

# EMI Test Report

Tested in accordance with  
Federal Communications Commission (FCC)  
Personal Communications Services  
CFR 47, Parts 2, 22, 24, 27  
&  
Industry Canada (IC), RSS-GEN, 132, 133 and 139



**A division of Research In Motion Limited**

**REPORT NO.:** RTS-6026-1302-12A\_Rev1

**PRODUCT MODEL NO.:** RFL111LW, RFP121LW  
**TYPE NAME:** BlackBerry® smartphone  
**FCC ID:** L6ARFL110LW, L6ARFP120LW  
**IC:** 2503A-RFL110LW, 2503A-RFP120LW  
**EMISSION DESIGNATOR (GSM):** 245KGXW  
**EMISSION DESIGNATOR (EDGE):** 246KG7W  
**EMISSION DESIGNATOR (WCDMA):** 4M16F9W  
**EMISSION DESIGNATOR (LTE QPSK):** See details in Appendix  
**EMISSION DESIGNATOR (LTE 16QAM):** See details in Appendix


**DATE:** April 05, 2013

This report supersedes the report RTS-6026-1302-12A dated March 08, 2013.

RTS is accredited  
according to  
EN ISO/IEC 17025 by:



592

	EMI Test Report for the BlackBerry® smartphone Model RFL111LW, RFP121LW	
<b>Test Report No.:</b> RTS-6026-1302-12A_Rev1	<b>Dates of Test:</b> Nov. 22, 2012 to Mar. 04, 2013, and April 05, 2013	<b>FCC ID:</b> L6ARFL110LW, L6ARFP120LW <b>IC:</b> 2503A-RFL110LW, 2503A-RFP120LW

## **Report Revision History**

### **Rev1:**

1. Added Emission Designator Table for LTE Band 2 in Appendix 3A.
2. Added Emission Designator Table for LTE Band 5 in Appendix 4A.
3. Added Emission Designator Table for LTE Band 4 in Appendix 5A.
4. Added Emission Designator Table for LTE Band 17 in Appendix 6A.

## **Statement of Performance:**

The BlackBerry® smartphone, model RFL111LW, part number CER-53012-001 Rev3-906-03 and accessories when configured and operated per RIM's operation instructions, and performs within the requirements of the test standards.

The BlackBerry® smartphone, model RFP121LW, part number CER-54352-001 Rev2-906-00 and accessories when configured and operated per RIM's operation instructions, and performs within the requirements of the test standards.

## **Declaration:**

We hereby certify that:

The test data reported herein is an accurate record of the performance of the sample(s) tested.

The test results are valid for the tested unit (s) only.

The test equipment used was suitable for the tests performed and within manufacturer's published specifications and operating parameters.

The test methods were consistent with the methods described in the relevant standards.

Documented by:


Reviewed by:

\_\_\_\_\_  
Heng Lin  
Regulatory Compliance Specialist

\_\_\_\_\_  
Forhad Hasnat  
Regulatory Compliance Specialist


Reviewed and Approved by:

\_\_\_\_\_  
Masud S. Attayi, P.Eng.  
Manager, Regulatory Compliance

	EMI Test Report for the BlackBerry® smartphone Model RFL111LW, RFP121LW	
<b>Test Report No.:</b> RTS-6026-1302-12A_Rev1	<b>Dates of Test:</b> Nov. 22, 2012 to Mar. 04, 2013, and April 05, 2013	<b>FCC ID:</b> L6ARFL110LW, L6ARFP120LW <b>IC:</b> 2503A-RFL110LW, 2503A-RFP120LW

## Table of Contents

A.	SCOPE .....	4
B.	ASSOCIATED DOCUMENTS .....	4
C.	PRODUCT IDENTIFICATION .....	4
D.	SUPPORT EQUIPMENT USED FOR THE TESTING OF THE EUT .....	6
E.	TEST RESULTS CHART .....	7
F.	SUMMARY OF RESULTS.....	10
G.	COMPLIANCE TEST EQUIPMENT USED .....	24
H.	TEST SOFTWARE USED .....	25
	APPENDIX 1A – GSM CONDUCTED RF EMISSIONS TEST DATA/PLOTS .....	26
	APPENDIX 1B – GSM FREQUENCY STABILITY TEST DATA .....	43
	APPENDIX 1C – GSM RADIATED EMISSIONS TEST DATA .....	55
	APPENDIX 2A– WCDMA BAND 2/4/5 CONDUCTED RF EMISSIONS TEST DATA/PLOTS .....	68
	APPENDIX 2B – WCDMA BAND 2/4/5 FREQUENCY STABILITY TEST DATA .....	97
	APPENDIX 2C – WCDMA BAND 2/4/5 RADIATED EMISSIONS TEST DATA.....	113
	APPENDIX 3A– LTE BAND 2 CONDUCTED RF EMISSIONS TEST DATA/PLOTS.....	129
	APPENDIX 3B – LTE BAND 2 FREQUENCY STABILITY TEST DATA.....	158
	APPENDIX 3C – LTE BAND 2 RADIATED EMISSIONS TEST DATA .....	170
	APPENDIX 4A– LTE BAND 5 CONDUCTED RF EMISSIONS TEST DATA/PLOTS.....	175
	APPENDIX 4B – LTE BAND 5 FREQUENCY STABILITY TEST DATA.....	193
	APPENDIX 4C – LTE BAND 5 RADIATED EMISSIONS TEST DATA .....	201
	APPENDIX 5A– LTE BAND 4 CONDUCTED RF EMISSIONS TEST DATA/PLOTS.....	206
	APPENDIX 5B – LTE BAND 4 FREQUENCY STABILITY TEST DATA.....	225
	APPENDIX 5C – LTE BAND 4 RADIATED EMISSIONS TEST DATA .....	233
	APPENDIX 6A– LTE BAND 17 CONDUCTED RF EMISSIONS TEST DATA/PLOTS.....	238
	APPENDIX 6B – LTE BAND 17 FREQUENCY STABILITY TEST DATA.....	253
	APPENDIX 6C – LTE BAND 17 RADIATED EMISSIONS TEST DATA .....	261

	EMI Test Report for the BlackBerry® smartphone Model RFL111LW, RFP121LW	
<b>Test Report No.:</b> RTS-6026-1302-12A_Rev1	<b>Dates of Test:</b> Nov. 22, 2012 to Mar. 04, 2013, and April 05, 2013	<b>FCC ID:</b> L6ARFL110LW, L6ARFP120LW <b>IC:</b> 2503A-RFL110LW, 2503A-RFP120LW

## A. Scope

This report details the results of compliance tests which were performed in accordance to the requirements of:

- FCC CFR 47 Part 2, Subpart J, Equipment Authorization Procedures, Oct, 2012.
- FCC CFR 47 Part 22, Subpart H, Cellular Radiotelephone Services, Oct., 2012.
- FCC CFR 47 Part 24 Subpart E, Broadband PCS, Oct., 2012.
- FCC CFR 47 Part 27, Subpart C, Technical Standards, Oct, 2012.
- Industry Canada, RSS-132 Issue 3, January 2013, Cellular Telephone Systems Operating in the Bands 824-849 MHz and 869-894 MHz.
- Industry Canada, RSS-133 Issue 6, January 2013, 2 GHz Personal Communications Services.
- Industry Canada, RSS-GEN Issue 3, December 2010, General Requirements and Information for the Certification of Radio communication Equipment.
- Industry Canada, RSS-139 Issue 2, February 2009, Advanced Wireless Services Equipment Operating in the Bands 1710-1755 MHz and 2110-2155 MHz.

## B. Associated Documents

1. RFL111LW\_HW\_Declaration\_CER-53012-001\_Rev3-906-03
2. RFP121LW\_HW\_Declaration\_CER-54352-001-Rev2-906-02
3. MultiSourceDeclaration\_RFL111LW\_RFP121LW\_b3123
4. MultiSourceDeclaration\_RFL111LW\_RFP121LW\_b3901
5. MultiSourceDeclaration\_RFL111LW\_RFP121LW\_b4318
6. BlackBerry\_System\_Similarity\_Declaration\_N-series\_Rev1.4

## C. Product Identification


Manufactured by Research In Motion Limited whose headquarters is located at:  
 295 Phillip Street  
 Waterloo, Ontario  
 Canada, N2L 3W8  
 Phone: 519 888 7465  
 Fax: 519 888 6906

The equipment under test (EUT) was tested at the following locations:

RIM Testing Services EMI test facilities

305 Phillip Street Waterloo, Ontario Canada, N2L 3W8 Phone: 519 888 7465 Fax: 519 888 6906	440 Phillip Street Waterloo, Ontario, Canada , N2L 5R9 Phone: 519 888 7465 Fax: 519 888 6906
--	--

The testing was performed from Nov. 22, 2012 to Mar. 04, 2013, and April 05, 2013.

	EMI Test Report for the BlackBerry® smartphone Model RFL111LW, RFP121LW	
<b>Test Report No.:</b> RTS-6026-1302-12A_Rev1	<b>Dates of Test:</b> Nov. 22, 2012 to Mar. 04, 2013, and April 05, 2013	<b>FCC ID:</b> L6ARFL110LW, L6ARFP120LW <b>IC:</b> 2503A-RFL110LW, 2503A-RFP120LW


### BlackBerry® smartphone Samples Tested

Sample	Model	CER NUMBER	PIN	Software Information
1A	RFL111LW	CER-53012-001 Rev2-905-01	25CF0ADB	OS: 127.0.1.2982
1B	RFL111LW	CER-53012-001 Rev2-905-01	25CF0ADB	OS: 127.0.1.3123
2	RFL111LW	CER-53012-001 Rev3-906-03	2668C70C	OS: 127.0.1.3123
3	RFL111LW	CER-53012-001 Rev2-905-01	25CF0AE3	OS: 127.0.1.3123
4	RFL111LW	CER-53012-001 Rev2-905-01	25CF0AC4	OS: 127.0.1.1323
5	RFL111LW	CER-53012-001 Rev2-905-01	25CF0AE1	OS: 127.0.1.1323
6	RFL111LW	CER-53012-001 Rev3-906-03	2668C731	OS: 127.0.1.3901
7	RFL111LW	CER-53012-001 Rev3-906-03	2668C71B	OS: 127.0.1.3901
8	RFP121LW	CER-54352-001 Rev2-906-01	26703202	OS: 127.0.1.3901
9	RFP121LW	CER-54352-001 Rev2-906-02	267031FC	OS: 127.0.1.4318
10	RFP121LW	CER-54352-001 Rev2-906-00	267031FD	OS: 127.0.1.3901
11	RFP121LW	CER-54352-001 Rev2-906-00	26703201	OS: 127.0.1.3901

RF Conducted Emissions testing was performed on samples 1A, 1B, 2, 3, 8, and 9.  
RF Radiated Emissions testing was performed on samples 4, 5, 6 and 7.

Only the characteristics that may have been affected by the changes from RFL111LW Rev2-905-01 to RFL111LW Rev3-906-03 were re-tested.  
For more details, refer to RFL111LW\_HW\_Declaration\_CER-53012-001\_Rev3-906-03.

Only the characteristics that may have been affected by the changes from RFL111LW to RFP121LW were re-tested.  
For more information, see BlackBerry\_System\_Similarity\_Declaration\_N-series\_Rev1.4.

	EMI Test Report for the BlackBerry® smartphone Model RFL111LW, RFP121LW	
<b>Test Report No.:</b> RTS-6026-1302-12A_Rev1	<b>Dates of Test:</b> Nov. 22, 2012 to Mar. 04, 2013, and April 05, 2013	<b>FCC ID:</b> L6ARFL110LW, L6ARFP120LW <b>IC:</b> 2503A-RFL110LW, 2503A-RFP120LW

Only the characteristics that may have been affected by the changes from RFP121LW Rev2-906-00 to RFP121LW Rev2-906-02 were re-tested.  
For more details, refer to RFP121LW\_HW\_Declaration\_CER-54352-001-Rev2-906-02.


To view the differences between OS: 127.0.1.2982 and OS: 127.0.1.4318 see documents:  
MultiSourceDeclaration\_RFL111LW\_b3123,  
MultiSourceDeclaration\_RFL111LW\_b3901  
MultiSourceDeclaration\_RFL111LW\_b4318

### BlackBerry® smartphone Accessories Tested

- 1) Bat. NS1, part number BAT-49702-002
- 2) Bat. NS1, part number BAT-52961-001

#### **D. Support Equipment Used for the Testing of the EUT**

No support equipment required; for list of equipment refer to section G, Compliance Test Equipment Used.

		EMI Test Report for the BlackBerry® smartphone Model RFL111LW, RFP121LW	
<b>Test Report No.:</b> RTS-6026-1302-12A_Rev1		<b>Dates of Test:</b> Nov. 22, 2012 to Mar. 04, 2013, and April 05, 2013	<b>FCC ID:</b> L6ARFL110LW, L6ARFP120LW <b>IC:</b> 2503A-RFL110LW, 2503A-RFP120LW

## E. Test Results Chart

SPECIFICATION		TEST TYPE	RESULT	TEST DATA APPENDIX
FCC CFR 47	IC			
Part 2.1051 Part 22.917 Part 24.238	RSS-GEN, 4.9 RSS-132, 5.5 RSS-133, 6.5	GSM850 / PCS1900 Conducted Spurious Emissions	Pass	1A
Part 2.1049 Part 22.917 Part 24.238	RSS-GEN, 4.6	GSM 850 / PCS1900 Occupied Bandwidth and Channel Mask	Pass	1A
Part 2.1055 Part 24.235	RSS-132, 5.3 RSS-133, 6.3	GSM 850 / PCS1900 Frequency Stability vs. Temperature and Voltage	Pass	1B
Part 22.913(a)(2) Part 24.232(c)	RSS-132, 5.4 RSS-133, 6.4	GSM850 ERP PCS1900 EIRP	Pass	1C
Part 2.1053 Part 22.917 Part 24.238	RSS-GEN, 4.9 RSS-132, 4.5 RSS-133, 6.5	GSM850 / PCS1900 Radiated Spurious/Harmonic Emissions	Pass	1C
Part 2.1051 Part 22.917 Part 24.238 Part 27.53(h)	RSS-GEN, 4.9 RSS-132, 5.5 RSS-133, 6.5 RSS-139, 6.5	WCDMA Band 2/5/4 Conducted Spurious Emissions	Pass	2A
Part 2.1049 Part 22.917 Part 24.238 Part 27.53(h)(1)	RSS-GEN, 4.6	WCDMA Band 2/5/4 Occupied Bandwidth and Channel Mask	Pass	2A
Part 24.232 (d) Part 27.50 (d)(5)	RSS-133, 6.4 RSS-139, 6.4	WCDMA Band 2/4 Peak to Average Ratio measurements	Pass	2A
Part 2.1055(a)(d) Part 24.235 Part 27.54	RSS-132, 5.3 RSS-133, 6.3 RSS-139, 6.3	WCDMA Band 2/5/4 Frequency Stability vs. Temperature and Voltage	Pass	2B
Part 22.913(a)(2) Part 24.232(c) Part 27.50(d)(4)	RSS-132, 5.4 RSS-133, 6.4 RSS-139, 6.4	WCDMA Band 5 ERP WCDMA Band 2/4 EIRP	Pass	2C
Part 2.1053 Part 22.917 Part 24.238 Part 27.53(h)	RSS-GEN, 4.9 RSS-132, 5.5 RSS-133, 6.5 RSS-139, 6.5	WCDMA Band 2/5 Radiated Spurious/Harmonic Emissions	Pass	2C

<b>Test Report No.:</b> RTS-6026-1302-12A_Rev1	<b>Dates of Test:</b> Nov. 22, 2012 to Mar. 04, 2013, and April 05, 2013	<b>FCC ID:</b> L6ARFL110LW, L6ARFP120LW <b>IC:</b> 2503A-RFL110LW, 2503A-RFP120LW
---	--	--

Part 2.1051 Part 24.238(a) Part 24.50 (d)	RSS-133, 6.5	LTE Band 2 Conducted Spurious Emissions	Pass	3A
Part 2.1049 Part 24.238	RSS-GEN, 4.6	LTE Band 2 Occupied Bandwidth and Channel Mask	Pass	3A
Part 24.232 (d)	RSS-133, 6.4	LTE Band 2 Peak to Average Ratio measurements	Pass	3A
Part 2.1055(a)(d) Part 24.235	RSS-133, 6.3	LTE Band 2 Frequency Stability vs. Temperature and Voltage	Pass	3B
Part 24.232(b)(c)	RSS-133, 6.4	LTE Band 2 EIRP	Pass	3C
Part 24.238	RSS-133, 6.5	LTE Band 2 Radiated Spurious/Harmonic Emissions	Pass	3C
Part 2.1051 Part 22.917	RSS-132, 5.5	LTE Band 5 Conducted Spurious Emissions	Pass	4A
Part 2.1049 Part 22.917	RSS-GEN, 4.6	LTE Band 5 Occupied Bandwidth and Channel Mask	Pass	4A
Part 2.1055(a)(d)	RSS-132, 5.3	LTE Band 5 Frequency Stability vs. Temperature and Voltage	Pass	4B
Part 22.913(a)(2)	RSS-132, 5.4	LTE Band 5 ERP	Pass	4C
Part 22.917	RSS-132, 5.5	LTE Band 5 Radiated Spurious/Harmonic Emissions	Pass	4C
Part 2.1051 Part 27.53(h)	RSS-139, 6.5	LTE Band 4 Conducted Spurious Emissions	Pass	5A
Part 2.1049 Part 27.53(h)(1)	RSS-GEN, 4.6	LTE Band 4 Occupied Bandwidth and Channel Mask	Pass	5A
Part 27.50 (d)(5)	RSS-139, 6.4	LTE Band 4 Peak to Average Ratio measurements	Pass	5A
Part 2.1055 Part 27.54	RSS-139, 6.3	LTE Band 4 Frequency Stability vs. Temperature and Voltage	Pass	5B
Part 2.1053 Part 27.50(d)(4)	RSS-139, 6.4	LTE Band 4 EIRP	Pass	5C
Part 2.1053 Part 27.53(h)	RSS-139, 6.5	LTE Band 4 Radiated Spurious/Harmonic Emissions	Pass	5C
Part 2.1051 Part 27.53(g)	-	LTE Band 17 Conducted Spurious Emissions	Pass	6A






EMI Test Report for the BlackBerry® smartphone Model RFL111LW, RFP121LW

**Test Report No.:**  
RTS-6026-1302-12A\_Rev1

**Dates of Test:**  
Nov. 22, 2012 to Mar. 04, 2013,  
and April 05, 2013

**FCC ID:** L6ARFL110LW, L6ARFP120LW  
**IC:** 2503A-RFL110LW, 2503A-RFP120LW

Part 2.1049 Part 27.53(g)	-	LTE Band 17 Occupied Bandwidth and Channel Mask	Pass	6A
Part 27.50 (d)(5)	-	LTE Band 17 Peak to Average Ratio measurements	Pass	6A
Part 2.1055 Part 27.54	-	LTE Band 17 Frequency Stability vs. Temperature and Voltage	Pass	6B
Part 2.1053 Part 27.50(c)(9)	-	LTE Band 17 ERP	Pass	6C
Part 2.1053 Part 27.53(g)	-	LTE Band 17 Radiated Spurious/Harmonic Emissions	Pass	6C

	EMI Test Report for the BlackBerry® smartphone Model RFL111LW, RFP121LW	
<b>Test Report No.:</b> RTS-6026-1302-12A_Rev1	<b>Dates of Test:</b> Nov. 22, 2012 to Mar. 04, 2013, and April 05, 2013	<b>FCC ID:</b> L6ARFL110LW, L6ARFP120LW <b>IC:</b> 2503A-RFL110LW, 2503A-RFP120LW

## F. Summary of Results

### 1) Conducted Emission Measurements

The following test configuration were performed on product model RFL111LW and RFP121LW.

- The EUT met the requirements of the Tx Conducted Spurious Emissions in the GSM850 as per 47 CFR 2.1051, CFR 22.917, CFR 22.901(d), RSS-132, 5.5 and RSS-GEN, 4.9. The EUT was measured on the low, middle and high channels. The frequency range investigated was from 30 MHz to 10 GHz. See APPENDIX 1A for test data.


The EUT met the requirements of the Tx Conducted Spurious Emissions in the PCS1900 as per 47 CFR 2.1051, CFR 24.238(a), RSS-133, 6.5. and RSS-GEN, 4.9 The EUT was measured on the low, middle and high channels. The frequency range investigated was from 30 MHz to 20 GHz. See APPENDIX 1A for test data

- The EUT met the requirements of the Occupied Bandwidth and channel mask in the GSM850 as per 47 CFR 2.202, CFR 22.917 and RSS-GEN, 4.6. The EUT was measured in GSM and EDGE mode on the low, middle and high channels. The worst case occupied bandwidth was 244.6 kHz on the low and mid channels in CALL mode, and 246.0 kHz on high channels in EDGE mode. See APPENDIX 1A for test data.

The EUT met the requirements of the Occupied Bandwidth and channel mask in the PCS1900 as per 47 CFR 2.202, CFR 24.238 and RSS-GEN, 4.6. The EUT was measured in GSM and EDGE mode on the low, middle and high channels. The worst case occupied bandwidth was 244.6 kHz on all channels in CALL mode, and 244.6 kHz on the mid channel in EDGE mode. See APPENDIX 1A for test data.

- The EUT met the requirements of the Frequency Stability in the GSM850 as per 47 CFR 2.1055 and RSS-132, 5.3. The EUT was measured in GSM850 mode on the low, middle and high channels. See APPENDIX 1B for test data.

The EUT met the requirements of the Frequency Stability in the PCS1900 as per 47 CFR 2.1055, CFR 24.235 and RSS-133, 6.3. The EUT was measured in PCS1900 mode on the low, middle and high channels. See APPENDIX1B for test data.

	EMI Test Report for the BlackBerry® smartphone Model RFL111LW, RFP121LW	
<b>Test Report No.:</b> RTS-6026-1302-12A_Rev1	<b>Dates of Test:</b> Nov. 22, 2012 to Mar. 04, 2013, and April 05, 2013	<b>FCC ID:</b> L6ARFL110LW, L6ARFP120LW <b>IC:</b> 2503A-RFL110LW, 2503A-RFP120LW

- The EUT met the requirements of the Tx Conducted Spurious Emissions in the WCDMA Band 5 as per 47 CFR 2.1051, CFR 22.917, CFR 22.901(d), RSS-132, 5.5 and RSS-GEN, 4.9. The EUT was measured on the low, middle and high channels. The frequency range investigated was from 30 MHz to 10 GHz. See APPENDIX 2A for test data.

The EUT met the requirements of the Tx Conducted Spurious Emissions in the WCDMA Band 2 as per 47 CFR 2.1051, CFR 24.238(a), RSS-133, 6.5 and RSS-GEN, 4.9. The EUT was measured on the low, middle and high channels. The frequency range investigated was from 30 MHz to 20 GHz. See APPENDIX 2A for test data


The EUT met the requirements of the Tx Conducted Spurious Emissions in the WCDMA Band 4 as per 47 CFR 2.1051, CFR 27.53 and RSS-139, 6.5. The EUT was measured on the low, middle and high channels. The frequency range investigated was from 30 MHz to 20 GHz. See APPENDIX 2A for test data

- The EUT met the requirements of the Occupied Bandwidth and channel mask in the WCDMA Band 5 as per 47 CFR 2.202, CFR 22.917 and RSS-GEN, 4.6. The EUT was measured in Voice and HSUPA mode on the low, middle and high channels. The worst case occupied bandwidth was 4.161 MHz on the high channel in Voice mode, and 4.153 MHz on the low channel in HSUPA mode. See APPENDIX 2A for test data.

The EUT met the requirements of the Occupied Bandwidth and channel mask in the WCDMA Band 2 as per 47 CFR 2.202, CFR 24.238 and RSS-GEN, 4.6. The EUT was measured in Voice and HSUPA mode on the low, middle and high channels. The worst case occupied bandwidth was 4.161 MHz on the mid channel in Voice mode, and 4.161 MHz on the low and mid channels in HSUPA mode. See APPENDIX 2A for test data.

The EUT met the requirements of the Occupied Bandwidth and channel mask in the WCDMA Band 4 as per 47 CFR 2.1049, CFR 27.53 and RSS-GEN, 4.6. The EUT was measured in Voice and HSUPA mode on the low, middle and high channels. The worst case occupied bandwidth was 4.161 MHz on the low and mid channels in Voice mode, and 4.161 MHz on the low channel in HSUPA mode. See APPENDIX 2A for test data.

- The EUT met the requirements of the Tx Peak to Average Ratio in the WCDMA Band 2 as per 47 CFR 24.232 (5)(d) and RSS-133, 6.4. The EUT was measured on the low, middle and high channels. The worst case Peak to Average Ratio was 9.02 dB on mid channel. See APPENDIX 2A for test data

	EMI Test Report for the BlackBerry® smartphone Model RFL111LW, RFP121LW	
<b>Test Report No.:</b> RTS-6026-1302-12A_Rev1	<b>Dates of Test:</b> Nov. 22, 2012 to Mar. 04, 2013, and April 05, 2013	<b>FCC ID:</b> L6ARFL110LW, L6ARFP120LW <b>IC:</b> 2503A-RFL110LW, 2503A-RFP120LW

The EUT met the requirements of the Tx Peak to Average Ratio in the WCDMA Band 4 as per 47 CFR 27.50 (5)(d) and RSS-139, 6.4. The EUT was measured on the low, middle and high channels. The worst case Peak to Average Ratio was 9.94 dB on middle channel.

See APPENDIX 2A for test data

- The EUT met the requirements of the Frequency Stability in the WCDMA Band 5 as per 47 CFR 2.1055 and RSS-132, 5.3. The EUT was measured in WCDMA Band 5 mode on the low, middle and high channels.

See APPENDIX 2B for test data.

The EUT met the requirements of the Frequency Stability in the WCDMA Band 2 as per 47 CFR 2.1055, CFR 24.235 and RSS-133, 6.3. The EUT was measured in WCDMA Band 2 mode on the low, middle and high channels.

See APPENDIX 2B for test data.

The EUT met the requirements of the Frequency Stability in the WCDMA Band 4 as per 47 CFR 2.1055, CFR 27.54 and RSS-139, 6.3. The EUT was measured in WCDMA Band 4 mode on the low, middle and high channels.


See APPENDIX 2B for test data.

- The EUT met the requirements of the Tx Conducted Spurious Emissions in the LTE Band 2 as per 47 CFR 2.1051, CFR 24.238(a) and RSS-133, 6.5. The EUT was measured on the low, middle and high channels in 1.4MHz, 3MHz, 5MHz, 10MHz, 15MHz and 20MHz bandwidths for LTE Band 2 with QPSK and 16-QAM modulations. Different resource block allocations were investigated, a minimum one resource block case was also tested. The frequency range investigated was from 30 MHz to 20 GHz.


See Appendix 3A for test data

- The EUT met the requirements of the Occupied Bandwidth and channel mask in the LTE Band 2 as per 47 CFR 2.202, CFR 24.238 and RSS-GEN, 4.6. The EUT was measured on the low, middle and high channels. For product RFL111LW, the worst case occupied bandwidth was 17.86 MHz on the low and middle channel in 20MHz BW, 100 resource blocks in QPSK modulation and 17.85 MHz on the low channel in 20MHz BW, 100 resource blocks in 16QAM modulation. For product RFP121LW, the worst case occupied bandwidth was 17.89 MHz on the low and high channels in 20MHz BW, 100 resource blocks in QPSK modulation and 17.89 MHz on the mid channel in 20MHz BW, 100 resource blocks in 16QAM modulation.

See Appendix 3A for test data

	EMI Test Report for the BlackBerry® smartphone Model RFL111LW, RFP121LW	
<b>Test Report No.:</b> RTS-6026-1302-12A_Rev1	<b>Dates of Test:</b> Nov. 22, 2012 to Mar. 04, 2013, and April 05, 2013	<b>FCC ID:</b> L6ARFL110LW, L6ARFP120LW <b>IC:</b> 2503A-RFL110LW, 2503A-RFP120LW

- The EUT met the requirements of the Tx Peak to Average Ratio in the LTE Band 2 as per 47 CFR 24.232 (5)(d). The EUT was measured on the low, middle and high channels in 1.4MHz, 3MHz, 5MHz, 10MHz, 15MHz and 20MHz bandwidths for LTE Band 2 with QPSK and 16-QAM modulations. Different resource block allocations were also investigated, a minimum one resource block case was also tested. For product RFL111LW, the worst case Peak to Average Ratio was 9.02 dB on mid channel in 20MHz bandwidth with 100 resource blocks. For product RFP121LW, the worst case Peak to Average Ratio was 9.61 dB on mid channel in 20 MHz bandwidth with 100 resource blocks.  
See APPENDIX 3A for test data
- The EUT met the requirements of the Frequency Stability in the LTE Band 2 as per 47 CFR 2.1055, CFR 24.235 and RSS-133, 6.3. The EUT was measured in LTE Band 2 mode on the low, middle and high channels in 20MHz BW with 100 resource blocks and QPSK modulation.  
See APPENDIX 3B for test data.
- The EUT met the requirements of the Tx Conducted Spurious Emissions in the LTE Band 5 as per 47 CFR 2.1051, CFR 22.917, CFR 22.901(d), RSS-132, 5.5 and RSS-GEN, 4.9. The EUT was measured on the low, middle and high channels in 1.4MHz, 3MHz, 5MHz and 10MHz as per scalable bandwidths for LTE Band 5 with QPSK and 16-QAM modulations. Different resource block allocations were investigated, a minimum one resource block case was also tested. The frequency range investigated was from 30 MHz to 10 GHz.  
See APPENDIX 4A for test data.
- The EUT met the requirements of the Occupied Bandwidth and channel mask in the LTE Band 5 as per 47 CFR 2.202, CFR 22.917 and RSS-GEN, 4.6. The EUT was measured on the low, middle and high channels in 1.4MHz, 3MHz, 5MHz and 10MHz bandwidths for LTE Band 5 with QPSK and 16-QAM modulations. Different resource block allocations were investigated, a minimum one resource block case was also tested. The worst case occupied bandwidth was 8.944 MHz on the mid channel in 10MHz BW, 50 resource blocks and QPSK modulation.  
See APPENDIX 4A for test data.
- The EUT met the requirements of the Frequency Stability in the LTE Band 5 as per 47 CFR 2.1055, CFR 22.917 and RSS-132, 5.3. The EUT was measured on the low, middle and high channels in 1.4MHz, 3MHz, 5MHz and 10MHz as per scalable bandwidths for LTE Band 5 with QPSK and 16-QAM modulations. Different resource block allocations were investigated, a minimum one resource block case was also tested.  
See APPENDIX 4B for test data.

	EMI Test Report for the BlackBerry® smartphone Model RFL111LW, RFP121LW	
<b>Test Report No.:</b> RTS-6026-1302-12A_Rev1	<b>Dates of Test:</b> Nov. 22, 2012 to Mar. 04, 2013, and April 05, 2013	<b>FCC ID:</b> L6ARFL110LW, L6ARFP120LW <b>IC:</b> 2503A-RFL110LW, 2503A-RFP120LW

- The EUT met the requirements of the Tx Conducted Spurious Emissions in the LTE Band 4 as per 47 CFR 2.1051, CFR 27.53 and RSS-139, 6.5. The EUT was measured on the low, middle and high channels in 1.4MHz, 3MHz, 5MHz, 10MHz, 15MHz and 20MHz bandwidths for LTE Band 4 with QPSK and 16-QAM modulations. Different resource block allocations were investigated, a minimum one resource block case was also tested. The frequency range investigated was from 30 MHz to 20 GHz.

See Appendix 5A for test data

- The EUT met the requirements of the Occupied Bandwidth and channel mask in the LTE Band 4 as per 47 CFR 2.1049, CFR 27.53 and RSS-GEN, 4.6. The EUT was measured on the low, middle and high channels. The worst case occupied bandwidth was 17.86 MHz on the low channel in 20MHz BW, 100 resource blocks and QPSK modulation.

See Appendix 5A for test data

- The EUT met the requirements of the Tx Peak to Average Ratio in the LTE Band 4 as per 47 CFR 27.50 (5)(d) and RSS-139, 6.4. The EUT was measured on the low, middle and high channels in 1.4MHz, 3MHz, 5MHz, 10MHz, 15MHz and 20MHz bandwidths for LTE Band 4 with QPSK and 16-QAM modulations. Different resource block allocations were also investigated, a minimum one resource block case was also tested. The worst case Peak to Average Ratio was 9.03 dB on middle channel in 20MHz bandwidth with 100 resource blocks.

See APPENDIX 5A for test data

- The EUT met the requirements of the Frequency Stability in the LTE Band 4 as per 47 CFR 2.1055, CFR 27.54 and RSS-139, 6.3. The EUT was measured in LTE Band 4 mode on the low, middle and high channels in 20MHz BW with 100 resource blocks and QPSK modulation.


See APPENDIX 5B for test data.

- The EUT met the requirements of the Tx Conducted Spurious Emissions in the LTE Band 17 as per 47 CFR 2.1051, CFR 27.53. The EUT was measured on the low, middle and high channels in 5MHz and 10MHz, bandwidths for LTE Band 17 with QPSK and 16-QAM modulations. Different resource block allocations were investigated, a minimum one resource block case was also tested. The frequency range investigated was from 30 MHz to 20 GHz.

See Appendix 6A for test data

- The EUT met the requirements of the Occupied Bandwidth and channel mask in the LTE Band 17 as per 47 CFR 2.1049, CFR 27.53. The EUT was measured on the low, middle and high channels. The worst case occupied bandwidth was 8.944 MHz on the low channel in 10MHz BW, 50 resource blocks and QPSK modulation.

See Appendix 6A for test data


	EMI Test Report for the BlackBerry® smartphone Model RFL111LW, RFP121LW	
<b>Test Report No.:</b> RTS-6026-1302-12A_Rev1	<b>Dates of Test:</b> Nov. 22, 2012 to Mar. 04, 2013, and April 05, 2013	<b>FCC ID:</b> L6ARFL110LW, L6ARFP120LW <b>IC:</b> 2503A-RFL110LW, 2503A-RFP120LW

- The EUT met the requirements of the Tx Peak to Average Ratio in the LTE Band 17 as per 47 CFR 27.50 (5)(d). The EUT was measured on the low, middle and high channels in 5MHz and 10MHz bandwidths for LTE Band 17 with QPSK and 16-QAM modulations. Different resource block allocations were also investigated, a minimum one resource block case was also tested. The worst case Peak to Average Ratio was 9.94 dB on middle channel in 20MHz bandwidth with 100 resource blocks.

See APPENDIX 6A for test data

- The EUT met the requirements of the Frequency Stability in the LTE Band 17 as per 47 CFR 2.1055, CFR 27.54. The EUT was measured in LTE Band 17 mode on the low, middle and high channels in 20MHz BW with 100 resource blocks and QPSK modulation.

See APPENDIX 6B for test data.

	EMI Test Report for the BlackBerry® smartphone Model RFL111LW, RFP121LW	
<b>Test Report No.:</b> RTS-6026-1302-12A_Rev1	<b>Dates of Test:</b> Nov. 22, 2012 to Mar. 04, 2013, and April 05, 2013	<b>FCC ID:</b> L6ARFL110LW, L6ARFP120LW <b>IC:</b> 2503A-RFL110LW, 2503A-RFP120LW

## 2) Radiated Emission Measurements

The radiated spurious emissions/harmonics and ERP/EIRP were measured for GSM 850 and PCS 1900. The results are within the limits. The EUT was placed on a nonconductive styrofoam table, 80 cm high that was positioned on a remotely controlled turntable. The test distance used between the EUT and the receiving antenna was three meters. Then the emissions were maximized by elevating the antenna in the range of 1 to 4 meters. The turntable was rotated to determine the azimuth of the peak emissions. Both the horizontal and vertical polarizations of the emissions were measured. The maximum emissions level was recorded. The EUT was then substituted with an antenna placed in the same location as the BlackBerry® smartphone. A Dipole antenna was used for the ERP measurements and a Horn antenna was used for EIRP measurements. The substitution antenna was connected into a signal generator that was set to the test frequency.

The emissions were maximized by elevating the antenna in the range of 1 to 4 meters. The signal generator output was then adjusted to match the EUT output reading. The signal generator output was recorded. Both the horizontal and vertical polarizations of the emissions were measured.


The following measurements were done in a semi-anechoic chamber (SAC) below 1 GHz and a Semi-anechoic Chamber ((SAC) with floor absorber) above 1 GHz. The SAC's FCC registration number is **778487** and the Industry Canada (IC) file number is **2503B-1**. The SAC with floor absorber's FCC registration number is **959115** and the IC file number is **2503C-1**. The EUT was measured on the low, middle and high channels.

a) The radiated spurious emissions/harmonics and ERP/EIRP were measured for GSM 850 and PCS 1900. The results are within the limits.

The measurement result for product RFL111LW:

- The highest ERP in the 850 band Call mode measured was 32.30 dBm (1.70 W) at 836.60 MHz (channel 190)
- The highest ERP in the 850 band EDGE mode measured was 29.02 dBm (0.80 W) at 836.60 MHz (channel 190).
- The highest EIRP in the PCS band Call mode measured was 32.55 dBm (1.80 W) at 1909.80 MHz (channel 810).
- The highest EIRP in the PCS band EDGE mode measured was 31.88 dBm (1.54 W) at 1880.00 MHz (channel 661).



	EMI Test Report for the BlackBerry® smartphone Model RFL111LW, RFP121LW	
<b>Test Report No.:</b> RTS-6026-1302-12A_Rev1	<b>Dates of Test:</b> Nov. 22, 2012 to Mar. 04, 2013, and April 05, 2013	<b>FCC ID:</b> L6ARFL110LW, L6ARFP120LW <b>IC:</b> 2503A-RFL110LW, 2503A-RFP120LW

Measurement result for product RFP121LW:

- The highest ERP in the 850 band Call mode measured was 32.02 dBm (1.59 W) at 848.80 MHz (channel 251)
- The highest ERP in the 850 band EDGE mode measured was 28.02 dBm (0.63 W) at 848.80 MHz (channel 251).
- The highest EIRP in the PCS band Call mode measured was 32.49 dBm (1.77 W) at 1850.20 MHz (channel 512).
- The highest EIRP in the PCS band EDGE mode measured was 31.80 dBm (1.51 W) at 1880.00 MHz (channel 661).

The radiated spurious emission and carrier harmonics were measured up to the 10<sup>th</sup> harmonic for low, middle, and high channels in the GSM 850 and PCS 1900. Each band was measured in CALL and EDGE modes, with both the horizontal and vertical polarizations.

Measurement result for product RFL111LW:

- All margins in band GSM850 for harmonic emission were at least 25 dB below the limit for all test frequency.
- The worst margin was 12.8 dB below the limit at 5550.476MHz in EDGE mode in band PCS1900.

Measurement result for product RFP121LW:

- The worst margin was 21.7 dB below the limit at 2510.008 MHz in CALL mode in band GSM850.
- All margins in band PCS1900 for harmonic emission were at least 25 dB below the limit for all test frequency.


See Appendix 1D for test data.

- b) The radiated spurious emissions/harmonics and ERP/EIRP were measured for WCDMA Band 2/4/5. The results are within the limits.

Measurement result for product RFL111LW:

- The highest ERP in the WCDMA Band 5, Voice mode was 22.99 dBm (0.2 W) at 846.60 MHz (channel 4233).
- The highest ERP in the WCDMA Band 5, HSUPA mode was 21.73 dBm (0.15 W) at 846.60 MHz (channel 4233).
- The highest EIRP in the WCDMA Band 2, Voice mode measured was 23.77 dBm (0.24 W) at 1852.4 MHz (channel 9262).
- The highest EIRP in the WCDMA Band 2, HSUPA mode measured was 23.27 dBm (0.21 W) at 1852.4 MHz (channel 9262).

Measurement result for product RFP121LW:

	EMI Test Report for the BlackBerry® smartphone Model RFL111LW, RFP121LW	
<b>Test Report No.:</b> RTS-6026-1302-12A_Rev1	<b>Dates of Test:</b> Nov. 22, 2012 to Mar. 04, 2013, and April 05, 2013	<b>FCC ID:</b> L6ARFL110LW, L6ARFP120LW <b>IC:</b> 2503A-RFL110LW, 2503A-RFP120LW

- The highest ERP in the WCDMA Band 5, Voice mode was 23.70 dBm (0.23 W) at 846.60 MHz (channel 4233).
- The highest ERP in the WCDMA Band 5, HSUPA mode was 22.01 dBm (0.16 W) at 846.60 MHz (channel 4233).
- The highest EIRP in the WCDMA Band 2, Voice mode measured was 23.83 dBm (0.24 W) at 1852.4 MHz (channel 9262).
- The highest EIRP in the WCDMA Band 2, HSUPA mode measured was 23.61 dBm (0.23 W) at 1852.4 MHz (channel 9262).
- The highest EIRP in the WCDMA Band 4, Voice mode measured was 23.13 dBm (0.21 W) at 1712.40 MHz (channel 1312).
- The highest EIRP in the WCDMA Band 4, HSUPA mode measured was 22.48 dBm (0.18 W) at 1732.60 MHz (channel 1413).

The radiated carrier harmonics were measured up to the 10<sup>th</sup> harmonic for low, middle and high channels in the WCDMA Band 2/4/5. Each band was measured in Voice and HSUPA modes. Both the horizontal and vertical polarizations were measured.


Measurement result for product RFL111LW:

- All margins in the WCDMA Band 5 for harmonic emissions were at least 25 dB below the limit for all test frequencies.
- All margins in the WCDMA Band 2 for harmonic emissions were at least 25 dB below the limit for all test frequencies.

Measurement result for product RFP121LW:

- All margins in the WCDMA Band 5 for harmonic emissions were at least 25 dB below the limit for all test frequencies.
- All margins in the WCDMA Band 2 for harmonic emissions were at least 25 dB below the limit for all test frequencies.
- All margins in the WCDMA Band 4 for harmonic emissions were at least 25 dB below the limit for all test frequencies.

See Appendix 2D for test data.

	EMI Test Report for the BlackBerry® smartphone Model RFL111LW, RFP121LW	
<b>Test Report No.:</b> RTS-6026-1302-12A_Rev1	<b>Dates of Test:</b> Nov. 22, 2012 to Mar. 04, 2013, and April 05, 2013	<b>FCC ID:</b> L6ARFL110LW, L6ARFP120LW <b>IC:</b> 2503A-RFL110LW, 2503A-RFP120LW

- c) The radiated spurious emissions/harmonics and EIRP were measured for LTE Band 2.

The EUT was measured on the low, middle and high channels in 1.4MHz, 3MHz, 5MHz, 10MHz, 15MHz and 20MHz bandwidths for LTE Band 2 with QPSK and 16-QAM modulations. Different resource block allocations were investigated, a minimum one resource block case was also tested. Both the horizontal and vertical polarizations were measured.

Measurement result for product RFL111LW:

- The highest EIRP in the LTE Band 2 measured was 23.66 dBm (0.23 W) at 1899.90 MHz (channel 19099) in 20MHz BW, 1 resource block and QPSK modulation and
- The highest EIRP in the LTE Band 2 measured was 22.38 dBm (0.17 W) at 1899.90 MHz (channel 19099) in 20MHz BW, 1 resource block and 16-QAM modulation.

Measurement result for product RFP121LW:

- The highest EIRP in the LTE Band 2 measured was 25.32 dBm (0.34 W) at 1899.90 MHz (channel 19099) in 20MHz BW, 1 resource block and QPSK modulation
- The highest EIRP in the LTE Band 2 measured was 24.16 dBm (0.26 W) at 1899.90 MHz (channel 19099) in 20MHz BW, 1 resource block and 16-QAM modulation.

The radiated carrier harmonics were measured up to the 10<sup>th</sup> harmonic. The EUT was measured on the low, middle and high channels in 1.4MHz, 3MHz, 5MHz, 10MHz, 15MHz and 20MHz bandwidths for LTE Band 2 with QPSK modulations. Different resource block allocations were investigated, a minimum one resource block case was also tested. Both the horizontal and vertical polarizations were measured.


Measurement result for product RFL111LW:

- All margins in the LTE Band 2 for harmonic emissions were at least 25 dB below the limit for all test frequencies.

Measurement result for product RFP121LW:

- All margins in the LTE Band 2 for harmonic emissions were at least 25 dB below the limit for all test frequencies.

See Appendix 3D for test data.

	EMI Test Report for the BlackBerry® smartphone Model RFL111LW, RFP121LW	
<b>Test Report No.:</b> RTS-6026-1302-12A_Rev1	<b>Dates of Test:</b> Nov. 22, 2012 to Mar. 04, 2013, and April 05, 2013	<b>FCC ID:</b> L6ARFL110LW, L6ARFP120LW <b>IC:</b> 2503A-RFL110LW, 2503A-RFP120LW

- d) The radiated spurious emissions/harmonics and ERP were measured for LTE Band 5.

The EUT was measured on the low, middle and high channels in 1.4MHz, 3MHz, 5MHz and 10MHz bandwidths for LTE Band 5 with QPSK and 16-QAM modulations. Different resource block allocations were investigated, a minimum one resource block case was also tested. Both the horizontal and vertical polarizations were measured.

Measurement result for product RFL111LW:

- The highest EIRP in the LTE Band 5 measured was 23.28 dBm (0.21 W) at 834.00 MHz (channel 20500) in 10MHz BW, 1 resource block and QPSK modulation.
- The highest EIRP in the LTE Band 5 measured was 21.47 dBm (0.14 W) at 836.50 MHz (channel 20525) in 10MHz BW, 1 resource block and 16-QAM modulation.

Measurement result for product RFP121LW:

- The highest EIRP in the LTE Band 5 measured was 24.25 dBm (0.27 W) at 834.00 MHz (channel 20500) in 10MHz BW, 1 resource block and QPSK modulation.
- The highest EIRP in the LTE Band 5 measured was 23.37 dBm (0.22 W) at 838.90 MHz (channel 20549) in 10MHz BW, 1 resource block and 16-QAM modulation.

The radiated carrier harmonics were measured up to the 10<sup>th</sup> harmonic. The EUT was measured on the low, middle and high channels in 1.4MHz, 3MHz, 5MHz and 10MHz bandwidths for LTE Band 5 with QPSK modulations. Different resource block allocations were investigated, a minimum one resource block case was also tested. Both the horizontal and vertical polarizations were measured.


Measurement result for product RFL111LW:

- All margins in the LTE Band 5 for harmonic emissions were at least 25 dB below the accepted limits for all test frequencies.

Measurement result for product RFP121LW:

- All margins in the LTE Band 5 for harmonic emissions were at least 25 dB below the accepted limits for all test frequencies.

See Appendix 4D for test data.

	EMI Test Report for the BlackBerry® smartphone Model RFL111LW, RFP121LW	
<b>Test Report No.:</b> RTS-6026-1302-12A_Rev1	<b>Dates of Test:</b> Nov. 22, 2012 to Mar. 04, 2013, and April 05, 2013	<b>FCC ID:</b> L6ARFL110LW, L6ARFP120LW <b>IC:</b> 2503A-RFL110LW, 2503A-RFP120LW

- e) The radiated spurious emissions/harmonics and ERP were measured for LTE Band 4.

The EUT was measured on the low, middle and high channels in 1.4MHz, 3MHz, 5MHz, 10MHz, 15MHz and 20MHz bandwidths for LTE Band 4 with QPSK and 16-QAM modulations. Different resource block allocations were investigated, a minimum one resource block case was also tested. Both the horizontal and vertical polarizations were measured.

Measurement result for product RFL111LW:

- The highest EIRP in the LTE Band 4 measured was 24.65 dBm (0.29 W) at 1744.90 MHz (channel 20299) in 20MHz BW, 1 resource block and QPSK modulation.
- The highest EIRP in the LTE Band 4 measured was 23.48 dBm (0.22 W) at 1744.90 MHz (channel 20299) in 20MHz BW, 1 resource block and 16-QAM modulation.

Measurement result for product RFP121LW:

- The highest EIRP in the LTE Band 4 measured was 23.64 dBm (0.23 W) at 1744.90 MHz (channel 20299) in 20MHz BW, 1 resource block and QPSK modulation.
- The highest EIRP in the LTE Band 4 measured was 22.35 dBm (0.17 W) at 1744.90 MHz (channel 20299) in 20MHz BW, 1 resource block and 16-QAM modulation.

The radiated carrier harmonics were measured up to the 10<sup>th</sup> harmonic. The EUT was measured on the low, middle and high channels in 1.4MHz, 3MHz, 5MHz, 10MHz, 15MHz and 20MHz bandwidths for LTE Band 4 with QPSK modulations. Different resource block allocations were investigated, a minimum one resource block case was also tested. Both the horizontal and vertical polarizations were measured.


Measurement result for product RFL111LW:

- All margins in the LTE Band 4 for harmonic emissions were at least 25 dB below the limit for all test frequencies.

Measurement result for product RFP121LW:

- All margins in the LTE Band 4 for harmonic emissions were at least 25 dB below the limit for all test frequencies.

See Appendix 5D for test data.

	EMI Test Report for the BlackBerry® smartphone Model RFL111LW, RFP121LW	
<b>Test Report No.:</b> RTS-6026-1302-12A_Rev1	<b>Dates of Test:</b> Nov. 22, 2012 to Mar. 04, 2013, and April 05, 2013	<b>FCC ID:</b> L6ARFL110LW, L6ARFP120LW <b>IC:</b> 2503A-RFL110LW, 2503A-RFP120LW

- f) The radiated spurious emissions/harmonics and ERP were measured for LTE Band 17.

The EUT was measured on the low, middle and high channels in 5MHz and 10MHz bandwidths for LTE band 17 with QPSK and 16-QAM modulations. Different resource block allocations were investigated, a minimum one resource block case was also tested. Both the horizontal and vertical polarizations were measured.

Measurement result for product RFL111LW:

- The highest EIRP in the LTE band 17 measured was 19.65 dBm (0.09 W) at 709.0 MHz (channel 23780) in 10MHz BW, 1 resource block and QPSK modulation.
- The highest EIRP in the LTE band 17 measured was 18.54 dBm (0.07 W) at 710.0 MHz (channel 23790) in 10MHz BW, 1 resource block and 16-QAM modulation.

Measurement result for product RFP121LW:

- The highest EIRP in the LTE band 17 measured was 19.62 dBm (0.09 W) at 710.0 MHz (channel 23790) in 10MHz BW, 1 resource block and QPSK modulation.
- The highest EIRP in the LTE band 17 measured was 18.26 dBm (0.07 W) at 709.0 MHz (channel 23780) in 10MHz BW, 1 resource block and 16-QAM modulation.

The radiated carrier harmonics were measured up to the 10<sup>th</sup> harmonic. The EUT was measured on the low, middle and high channels in 5MHz and 10MHz bandwidths for LTE Band 17 with QPSK modulations. Different resource block allocations were investigated, a minimum one resource block case was also tested. Both the horizontal and vertical polarizations were measured.


Measurement result for product RFL111LW:

- All margins in the LTE Band 17 for harmonic emissions were at least 25 dB below the limit for all test frequencies.

Measurement result for product RFP121LW:

- All margins in the LTE Band 17 for harmonic emissions were at least 25 dB below the limit for all test frequencies.

See Appendix 6D for test data.

	EMI Test Report for the BlackBerry® smartphone Model RFL111LW, RFP121LW	
<b>Test Report No.:</b> RTS-6026-1302-12A_Rev1	<b>Dates of Test:</b> Nov. 22, 2012 to Mar. 04, 2013, and April 05, 2013	<b>FCC ID:</b> L6ARFL110LW, L6ARFP120LW <b>IC:</b> 2503A-RFL110LW, 2503A-RFP120LW

### 3) Co-Location Radiated Measurements

The radiated emissions were measured up to 18 GHz for middle channels for simultaneous transmission in the following test configuration combinations:

The following test configurations were performed on product RFL111LW:

- GSM 850 + Bluetooth(DH5) + 802.11b
- PCS 1900 + Bluetooth(2DH5) + 802.11g
- WCDMA B2 + Bluetooth(3DH5)+ 802.11n(2.4GHz).
- WCDMA B5 + Bluetooth(DH5) + 802.11a
- LTE B2 + Bluetooth(2DH5) + 802.11b
- LTE B4 + Bluetooth(3DH5) + 802.11g
- LTE B5 + Bluetooth(DH5) + 802.11n(2.4GHz)
- LTE B17 + Bluetooth(2DH5) + 802.11a

The following test configurations were performed on product RFP121LW:

- UMTS B4 + Bluetooth(DH5) + 802.11a
- LTE B2 + Bluetooth(2DH5) + 802.11g


Both the horizontal and vertical polarizations were measured. The emissions due to different simultaneous transmission did not increase the amplitude of any emissions nor did it produce any new inter-modulation products as a result of mixing.

#### **Sample Calculation:**

Corrected Signal level (CSL) is calculated as follows:

$$\text{CSL (dBm)} = \text{Measured Level (dB}\mu\text{V)} - \text{Antenna Gain (dBi)} + \text{Free Space loss (dB)} - 107(\text{dB}) + \text{Cable Loss (dB)} - \text{Preamp (dB)} + \text{Filter Loss (dB)} - 2.15(\text{dB})$$


#### **Measurement Uncertainty ±4.5 dB**

		EMI Test Report for the BlackBerry® smartphone Model RFL111LW, RFP121LW	
<b>Test Report No.:</b> RTS-6026-1302-12A_Rev1	<b>Dates of Test:</b> Nov. 22, 2012 to Mar. 04, 2013, and April 05, 2013	<b>FCC ID:</b> L6ARFL110LW, L6ARFP120LW <b>IC:</b> 2503A-RFL110LW, 2503A-RFP120LW	

## G. Compliance Test Equipment Used

<u>UNIT</u>	<u>MANUFACTURER</u>	<u>MODEL</u>	<u>SERIAL NUMBER</u>	<u>CAL DUE DATE</u> (YY MM DD)	<u>USE</u>
Preamplifier	Sonoma	310N/11909A	185831	13-10-10	Radiated Emissions
Preamplifier system	TDK RF Solutions	PA-02	080010	13-10-10	Radiated Emissions
Preamplifier	Rohde & Schwarz	TS-ANA4-SP	001	13-09-01	Radiated Emissions
Preamplifier	Rohde & Schwarz	TS-ANA-SP	001	13-09-01	Radiated Emissions
Hybrid Log Antenna	EMC Automation	HLP-3003C	017301	13-08-23	Radiated Emissions
Horn Antenna	EMC Automation	HRN-0118	030101	14-08-07	Radiated Emissions
Horn Antenna	EMC Automation	HRN-0118	030201	13-03-15	Radiated Emissions
Horn Antenna	Emco	3117	47563	13-08-04	Radiated Emissions
Horn Antenna	ETS	3116	2538	14-09-29	Radiated Emissions
Dipole Antenna	Schwarzbeck	UHAP	974	14-11-27	Radiated Emissions
Universal Radio Communication Tester	Rohde & Schwarz	CMU 200	837493/073	13-11-26	Radiated Emissions
Universal Radio Communication Tester	Rohde & Schwarz	CMU 200	112394	13-11-25	Radiated Emissions
Universal Radio Communication Tester	Rohde & Schwarz	CMU 200	109747	13-10-18	RF Conducted Emissions
EMI Receiver	Rohde & Schwarz	ESIB-40	100255	13-11-30	Radiated Emissions
EMI Receiver	Rohde & Schwarz	ESU-40	100162	13-11-30	Radiated Emissions
DC Power Supply	HP	6632B	US37472178	13-09-25	RF Conducted Emissions
Environment Monitor	Omega	iTHX-SD	0380561	13-10-30	Radiated Emissions
Environment Monitor	Omega	iTHX-SD	0340060	13-10-30	RF Conducted Emissions
Environment Monitor	Omega	iTHX-SD	0380567	13-10-30	Radiated Emissions



		EMI Test Report for the BlackBerry® smartphone Model RFL111LW, RFP121LW	
<b>Test Report No.:</b> RTS-6026-1302-12A_Rev1	<b>Dates of Test:</b> Nov. 22, 2012 to Mar. 04, 2013, and April 05, 2013	<b>FCC ID:</b> L6ARFL110LW, L6ARFP120LW <b>IC:</b> 2503A-RFL110LW, 2503A-RFP120LW	


### Compliance Test Equipment Used cont'd

<u>UNIT</u>	<u>MANUFACTURER</u>	<u>MODEL</u>	<u>SERIAL NUMBER</u>	<u>CAL DUE DATE</u> (YY MM DD)	<u>USE</u>
Universal Radio Communication Tester	Rohde & Schwarz	CMW500	101469	13-12-10	Radiated /RF Conducted Emission
Universal Radio Communication Tester	Rohde & Schwarz	CMW500	109949	13-12-08	Radiated /RF Conducted Emission
Signal Generator	Agilent	E8257D	MY45140527	14-12-10	Radiated Emissions
Signal Generator	Agilent	83630B	3844A00927	14-11-23	Radiated Emissions
Spectrum Analyzer	Rohde & Schwarz	FSV	101820	13-11-28	RF Conducted Emissions
Spectrum Analyzer	Rohde & Schwarz	FSP	100884	13-11-22	RF Conducted Emissions

### H. Test Software used

<u>SOFTWARE</u>	<u>COMPANY</u>	<u>VERSION</u>	<u>USE</u>
EMC32	Rohde & Schwarz	8.52.0	Radiated Emissions
TDK Standard Emission Test	TDK RF Solutions	8.53.1.62	Radiated Emissions

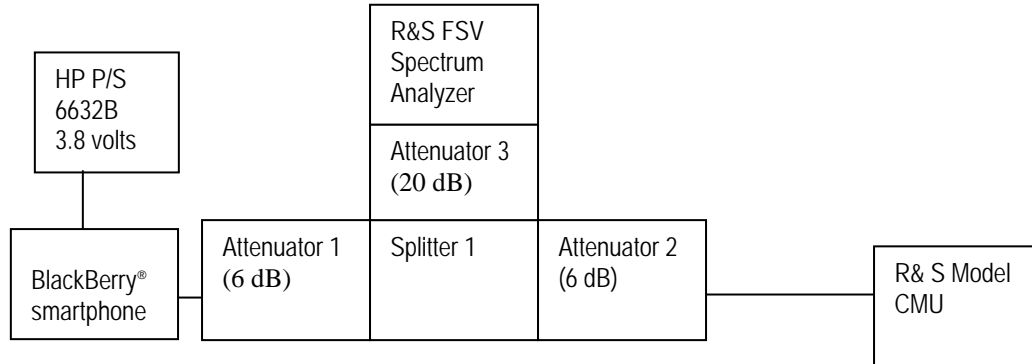
## APPENDIX 1A – GSM CONDUCTED RF EMISSIONS TEST DATA/PLOTS

	EMI Test Report for the BlackBerry® smartphone Model RFL111LW	
	<b>APPENDIX 1A</b>	
<b>Test Report No.:</b> RTS-6026-1302-12A_Rev1	<b>Dates of Test:</b> Nov. 22, 2012 to Mar. 04, 2013, and April 05, 2013	<b>FCC ID:</b> L6ARFL110LW, L6ARFP120LW <b>IC:</b> 2503A-RFL110LW, 2503A-RFP120LW

### GSM Conducted RF Emission Test Data

This appendix contains measurement data pertaining to conducted spurious emissions, -26 dBc bandwidth, 99% power bandwidth and the channel mask on BlackBerry® smartphone.

#### Test Setup Diagram



A reference offset of 31.4 dB was applied to the spectrum analyzer reference level for the attenuators and coaxial cable loss in the test circuit.


<u>UNIT</u>	<u>MANUFACTURER</u>	<u>MODEL</u>	<u>SERIAL NUMBER</u>
Attenuator 1	Mini-Circuits	BW-S6W2+	0647
Attenuator 2	Mini-Circuits	BW-S6W2+	0648
Attenuator 3	Mini-Circuits	BW-S20-2W263+	1234
Splitter 1	Weinschel	1515	MES 92

The environmental test conditions were:

Temperature: 23.1 °C  
 Relative Humidity: 28.9 %

The following measurements were performed by Berkin Can.

The following tests were performed on product RFL111LW.

	EMI Test Report for the BlackBerry® smartphone Model RFL111LW	
	<b>APPENDIX 1A</b>	
<b>Test Report No.:</b> RTS-6026-1302-12A_Rev1	<b>Dates of Test:</b> Nov. 22, 2012 to Mar. 04, 2013, and April 05, 2013	<b>FCC ID:</b> L6ARFL110LW, L6ARFP120LW <b>IC:</b> 2503A-RFL110LW, 2503A-RFP120LW

### GSM Conducted RF Emission Test Data cont'd

**The conducted spurious emissions** – As per 47 CFR 2.1051, CRF 22.917, CFR 24.238(a), RSS-GEN, 4.9, RSS-132, 5.5 and RSS-133, 6.5 were measured from 30 MHz to 20 GHz.

#### **–26 dBc Bandwidth and Occupied Bandwidth (99%)**

For each carrier frequency of low, middle and high, the modulation spectrum was measured by both methods of 99% power bandwidth and –26 dBc bandwidth.

The resolution bandwidth required for out-of-band emissions in the 1 MHz bands immediately outside and adjacent to the frequency block, was determined to be at least 1% of the emission bandwidth.

The worst case –26dBc bandwidth for the GSM850 band was measured to be 277 kHz, and for the PCS1900 band was measured to be 273 kHz as shown below. Results were derived in a 3.0 kHz resolution bandwidth.

On any frequency outside the frequency block and outside the adjacent 1 MHz bands, a resolution bandwidth of at least 1 MHz was applied.

#### Test Data for GSM850 band and PCS1900 band in Call mode

<b>GSM850 band Frequency (MHz)</b>	<b>-26dBc Bandwidth (kHz)</b>	<b>99% Occupied Bandwidth (kHz)</b>
824.2	272.1	244.6
837.6	272.1	244.6
848.8	279.3	243.1


<b>PCS1900 band Frequency (MHz)</b>	<b>-26dBc Bandwidth (kHz)</b>	<b>99% Occupied Bandwidth (kHz)</b>
1850.2	275.0	244.6
1880.0	279.3	244.6
1909.8	270.6	244.6

#### **Measurement Plots for 850 and 1900 bands in Call mode**

See Figures 1-1a to 1-12a for the plots of the conducted spurious emissions.

See Figures 1-13a to 1-24a for the plots of 26dBc/99% Occupied Bandwidth.

See Figures 1-25a to 1-28a for the plots of the Channel mask.

	EMI Test Report for the BlackBerry® smartphone Model RFL111LW <b>APPENDIX 1A</b>	
	<b>Test Report No.:</b> RTS-6026-1302-12A_Rev1	<b>Dates of Test:</b> Nov. 22, 2012 to Mar. 04, 2013, and April 05, 2013

GSM Conducted RF Emission Test Data cont'd

**Test Data for GSM850 and PCS1900 bands in EDGE mode**

<b>GSM850 band Frequency (MHz)</b>	<b>99% Occupied Bandwidth (kHz)</b>
824.2	244.6
837.6	244.6
848.8	246.0


<b>PCS1900 band Frequency (MHz)</b>	<b>99% Occupied Bandwidth (kHz)</b>
1850.2	243.1
1880.0	244.6
1909.8	243.1

***Measurement Plots for GSM850 and PCS1900 bands in EDGE mode***

See Figures 1-29a to 1-34a for the plots of the 99% Occupied Bandwidth EDGE results.

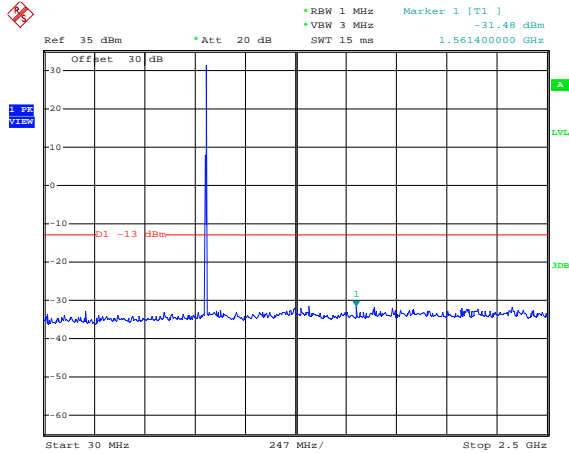
See Figures 1-35a to 1-38a for the plots of channel mask EDGE results.

See Figures 1-39a to 1-50a for the plots of the conducted spurious emissions EDGE results

	EMI Test Report for the BlackBerry® smartphone Model RFL111LW <b>APPENDIX 1A</b>	
	<b>Test Report No.:</b> RTS-6026-1302-12A_Rev1	<b>Dates of Test:</b> Nov. 22, 2012 to Mar. 04, 2013, and April 05, 2013

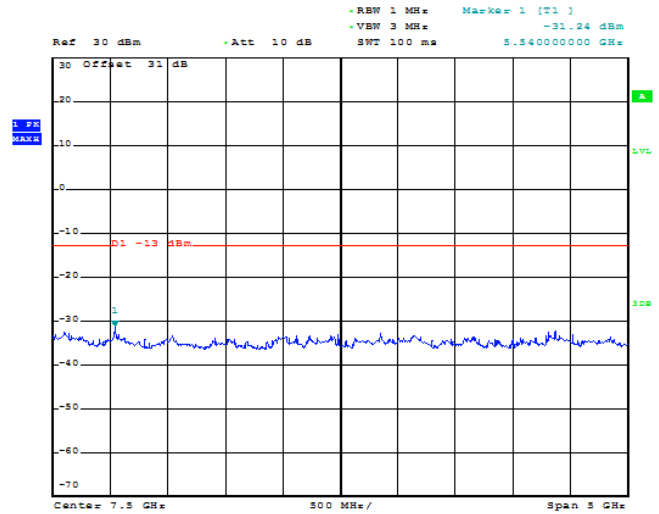
### GSM Conducted RF Emission Test Data cont'd

**Figure 1-1a: GSM850 band, Spurious Conducted Emissions, Low channel**

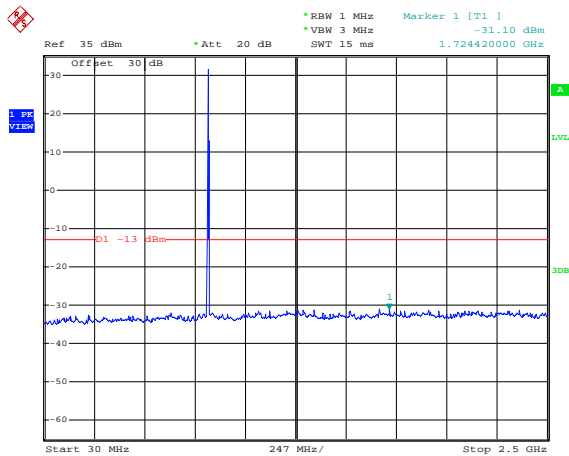


Date: 5.DEC.2012 14:40:01

**Figure 1-2a: GSM850 band, Spurious Conducted Emissions, Low channel**

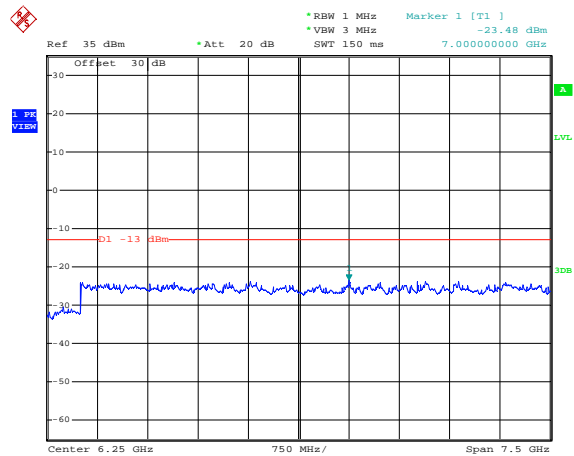


**Figure 1-3a: GSM850 band, Spurious Conducted Emissions, Middle Channel**




Date: 5.DEC.2012 14:57:22

**Figure 1-4a: GSM850 band, Spurious Conducted Emissions, Middle Channel**

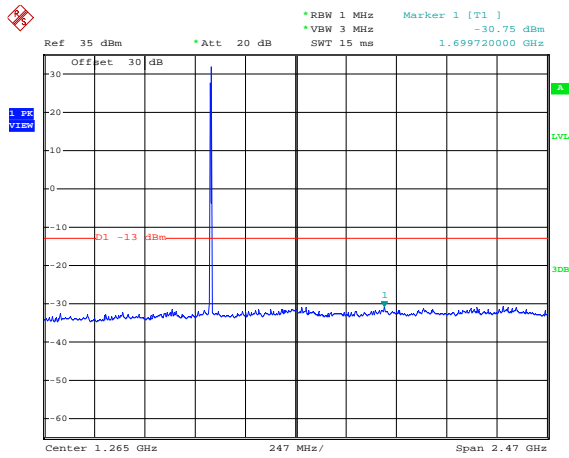


Date: 5.DEC.2012 14:53:50

	EMI Test Report for the BlackBerry® smartphone Model RFL111LW <b>APPENDIX 1A</b>	
	<b>Test Report No.:</b> RTS-6026-1302-12A_Rev1	<b>Dates of Test:</b> Nov. 22, 2012 to Mar. 04, 2013, and April 05, 2013

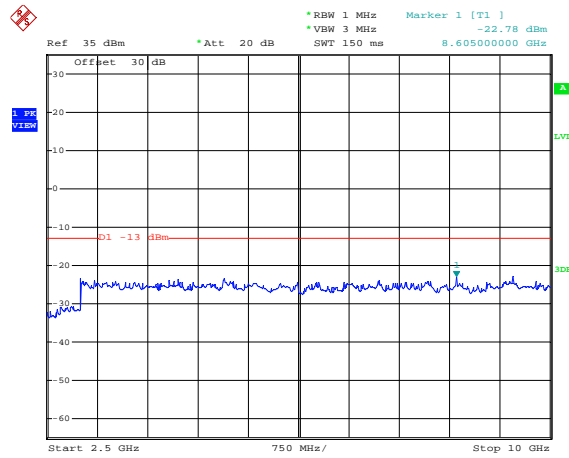
### GSM Conducted RF Emission Test Data cont'd

**Figure 1-5a: GSM850 band, Spurious Conducted Emissions, High Channel**



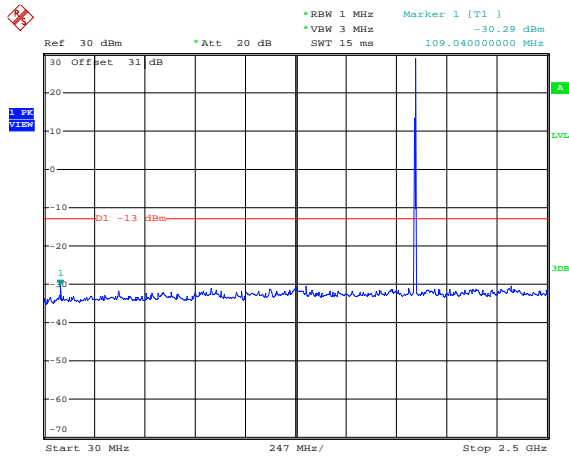
Date: 5.DEC.2012 15:04:13

**Figure 1-6a: GSM850 band, Spurious Conducted Emissions, High Channel**



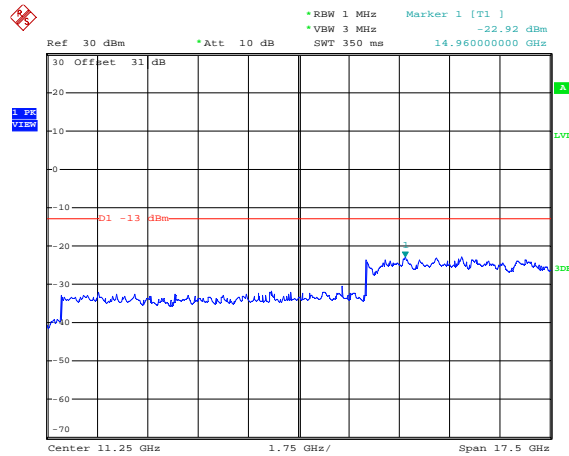
Date: 5.DEC.2012 15:04:57

**Figure 1-7a: PCS1900 band, Spurious Conducted Emissions, Low Channel**




Date: 6.DEC.2012 18:11:54

**Figure 1-8a: PCS1900 band, Spurious Conducted Emissions, Low Channel**

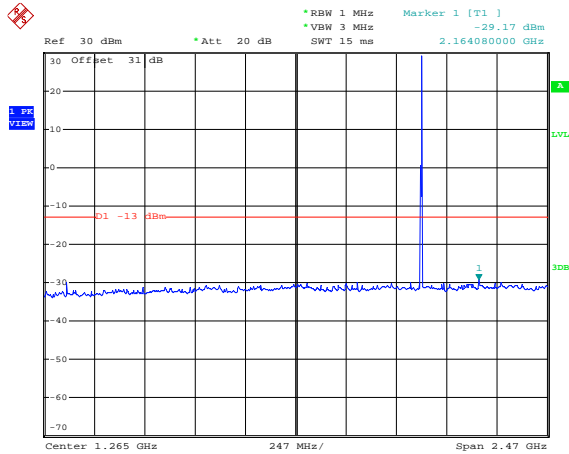


Date: 6.DEC.2012 18:10:20

	<b>EMI Test Report for the BlackBerry® smartphone Model RFL111LW</b> <b>APPENDIX 1A</b>	
	<b>Test Report No.:</b> RTS-6026-1302-12A_Rev1	<b>Dates of Test:</b> Nov. 22, 2012 to Mar. 04, 2013, and April 05, 2013

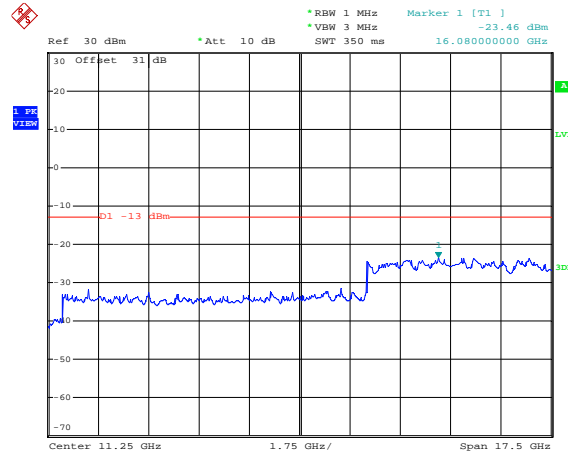
### GSM Conducted RF Emission Test Data cont'd

**Figure 1-9a: PCS1900 band, Spurious Conducted Emissions, Middle Channel**



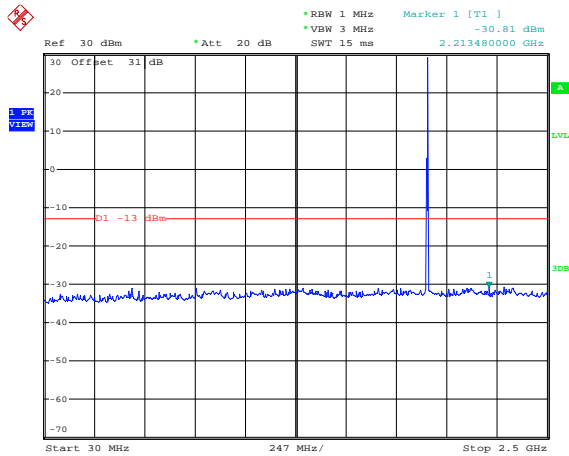
Date: 6.DEC.2012 18:24:48

**Figure 1-10a: PCS1900 band, Spurious Conducted Emissions, Middle Channel**



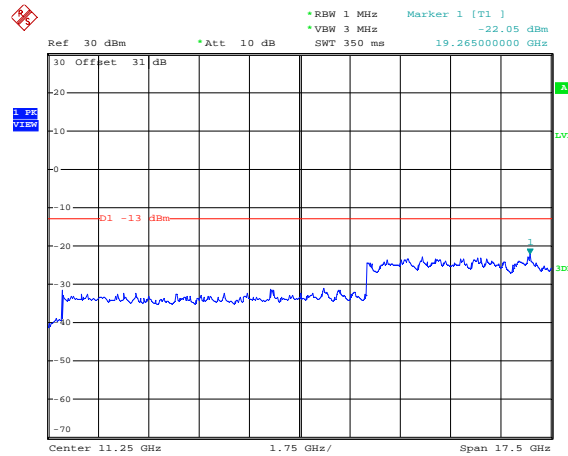
Date: 6.DEC.2012 18:08:14

**Figure 1-11a: PCS1900 band, Spurious Conducted Emissions, High Channel**




Date: 6.DEC.2012 18:27:32

**Figure 1-12a: PCS1900 band, Spurious Conducted Emissions, High Channel**



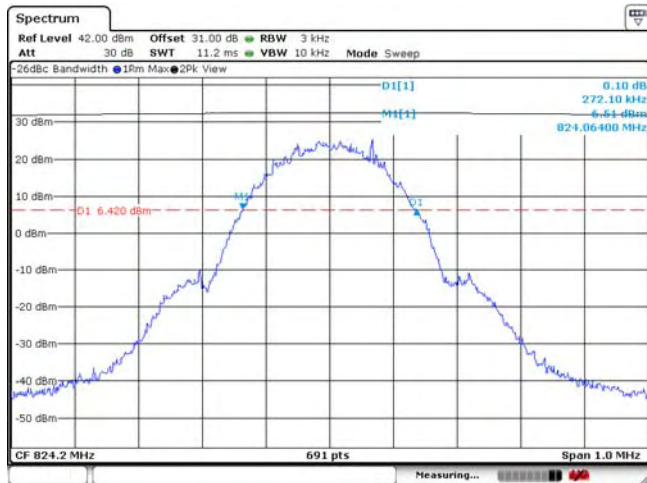
Date: 6.DEC.2012 18:07:21



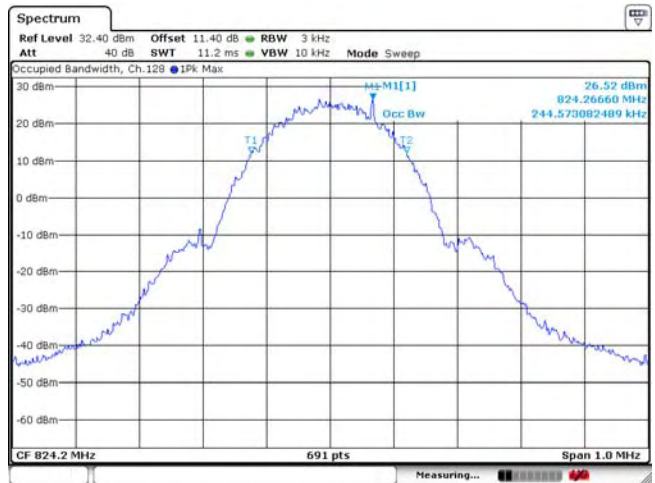
	EMI Test Report for the BlackBerry® smartphone Model RFL111LW <b>APPENDIX 1A</b>	
<b>Test Report No.:</b> RTS-6026-1302-12A_Rev1	<b>Dates of Test:</b> Nov. 22, 2012 to Mar. 04, 2013, and April 05, 2013	<b>FCC ID:</b> L6ARFL110LW, L6ARFP120LW <b>IC:</b> 2503A-RFL110LW, 2503A-RFP120LW

### GSM Conducted RF Emission Test Data cont'd

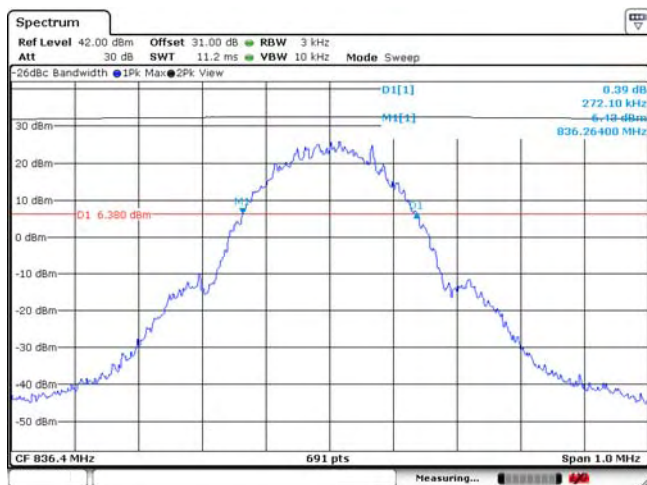
**Figure 1-13a: -26dBc bandwidth, GSM850 band Low Channel in GSM mode**



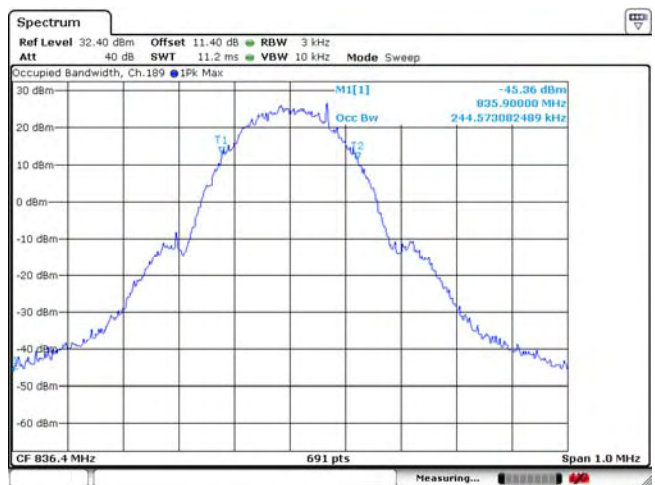
**Figure 1-14a: Occupied Bandwidth, GSM850 band Low Channel in GSM mode**




**Figure 1-15a: -26dBc bandwidth, GSM850 band Middle Channel in GSM mode**



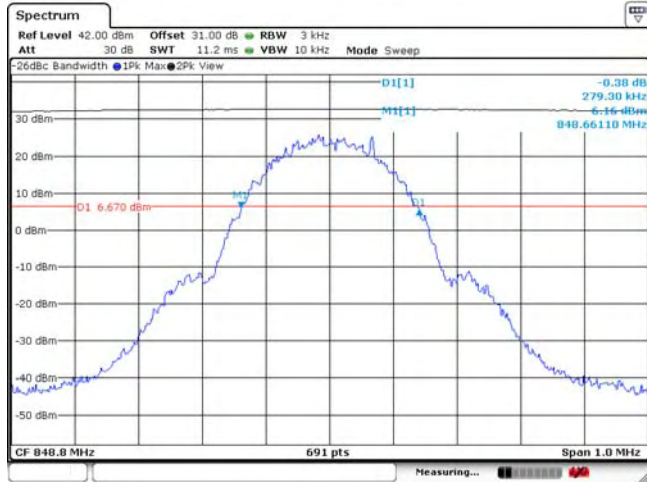
**Figure 1-16a: Occupied Bandwidth, GSM850 band Middle Channel in GSM mode**



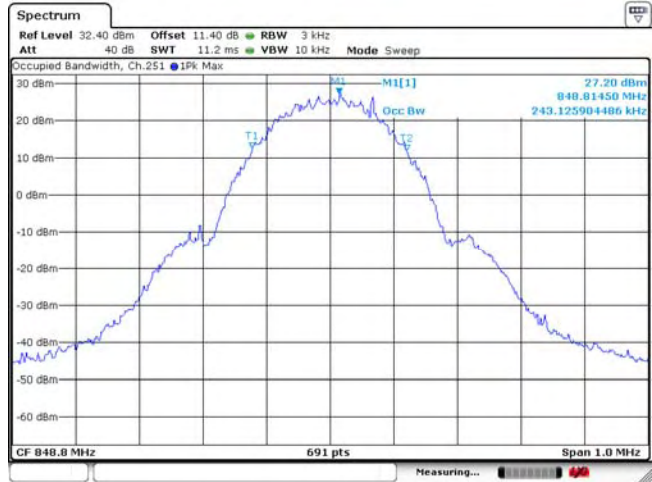
	<b>EMI Test Report for the BlackBerry® smartphone Model RFL111LW</b> <b>APPENDIX 1A</b>	
	<b>Test Report No.:</b> RTS-6026-1302-12A_Rev1	<b>Dates of Test:</b> Nov. 22, 2012 to Mar. 04, 2013, and April 05, 2013

### GSM Conducted RF Emission Test Data cont'd

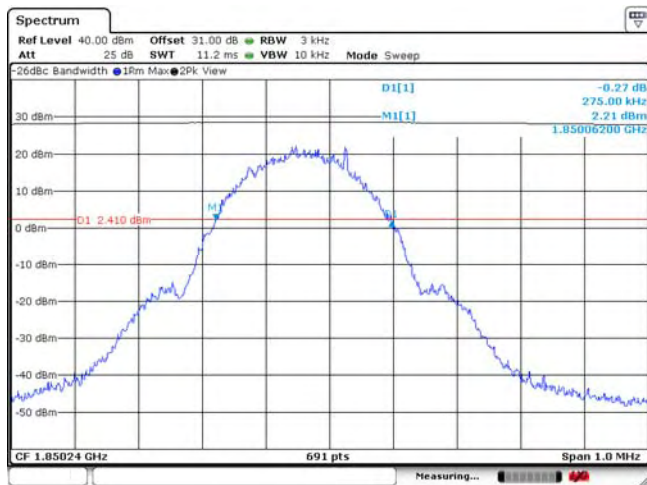
**Figure 1-17a: -26dBc bandwidth, GSM850 band High Channel in GSM mode**



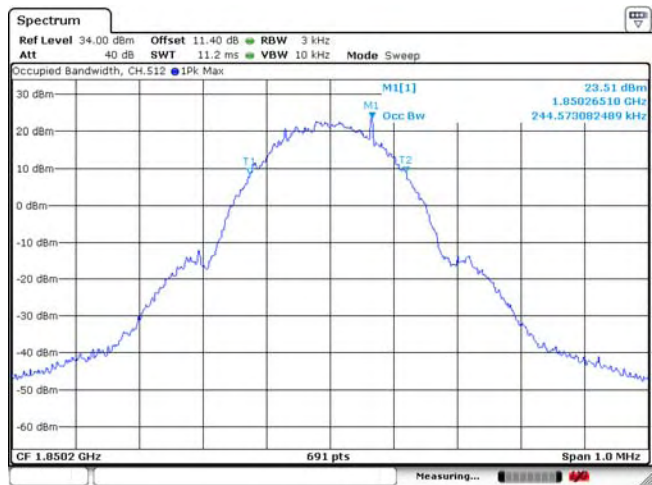
**Figure 1-18a: Occupied Bandwidth, GSM850 band High Channel in GSM mode**



**Figure 1-19a: -26dBc bandwidth, PCS1900 Low Channel in GSM mode**



**Figure 1-20a: Occupied Bandwidth, PCS1900 Low Channel in GSM mode**



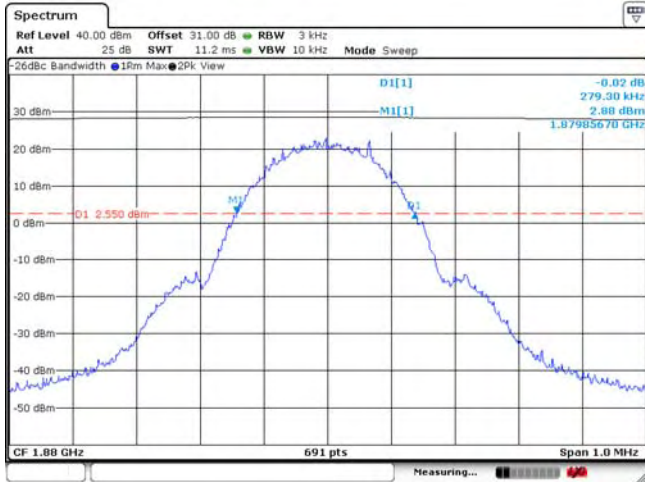
Test Report No.:  
 RTS-6026-1302-12A\_Rev1

Dates of Test:  
 Nov. 22, 2012 to Mar. 04, 2013,  
 and April 05, 2013

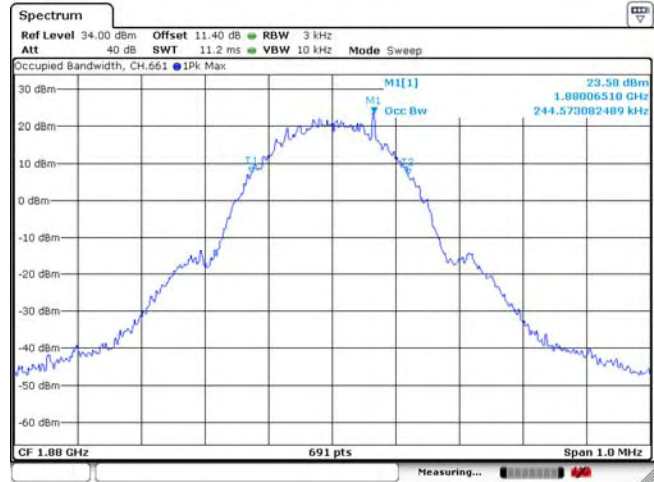
FCC ID: L6ARFL110LW, L6ARFP120LW  
 IC: 2503A-RFL110LW, 2503A-RFP120LW

**GSM Conducted RF Emission Test Data cont'd**

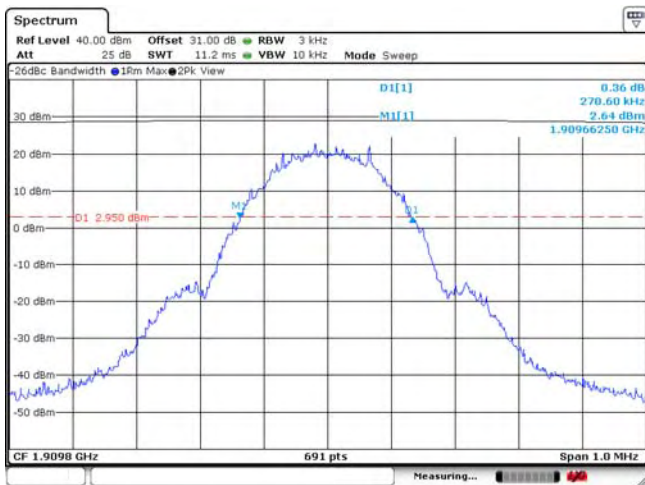
**Figure 1-21a: -26dBc bandwidth, PCS1900 Middle Channel in GSM mode**



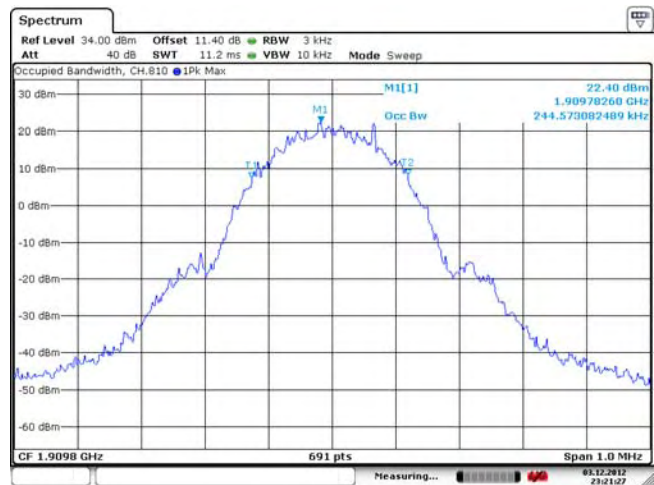
**Figure 1-22a: Occupied Bandwidth, PCS1900 Middle Channel in GSM mode**



**Figure 1-23a: -26dBc bandwidth, PCS1900 High Channel in GSM mode**



**Figure 1-24a: Occupied Bandwidth, PCS1900 High Channel in GSM mode**



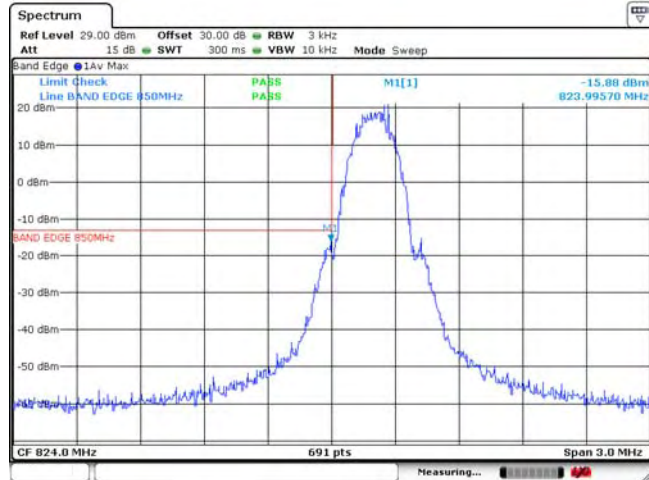
**Test Report No.:**  
 RTS-6026-1302-12A\_Rev1

**Dates of Test:**  
 Nov. 22, 2012 to Mar. 04, 2013,  
 and April 05, 2013

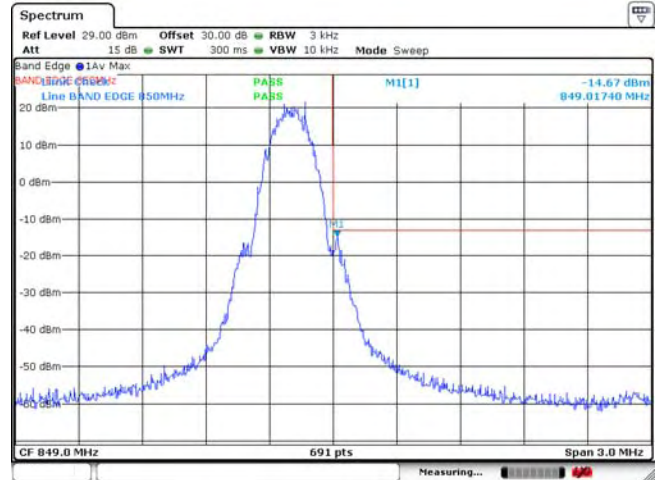
**FCC ID:** L6ARFL110LW, L6ARFP120LW  
**IC:** 2503A-RFL110LW, 2503A-RFP120LW

GSM Conducted RF Emission Test Data cont'd

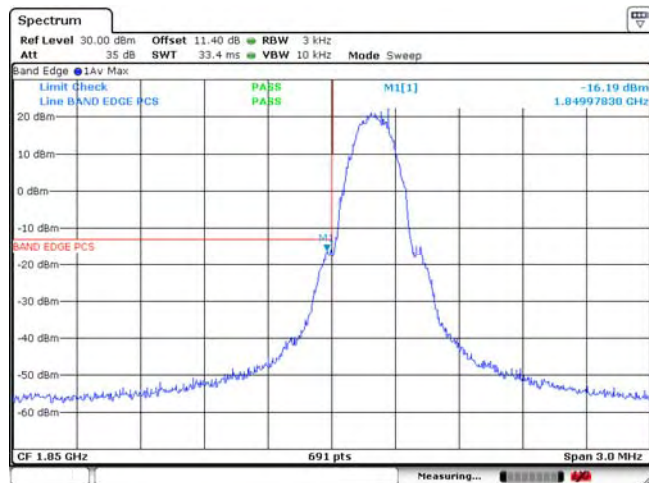
**Figure 1-25a: GSM850 band, Low Channel Mask in GSM mode**



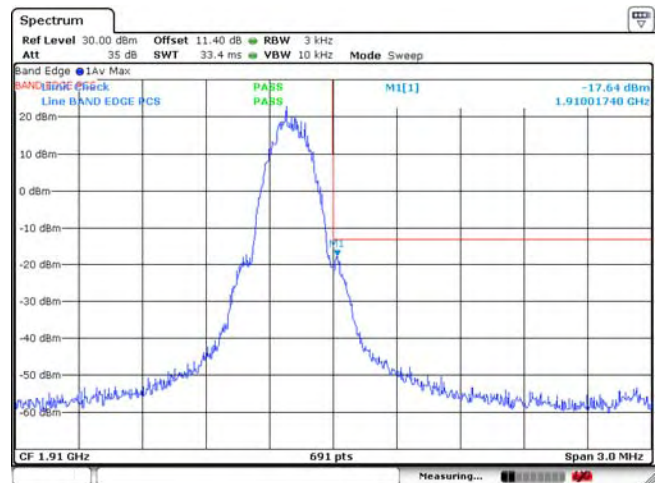
**Figure 1-26a: GSM850 band High Channel Mask in GSM mode**



**Figure 1-27a: PCS1900, Low Channel Mask in GSM mode**



**Figure 1-28a: PCS1900, High Channel Mask in GSM mode**



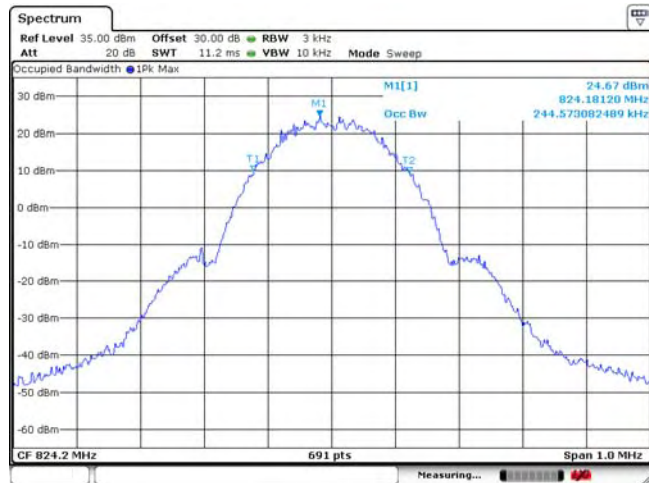
**Test Report No.:**  
 RTS-6026-1302-12A\_Rev1

**Dates of Test:**  
 Nov. 22, 2012 to Mar. 04, 2013,  
 and April 05, 2013

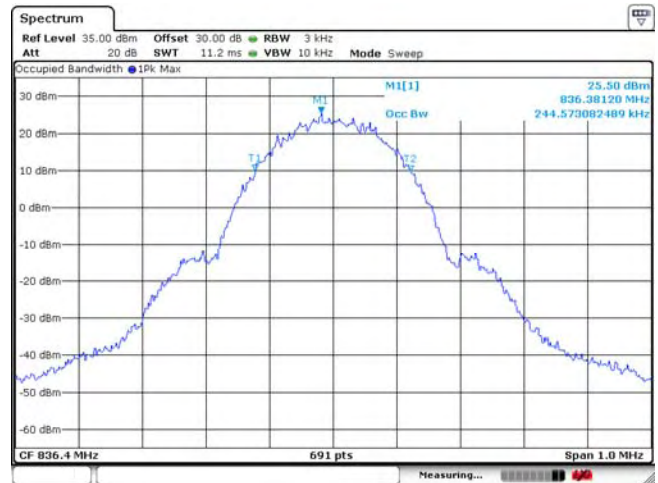
**FCC ID:** L6ARFL110LW, L6ARFP120LW  
**IC:** 2503A-RFL110LW, 2503A-RFP120LW

GSM Conducted RF Emission Test Data cont'd

**Figure 1-29a: Occupied Bandwidth, GSM850 Band, Low Channel in EDGE mode**



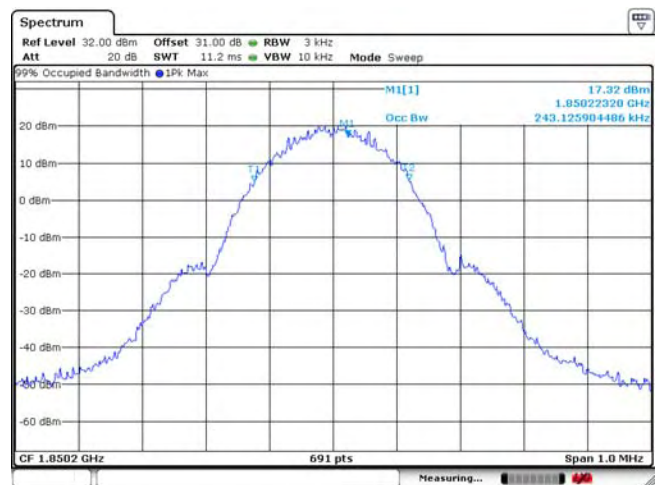
**Figure 1-30a: Occupied Bandwidth, GSM850 Band, Middle Channel in EDGE mode**




**Figure 1-31a: Occupied Bandwidth, GSM850 band, High Channel in EDGE mode**



**Figure 1-32a: Occupied Bandwidth, PCS1900 Band, Low Channel in EDGE mode**

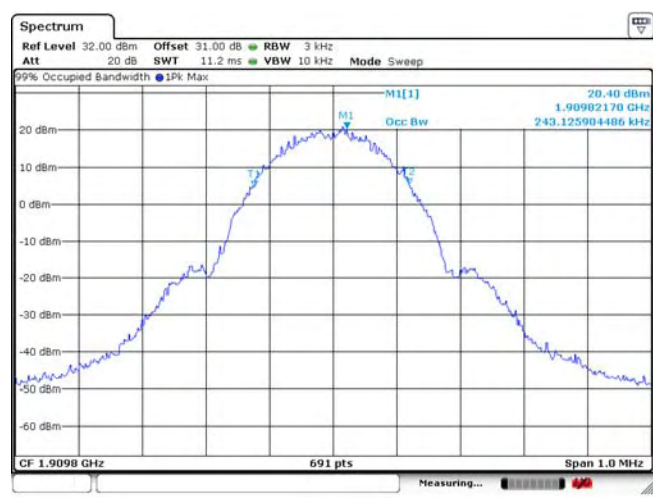
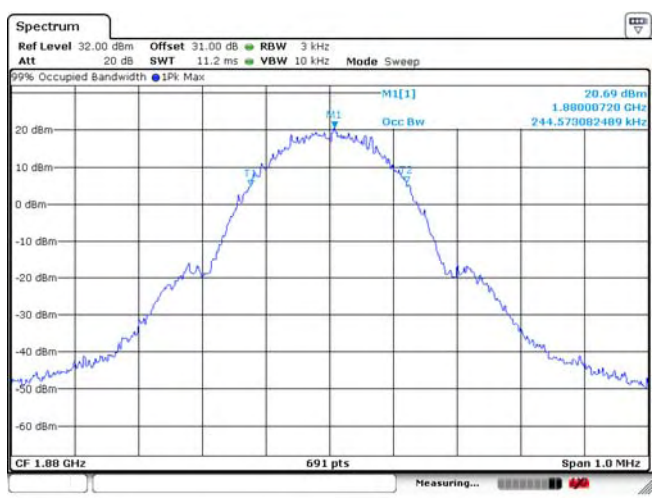


	EMI Test Report for the BlackBerry® smartphone Model RFL111LW <b>APPENDIX 1A</b>	
<b>Test Report No.:</b> RTS-6026-1302-12A_Rev1	<b>Dates of Test:</b> Nov. 22, 2012 to Mar. 04, 2013, and April 05, 2013	<b>FCC ID:</b> L6ARFL110LW, L6ARFP120LW <b>IC:</b> 2503A-RFL110LW, 2503A-RFP120LW

GSM Conducted RF Emission Test Data cont'd

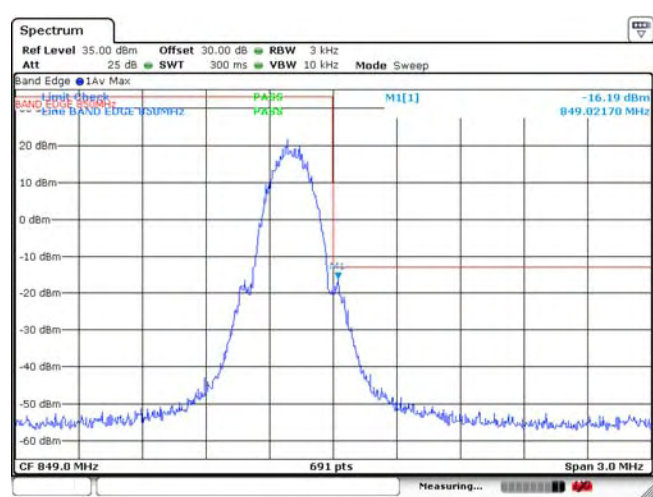
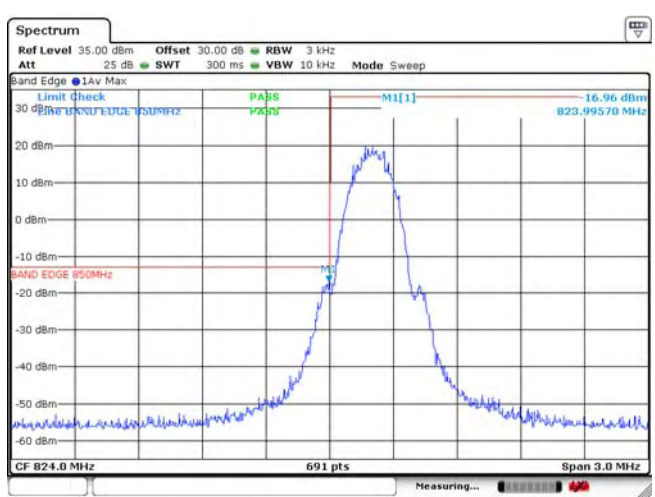
**Figure 1-33a: Occupied Bandwidth, PCS1900 Band, Middle Channel in EDGE mode**


**Figure 1-34a: Occupied Bandwidth, PCS1900 Band, High Channel in EDGE mode**



**Figure 1-35a: GSM850 Band, Low Channel Mask in EDGE mode**

**Figure 1-36a: GSM850 Band, High Channel Mask in EDGE mode**

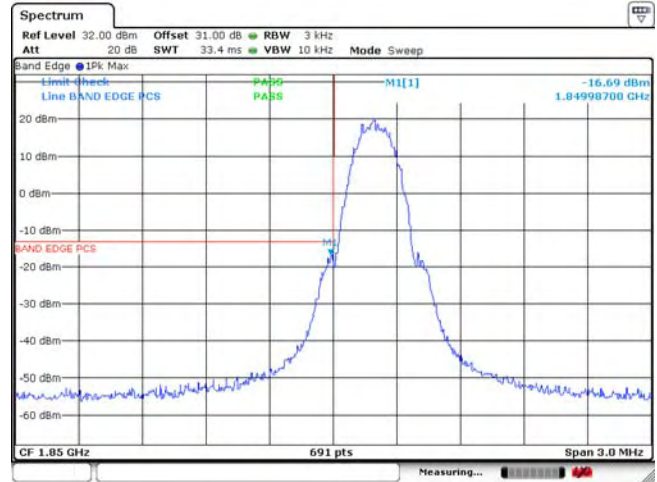
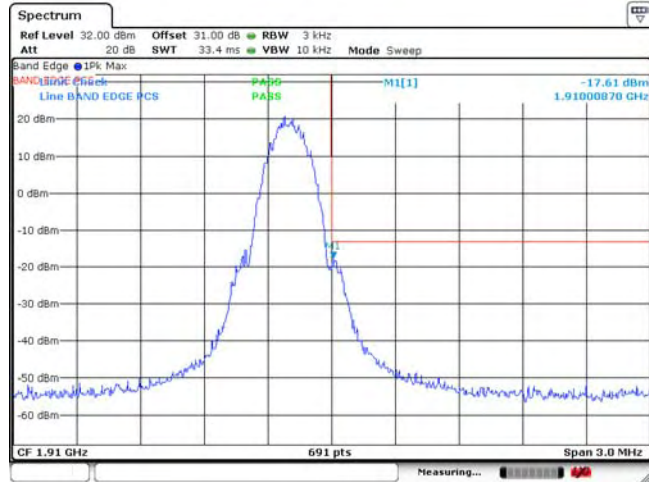



	EMI Test Report for the BlackBerry® smartphone Model RFL111LW <b>APPENDIX 1A</b>	
<b>Test Report No.:</b> RTS-6026-1302-12A_Rev1	<b>Dates of Test:</b> Nov. 22, 2012 to Mar. 04, 2013, and April 05, 2013	<b>FCC ID:</b> L6ARFL110LW, L6ARFP120LW <b>IC:</b> 2503A-RFL110LW, 2503A-RFP120LW

GSM Conducted RF Emission Test Data cont'd

**Figure 1-37a: PCS1900 Band, Low Channel Mask in EDGE mode**

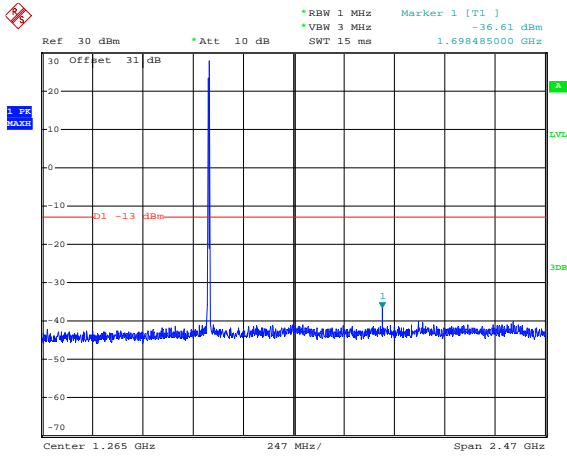
**Figure 1-38a: PCS1900 Band, High Channel Mask in EDGE mode**



	EMI Test Report for the BlackBerry® smartphone Model RFL111LW <b>APPENDIX 1A</b>	
	<b>Test Report No.:</b> RTS-6026-1302-12A_Rev1	<b>Dates of Test:</b> Nov. 22, 2012 to Mar. 04, 2013, and April 05, 2013

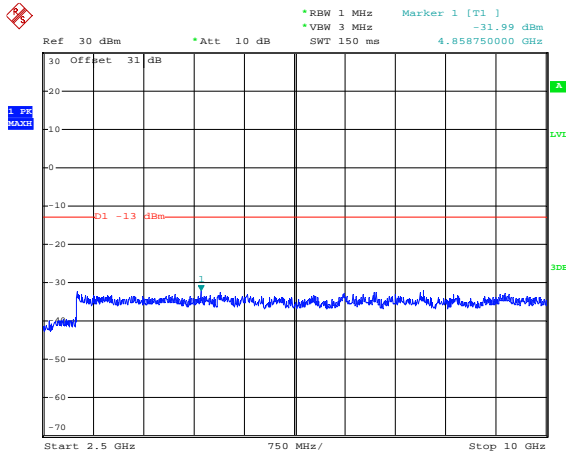
### GSM Conducted RF Emission Test Data cont'd

**Figure 1-39a: GSM850 band, Spurious Conducted Emissions, Low channel in Edge Mode**



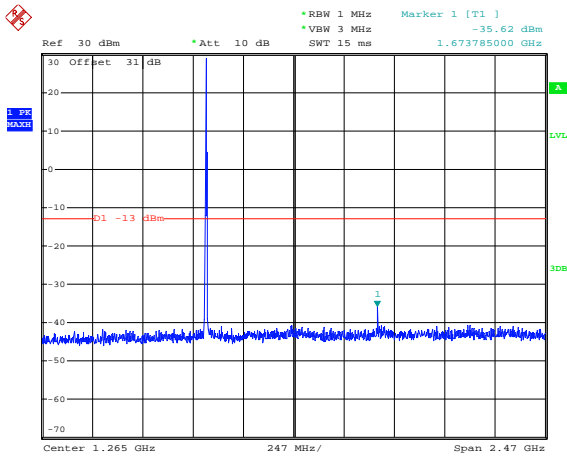
Date: 10.DEC.2012 15:48:53

**Figure 1-40a: GSM850 band, Spurious Conducted Emissions, Low channel in Edge Mode**



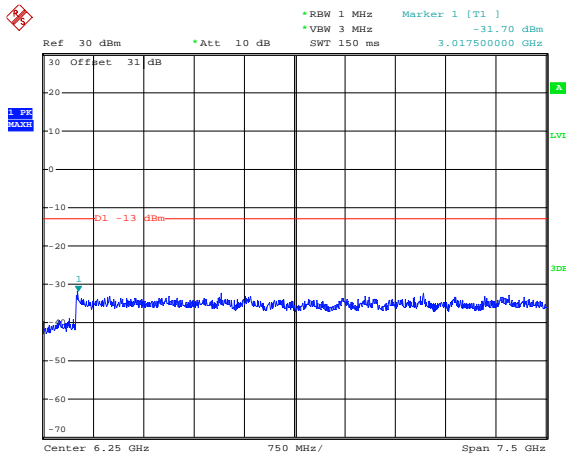
Date: 10.DEC.2012 15:46:32

**Figure 1-41a: GSM850 band, Spurious Conducted Emissions, Middle channel in Edge Mode**




Date: 10.DEC.2012 16:02:32

**Figure 1-42a: GSM850 band, Spurious Conducted Emissions, Middle channel in Edge Mode**



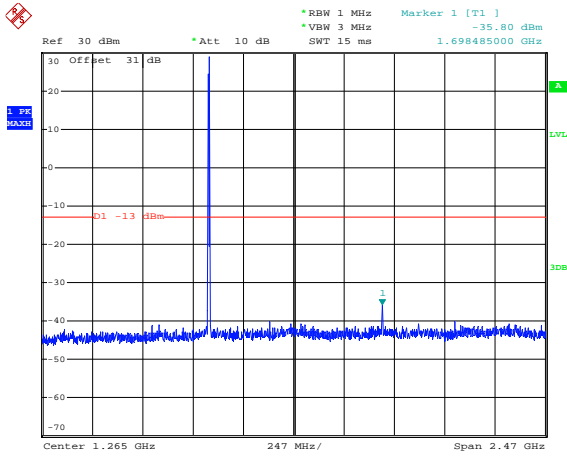
Date: 10.DEC.2012 15:47:19



	EMI Test Report for the BlackBerry® smartphone Model RFL111LW <b>APPENDIX 1A</b>	
	<b>Test Report No.:</b> RTS-6026-1302-12A_Rev1	<b>Dates of Test:</b> Nov. 22, 2012 to Mar. 04, 2013, and April 05, 2013

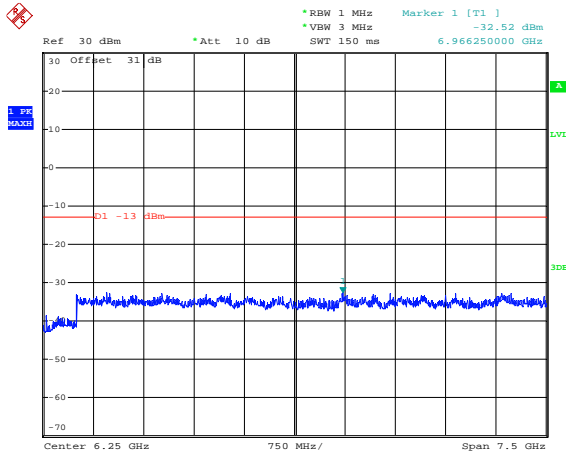
### GSM Conducted RF Emission Test Data cont'd

**Figure 1-43a: GSM850 band, Spurious Conducted Emissions, High channel in Edge Mode**



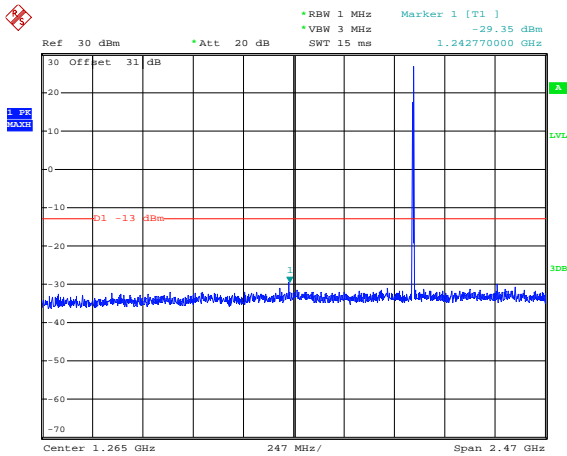
Date: 10.DEC.2012 16:03:07

**Figure 1-44a: GSM850 band, Spurious Conducted Emissions, High channel in Edge Mode**



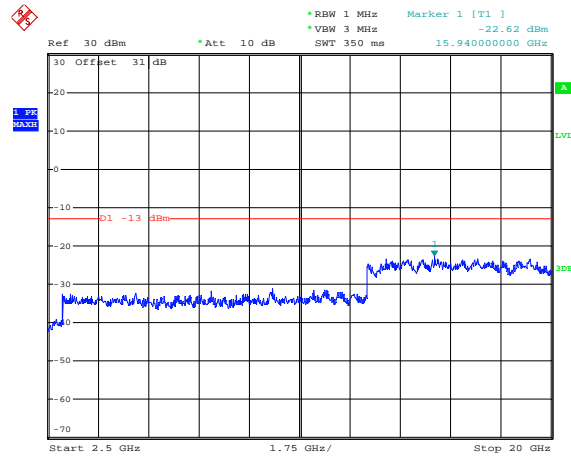
Date: 10.DEC.2012 15:48:13

**Figure 1-45a: PCS1900 band, Spurious Conducted Emissions, Low channel in Edge Mode**




Date: 10.DEC.2012 15:13:30

**Figure 1-46a: PCS1900 band, Spurious Conducted Emissions, Low channel in Edge Mode**

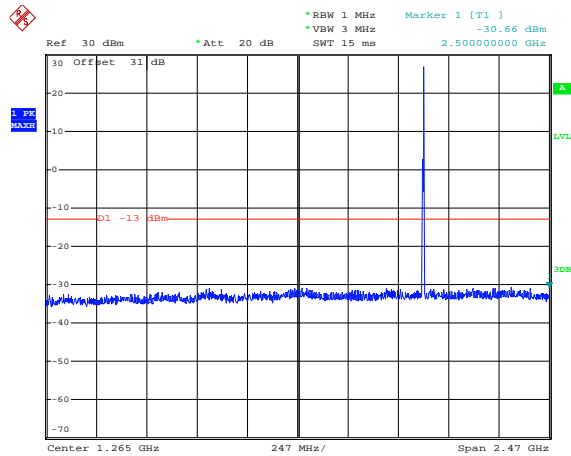


Date: 10.DEC.2012 15:41:24

	<b>EMI Test Report for the BlackBerry® smartphone Model RFL111LW</b> <b>APPENDIX 1A</b>	
	<b>Test Report No.:</b> RTS-6026-1302-12A_Rev1	<b>Dates of Test:</b> Nov. 22, 2012 to Mar. 04, 2013, and April 05, 2013

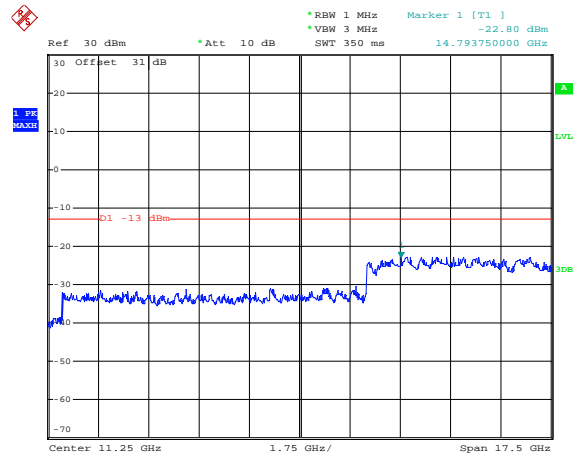
### GSM Conducted RF Emission Test Data cont'd

**Figure 1-47a: PCS1900 band, Spurious Conducted Emissions, middle channel in Edge Mode**



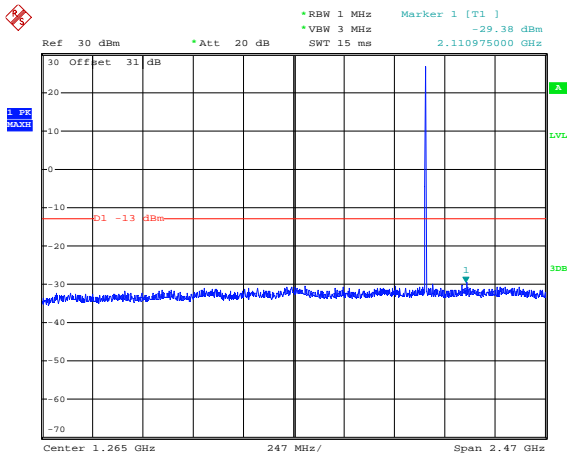
Date: 10.DEC.2012 15:19:36

**Figure 1-48a: PCS1900 band, Spurious Conducted Emissions, middle channel in Edge Mode**



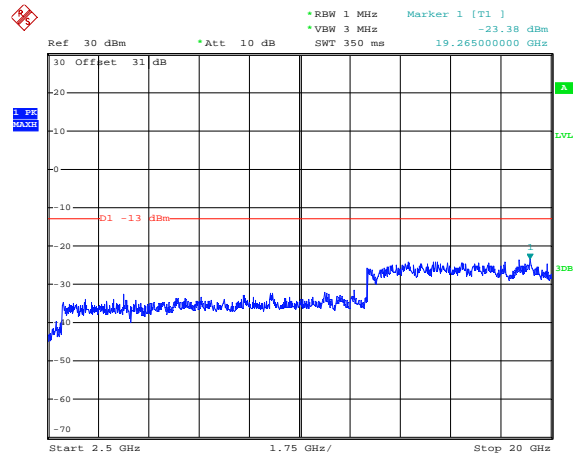
Date: 10.DEC.2012 15:39:04

**Figure 1-49a: PCS1900 band, Spurious Conducted Emissions, High channel in Edge Mode**




Date: 10.DEC.2012 15:22:40

**Figure 1-50a: PCS1900 band, Spurious Conducted Emissions, High channel in Edge Mode**

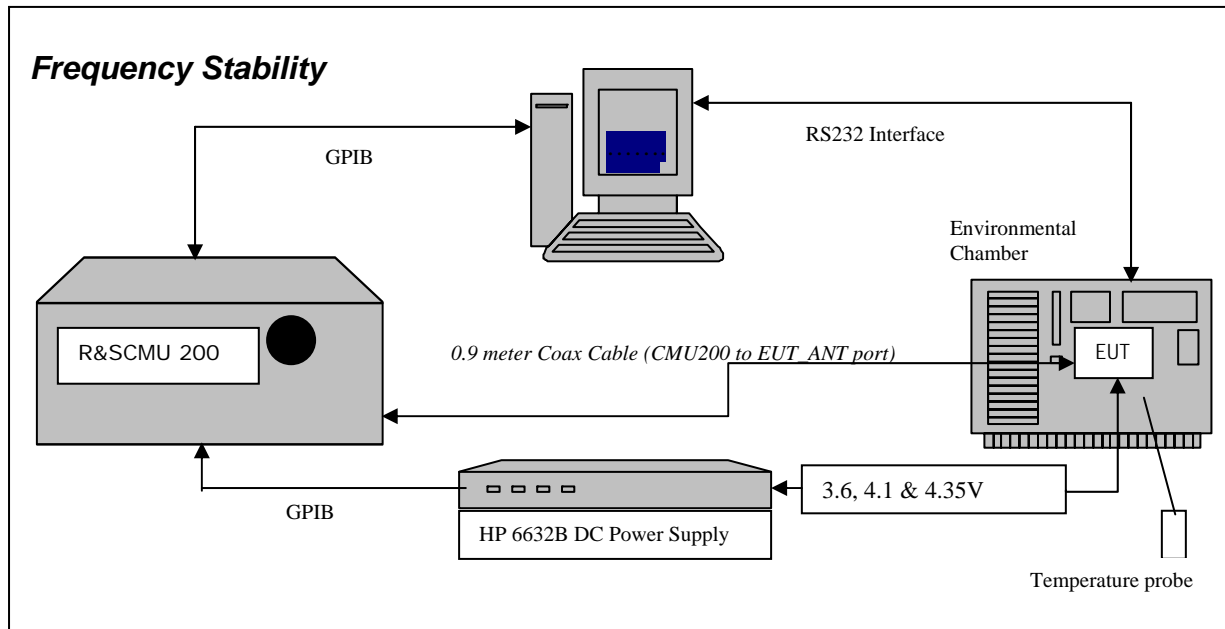


Date: 10.DEC.2012 15:23:49

## APPENDIX 1B – GSM FREQUENCY STABILITY TEST DATA

	EMI Test Report for the BlackBerry® smartphone Model RFL111LW <b>APPENDIX 1B</b>	
	<b>Test Report No.:</b> RTS-6026-1302-12A_Rev1	<b>Dates of Test:</b> Nov. 22, 2012 to Mar. 04, 2013, and April 05, 2013

### GSM Frequency Stability Test Data



The measurements were performed by Berkin Can.

CFR 47 Chapter 1 - Federal Communications Commission Rules

Part 2 Required Measurements

2.995 Frequency Stability - Procedures

(a,b) Frequency Stability - Temperature Variation

(d) Frequency Stability - Voltage Variation


#### **24.235 Frequency Stability.**

*The frequency stability shall be sufficient to ensure that the fundamental emission stays within the authorized frequency block.*

*The EUT meets the requirements as stated in CFR 47 chapter 1, Section 24.235, CFR 47 chapter 1, Section 22.917 RSS-132, 4.3 Frequency Stability, and RSS-133, 6.3 Frequency Stability.*

Frequency Stability measurement devices were configured as presented in the block diagram recording frequency, power, data, temperatures, and stepped voltages controlled via a GPIB interface linked to the Environmental chamber, a DC power supply, and the Communications Test Set. A 0.9-metre coax cable was calibrated to characterize the insertion loss for the transmitted frequencies between the RF input/output of the CMU 200 and the EUT antenna port.

Calibration for the Cable Loss was performed in the RF Laboratory using the Agilent power meter and Agilent Signal Generator.

	EMI Test Report for the BlackBerry® smartphone Model RFL111LW	
	<b>APPENDIX 1B</b>	
<b>Test Report No.:</b> RTS-6026-1302-12A_Rev1	<b>Dates of Test:</b> Nov. 22, 2012 to Mar. 04, 2013, and April 05, 2013	<b>FCC ID:</b> L6ARFL110LW, L6ARFP120LW <b>IC:</b> 2503A-RFL110LW, 2503A-RFP120LW

**Test setup:**


The EUT was placed in the Temperature chamber and connected to CMU 200 outside as shown in the figure above. Dry air was pumped inside the temperature chamber to maintain a backpressure during the test. The EUT was kept in the off condition at all times except when the measurements were to be made.

The chamber was switched on and the temperature was set to -30°C. After the chamber stabilized at -30 °C there was a soak period of one hour to alleviate moisture in the chamber, the EUT voltage was enabled. The system software recorded the frequency, power, and associated measurements.

A Computer system controlled the automated software. This application was given the command of activating all machines intrinsic to the temperature and voltage tests controlling the CMU 200 via the GPIB Bus. The Environmental Chamber was instructed through an RS-232 serial line. The EUT dialogue was passed through a serial connection.

The EUT repetitively transmitted 100 bursts for each set of programmed parameters recording temperature, voltage settings, and systematically selected frequencies. The power supply was cycled from minimum voltage 3.6 volts, to 4.1 and to 4.35 volts maximum voltage. The frequency error was measured at a maximum output power and recorded by the automated system test software.

The EUT output power and frequency was measured at 3.6 volts, 4.1 and 4.35 volts. The transmit frequency was varied in 3 steps consisting of 824.2, 836.4, and 848.8 MHz for the GSM850 band, 1850.2, 1880.0 and 1909.8 MHz for the PCS1900 band. This frequency was recorded in MHz and deviation from nominal, in Parts Per Million. After the initial one-hour soak at the beginning of the tests, a period of thirty minutes soak was initialized between each ascending temperature step, before proceeding to the next measurement test cycle.

	EMI Test Report for the BlackBerry® smartphone Model RFL111LW	
	<b>APPENDIX 1B</b>	
<b>Test Report No.:</b> RTS-6026-1302-12A_Rev1	<b>Dates of Test:</b> Nov. 22, 2012 to Mar. 04, 2013, and April 05, 2013	<b>FCC ID:</b> L6ARFL110LW, L6ARFP120LW <b>IC:</b> 2503A-RFL110LW, 2503A-RFP120LW


**Procedure:**

The test system software for commencing the Frequency Stability Tests carried through the following cycle.

1. Switch on the HP 6632B power supply; CMU 200 Communications test Set, and Environmental Chamber.
2. Start test program
3. Set the Temperature to –30°C and maintain a period of one- hour soak time, with the EUT supply voltage disabled.
4. Set power supply voltage to 3.6 volts.
5. Set up CMU 200 Radio Communication Tester.
6. Command the CMU 200 to switch to the low channel.
7. Enable the voltage to the EUT, and connect a link to the CMU 200 test set.
8. EUT is commanded to Transmit 100 Bursts.
9. Software logs the following data from the CMU 200, power supply and temperature chamber: Traffic Channel Number, Traffic Channel Frequency, Power Level, Chamber Temperature, Supply Voltage, Power and Frequency Error.
10. The CMU 200 commands the EUT to change frequency to the middle channel and high channel and repeats steps 7 to 9.
11. Repeat steps 5 to 10 changing the supply voltage to 4.1 Volts
12. Increase temperature by 10°C and soak for 1/2 hour.
13. Repeat steps 4 - 12 for temperatures –30°C to 60°C.
14. Repeat steps 5 to 10 changing the supply voltage to 4.35 volts

Procedure 5 to 10 was repeated at room temperature (20°C) with the power supply voltage set to 3.6, 4.1 and 4.35 volts.

The maximum frequency error in the GSM850 band measured was **-0.0330 PPM**.  
The maximum frequency error in the PCS1900 band measured was **0.0346PPM**.

	EMI Test Report for the BlackBerry® smartphone Model RFL111LW	
	<b>APPENDIX 1B</b>	
<b>Test Report No.:</b> RTS-6026-1302-12A_Rev1	<b>Dates of Test:</b> Nov. 22, 2012 to Mar. 04, 2013, and April 05, 2013	<b>FCC ID:</b> L6ARFL110LW, L6ARFP120LW <b>IC:</b> 2503A-RFL110LW, 2503A-RFP120LW

Date of Test: December 07, 2012

**GSM850 results: channels 128, 189 and 251 @ 20°C maximum transmitted power**

Traffic Channel Number	GSM850 Frequency (MHz)	Voltage (Volts)	Temperature (Celsius)	Frequency Error (Hz)	PPM
128	824.20	3.6	20	-5.37	-0.0065
189	836.40	3.6	20	-7.04	-0.0084
251	848.60	3.6	20	-7.49	-0.0088

Traffic Channel Number	GSM850 Frequency (MHz)	Voltage (Volts)	Temperature (Celsius)	Frequency Error (Hz)	PPM
128	824.20	4.1	20	-9.14	-0.0111
189	836.40	4.1	20	-10.35	-0.0124
251	848.60	4.1	20	-6.59	-0.0078

Traffic Channel Number	GSM850 Frequency (MHz)	Voltage (Volts)	Temperature (Celsius)	Frequency Error (Hz)	PPM
128	824.20	4.35	20	-13.55	-0.0164
189	836.40	4.35	20	-17.49	-0.0209
251	848.60	4.35	20	-14.63	-0.0172

<b>Test Report No.:</b> RTS-6026-1302-12A_Rev1	<b>Dates of Test:</b> Nov. 22, 2012 to Mar. 04, 2013, and April 05, 2013	<b>FCC ID:</b> L6ARFL110LW, L6ARFP120LW <b>IC:</b> 2503A-RFL110LW, 2503A-RFP120LW
---	--	--

**GSM850 Results: channel 128 @ maximum transmitted power**

Traffic Channel Number	Frequency (MHz)	Voltage (Volts)	Temperature (Celsius)	Frequency Error (Hz)	PPM
128	824.20	3.6	-30	-13.53	-0.0164
128	824.20	3.6	-20	6.05	0.0073
128	824.20	3.6	-10	12.37	0.0150
128	824.20	3.6	0	16.01	0.0194
128	824.20	3.6	10	-8.81	-0.0107
128	824.20	3.6	20	-5.37	-0.0065
128	824.20	3.6	30	-20.83	-0.0253
128	824.20	3.6	40	-14.37	-0.0174
128	824.20	3.6	50	-9.51	-0.0115
128	824.20	3.6	60	-11.24	-0.0136
Traffic Channel Number	Frequency (MHz)	Voltage (Volts)	Temperature (Celsius)	Frequency Error (Hz)	PPM
128	824.20	4.1	-30	-20.95	-0.0254
128	824.20	4.1	-20	-6.41	-0.0078
128	824.20	4.1	-10	11.45	0.0139
128	824.20	4.1	0	19.07	0.0231
128	824.20	4.1	10	-7.62	-0.0092
128	824.20	4.1	20	-9.14	-0.0111
128	824.20	4.1	30	-23.41	-0.0284
128	824.20	4.1	40	-13.21	-0.0160
128	824.20	4.1	50	-7.85	-0.0095
128	824.20	4.1	60	-7.53	-0.0091
Traffic Channel Number	Frequency (MHz)	Voltage (Volts)	Temperature (Celsius)	Frequency Error (Hz)	PPM
128	824.20	4.35	-30	-24.15	-0.0293
128	824.20	4.35	-20	-3.56	-0.0043
128	824.20	4.35	-10	12.18	0.0148
128	824.20	4.35	0	16.82	0.0204
128	824.20	4.35	10	-3.38	-0.0041
128	824.20	4.35	20	-13.55	-0.0164
128	824.20	4.35	30	-19.60	-0.0238
128	824.20	4.35	40	-8.40	-0.0102
128	824.20	4.35	50	10.44	0.0127
128	824.20	4.35	60	-7.60	-0.0092



Test Report No.:  
 RTS-6026-1302-12A\_Rev1

 Dates of Test:  
 Nov. 22, 2012 to Mar. 04, 2013,  
 and April 05, 2013

 FCC ID: L6ARFL110LW, L6ARFP120LW  
 IC: 2503A-RFL110LW, 2503A-RFP120LW

**GSM850 Results: channel 189 @ maximum transmitted power**

Traffic Channel Number	Frequency (MHz)	Voltage (Volts)	Temperature (Celsius)	Frequency Error (Hz)	PPM
189	836.40	3.6	-30	-15.12	-0.0181
189	836.40	3.6	-20	-4.34	-0.0052
189	836.40	3.6	-10	16.06	0.0192
189	836.40	3.6	0	14.66	0.0175
189	836.40	3.6	10	-7.61	-0.0091
189	836.40	3.6	20	-7.04	-0.0084
189	836.40	3.6	30	-21.50	-0.0257
189	836.40	3.6	40	-12.96	-0.0155
189	836.40	3.6	50	-11.01	-0.0132
189	836.40	3.6	60	-7.00	-0.0084
Traffic Channel Number	Frequency (MHz)	Voltage (Volts)	Temperature (Celsius)	Frequency Error (Hz)	PPM
189	836.40	4.1	-30	-22.67	-0.0271
189	836.40	4.1	-20	-10.90	-0.0130
189	836.40	4.1	-10	12.09	0.0145
189	836.40	4.1	0	18.25	0.0218
189	836.40	4.1	10	-9.10	-0.0109
189	836.40	4.1	20	-10.35	-0.0124
189	836.40	4.1	30	-25.39	-0.0304
189	836.40	4.1	40	-8.03	-0.0096
189	836.40	4.1	50	-10.04	-0.0120
189	836.40	4.1	60	-9.88	-0.0118
Traffic Channel Number	Frequency (MHz)	Voltage (Volts)	Temperature (Celsius)	Frequency Error (Hz)	PPM
189	836.40	4.35	-30	<b>-27.58</b>	<b>-0.0330</b>
189	836.40	4.35	-20	10.89	0.0130
189	836.40	4.35	-10	14.32	0.0171
189	836.40	4.35	0	8.08	0.0097
189	836.40	4.35	10	-6.91	-0.0083
189	836.40	4.35	20	-17.49	-0.0209
189	836.40	4.35	30	-23.15	-0.0277
189	836.40	4.35	40	-15.27	-0.0183
189	836.40	4.35	50	-7.47	-0.0089
189	836.40	4.35	60	-7.01	-0.0084


Test Report No.:  
 RTS-6026-1302-12A\_Rev1

Dates of Test:  
 Nov. 22, 2012 to Mar. 04, 2013,  
 and April 05, 2013

FCC ID: L6ARFL110LW, L6ARFP120LW  
 IC: 2503A-RFL110LW, 2503A-RFP120LW

**GSM850 Results: channel 251 @ maximum transmitted power**

Traffic Channel Number	Frequency (MHz)	Voltage (Volts)	Temperature (Celsius)	Frequency Error (Hz)	PPM
251	848.8	3.6	-30	-21.56	-0.0254
251	848.8	3.6	-20	-5.48	-0.0065
251	848.8	3.6	-10	16.77	0.0198
251	848.8	3.6	0	22.13	0.0261
251	848.8	3.6	10	-6.60	-0.0078
251	848.8	3.6	20	-7.49	-0.0088
251	848.8	3.6	30	-21.84	-0.0257
251	848.8	3.6	40	-10.74	-0.0127
251	848.8	3.6	50	5.93	0.0070
251	848.8	3.6	60	-7.35	-0.0087
Traffic Channel Number	Frequency (MHz)	Voltage (Volts)	Temperature (Celsius)	Frequency Error (Hz)	PPM
251	848.8	4.1	-30	-14.96	-0.0176
251	848.8	4.1	-20	-11.04	-0.0130
251	848.8	4.1	-10	12.78	0.0151
251	848.8	4.1	0	16.98	0.0200
251	848.8	4.1	10	-5.99	-0.0071
251	848.8	4.1	20	-6.59	-0.0078
251	848.8	4.1	30	-21.79	-0.0257
251	848.8	4.1	40	-6.34	-0.0075
251	848.8	4.1	50	-3.34	-0.0039
251	848.8	4.1	60	-6.89	-0.0081
Traffic Channel Number	Frequency (MHz)	Voltage (Volts)	Temperature (Celsius)	Frequency Error (Hz)	PPM
251	848.8	4.35	-30	-24.24	-0.0286
251	848.8	4.35	-20	10.57	0.0125
251	848.8	4.35	-10	12.14	0.0143
251	848.8	4.35	0	18.42	0.0217
251	848.8	4.35	10	-4.73	-0.0056
251	848.8	4.35	20	-14.63	-0.0172
251	848.8	4.35	30	-16.02	-0.0189
251	848.8	4.35	40	-10.43	-0.0123
251	848.8	4.35	50	-8.31	-0.0098
251	848.8	4.35	60	10.34	0.0122

	EMI Test Report for the BlackBerry® smartphone Model RFL111LW	
	<b>APPENDIX 1B</b>	
<b>Test Report No.:</b> RTS-6026-1302-12A_Rev1	<b>Dates of Test:</b> Nov. 22, 2012 to Mar. 04, 2013, and April 05, 2013	<b>FCC ID:</b> L6ARFL110LW, L6ARFP120LW <b>IC:</b> 2503A-RFL110LW, 2503A-RFP120LW

**PCS results: channels 512, 661, & 810 @ 20°C maximum transmitted power**

Traffic Channel Number	PCS Frequency (MHz)	Voltage (Volts)	Temperature (Celsius)	Frequency Error (Hz)	PPM
512	1850.20	3.6	20	35.71	0.0193
661	1880.00	3.6	20	30.41	0.0162
810	1909.80	3.6	20	29.96	0.0157

Traffic Channel Number	PCS Frequency (MHz)	Voltage (Volts)	Temperature (Celsius)	Frequency Error (Hz)	PPM
512	1850.20	4.1	20	27.31	0.0148
661	1880.00	4.1	20	28.41	0.0151
810	1909.80	4.1	20	28.73	0.0150

Traffic Channel Number	PCS Frequency (MHz)	Voltage (Volts)	Temperature (Celsius)	Frequency Error (Hz)	PPM
512	1850.20	4.35	20	27.31	0.0148
661	1880.00	4.35	20	26.28	0.0140
810	1909.80	4.35	20	23.76	0.0124

Test Report No.:  
 RTS-6026-1302-12A\_Rev1

Dates of Test:  
 Nov. 22, 2012 to Mar. 04, 2013,  
 and April 05, 2013

FCC ID: L6ARFL110LW, L6ARFP120LW  
 IC: 2503A-RFL110LW, 2503A-RFP120LW

**PCS1900 Results: channel 512 @ maximum transmitted power**

Traffic Channel Number	Frequency (MHz)	Voltage (Volts)	Temperature (Celsius)	Frequency Error (Hz)	PPM
512	1850.20	3.6	-30	-7.81	-0.0042
512	1850.20	3.6	-20	37.52	0.0203
512	1850.20	3.6	-10	45.52	0.0246
512	1850.20	3.6	0	62.63	0.0339
512	1850.20	3.6	10	36.03	0.0195
512	1850.20	3.6	20	35.71	0.0193
512	1850.20	3.6	30	9.17	0.0050
512	1850.20	3.6	40	23.37	0.0126
512	1850.20	3.6	50	23.37	0.0126
512	1850.20	3.6	60	22.57	0.0122
Traffic Channel Number	Frequency (MHz)	Voltage (Volts)	Temperature (Celsius)	Frequency Error (Hz)	PPM
512	1850.20	4.1	-30	-9.43	-0.0051
512	1850.20	4.1	-20	24.86	0.0134
512	1850.20	4.1	-10	40.49	0.0219
512	1850.20	4.1	0	54.89	0.0297
512	1850.20	4.1	10	36.55	0.0198
512	1850.20	4.1	20	27.31	0.0148
512	1850.20	4.1	30	-12.40	-0.0067
512	1850.20	4.1	40	16.14	0.0087
512	1850.20	4.1	50	16.14	0.0087
512	1850.20	4.1	60	28.41	0.0154
Traffic Channel Number	Frequency (MHz)	Voltage (Volts)	Temperature (Celsius)	Frequency Error (Hz)	PPM
512	1850.20	4.35	-30	17.69	0.0096
512	1850.20	4.35	-20	32.54	0.0176
512	1850.20	4.35	-10	36.42	0.0197
512	1850.20	4.35	0	58.37	0.0315
512	1850.20	4.35	10	38.48	0.0208
512	1850.20	4.35	20	27.31	0.0148
512	1850.20	4.35	30	-10.33	-0.0056
512	1850.20	4.35	40	17.43	0.0094
512	1850.20	4.35	50	17.43	0.0094
512	1850.20	4.35	60	17.43	0.0094

Test Report No.:  
 RTS-6026-1302-12A\_Rev1

Dates of Test:  
 Nov. 22, 2012 to Mar. 04, 2013,  
 and April 05, 2013

FCC ID: L6ARFL110LW, L6ARFP120LW  
 IC: 2503A-RFL110LW, 2503A-RFP120LW

**PCS1900 Results: channel 661 @ maximum transmitted power**


Traffic Channel Number	Frequency (MHz)	Voltage (Volts)	Temperature (Celsius)	Frequency Error (Hz)	PPM
661	1880.00	3.6	-30	-6.52	-0.0035
661	1880.00	3.6	-20	35.00	0.0186
661	1880.00	3.6	-10	46.30	0.0246
661	1880.00	3.6	0	65.54	0.0349
661	1880.00	3.6	10	40.81	0.0217
661	1880.00	3.6	20	30.41	0.0162
661	1880.00	3.6	30	6.07	0.0032
661	1880.00	3.6	40	24.02	0.0128
661	1880.00	3.6	50	24.02	0.0128
661	1880.00	3.6	60	14.82	0.0079
Traffic Channel Number	Frequency (MHz)	Voltage (Volts)	Temperature (Celsius)	Frequency Error (Hz)	PPM
661	1880.00	4.1	-30	-8.46	-0.0045
661	1880.00	4.1	-20	22.66	0.0121
661	1880.00	4.1	-10	35.64	0.0190
661	1880.00	4.1	0	56.82	0.0302
661	1880.00	4.1	10	38.61	0.0205
661	1880.00	4.1	20	28.41	0.0151
661	1880.00	4.1	30	-12.85	-0.0068
661	1880.00	4.1	40	24.73	0.0132
661	1880.00	4.1	50	24.73	0.0132
661	1880.00	4.1	60	22.63	0.0120
Traffic Channel Number	Frequency (MHz)	Voltage (Volts)	Temperature (Celsius)	Frequency Error (Hz)	PPM
661	1880.00	4.35	-30	20.02	0.0106
661	1880.00	4.35	-20	29.06	0.0155
661	1880.00	4.35	-10	41.97	0.0223
661	1880.00	4.35	0	57.73	0.0307
661	1880.00	4.35	10	37.58	0.0200
661	1880.00	4.35	20	26.28	0.0140
661	1880.00	4.35	30	-11.49	-0.0061
661	1880.00	4.35	40	16.01	0.0085
661	1880.00	4.35	50	16.01	0.0085
661	1880.00	4.35	60	21.36	0.0114

<b>Test Report No.:</b> RTS-6026-1302-12A_Rev1	<b>Dates of Test:</b> Nov. 22, 2012 to Mar. 04, 2013, and April 05, 2013	<b>FCC ID:</b> L6ARFL110LW, L6ARFP120LW <b>IC:</b> 2503A-RFL110LW, 2503A-RFP120LW
---	--	--

PCS1900 Results: channel 810 @ maximum transmitted power

Traffic Channel Number	Frequency (MHz)	Voltage (Volts)	Temperature (Celsius)	Frequency Error (Hz)	PPM
810	1909.80	3.6	-30	-7.81	-0.0041
810	1909.80	3.6	-20	33.38	0.0175
810	1909.80	3.6	-10	44.23	0.0232
810	1909.80	3.6	0	<b>65.99</b>	<b>0.0346</b>
810	1909.80	3.6	10	41.46	0.0217
810	1909.80	3.6	20	29.96	0.0157
810	1909.80	3.6	30	7.68	0.0040
810	1909.80	3.6	40	14.92	0.0078
810	1909.80	3.6	50	14.92	0.0078
810	1909.80	3.6	60	16.55	0.0087
Traffic Channel Number	Frequency (MHz)	Voltage (Volts)	Temperature (Celsius)	Frequency Error (Hz)	PPM
810	1909.80	4.1	-30	11.36	0.0059
810	1909.80	4.1	-20	27.44	0.0144
810	1909.80	4.1	-10	35.00	0.0183
810	1909.80	4.1	0	57.53	0.0301
810	1909.80	4.1	10	37.32	0.0195
810	1909.80	4.1	20	28.73	0.0150
810	1909.80	4.1	30	-6.39	-0.0033
810	1909.80	4.1	40	18.85	0.0099
810	1909.80	4.1	50	18.85	0.0099
810	1909.80	4.1	60	19.71	0.0103
Traffic Channel Number	Frequency (MHz)	Voltage (Volts)	Temperature (Celsius)	Frequency Error (Hz)	PPM
810	1909.80	4.35	-30	28.93	0.0151
810	1909.80	4.35	-20	31.64	0.0166
810	1909.80	4.35	-10	41.52	0.0217
810	1909.80	4.35	0	51.59	0.0270
810	1909.80	4.35	10	38.03	0.0199
810	1909.80	4.35	20	23.76	0.0124
810	1909.80	4.35	30	-14.33	-0.0075
810	1909.80	4.35	40	17.50	0.0092
810	1909.80	4.35	50	17.50	0.0092
810	1909.80	4.35	60	32.41	0.0170

## APPENDIX 1C – GSM RADIATED EMISSIONS TEST DATA

	EMI Test Report for the BlackBerry® smartphone Model RFL111LW, RFP121LW <b>APPENDIX 1C</b>	
<b>Test Report No.:</b> RTS-6026-1302-12A_Rev1	<b>Dates of Test:</b> Nov. 22, 2012 to Mar. 04, 2013, and April 05, 2013	<b>FCC ID:</b> L6ARFL110LW, L6ARFP120LW <b>IC:</b> 2503A-RFL110LW, 2503A-RFP120LW

### Radiated Power Test Data Results

The following measurements were performed on product RFL111LW.

Date of test: December 17, 2012

The following measurements were performed by Feras Obeid.

The environmental tests conditions were:     Temperature:            25.0 °C  
   Relative Humidity:        29.5 %

The EUT was standalone, horizontal with LCD facing up and top pointing to RX antenna when the turntable is at 0 degree position.

Test Distance was 3.0 meters with the RX antenna height scans between 1-4 meters height.


### GSM850 Band Call Mode

EUT				Rx Antenna		Spectrum Analyzer		Substitution Method				Limit (dBm)	Diff. To Limit (dB)
Type	Ch	Frequency (MHz)	Band	Type	Pol.	Reading (dBuV)	Max (V,H) (dBuV)	Pol. Tx-Rx	Reading (dBm)	Corrected Reading (relative to Dipole)			
										(dBm)	(W)		
F0	128	824.20	850	Dipole	V	77.82	87.62	V-V	14.95	32.08	1.61	38.50	-6.42
F0	128	824.20	850	Dipole	H	87.62		H-H	13.60				
F0	190	836.60	850	Dipole	V	76.92	87.38	V-V	15.50	32.30	1.70	38.50	-6.20
F0	190	836.60	850	Dipole	H	87.38		H-H	14.28				
F0	251	848.80	850	Dipole	V	77.19	86.05	V-V	15.28	32.06	1.61	38.50	-6.44
F0	251	848.80	850	Dipole	H	86.05		H-H	15.09				

### GSM850 Band EDGE Mode

EUT				Rx Antenna		Spectrum Analyzer		Substitution Method				Limit (dBm)	Diff. To Limit (dB)
Type	Ch	Frequency (MHz)	Band	Type	Pol.	Reading (dBuV)	Max (V,H) (dBuV)	Pol. Tx-Rx	Reading (dBm)	Corrected Reading (relative to Dipole)			
										(dBm)	(W)		
F0	128	824.20	850	Dipole	V	74.63	84.24	V-V	11.65	28.78	0.76	38.50	-9.72
F0	128	824.20	850	Dipole	H	84.24		H-H	10.28				
F0	190	836.60	850	Dipole	V	73.89	84.00	V-V	12.22	<b>29.02</b>	<b>0.80</b>	38.50	-9.48
F0	190	836.60	850	Dipole	H	84.00		H-H	10.94				
F0	251	848.80	850	Dipole	V	73.91	82.73	V-V	11.89	28.67	0.74	38.50	-9.83
F0	251	848.80	850	Dipole	H	82.73		H-H	11.74				



	EMI Test Report for the BlackBerry® smartphone Model RFL111LW, RFP121LW <b>APPENDIX 1C</b>	
	<b>Test Report No.:</b> RTS-6026-1302-12A_Rev1	<b>Dates of Test:</b> Nov. 22, 2012 to Mar. 04, 2013, and April 05, 2013

### Radiated Emissions Test Data Results cont'd

Date of test: January 31, 2013

The following measurements were performed by Mahmood Ahmed.

The environmental tests conditions were: Temperature: 25.7 °C

Relative Humidity: 21.7 %

The EUT was standalone, horizontal with LCD down and head pointing to RX antenna when the turntable is at 0 degree position.

Test Distance was 3.0 meters with the RX antenna height scans between 1-4 meters height.


### **PCS1900 Band Call Mode**

EUT								Rx Antenna		Spectrum Analyzer		Substitution Method		Tracking Generator		Limit (dBm)	Diff to Limit (dB)
Type	Ch	Frequency (MHz)	Band	Type	Pol.	Reading (dBuV)	Max (V,H) dBuV	Pol. Tx-Rx	Reading (dBm)	Corrected Reading (relative to Isotropic Radiator)		Limit (dBm)	Diff to Limit (dB)				
										(dBm)	(W)						
F0	512	1850.20	1900	Horn	V	87.61	90.95	V-V	-3	32.49	1.77	33.00	-0.51				
F0	512	1850.20	1900	Horn	H	90.95		H-H	-2.32								
F0	661	1880.00	1900	Horn	V	86.82	89.79	V-V	-3.16	32.12	1.63	33.00	-0.88				
F0	661	1880.00	1900	Horn	H	89.79		H-H	-2.78								
F0	810	1909.80	1900	Horn	V	86.28	89.99	V-V	-1.46	<b>32.55</b>	<b>1.80</b>	33.00	-0.45				
F0	810	1909.80	1900	Horn	H	89.99		H-H	-1.4								

### **PCS1900 Band EDGE Mode**

EUT								Rx Antenna		Spectrum Analyzer		Substitution Method		Tracking Generator		Limit (dBm)	Diff to Limit (dB)
Type	Ch	Frequency (MHz)	Band	Type	Pol.	Reading (dBuV)	Max (V,H) dBuV	Pol. Tx-Rx	Reading (dBm)	Corrected Reading (relative to Isotropic Radiator)		Limit (dBm)	Diff to Limit (dB)				
										(dBm)	(W)						
F0	512	1850.20	1900	Horn	V	86.93	89.9	V-V	-4.2	31.46	1.40	33.00	-1.54				
F0	512	1850.20	1900	Horn	H	89.9		H-H	-3.35								
F0	661	1880.00	1900	Horn	V	86.45	89.45	V-V	-3.45	<b>31.88</b>	<b>1.54</b>	33.00	-1.12				
F0	661	1880.00	1900	Horn	H	89.45		H-H	-3.02								
F0	810	1909.80	1900	Horn	V	85.74	88.75	V-V	-2.64	31.32	1.36	33.00	-1.68				
F0	810	1909.80	1900	Horn	H	88.75		H-H	-2.63								

This report shall **NOT** be reproduced except in full without the written consent of RIM Testing Services  
- A division of Research in Motion Limited.

	EMI Test Report for the BlackBerry® smartphone Model RFL111LW, RFP121LW <b>APPENDIX 1C</b>	
	<b>Test Report No.:</b> RTS-6026-1302-12A_Rev1	<b>Dates of Test:</b> Nov. 22, 2012 to Mar. 04, 2013, and April 05, 2013

Radiated Emissions Test Data Results cont'd

**GSM850 Call Mode**

Date of Test: December 04, 2012 – February 01, 2013

The following measurements were performed by Savtej Sandhu.

The environmental test conditions were: Temperature: 23.7 – 25.5 °C

Relative Humidity: 19.7 – 29.7 %

Test Distance was 3.0 meters with the RX antenna height scans between 1-4 meters height, and a frequency range of 30 MHz to 1000 MHz.

The EUT was standalone, horizontal with LCD facing up and top pointing to the RX antenna when the turntable is at 0 degree position.

Measurements were performed in GSM850 CALL mode, channels 128, 190, 251.

All emissions were at least 25.0 dB below the limit line.

Date of Test: December 04, 2012 – February 01, 2013

The following measurements were performed by Mahmood Ahmed

The environmental test conditions were: Temperature: 23.7 – 25.5 °C


Relative Humidity: 19.7 – 29.7 %

Test Distance was 3.0 meters with the RX antenna height scans between 1-4 meters height, and a frequency range of 1 GHz to 9 GHz.

The EUT was standalone, with USB port pointing up and LCD facing to the RX antenna when the turntable is at 0 degree position.

The measurements were performed in GSM850 CALL mode, channels 128, 190, 251.

All emissions were at least 25.0 dB below the limit line.

	EMI Test Report for the BlackBerry® smartphone Model RFL111LW, RFP121LW <b>APPENDIX 1C</b>	
<b>Test Report No.:</b> RTS-6026-1302-12A_Rev1	<b>Dates of Test:</b> Nov. 22, 2012 to Mar. 04, 2013, and April 05, 2013	<b>FCC ID:</b> L6ARFL110LW, L6ARFP120LW <b>IC:</b> 2503A-RFL110LW, 2503A-RFP120LW

Radiated Emissions Test Data Results (cont'd)

**GSM850 EDGE Mode**

Date of Test: December 04, 2012 – February 01, 2013

The following measurements were performed by Savtej Sandhu.

The environmental test conditions were: Temperature: 23.7 – 25.5 °C

Relative Humidity: 19.7 – 29.7 %

Test Distance was 3.0 meters with the RX antenna height scans between 1-4 meters height, and a frequency range of 30 MHz to 1000 MHz.

The EUT was standalone, horizontal with LCD facing up and top pointing to the RX antenna when the turntable is at 0 degree position.

Measurements were performed in GSM850 EDGE mode, channels 128, 190, 251.

All emissions were at least 25.0 dB below the limit line.

Date of Test: December 04, 2012 – February 01, 2013

The following measurements were performed by Shuo Wang

The environmental test conditions were: Temperature: 23.7 – 25.5 °C


Relative Humidity: 19.7 – 29.7 %

Test Distance was 3.0 meters with the RX antenna height scans between 1-4 meters height, and a frequency range of 1 GHz to 9 GHz.

The EUT was standalone, with USB port pointing up and LCD facing to the RX antenna when the turntable is at 0 degree position.

The measurements were performed in GSM850 EDGE mode, channels 128, 190, 251.

All emissions were at least 25.0 dB below the limit line.

	EMI Test Report for the BlackBerry® smartphone Model RFL111LW, RFP121LW <b>APPENDIX 1C</b>	
	<b>Test Report No.:</b> RTS-6026-1302-12A_Rev1	<b>Dates of Test:</b> Nov. 22, 2012 to Mar. 04, 2013, and April 05, 2013

Radiated Emissions Test Data Results (cont'd)

**PCS1900 CALL Mode**

Date of Test: December 04, 2012 – February 01, 2013

The environmental test conditions were: Temperature: 23.7 – 25.5 °C  
Relative Humidity: 19.7 – 29.7 %

Test Distance was 3.0 meters with the RX antenna height scans between 1-4 meters height, and a frequency range of 30 MHz to 1000 MHz.

The EUT was standalone, horizontal with LCD facing down and top pointing to the RX antenna when the turntable is at 0 degree position.

Measurements were performed in PCS1900 Call Tx mode, channels 512, 661, 810. All emissions were at least 25.0 dB below the limit line.

Date of Test: December 04, 2012 – February 01, 2013

The environmental test conditions were: Temperature: 23.7 – 25.5 °C  
Relative Humidity: 19.7 – 29.7 %


Test Distance was 3.0 meters with the RX antenna height scans between 1-4 meters height, and a frequency range of 1 GHz to 20 GHz.

The EUT was standalone, vertically with LCD facing to the RX antenna when the turntable is at 0 degree position.

Measurements were performed in PCS1900 Call Tx mode, channels 512, 661, 810.

Frequency (MHz)	Channel Of Occurrence	Antenna		Test Angle (Deg.)	Detector (PK or QP)	Measured Level (dBµV)	Correction Factor for preamp/antenna/ cables/ filter (dB)	Field Strength Level (reading+corr) (dBm)	Limit @ 3.0 m (dBm)	Test Margin (dB)
		Pol. (V/H)	Height (meters)							
3819.568	810	H	2.08	142	PK	50.70	-81.35	-30.641	-13.00	<b>-17.6</b>

All other emissions were at least 25.0 dB below the limit line.

	EMI Test Report for the BlackBerry® smartphone Model RFL111LW, RFP121LW <b>APPENDIX 1C</b>	
	<b>Test Report No.:</b> RTS-6026-1302-12A_Rev1	<b>Dates of Test:</b> Nov. 22, 2012 to Mar. 04, 2013, and April 05, 2013

### Radiated Emissions Test Data Results (cont'd)

#### **PCS1900 EDGE Mode**

Date of Test: December 04, 2012 – February 01, 2013

The environmental test conditions were: Temperature: 23.7 – 25.5 °C  
Relative Humidity: 19.7 – 29.7 %

Test Distance was 3.0 meters with the RX antenna height scans between 1-4 meters height, and a frequency range of 30 MHz to 1000 MHz.

The EUT was standalone, horizontal with LCD facing down and top pointing to the RX antenna when the turntable is at 0 degree position.

Measurements were performed in PCS1900 EDGE Tx mode, channels 512, 661, 810. All emissions were at least 25.0 dB below the limit line.

Date of Test: December 04, 2012 – February 01, 2013

The environmental test conditions were: Temperature: 23.7 – 25.5 °C  
Relative Humidity: 19.7 – 29.7 %

Test Distance was 3.0 meters with the RX antenna height scans between 1-4 meters height, and a frequency range of 1 GHz to 20 GHz.

The EUT was standalone, vertically with LCD facing to the RX antenna when the turntable is at 0 degree position.


Measurements were performed in PCS1900 EDGE Tx mode, channels 512, 661, 810.

Frequency (MHz)	Channel Of Occurrence	Antenna		Test Angle (Deg.)	Detector (PK or QP)	Measured Level (dBμV)	Correction Factor for preamp/antenna/ cables/ filter (dB)	Field Strength Level (reading+corr) (dBm)	Limit @ 3.0 m (dBm)	Test Margin (dB)
		Pol. (V/H)	Height (meters)							
5550.476	512	H	1.30	0	PK	46.97	-72.77	-25.81	-13.00	<b>-12.8</b>

All other emissions were at least 25.0 dB below the limit line.





	EMI Test Report for the BlackBerry® smartphone Model RFL111LW, RFP121LW <b>APPENDIX 1C</b>	
	<b>Test Report No.:</b> RTS-6026-1302-12A_Rev1	<b>Dates of Test:</b> Nov. 22, 2012 to Mar. 04, 2013, and April 05, 2013

Radiated Emissions Test Data Results cont'd

**GSM850 Call Mode**

Date of Test: January 30, 2013

The following measurements were performed by Savtej Sandhu.

The environmental test conditions were: Temperature: 24.6 °C

Relative Humidity: 21.2 %

Test Distance was 3.0 meters with the RX antenna height scans between 1-4 meters height, and a frequency range of 30 MHz to 1000 MHz.

The EUT was standalone, with USB jack pointing down and LCD facing to RX antenna when the turntable is at 0 degree position.

Measurements were performed in GSM850 CALL mode, channels 190.

All emissions were at least 25.0 dB below the limit line.

Date of Test: January 28, 2013 – February 02, 2013

The following measurements were performed by Mahmood Ahmed

The environmental test conditions were: Temperature: 23.7 – 26.0 °C

Relative Humidity: 19.7 – 38.8 %

Test Distance was 3.0 meters with the RX antenna height scans between 1-4 meters height, and a frequency range of 1 GHz to 9 GHz.


The EUT was standalone, with USB port pointing down and LCD facing to the RX antenna when the turntable is at 0 degree position.

The measurements were performed in GSM850 CALL mode, channels 190.

Frequency (MHz)	Channel Of Occurrence	Antenna		Test Angle (Deg.)	Detector (PK or QP)	Measured Level (dBµV)	Correction Factor for preamp/antenna/ cables/ filter (dB)	Field Strength Level (reading+corr) (dBm)	Limit @ 3.0 m (dBm)	Test Margin (dB)
		Pol. (V/H)	Height (meters)							
1673.068	190	V	1.41	290	PK	56.78	-81.35	-34.848	-13.00	-21.8
2510.008	190	V	1.00	118	PK	51.37	-86.04	<b>-34.67</b>	-13.00	<b>-21.7</b>

All other emissions were at least 25.0 dB below the limit line.



	EMI Test Report for the BlackBerry® smartphone Model RFL111LW, RFP121LW	
	<b>APPENDIX 1C</b>	
<b>Test Report No.:</b> RTS-6026-1302-12A_Rev1	<b>Dates of Test:</b> Nov. 22, 2012 to Mar. 04, 2013, and April 05, 2013	<b>FCC ID:</b> L6ARFL110LW, L6ARFP120LW <b>IC:</b> 2503A-RFL110LW, 2503A-RFP120LW

Radiated Emissions Test Data Results cont'd

**GSM850 EDGE Mode**

Date of Test: December 04, 2012 – February 01, 2013

The environmental test conditions were: Temperature: 23.7 – 25.5 °C  
Relative Humidity: 19.7 – 29.7 %

Test Distance was 3.0 meters with the RX antenna height scans between 1-4 meters height, and a frequency range of 30 MHz to 1000 MHz.

The EUT was standalone, with USB port pointing down and LCD facing to the RX antenna when the turntable is at 0 degree position.

Measurements were performed in GSM850 EDGE mode, channels 190.  
All emissions were at least 25.0 dB below the limit line.

Date of Test: December 04, 2012 – February 02, 2013


The environmental test conditions were: Temperature: 23.7 – 25.5 °C  
Relative Humidity: 19.7 – 29.7 %

Test Distance was 3.0 meters with the RX antenna height scans between 1-4 meters height, and a frequency range of 1 GHz to 9 GHz.

The EUT was standalone, with USB port pointing down and LCD facing to the RX antenna when the turntable is at 0 degree position.

The measurements were performed in GSM850 EDGE mode, channels 190.

All emissions were at least 25.0 dB below the limit line.

	EMI Test Report for the BlackBerry® smartphone Model RFL111LW, RFP121LW <b>APPENDIX 1C</b>	
<b>Test Report No.:</b> RTS-6026-1302-12A_Rev1	<b>Dates of Test:</b> Nov. 22, 2012 to Mar. 04, 2013, and April 05, 2013	<b>FCC ID:</b> L6ARFL110LW, L6ARFP120LW <b>IC:</b> 2503A-RFL110LW, 2503A-RFP120LW

Radiated Emissions Test Data Results cont'd

**PCS1900 CALL Mode**

Date of Test: December 04, 2012 – February 01, 2013

The environmental test conditions were: Temperature: 23.7 – 25.5 °C  
Relative Humidity: 19.7 – 29.7 %

Test Distance was 3.0 meters with the RX antenna height scans between 1-4 meters height, and a frequency range of 30 MHz to 1000 MHz.

The EUT was standalone, horizontally with LCD facing down and the top pointing to the RX antenna when the turntable is at 0 degree position.

Measurements were performed in PCS1900 Call Tx mode, channels 661.  
All emissions were at least 25.0 dB below the limit line.

Date of Test: December 04, 2012 – February 04, 2013


The environmental test conditions were: Temperature: 23.7 – 25.5 °C  
Relative Humidity: 19.7 – 29.7 %

Test Distance was 3.0 meters with the RX antenna height scans between 1-4 meters height, and a frequency range of 1 GHz to 20 GHz.

The EUT was standalone, horizontally with LCD facing down and the top pointing to the RX antenna when the turntable is at 0 degree position.

Measurements were performed in PCS1900 Call Tx mode, channels 661.

All other emissions were at least 25.0 dB below the limit line.

	EMI Test Report for the BlackBerry® smartphone Model RFL111LW, RFP121LW	
	<b>APPENDIX 1C</b>	
<b>Test Report No.:</b> RTS-6026-1302-12A_Rev1	<b>Dates of Test:</b> Nov. 22, 2012 to Mar. 04, 2013, and April 05, 2013	<b>FCC ID:</b> L6ARFL110LW, L6ARFP120LW <b>IC:</b> 2503A-RFL110LW, 2503A-RFP120LW

Radiated Emissions Test Data Results cont'd

**PCS1900 EDGE Mode**

Date of Test: December 04, 2012 – February 01, 2013

The environmental test conditions were: Temperature: 23.7 – 25.5 °C  
Relative Humidity: 19.7 – 29.7 %

Test Distance was 3.0 meters with the RX antenna height scans between 1-4 meters height, and a frequency range of 30 MHz to 1000 MHz.

The EUT was standalone, horizontally with LCD facing down and the top pointing to the RX antenna when the turntable is at 0 degree position.

Measurements were performed in PCS1900 EDGE Tx mode, channels 661.  
All emissions were at least 25.0 dB below the limit line.

Date of Test: December 04, 2012 – February 04, 2013

The environmental test conditions were: Temperature: 23.7 – 25.5 °C  
Relative Humidity: 19.7 – 29.7 %

Test Distance was 3.0 meters with the RX antenna height scans between 1-4 meters height, and a frequency range of 1 GHz to 20 GHz.

The EUT was standalone, vertically with LCD facing to the RX antenna when the turntable is at 0 degree position.

Measurements were performed in PCS1900 EDGE Tx mode, channels 661.

All emissions were at least 25.0 dB below the limit line.

APPENDIX 2A– WCDMA Band 2/4/5 CONDUCTED RF EMISSIONS TEST DATA/PLOTS

**Test Report No.:**  
RTS-6026-1302-12A\_Rev1

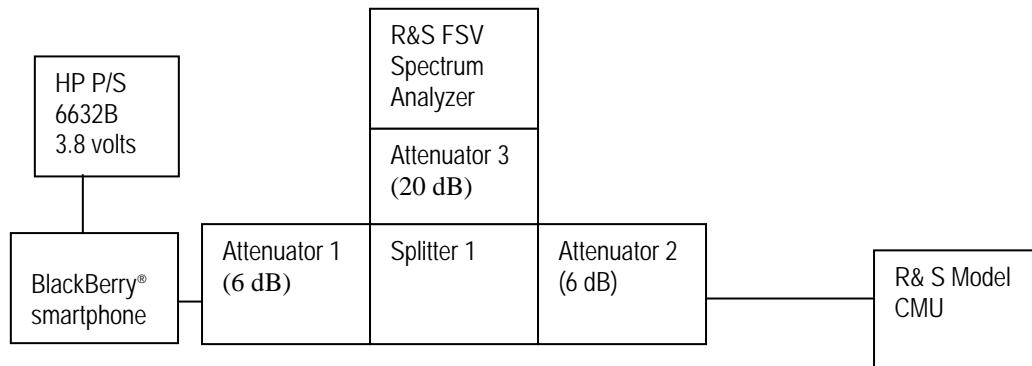
**Dates of Test:**  
Nov. 22, 2012 to Mar. 04, 2013,  
and April 05, 2013

**FCC ID:** L6ARFL110LW, L6ARFP120LW  
**IC:** 2503A-RFL110LW, 2503A-RFP120LW

WCDMA BAND 2/4/5 Conducted RF Emission Test Data

This appendix contains measurement data pertaining to conducted spurious emissions, 99% power bandwidth and the channel mask.

**Test Setup Diagram**




A reference offset of 31.4 dB was applied to the spectrum analyzer reference level for the attenuators and coaxial cable loss in the test circuit.

UNIT	MANUFACTURER	MODEL	SERIAL NUMBER
Attenuator 1	Mini-Circuits	BW-S6W2+	0647
Attenuator 2	Mini-Circuits	BW-S6W2+	0648
Attenuator 3	Mini-Circuits	BW-S20-2W263+	1234
Splitter 1	Weinschel	1515	MES 92

Date of Test: December 10-11, 2012 and February 19-25, 2013

The environmental test conditions were: Temperature: 22.4 – 23.3°C  
Relative Humidity: 21.3 – 28.9 %

The following measurements were performed by Berkin Can.

	EMI Test Report for the BlackBerry® smartphone Model RFL111LW, RFP121LW <b>APPENDIX 2A</b>	
	<b>Test Report No.:</b> RTS-6026-1302-12A_Rev1	<b>Dates of Test:</b> Nov. 22, 2012 to Mar. 04, 2013, and April 05, 2013

### WCDMA Conducted RF Emission Test Data cont'd

**The conducted spurious emissions** – As per 47 CFR 2.1051, CFR 22.917, CFR 24.238(a), RSS-132, 5.5 and RSS – 133, 6.5 were measured from 30 MHz to 20 GHz.

#### **–26 dBc Bandwidth and Occupied Bandwidth (99%)**

For each carrier frequency of low, middle and high, the modulation spectrum was measured by both methods of 99% power bandwidth and –26 dBc bandwidth.

The resolution bandwidth required for out-of-band emissions in the 1 MHz bands immediately outside and adjacent to the frequency block, was determined to be at least 1% of the emission bandwidth.

The worst case –26dBc bandwidth for WCDMA Band 5 was measured to be 4.602 MHz, for WCDMA Band 2 was measured to be 4.595 MHz, and for the WCDMA Band 4 was measured to be 4.588 MHz as shown below. Results were derived in a 100 kHz resolution bandwidth.

On any frequency outside the frequency block and outside the adjacent 1 MHz bands, a resolution bandwidth of at least 1 MHz was applied.

#### **Test Data for WCDMA Band 2/4/5 selected Frequencies in Voice mode**


The following measurements were performed on product RFL111LW.

WCDMA Band 5 Frequency (MHz)	26dBc Occupied Bandwidth (MHz)	99% Occupied Bandwidth (MHz)
826.4	4.602	4.146
836.4	4.580	4.146
846.6	4.588	4.161

WCDMA Band 2 Frequency (MHz)	26dBc Occupied Bandwidth (MHz)	99% Occupied Bandwidth (MHz)
1852.4	4.566	4.153
1880.0	4.595	4.161
1907.6	4.580	4.153

The following measurements were performed on product RFP121LW.

WCDMA Band 4 Frequency (MHz)	26dBc Occupied Bandwidth (MHz)	99% Occupied Bandwidth (MHz)
1712.4	4.588	4.161
1732.6	4.566	4.161
1752.6	4.588	4.153

	EMI Test Report for the BlackBerry® smartphone Model RFL111LW, RFP121LW <b>APPENDIX 2A</b>	
<b>Test Report No.:</b> RTS-6026-1302-12A_Rev1	<b>Dates of Test:</b> Nov. 22, 2012 to Mar. 04, 2013, and April 05, 2013	<b>FCC ID:</b> L6ARFL110LW, L6ARFP120LW <b>IC:</b> 2503A-RFL110LW, 2503A-RFP120LW

### Peak to Average Ratio (PAR)

The peak to average ratio was measured on the low, middle and high channels. On any frequency outside the frequency block and outside the adjacent 1 MHz bands, a resolution bandwidth of at least 1 MHz was applied.

The worst case measured was 3.72 dB on low channel of WCDMA Band 2.

The worst case measured was 3.55 dB on low and high channels of WCDMA Band 4.

### **Measurement Plots for WCDMA Band 5 and WCDMA Band 2 in Voice mode**

Refer to the following measurement plots for more detail:

The measurement plots on product RFL111LW:

See Figures 2-1a to 2-12a for the plots of the conducted spurious emissions.

See Figures 2-13a to 2-24a for the plots of 99% Occupied Bandwidth and -26 dBc Bandwidth.

See Figures 2-25a to 2-28a for the plots of the Channel mask.

See figures 2-29a to 2-31a for the plots of the Peak to Average Ratio (WCDMA Band 2).

The measurement plots on product RFP121LW:

See Figures 2-1b to 2-6b for the plots of the conducted spurious emissions.

See Figures 2-7b to 2-12b for the plots of 99% Occupied Bandwidth and -26 dBc Bandwidth.

See Figures 2-13b to 2-14b for the plots of the Channel mask.

See figures 2-15a to 2-17a for the plots of the Peak to Average Ratio (WCDMA Band 4).

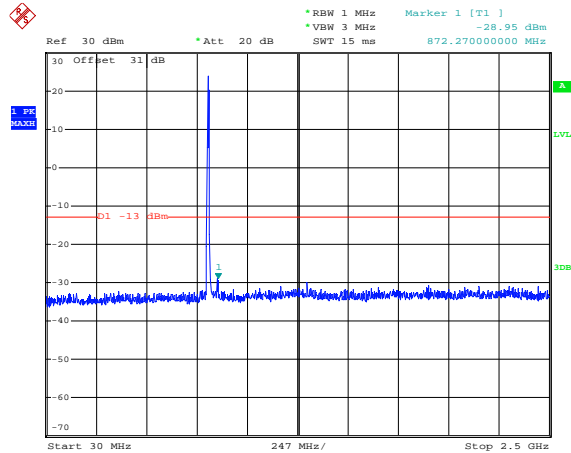
**Test Report No.:**  
 RTS-6026-1302-12A\_Rev1

**Dates of Test:**  
 Nov. 22, 2012 to Mar. 04, 2013,  
 and April 05, 2013

**FCC ID:** L6ARFL110LW, L6ARFP120LW  
**IC:** 2503A-RFL110LW, 2503A-RFP120LW

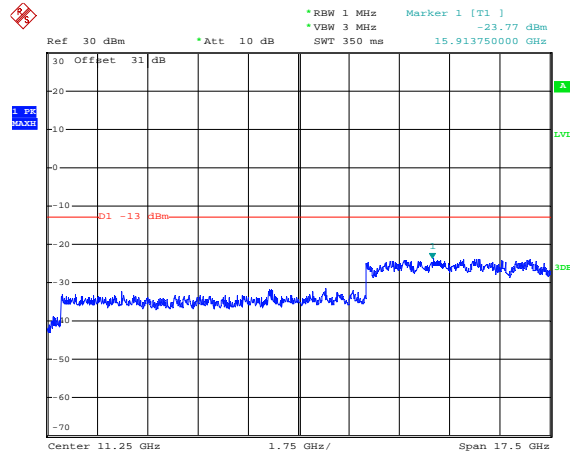
**WCDMA Conducted RF Emission Test Data cont'd**

**Figure 2-1a: Band 5, Spurious Conducted Emissions, Low channel**



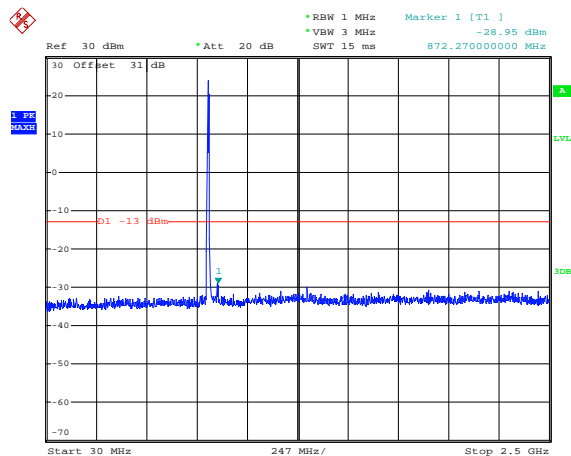
Date: 10.DEC.2012 16:20:45

**Figure 2-2a: Band 5, Spurious Conducted Emissions, Low channel**



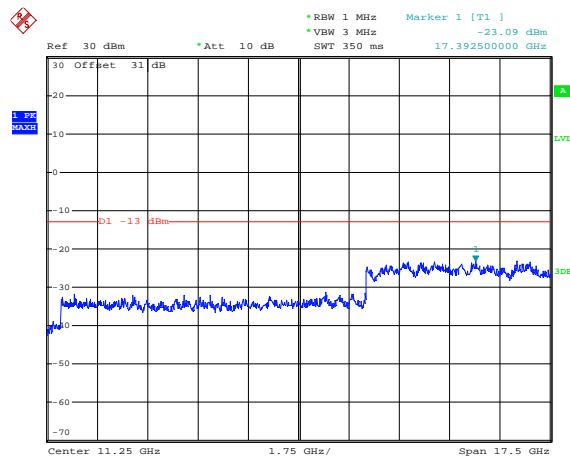
Date: 10.DEC.2012 16:29:53

**Figure 2-3a: Band 5, Spurious Conducted Emissions, Middle channel**




Date: 10.DEC.2012 16:20:45

**Figure 2-4a: Band 5, Spurious Conducted Emissions, Middle channel**



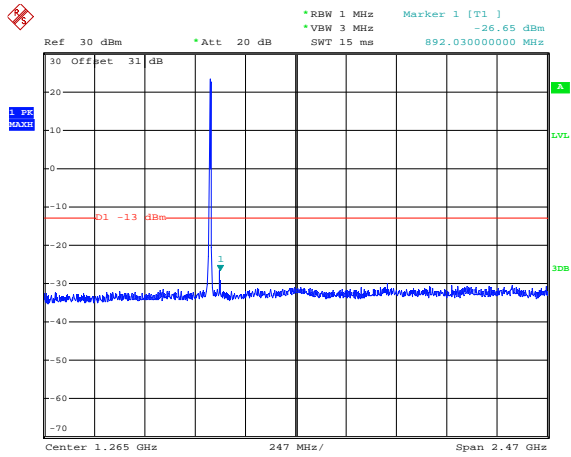
Date: 10.DEC.2012 16:29:10



	EMI Test Report for the BlackBerry® smartphone Model RFL111LW, RFP121LW <b>APPENDIX 2A</b>	
	<b>Test Report No.:</b> RTS-6026-1302-12A_Rev1	<b>Dates of Test:</b> Nov. 22, 2012 to Mar. 04, 2013, and April 05, 2013

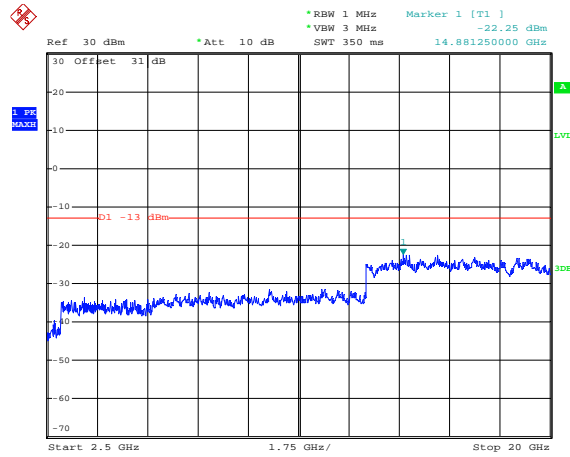
WCDMA Conducted RF Emission Test Data cont'd

**Figure 2-5a: Band 5, Spurious Conducted Emissions, High Channel**



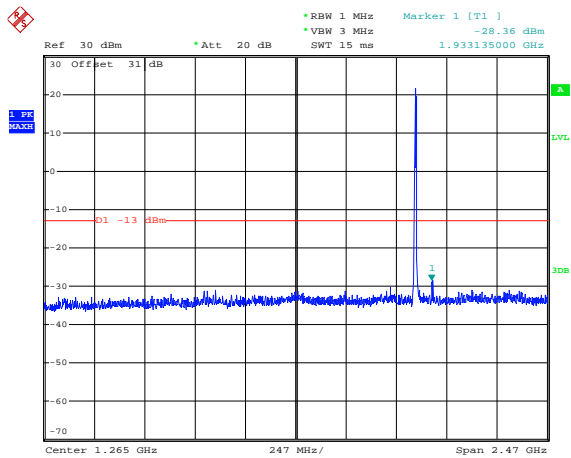
Date: 10.DEC.2012 16:25:34

**Figure 2-6a: Band 5, Spurious Conducted Emissions, High Channel**



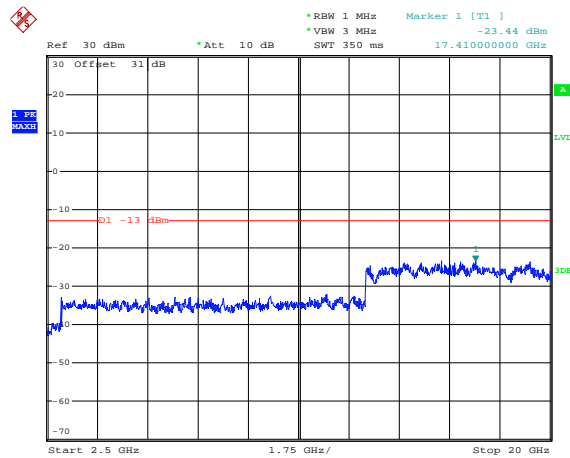
Date: 10.DEC.2012 16:27:29

**Figure 2-2a: BAND 2 Spurious Conducted Emissions, Low Channel**



Date: 11.DEC.2012 10:59:24

**Figure 2-8a: BAND 2, Spurious Conducted Emissions, Low Channel**



Date: 11.DEC.2012 10:48:18

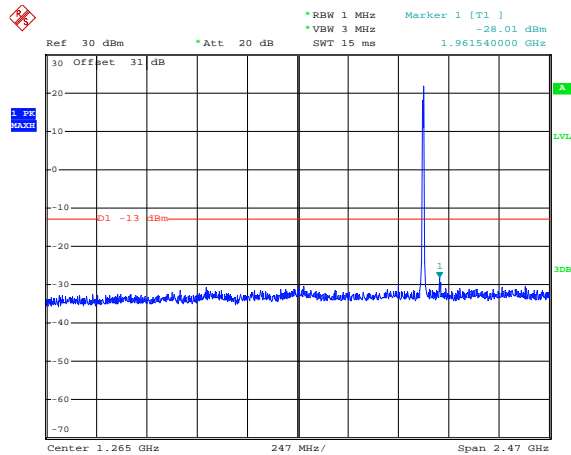
**Test Report No.:**  
 RTS-6026-1302-12A\_Rev1

**Dates of Test:**  
 Nov. 22, 2012 to Mar. 04, 2013,  
 and April 05, 2013

**FCC ID:** L6ARFL110LW, L6ARFP120LW  
**IC:** 2503A-RFL110LW, 2503A-RFP120LW

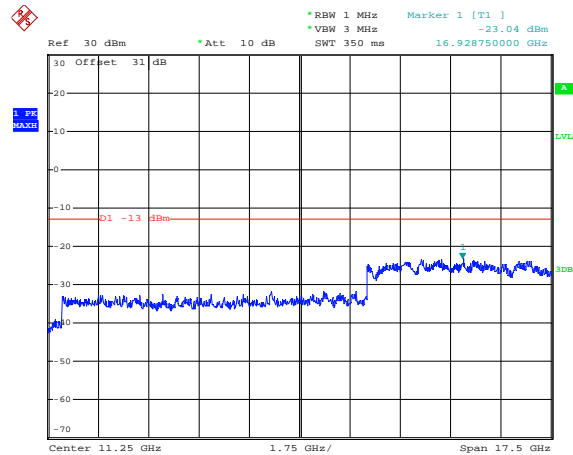
**WCDMA Conducted RF Emission Test Data cont'd**

**Figure 2-9a: BAND 2, Spurious Conducted Emissions, Middle Channel**



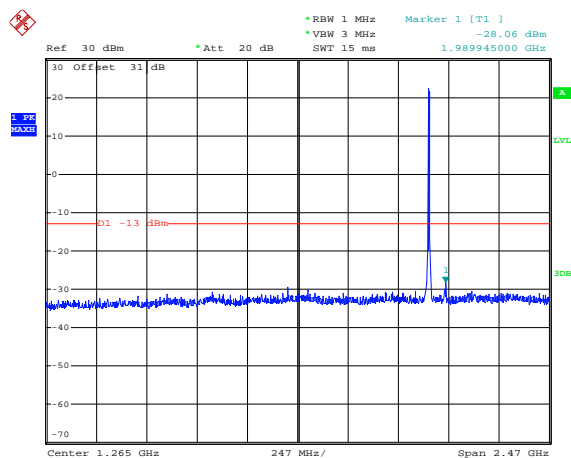
Date: 11.DEC.2012 10:56:28

**Figure 2-10a: BAND 2, Spurious Conducted Emissions, Middle Channel**



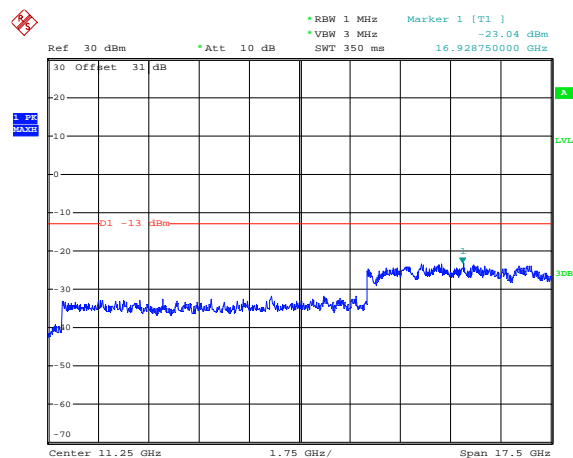
Date: 11.DEC.2012 10:49:32

**Figure 2-11a: BAND 2, Spurious Conducted Emissions, High Channel**



Date: 11.DEC.2012 10:55:17

**Figure 2-12a: BAND 2, Spurious Conducted Emissions, High Channel**



Date: 11.DEC.2012 10:49:32

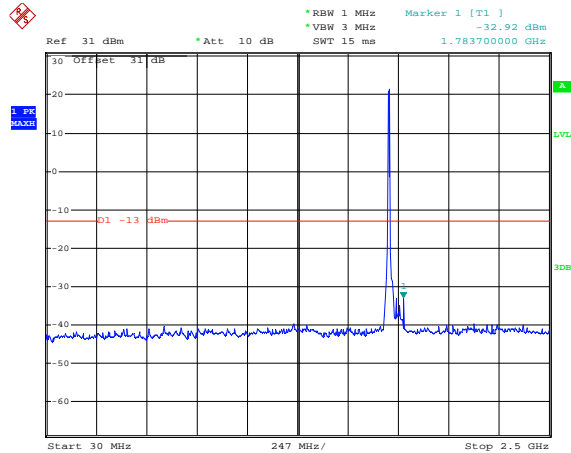
**Test Report No.:**  
 RTS-6026-1302-12A\_Rev1

**Dates of Test:**  
 Nov. 22, 2012 to Mar. 04, 2013,  
 and April 05, 2013

**FCC ID:** L6ARFL110LW, L6ARFP120LW  
**IC:** 2503A-RFL110LW, 2503A-RFP120LW

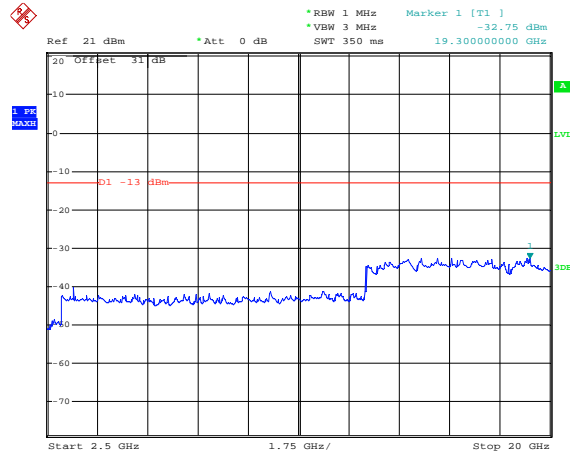
WCDMA Conducted RF Emission Test Data cont'd

**Figure 2-1b: Band 4, Spurious Conducted Emissions, Low channel**



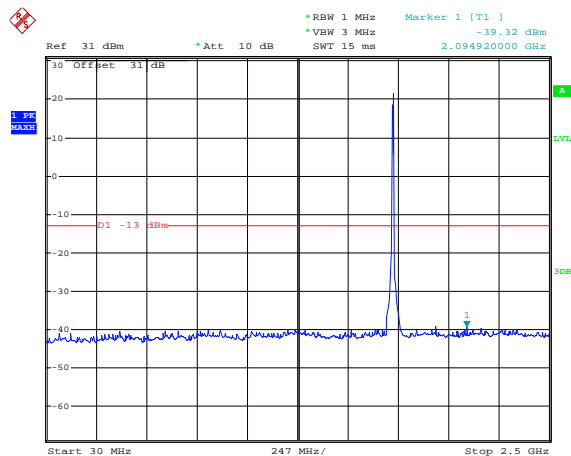
Date: 22.FEB.2013 16:01:41

**Figure 2-2b: Band 4, Spurious Conducted Emissions, Low channel**



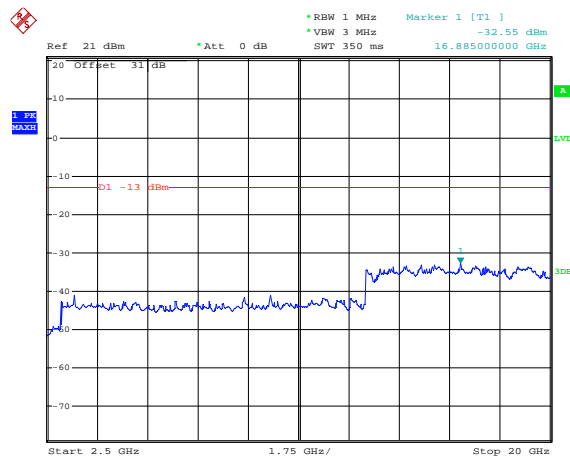
Date: 22.FEB.2013 16:09:39

**Figure 2-3b: Band 4, Spurious Conducted Emissions, Middle channel**




Date: 22.FEB.2013 16:03:19

**Figure 2-4b: Band 4, Spurious Conducted Emissions, Middle channel**

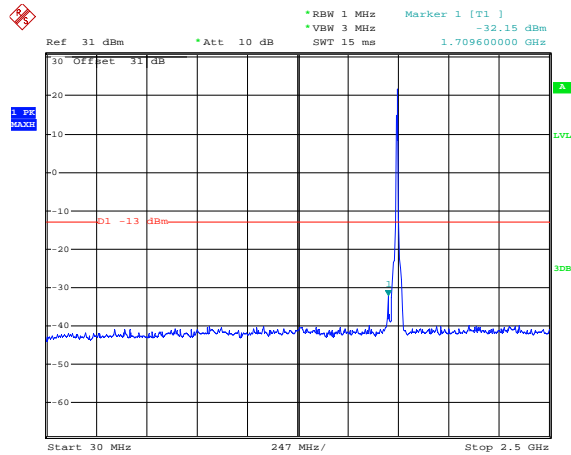


Date: 22.FEB.2013 16:07:14

	EMI Test Report for the BlackBerry® smartphone Model RFL111LW, RFP121LW <b>APPENDIX 2A</b>	
<b>Test Report No.:</b> RTS-6026-1302-12A_Rev1	<b>Dates of Test:</b> Nov. 22, 2012 to Mar. 04, 2013, and April 05, 2013	<b>FCC ID:</b> L6ARFL110LW, L6ARFP120LW <b>IC:</b> 2503A-RFL110LW, 2503A-RFP120LW

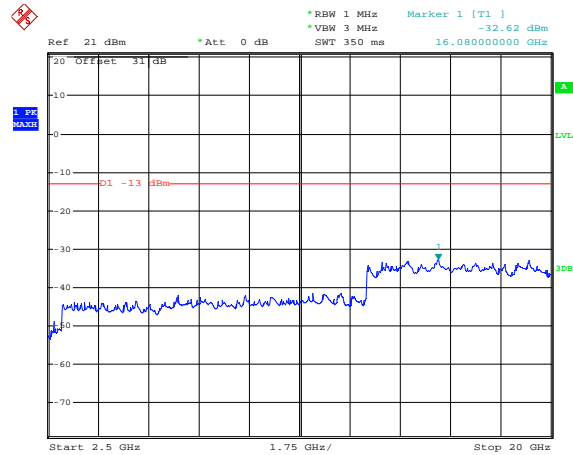
WCDMA Conducted RF Emission Test Data cont'd

**Figure 2-5b: Band 4, Spurious Conducted Emissions, High Channel**




Date: 22.FEB.2013 16:04:15

**Figure 2-6b: Band 4, Spurious Conducted Emissions, High Channel**

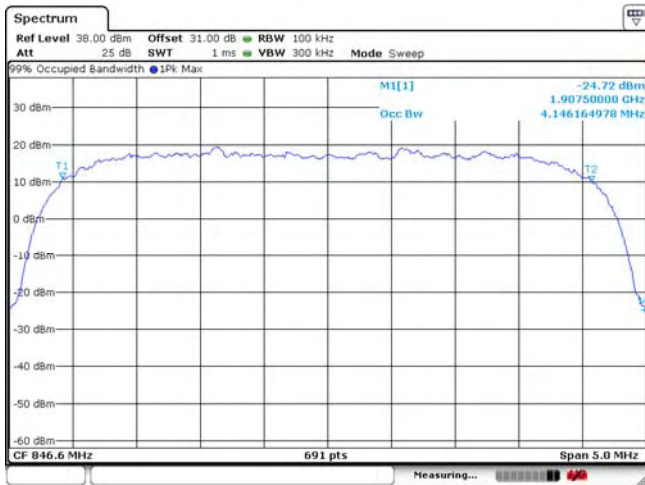


Date: 22.FEB.2013 16:05:28

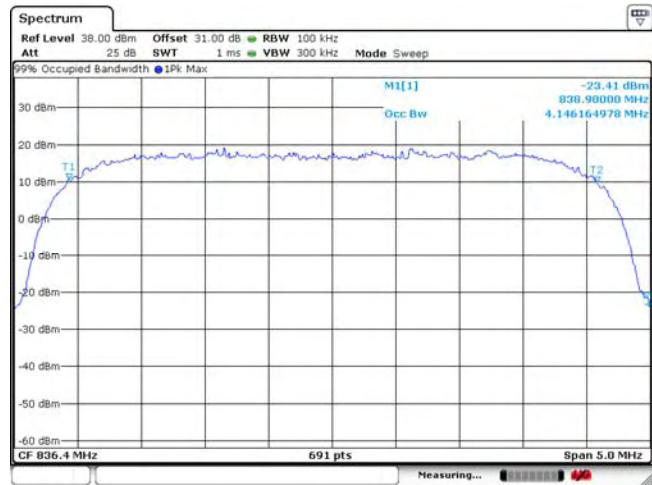
	EMI Test Report for the BlackBerry® smartphone Model RFL111LW, RFP121LW <b>APPENDIX 2A</b>	
<b>Test Report No.:</b> RTS-6026-1302-12A_Rev1	<b>Dates of Test:</b> Nov. 22, 2012 to Mar. 04, 2013, and April 05, 2013	<b>FCC ID:</b> L6ARFL110LW, L6ARFP120LW <b>IC:</b> 2503A-RFL110LW, 2503A-RFP120LW

## WCDMA Conducted RF Emission Test Data cont'd

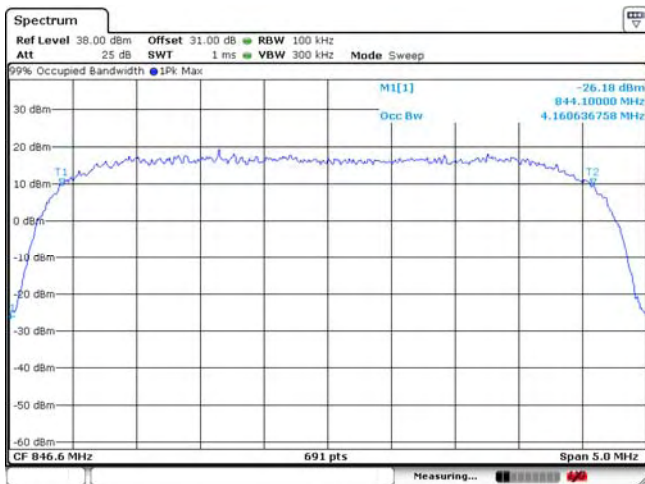
**Figure 2-13a: Occupied Bandwidth, Band 5 Low Channel**



**Figure 2-14a: Occupied Bandwidth, Band 5 Middle Channel**



**Figure 2-15a: Occupied Bandwidth, Band 5 High Channel**



**Figure 2-16a: Occupied Bandwidth, Band 2 Low Channel**



**Test Report No.:**  
 RTS-6026-1302-12A\_Rev1

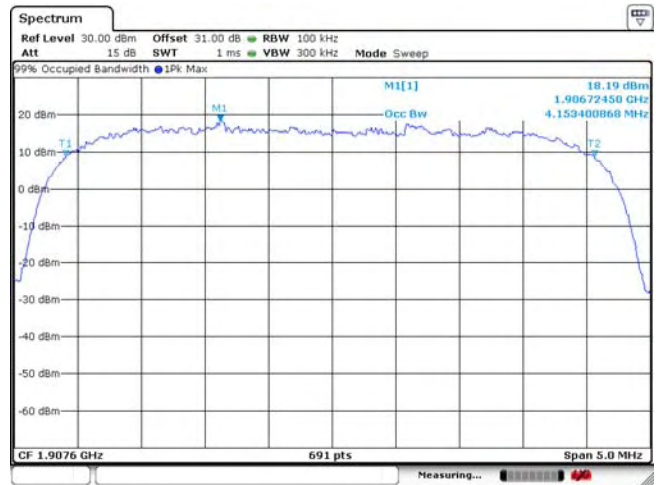
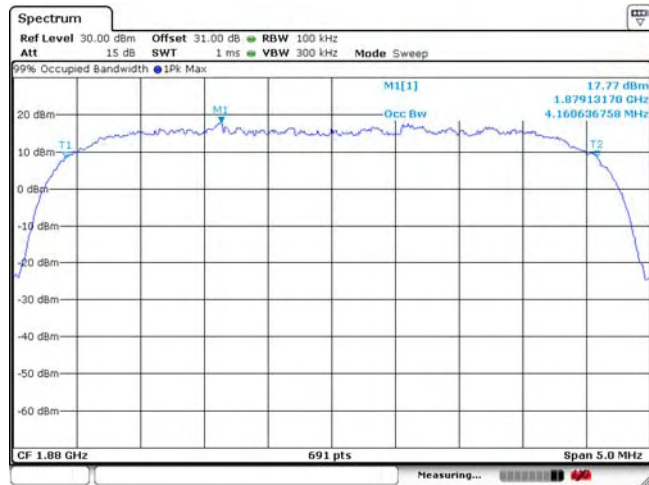
**Dates of Test:**  
 Nov. 22, 2012 to Mar. 04, 2013,  
 and April 05, 2013

**FCC ID:** L6ARFL110LW, L6ARFP120LW  
**IC:** 2503A-RFL110LW, 2503A-RFP120LW

WCDMA Conducted RF Emission Test Data cont'd

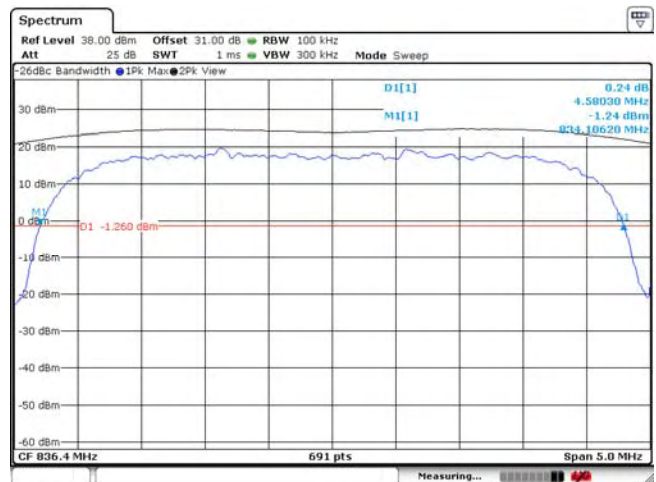
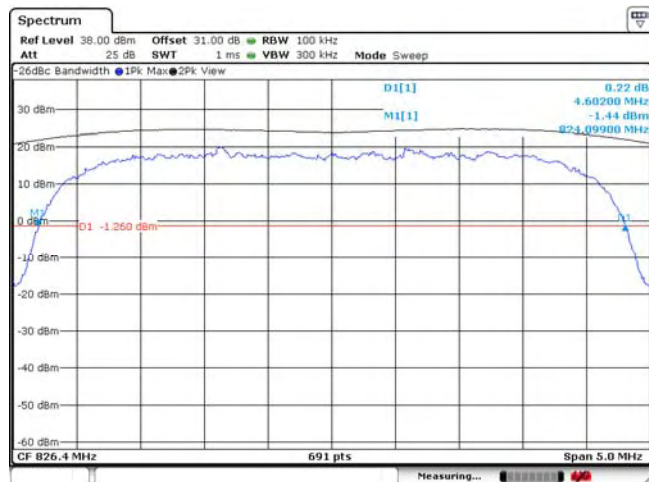
**Figure 2-17a: Occupied Bandwidth, Band 2 Middle Channel**

**Figure 2-18a: Occupied Bandwidth, Band 2 High Channel**



**Figure 2-19a: -26 dBc Bandwidth, Band 5 Low Channel**

**Figure 2-20a: -26 dBc Bandwidth, Band 5 Middle Channel**



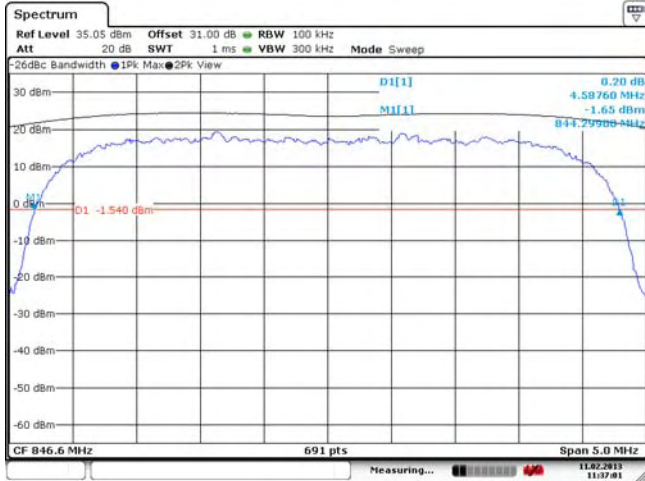
**Test Report No.:**  
 RTS-6026-1302-12A\_Rev1

**Dates of Test:**  
 Nov. 22, 2012 to Mar. 04, 2013,  
 and April 05, 2013

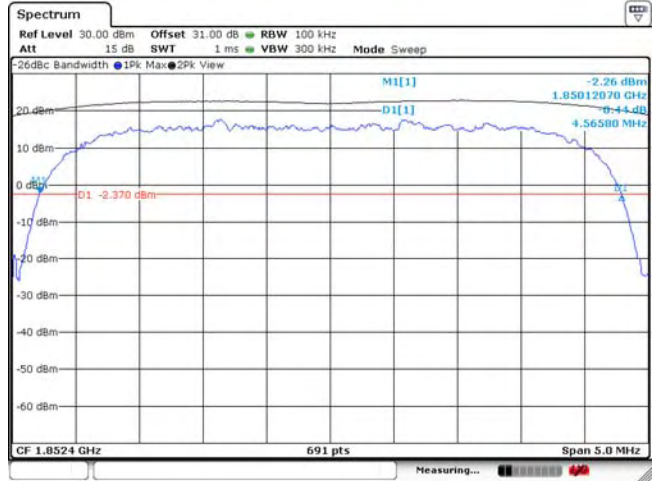
**FCC ID:** L6ARFL110LW, L6ARFP120LW  
**IC:** 2503A-RFL110LW, 2503A-RFP120LW

WCDMA Conducted RF Emission Test Data cont'd

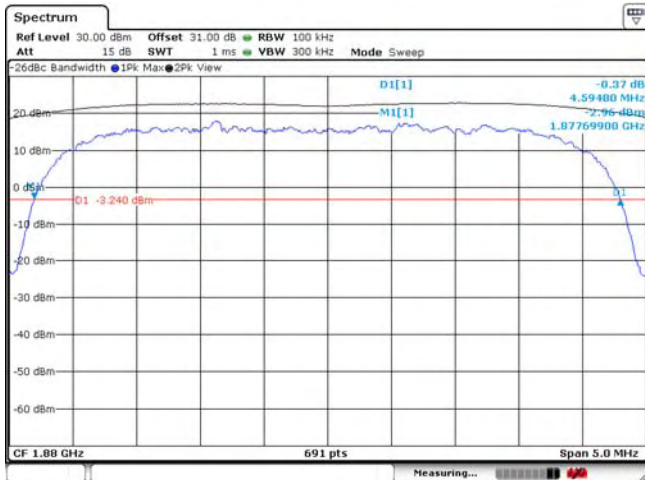
**Figure 2-21a: -26 dBc Bandwidth, Band 5 High Channel**



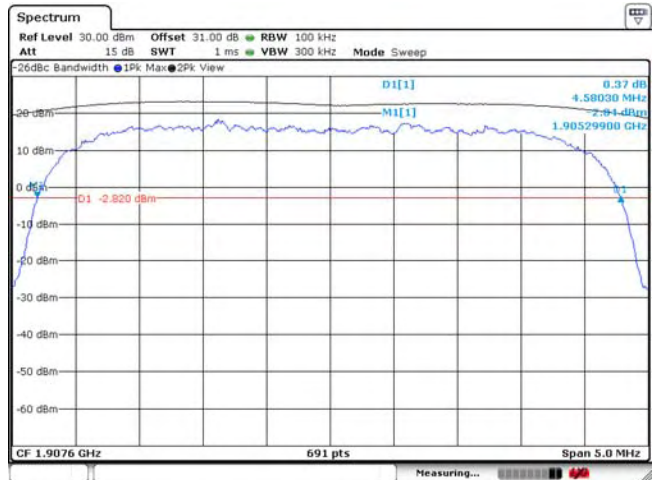
**Figure 2-22a: -26 dBc Bandwidth, Band 2 Low Channel**



**Figure 2-23a: -26 dBc Bandwidth, Band 2 Middle Channel**



**Figure 2-24a: -26 dBc Bandwidth, Band 2 High Channel**



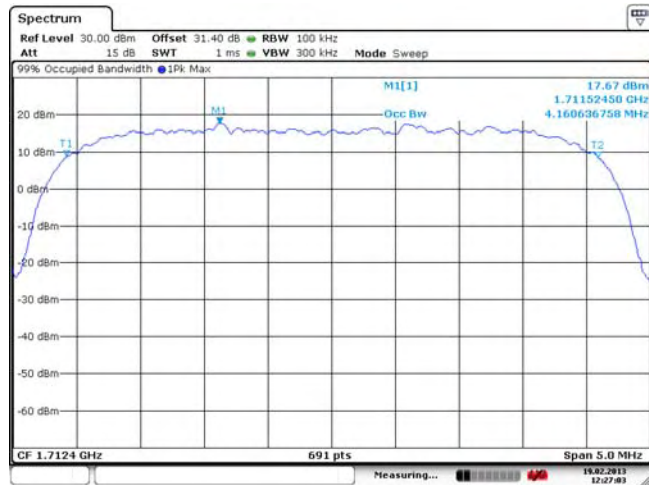
**Test Report No.:**  
 RTS-6026-1302-12A\_Rev1

**Dates of Test:**  
 Nov. 22, 2012 to Mar. 04, 2013,  
 and April 05, 2013

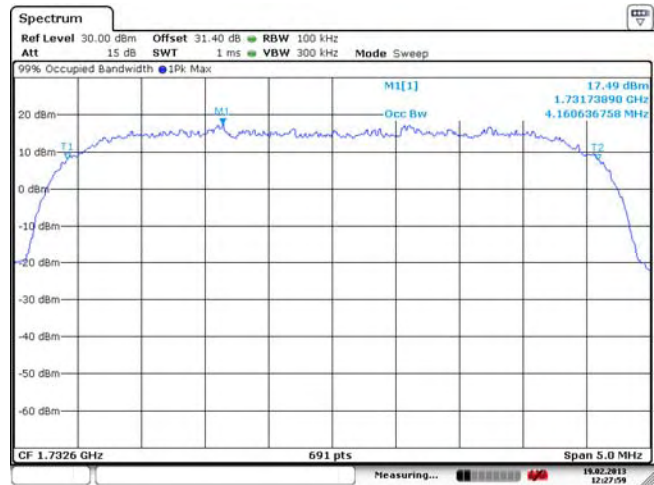
**FCC ID:** L6ARFL110LW, L6ARFP120LW  
**IC:** 2503A-RFL110LW, 2503A-RFP120LW

WCDMA Conducted RF Emission Test Data cont'd

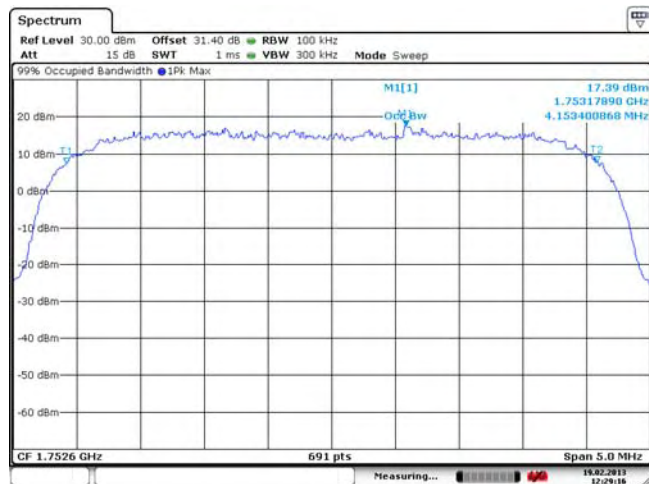
**Figure 2-7b: Occupied Bandwidth, Band 4 Low Channel**



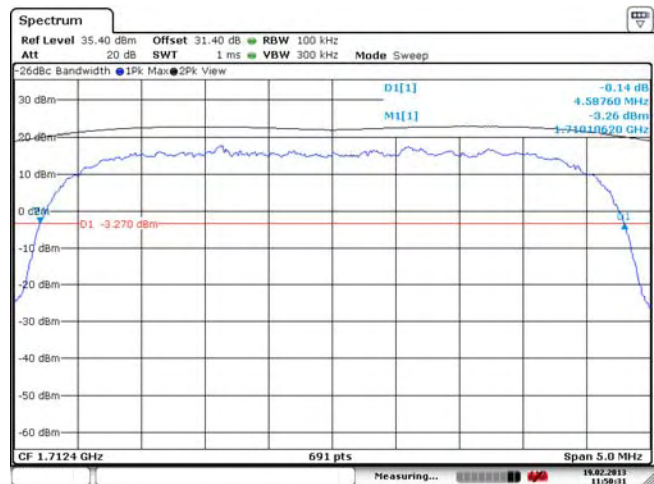
**Figure 2-8b: Occupied Bandwidth, Band 4 Middle Channel**




**Figure 2-9b: Occupied Bandwidth, Band 4 High Channel**



**Figure 2-10b: -26 dBc Bandwidth, Band 4 Low Channel**



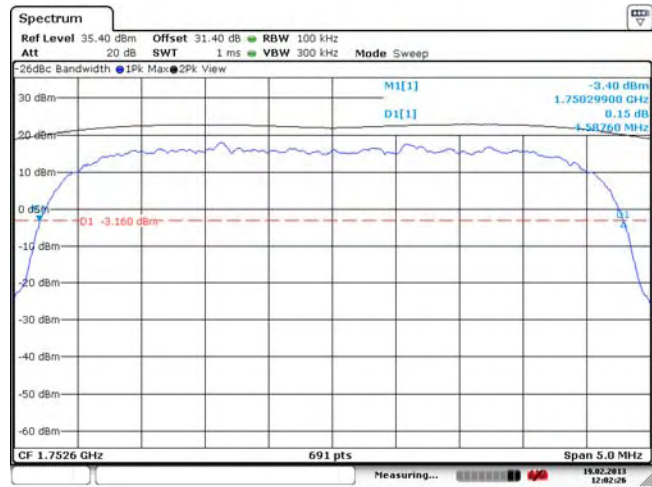
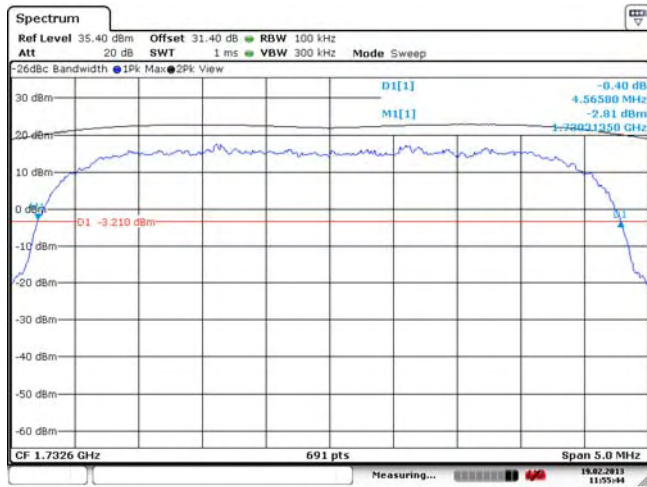


	EMI Test Report for the BlackBerry® smartphone Model RFL111LW, RFP121LW <b>APPENDIX 2A</b>	
<b>Test Report No.:</b> RTS-6026-1302-12A_Rev1	<b>Dates of Test:</b> Nov. 22, 2012 to Mar. 04, 2013, and April 05, 2013	<b>FCC ID:</b> L6ARFL110LW, L6ARFP120LW <b>IC:</b> 2503A-RFL110LW, 2503A-RFP120LW

### WCDMA Conducted RF Emission Test Data cont'd

**Figure 2-11b: -26 dBc Bandwidth, Band 4 Middle Channel**

**Figure 2-12b: -26 dBc Bandwidth, Band 4 High Channel**



**Test Report No.:**  
 RTS-6026-1302-12A\_Rev1

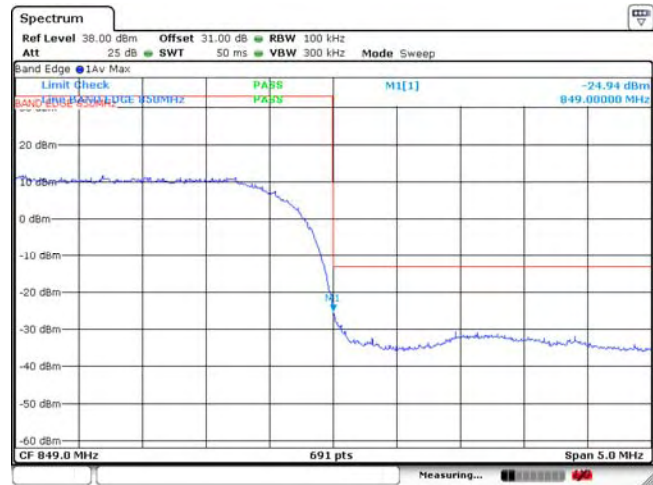
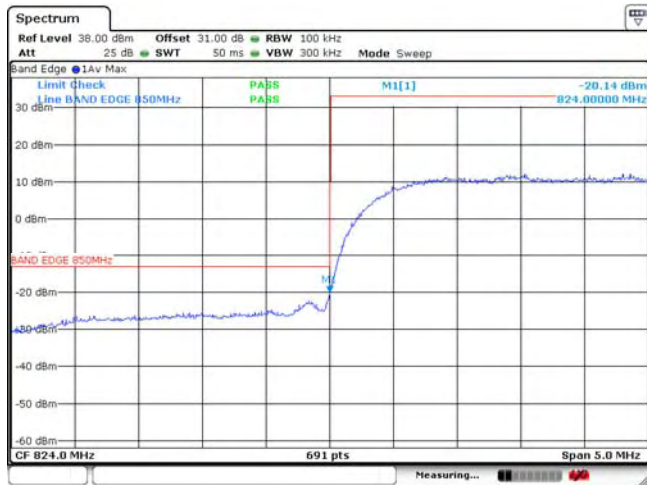
**Dates of Test:**  
 Nov. 22, 2012 to Mar. 04, 2013,  
 and April 05, 2013

**FCC ID:** L6ARFL110LW, L6ARFP120LW  
**IC:** 2503A-RFL110LW, 2503A-RFP120LW

WCDMA Conducted RF Emission Test Data cont'd

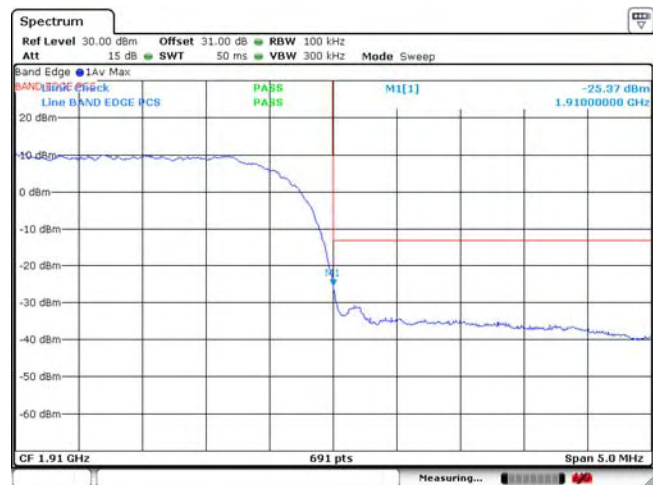
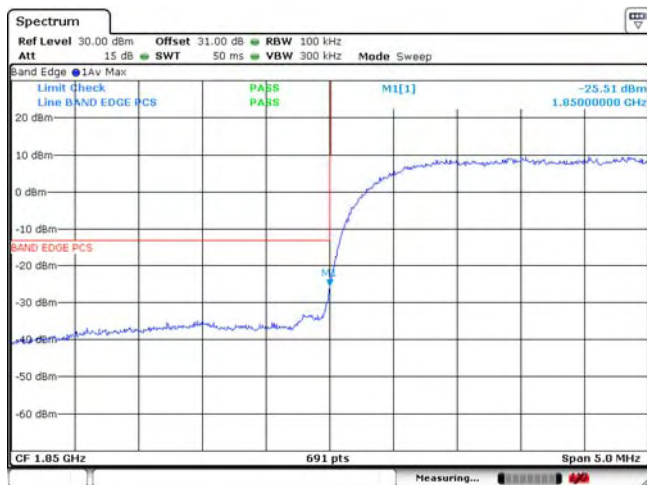
**Figure 2-25a: Band 5 Low Channel Mask**


**Figure 2-26a: Band 5 High Channel Mask**



**Figure 2-27a: Band 2 Low Channel Mask**

**Figure 2-28a: Band 2 High Channel Mask**

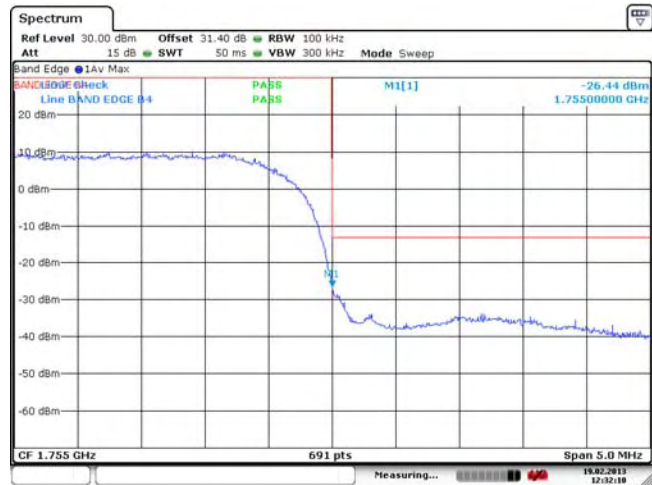
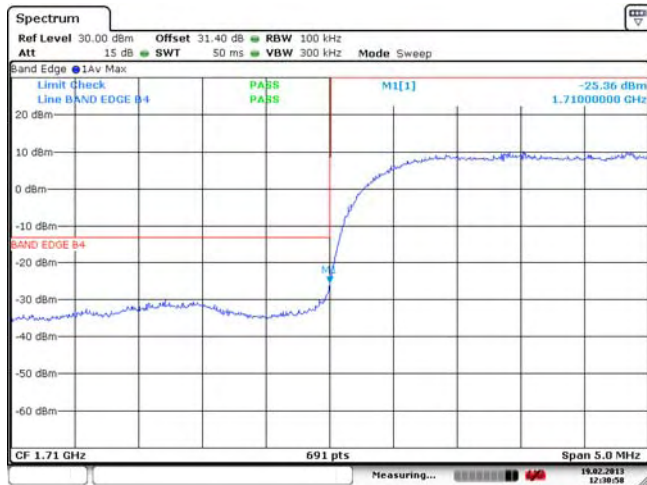



	EMI Test Report for the BlackBerry® smartphone Model RFL111LW, RFP121LW <b>APPENDIX 2A</b>	
<b>Test Report No.:</b> RTS-6026-1302-12A_Rev1	<b>Dates of Test:</b> Nov. 22, 2012 to Mar. 04, 2013, and April 05, 2013	<b>FCC ID:</b> L6ARFL110LW, L6ARFP120LW <b>IC:</b> 2503A-RFL110LW, 2503A-RFP120LW

WCDMA Conducted RF Emission Test Data cont'd

**Figure 2-13b: Band 4 Low Channel Mask**

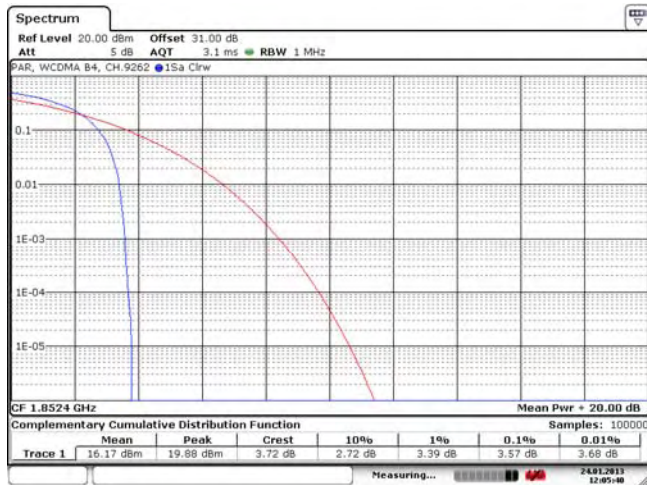
**Figure 2-14b: Band 4 High Channel Mask**



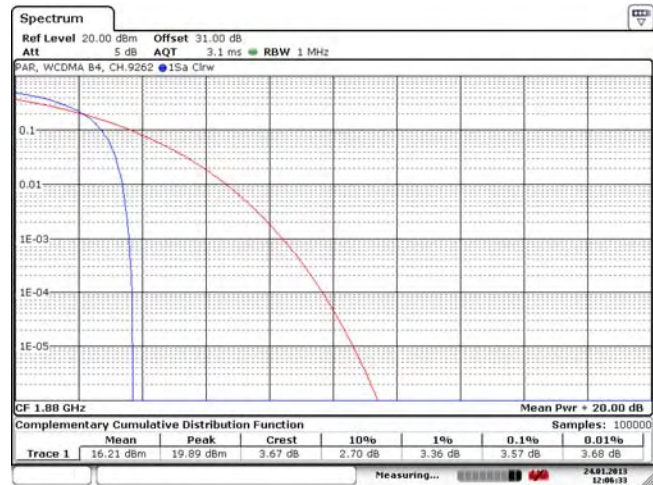
	EMI Test Report for the BlackBerry® smartphone Model RFL111LW, RFP121LW <b>APPENDIX 2A</b>	
	<b>Test Report No.:</b> RTS-6026-1302-12A_Rev1	<b>Dates of Test:</b> Nov. 22, 2012 to Mar. 04, 2013, and April 05, 2013

WCDMA Conducted RF Emission Test Data cont'd

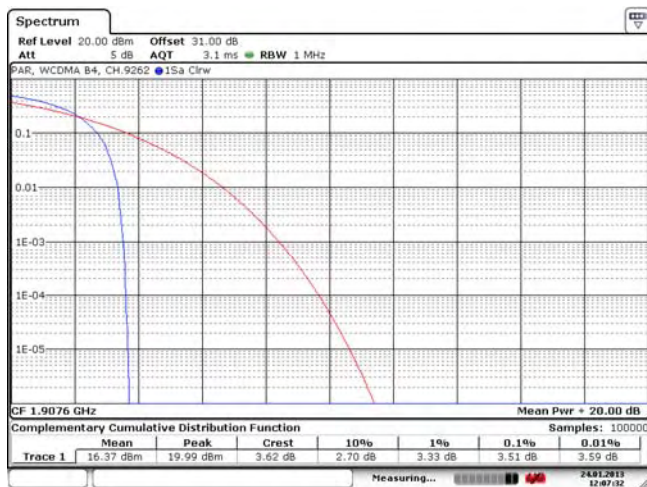
**Figure 2-29a: Band 2, PAR Low Channel**



**Figure 2-30a: Band 2, PAR Mid Channel**



**Figure 2-31a: Band 2, PAR High Channel**



**Test Report No.:**  
 RTS-6026-1302-12A\_Rev1

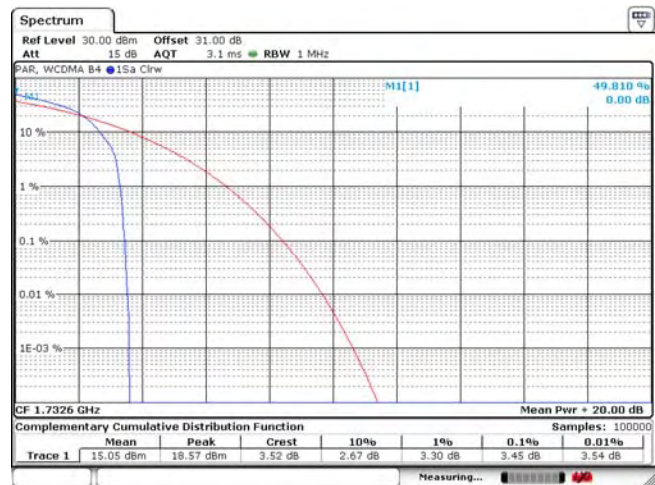
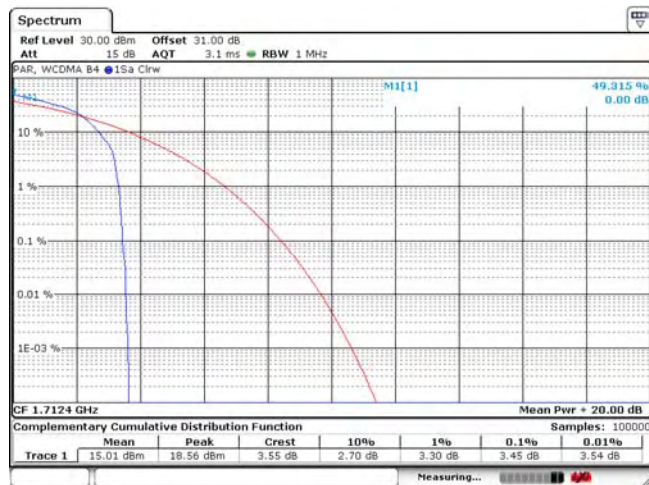
**Dates of Test:**  
 Nov. 22, 2012 to Mar. 04, 2013,  
 and April 05, 2013

**FCC ID:** L6ARFL110LW, L6ARFP120LW  
**IC:** 2503A-RFL110LW, 2503A-RFP120LW

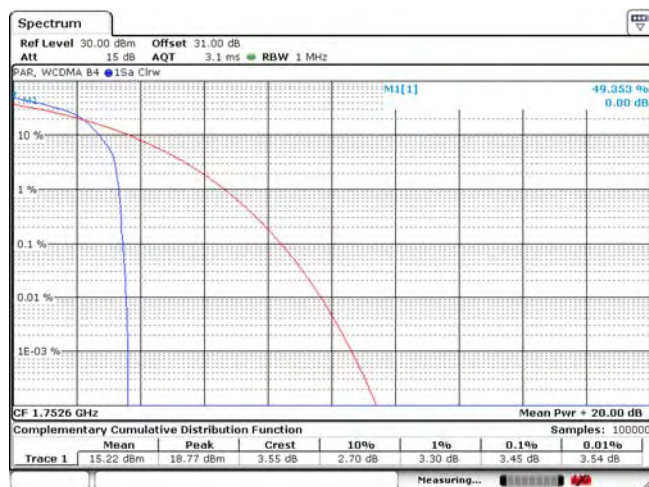
WCDMA Conducted RF Emission Test Data cont'd


**Figure 2-15b: Band 4, PAR Low Channel**

**Figure 2-16b: Band 4, PAR Mid Channel**



**Figure 2-17b: Band 4, PAR High Channel**



	EMI Test Report for the BlackBerry® smartphone Model RFL111LW, RFP121LW <b>APPENDIX 2A</b>	
	<b>Test Report No.:</b> RTS-6026-1302-12A_Rev1	<b>Dates of Test:</b> Nov. 22, 2012 to Mar. 04, 2013, and April 05, 2013

### WCDMA Conducted RF Emission Test Data cont'd

**The conducted spurious emissions** – As per 47 CFR 2.1051, CFR 24.238(a), CFR 22 Subpart H, RSS-132, RSS - 133 and RSS – 139, were measured from 30 MHz to 20 GHz.

Date of Test: December 12, 2012 and February 19 -25, 2013

The environmental test conditions were:   Temperature:           22.4 – 23.3°C  
   Relative Humidity:    21.3 – 28.9 %

### Test Data for WCDMA Band 2/4/5 selected Frequencies in HSUPA mode

WCDMA Band 5 Frequency (MHz)	99% Occupied Bandwidth (MHz)
826.400	4.153
836.400	4.146
846.600	4.146

WCDMA Band 2 Frequency (MHz)	99% Occupied Bandwidth (MHz)
1852.400	4.161
1880.000	4.161
1907.600	4.153

WCDMA Band 4 Frequency (MHz)	99% Occupied Bandwidth (MHz)
1712.4	4.161
1732.6	4.153
1752.6	4.153

### **Measurement Plots for WCDMA Band 5 and WCDMA Band 2 in HSUPA mode**

Refer to the following measurement plots for more detail:

The measurement plots for product RFL111LW:

See Figures 2-32a to 2-43a for the plots of the conducted spurious emissions.

See Figures 2-44a to 2-49a for the plots of 99% Occupied Bandwidth.

See Figures 2-50a to 2-53a for the plots of the Channel mask.

The measurement plots for product RFP121LW:

See Figures 2-18b to 2-23b for the plots of the conducted spurious emissions.

See Figures 2-24b to 2-26b for the plots of 99% Occupied Bandwidth.

See Figures 2-27b to 2-28b for the plots of the Channel mask.

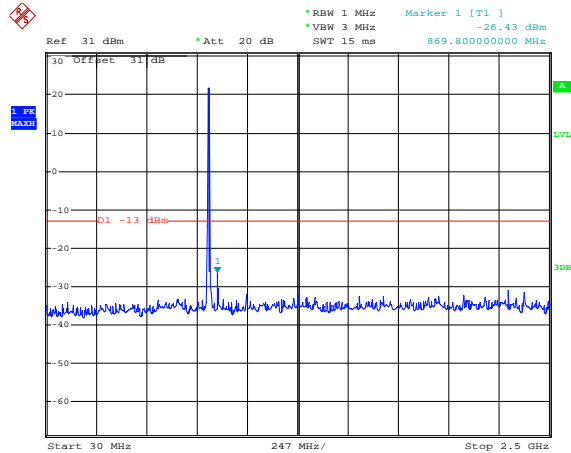
**Test Report No.:**  
 RTS-6026-1302-12A\_Rev1

**Dates of Test:**  
 Nov. 22, 2012 to Mar. 04, 2013,  
 and April 05, 2013

**FCC ID:** L6ARFL110LW, L6ARFP120LW  
**IC:** 2503A-RFL110LW, 2503A-RFP120LW

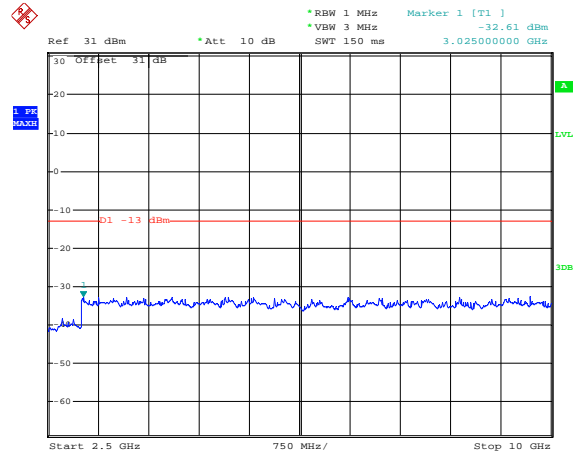
WCDMA Conducted RF Emission Test Data cont'd

**Figure 2-32a: Band 5 HSUPA, Spurious Conducted Emissions, Low channel**



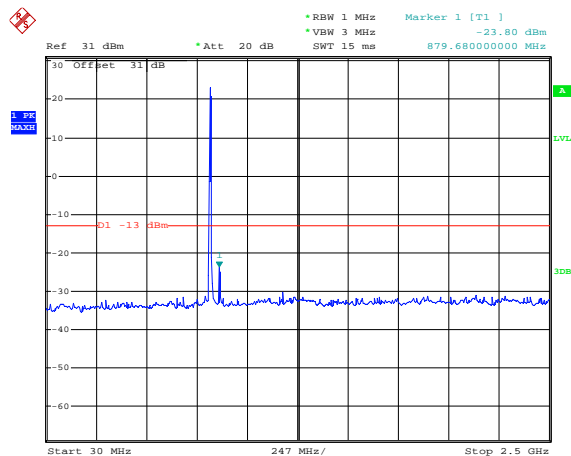
Date: 12.DEC.2012 13:04:34

**Figure 2-33a: Band 5 HSUPA, Spurious Conducted Emissions, Low channel**



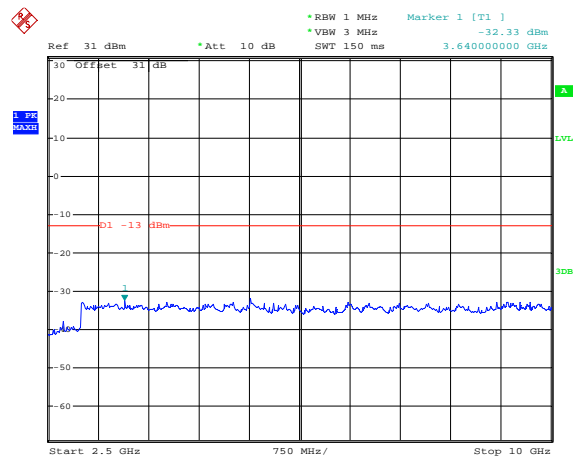
Date: 12.DEC.2012 13:03:55

**Figure 2-34a: Band 5 HSUPA, Spurious Conducted Emissions, Middle channel**



Date: 12.DEC.2012 13:05:17

**Figure 2-35a: Band 5 HSUPA, Spurious Conducted Emissions, Middle channel**



Date: 12.DEC.2012 13:03:03

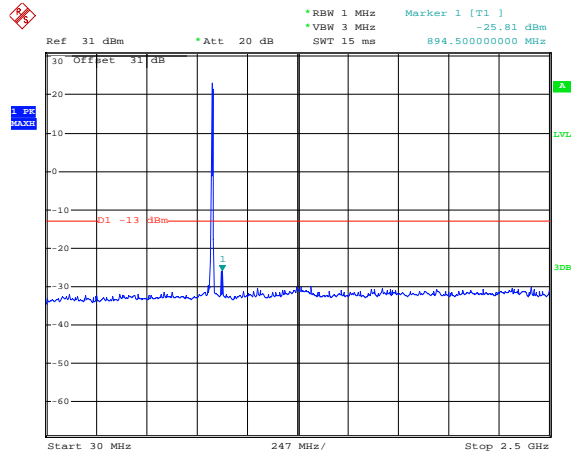
**Test Report No.:**  
 RTS-6026-1302-12A\_Rev1

**Dates of Test:**  
 Nov. 22, 2012 to Mar. 04, 2013,  
 and April 05, 2013

**FCC ID:** L6ARFL110LW, L6ARFP120LW  
**IC:** 2503A-RFL110LW, 2503A-RFP120LW

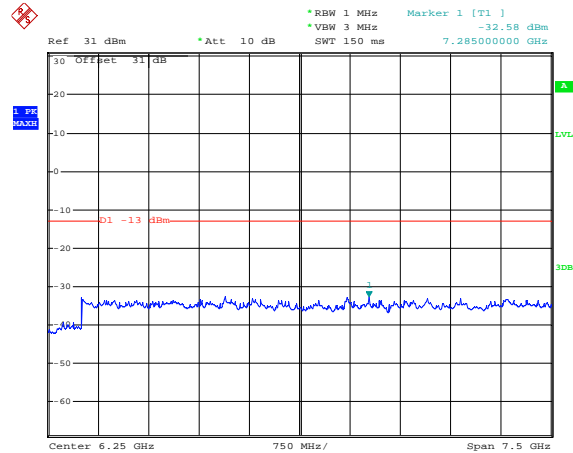
WCDMA Conducted RF Emission Test Data cont'd

**Figure 2-36a: Band 5 HSUPA, Spurious Conducted Emissions, High Channel**



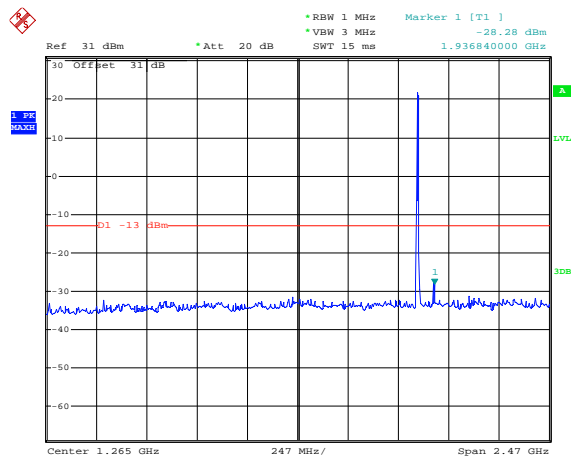
Date: 12.DEC.2012 13:08:03

**Figure 2-37a: Band 5 HSUPA, Spurious Conducted Emissions, High Channel**



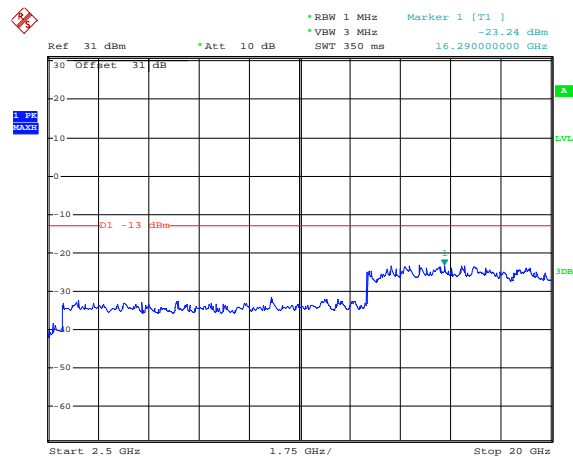
Date: 12.DEC.2012 13:01:53

**Figure 2-38a: Band 2 HSUPA, Spurious Conducted Emissions, Low Channel**



Date: 12.DEC.2012 12:16:55

**Figure 2-39a: Band 2 HSUPA, Spurious Conducted Emissions, Low Channel**



Date: 12.DEC.2012 12:44:23



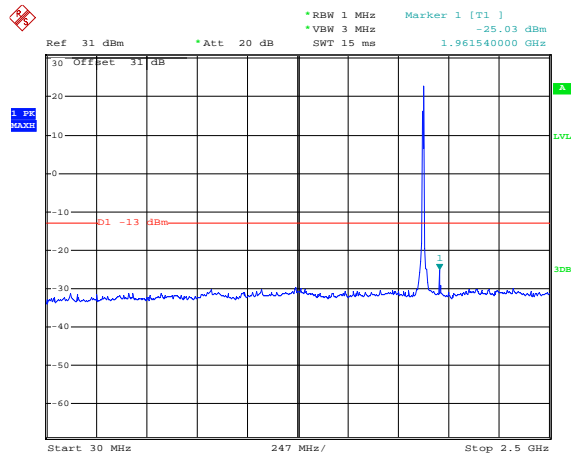
**Test Report No.:**  
 RTS-6026-1302-12A\_Rev1

**Dates of Test:**  
 Nov. 22, 2012 to Mar. 04, 2013,  
 and April 05, 2013

**FCC ID:** L6ARFL110LW, L6ARFP120LW  
**IC:** 2503A-RFL110LW, 2503A-RFP120LW

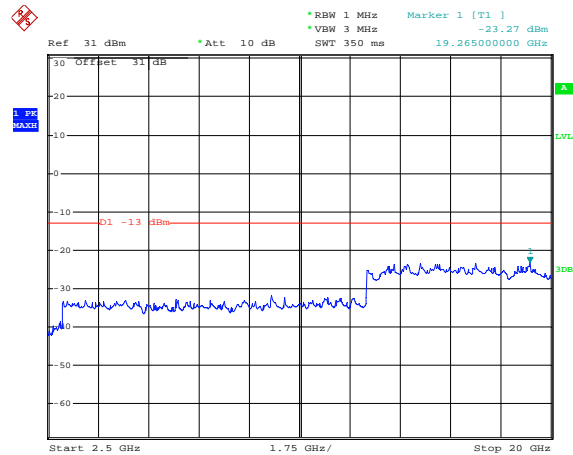
### WCDMA Conducted RF Emission Test Data cont'd

**Figure 2-40a: Band 2 HSUPA, Spurious Conducted Emissions, Middle Channel**



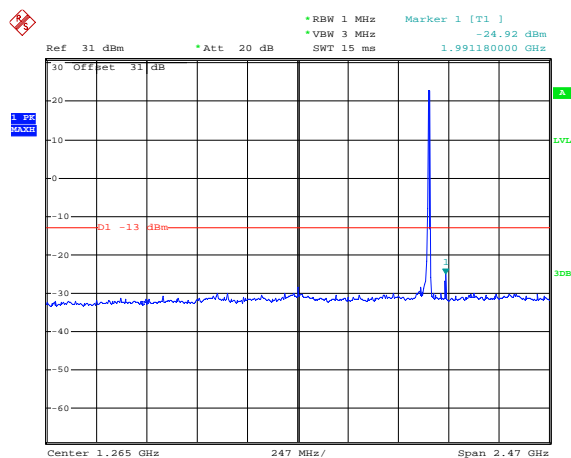
Date: 12.DEC.2012 12:25:58

**Figure 2-41a: Band 2 HSUPA, Spurious Conducted Emissions, Middle Channel**



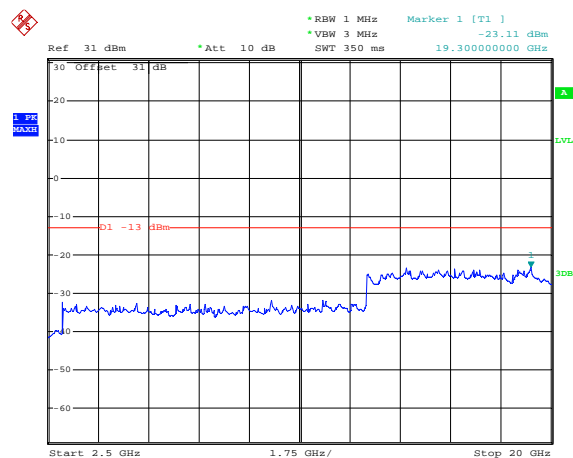
Date: 12.DEC.2012 12:43:44

**Figure 2-42a: Band 2 HSUPA, Spurious Conducted Emissions, High Channel**



Date: 12.DEC.2012 12:41:06

**Figure 2-43a: Band 2 HSUPA, Spurious Conducted Emissions, High Channel**



Date: 12.DEC.2012 12:43:08

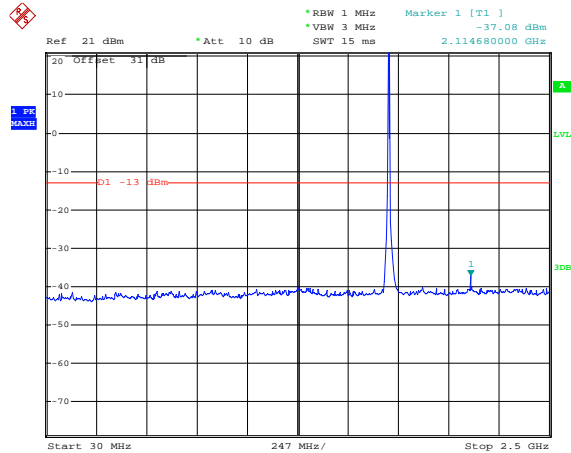
**Test Report No.:**  
 RTS-6026-1302-12A\_Rev1

**Dates of Test:**  
 Nov. 22, 2012 to Mar. 04, 2013,  
 and April 05, 2013

**FCC ID:** L6ARFL110LW, L6ARFP120LW  
**IC:** 2503A-RFL110LW, 2503A-RFP120LW

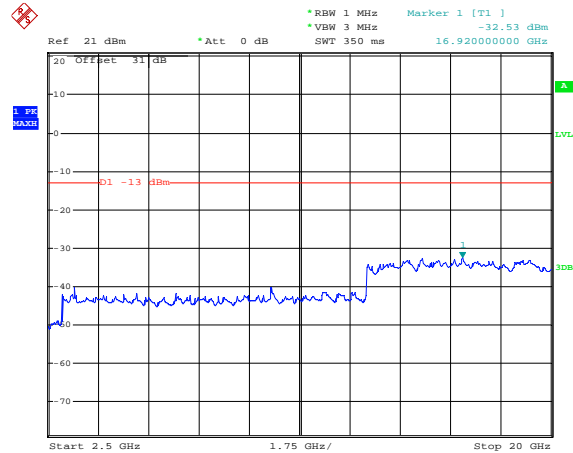
**WCDMA Conducted RF Emission Test Data cont'd**

**Figure 2-18b: Band 4 HSUPA, Spurious Conducted Emissions, Low channel**



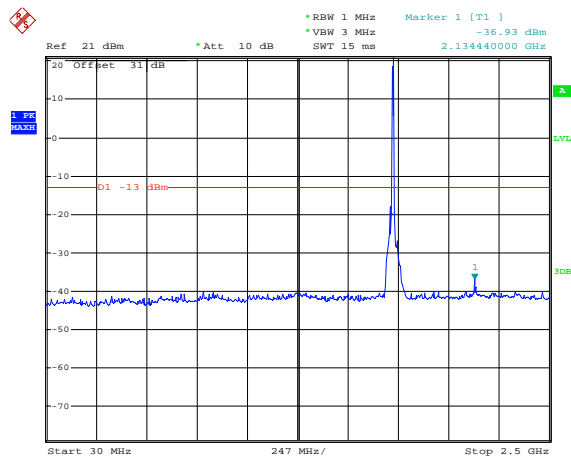
Date: 25.FEB.2013 14:53:05

**Figure 2-19b: Band 4 HSUPA, Spurious Conducted Emissions, Low channel**



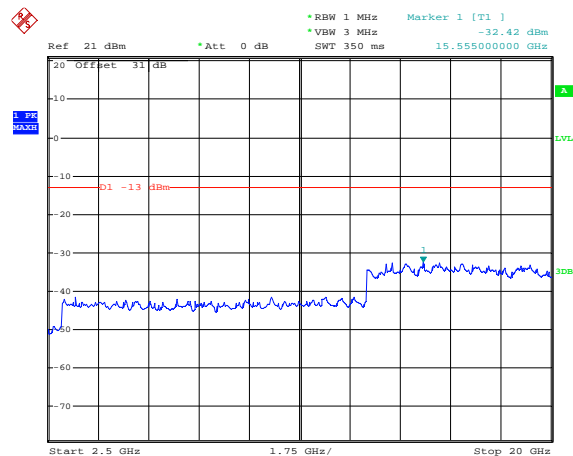
Date: 25.FEB.2013 15:12:25

**Figure 2-20b: Band 4 HSUPA, Spurious Conducted Emissions, Middle channel**




Date: 25.FEB.2013 15:04:58

**Figure 2-21b: Band 4 HSUPA, Spurious Conducted Emissions, Middle channel**

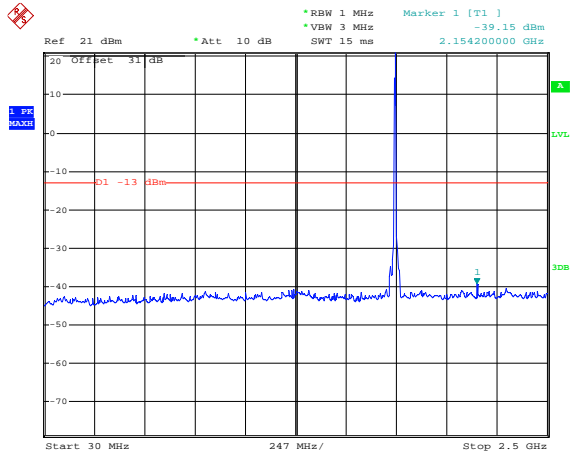


Date: 25.FEB.2013 15:10:22

	EMI Test Report for the BlackBerry® smartphone Model RFL111LW, RFP121LW <b>APPENDIX 2A</b>	
<b>Test Report No.:</b> RTS-6026-1302-12A_Rev1	<b>Dates of Test:</b> Nov. 22, 2012 to Mar. 04, 2013, and April 05, 2013	<b>FCC ID:</b> L6ARFL110LW, L6ARFP120LW <b>IC:</b> 2503A-RFL110LW, 2503A-RFP120LW

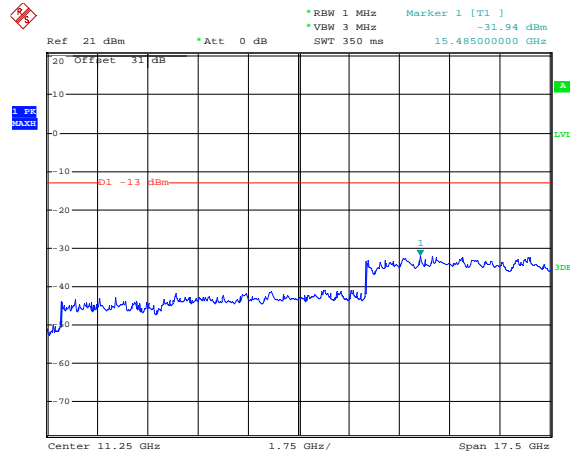
### WCDMA Conducted RF Emission Test Data cont'd

**Figure 2-22b: Band 4 HSUPA, Spurious Conducted Emissions, High Channel**



Date: 25.FEB.2013 15:05:34

**Figure 2-23b: Band 4 HSUPA, Spurious Conducted Emissions, High Channel**



Date: 25.FEB.2013 15:09:03

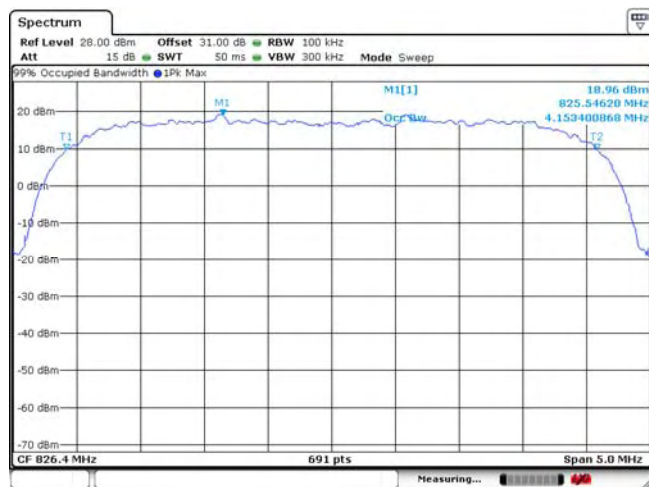
**Test Report No.:**  
 RTS-6026-1302-12A\_Rev1

**Dates of Test:**  
 Nov. 22, 2012 to Mar. 04, 2013,  
 and April 05, 2013

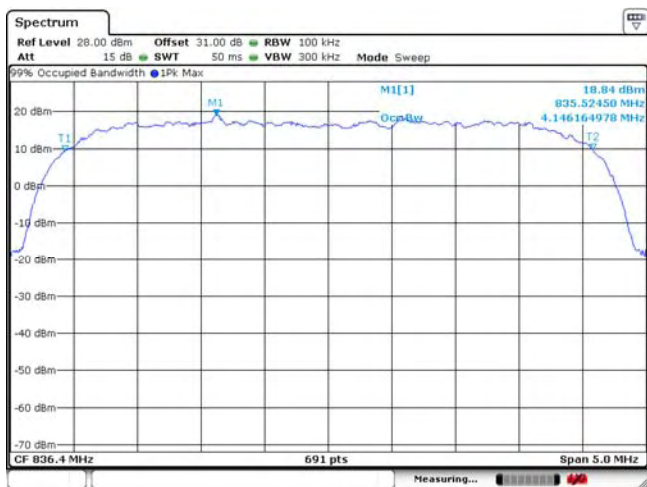
**FCC ID:** L6ARFL110LW, L6ARFP120LW  
**IC:** 2503A-RFL110LW, 2503A-RFP120LW

**WCDMA Conducted RF Emission Test Data cont'd**

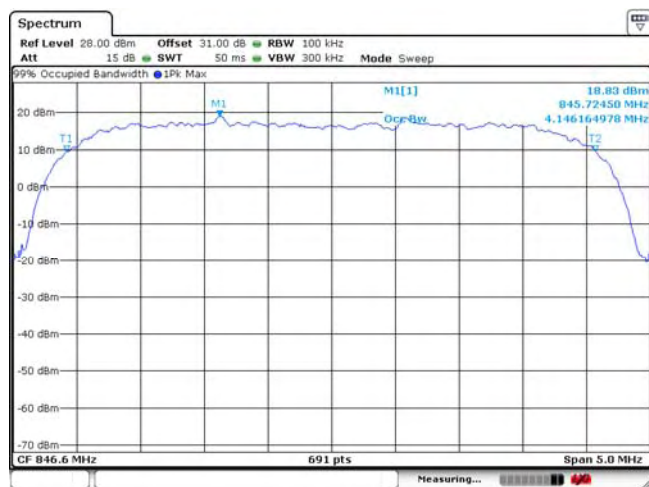
**Figure 2-44a: Occupied Bandwidth, Band 5 HSUPA Low Channel**



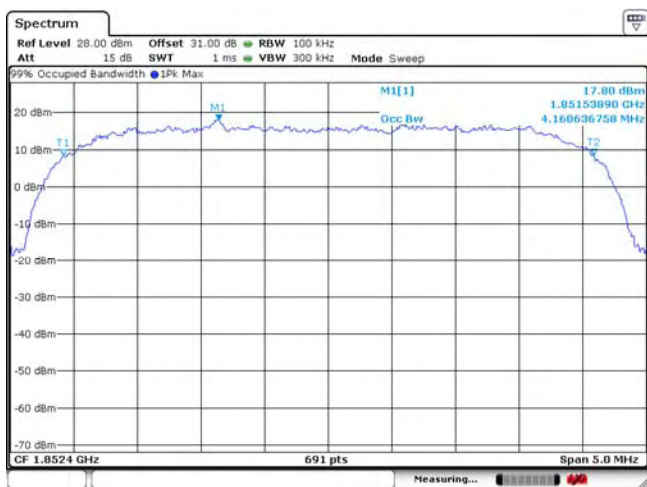
**Figure 2-45a: Occupied Bandwidth, Band 5 HSUPA Middle Channel**




**Figure 2-46a: Occupied Bandwidth, Band 5 HSUPA High Channel**



**Figure 2-47a: Occupied Bandwidth, Band 2 HSUPA Low Channel**

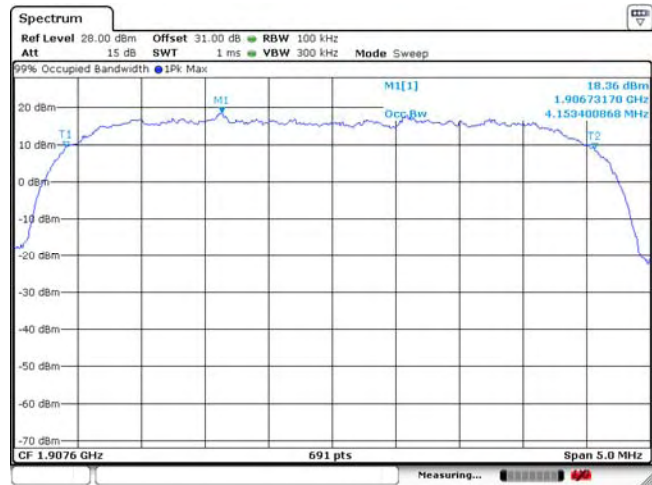
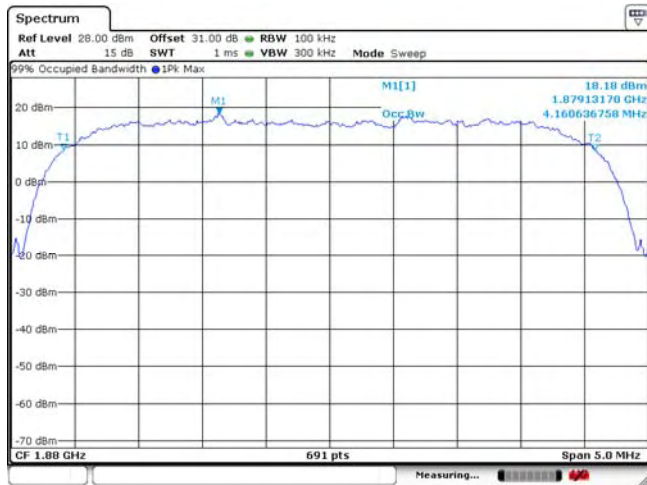



	EMI Test Report for the BlackBerry® smartphone Model RFL111LW, RFP121LW <b>APPENDIX 2A</b>	
<b>Test Report No.:</b> RTS-6026-1302-12A_Rev1	<b>Dates of Test:</b> Nov. 22, 2012 to Mar. 04, 2013, and April 05, 2013	<b>FCC ID:</b> L6ARFL110LW, L6ARFP120LW <b>IC:</b> 2503A-RFL110LW, 2503A-RFP120LW

WCDMA Conducted RF Emission Test Data cont'd

**Figure 2-48a: Occupied Bandwidth, Band 2  
HSUPA Middle Channel**

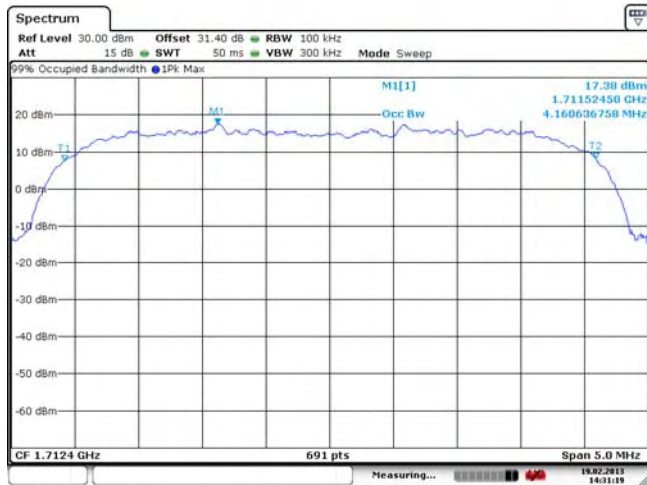
**Figure 2-49a: Occupied Bandwidth, Band 2  
HSUPA High Channel**



	EMI Test Report for the BlackBerry® smartphone Model RFL111LW, RFP121LW <b>APPENDIX 2A</b>	
<b>Test Report No.:</b> RTS-6026-1302-12A_Rev1	<b>Dates of Test:</b> Nov. 22, 2012 to Mar. 04, 2013, and April 05, 2013	<b>FCC ID:</b> L6ARFL110LW, L6ARFP120LW <b>IC:</b> 2503A-RFL110LW, 2503A-RFP120LW

WCDMA Conducted RF Emission Test Data cont'd

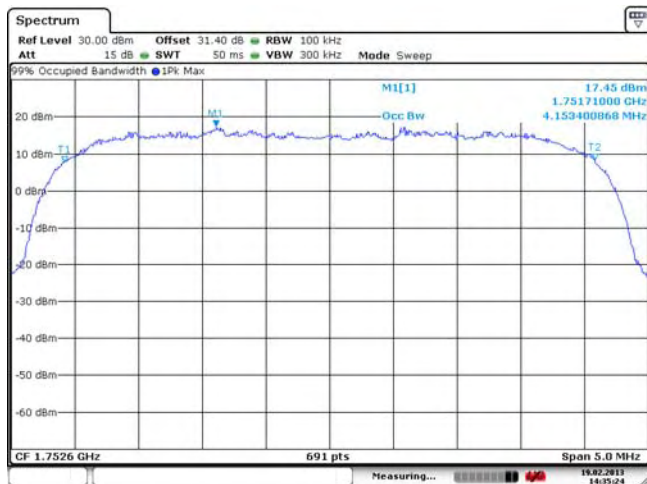
**Figure 2-24b: Occupied Bandwidth, Band 4 HSUPA Low Channel**




**Figure 2-25b: Occupied Bandwidth, Band 4 HSUPA Middle Channel**



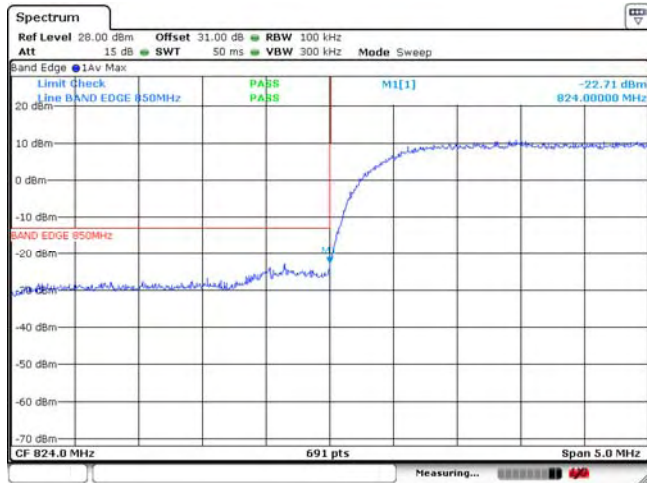
**Figure 2-26b: Occupied Bandwidth, Band 4 HSUPA High Channel**



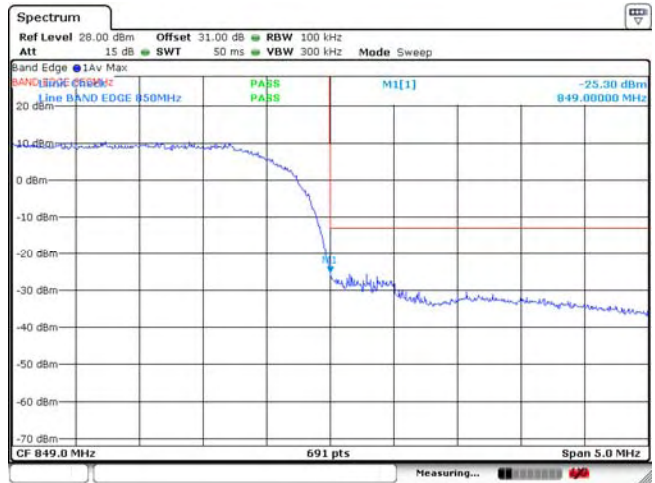
	EMI Test Report for the BlackBerry® smartphone Model RFL111LW, RFP121LW <b>APPENDIX 2A</b>	
	<b>Test Report No.:</b> RTS-6026-1302-12A_Rev1	<b>Dates of Test:</b> Nov. 22, 2012 to Mar. 04, 2013, and April 05, 2013

WCDMA Conducted RF Emission Test Data cont'd

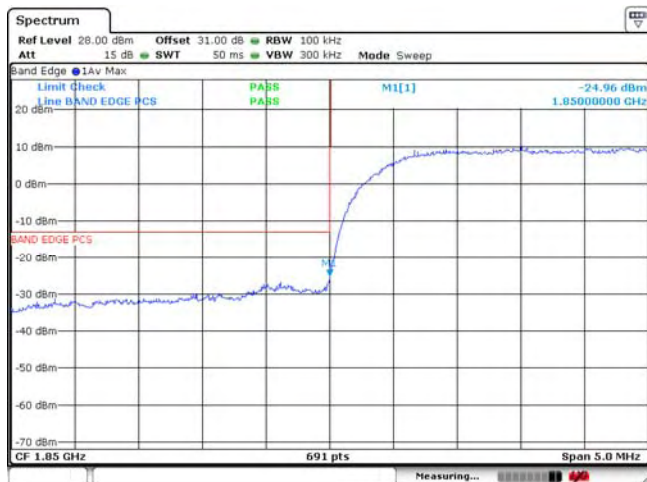
**Figure 2-50a: Band 5 , HSUPA Low Channel Mask**



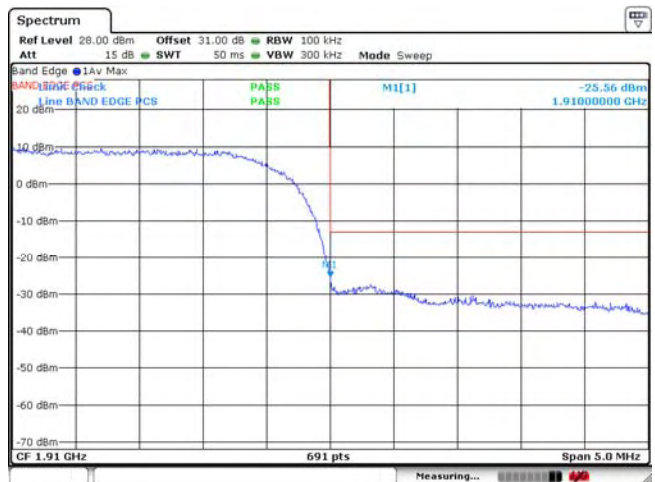
**Figure 2-51a: Band 5 , HSUPA High Channel Mask**




**Figure 2-52a: Band 2, HSUPA Low Channel Mask**



**Figure 2-53a: Band 2, HSUPA High Channel Mask**

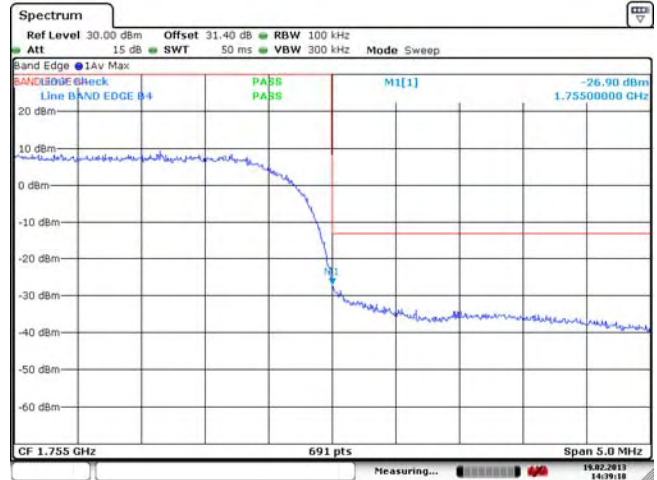
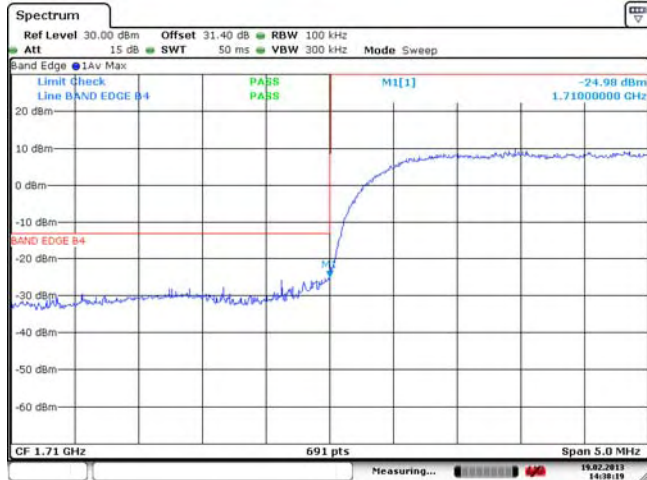


	EMI Test Report for the BlackBerry® smartphone Model RFL111LW, RFP121LW <b>APPENDIX 2A</b>	
<b>Test Report No.:</b> RTS-6026-1302-12A_Rev1	<b>Dates of Test:</b> Nov. 22, 2012 to Mar. 04, 2013, and April 05, 2013	<b>FCC ID:</b> L6ARFL110LW, L6ARFP120LW <b>IC:</b> 2503A-RFL110LW, 2503A-RFP120LW

WCDMA Conducted RF Emission Test Data cont'd


**Figure 2-27b: Band 4, HSUPA Low Channel Mask**

**Figure 2-28b: Band 4, HSUPA High Channel Mask**

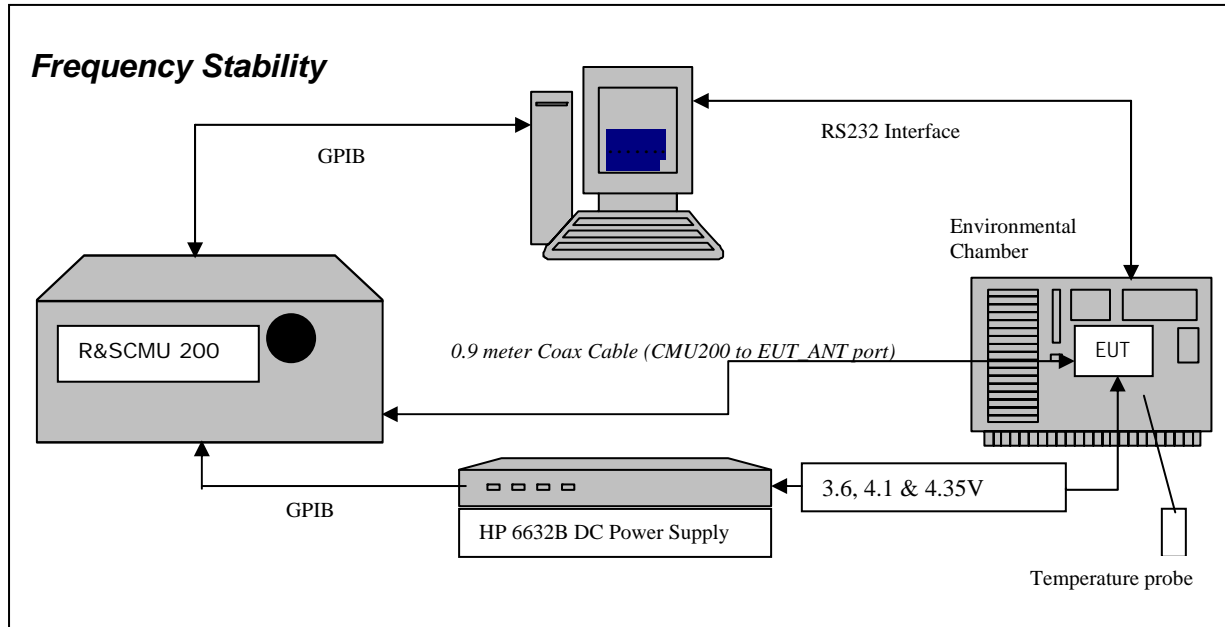




APPENDIX 2B – WCDMA Band 2/4/5 FREQUENCY STABILITY TEST DATA

	EMI Test Report for the BlackBerry® smartphone Model RFL111LW, RFP121LW <b>APPENDIX 2B</b>	
<b>Test Report No.:</b> RTS-6026-1302-12A_Rev1	<b>Dates of Test:</b> Nov. 22, 2012 to Mar. 04, 2013, and April 05, 2013	<b>FCC ID:</b> L6ARFL110LW, L6ARFP120LW <b>IC:</b> 2503A-RFL110LW, 2503A-RFP120LW

### WCDMA Frequency Stability Test Data



The following measurements were performed by Berkin Can.

CFR 47 Chapter 1 - Federal Communications Commission Rules

Part 2 Required Measurements


- 2.1055** Frequency Stability - Procedures
- (a,b) Frequency Stability - Temperature Variation
- (d) Frequency Stability - Voltage Variation

**24.235** *Frequency Stability.*

*The frequency stability shall be sufficient to ensure that the fundamental emission stays within the authorized frequency block.*

*The EUT meets the requirements as stated in CFR 47 chapter 1, Section 27.54, CFR 47 and RSS-139, 6.3 Frequency Stability.*

Frequency Stability measurement devices were configured as presented in the block diagram recording frequency, power, data, temperatures, and stepped voltages controlled via a GPIB interface linked to the Environmental chamber, a DC power supply, and the Communications Test Set. A 0.9-metre coax cable was calibrated to characterize the insertion loss for the transmitted frequencies between the RF input/output of the CMU 200 and the EUT antenna port.

	EMI Test Report for the BlackBerry® smartphone Model RFL111LW, RFP121LW <b>APPENDIX 2B</b>	
<b>Test Report No.:</b> RTS-6026-1302-12A_Rev1	<b>Dates of Test:</b> Nov. 22, 2012 to Mar. 04, 2013, and April 05, 2013	<b>FCC ID:</b> L6ARFL110LW, L6ARFP120LW <b>IC:</b> 2503A-RFL110LW, 2503A-RFP120LW

### Test Setup:

The EUT was placed in the Temperature chamber and connected to CMU 200 outside as shown in the figure above. Dry air was pumped inside the temperature chamber to maintain a backpressure during the test. The EUT was kept in the off condition at all times except when the following measurements were to be made.


The chamber was switched on and the temperature was set to -30°C. After the chamber stabilized at -30 °C there was a soak period of one hour to alleviate moisture in the chamber, the EUT voltage was enabled. The system software recorded the frequency, power, and associated measurements.

A Computer system controlled the automated software. This application was given the command of activating all machines intrinsic to the temperature and voltage tests controlling the CMU 200 via the GPIB Bus. The Environmental Chamber was instructed through an RS-232 serial line. The EUT dialogue was passed through a serial connection.

The EUT repetitively transmitted 100 bursts for each set of programmed parameters recording temperature, voltage settings, and systematically selected frequencies. The power supply was cycled from minimum voltage 3.6 volts, 4.1 volts and to 4.35 volts maximum voltage. The frequency error was measured at a maximum output power and recorded by the automated system test software.

The EUT output power and frequency was measured at 3.6 volts, 4.1 volts and 4.35 volts. The transmit frequency was varied in 3 steps consisting of 1852.4, 1880.0 and 1907.6 MHz for the WCDMA band 2. This frequency was recorded in MHz and deviation from nominal, in Parts Per Million.

After the initial one-hour soak at the beginning of the tests, a period of thirty minutes soak was initialized between each ascending temperature step, before proceeding to the next measurement test cycle.

	EMI Test Report for the BlackBerry® smartphone Model RFL111LW, RFP121LW <b>APPENDIX 2B</b>	
<b>Test Report No.:</b> RTS-6026-1302-12A_Rev1	<b>Dates of Test:</b> Nov. 22, 2012 to Mar. 04, 2013, and April 05, 2013	<b>FCC ID:</b> L6ARFL110LW, L6ARFP120LW <b>IC:</b> 2503A-RFL110LW, 2503A-RFP120LW


Procedure:

The test system software for commencing the Frequency Stability Tests carried through the following cycle.

1. Switch on the HP 6632B power supply; CMU 200 Communications test Set, and Environmental Chamber.
2. Start test program
3. Set the Temperature to –30°C and maintain a period of one- hour soak time, with the EUT supply voltage disabled.
4. Set power supply voltage to 3.6 volts.
5. Set up CMU 200 Radio Communication Tester.
6. Command the CMU 200 to switch to the low channel.
7. Enable the voltage to the EUT, and connect a link to the CMU 200 test set.
8. EUT is commanded to Transmit 100 Bursts.
9. Software logs the following data from the CMU 200, power supply and temperature chamber: Traffic Channel Number, Traffic Channel Frequency, Power Level, Chamber Temperature, Supply Voltage, Power and Frequency Error.
10. The CMU 200 commands the EUT to change frequency to the middle channel and high channel and repeats steps 7 to 9.
11. Repeat steps 5 to 10 changing the supply voltage to 4.1 Volts
12. Increase temperature by 10°C and soak for 1/2 hour.
13. Repeat steps 4 - 12 for temperatures –30°C to 60°C.
14. Repeat steps 5 to 10 changing the supply voltage to 4.35 volts

Procedure 5 to 10 was repeated at room temperature (20°C) with the power supply voltage set to 3.6, 4.1 and 4.35 volts

The maximum frequency error in the WCDMA band 5 measured was **0.0387 PPM**.  
The maximum frequency error in the WCDMA band 2 measured was **0.0154 PPM**.  
The maximum frequency error in the WCDMA band 4 measured was **0.0177 PPM**.

	EMI Test Report for the BlackBerry® smartphone Model RFL111LW, RFP121LW <b>APPENDIX 2B</b>	
	<b>Test Report No.:</b> RTS-6026-1302-12A_Rev1	<b>Dates of Test:</b> Nov. 22, 2012 to Mar. 04, 2013, and April 05, 2013

The following measurements were performed on product RFL111LW.

**WCDMA Band 5 results: channels 4132, 4182 and 4233 @ 20°C maximum transmitted power**

Traffic Channel Number	WCDMA Band 5 Frequency (MHz)	Voltage (Volts)	Temperature (Celsius)	Frequency Error (Hz)	PPM
4132	826.4	3.6	20	20.03	0.0242
4182	836.4	3.6	20	-6.05	-0.0072
4233	846.6	3.6	20	-7.00	-0.0083

Traffic Channel Number	WCDMA Band 5 Frequency (MHz)	Voltage (Volts)	Temperature (Celsius)	Frequency Error (Hz)	PPM
4132	826.4	4.1	20	-7.55	-0.0091
4182	836.4	4.1	20	22.38	0.0268
4233	846.6	4.1	20	-13.99	-0.0165

Traffic Channel Number	WCDMA Band 5 Frequency (MHz)	Voltage (Volts)	Temperature (Celsius)	Frequency Error (Hz)	PPM
4132	826.4	4.35	20	-6.82	-0.0083
4182	836.4	4.35	20	-10.15	-0.0121
4233	846.6	4.35	20	-6.59	-0.0078

Test Report No.: RTS-6026-1302-12A_Rev1	Dates of Test: Nov. 22, 2012 to Mar. 04, 2013, and April 05, 2013	FCC ID: L6ARFL110LW, L6ARFP120LW IC: 2503A-RFL110LW, 2503A-RFP120LW

**WCDMA Band 5 Results: channel 4132 @ maximum transmitted power**

Traffic Channel Number	Frequency (MHz)	Voltage (Volts)	Temperature (Celsius)	Frequency Error (Hz)	PPM
4132	826.4	3.6	-30	-10.44	-0.0126
4132	826.4	3.6	-20	-3.24	-0.0039
4132	826.4	3.6	-10	12.39	0.0150
4132	826.4	3.6	0	-5.40	-0.0065
4132	826.4	3.6	10	-6.67	-0.0081
4132	826.4	3.6	20	20.03	0.0242
4132	826.4	3.6	30	-13.02	-0.0158
4132	826.4	3.6	40	18.19	0.0220
4132	826.4	3.6	50	17.80	0.0215
4132	826.4	3.6	60	-3.49	-0.0042
Traffic Channel Number	Frequency (MHz)	Voltage (Volts)	Temperature (Celsius)	Frequency Error (Hz)	PPM
4132	826.4	4.1	-30	18.21	0.0220
4132	826.4	4.1	-20	-4.88	-0.0059
4132	826.4	4.1	-10	-4.16	-0.0050
4132	826.4	4.1	0	-4.29	-0.0052
4132	826.4	4.1	10	17.38	0.0210
4132	826.4	4.1	20	-7.55	-0.0091
4132	826.4	4.1	30	-2.29	-0.0028
4132	826.4	4.1	40	-1.58	-0.0019
4132	826.4	4.1	50	-2.60	-0.0031
4132	826.4	4.1	60	26.39	0.0319
Traffic Channel Number	Frequency (MHz)	Voltage (Volts)	Temperature (Celsius)	Frequency Error (Hz)	PPM
4132	826.4	4.35	-30	-14.15	-0.0171
4132	826.4	4.35	-20	-6.01	-0.0073
4132	826.4	4.35	-10	-4.05	-0.0049
4132	826.4	4.35	0	-6.05	-0.0073
4132	826.4	4.35	10	19.22	0.0233
4132	826.4	4.35	20	-6.82	-0.0083
4132	826.4	4.35	30	-3.20	-0.0039
4132	826.4	4.35	40	17.04	0.0206
4132	826.4	4.35	50	20.31	0.0246
4132	826.4	4.35	60	-5.66	-0.0068

**Test Report No.:**  
 RTS-6026-1302-12A\_Rev1

**Dates of Test:**  
 Nov. 22, 2012 to Mar. 04, 2013,  
 and April 05, 2013

**FCC ID:** L6ARFL110LW, L6ARFP120LW  
**IC:** 2503A-RFL110LW, 2503A-RFP120LW

## WCDMA Band 5 Results: channel 4182 @ maximum transmitted power


Traffic Channel Number	Frequency (MHz)	Voltage (Volts)	Temperature (Celsius)	Frequency Error (Hz)	PPM
4182	836.4	3.6	-30	12.84	0.0154
4182	836.4	3.6	-20	18.39	0.0220
4182	836.4	3.6	-10	-7.27	-0.0087
4182	836.4	3.6	0	20.90	0.0250
4182	836.4	3.6	10	15.52	0.0186
4182	836.4	3.6	20	-6.05	-0.0072
4182	836.4	3.6	30	19.85	0.0237
4182	836.4	3.6	40	1.47	0.0018
4182	836.4	3.6	50	-0.26	-0.0003
4182	836.4	3.6	60	<b>32.37</b>	<b>0.0387</b>
Traffic Channel Number	Frequency (MHz)	Voltage (Volts)	Temperature (Celsius)	Frequency Error (Hz)	PPM
4182	836.4	4.1	-30	10.93	0.0131
4182	836.4	4.1	-20	-6.79	-0.0081
4182	836.4	4.1	-10	-8.06	-0.0096
4182	836.4	4.1	0	17.62	0.0211
4182	836.4	4.1	10	-6.23	-0.0074
4182	836.4	4.1	20	22.38	0.0268
4182	836.4	4.1	30	14.23	0.0170
4182	836.4	4.1	40	19.46	0.0233
4182	836.4	4.1	50	19.27	0.0230
4182	836.4	4.1	60	-7.77	-0.0093
Traffic Channel Number	Frequency (MHz)	Voltage (Volts)	Temperature (Celsius)	Frequency Error (Hz)	PPM
4182	836.4	4.35	-30	12.50	0.0149
4182	836.4	4.35	-20	14.07	0.0168
4182	836.4	4.35	-10	13.52	0.0162
4182	836.4	4.35	0	16.23	0.0194
4182	836.4	4.35	10	-7.92	-0.0095
4182	836.4	4.35	20	-10.15	-0.0121
4182	836.4	4.35	30	19.95	0.0239
4182	836.4	4.35	40	-3.48	-0.0042
4182	836.4	4.35	50	-5.51	-0.0066
4182	836.4	4.35	60	31.83	0.0381

Test Report No.: RTS-6026-1302-12A_Rev1	Dates of Test: Nov. 22, 2012 to Mar. 04, 2013, and April 05, 2013	FCC ID: L6ARFL110LW, L6ARFP120LW IC: 2503A-RFL110LW, 2503A-RFP120LW

**WCDMA Band 5 Results: channel 4233 @ maximum transmitted power**

Traffic Channel Number	Frequency (MHz)	Voltage (Volts)	Temperature (Celsius)	Frequency Error (Hz)	PPM
4233	846.6	3.6	-30	14.85	0.0175
4233	846.6	3.6	-20	-5.30	-0.0063
4233	846.6	3.6	-10	-12.68	-0.0150
4233	846.6	3.6	0	17.22	0.0203
4233	846.6	3.6	10	-6.57	-0.0078
4233	846.6	3.6	20	-7.00	-0.0083
4233	846.6	3.6	30	13.16	0.0155
4233	846.6	3.6	40	17.30	0.0204
4233	846.6	3.6	50	21.71	0.0256
4233	846.6	3.6	60	-7.33	-0.0087
Traffic Channel Number	Frequency (MHz)	Voltage (Volts)	Temperature (Celsius)	Frequency Error (Hz)	PPM
4233	846.6	4.1	-30	16.56	0.0196
4233	846.6	4.1	-20	16.68	0.0197
4233	846.6	4.1	-10	20.45	0.0242
4233	846.6	4.1	0	20.46	0.0242
4233	846.6	4.1	10	16.83	0.0199
4233	846.6	4.1	20	-13.99	-0.0165
4233	846.6	4.1	30	-6.34	-0.0075
4233	846.6	4.1	40	-1.93	-0.0023
4233	846.6	4.1	50	-1.25	-0.0015
4233	846.6	4.1	60	-9.56	-0.0113
Traffic Channel Number	Frequency (MHz)	Voltage (Volts)	Temperature (Celsius)	Frequency Error (Hz)	PPM
4233	846.6	4.35	-30	-6.73	-0.0079
4233	846.6	4.35	-20	-6.80	-0.0080
4233	846.6	4.35	-10	16.50	0.0195
4233	846.6	4.35	0	18.29	0.0216
4233	846.6	4.35	10	18.23	0.0215
4233	846.6	4.35	20	-6.59	-0.0078
4233	846.6	4.35	30	16.35	0.0193
4233	846.6	4.35	40	-7.35	-0.0087
4233	846.6	4.35	50	-4.31	-0.0051
4233	846.6	4.35	60	-3.30	-0.0039



	EMI Test Report for the BlackBerry® smartphone Model RFL111LW, RFP121LW <b>APPENDIX 2B</b>	
	<b>Test Report No.:</b> RTS-6026-1302-12A_Rev1	<b>Dates of Test:</b> Nov. 22, 2012 to Mar. 04, 2013, and April 05, 2013

**WCDMA Band 2 results: channels 9262, 9400, & 9538 @ 20°C maximum transmitted power**

Traffic Channel Number	WCDMA1900 Frequency (MHz)	Voltage (Volts)	Temperature (Celsius)	Frequency Error (Hz)	PPM
9262	1852.40	3.6	20	17.53	0.0095
9400	1880.00	3.6	20	-7.61	-0.0040
9538	1907.60	3.6	20	-11.91	-0.0062

Traffic Channel Number	WCDMA1900 Frequency (MHz)	Voltage (Volts)	Temperature (Celsius)	Frequency Error (Hz)	PPM
9262	1852.40	4.1	20	-8.49	-0.0046
9400	1880.00	4.1	20	14.25	0.0076
9538	1907.60	4.1	20	-13.63	-0.0071

Traffic Channel Number	WCDMA1900 Frequency (MHz)	Voltage (Volts)	Temperature (Celsius)	Frequency Error (Hz)	PPM
9262	1852.40	4.35	20	-9.12	-0.0049
9400	1880.00	4.35	20	-10.37	-0.0055
9538	1907.60	4.35	20	-13.71	-0.0072

Test Report No.: RTS-6026-1302-12A_Rev1	Dates of Test: Nov. 22, 2012 to Mar. 04, 2013, and April 05, 2013	FCC ID: L6ARFL110LW, L6ARFP120LW IC: 2503A-RFL110LW, 2503A-RFP120LW

**WCDMA Band 2 Results: channel 9262 @ maximum transmitted power**

Traffic Channel Number	Frequency (MHz)	Voltage (Volts)	Temperature (Celsius)	Frequency Error (Hz)	PPM
9262	1852.40	3.6	-30	-10.90	-0.0059
9262	1852.40	3.6	-20	-3.42	-0.0018
9262	1852.40	3.6	-10	15.82	0.0085
9262	1852.40	3.6	0	-6.96	-0.0038
9262	1852.40	3.6	10	-8.10	-0.0044
9262	1852.40	3.6	20	17.53	0.0095
9262	1852.40	3.6	30	-16.41	-0.0089
9262	1852.40	3.6	40	12.14	0.0066
9262	1852.40	3.6	50	10.90	0.0059
9262	1852.40	3.6	60	-6.37	-0.0034
Traffic Channel Number	Frequency (MHz)	Voltage (Volts)	Temperature (Celsius)	Frequency Error (Hz)	PPM
9262	1852.40	4.1	-30	17.68	0.0095
9262	1852.40	4.1	-20	-7.49	-0.0040
9262	1852.40	4.1	-10	-11.24	-0.0061
9262	1852.40	4.1	0	-7.55	-0.0041
9262	1852.40	4.1	10	15.91	0.0086
9262	1852.40	4.1	20	-8.49	-0.0046
9262	1852.40	4.1	30	-5.32	-0.0029
9262	1852.40	4.1	40	-9.65	-0.0052
9262	1852.40	4.1	50	-9.69	-0.0052
9262	1852.40	4.1	60	27.35	0.0148
Traffic Channel Number	Frequency (MHz)	Voltage (Volts)	Temperature (Celsius)	Frequency Error (Hz)	PPM
9262	1852.40	4.35	-30	-13.77	-0.0074
9262	1852.40	4.35	-20	-6.89	-0.0037
9262	1852.40	4.35	-10	-12.75	-0.0069
9262	1852.40	4.35	0	-9.10	-0.0049
9262	1852.40	4.35	10	18.90	0.0102
9262	1852.40	4.35	20	-9.12	-0.0049
9262	1852.40	4.35	30	-3.90	-0.0021
9262	1852.40	4.35	40	18.50	0.0100
9262	1852.40	4.35	50	17.39	0.0094
9262	1852.40	4.35	60	-10.90	-0.0059

**Test Report No.:**  
 RTS-6026-1302-12A\_Rev1

**Dates of Test:**  
 Nov. 22, 2012 to Mar. 04, 2013,  
 and April 05, 2013

**FCC ID:** L6ARFL110LW, L6ARFP120LW  
**IC:** 2503A-RFL110LW, 2503A-RFP120LW


**WCDMA Band 2 Results: channel 9400 @ maximum transmitted power**

Traffic Channel Number	Frequency (MHz)	Voltage (Volts)	Temperature (Celsius)	Frequency Error (Hz)	PPM
9400	1880.00	3.6	-30	13.58	0.0072
9400	1880.00	3.6	-20	15.19	0.0081
9400	1880.00	3.6	-10	-11.42	-0.0061
9400	1880.00	3.6	0	19.37	0.0103
9400	1880.00	3.6	10	12.62	0.0067
9400	1880.00	3.6	20	-7.61	-0.0040
9400	1880.00	3.6	30	15.04	0.0080
9400	1880.00	3.6	40	-5.39	-0.0029
9400	1880.00	3.6	50	-4.63	-0.0025
9400	1880.00	3.6	60	<b>29.00</b>	<b>0.0154</b>
Traffic Channel Number	Frequency (MHz)	Voltage (Volts)	Temperature (Celsius)	Frequency Error (Hz)	PPM
9400	1880.00	4.1	-30	11.55	0.0061
9400	1880.00	4.1	-20	-8.48	-0.0045
9400	1880.00	4.1	-10	-8.64	-0.0046
9400	1880.00	4.1	0	13.61	0.0072
9400	1880.00	4.1	10	-8.85	-0.0047
9400	1880.00	4.1	20	14.25	0.0076
9400	1880.00	4.1	30	16.54	0.0088
9400	1880.00	4.1	40	17.70	0.0094
9400	1880.00	4.1	50	16.01	0.0085
9400	1880.00	4.1	60	-11.05	-0.0059
Traffic Channel Number	Frequency (MHz)	Voltage (Volts)	Temperature (Celsius)	Frequency Error (Hz)	PPM
9400	1880.00	4.35	-30	10.02	0.0053
9400	1880.00	4.35	-20	11.79	0.0063
9400	1880.00	4.35	-10	10.12	0.0054
9400	1880.00	4.35	0	10.41	0.0055
9400	1880.00	4.35	10	-8.92	-0.0047
9400	1880.00	4.35	20	-10.37	-0.0055
9400	1880.00	4.35	30	12.39	0.0066
9400	1880.00	4.35	40	-5.77	-0.0031
9400	1880.00	4.35	50	-10.16	-0.0054
9400	1880.00	4.35	60	28.06	0.0149

Test Report No.: RTS-6026-1302-12A_Rev1	Dates of Test: Nov. 22, 2012 to Mar. 04, 2013, and April 05, 2013	FCC ID: L6ARFL110LW, L6ARFP120LW IC: 2503A-RFL110LW, 2503A-RFP120LW

**WCDMA Band 2 Results: channel 9538 @ maximum transmitted power**

Traffic Channel Number	Frequency (MHz)	Voltage (Volts)	Temperature (Celsius)	Frequency Error (Hz)	21BPPM
9538	1907.60	3.6	-30	15.21	0.0080
9538	1907.60	3.6	-20	-6.58	-0.0034
9538	1907.60	3.6	-10	-10.71	-0.0056
9538	1907.60	3.6	0	16.73	0.0088
9538	1907.60	3.6	10	-8.90	-0.0047
9538	1907.60	3.6	20	-11.91	-0.0062
9538	1907.60	3.6	30	15.02	0.0079
9538	1907.60	3.6	40	16.17	0.0085
9538	1907.60	3.6	50	15.40	0.0081
9538	1907.60	3.6	60	-8.58	-0.0045
Traffic Channel Number	Frequency (MHz)	Voltage (Volts)	Temperature (Celsius)	Frequency Error (Hz)	PPM
9538	1907.60	4.1	-30	12.51	0.0066
9538	1907.60	4.1	-20	11.69	0.0061
9538	1907.60	4.1	-10	15.44	0.0081
9538	1907.60	4.1	0	15.41	0.0081
9538	1907.60	4.1	10	14.17	0.0074
9538	1907.60	4.1	20	-13.63	-0.0071
9538	1907.60	4.1	30	-8.35	-0.0044
9538	1907.60	4.1	40	-2.73	-0.0014
9538	1907.60	4.1	50	-6.25	-0.0033
9538	1907.60	4.1	60	-12.33	-0.0065
Traffic Channel Number	Frequency (MHz)	Voltage (Volts)	Temperature (Celsius)	Frequency Error (Hz)	21BPPM
9538	1907.60	4.35	-30	-11.43	-0.0060
9538	1907.60	4.35	-20	-8.59	-0.0045
9538	1907.60	4.35	-10	11.34	0.0059
9538	1907.60	4.35	0	12.62	0.0066
9538	1907.60	4.35	10	17.72	0.0093
9538	1907.60	4.35	20	-13.71	-0.0072
9538	1907.60	4.35	30	12.65	0.0066
9538	1907.60	4.35	40	-9.09	-0.0048
9538	1907.60	4.35	50	-12.53	-0.0066
9538	1907.60	4.35	60	-9.80	-0.0051

	EMI Test Report for the BlackBerry® smartphone Model RFL111LW, RFP121LW <b>APPENDIX 2B</b>	
	<b>Test Report No.:</b> RTS-6026-1302-12A_Rev1	<b>Dates of Test:</b> Nov. 22, 2012 to Mar. 04, 2013, and April 05, 2013

The following measurements were performed on product RFP121LW.

**WCDMA Band 4 results: channels 1312, 1412, & 1513 @ 20°C maximum transmitted power**

Traffic Channel Number	Frequency (MHz)	Voltage (Volts)	Temperature (Celsius)	Frequency Error (Hz)	PPM
1312	1712.40	3.6	20	24.12	0.0141
1412	1732.60	3.6	20	-1.25	-0.0007
1513	1752.60	3.6	20	-1.87	-0.0012

Traffic Channel Number	Frequency (MHz)	Voltage (Volts)	Temperature (Celsius)	Frequency Error (Hz)	PPM
1312	1712.40	4.1	20	-5.77	-0.0034
1412	1732.60	4.1	20	24.67	0.0142
1513	1752.60	4.1	20	-10.09	-0.0067

Traffic Channel Number	Frequency (MHz)	Voltage (Volts)	Temperature (Celsius)	Frequency Error (Hz)	PPM
1312	1712.40	4.35	20	-2.55	-0.0015
1412	1732.60	4.35	20	-5.92	-0.0034
1513	1752.60	4.35	20	-3.52	-0.0023

Test Report No.: RTS-6026-1302-12A_Rev1	Dates of Test: Nov. 22, 2012 to Mar. 04, 2013, and April 05, 2013	FCC ID: L6ARFL110LW, L6ARFP120LW IC: 2503A-RFL110LW, 2503A-RFP120LW

**WCDMA Band 4 Results: channel 1312 @ maximum transmitted power**

Traffic Channel Number	Frequency (MHz)	Voltage (Volts)	Temperature (Celsius)	Frequency Error (Hz)	PPM
1312	1712.40	3.6	-30	-7.47	-0.0044
1312	1712.40	3.6	-20	1.20	0.0007
1312	1712.40	3.6	-10	14.97	0.0087
1312	1712.40	3.6	0	-0.18	-0.0001
1312	1712.40	3.6	10	-15.47	-0.0090
1312	1712.40	3.6	20	24.12	0.0141
1312	1712.40	3.6	30	-11.38	-0.0066
1312	1712.40	3.6	40	20.53	0.0120
1312	1712.40	3.6	50	21.45	0.0125
1312	1712.40	3.6	60	15.60	0.0091
Traffic Channel Number	Frequency (MHz)	Voltage (Volts)	Temperature (Celsius)	Frequency Error (Hz)	PPM
1312	1712.40	4.1	-30	22.04	0.0129
1312	1712.40	4.1	-20	-0.90	-0.0005
1312	1712.40	4.1	-10	-26.34	-0.0154
1312	1712.40	4.1	0	-12.53	-0.0073
1312	1712.40	4.1	10	22.89	0.0134
1312	1712.40	4.1	20	-5.77	-0.0034
1312	1712.40	4.1	30	-6.30	-0.0037
1312	1712.40	4.1	40	19.88	0.0116
1312	1712.40	4.1	50	0.72	0.0004
1312	1712.40	4.1	60	<b>30.29</b>	<b>0.0177</b>
Traffic Channel Number	Frequency (MHz)	Voltage (Volts)	Temperature (Celsius)	Frequency Error (Hz)	PPM
1312	1712.40	4.35	-30	-11.32	-0.0066
1312	1712.40	4.35	-20	-3.98	-0.0023
1312	1712.40	4.35	-10	-0.02	0.0000
1312	1712.40	4.35	0	-2.75	-0.0016
1312	1712.40	4.35	10	23.27	0.0136
1312	1712.40	4.35	20	-2.55	-0.0015
1312	1712.40	4.35	30	3.02	0.0018
1312	1712.40	4.35	40	20.77	0.0121
1312	1712.40	4.35	50	25.52	0.0149
1312	1712.40	4.35	60	-1.84	-0.0011

**Test Report No.:**  
 RTS-6026-1302-12A\_Rev1

**Dates of Test:**  
 Nov. 22, 2012 to Mar. 04, 2013,  
 and April 05, 2013

**FCC ID:** L6ARFL110LW, L6ARFP120LW  
**IC:** 2503A-RFL110LW, 2503A-RFP120LW

**WCDMA Band 4 Results: channel 1412 @ maximum transmitted power**

Traffic Channel Number	Frequency (MHz)	Voltage (Volts)	Temperature (Celsius)	Frequency Error (Hz)	PPM
1413	1732.60	3.6	-30	18.13	0.0105
1413	1732.60	3.6	-20	21.28	0.0123
1413	1732.60	3.6	-10	-4.01	-0.0023
1413	1732.60	3.6	0	25.87	0.0149
1413	1732.60	3.6	10	16.93	0.0098
1413	1732.60	3.6	20	-1.25	-0.0007
1413	1732.60	3.6	30	23.87	0.0138
1413	1732.60	3.6	40	4.98	0.0029
1413	1732.60	3.6	50	5.30	0.0031
1413	1732.60	3.6	60	27.14	0.0157
Traffic Channel Number	Frequency (MHz)	Voltage (Volts)	Temperature (Celsius)	Frequency Error (Hz)	PPM
1413	1732.60	4.1	-30	14.23	0.0082
1413	1732.60	4.1	-20	-3.94	-0.0023
1413	1732.60	4.1	-10	-2.29	-0.0013
1413	1732.60	4.1	0	20.96	0.0121
1413	1732.60	4.1	10	-4.38	-0.0025
1413	1732.60	4.1	20	24.67	0.0142
1413	1732.60	4.1	30	17.73	0.0102
1413	1732.60	4.1	40	21.63	0.0125
1413	1732.60	4.1	50	22.10	0.0128
1413	1732.60	4.1	60	-6.23	-0.0036
Traffic Channel Number	Frequency (MHz)	Voltage (Volts)	Temperature (Celsius)	Frequency Error (Hz)	PPM
1413	1732.60	4.35	-30	13.40	0.0077
1413	1732.60	4.35	-20	15.38	0.0089
1413	1732.60	4.35	-10	16.37	0.0094
1413	1732.60	4.35	0	19.01	0.0110
1413	1732.60	4.35	10	-4.01	-0.0023
1413	1732.60	4.35	20	-5.92	-0.0034
1413	1732.60	4.35	30	23.79	0.0137
1413	1732.60	4.35	40	16.42	0.0095
1413	1732.60	4.35	50	-2.64	-0.0015
1413	1732.60	4.35	60	25.80	0.0149


Test Report No.: RTS-6026-1302-12A_Rev1	Dates of Test: Nov. 22, 2012 to Mar. 04, 2013, and April 05, 2013	FCC ID: L6ARFL110LW, L6ARFP120LW IC: 2503A-RFL110LW, 2503A-RFP120LW

**WCDMA Band 4 Results: channel 1513 @ maximum transmitted power**

Traffic Channel Number	Frequency (MHz)	Voltage (Volts)	Temperature (Celsius)	Frequency Error (Hz)	PPM
1513	1752.60	3.6	-30	18.34	0.0121
1513	1752.60	3.6	-20	-1.09	-0.0007
1513	1752.60	3.6	-10	-11.11	-0.0073
1513	1752.60	3.6	0	21.45	0.0142
1513	1752.60	3.6	10	-3.29	-0.0022
1513	1752.60	3.6	20	-1.87	-0.0012
1513	1752.60	3.6	30	17.12	0.0113
1513	1752.60	3.6	40	20.46	0.0135
1513	1752.60	3.6	50	26.90	0.0178
1513	1752.60	3.6	60	-2.76	-0.0018
Traffic Channel Number	Frequency (MHz)	Voltage (Volts)	Temperature (Celsius)	Frequency Error (Hz)	PPM
1513	1752.60	4.1	-30	18.93	0.0125
1513	1752.60	4.1	-20	20.84	0.0138
1513	1752.60	4.1	-10	22.14	0.0146
1513	1752.60	4.1	0	24.69	0.0163
1513	1752.60	4.1	10	19.48	0.0129
1513	1752.60	4.1	20	-10.09	-0.0067
1513	1752.60	4.1	30	-1.36	-0.0009
1513	1752.60	4.1	40	3.02	0.0020
1513	1752.60	4.1	50	0.43	0.0003
1513	1752.60	4.1	60	-6.20	-0.0041
Traffic Channel Number	Frequency (MHz)	Voltage (Volts)	Temperature (Celsius)	Frequency Error (Hz)	PPM
1513	1752.60	4.35	-30	-2.54	-0.0017
1513	1752.60	4.35	-20	-2.02	-0.0013
1513	1752.60	4.35	-10	17.03	0.0113
1513	1752.60	4.35	0	21.22	0.0140
1513	1752.60	4.35	10	22.92	0.0151
1513	1752.60	4.35	20	-3.52	-0.0023
1513	1752.60	4.35	30	20.27	0.0134
1513	1752.60	4.35	40	-2.20	-0.0015
1513	1752.60	4.35	50	-1.59	-0.0011
1513	1752.60	4.35	60	1.72	0.0011



APPENDIX 2C – WCDMA Band 2/4/5 RADIATED EMISSIONS TEST DATA

	EMI Test Report for the BlackBerry® smartphone Model RFL111LW, RFP121LW <b>APPENDIX 2C</b>		
	<b>Test Report No.:</b> RTS-6026-1302-12A_Rev1	<b>Dates of Test:</b> Nov. 22, 2012 to Mar. 04, 2013, and April 05, 2013	<b>FCC ID:</b> L6ARFL110LW, L6ARFP120LW <b>IC:</b> 2503A-RFL110LW, 2503A-RFP120LW

### Radiated Power Test Data Results

The following measurements were performed on product RFL111LW.

Date of Test: December 17, 2012

The following measurements were performed by Feras Obeid.

The environmental tests conditions were: Temperature: 25.0 °C  
Relative Humidity: 29.5 %

The EUT was standalone, USB port pointing up with LCD facing the RX antenna when the turntable is at 0 degree position.


Test Distance was 3.0 meters with the RX antenna height scans between 1-4 meters height.

#### WCDMA Band 5 Voice Mode

EUT				Rx Antenna		Spectrum Analyzer		Substitution Method					
Type	Ch	Frequency (MHz)	Band	Type	Pol.	Reading (dBm)	Max (V,H) (dBm)	Tracking Generator		Corrected Reading (relative to Dipole)		Limit (dBm)	Diff. To Limit (dB)
								Pol.	Reading (dBm)	(dBm)	(W)		
F0	4132	826.40	5	Dipole	V	-37.35	-30.16	V-V	4.93	22.04	0.16	38.5	-16.46
F0	4132	826.40	5	Dipole	H	-30.16		H-H	3.10				
F0	4182	836.40	5	Dipole	V	-37.78	-29.91	V-V	5.47	22.28	0.17	38.5	-16.22
F0	4182	836.40	5	Dipole	H	-29.91		H-H	4.08				
F0	4233	846.60	5	Dipole	V	-37.35	-29.73	V-V	6.17	<b>22.99</b>	<b>0.20</b>	38.5	-15.51
F0	4233	846.60	5	Dipole	H	-29.73		H-H	5.43				

#### WCDMA Band 5 HSUPA Mode

EUT				Rx Antenna		Spectrum Analyzer		Substitution Method					
Type	Ch	Frequency (MHz)	Band	Type	Pol.	Reading (dBuV)	Max (V,H) (dBuV)	Tracking Generator		Corrected Reading (relative to Dipole)		Limit (dBm)	Diff. To Limit (dB)
								Pol.	Reading (dBm)	(dBm)	(W)		
F0	4132	826.40	5	Dipole	V	-37.81	-30.84	V-V	4.20	21.31	0.14	38.50	17.19
F0	4132	826.40	5	Dipole	H	-30.84		H-H	2.30				
F0	4182	836.40	5	Dipole	V	-38.84	-31.59	V-V	3.73	20.54	0.11	38.50	17.96
F0	4182	836.40	5	Dipole	H	-31.59		H-H	2.34				
F0	4233	846.60	5	Dipole	V	-38.92	-30.91	V-V	4.91	<b>21.73</b>	<b>0.15</b>	38.50	16.77
F0	4233	846.60	5	Dipole	H	-30.91		H-H	4.24				

	EMI Test Report for the BlackBerry® smartphone Model RFL111LW, RFP121LW <b>APPENDIX 2C</b>		
<b>Test Report No.:</b> RTS-6026-1302-12A_Rev1	<b>Dates of Test:</b> Nov. 22, 2012 to Mar. 04, 2013, and April 05, 2013	<b>FCC ID:</b> L6ARFL110LW, L6ARFP120LW <b>IC:</b> 2503A-RFL110LW, 2503A-RFP120LW	

### Radiated Power Test Data Results cont'd

Date of Test: December 17, 2012

The following measurements were performed by Feras Obeid.

The environmental test conditions were:    Temperature:            25.0 °C  
  Relative Humidity:       29.5 %

The EUT was standalone, USB port point down with LCD facing the RX antenna when the turntable is at 0 degree position.


Test Distance was 3.0 meters with the RX antenna height scans between 1-4 meters height.

#### **WCDMA Band 2 Voice Mode**

EUT						Rx Antenna		Spectrum Analyzer		Substitution Method			
EUT						Rx Antenna		Spectrum Analyzer		Tracking Generator			
Type	Ch	Frequency (MHz)	Band	Type	Pol.	Reading (dBm)	Max (V,H) (dBm)	Pol.	Reading (dBm)	Corrected Reading (relative to Isotropic radiator)		Limit (dBm)	Diff to Limit (dB)
								Tx-Rx		(dBm)	(W)		
F0	9262	1852.40	2	Horn	V	-26.23	-26.23	V-V	-16.47	<b>23.77</b>	<b>0.24</b>	33.0	9.23
F0	9262	1852.40	2	Horn	H	-32.87		H-H	-15.57				
F0	9400	1880.00	2	Horn	V	-27.37	-27.37	V-V	-16.80	23.00	0.20	33.0	10.00
F0	9400	1880.00	2	Horn	H	-31.93		H-H	-15.99				
F0	9538	1907.60	2	Horn	V	-28.43	-28.43	V-V	-18.04	21.73	0.15	33.0	11.27
F0	9538	1907.60	2	Horn	H	-32.23		H-H	-17.15				

#### **WCDMA Band 2 HSUPA Mode**

EUT						Rx Antenna		Spectrum Analyzer		Substitution Method			
EUT						Rx Antenna		Spectrum Analyzer		Tracking Generator			
Type	Ch	Frequency (MHz)	Band	Type	Pol.	Reading (dBuV)	Max (V,H) (dBuV)	Pol.	Reading (dBm)	Corrected Reading (relative to Isotropic Radiator)		Limit (dBm)	Diff to Limit (dB)
								Tx-Rx		(dBm)	(W)		
F0	9262	1852.40	2	Horn	V	-26.71	-26.71	V-V	-16.93	<b>23.27</b>	<b>0.21</b>	33.0	9.73
F0	9262	1852.40	2	Horn	H	-32.56		H-H	-16.07				
F0	9400	1880.00	2	Horn	V	-27.62	-27.62	V-V	-17.02	22.71	0.19	33.0	10.29
F0	9400	1880.00	2	Horn	H	-33.76		H-H	-16.28				
F0	9538	1907.60	2	Horn	V	-28.68	-28.68	V-V	-18.31	21.48	0.14	33.0	11.52
F0	9538	1907.60	2	Horn	H	-33.41		H-H	-17.40				

	EMI Test Report for the BlackBerry® smartphone Model RFL111LW, RFP121LW	
	<b>APPENDIX 2C</b>	
<b>Test Report No.:</b> RTS-6026-1302-12A_Rev1	<b>Dates of Test:</b> Nov. 22, 2012 to Mar. 04, 2013, and April 05, 2013	<b>FCC ID:</b> L6ARFL110LW, L6ARFP120LW <b>IC:</b> 2503A-RFL110LW, 2503A-RFP120LW

Radiated Emissions Test Data Results cont'd

**WCDMA Band 5 Voice Mode**

Date of Test: December 05, 2012

The following measurements were performed by Savtej Sandhu.

The environmental test conditions were:   Temperature:        24.1°C  
Relative Humidity:      17.4 %

The EUT was standalone, USB jack pointing down with LCD facing the RX antenna when the turntable is at 0 degree position.

Test Distance was 3.0 meters with the RX antenna height scans between 1-4 meters height, and the frequency range scanned was 30MHz – 1GHz.

Measurements were performed in WCDMA band 5 Voice mode on channels 4132, 4182, and 4233.

All emissions were at least 25.0 dB below the limit.

Date of Test: December 05, 2012 to January 03, 2013

The following measurements were performed by Heng Lin

The environmental test conditions were:   Temperature:        23.2 - 25.4 °C  
Relative Humidity:      18.4 - 22.3 %


Test Distance was 3.0 meters with the RX antenna height scans between 1-4 meters height, and a frequency range of 1 GHz to 9 GHz.

The EUT was standalone, USB jack pointing up with LCD facing the RX antenna when the turntable is at 0 degree position.

Measurements were performed in WCDMA Band 5 Voice mode on channels 4132, 4182, and 4233.

All emissions were at least 25.0 dB below the limit.



	EMI Test Report for the BlackBerry <sup>®</sup> smartphone Model RFL111LW, RFP121LW <b>APPENDIX 2C</b>	
<b>Test Report No.:</b> RTS-6026-1302-12A_Rev1	<b>Dates of Test:</b> Nov. 22, 2012 to Mar. 04, 2013, and April 05, 2013	<b>FCC ID:</b> L6ARFL110LW, L6ARFP120LW <b>IC:</b> 2503A-RFL110LW, 2503A-RFP120LW

**Radiated Emissions Test Data Results cont'd**

**WCDMA Band 2 Voice mode**

Date of Test: December 05, 2012

The environmental test conditions were:      Temperature:            24.1 - 25.3 °C  
Relative Humidity:            27.7 – 32.3 %

The EUT was standalone, with USB jack pointing down and LCD facing the RX antenna when the turntable is at 0 degree position.

Test Distance was 3.0 meters with the RX antenna height scans between 1-4 meters height, and the frequency range scanned was 30MHz – 1GHz.

Measurements were performed in WCDMA Band 2 Voice mode on channels 9262, 9400, and 9538.

All emissions were at least 25.0 dB below the limit.

Date of Test: December 14, 2012 to January 18, 2013

The environmental test conditions were:      Temperature:            23.2 - 25.4 °C  
Relative Humidity:            37.6 - 41.7 %


Test Distance was 3.0 meters with the RX antenna height scans between 1-4 meters height, and a frequency range of 1GHz to 20 GHz.

The EUT was standalone vertically with LCD facing the RX antenna when the turntable is at 0 degree position.

Measurements were performed in WCDMA Band 2 Voice mode on channels 9262, 9400, 9538.

All emissions were at least 25.0 dB below the limit.



	EMI Test Report for the BlackBerry® smartphone Model RFL111LW, RFP121LW <b>APPENDIX 2C</b>		
	<b>Test Report No.:</b> RTS-6026-1302-12A_Rev1	<b>Dates of Test:</b> Nov. 22, 2012 to Mar. 04, 2013, and April 05, 2013	<b>FCC ID:</b> L6ARFL110LW, L6ARFP120LW <b>IC:</b> 2503A-RFL110LW, 2503A-RFP120LW

### Radiated Emissions Test Data Results cont'd

The following measurements were performed on RFP121LW:

Date of Test: January 28, 2013

The following measurements were performed by Savtej Sandhu.

The environmental tests conditions were: Temperature: 25.0 °C  
Relative Humidity: 17.3 %

The EUT was standalone, horizontally with LCD facing down and the top pointing to the RX antenna when the turntable is at 0 degree position.

Test Distance was 3.0 meters with the RX antenna height scans between 1-4 meters height.

#### WCDMA Band 5 Voice Mode

EUT				Rx Antenna		Spectrum Analyzer		Substitution Method					
Type	Ch	Frequency (MHz)	Band	Type	Pol.	Reading (dBm)	Max (V,H) (dBm)	Tracking Generator		Corrected Reading (relative to Dipole)		Limit (dBm)	Diff. To Limit (dB)
								Pol.	Reading (dBm)	(dBm)	(W)		
F0	4132	826.40	5	Dipole	V	-38.55	-28.83	V-V	5.48	22.59	0.18	38.5	-15.91
F0	4132	826.40	5	Dipole	H	-28.83		H-H	4.76				
F0	4182	836.40	5	Dipole	V	-39.17	-29.63	V-V	6.03	22.84	0.19	38.5	-15.66
F0	4182	836.40	5	Dipole	H	-29.63		H-H	4.23				
F0	4233	846.60	5	Dipole	V	-38.36	-29.56	V-V	6.88	<b>23.70</b>	<b>0.23</b>	38.5	-14.80
F0	4233	846.60	5	Dipole	H	-29.56		H-H	4.92				

#### WCDMA Band 5 HSUPA Mode

EUT				Rx Antenna		Spectrum Analyzer		Substitution Method					
Type	Ch	Frequency (MHz)	Band	Type	Pol.	Reading (dBuV)	Max (V,H) (dBuV)	Tracking Generator		Corrected Reading (relative to Dipole)		Limit (dBm)	Diff. To Limit (dB)
								Pol.	Reading (dBm)	(dBm)	(W)		
F0	4132	826.40	5	Dipole	V	-40.27	-30.34	V-V	3.96	21.07	0.13	38.50	17.43
F0	4132	826.40	5	Dipole	H	-30.34		H-H	3.25				
F0	4182	836.40	5	Dipole	V	-40.37	-31.06	V-V	4.59	21.40	0.14	38.50	17.10
F0	4182	836.40	5	Dipole	H	-31.06		H-H	2.78				
F0	4233	846.60	5	Dipole	V	-39.78	-31.24	V-V	5.19	<b>22.01</b>	<b>0.16</b>	38.50	16.49
F0	4233	846.60	5	Dipole	H	-31.24		H-H	3.21				

This report shall NOT be reproduced except in full without the written consent of RIM Testing Services  
- A division of Research in Motion Limited.






















## APPENDIX 3A– LTE Band 2 CONDUCTED RF EMISSIONS TEST DATA/PLOTS



	EMI Test Report for the BlackBerry® smartphone Model RFL111LW, RFP121LW <b>APPENDIX 3A</b>	
	<b>Test Report No.:</b> RTS-6026-1302-12A_Rev1	<b>Dates of Test:</b> Nov. 22, 2012 to Mar. 04, 2013, and April 05, 2013


LTE Band 2 Conducted RF Emission Test Data cont'd

**Emission Designator Table for product model RFL111LW**

Frequency Rane (MHz)	Conducted Output Power (dBm)	Emission Designator	Band	Bandwidth (MHz)	Modulation
1850.7-1909.3	22.17	1M09G7D	LTE B2	1.4	QPSK
1850.7-1909.3	20.82	1M09D7W	LTE B2	1.4	16QAM
1851.5-1908.5	21.06	2M68G7D	LTE B2	3	QPSK
1851.5-1908.5	20.12	2M68D7W	LTE B2	3	16QAM
1852.5-1907.5	21.03	4M47G7D	LTE B2	5	QPSK
1852.5-1907.5	20.1	4M47D7W	LTE B2	5	16QAM
1855-1905	22.32	8M92G7D	LTE B2	10	QPSK
1855-1905	21.06	8M44D7W	LTE B2	10	16QAM
1857.5-1902.5	22.35	13M4G7D	LTE B2	15	QPSK
1857.5-1902.5	21.15	13M4D7W	LTE B2	15	16QAM
1860-1900	22.34	17M9G7D	LTE B2	20	QPSK
1860-1900	21.00	17M9D7W	LTE B2	20	16QAM

**Emission Designator Table for product model RFP121LW**

Frequency Range (MHz)	Condcuted Output Power (dBm)	Emission Designator	Band	Bandwidth (MHz)	Modulation
1850.7-1909.3	23.08	1M08G7D	LTE B2	1.4	QPSK
1850.7-1909.3	21.96	1M08D7W	LTE B2	1.4	16QAM
1851.5-1908.5	23.11	2M68G7D	LTE B2	3	QPSK
1851.5-1908.5	22.02	2M68D7W	LTE B2	3	16QAM
1852.5-1907.5	23.17	4M47G7D	LTE B2	5	QPSK
1852.5-1907.5	22.46	4M47D7W	LTE B2	5	16QAM
1855-1905	23.18	8M92G7D	LTE B2	10	QPSK
1855-1905	21.90	8M92D7W	LTE B2	10	16QAM
1857.5-1902.5	23.10	13M4G7D	LTE B2	15	QPSK
1857.5-1902.5	22.44	13M4D7W	LTE B2	15	16QAM
1860-1900	23.23	17M8G7D	LTE B2	20	QPSK
1860-1900	21.96	17M8D7W	LTE B2	20	16QAM

	EMI Test Report for the BlackBerry® smartphone Model RFL111LW, RFP121LW	
	<b>APPENDIX 3A</b>	
<b>Test Report No.:</b> RTS-6026-1302-12A_Rev1	<b>Dates of Test:</b> Nov. 22, 2012 to Mar. 04, 2013, and April 05, 2013	<b>FCC ID:</b> L6ARFL110LW, L6ARFP120LW <b>IC:</b> 2503A-RFL110LW, 2503A-RFP120LW

**The conducted spurious emissions** – As per 47 CFR 2.1051, CFR 24.232(d), CFR 2.202, RSS - 133 were measured from 30 MHz to 20 GHz.

**–26 dBc Bandwidth and Occupied Bandwidth (99%)**

For each 1.4MHz, 3MHz, 5MHz, 10MHz, 15MHz and 20MHz with different number of resource blocks as per scalable bandwidths for LTE Band 2, the modulation spectrum was measured by both methods of 99% power bandwidth and –26 dBc bandwidth.

QPSK and 16-QAM modulations were applied to each of the bandwidths. Only the worst case measurements are documented in this report.

A minimum resource block condition was also measured (RB = 1).

The resolution bandwidth required for out-of-band emissions in the 1 MHz bands immediately outside and adjacent to the frequency block, was determined to be at least 1% of the emission bandwidth.

The worst case –26dBc bandwidth for LTE Band 2 was measured to be 18.70 MHz for product RFL111LW and 18.73 for product RFP121LW as shown below. Results were derived in a 200 kHz resolution bandwidth.

On any frequency outside the frequency block and outside the adjacent 1 MHz bands, a resolution bandwidth of at least 1 MHz was applied.


**Test Data for LTE Band 2 selected Frequencies in 20MHz bandwidth (RB = 100)**

For product RFL111LW:

LTE Band 2 Frequency (MHz)	26dBc Occupied Bandwidth (MHz)	99% Occupied Bandwidth (MHz)	
		QPSK	16QAM
1852.400	18.64	17.86	17.85
1880.000	18.70	17.86	17.83
1907.600	18.64	17.80	17.80

For product RFP121LW:

LTE Band 2 Frequency (MHz)	26dBc Occupied Bandwidth (MHz)	99% Occupied Bandwidth (MHz)	
		QPSK	16QAM
1852.400	18.73	17.89	17.83
1880.000	18.52	17.83	17.89
1907.600	18.70	17.89	17.83

	EMI Test Report for the BlackBerry® smartphone Model RFL111LW, RFP121LW <b>APPENDIX 3A</b>	
<b>Test Report No.:</b> RTS-6026-1302-12A_Rev1	<b>Dates of Test:</b> Nov. 22, 2012 to Mar. 04, 2013, and April 05, 2013	<b>FCC ID:</b> L6ARFL110LW, L6ARFP120LW <b>IC:</b> 2503A-RFL110LW, 2503A-RFP120LW

### Peak to Average Ratio (PAR)

For each 1.4MHz, 3MHz, 5MHz, 10MHz, 15MHz and 20 MHz with different number of resource blocks as per scalable bandwidths for LTE Band 2, the peak to average ratio was measured on the low, middle and high channels with QPSK and 16-QAM modulation. On any frequency outside the frequency block and outside the adjacent 1 MHz bands, a resolution bandwidth of at least 1 MHz was applied.

The worst case measured was 9.15 dB on middle channel in 20MHz bandwidth with 50 resource blocks for product RFL111LW.

The worst case measured was 9.61 dB on middle channel in 20MHz bandwidth with 100 resource blocks for product RFP121LW.

### Measurement Plots for LTE Band 2

Refer to the following measurement plots for more detail:

The following measurements were done on product RFL111LW:

See Figures 3-1a to 3-18a for the plots of the conducted spurious emissions.

See Figures 3-19a to 3-24a and 3-43a to 3-45a for the plots of 99% Occupied Bandwidth and -26 dBc Bandwidth.

See Figures 3-25a to 3-36a for the plots of the Channel mask.

See Figures 3-37a to 3-42a for the plots of the Peak to Average Ratio.


The following measurements were done on product RFP121LW:

See Figures 3-1b to 3-18b for the plots of the conducted spurious emissions.

See Figures 3-19b to 3-24b and 3-43b to 3-45b for the plots of 99% Occupied Bandwidth and -26 dBc Bandwidth.

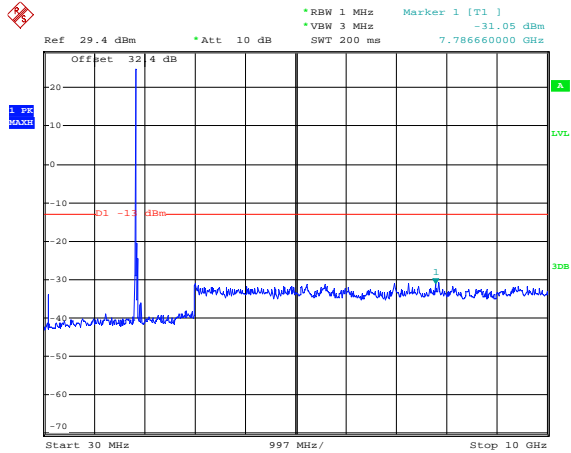
See Figures 3-25b to 3-36b for the plots of the Channel mask.

See Figures 3-37b to 3-42b for the plots of the Peak to Average Ratio.

	EMI Test Report for the BlackBerry® smartphone Model RFL111LW, RFP121LW <b>APPENDIX 3A</b>	
	<b>Test Report No.:</b> RTS-6026-1302-12A_Rev1	<b>Dates of Test:</b> Nov. 22, 2012 to Mar. 04, 2013, and April 05, 2013

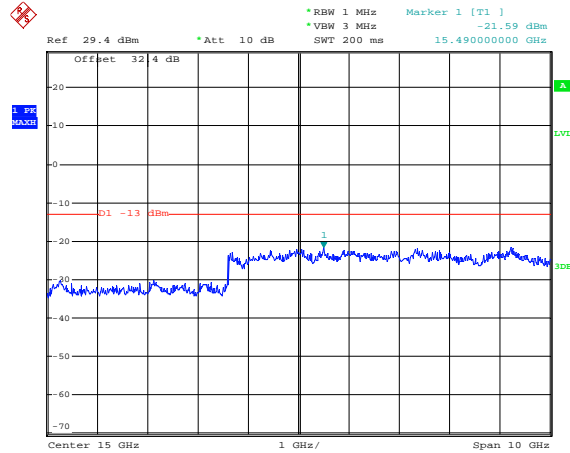
### LTE Band 2 Conducted RF Emission Test Data (cont'd)

**Figure 3-1a: Band 2, Spurious Conducted Emissions, Low channel, 20MHz BW (RB= 100)**



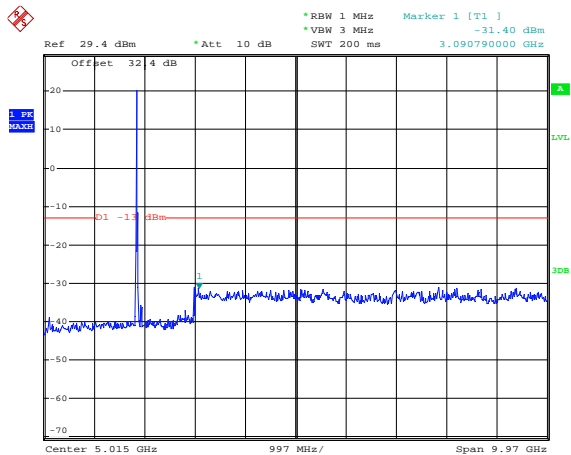
Date: 4.JAN.2013 11:27:32

**Figure 3-2a: Band 2, Spurious Conducted Emissions, Low channel, 20MHz BW (RB= 100)**



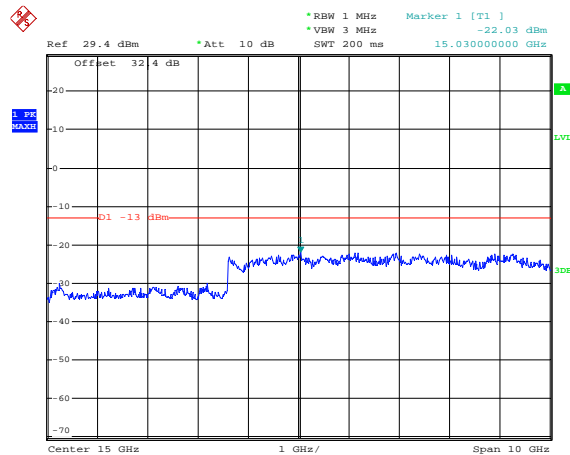
Date: 4.JAN.2013 11:28:17

**Figure 3-3a: Band 2, Spurious Conducted Emissions, Middle channel, 20MHz BW (RB= 100)**




Date: 4.JAN.2013 11:30:17

**Figure 3-4a: Band 2, Spurious Conducted Emissions, Middle channel, 20MHz BW (RB= 100)**

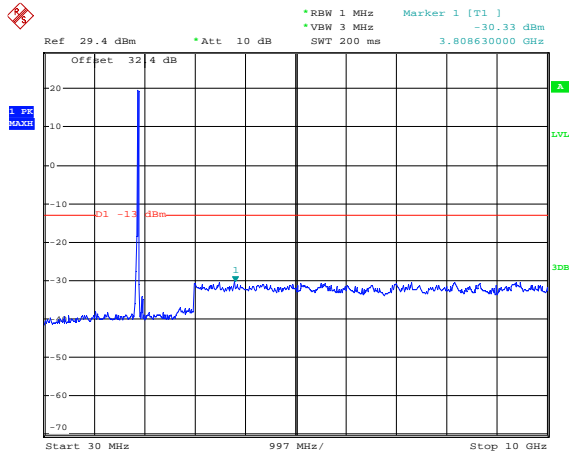


Date: 4.JAN.2013 11:29:01

	EMI Test Report for the BlackBerry® smartphone Model RFL111LW, RFP121LW <b>APPENDIX 3A</b>	
	<b>Test Report No.:</b> RTS-6026-1302-12A_Rev1	<b>Dates of Test:</b> Nov. 22, 2012 to Mar. 04, 2013, and April 05, 2013

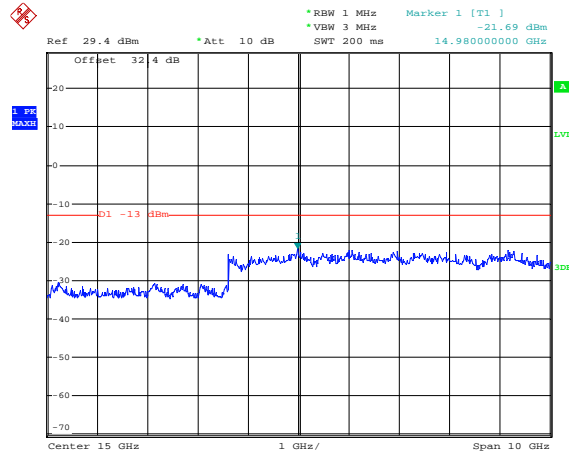
LTE Band 2 Conducted RF Emission Test Data cont'd

**Figure 3-5a: Band 2, Spurious Conducted Emissions, High Channel, 20MHz BW (RB= 100)**



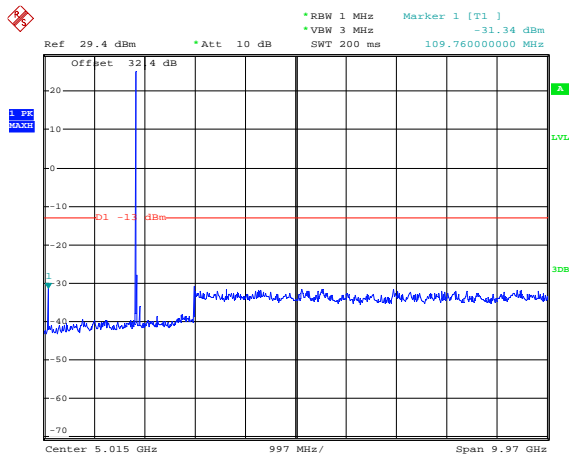
Date: 4.JAN.2013 11:45:32

**Figure 3-6a: Band 2, Spurious Conducted Emissions, High Channel, 20MHz BW (RB= 100)**



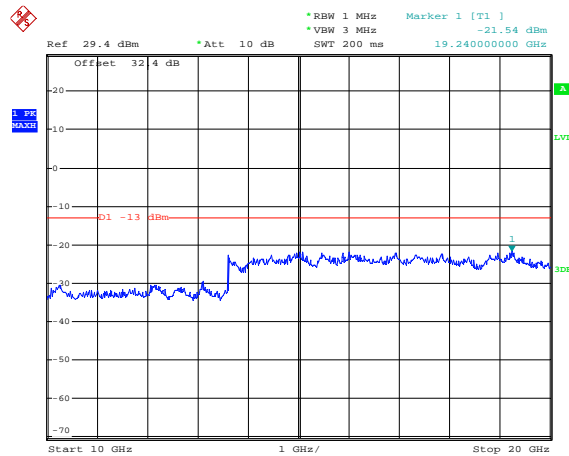
Date: 4.JAN.2013 11:45:59

**Figure 3-7a: Band 2, Spurious Conducted Emissions, Low channel, 10MHz BW (RB= 50)**




Date: 4.JAN.2013 11:48:19

**Figure 3-8a: Band 2, Spurious Conducted Emissions, Low channel, 10MHz BW (RB= 50)**

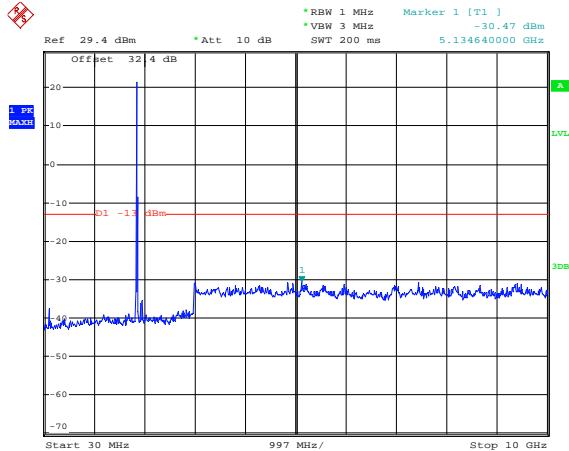


Date: 4.JAN.2013 11:47:17

	EMI Test Report for the BlackBerry® smartphone Model RFL111LW, RFP121LW <b>APPENDIX 3A</b>	
	<b>Test Report No.:</b> RTS-6026-1302-12A_Rev1	<b>Dates of Test:</b> Nov. 22, 2012 to Mar. 04, 2013, and April 05, 2013

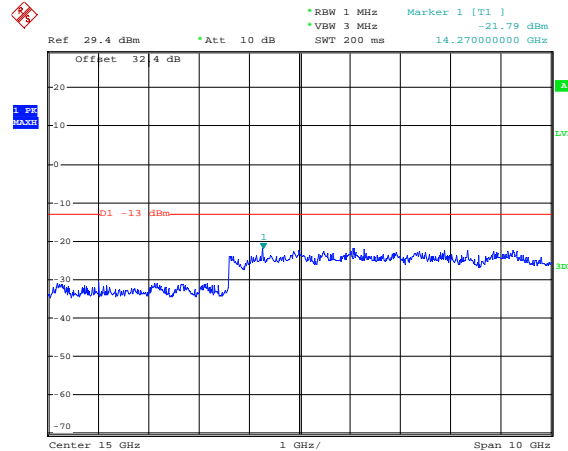
## LTE Band 2 Conducted RF Emission Test Data cont'd

**Figure 3-9a: Band 2, Spurious Conducted Emissions, Middle channel, 10MHz BW (RB= 50)**



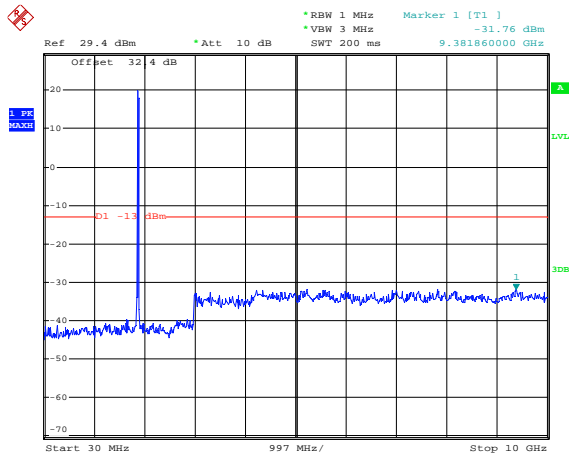
Date: 4.JAN.2013 11:49:21

**Figure 3-10a: Band 2, Spurious Conducted Emissions, Middle channel, 10MHz BW (RB= 50)**



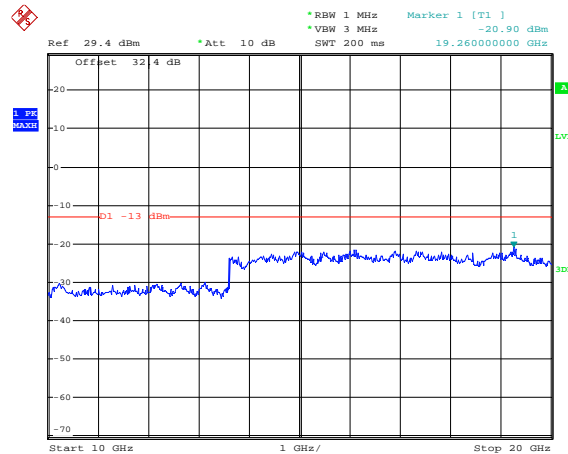
Date: 4.JAN.2013 11:52:04

**Figure 3-11a: Band 2, Spurious Conducted Emissions, High Channel, 10MHz BW (RB= 50)**




Date: 4.JAN.2013 11:54:18

**Figure 3-12a: Band 2, Spurious Conducted Emissions, High Channel, 10MHz BW (RB= 50)**



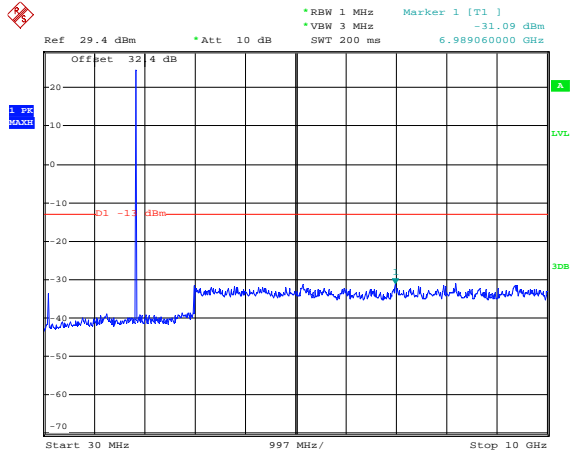
Date: 4.JAN.2013 11:53:44



	EMI Test Report for the BlackBerry® smartphone Model RFL111LW, RFP121LW <b>APPENDIX 3A</b>	
	<b>Test Report No.:</b> RTS-6026-1302-12A_Rev1	<b>Dates of Test:</b> Nov. 22, 2012 to Mar. 04, 2013, and April 05, 2013

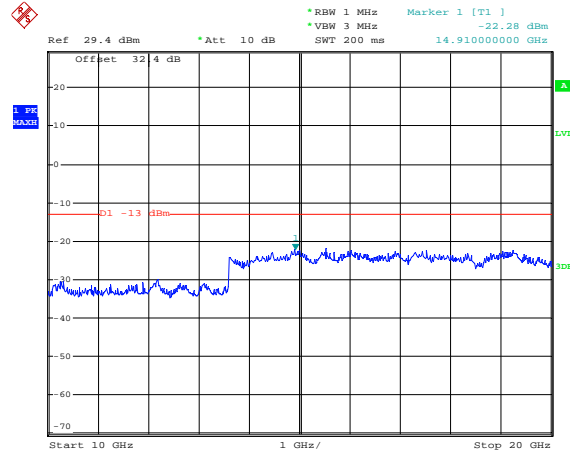
### LTE Band 2 Conducted RF Emission Test Data cont'd

**Figure 3-13a: Band 2, Spurious Conducted Emissions, Low channel, 1.4MHz BW (RB= 6)**



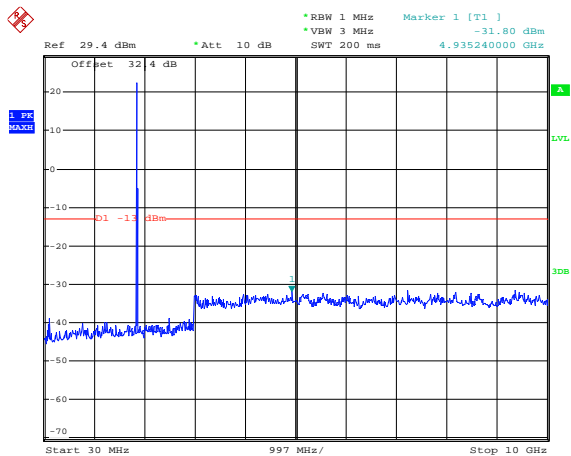
Date: 4.JAN.2013 11:55:36

**Figure 3-14a: Band 2, Spurious Conducted Emissions, Low channel, 1.4MHz BW (RB= 6)**



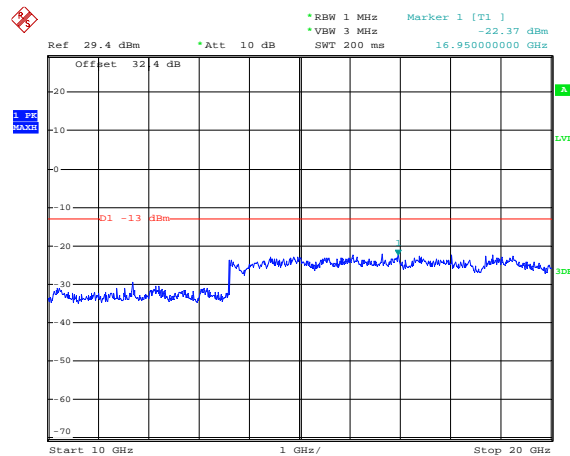
Date: 4.JAN.2013 11:56:12

**Figure 3-15a: Band 2, Spurious Conducted Emissions, Middle channel, 1.4MHz BW (RB= 6)**




Date: 4.JAN.2013 11:57:38

**Figure 3-16a: Band 2, Spurious Conducted Emissions, Middle channel, 1.4MHz BW (RB= 6)**

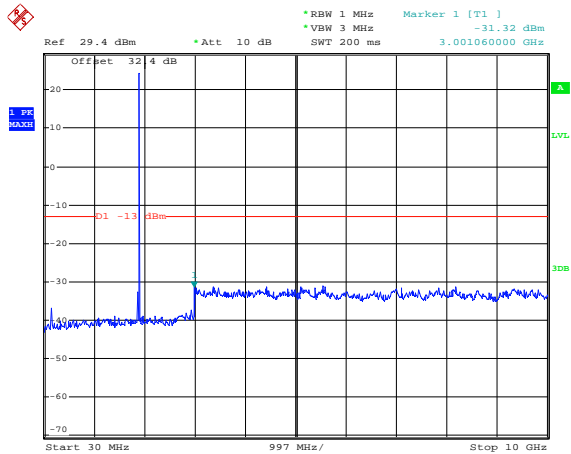


Date: 4.JAN.2013 11:57:10

	EMI Test Report for the BlackBerry® smartphone Model RFL111LW, RFP121LW <b>APPENDIX 3A</b>	
	<b>Test Report No.:</b> RTS-6026-1302-12A_Rev1	<b>Dates of Test:</b> Nov. 22, 2012 to Mar. 04, 2013, and April 05, 2013

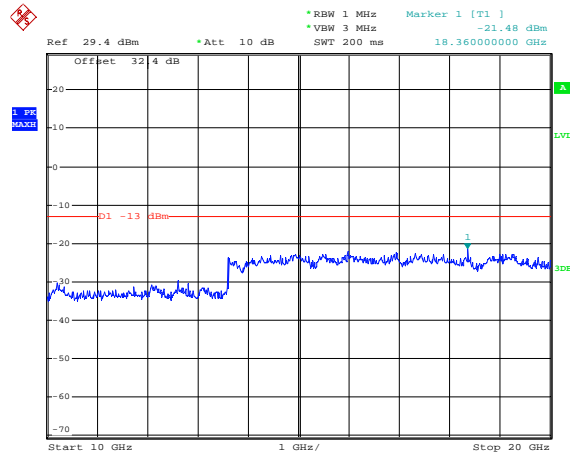
### LTE Band 2 Conducted RF Emission Test Data cont'd

**Figure 3-17a: Band 2, Spurious Conducted Emissions, High Channel, 1.4MHz BW (RB= 6)**



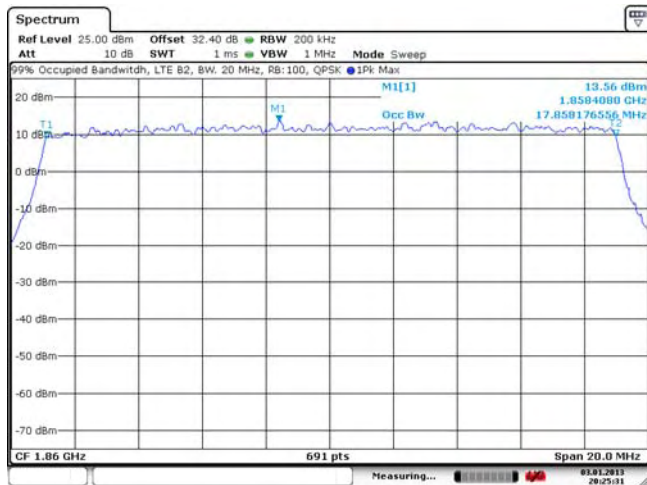
Date: 4.JAN.2013 11:59:09

**Figure 3-18a: Band 2, Spurious Conducted Emissions, High Channel, 1.4MHz BW (RB= 6)**

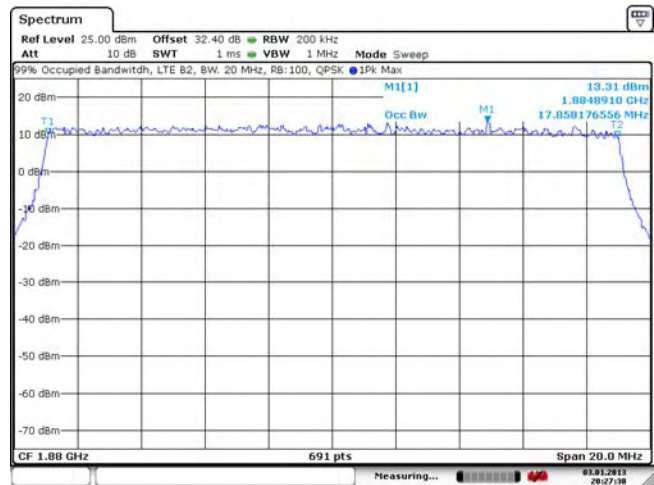



Date: 4.JAN.2013 11:59:44

**Figure 3-19a: Occupied Bandwidth, Band 2 Low Channel, 20MHz BW (RB= 100) QPSK**



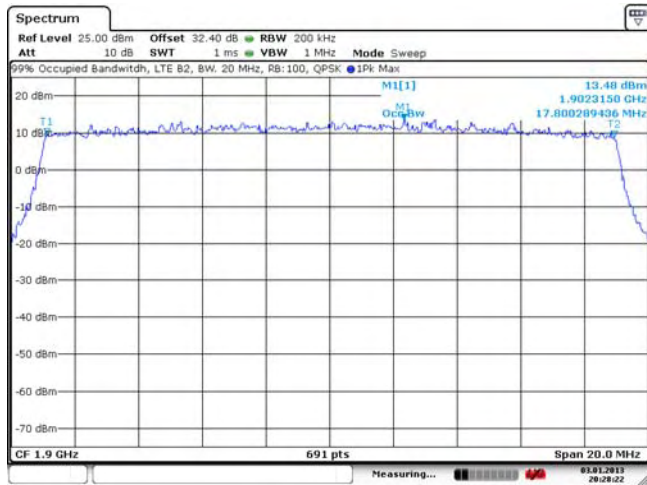
**Figure 3-20a: Occupied Bandwidth, Band 2 Middle Channel, 20MHz BW (RB= 100) QPSK**



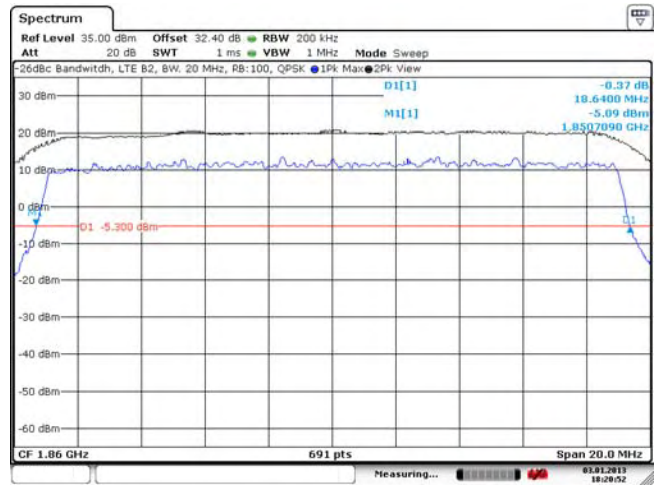
	EMI Test Report for the BlackBerry® smartphone Model RFL111LW, RFP121LW <b>APPENDIX 3A</b>	
	<b>Test Report No.:</b> RTS-6026-1302-12A_Rev1	<b>Dates of Test:</b> Nov. 22, 2012 to Mar. 04, 2013, and April 05, 2013

LTE Band 2 Conducted RF Emission Test Data cont'd

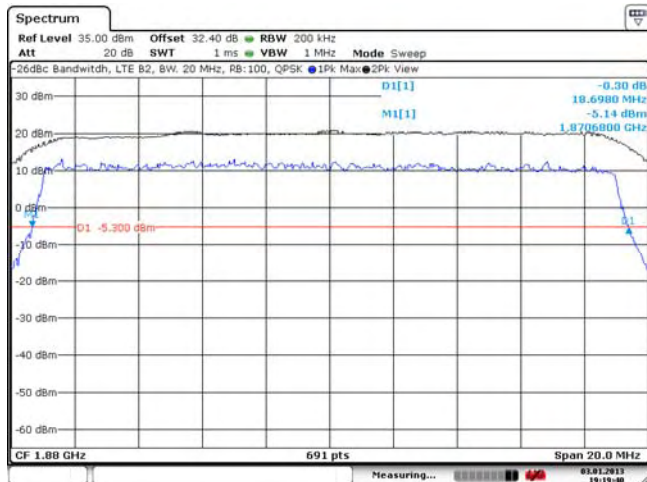
**Figure 3-21a: Occupied Bandwidth, Band 2 High Channel, 20MHz BW (RB= 100) QPSK**



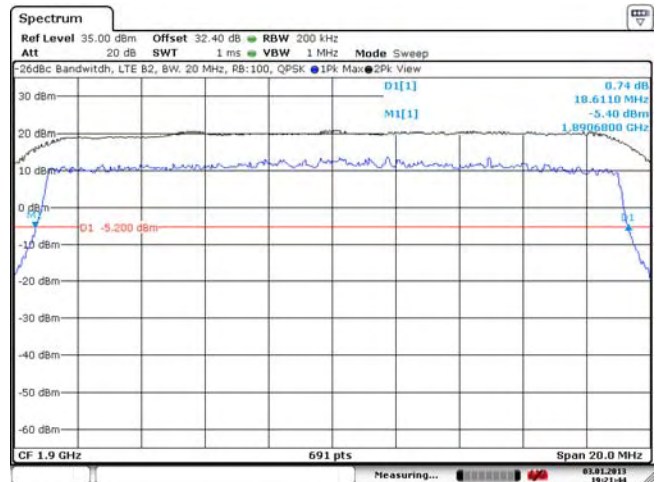
**Figure 3-22a: -26 dBc Bandwidth, Band 2 Low Channel, 20MHz BW (RB= 100)**




**Figure 3-23a: -26 dBc Bandwidth, Band 2 Middle Channel, 20MHz BW (RB= 100)**



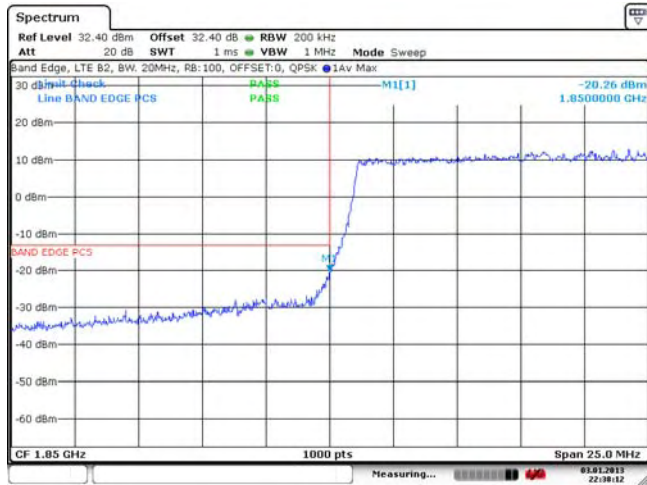
**Figure 3-24a: -26 dBc Bandwidth, Band 2 High Channel, 20MHz BW (RB= 100)**



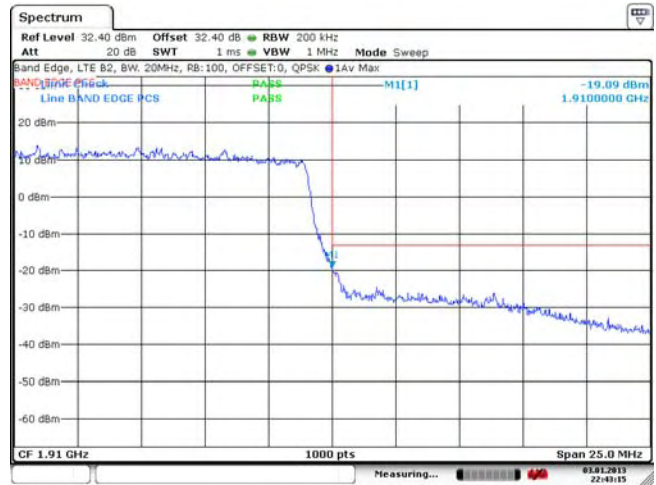
	EMI Test Report for the BlackBerry® smartphone Model RFL111LW, RFP121LW <b>APPENDIX 3A</b>	
	<b>Test Report No.:</b> RTS-6026-1302-12A_Rev1	<b>Dates of Test:</b> Nov. 22, 2012 to Mar. 04, 2013, and April 05, 2013

**LTE Band 2 Conducted RF Emission Test Data cont'd**

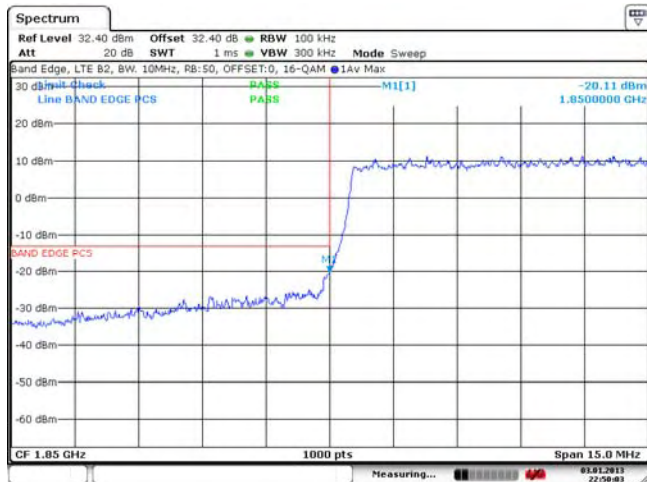
**Figure 3-25a: Band 2 Low Channel Mask, 20MHz  
BW, RB = 100**



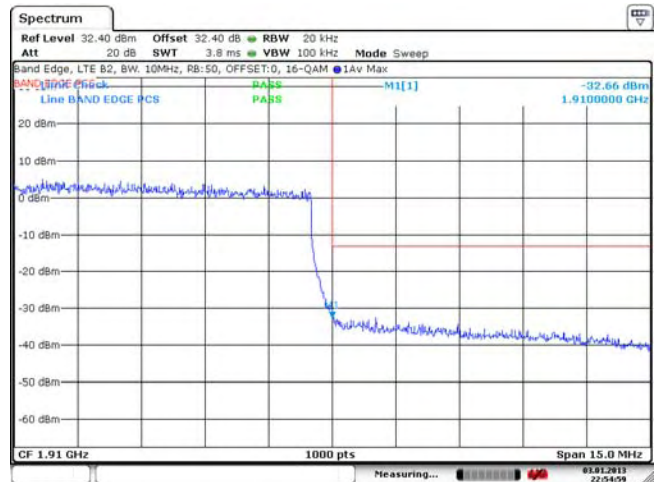
**Figure 3-26a: Band 2 High Channel Mask, 20MHz  
BW, RB = 100**




**Figure 3-27a: Band 2 Low Channel Mask, 10MHz  
BW, RB = 50**



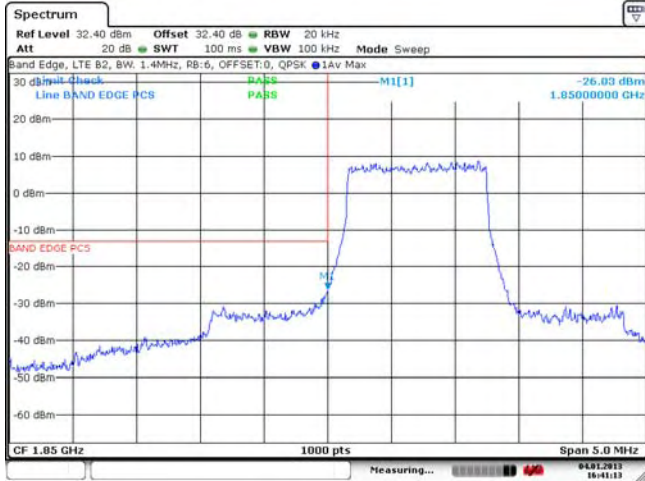
**Figure 3-28a: Band 2 High Channel Mask, 10MHz  
BW, RB = 50**



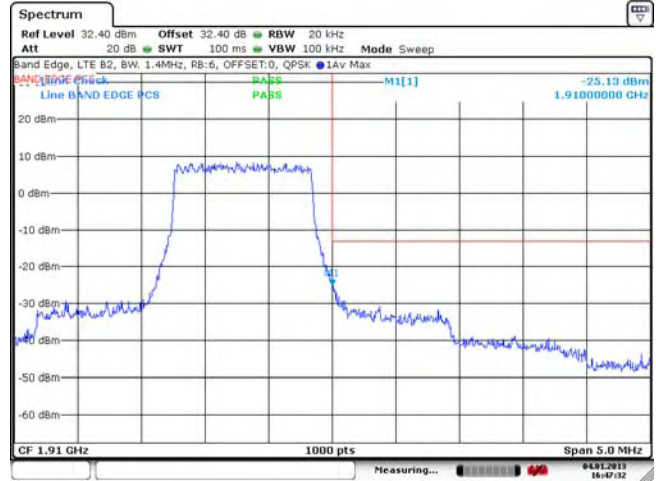
	EMI Test Report for the BlackBerry® smartphone Model RFL111LW, RFP121LW <b>APPENDIX 3A</b>	
<b>Test Report No.:</b> RTS-6026-1302-12A_Rev1	<b>Dates of Test:</b> Nov. 22, 2012 to Mar. 04, 2013, and April 05, 2013	<b>FCC ID:</b> L6ARFL110LW, L6ARFP120LW <b>IC:</b> 2503A-RFL110LW, 2503A-RFP120LW

LTE Band 2 Conducted RF Emission Test Data cont'd

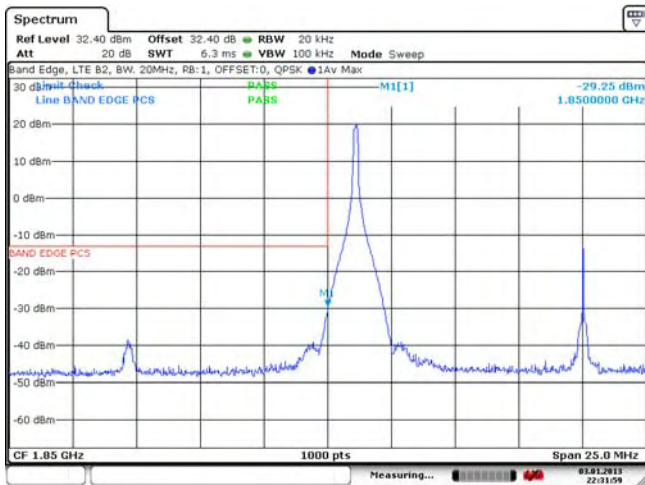
**Figure 3-29a: Band 2 Low Channel Mask, 1.4MHz BW, RB = 6**



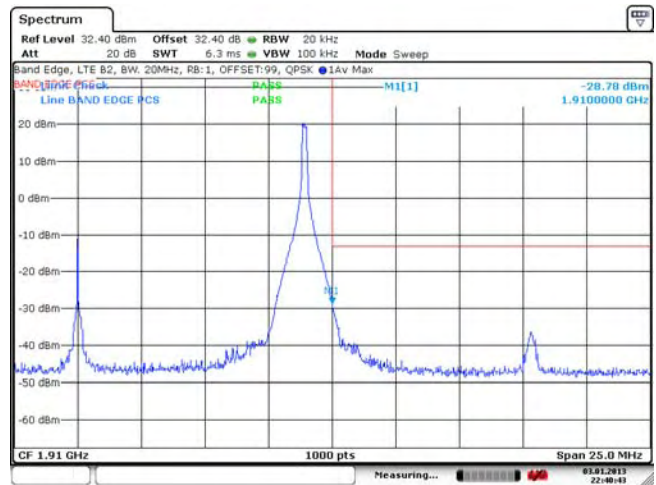
**Figure 3-30a: Band 2 High Channel Mask, 1.4MHz BW, RB = 6**




**Figure 3-31a: Band 2 Low Channel Mask, 20MHz BW, RB = 1**



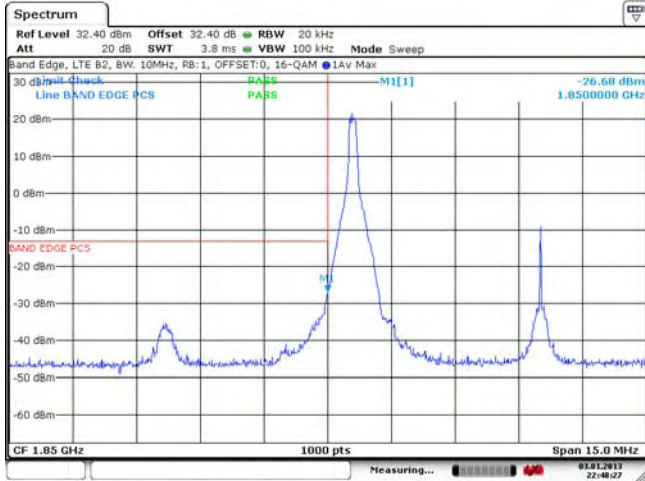
**Figure 3-32a: Band 2 High Channel Mask, 20MHz BW, RB = 1**



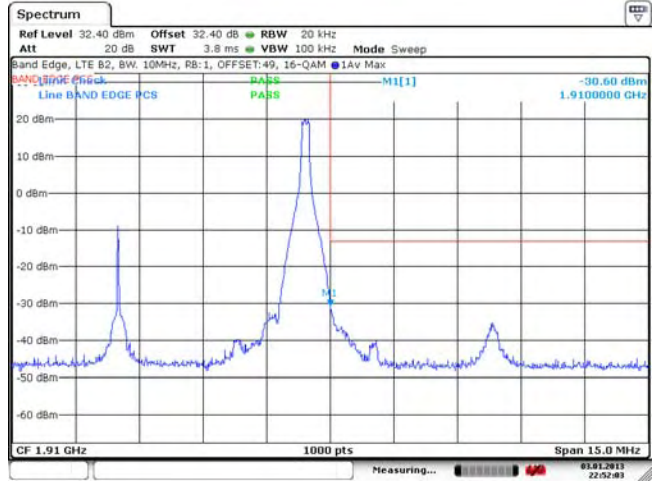
	EMI Test Report for the BlackBerry® smartphone Model RFL111LW, RFP121LW <b>APPENDIX 3A</b>	
	<b>Test Report No.:</b> RTS-6026-1302-12A_Rev1	<b>Dates of Test:</b> Nov. 22, 2012 to Mar. 04, 2013, and April 05, 2013

### LTE Band 2 Conducted RF Emission Test Data cont'd

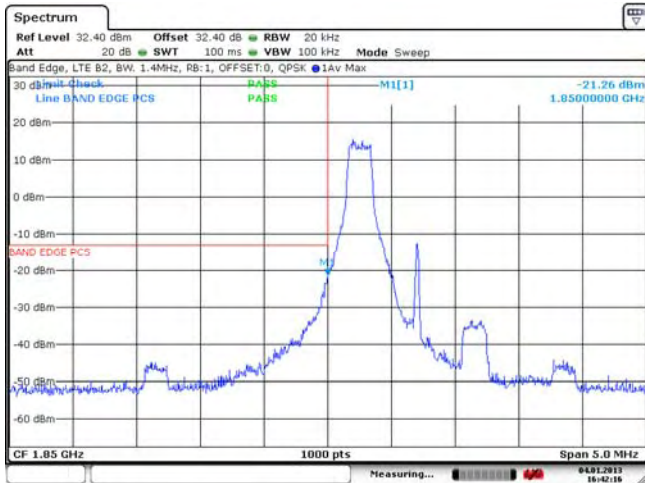
**Figure 3-33a: Band 2 Low Channel Mask, 10MHz BW, RB = 1**



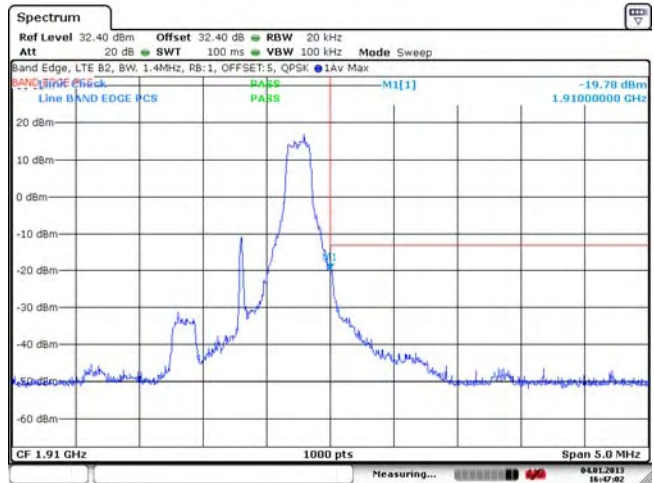
**Figure 3-34a: Band 2 High Channel Mask, 10MHz BW, RB = 1**



**Figure 3-35a: Band 2 Low Channel Mask, 1.4MHz BW, RB = 1**



**Figure 3-36a: Band 2 High Channel Mask, 1.4MHz BW, RB = 1**



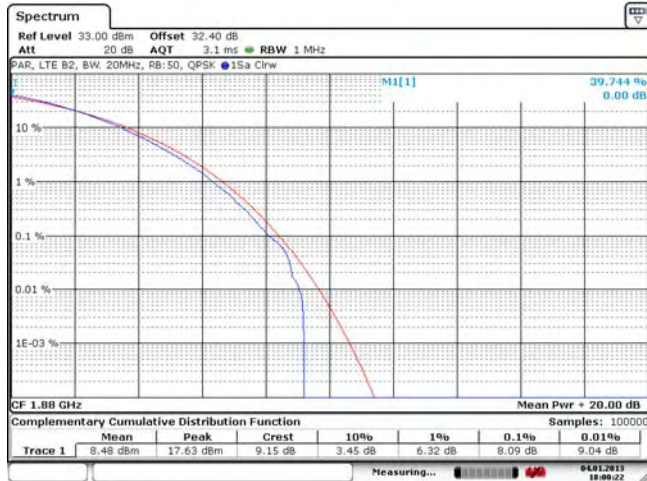
Test Report No.:  
 RTS-6026-1302-12A\_Rev1

Dates of Test:  
 Nov. 22, 2012 to Mar. 04, 2013,  
 and April 05, 2013

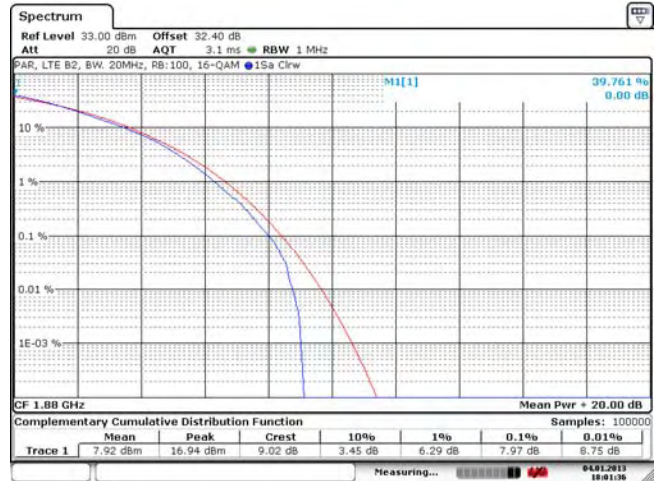
FCC ID: L6ARFL110LW, L6ARFP120LW  
 IC: 2503A-RFL110LW, 2503A-RFP120LW

**LTE Band 2 Conducted RF Emission Test Data cont'd**

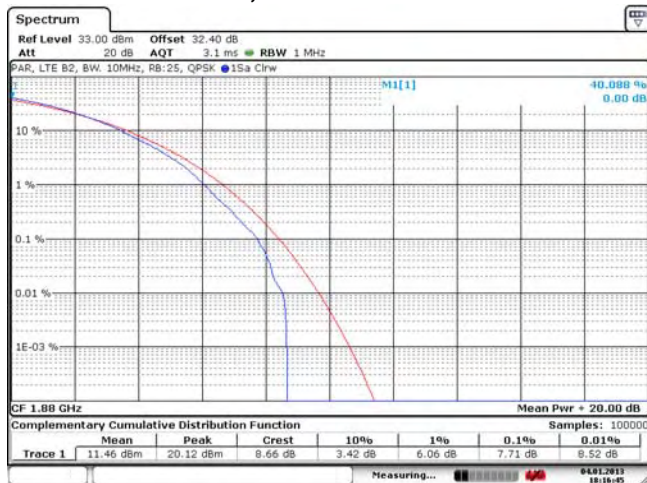
**Figure 3-37a: Band 2, Mid Channel PAR, 20 MHz  
 BW, RB = 50 QPSK**



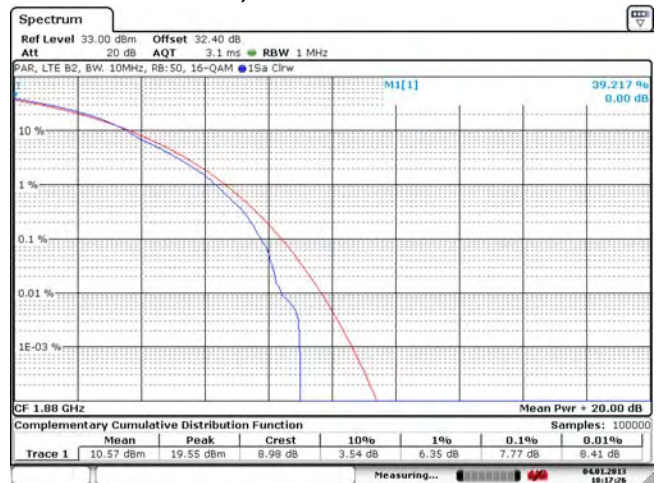
**Figure 3-38a: Band 2, Mid Channel PAR, 20 MHz  
 BW, RB = 100 16-QAM**




**Figure 3-39a: Band 2, Mid Channel PAR, 10 MHz  
 BW, RB = 25 QPSK**



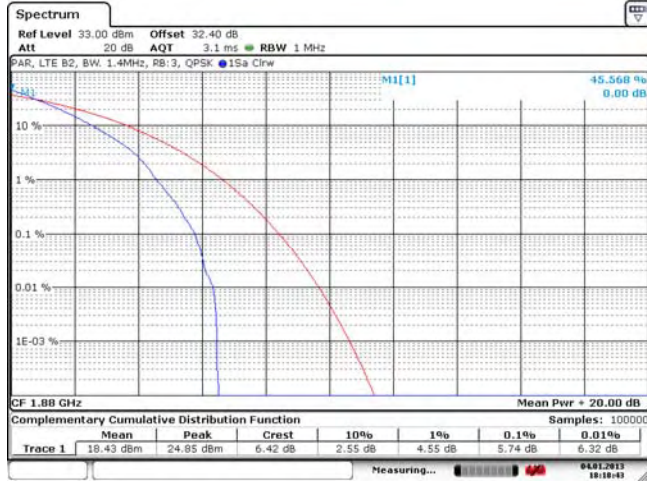
**Figure 3-40a: Band 2, Mid Channel PAR, 10 MHz  
 BW, RB = 50 16-QAM**



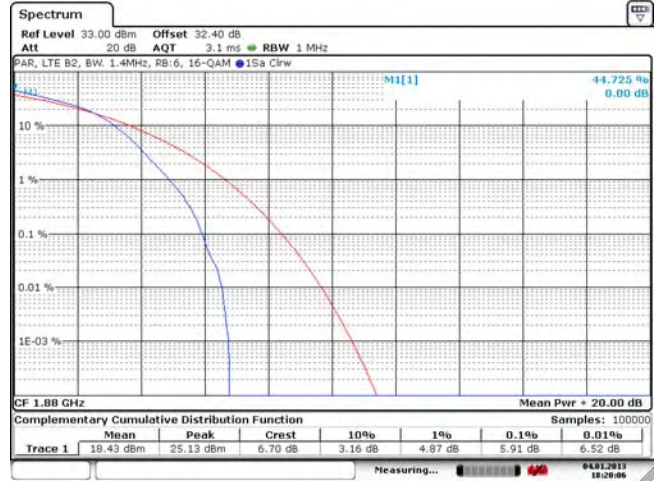
	EMI Test Report for the BlackBerry® smartphone Model RFL111LW, RFP121LW <b>APPENDIX 3A</b>	
	<b>Test Report No.:</b> RTS-6026-1302-12A_Rev1	<b>Dates of Test:</b> Nov. 22, 2012 to Mar. 04, 2013, and April 05, 2013

LTE Band 2 Conducted RF Emission Test Data cont'd


**Figure 3-41a: Band 2, Mid Channel PAR, 1.4 MHz  
BW, RB = 3 QPSK**



**Figure 3-42a: Band 2, Mid Channel PAR, 1.4 MHz  
BW, RB = 6 16-QAM**



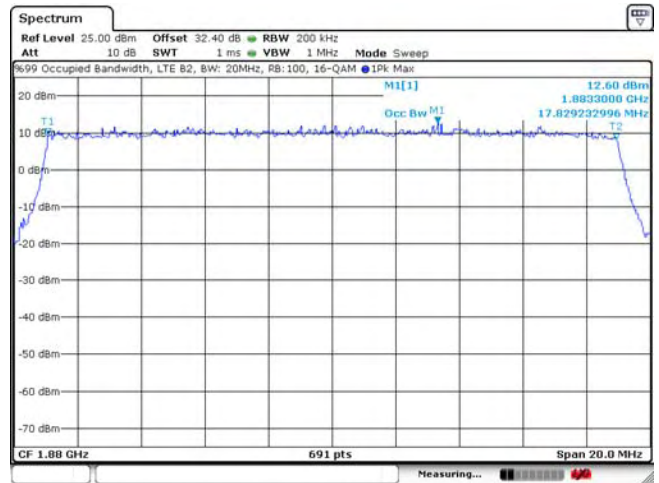
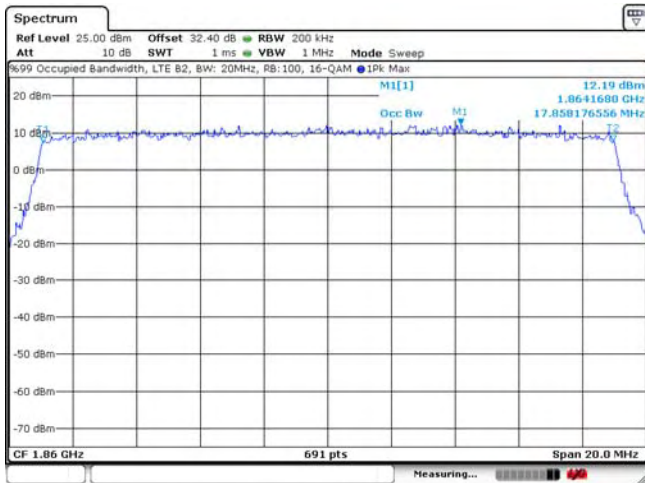


	EMI Test Report for the BlackBerry® smartphone Model RFL111LW, RFP121LW <b>APPENDIX 3A</b>	
	<b>Test Report No.:</b> RTS-6026-1302-12A_Rev1	<b>Dates of Test:</b> Nov. 22, 2012 to Mar. 04, 2013, and April 05, 2013

LTE Band 2 Conducted RF Emission Test Data cont'd

**Figure 3-43a: Occupied Bandwidth, Band 2 Low Channel, 20MHz BW (RB= 100) 16-QAM**

**Figure 3-44a: Occupied Bandwidth, Band 2 Mid Channel, 20MHz BW (RB= 100) 16-QAM**



**Figure 3-45a: Occupied Bandwidth, Band 2 High Channel, 20MHz BW (RB= 100) 16-QAM**

