

TEST REPORT

Test report no.: 1-5579/12-01-09-B



Testing laboratory

CETECOM ICT Services GmbH
Untertuerkheimer Strasse 6 – 10
66117 Saarbruecken / Germany
Phone: + 49 681 5 98 - 0
Fax: + 49 681 5 98 - 9075
Internet: <http://www.cetecom.com>
e-mail: ict@cetecom.com

Accredited Testing Laboratory:

The testing laboratory (area of testing) is accredited according to DIN EN ISO/IEC 17025 (2005) by the Deutsche Akkreditierungsstelle GmbH (DAkkS). The accreditation is valid for the scope of testing procedures as stated in the accreditation certificate with the registration number: D-PL-12076-01-01
Area of Testing: Radio/Satellite Communications

Applicant

Research In Motion Limited
305 Phillip Street
Waterloo, ON N2L 3W8 / CANADA
Phone: +1 51 98 88 74 65
Fax: +1 51 98 88 69 06
Contact: Masud Attayi
e-mail: mattayi@rim.com
Phone: +1 51 98 88 74 65

Manufacturer

Research In Motion Limited
305 Phillip Street
Waterloo, ON N2L 3W8 / CANADA

Test standard/s

47 CFR Part 15 Title 47 of the Code of Federal Regulations; Chapter I
Part 15 - Radio frequency devices

RSS - 210 Issue 8 Spectrum Management and Telecommunications - Radio Standards Specification
Low-power Licence-exempt Radiocommunication Devices (All Frequency Bands):
Category I Equipment

For further applied test standards please refer to section 3 of this test report.

Test Item

Kind of test item: Blackberry GSM Phones
Model name: RFN81UW
FCC ID: L6ARFN80UW
IC: 2503A-RFN80UW
Frequency: ISM band 2400 MHz to 2483.5 MHz
(lowest channel 2412 MHz, highest channel 2462 MHz)
Technology tested: WLAN (DSSS & OFDM)
Antenna: Integrated antenna
Power Supply: 3.8 V DC by Li - Ion battery
Temperature Range: No range needed!

This test report is electronically signed and valid without handwriting signature. For verification of the electronic signatures, the public keys can be requested at the testing laboratory.

Test report authorised:

Andreas Luckenbill
Expert

Test performed:

Marco Bertolino
Testing Manager

1 Table of contents	
1	Table of contents2
2	General information3
2.1	Notes and disclaimer3
2.2	Application details.....3
3	Test standard/s3
3.1	Measurement guidance.....3
4	Test environment.....4
5	Test item4
5.1	Additional information4
6	Test laboratories sub-contracted4
7	Summary of measurement results5
8	RF measurements6
8.1	Description of test setup6
8.1.1	Radiated measurements.....6
8.1.2	Conducted measurements.....7
8.2	Additional comments7
9	Measurement results.....8
9.1	Output power verification (conducted)8
9.2	Antenna gain.....8
9.3	Maximum output power8
9.4	Power spectral density8
9.5	Spectrum bandwidth – 6 dB8
9.6	Spectrum bandwidth – 20 dB8
9.7	Band edge compliance conducted8
9.8	Band edge compliance radiated9
9.9	TX spurious emissions conducted14
9.10	TX spurious emissions radiated15
9.11	RX spurious emissions radiated44
9.12	Spurious emissions radiated < 30 MHz44
9.13	Spurious emissions conducted < 30 MHz44
10	Test equipment and ancillaries used for tests45
11	Observations46
Annex A	Document history47
Annex B	Further information.....47
Annex C	Accreditation Certificate48

2 General information

2.1 Notes and disclaimer

The test results of this test report relate exclusively to the test item specified in this test report. CETECOM ICT Services GmbH does not assume responsibility for any conclusions and generalizations drawn from the test results with regard to other specimens or samples of the type of the equipment represented by the test item.

The test report may only be reproduced or published in full. Reproduction or publication of extracts from the report requires the prior written approval of CETECOM ICT Services GmbH.

The testing service provided by CETECOM ICT Services GmbH has been rendered under the current "General Terms and Conditions for CETECOM ICT Services GmbH".

CETECOM ICT Services GmbH will not be liable for any loss or damage resulting from false, inaccurate, inappropriate or incomplete product information provided by the customer.

Under no circumstances does the CETECOM ICT Services GmbH test report include any endorsement or warranty regarding the functionality, quality or performance of any other product or service provided.

Under no circumstances does the CETECOM ICT Services GmbH test report include or imply any product or service warranties from CETECOM ICT Services GmbH, including, without limitation, any implied warranties of merchantability, fitness for purpose, or non-infringement, all of which are expressly disclaimed by CETECOM ICT Services GmbH.

All rights and remedies regarding vendor's products and services for which CETECOM ICT Services GmbH has prepared this test report shall be provided by the party offering such products or services and not by CETECOM ICT Services GmbH.

In no case this test report can be considered as a Letter of Approval.

This test report is electronically signed and valid without handwritten signature. For verification of the electronic signatures, the public keys can be requested at the testing laboratory.

2.2 Application details

Date of receipt of order:	2012-11-30
Date of receipt of test item:	2012-12-01
Start of test:	2012-12-01
End of test:	2013-03-05
Person(s) present during the test:	-/-

3 Test standard/s

Test standard	Date	Test standard description
47 CFR Part 15	2010-10	Title 47 of the Code of Federal Regulations; Chapter I Part 15 - Radio frequency devices
RSS - 210 Issue 8	2010-12	Spectrum Management and Telecommunications - Radio Standards Specification Low-power Licence-exempt Radiocommunication Devices (All Frequency Bands): Category I Equipment

3.1 Measurement guidance

DTS : KDB 558074	2012-04	Guidance for Performing Compliance Measurements on Digital Transmission Systems (DTS) Operating Under §15.247
------------------	---------	---

4 Test environment

Temperature:	T_{nom}	+22 °C during room temperature tests
	T_{max}	-/- °C during high temperature tests
	T_{min}	-/- °C during low temperature tests
Relative humidity content:		39 %
Barometric pressure:		not relevant for this kind of testing
Power supply:	V_{nom}	3.8 V DC by Li - Ion battery
	V_{max}	-/- V
	V_{min}	-/- V

5 Test item

Kind of test item	:	Blackberry GSM Phones
Type identification	:	RFN81UW
S/N serial number	:	IMEI 004401139252155 / 004401139334680
HW hardware status	:	CER-53015-001-Rev 2-905-01 / CER-53015-001-Rev 3-905-01
SW software status	:	127.0.1.3123 / 127.0.1.3901
Frequency band [MHz]	:	ISM band 2400 MHz to 2483.5 MHz (lowest channel 2412 MHz, highest channel 2462 MHz)
Type of radio transmission	:	DSSS, OFDM
Use of frequency spectrum	:	
Type of modulation	:	BPSK, QPSK, 16 – QAM, 32 – QAM
Number of channels	:	11
Antenna	:	Integrated antenna
Power supply	:	3.8 V DC by Li - Ion battery
Temperature range	:	Not needed!

5.1 Additional information

Test setup- and EUT-photos are included in test reports: 1-5579/12-01-01_AnnexA
1-5579/12-01-01_AnnexD

6 Test laboratories sub-contracted

None

7 Summary of measurement results

- No deviations from the technical specifications were ascertained
- There were deviations from the technical specifications ascertained

TC Identifier	Description	Verdict	Date	Remark
RF-Testing	CFR Part 15 RSS 210, Issue 8	passed	2013-03-08	Tests according to manufacturer test plan!

Test specification clause	Test case	Temperature conditions	Power source voltages	Mode	Pass	Fail	NA	NP	Remark
§15.247(b)(4) RSS 210 / A8.4(2)	Antenna gain	Nominal	Nominal	DSSS	<input type="checkbox"/>	<input type="checkbox"/>	<input type="checkbox"/>	<input checked="" type="checkbox"/>	-/-
§15.247(e) RSS 210 / A8.2(b)	Power spectral density	Nominal	Nominal	DSSS OFDM g & n	<input type="checkbox"/> <input type="checkbox"/>	<input type="checkbox"/> <input type="checkbox"/>	<input type="checkbox"/> <input type="checkbox"/>	<input checked="" type="checkbox"/> <input checked="" type="checkbox"/>	-/-
§15.247(a)(2) RSS 210 / A8.2(a)	Spectrum bandwidth - 6dB bandwidth	Nominal	Nominal	DSSS OFDM g & n	<input type="checkbox"/> <input type="checkbox"/>	<input type="checkbox"/> <input type="checkbox"/>	<input type="checkbox"/> <input type="checkbox"/>	<input checked="" type="checkbox"/> <input checked="" type="checkbox"/>	-/-
§15.247(a)(2) RSS 210 / A8.2(a)	Spectrum bandwidth - 20dB bandwidth	Nominal	Nominal	DSSS OFDM g & n	<input type="checkbox"/> <input type="checkbox"/>	<input type="checkbox"/> <input type="checkbox"/>	<input type="checkbox"/> <input type="checkbox"/>	<input checked="" type="checkbox"/> <input checked="" type="checkbox"/>	-/-
§15.247(b)(3) RSS-210 / A8.4(4)	Maximum output power	Nominal	Nominal	DSSS OFDM g & n	<input type="checkbox"/> <input type="checkbox"/>	<input type="checkbox"/> <input type="checkbox"/>	<input type="checkbox"/> <input type="checkbox"/>	<input checked="" type="checkbox"/> <input checked="" type="checkbox"/>	-/-
§15.247(d) RSS-210 / A8.5	Band edge compliance conducted	Nominal	Nominal	DSSS OFDM g & n	<input type="checkbox"/> <input type="checkbox"/>	<input type="checkbox"/> <input type="checkbox"/>	<input type="checkbox"/> <input type="checkbox"/>	<input checked="" type="checkbox"/> <input checked="" type="checkbox"/>	-/-
§15.205 RSS-210 / A8.5	Band edge compliance radiated	Nominal	Nominal	DSSS OFDM g & n	<input checked="" type="checkbox"/> <input checked="" type="checkbox"/>	<input type="checkbox"/> <input type="checkbox"/>	<input type="checkbox"/> <input type="checkbox"/>	<input type="checkbox"/> <input type="checkbox"/>	-/-
§15.247(d) RSS-210 / A8.5	TX spurious emissions conducted	Nominal	Nominal	DSSS OFDM g & n	<input type="checkbox"/> <input type="checkbox"/>	<input type="checkbox"/> <input type="checkbox"/>	<input type="checkbox"/> <input type="checkbox"/>	<input checked="" type="checkbox"/> <input checked="" type="checkbox"/>	-/-
§15.247(d) RSS-210 / A8.5	TX spurious emissions radiated	Nominal	Nominal	DSSS OFDM g & n	<input checked="" type="checkbox"/> <input checked="" type="checkbox"/>	<input type="checkbox"/> <input type="checkbox"/>	<input type="checkbox"/> <input type="checkbox"/>	<input type="checkbox"/> <input type="checkbox"/>	-/-
§15.109 RSS-Gen	RX spurious emissions radiated	Nominal	Nominal	-/-	<input type="checkbox"/>	<input type="checkbox"/>	<input type="checkbox"/>	<input checked="" type="checkbox"/>	-/-
§15.209(a) RSS-Gen	TX spurious emissions radiated < 30 MHz	Nominal	Nominal	DSSS OFDM g & n	<input type="checkbox"/> <input type="checkbox"/>	<input type="checkbox"/> <input type="checkbox"/>	<input type="checkbox"/> <input type="checkbox"/>	<input checked="" type="checkbox"/> <input checked="" type="checkbox"/>	-/-
§15.107(a)	Conducted emissions < 30 MHz	Nominal	Nominal	DSSS OFDM g & n	<input type="checkbox"/> <input type="checkbox"/>	<input type="checkbox"/> <input type="checkbox"/>	<input type="checkbox"/> <input type="checkbox"/>	<input checked="" type="checkbox"/> <input checked="" type="checkbox"/>	-/-

Note: NA = Not Applicable; NP = Not Performed

8 RF measurements

8.1 Description of test setup

8.1.1 Radiated measurements

The radiated measurements are performed in vertical and horizontal plane in the frequency range from 9 kHz to 25 GHz in semi-anechoic chambers. The EUT is positioned on a non-conductive support with a height of 0.80 m above a conductive ground plane that covers the whole chamber. The receiving antennas are confirmed with specifications ANSI C63.2-1996 clause 15 and ANSI C63.4-2009 clause 4.1.5. These antennas can be moved over the height range between 1.0 m and 4.0 m in order to search for maximum field strength emitted from EUT. The measurement distances between EUT and receiving antennas are indicated in the test setups for the various frequency ranges. For each measurement, the EUT is rotated in all three axes until the maximum field strength is received. The wanted and unwanted emissions are received by spectrum analysers where the detector modes and resolution bandwidths over various frequency ranges are set according to requirement ANSI C63-4-2009 clause 4.2.

Antennas are confirmed with ANSI C63.2-1996 item 15.

Semi anechoic chamber

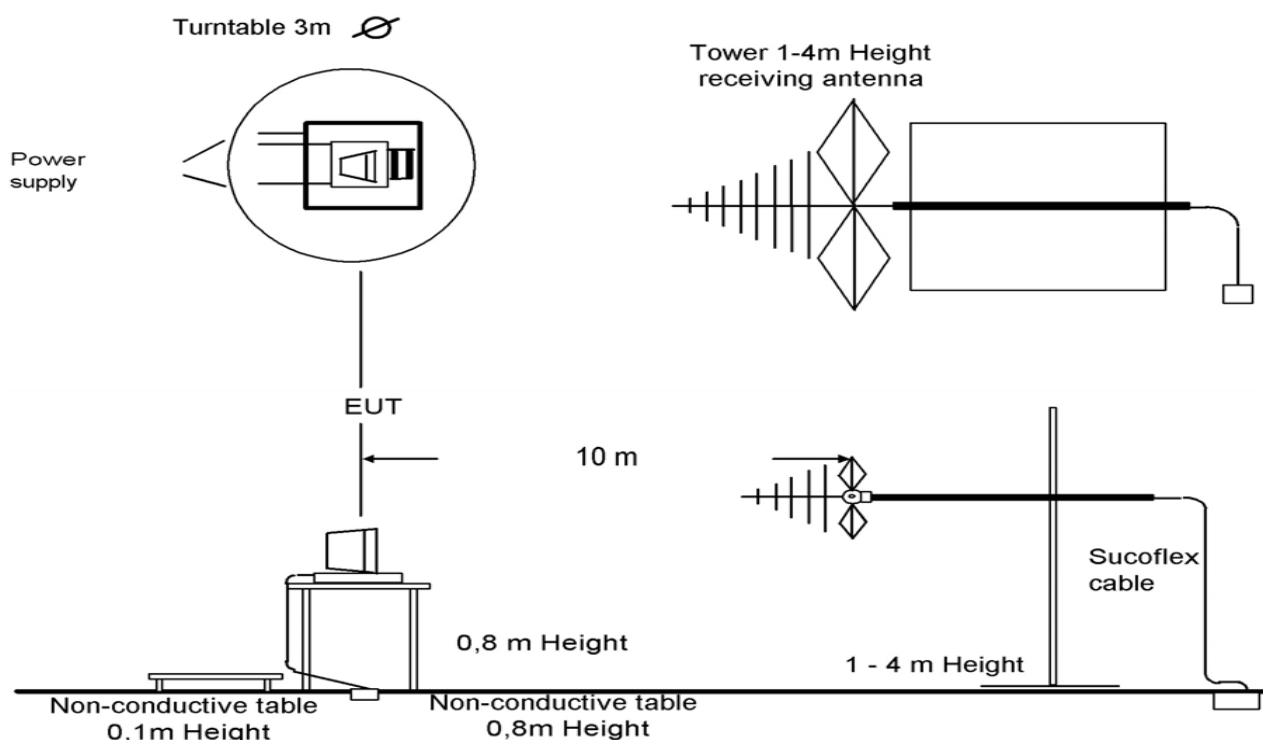

Picture 1: Diagram radiated measurements

9 kHz - 30 MHz:	active loop antenna
30 MHz – 1 GHz:	tri-log antenna
> 1 GHz:	horn antenna

The EUT is powered by an external power supply with nominal voltage. The signalling is performed from outside the chamber with a signalling unit (CMU200 or other) by air link using signalling antenna.

8.1.2 Conducted measurements

The EUT's RF signal is coupled out by the antenna connector which is supplied by the manufacturer. The signal is first 10dB attenuated before it is power divided (~6dB loss per branch). One of the signal paths is connected to the communication base Station (CMU200 or other), the other one is connected to the spectrum analyzer. The specific losses for both signal paths are first checked within a calibration. The measurement readings on the signalling unit/spectrum analyzer are corrected by the specific test set-up loss. The attenuator, power divider, signalling unit and the spectrum analyzer are impedance matched on 50 Ohm.

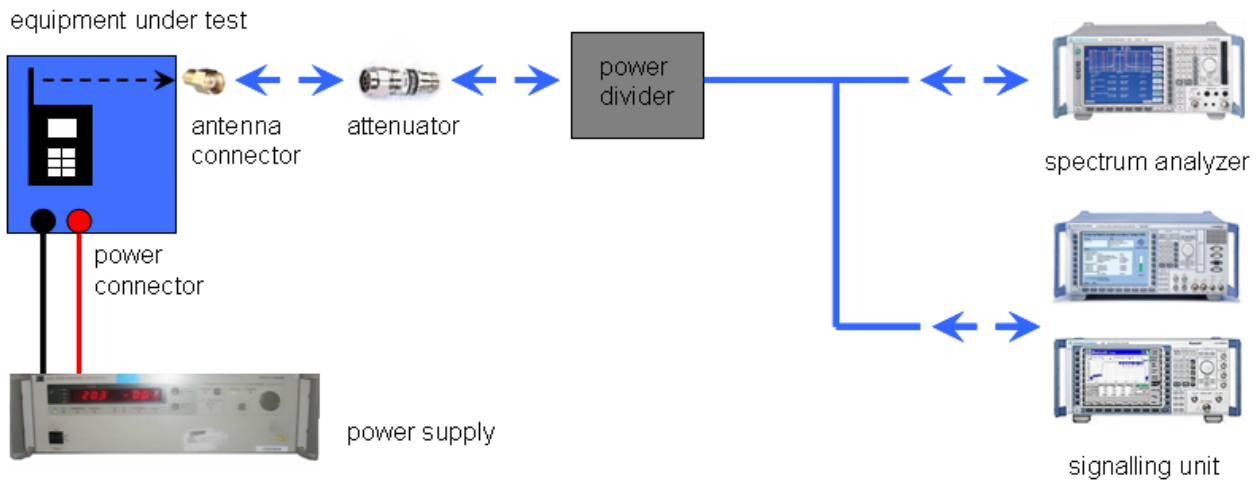

Picture 2: Diagram conducted measurements

8.2 Additional comments

Reference documents: None

Special test descriptions: None

Configuration descriptions: None

- Test mode:
- No test mode available.
Iperf was used to ping another device with the largest support packet size
 - Special software is used.
EUT is transmitting pseudo random data by itself

9 Measurement results

9.1 Output power verification (conducted)

Not performed! Reduced tests only!

9.2 Antenna gain

Not performed! Reduced tests only!

9.3 Maximum output power

Not performed! Reduced tests only!

9.4 Power spectral density

Not performed! Reduced tests only!

9.5 Spectrum bandwidth – 6 dB

Not performed! Reduced tests only!

9.6 Spectrum bandwidth – 20 dB

Not performed! Reduced tests only!

9.7 Band edge compliance conducted

Not performed! Reduced tests only!

9.8 Band edge compliance radiated

Description:

Measurement of the radiated band edge compliance. The EUT is turned in the position that results in the maximum level at the band edge. Then a sweep over the corresponding restricted band is performed. The EUT is set to channel 1 for the lower restricted band and to channel 11 for the upper restricted band. The measurement is repeated for all modulations. Measurement distance is 3m.

Measurement:

Measurement parameter	
Detector:	Peak
Sweep time:	Auto
Resolution bandwidth:	1 MHz / 1 MHz
Video bandwidth:	1 MHz / 10 Hz
Span:	See plot!
Trace-Mode:	Max Hold

Limits:

FCC	IC
Band Edge Compliance Radiated	
<p>In any 100 kHz bandwidth outside the frequency band in which the spread spectrum or digitally modulated intentional radiator is operating, the radio frequency power that is produced by the intentional radiator shall be at least 20 dB below that in the 100 kHz bandwidth within the band that contains the highest level of the desired power, based on either an RF conducted or a radiated measurement. Attenuation below the general limits specified in Section 15.209(a) is not required. In addition, radiated emissions which fall in the restricted bands, as defined in Section 15.205(a), must also comply with the radiated emission limits specified in Section 15.209(a) (see Section 5.205(c).</p>	
54 dB μ V/m AVG	

Results:

Scenario Modulation	Band Edge Compliance Radiated [dB]		
	DSSS / b – mode	OFDM / g – mode	OFDM / n – mode
Lower Band Edge – Channel 1	> 20 dB (Peak) > 20 dB (AVG)	> 10 dB (Peak) > 10 dB (AVG)	> 10 dB (Peak) > 10 dB (AVG)
Upper Band Edge – Channel 11	> 20 dB (Peak) > 20 dB (AVG)	> 10 dB (Peak) > 10 dB (AVG)	> 10 dB (Peak) > 10 dB (AVG)
Measurement uncertainty	\pm 3 dB		

Result: **Passed**

Plots: DSSS/ b – mode peak

Plot 1: TX mode, lower band edge, vertical & horizontal polarization

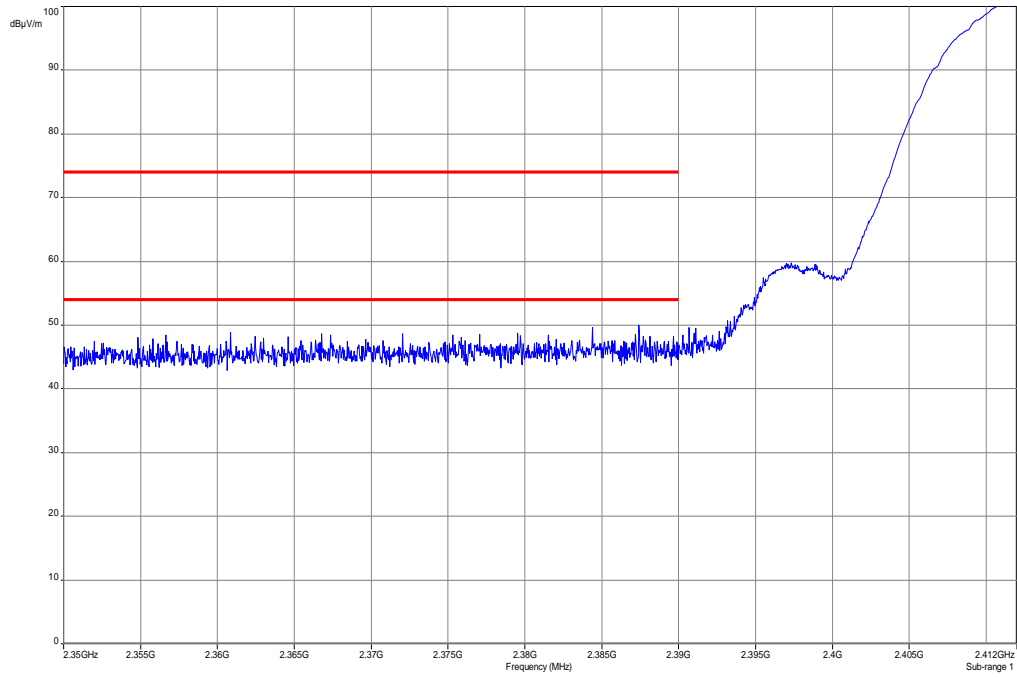

Plot 2: TX mode, upper band edge, vertical & horizontal polarization

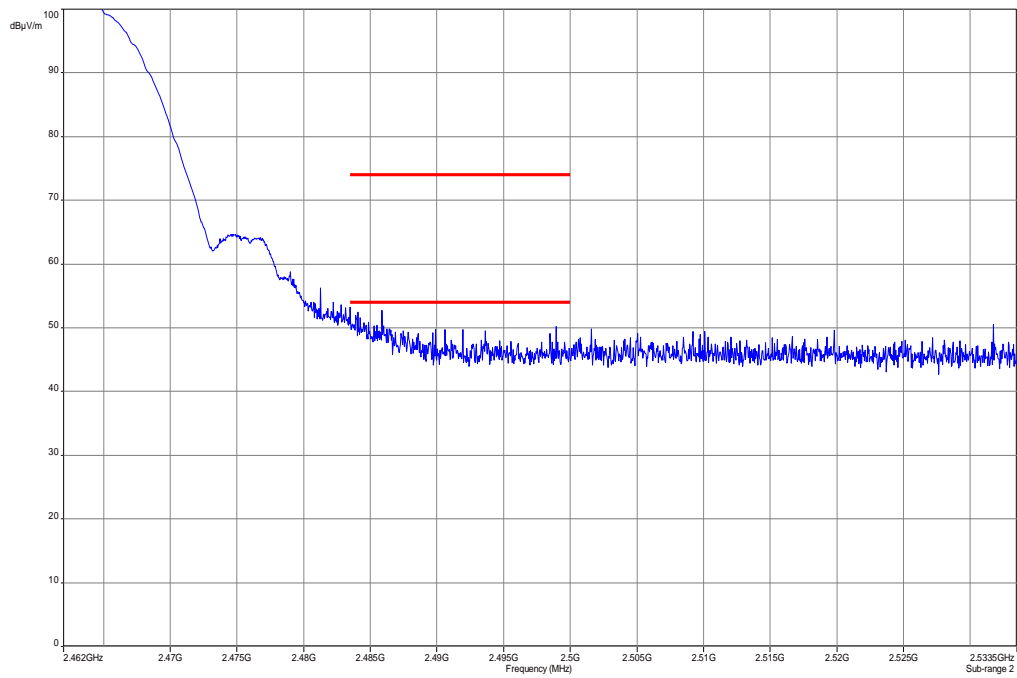

Plots: DSSS / b – mode average

Plot 1: TX mode, lower band edge, vertical & horizontal polarization

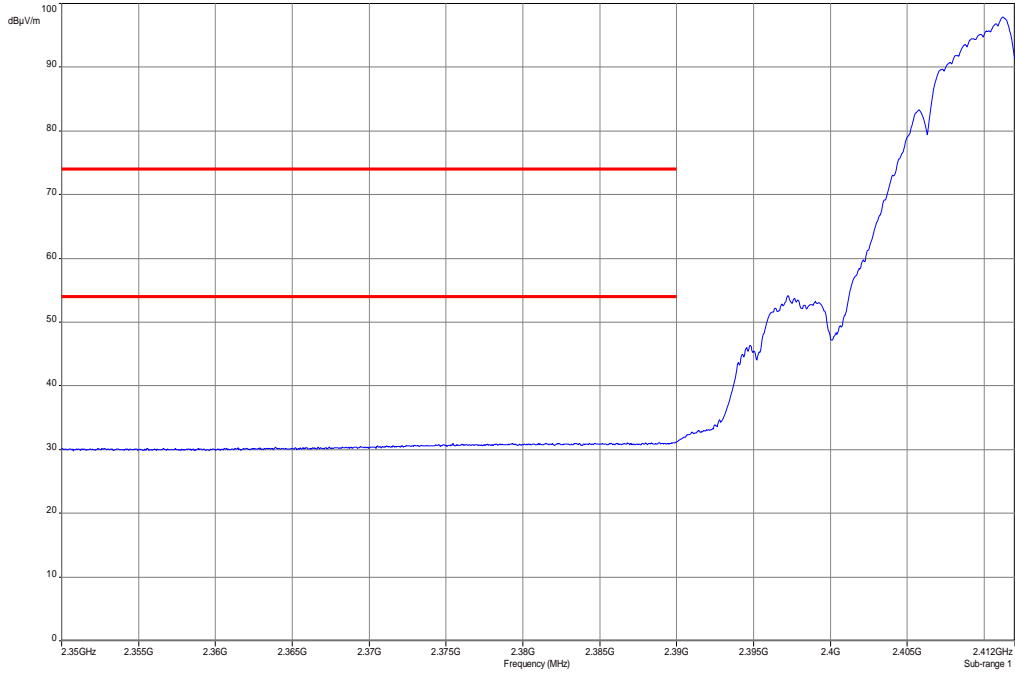

Plot 2: TX mode, upper band edge, vertical & horizontal polarization

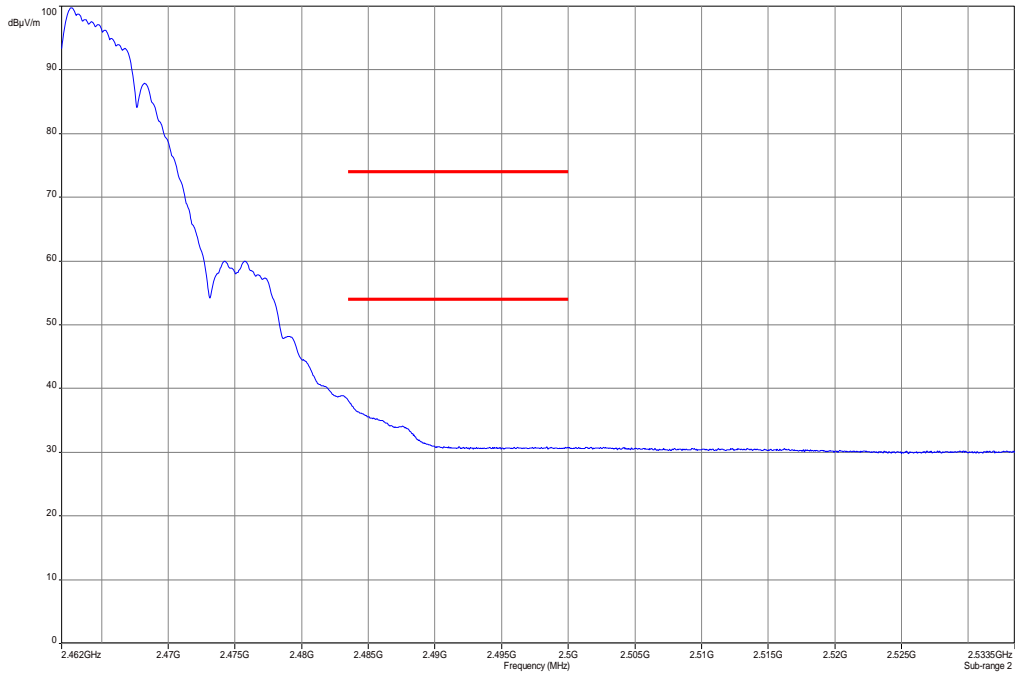

Plots: OFDM / g – mode, peak and average

Plot 1: TX mode, lower band edge, vertical & horizontal polarization

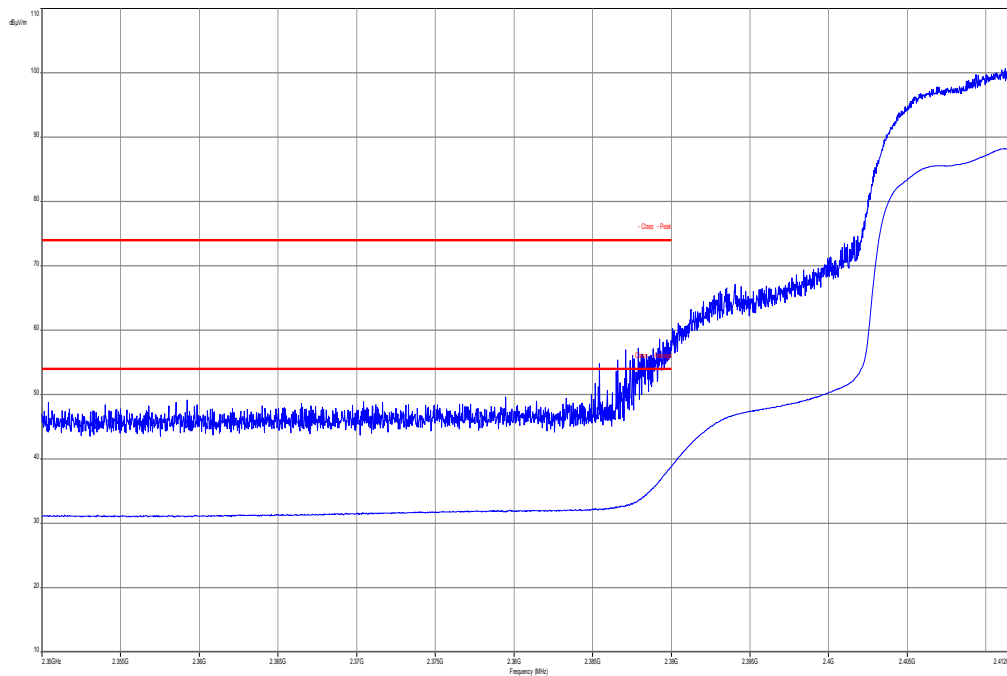

Plot 2: TX mode, upper band edge, vertical & horizontal polarization

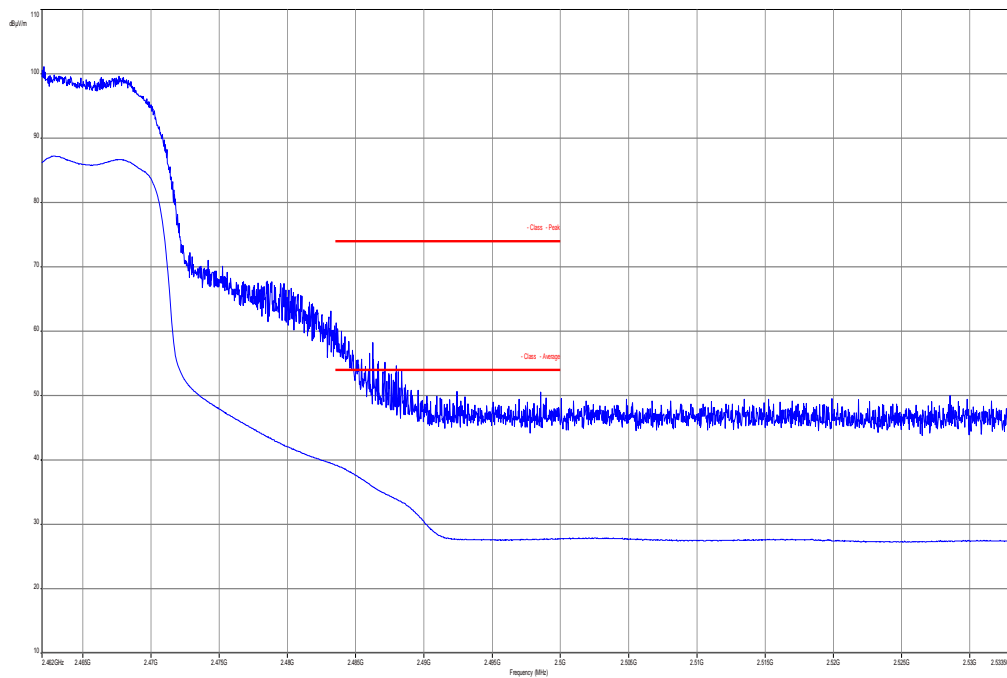

Plots: OFDM / n – mode, peak and average

Plot 1: TX mode, lower band edge, vertical & horizontal polarization

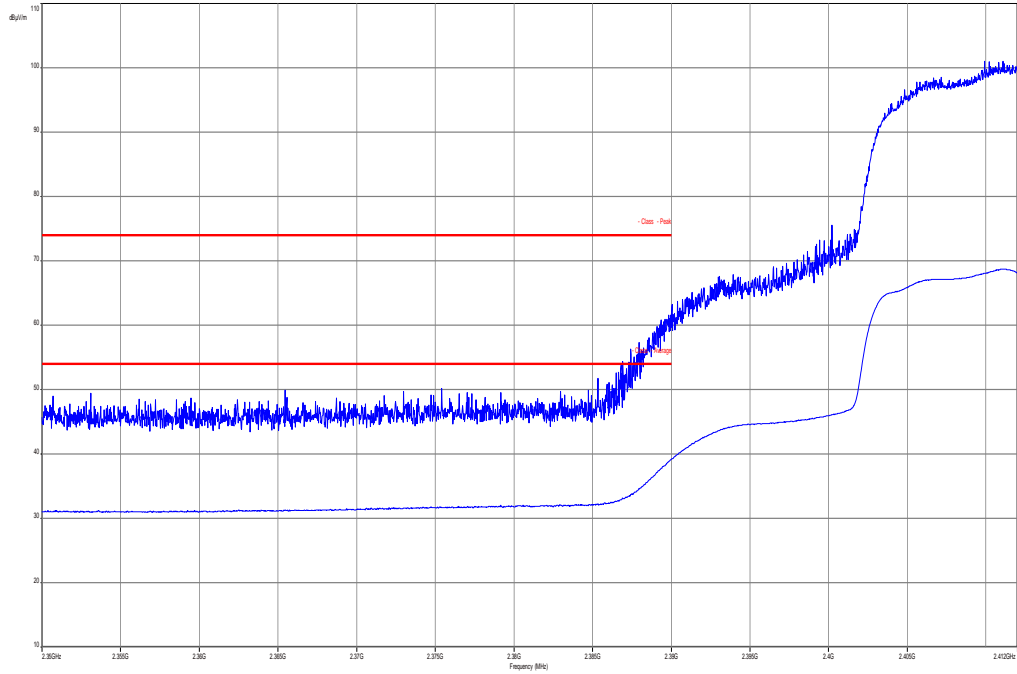

Plot 2: TX mode, upper band edge, vertical & horizontal polarization

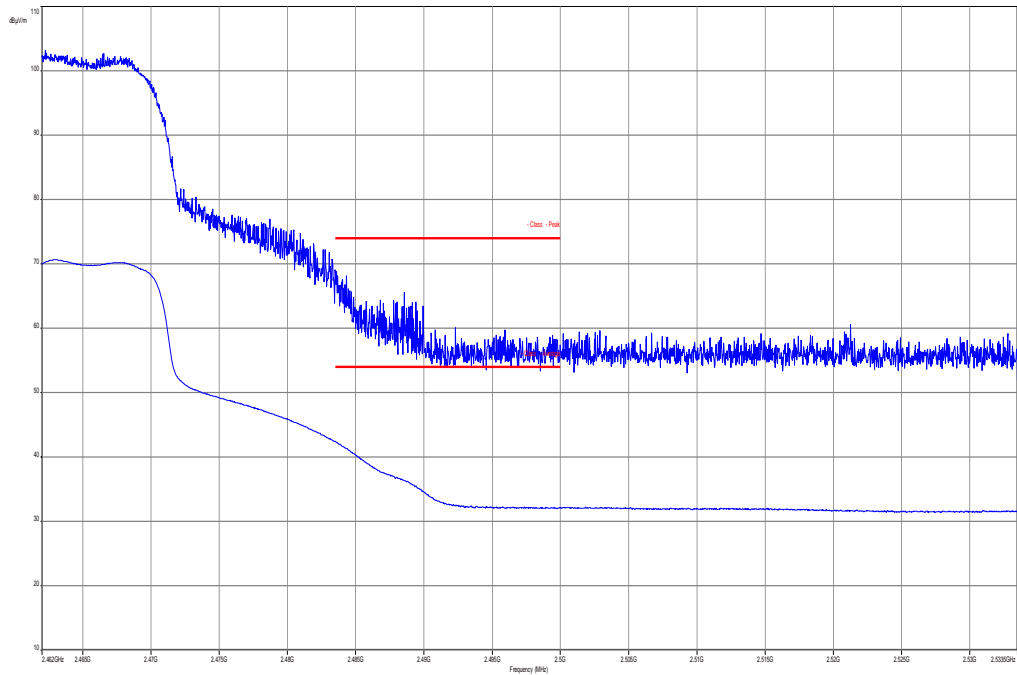

9.9 TX spurious emissions conducted

Not performed! Reduced tests only!

9.10 TX spurious emissions radiated

Description:

Measurement of the radiated spurious emissions in transmit mode. The measurement is performed at channel 1, 6 and 11. The measurement is repeated for all modulations.

Measurement:

Measurement parameter	
Detector:	Peak / Quasi Peak / RMS
Sweep time:	Auto
Resolution bandwidth:	F > 1 GHz: 1 MHz F < 1 GHz: 100 kHz
Video bandwidth:	Sweep: 100 kHz Remeasurement: 10 Hz / 3 MHz
Span:	30 MHz to 26 GHz
Trace-Mode:	Max Hold
Measured Modulation	<input checked="" type="checkbox"/> DSSS b – mode <input checked="" type="checkbox"/> OFDM g – mode <input checked="" type="checkbox"/> OFDM n – mode

The modulation with the highest output power was used to perform the transmitter spurious emissions. If spurious were detected a re-measurement was performed on the detected frequency with each modulation.

Limits:

FCC	IC	
TX Spurious Emissions Radiated		
<p>In any 100 kHz bandwidth outside the frequency band in which the spread spectrum or digitally modulated intentional radiator is operating, the radio frequency power that is produced by the intentional radiator shall be at least 20 dB below that in the 100 kHz bandwidth within the band that contains the highest level of the desired power, based on either an RF conducted or a radiated measurement. Attenuation below the general limits specified in Section 15.209(a) is not required. In addition, radiated emissions which fall in the restricted bands, as defined in §15.205(a), must also comply with the radiated emission limits specified in §15.209(a) (see §15.205(c)).</p>		
Frequency (MHz)	Field Strength (dBµV/m)	Measurement distance
30 - 88	30.0	10
88 – 216	33.5	10
216 – 960	36.0	10
Above 960	54.0	3

Results: DSSS / b – mode

TX Spurious Emissions Radiated [dBµV/m]								
DSSS / b – mode								
2412 MHz			2442 MHz			2462 MHz		
F [MHz]	Detector	Level [dBµV/m]	F [MHz]	Detector	Level [dBµV/m]	F [MHz]	Detector	Level [dBµV/m]
For emissions below 1 GHz, please take a look at the table below the 1 GHz plot.			For emissions below 1 GHz, please take a look at the table below the 1 GHz plot.			For emissions below 1 GHz, please take a look at the table below the 1 GHz plot.		
4824	Peak	48.3	4884	Peak	44.7	4924	Peak	48.8
	AVG	46.0		AVG	42.2		AVG	46.2
Measurement uncertainty			± 3 dB					

Result: Passed

Results: OFDM / g – mode

TX Spurious Emissions Radiated [dBµV/m]								
OFDM / g – mode								
2412 MHz			2442 MHz			2462 MHz		
F [MHz]	Detector	Level [dBµV/m]	F [MHz]	Detector	Level [dBµV/m]	F [MHz]	Detector	Level [dBµV/m]
For emissions below 1 GHz, please take a look at the table below the 1 GHz plot.			For emissions below 1 GHz, please take a look at the table below the 1 GHz plot.			For emissions below 1 GHz, please take a look at the table below the 1 GHz plot.		
4824	Peak	57.6	-/-	-/-	-/-	-/-	-/-	-/-
	AVG	42.6						
Measurement uncertainty			± 3 dB					

Result: Passed

Results: OFDM / n – mode

TX Spurious Emissions Radiated [dBµV/m]								
OFDM / n – mode								
2412 MHz			2442 MHz			2462 MHz		
F [MHz]	Detector	Level [dBµV/m]	F [MHz]	Detector	Level [dBµV/m]	F [MHz]	Detector	Level [dBµV/m]
For emissions below 1 GHz, please take a look at the table below the 1 GHz plot.			For emissions below 1 GHz, please take a look at the table below the 1 GHz plot.			For emissions below 1 GHz, please take a look at the table below the 1 GHz plot.		
4824	Peak	57.9	-/-	-/-	-/-	-/-	-/-	-/-
	AVG	42.9						
Measurement uncertainty			± 3 dB					

Result: Passed

Plots: DSSS / b – mode

Plot 1: Lowest channel, 30 MHz to 1 GHz, vertical & horizontal polarization

Common Information

EUT: RFN81UW
 Serial Number: IMEI:004401139252155
 Test Description: FCC part 15 C class B @ 10m
 Operating Conditions: 802.11b TX CH1 1Mbps
 Operator Name: Wolsdorfer
 Comment: battery powered

Scan Setup: STAN_Fin [EMI radiated]

Hardware Setup: Electric Field (NOS)
 Receiver: [ESCI 3]
 Level Unit: dBµV/m

Subrange	Step Size	Detectors	IF BW	Meas. Time	Preamp
30 MHz - 2 GHz	60 kHz	QPK	120 kHz	1 s	20 dB

FCC_10m(B)_3

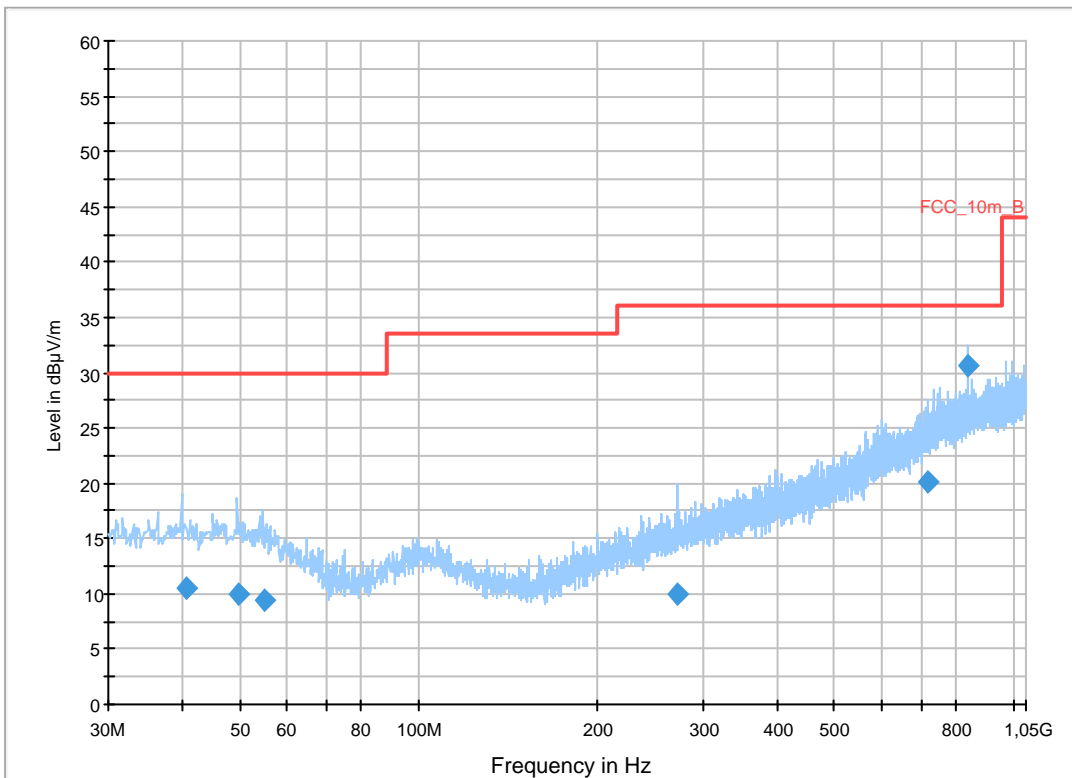

Final Result 1

Frequency (MHz)	QuasiPeak (dBµV/m)	Meas. Time (ms)	Bandwidth (kHz)	Height (cm)	Polarization	Azimuth (deg)	Corr. (dB)	Margin (dB)	Limit (dBµV/m)	Comment
40.478400	10.5	1000.0	120.000	170.0	V	280.0	13.4	19.5	30.0	
49.817550	9.9	1000.0	120.000	170.0	V	0.0	13.4	20.1	30.0	
54.963450	9.4	1000.0	120.000	170.0	H	182.0	12.9	20.6	30.0	
272.618250	10.0	1000.0	120.000	170.0	H	190.0	13.9	26.0	36.0	
718.488000	20.1	1000.0	120.000	144.0	V	180.0	22.9	15.9	36.0	
836.677650	30.6	1000.0	120.000	143.0	V	-10.0	24.4	5.4	36.0	

Plot 2: Lowest channel, 1 GHz to 12.75 GHz, vertical & horizontal polarization

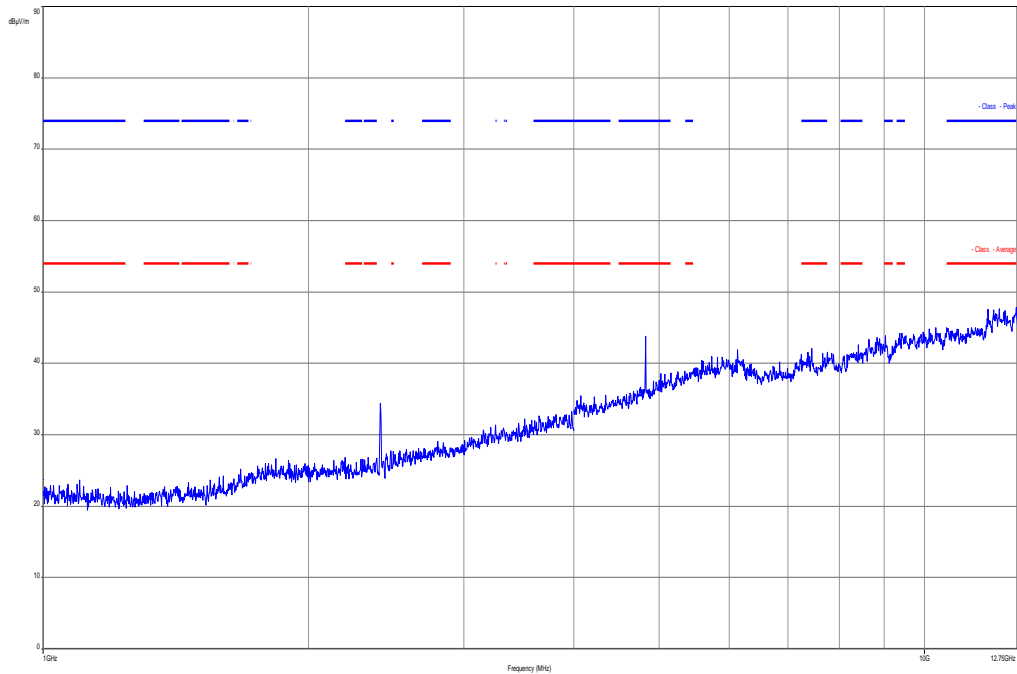

The carrier signal is notched with a 2.4 GHz band rejection filter.

Plot 3: Lowest channel, 12.75 GHz to 18 GHz, vertical & horizontal polarization

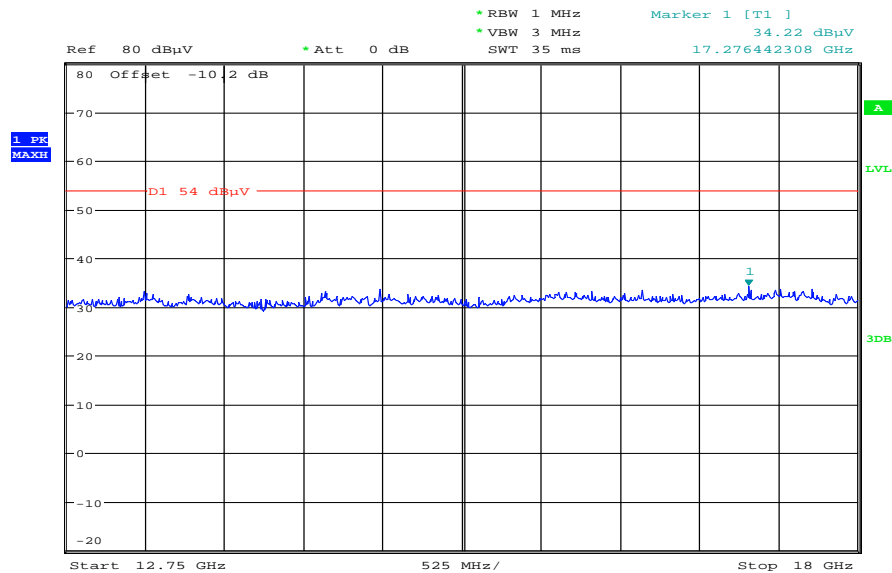

Date: 8.JAN.2013 10:21:58

Plot 4: Lowest channel, 18 GHz to 26 GHz, vertical & horizontal polarization

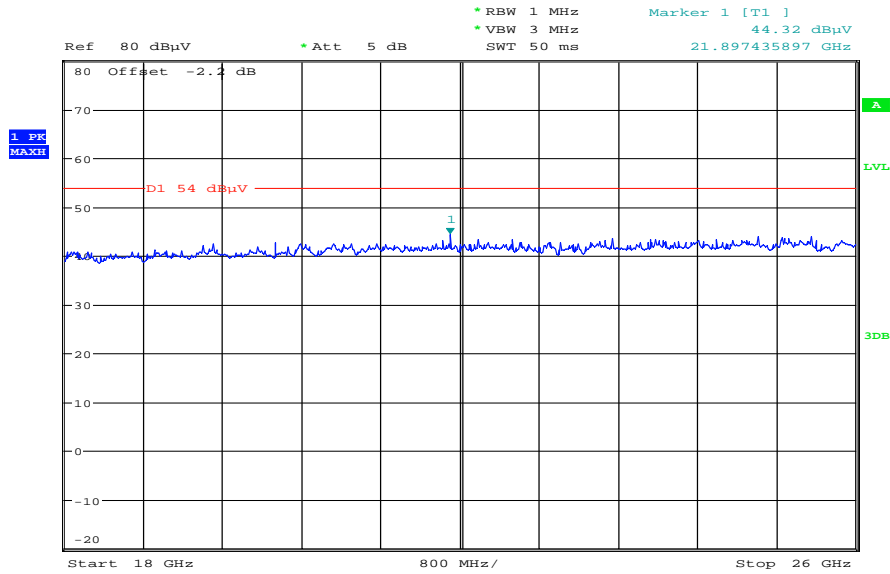

Date: 8.JAN.2013 10:39:09

Plot 5: Middle channel, 30 MHz to 1 GHz, vertical & horizontal polarization

Common Information

EUT: RFN81UW
 Serial Number: IMEI:004401139252155
 Test Description: FCC part 15 C class B @ 10m
 Operating Conditions: 802.11b TX CH7 1Mbps
 Operator Name: Wolsdorfer
 Comment: battery powered

Scan Setup: STAN_Fin [EMI radiated]

Hardware Setup: Electric Field (NOS)
 Receiver: [ESC1 3]
 Level Unit: dBµV/m

Subrange	Step Size	Detectors	IF BW	Meas. Time	Preamp
30 MHz - 2 GHz	60 kHz	QPK	120 kHz	1 s	20 dB

FCC_10m(B)_3

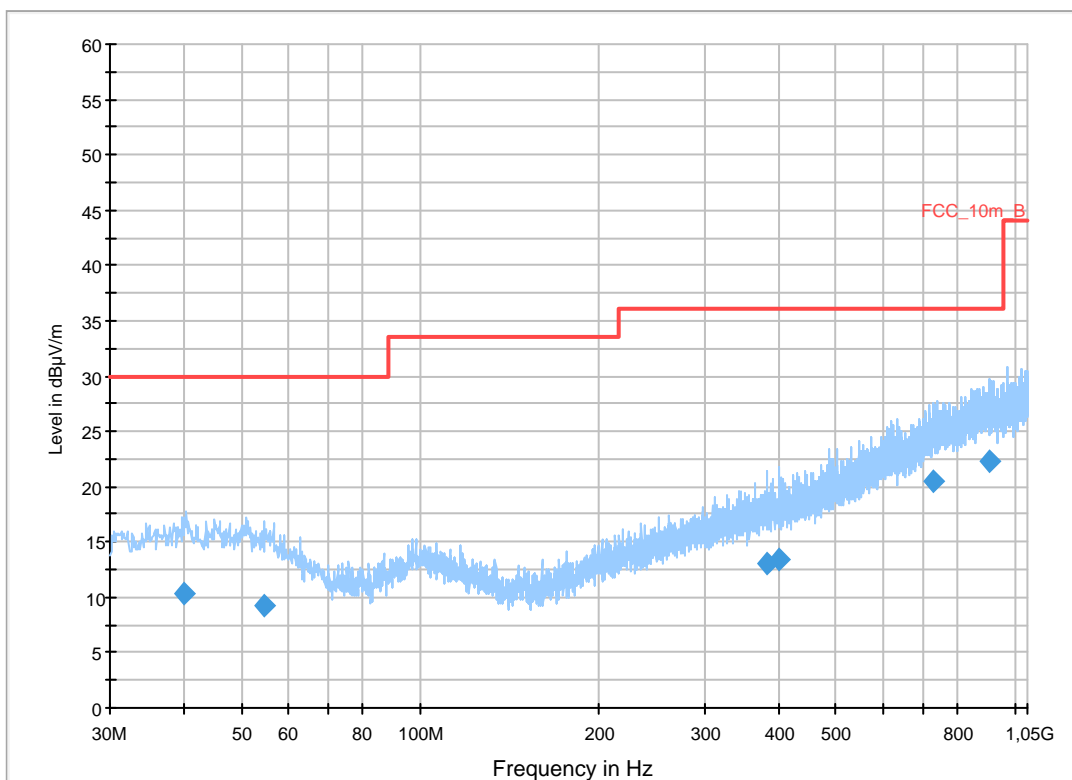

Final Result 1

Frequency (MHz)	QuasiPeak (dBµV/m)	Meas. Time (ms)	Bandwidth (kHz)	Height (cm)	Polarization	Azimuth (deg)	Corr. (dB)	Margin (dB)	Limit (dBµV/m)	Comment
39.865350	10.3	1000.0	120.000	170.0	H	100.0	13.4	19.7	30.0	
54.543300	9.3	1000.0	120.000	121.0	V	280.0	12.9	20.7	30.0	
382.478100	13.1	1000.0	120.000	112.0	H	190.0	16.6	22.9	36.0	
401.196900	13.5	1000.0	120.000	170.0	H	280.0	16.9	22.5	36.0	
727.095750	20.4	1000.0	120.000	170.0	H	190.0	23.1	15.6	36.0	
908.555400	22.3	1000.0	120.000	170.0	H	81.0	25.2	13.7	36.0	

Plot 6: Middle channel, 1 GHz to 12.75 GHz, vertical & horizontal polarization

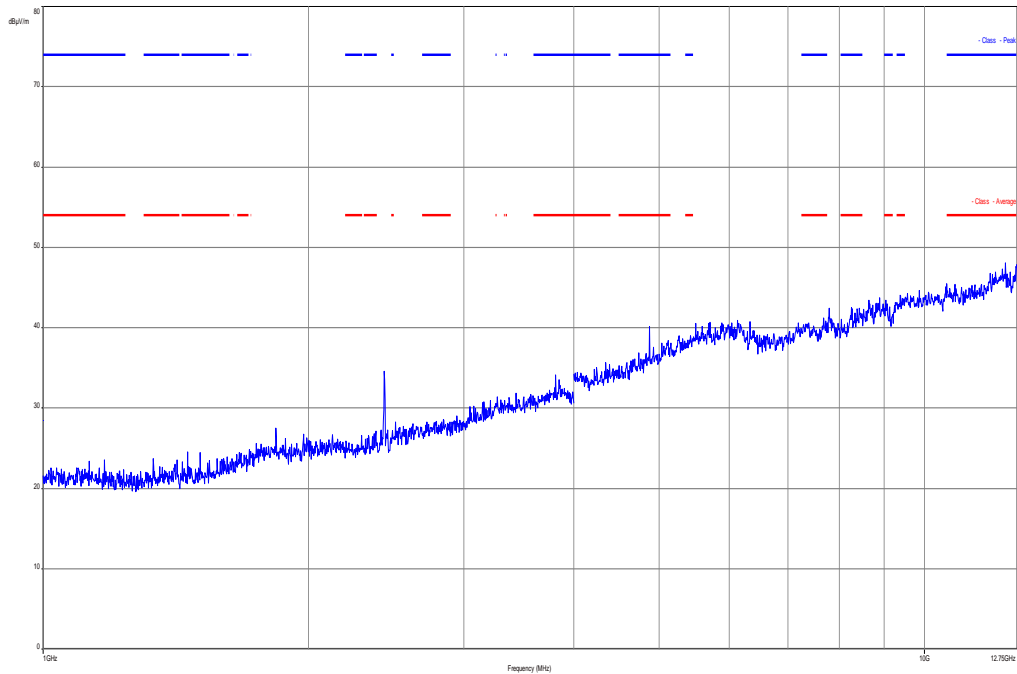

The carrier signal is notched with a 2.4 GHz band rejection filter.

Plot 7: Middle channel, 12.75 GHz to 18 GHz, vertical & horizontal polarization

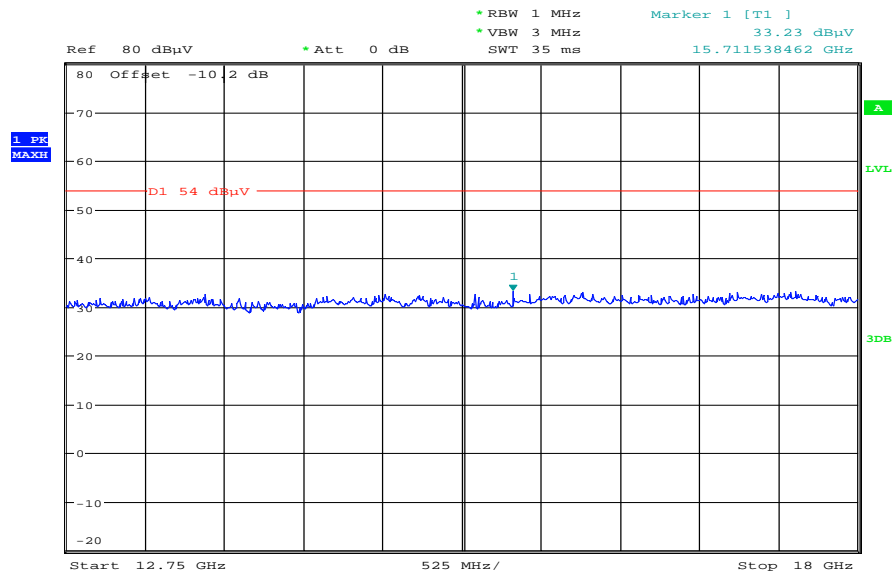

Date: 8.JAN.2013 10:23:03

Plot 8: Middle channel, 18 GHz to 26 GHz, vertical & horizontal polarization

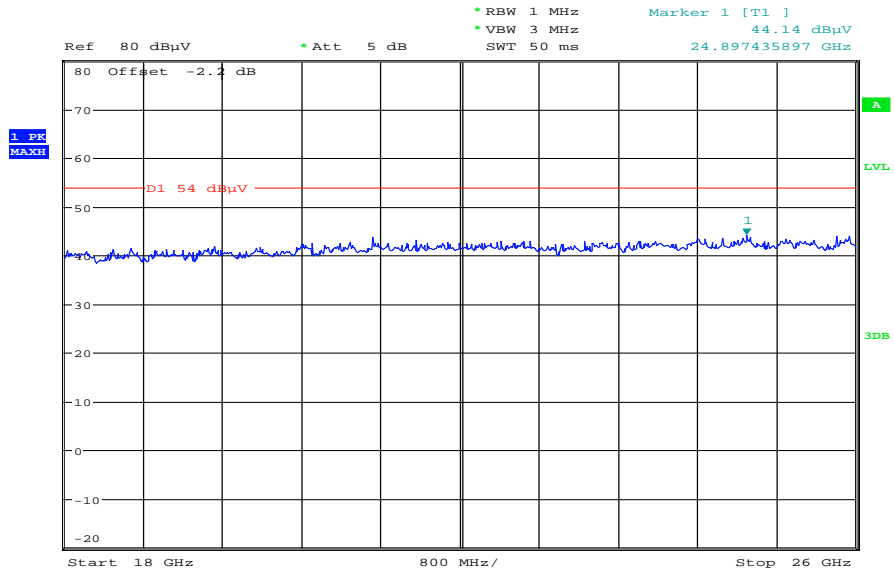

Date: 8.JAN.2013 10:44:46

Plot 9: Highest channel, 30 MHz to 1 GHz, vertical & horizontal polarization

Common Information

EUT: RFN81UW
 Serial Number: IMEI:004401139252155
 Test Description: FCC part 15 C class B @ 10m
 Operating Conditions: 802.11b TX CH11 1Mbps
 Operator Name: Wolsdorfer
 Comment: battery powered

Scan Setup: STAN_Fin [EMI radiated]

Hardware Setup: Electric Field (NOS)
 Receiver: [ESCI 3]
 Level Unit: dBµV/m

Subrange	Step Size	Detectors	IF BW	Meas. Time	Preamp
30 MHz - 2 GHz	60 kHz	QPK	120 kHz	1 s	20 dB

FCC_10m(B)_3

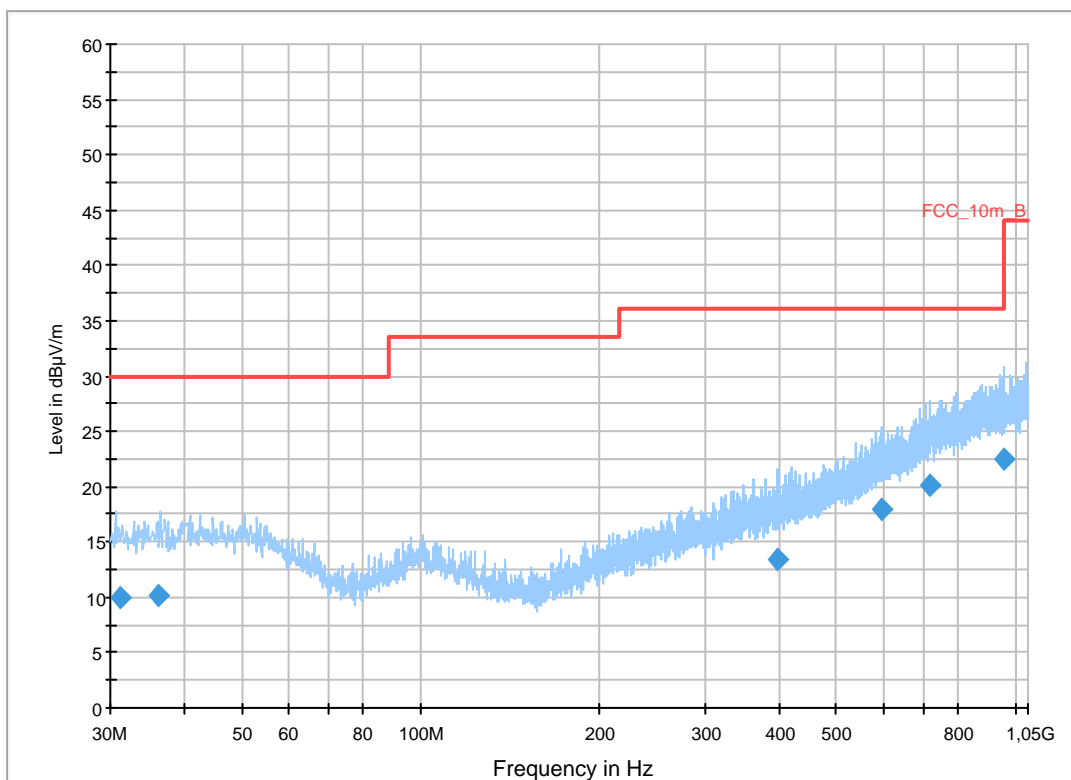

Final Result 1

Frequency (MHz)	QuasiPeak (dBµV/m)	Meas. Time (ms)	Bandwidth (kHz)	Height (cm)	Polarization	Azimuth (deg)	Corr. (dB)	Margin (dB)	Limit (dBµV/m)	Comment
31.163700	10.0	1000.0	120.000	120.0	H	177.0	12.6	20.0	30.0	
36.235950	10.2	1000.0	120.000	132.0	H	10.0	13.1	19.8	30.0	
398.113800	13.4	1000.0	120.000	170.0	H	260.0	16.9	22.6	36.0	
597.519600	18.0	1000.0	120.000	120.0	H	280.0	20.7	18.0	36.0	
716.800800	20.2	1000.0	120.000	98.0	V	88.0	22.9	15.8	36.0	
958.073250	22.5	1000.0	120.000	170.0	H	-3.0	25.4	13.5	36.0	

Plot 10: Highest channel, 1 GHz to 12.75 GHz, vertical & horizontal polarization

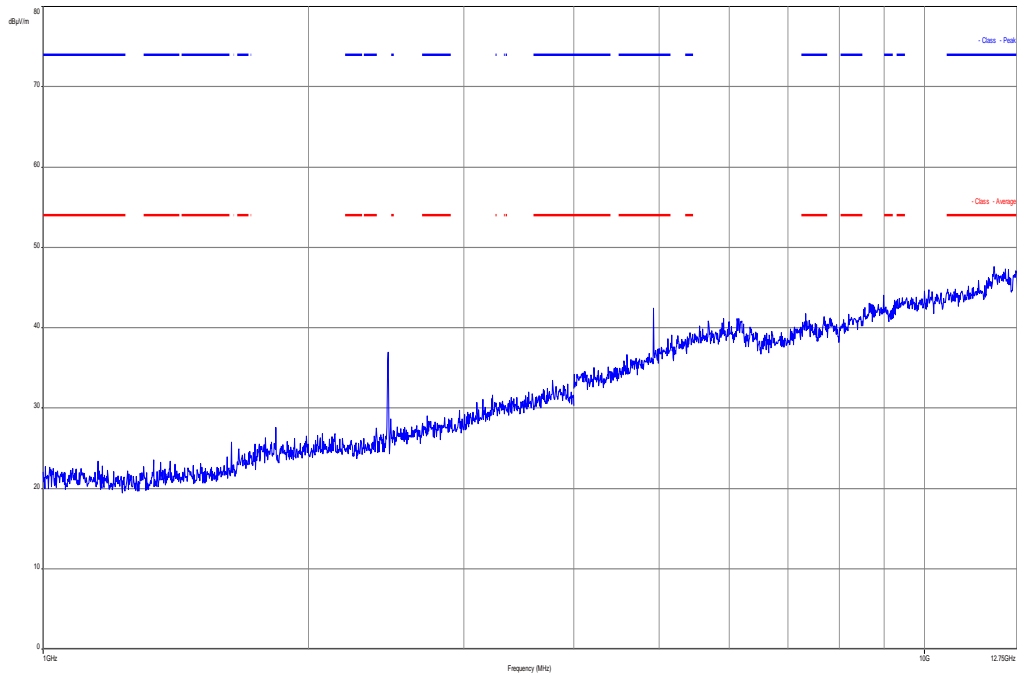

The carrier signal is notched with a 2.4 GHz band rejection filter.

Plot 11: Highest channel, 12.75 GHz to 18 GHz, vertical & horizontal polarization

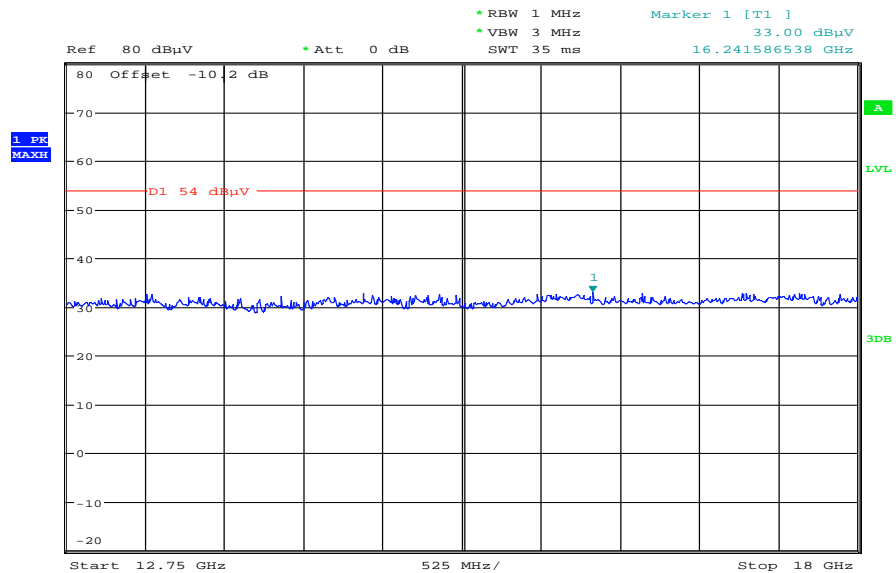

Date: 8.JAN.2013 10:24:24

Plot 12: Highest channel, 18 GHz to 26 GHz, vertical & horizontal polarization

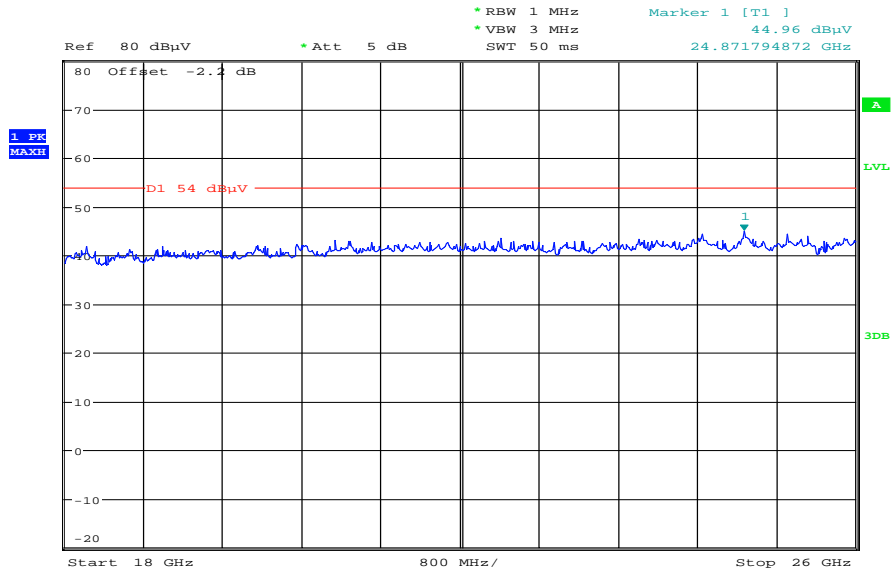

Date: 8.JAN.2013 11:10:40

Plots: OFDM / g – mode

Plot 1: Lowest channel, 30 MHz to 1 GHz, vertical & horizontal polarization

Common Information

EUT: RFN81UW
 Serial Number: IMEI:004401139252155
 Test Description: FCC part 15 C class B @ 10m
 Operating Conditions: 802.11G TX CH1 6Mbps
 Operator Name: Wolsdorfer
 Comment: battery powered

Scan Setup: STAN_Fin [EMI radiated]

Hardware Setup: Electric Field (NOS)
 Receiver: [ESCI 3]
 Level Unit: dBµV/m

Subrange	Step Size	Detectors	IF BW	Meas. Time	Preamp
30 MHz - 2 GHz	60 kHz	QPK	120 kHz	1 s	20 dB

FCC_10m(B)_3

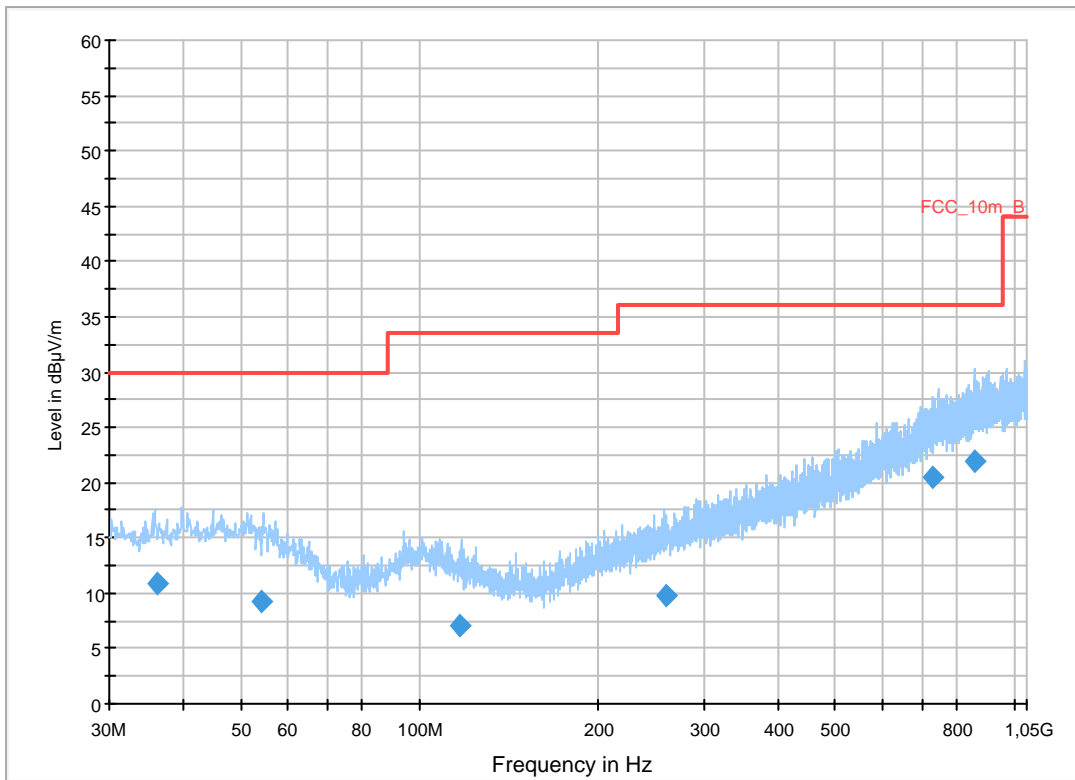

Final Result 1

Frequency (MHz)	QuasiPeak (dBµV/m)	Meas. Time (ms)	Bandwidth (kHz)	Height (cm)	Polarization	Azimuth (deg)	Corr. (dB)	Margin (dB)	Limit (dBµV/m)	Comment
36.004200	10.9	1000.0	120.000	122.0	V	268.0	13.1	19.1	30.0	
54.147900	9.2	1000.0	120.000	135.0	V	280.0	13.0	20.8	30.0	
116.645550	7.0	1000.0	120.000	135.0	V	-2.0	10.5	26.5	33.5	
258.675150	9.7	1000.0	120.000	170.0	H	280.0	13.5	26.3	36.0	
729.665400	20.5	1000.0	120.000	98.0	H	3.0	23.2	15.5	36.0	
855.394050	21.9	1000.0	120.000	170.0	H	171.0	24.6	14.1	36.0	

Plot 2: Lowest channel, 1 GHz to 12.75 GHz, vertical & horizontal polarization

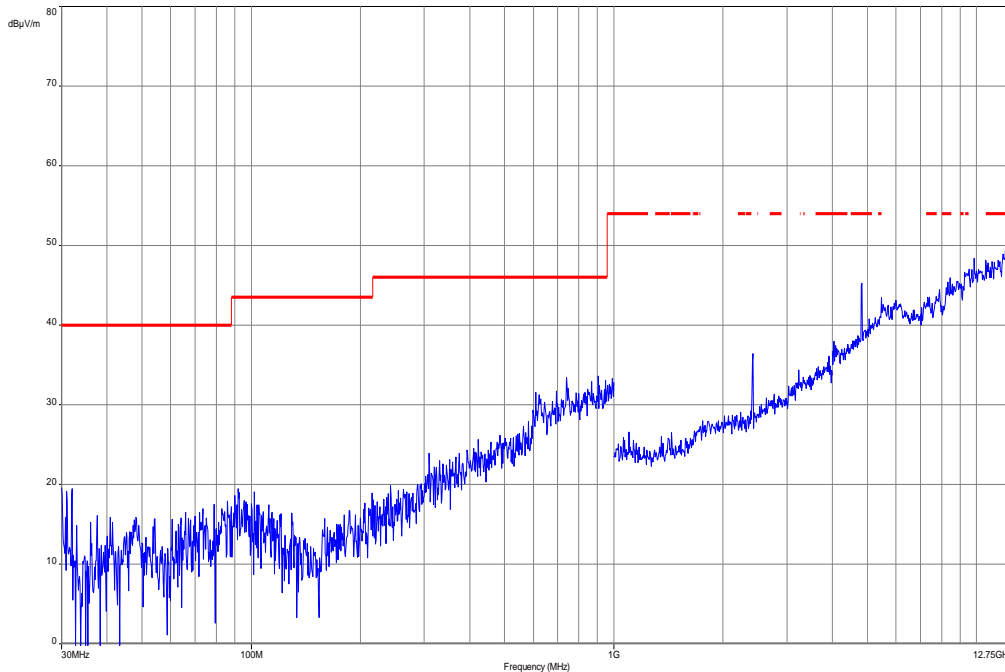

The carrier signal is notched with a 2.4 GHz band rejection filter.

Plot 3: Lowest channel, 12.75 GHz to 18 GHz, vertical & horizontal polarization

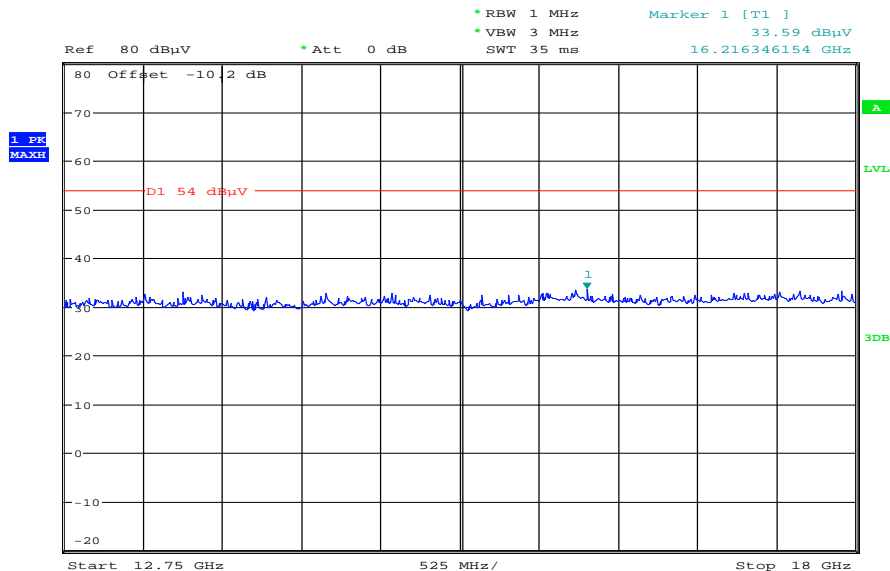

Date: 8.JAN.2013 10:25:39

Plot 4: Lowest channel, 18 GHz to 26 GHz, vertical & horizontal polarization

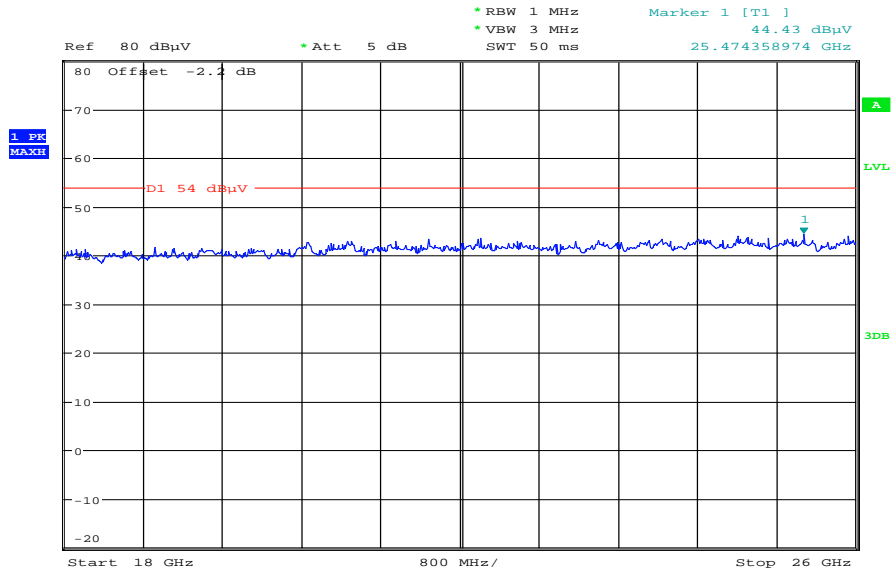

Date: 8.JAN.2013 10:48:13

Plot 5: Middle channel, 30 MHz to 1 GHz, vertical & horizontal polarization

Common Information

EUT: RFN81UW
 Serial Number: IMEI:004401139252155
 Test Description: FCC part 15 C class B @ 10m
 Operating Conditions: 802.11G TX CH7 6Mbps
 Operator Name: Wolsdorfer
 Comment: battery powered

Scan Setup: STAN_Fin [EMI radiated]

Hardware Setup: Electric Field (NOS)
 Receiver: [ESCI 3]
 Level Unit: dBµV/m

Subrange	Step Size	Detectors	IF BW	Meas. Time	Preamp
30 MHz - 2 GHz	60 kHz	QPK	120 kHz	1 s	20 dB

FCC_10m(B)_3

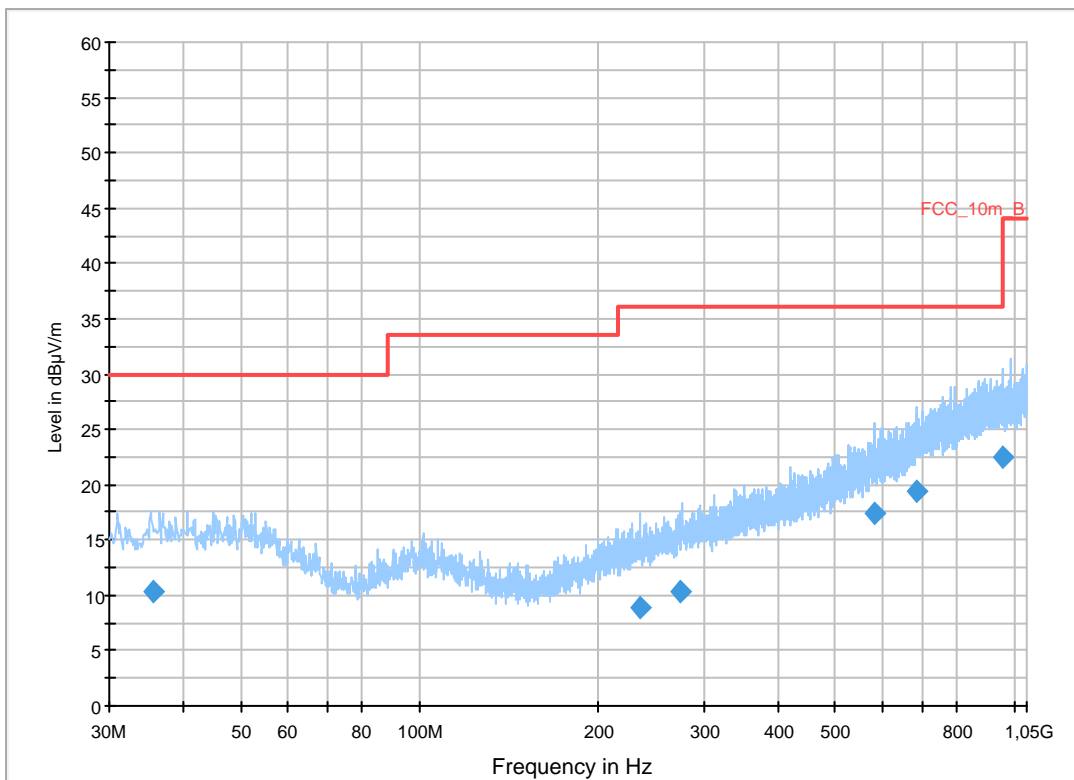

Final Result 1

Frequency (MHz)	QuasiPeak (dBµV/m)	Meas. Time (ms)	Bandwidth (kHz)	Height (cm)	Polarization	Azimuth (deg)	Corr. (dB)	Margin (dB)	Limit (dBµV/m)	Comment
35.452650	10.2	1000.0	120.000	154.0	H	81.0	13.1	19.8	30.0	
234.289800	9.0	1000.0	120.000	170.0	H	-10.0	12.8	27.0	36.0	
275.022450	10.4	1000.0	120.000	170.0	H	0.0	13.9	25.6	36.0	
581.557350	17.5	1000.0	120.000	156.0	V	178.0	20.3	18.5	36.0	
685.475100	19.4	1000.0	120.000	170.0	H	100.0	22.1	16.6	36.0	
959.171250	22.5	1000.0	120.000	121.0	V	10.0	25.4	13.5	36.0	

Plot 6: Middle channel, 1 GHz to 12.75 GHz, vertical & horizontal polarization

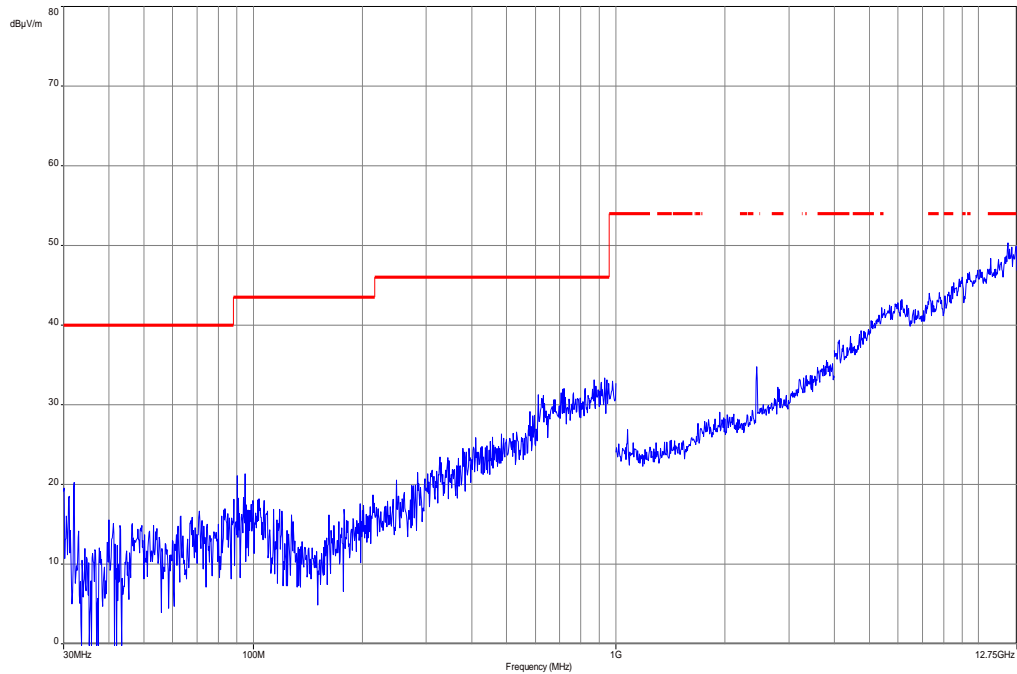

The carrier signal is notched with a 2.4 GHz band rejection filter.

Plot 7: Middle channel, 12.75 GHz to 18 GHz, vertical & horizontal polarization

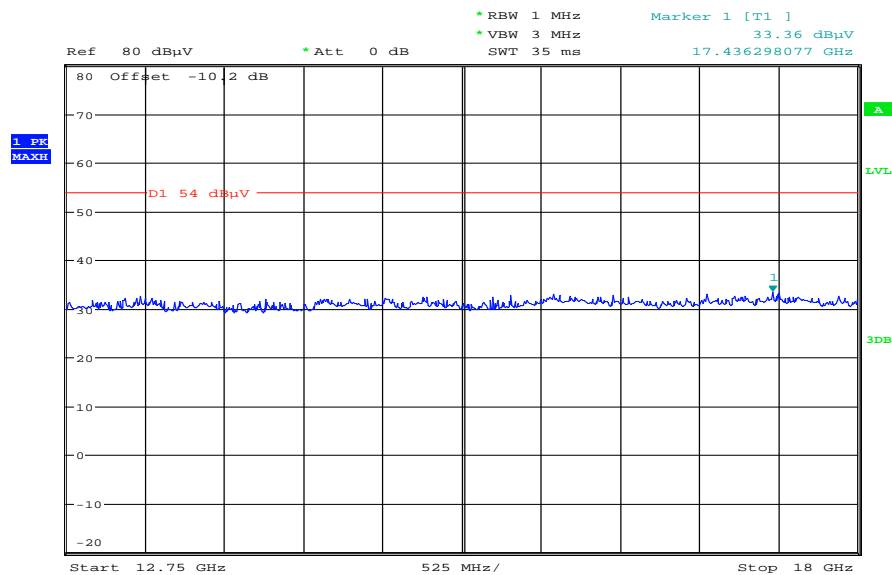

Date: 8.JAN.2013 10:26:51

Plot 8: Middle channel, 18 GHz to 26 GHz, vertical & horizontal polarization

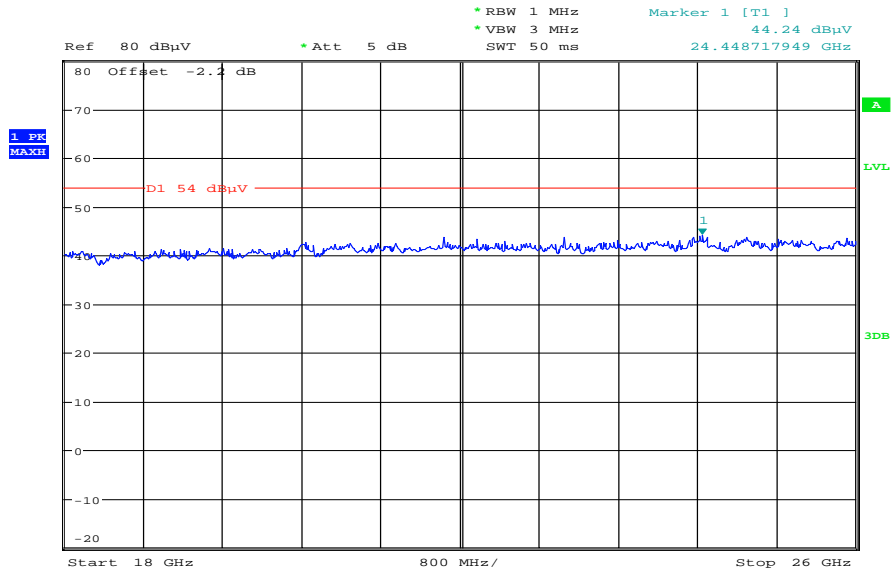

Date: 8.JAN.2013 10:49:25

Plot 9: Highest channel, 30 MHz to 1 GHz, vertical & horizontal polarization

Common Information

EUT: RFN81UW
 Serial Number: IMEI:004401139252155
 Test Description: FCC part 15 C class B @ 10m
 Operating Conditions: 802.11G TX CH11 6Mbps
 Operator Name: Wolsdorfer
 Comment: battery powered

Scan Setup: STAN_Fin [EMI radiated]

Hardware Setup: Electric Field (NOS)
 Receiver: [ESCI 3]
 Level Unit: dBµV/m

Subrange	Step Size	Detectors	IF BW	Meas. Time	Preamp
30 MHz - 2 GHz	60 kHz	QPK	120 kHz	1 s	20 dB

FCC_10m(B)_3

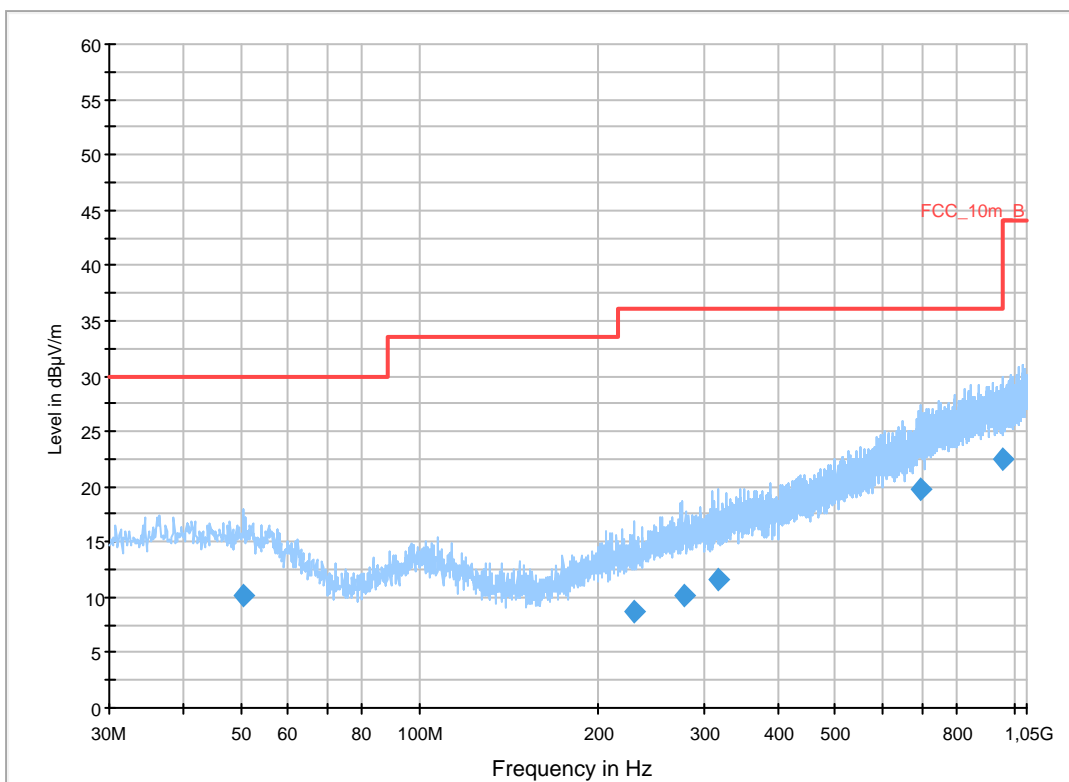

Final Result 1

Frequency (MHz)	QuasiPeak (dBµV/m)	Meas. Time (ms)	Bandwidth (kHz)	Height (cm)	Polarization	Azimuth (deg)	Corr. (dB)	Margin (dB)	Limit (dBµV/m)	Comment
50.598600	10.2	1000.0	120.000	98.0	H	183.0	13.3	19.8	30.0	
228.675900	8.7	1000.0	120.000	170.0	V	280.0	12.7	27.3	36.0	
277.353450	10.1	1000.0	120.000	170.0	V	270.0	14.0	25.9	36.0	
318.218550	11.7	1000.0	120.000	170.0	H	268.0	15.1	24.3	36.0	
697.964850	19.8	1000.0	120.000	170.0	H	190.0	22.4	16.2	36.0	
956.334000	22.4	1000.0	120.000	113.0	H	190.0	25.4	13.6	36.0	

Plot 10: Highest channel, 1 GHz to 12.75 GHz, vertical & horizontal polarization

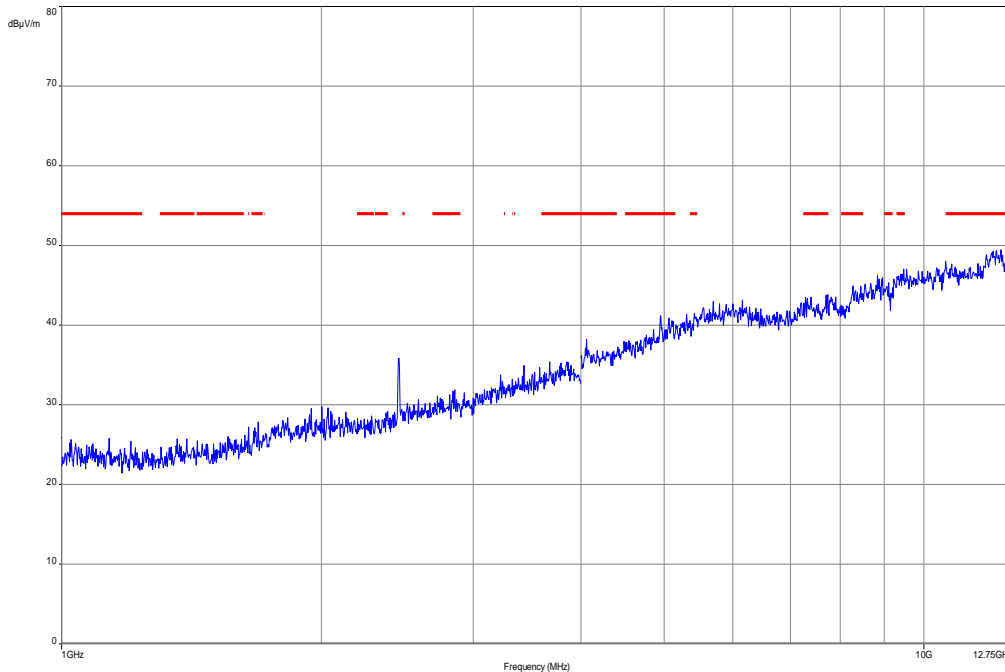

The carrier signal is notched with a 2.4 GHz band rejection filter.

Plot 11: Highest channel, 12.75 GHz to 18 GHz, vertical & horizontal polarization

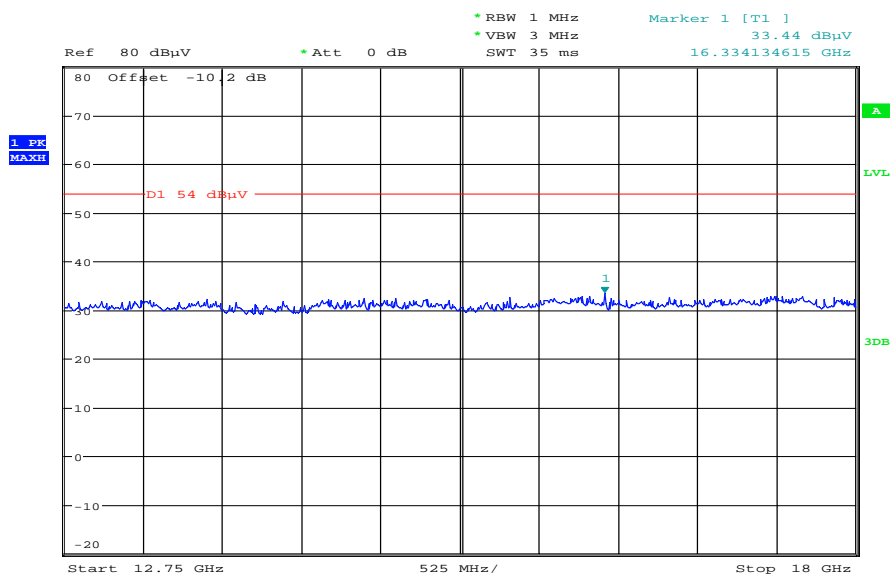

Date: 8.JAN.2013 10:27:50

Plot 12: Highest channel, 18 GHz to 26 GHz, vertical & horizontal polarization

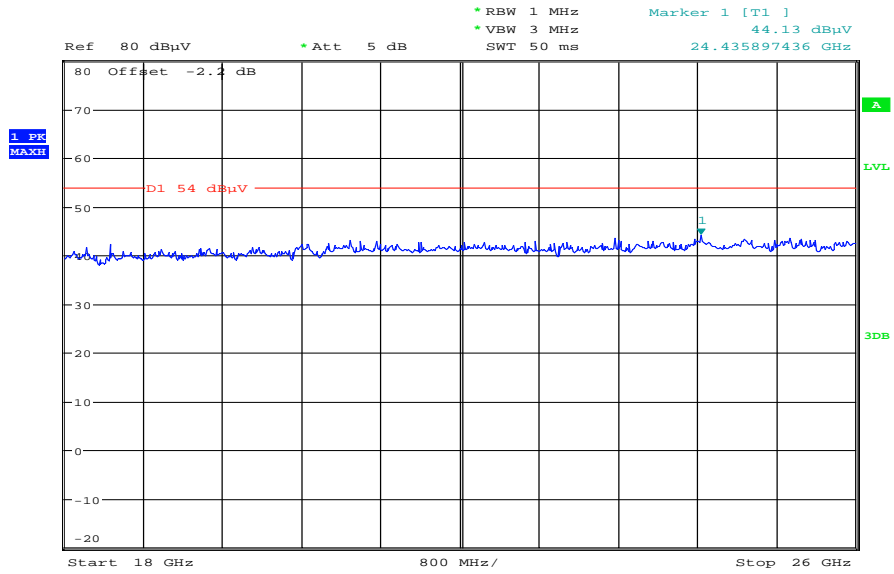

Date: 8.JAN.2013 10:50:31

Plots: OFDM / n – mode

Plot 1: Lowest channel, 30 MHz to 1 GHz, vertical & horizontal polarization

Common Information

EUT: RFN81UW
 Serial Number: IMEI:004401139252155
 Test Description: FCC part 15 C class B @ 10m
 Operating Conditions: 802.11N TX CH1 MCS 0
 Operator Name: Wolsdorfer
 Comment: battery powered

Scan Setup: STAN_Fin [EMI radiated]

Hardware Setup: Electric Field (NOS)
 Receiver: [ESC1 3]
 Level Unit: dBµV/m

Subrange	Step Size	Detectors	IF BW	Meas. Time	Preamp
30 MHz - 2 GHz	60 kHz	QPK	120 kHz	1 s	20 dB
FCC_10m(B)_3					

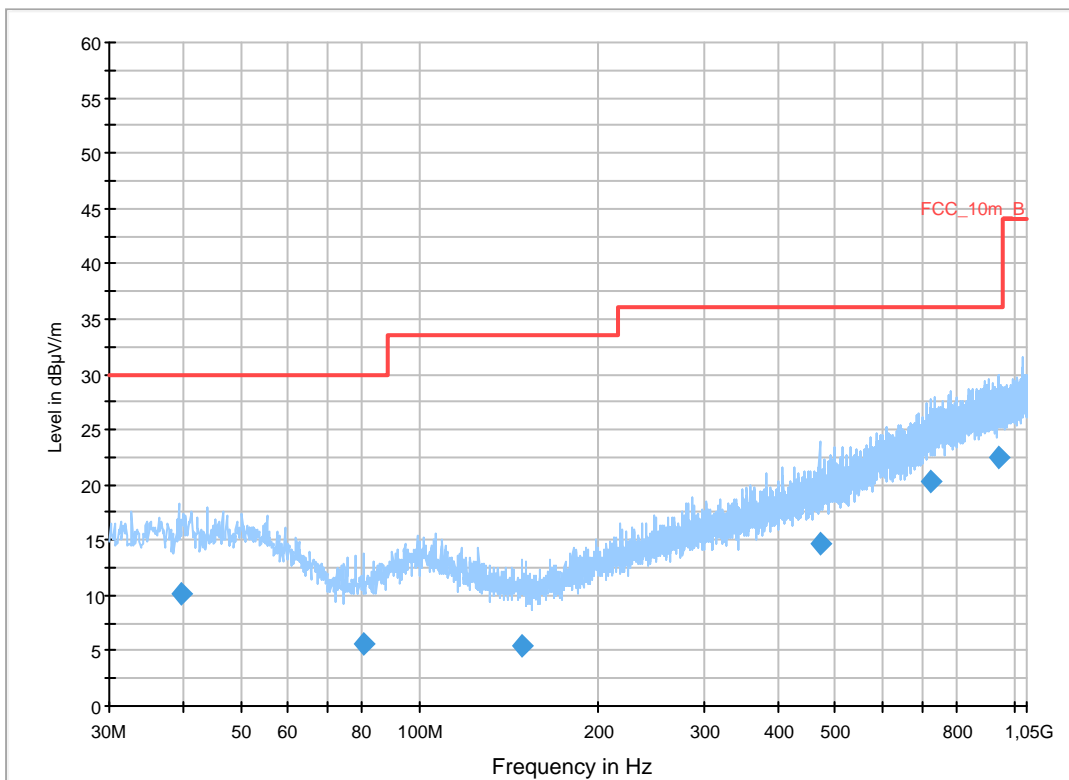

Final Result 1

Frequency (MHz)	QuasiPeak (dBµV/m)	Meas. Time (ms)	Bandwidth (kHz)	Height (cm)	Polarization	Azimuth (deg)	Corr. (dB)	Margin (dB)	Limit (dBµV/m)	Comment
39.739350	10.2	1000.0	120.000	121.0	H	80.0	13.4	19.8	30.0	
80.318250	5.7	1000.0	120.000	134.0	H	171.0	9.1	24.3	30.0	
148.601550	5.4	1000.0	120.000	170.0	V	10.0	8.9	28.1	33.5	
470.322300	14.7	1000.0	120.000	112.0	H	100.0	18.1	21.3	36.0	
724.685850	20.3	1000.0	120.000	170.0	H	268.0	23.1	15.7	36.0	
941.808450	22.5	1000.0	120.000	170.0	V	-10.0	25.3	13.5	36.0	

Plot 2: Lowest channel, 1 GHz to 12.75 GHz, vertical & horizontal polarization

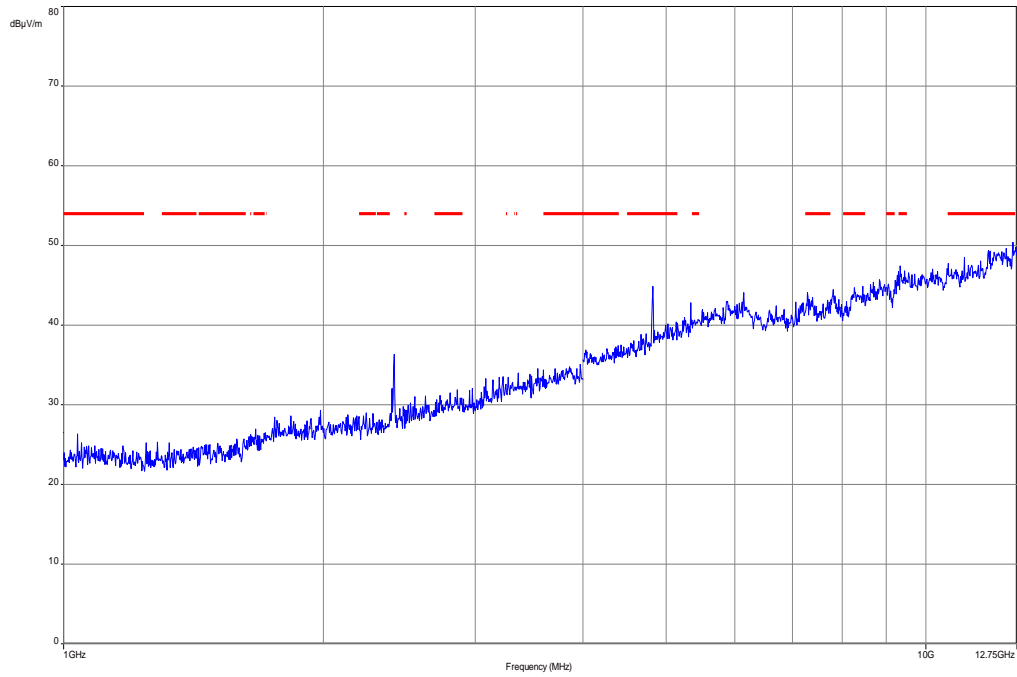

The carrier signal is notched with a 2.4 GHz band rejection filter.

Plot 3: Lowest channel, 12.75 GHz to 18 GHz, vertical & horizontal polarization

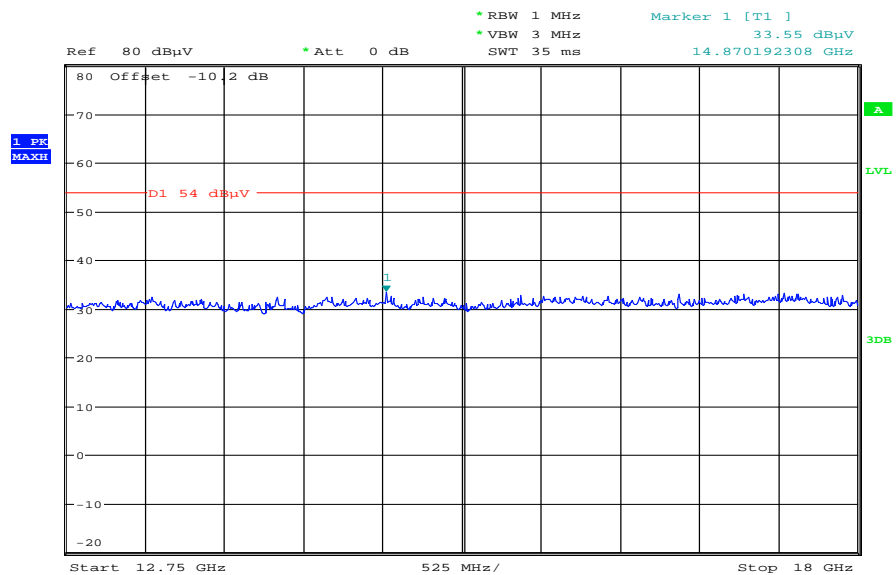

Date: 8.JAN.2013 10:28:52

Plot 4: Lowest channel, 18 GHz to 26 GHz, vertical & horizontal polarization

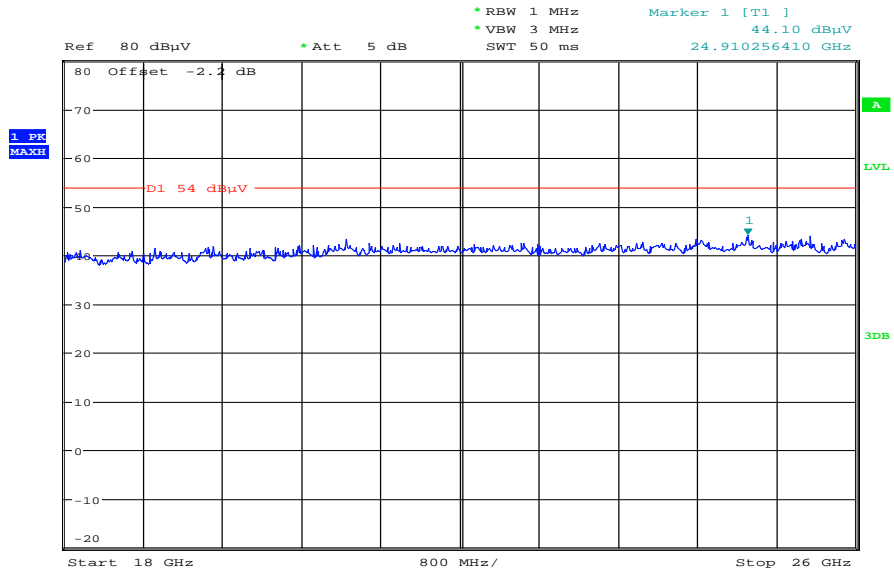

Date: 8.JAN.2013 10:55:35

Plot 5: Middle channel, 30 MHz to 1 GHz, vertical & horizontal polarization

Common Information

EUT: RFN81UW
 Serial Number: IMEI:004401139252155
 Test Description: FCC part 15 C class B @ 10m
 Operating Conditions: 802.11N TX CH7 MCS 0
 Operator Name: Wolsdorfer
 Comment: battery powered

Scan Setup: STAN_Fin [EMI radiated]

Hardware Setup: Electric Field (NOS)
 Receiver: [ESCI 3]
 Level Unit: dBµV/m

Subrange	Step Size	Detectors	IF BW	Meas. Time	Preamp
30 MHz - 2 GHz	60 kHz	QPK	120 kHz	1 s	20 dB

FCC_10m(B)_3

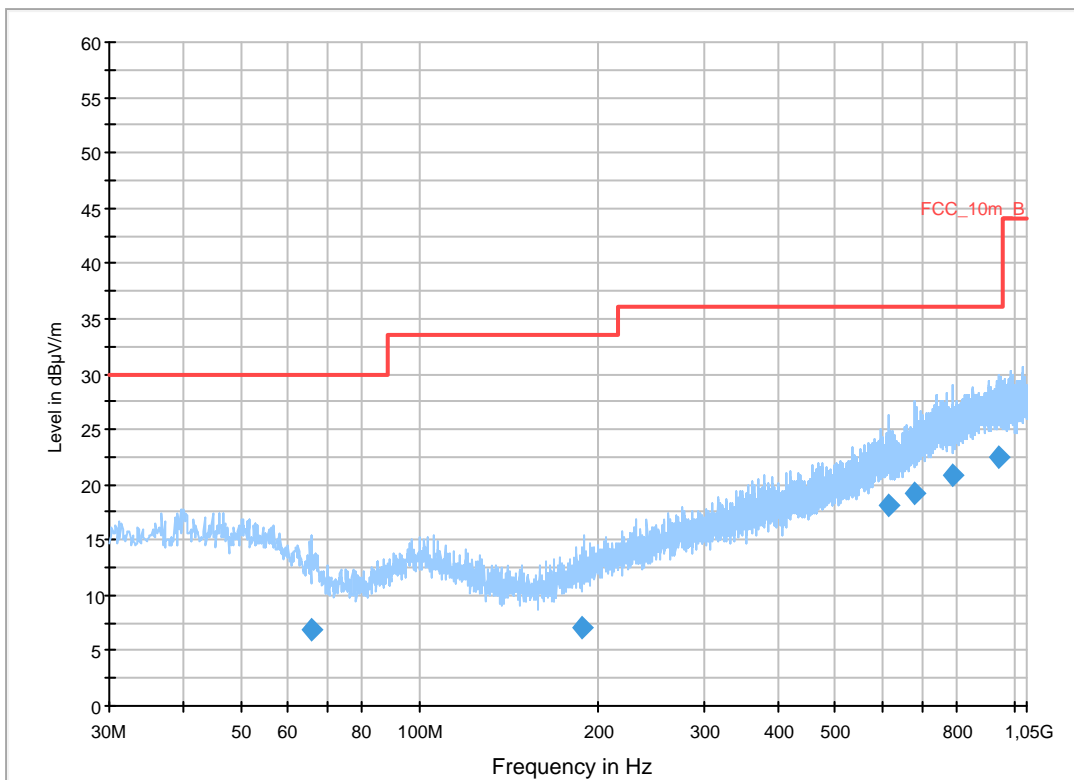

Final Result 1

Frequency (MHz)	QuasiPeak (dBµV/m)	Meas. Time (ms)	Bandwidth (kHz)	Height (cm)	Polarization	Azimuth (deg)	Corr. (dB)	Margin (dB)	Limit (dBµV/m)	Comment
65.799150	6.9	1000.0	120.000	162.0	H	-10.0	10.2	23.1	30.0	
188.024700	7.0	1000.0	120.000	170.0	H	190.0	11.0	26.5	33.5	
616.059150	18.2	1000.0	120.000	170.0	H	-4.0	20.9	17.8	36.0	
680.607450	19.1	1000.0	120.000	98.0	H	261.0	22.0	16.9	36.0	
785.371500	20.8	1000.0	120.000	170.0	H	100.0	23.8	15.2	36.0	
945.481950	22.6	1000.0	120.000	161.0	V	171.0	25.3	13.4	36.0	

Plot 6: Middle channel, 1 GHz to 12.75 GHz, vertical & horizontal polarization

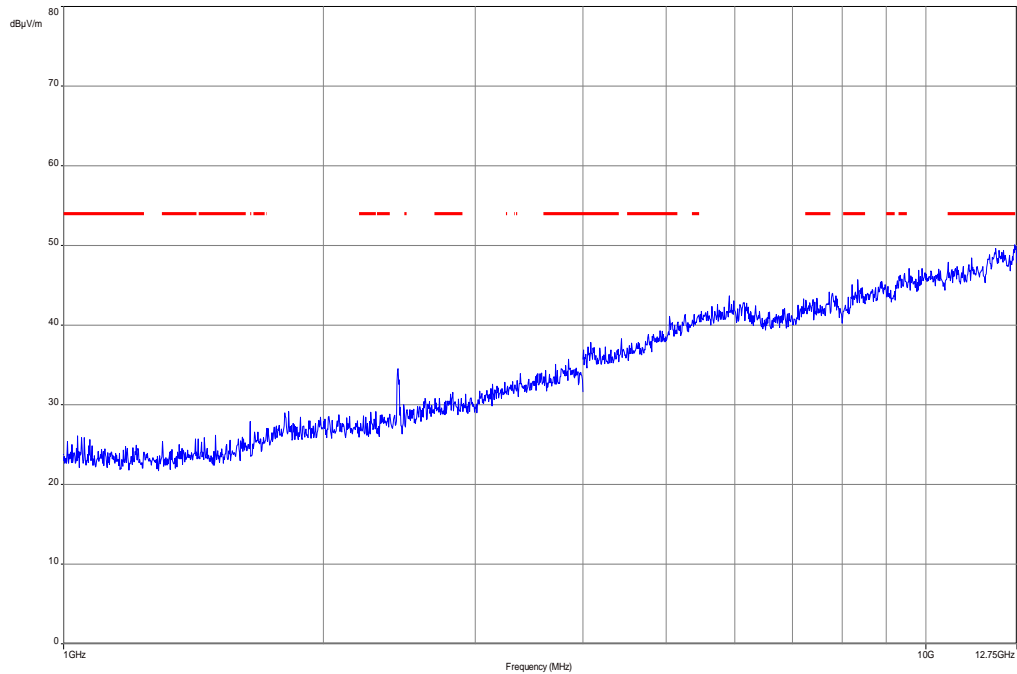

The carrier signal is notched with a 2.4 GHz band rejection filter.

Plot 7: Middle channel, 12.75 GHz to 18 GHz, vertical & horizontal polarization

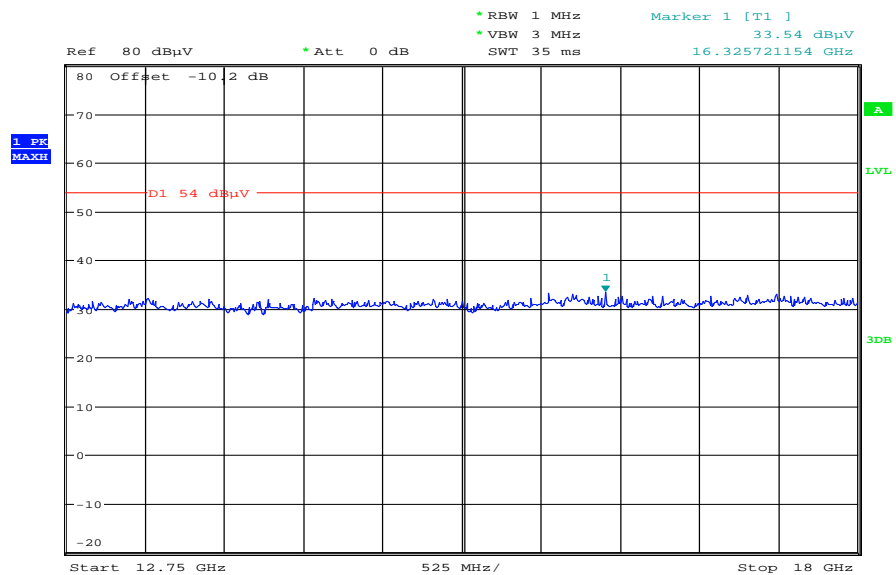

Date: 8.JAN.2013 10:29:57

Plot 8: Middle channel, 18 GHz to 26 GHz, vertical & horizontal polarization

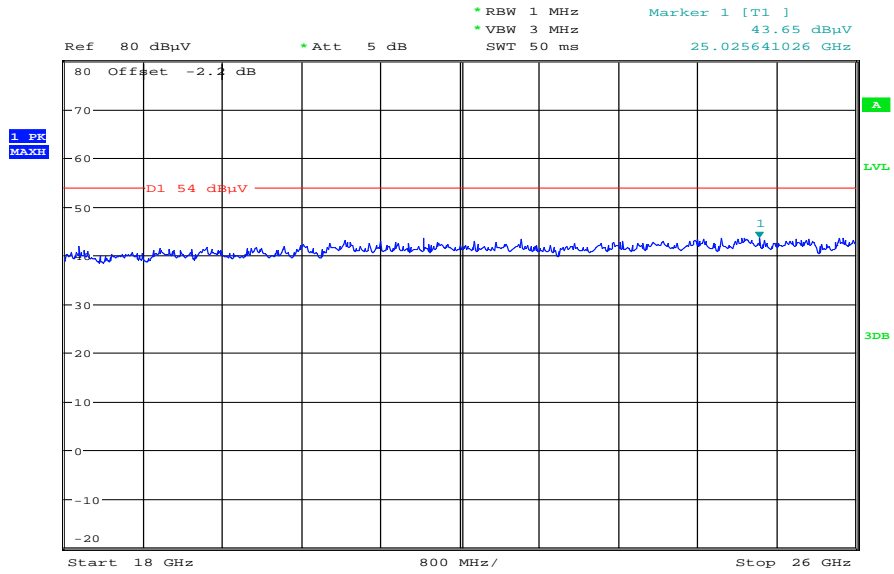

Date: 8.JAN.2013 10:54:00

Plot 9: Highest channel, 30 MHz to 1 GHz, vertical & horizontal polarization

Common Information

EUT: RFN81UW
 Serial Number: IMEI:004401139252155
 Test Description: FCC part 15 C class B @ 10m
 Operating Conditions: 802.11N TX CH11 MCS 0
 Operator Name: Wolsdorfer
 Comment: battery powered

Scan Setup: STAN_Fin [EMI radiated]

Hardware Setup: Electric Field (NOS)
 Receiver: [ESC1 3]
 Level Unit: dBµV/m

Subrange	Step Size	Detectors	IF BW	Meas. Time	Preamp
30 MHz - 2 GHz	60 kHz	QPK	120 kHz	1 s	20 dB

FCC_10m(B)_3

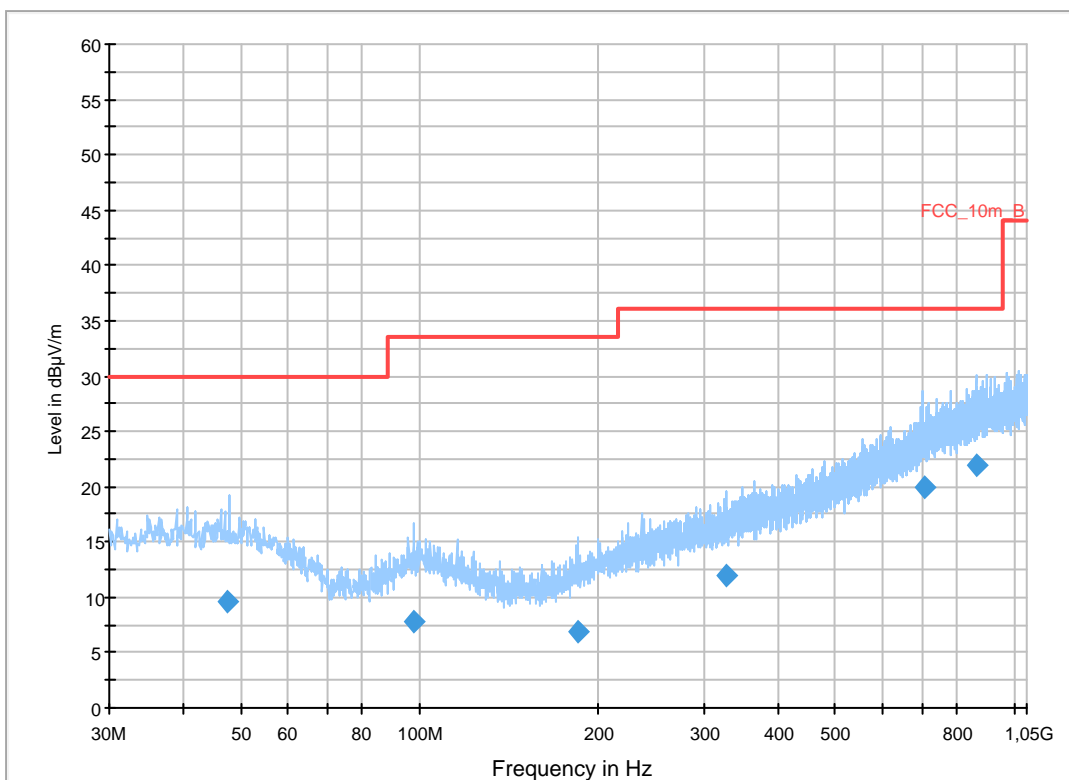

Final Result 1

Frequency (MHz)	QuasiPeak (dBµV/m)	Meas. Time (ms)	Bandwidth (kHz)	Height (cm)	Polarization	Azimuth (deg)	Corr. (dB)	Margin (dB)	Limit (dBµV/m)	Comment
47.502600	9.6	1000.0	120.000	105.0	V	10.0	13.3	20.4	30.0	
97.471200	7.7	1000.0	120.000	152.0	H	265.0	11.6	25.8	33.5	
184.684950	6.9	1000.0	120.000	105.0	V	0.0	10.7	26.6	33.5	
327.669150	11.9	1000.0	120.000	170.0	H	280.0	15.4	24.1	36.0	
704.061300	19.9	1000.0	120.000	98.0	V	183.0	22.6	16.1	36.0	
861.584850	22.0	1000.0	120.000	170.0	H	0.0	24.7	14.0	36.0	

Plot 10: Highest channel, 1 GHz to 12.75 GHz, vertical & horizontal polarization

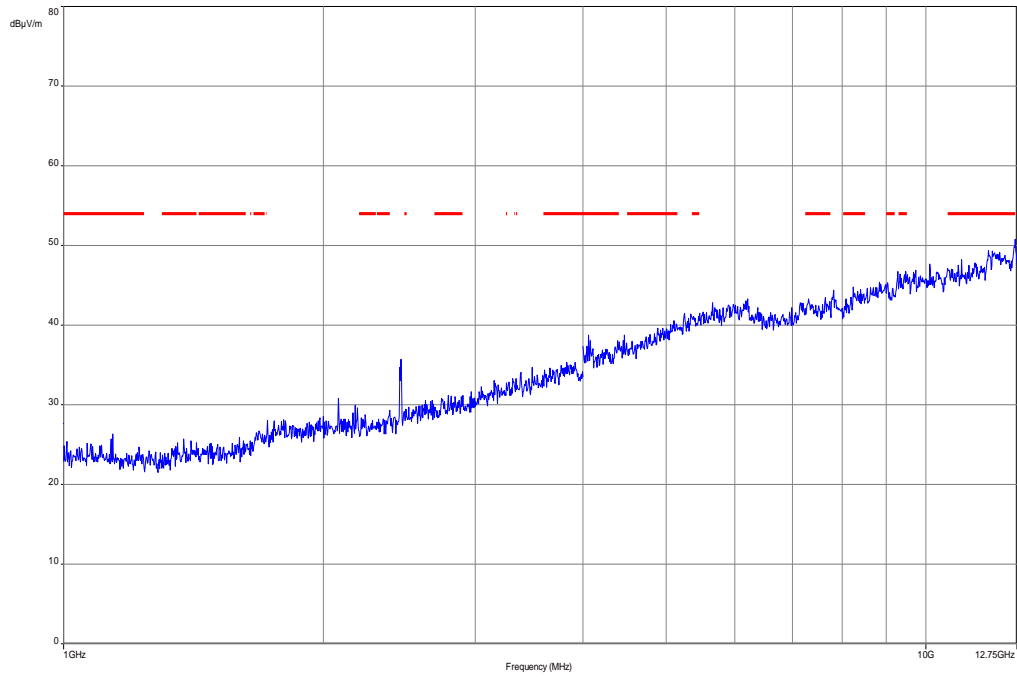

The carrier signal is notched with a 2.4 GHz band rejection filter.

Plot 11: Highest channel, 12.75 GHz to 18 GHz, vertical & horizontal polarization

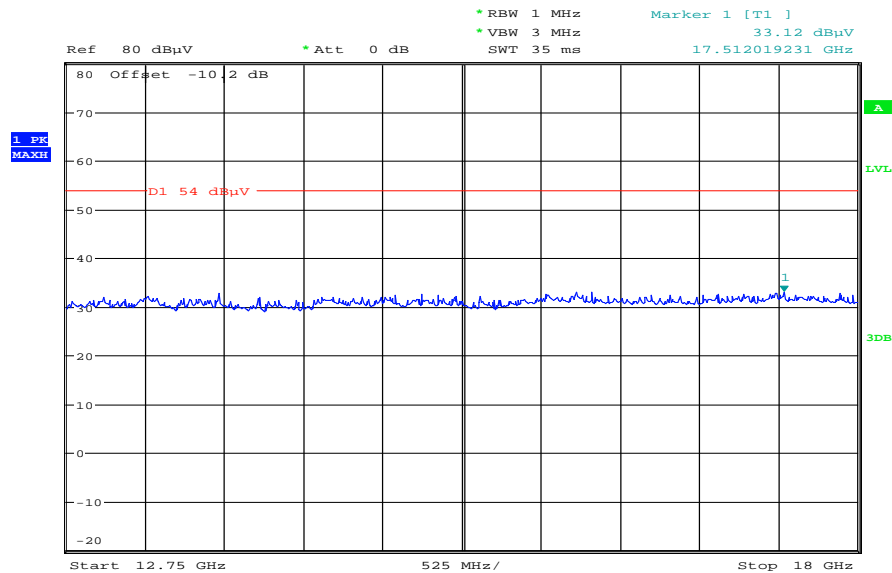

Date: 8.JAN.2013 10:30:50

Plot 12: Highest channel, 18 GHz to 26 GHz, vertical & horizontal polarization

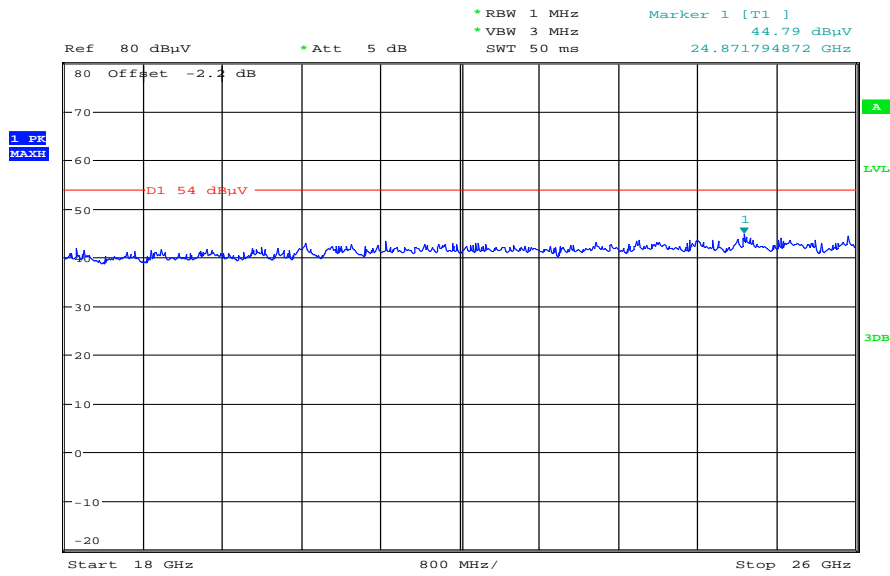

Date: 8.JAN.2013 10:55:13

9.11 RX spurious emissions radiated

Not performed! Reduced tests only!

9.12 Spurious emissions radiated < 30 MHz

Not performed! Reduced tests only!

9.13 Spurious emissions conducted < 30 MHz

Not performed! Reduced tests only!

10 Test equipment and ancillaries used for tests

Typically, the calibrations of the test apparatus are commissioned to and performed by an accredited calibration laboratory. The calibration intervals are determined in accordance with the DIN EN ISO/IEC 17025. In addition to the external calibrations, the laboratory executes comparison measurements with other calibrated test systems or effective verifications. Weekly chamber inspections and range calibrations are performed. Where possible, rf-generating and signalling equipment as well as measuring receivers and analyzers are connected to an external high-precision 10 MHz reference (GPS-based or rubidium frequency standard).

In order to simplify the identification of the equipment used at some special tests, some items of test equipment and ancillaries can be provided with an identifier or number in the equipment list below (Labor/Item).

No.	Lab / Item	Equipment	Type	Manufact.	Serial No.	INV. No Cetecom	Kind of Calibration	Last Calibration	Next Calibration
1	45	Switch-Unit	3488A	HP Meßtechnik	2719A14505	300000368	g		
2	50	DC power supply, 60Vdc, 50A, 1200 W	6032A	HP Meßtechnik	2920A04466	300000580	ne		
3	n. a.	software	SPS_PHE 1.4f	Spitzberger & Spieß	B5981; 5D1081;B597 9	300000210	ne		
4	n. a.	EMI Test Receiver	ESCI 1166.5950. 03	R&S	100083	300003312	k		
5	n. a.	Analyzer- Reference- System (Harmonics and Flicker)	ARS 16/1	SPS	A3509 07/0 0205	300003314	k	14.07.2011	14.07.2013
6	n. a.	Amplifier	JS42- 00502650- 28-5A	MITEQ	1084532	300003379	ev		
7	n. a.	Antenna Tower	Model 2175	ETS- LINDGREN	64762	300003745	izw		
8	n. a.	Positioning Controller	Model 2090	ETS- LINDGREN	64672	300003746	izw		
9	n. a.	Turntable Interface-Box	Model 105637	ETS- LINDGREN	44583	300003747	izw		
10	n. a.	TRIOLOG Broadband Test-Antenna 30 MHz - 3 GHz	VULB9163	Schwarzbe ck	295	300003787	k	12.04.2012	12.04.2014
11	n. a.	Spectrum- Analyzer	FSU26	R&S	200809	300003874	k	06.01.2012	06.01.2014
12	n. a.	Double-Ridged Waveguide Horn Antenna 1-18.0GHz	3115	EMCO	8812-3088	300001032	vIKI!	11.05.2011	11.05.2013
13	n. a.	Anechoic chamber	FAC 3/5m	MWB / TDK	87400/02	300000996	ev		
14	9	Isolating Transformer	MPL IEC625 Bus Regeltrennt ravo	Erfi	91350	300001155	ne		
15	n. a.	Three-Way Power Splitter, 50 Ohm	11850C	HP Meßtechnik		300000997	ne		
16	n. a.	Amplifier	js42- 00502650- 28-5a	Parzich GMBH	928979	300003143	ne		
17	n. a.	Band Reject filter	WRCG240 0/2483- 2375/2505- 50/10SS	Wainwright	11	300003351	ev		
18	n. a.	TRIOLOG Broadband Test-Antenna 30 MHz - 3 GHz	VULB9163	Schwarzbe ck	371	300003854	vIKI!	14.10.2011	14.10.2014
19	n. a.	MXE EMI Receiver 20 Hz bis 26,5 GHz	N9038A	Agilent Technologi es	MY51210197	300004405	k		
20	A026	Std. Gain Horn Antenna 12.4 to 18.0 GHz	639	Narda		300000787	ne		
21	A029	Std. Gain Horn	638	Narda		300002442	ne		

		Antenna 18.0 to 26.5 GHz							
22	11b	Microwave System Amplifier, 0.5-26.5 GHz	83017A	HP Meßtechnik	00419	300002268	ev		
23	n. a.	Spectrum Analyzer 20 Hz - 50 GHz	FSU50	R&S	200012	300003443	Ve	09.10.2012	09.10.2014

Agenda: Kind of Calibration

- | | | | |
|------|--|-----|--|
| k | calibration / calibrated | EK | limited calibration |
| ne | not required (k, ev, izw, zw not required) | zw | cyclical maintenance (external cyclical maintenance) |
| ev | periodic self verification | izw | internal cyclical maintenance |
| Ve | long-term stability recognized | g | blocked for accredited testing |
| vlk! | Attention: extended calibration interval | * | next calibration ordered / currently in progress |
| NK! | Attention: not calibrated | | |

11 Observations

No observations exceeding those reported with the single test cases have been made.

Annex A Document history

Version	Applied changes	Date of release
1.0	Initial release	2013-01-09
-A	Addition of HW / SW status and FCC / IC number	2013-03-05
-B	Editorial changes	2013-03-08

Annex B Further information**Glossary**

AVG	-	Average
DUT	-	Device under test
EMC	-	Electromagnetic Compatibility
EN	-	European Standard
EUT	-	Equipment under test
ETSI	-	European Telecommunications Standard Institute
FCC	-	Federal Communication Commission
FCC ID	-	Company Identifier at FCC
HW	-	Hardware
IC	-	Industry Canada
Inv. No.	-	Inventory number
N/A	-	Not applicable
PP	-	Positive peak
QP	-	Quasi peak
S/N	-	Serial number
SW	-	Software

Annex C Accreditation Certificate



Deutsche Akkreditierungsstelle GmbH
German Accreditation Body

Entrusted according to Section 8 subsection 1 AkkStelleG in connection with Section 1 subsection 1 AkkStelleGBV
Signatory to the Multilateral Agreements of EA, ILAC and IAF for Mutual Recognition

Accreditation



The Deutsche Akkreditierungsstelle GmbH (German Accreditation Body) attests that the testing laboratory

CETECOM ICT Services GmbH
Untertürkheimer Straße 6-10
66117 Saarbrücken

is competent under the terms of DIN EN ISO/IEC 17025:2005 to carry out tests in the following fields:

- Wired communications and DECT
- Acoustic
- Radio
- Shirt Range Devices (SRD)
- RFID
- WiMax and Richtfunk
- Mobile radio (GSM / DCS), Over the Air (OTA) Performance
- Electromagnetic Compatibility (EMC) incl. Automotive
- Product safety
- SAR and Hearing Aid Compatibility (HAC)
- Environmental simulation
- Smart Card Terminals
- Bluetooth
- Wi-Fi-Services

The accreditation certificate shall only apply in connection with the notice of accreditation of 13.04.2011 with the accreditation number D-PL-12076-01 and is valid until 03.09.2014. It comprises the cover sheet, the reverse side of the cover sheet and the following annex with a total of 82 pages.

Registration number of the certificate: **D-PL-12076-01-01**

Frankfurt am Main, 13.04.2011

Dipl.-Ing. (FH) Dr. Egner
Head of Division 2

This document is a translation. The definitive version is the original German accreditation certificate.
www.dakks.de

Deutsche Akkreditierungsstelle GmbH

Office Berlin
Spittelmarkt 10
10117 Berlin

Office Frankfurt am Main
Gartenstraße 6
60594 Frankfurt am Main

Office Braunschweig
Bundesallee 100
38116 Braunschweig

The publication of extracts of the accreditation certificate is subject to the prior written approval by Deutsche Akkreditierungsstelle GmbH (DAkkS). Exempted is the unchanged form of separate disseminations of the cover sheet by the conformity assessment body mentioned overleaf.

No impression shall be made that the accreditation also extends to fields beyond the scope of accreditation attested by DAkkS.

The accreditation was granted pursuant to the Act on the Accreditation Body (AkkStelleG) of 31 July 2009 (Federal Law Gazette I p. 2625) and the Regulation (EC) No 765/2008 of the European Parliament and of the Council of 9 July 2008 setting out the requirements for accreditation and market surveillance relating to the marketing of products (Official Journal of the European Union L 218 of 9 July 2008; p. 30). DAkkS is a signatory to the Multilateral Agreements for Mutual Recognition of the European co-operation for Accreditation (EA), International Accreditation Forum (IAF) and International Laboratory Accreditation Cooperation (ILAC). The signatories to these agreements recognise each other's accreditations.

The up-to-date state of membership can be retrieved from the following websites:
EA: www.european-accreditation.org
ILAC: www.ilac.org
IAF: www.iaf.nu

Front side of certificate

Back side of certificate

Note:

The current certificate including annex is published on our website (see link below) or may be received from CETECOM ICT Services on request.

http://www.cetecom.com/fileadmin/de/CETECOM_D_Saarbruecken/accreditations_Jan_2010/DAKKS_Akkredi_Urk_EN17025-En_incl_Annex.pdf