

## TEST REPORT

Test report no.: 1-5579/12-01-06-B



### Testing laboratory

**CETECOM ICT Services GmbH**  
 Untertuerkheimer Strasse 6 – 10  
 66117 Saarbruecken / Germany  
 Phone: + 49 681 5 98 - 0  
 Fax: + 49 681 5 98 - 9075  
 Internet: <http://www.cetecom.com>  
 e-mail: [ict@cetecom.com](mailto:ict@cetecom.com)

#### Accredited Testing Laboratory:

The testing laboratory (area of testing) is accredited according to DIN EN ISO/IEC 17025 (2005) by the Deutsche Akkreditierungsstelle GmbH (DAkkS). The accreditation is valid for the scope of testing procedures as stated in the accreditation certificate with the registration number: D-PL-12076-01-01  
 Area of Testing: Radio/Satellite Communications

### Applicant

**Research In Motion Limited**  
 305 Phillip Street  
 Waterloo, ON N2L 3W8 / CANADA  
 Phone: +1 51 98 88 74 65  
 Fax: +1 51 98 88 69 06  
 Contact: Masud Attayi  
 e-mail: [mattayi@rim.com](mailto:mattayi@rim.com)  
 Phone: +1 51 98 88 74 65

### Manufacturer

**Research In Motion Limited**  
 305 Phillip Street  
 Waterloo, ON N2L 3W8 / CANADA

### Test standard/s

47 CFR Part 15 Title 47 of the Code of Federal Regulations; Chapter I  
 Part 15 - Radio frequency devices

RSS - 210 Issue 8 Spectrum Management and Telecommunications - Radio Standards Specification  
 Low-power Licence-exempt Radiocommunication Devices (All Frequency Bands):  
 Category I Equipment

For further applied test standards please refer to section 3 of this test report.

### Test Item

**Kind of test item:** Blackberry GSM Phones  
**Model name:** RFN81UW  
**FCC ID:** L6ARFN80UW  
**IC:** 2503A-RFN80UW  
 Frequency: ISM band 2400 MHz to 2483.5 MHz  
 (lowest channel 2402 MHz, highest channel 2480 MHz)  
 Technology tested: Bluetooth®, +EDR  
 Antenna: Integrated antenna  
 Power Supply: 3.8 V DC by Li - Ion battery  
 Temperature Range: Not needed – normal test conditions only!

This test report is electronically signed and valid without handwriting signature. For verification of the electronic signatures, the public keys can be requested at the testing laboratory.

### Test report authorised:

Andreas Luckenbill  
 Expert

### Test performed:

Marco Bertolino  
 Testing Manager

**1 Table of contents**

1 Table of contents .....2

2 General information .....3

    2.1 Notes and disclaimer .....3

    2.2 Application details.....3

3 Test standard/s .....3

4 Test environment.....4

5 Test item .....4

    5.1 Additional information .....4

6 Test laboratories sub-contracted .....4

7 Summary of measurement results .....5

8 RF measurements .....6

    8.1 Description of test setup .....6

        8.1.1 Radiated measurements.....6

        8.1.2 Conducted measurements.....7

    8.2 Additional comments .....7

9 Measurement results.....8

    9.1 Antenna gain.....8

    9.2 Power spectral density .....8

    9.3 Carrier frequency separation .....8

    9.4 Number of hopping channels.....8

    9.5 Time of occupancy (dwell time) .....9

    9.6 Spectrum bandwidth of a FHSS system – 20 dB bandwidth .....10

    9.7 Maximum output power .....10

    9.8 Band edge compliance conducted .....10

    9.9 Band edge compliance radiated .....11

    9.10 TX spurious emissions conducted .....18

    9.11 TX spurious emissions radiated .....19

    9.12 RX spurious emissions radiated .....48

    9.13 Spurious emissions radiated < 30 MHz .....52

    9.14 Spurious emissions conducted < 30 MHz.....53

10 Test equipment and ancillaries used for tests.....56

11 Observations .....57

Annex A Document history .....58

Annex B Further information.....58

Annex C Accreditation Certificate .....59

## 2 General information

### 2.1 Notes and disclaimer

The test results of this test report relate exclusively to the test item specified in this test report. CETECOM ICT Services GmbH does not assume responsibility for any conclusions and generalizations drawn from the test results with regard to other specimens or samples of the type of the equipment represented by the test item.

The test report may only be reproduced or published in full. Reproduction or publication of extracts from the report requires the prior written approval of CETECOM ICT Services GmbH.

The testing service provided by CETECOM ICT Services GmbH has been rendered under the current "General Terms and Conditions for CETECOM ICT Services GmbH".

CETECOM ICT Services GmbH will not be liable for any loss or damage resulting from false, inaccurate, inappropriate or incomplete product information provided by the customer.

Under no circumstances does the CETECOM ICT Services GmbH test report include any endorsement or warranty regarding the functionality, quality or performance of any other product or service provided.

Under no circumstances does the CETECOM ICT Services GmbH test report include or imply any product or service warranties from CETECOM ICT Services GmbH, including, without limitation, any implied warranties of merchantability, fitness for purpose, or non-infringement, all of which are expressly disclaimed by CETECOM ICT Services GmbH.

All rights and remedies regarding vendor's products and services for which CETECOM ICT Services GmbH has prepared this test report shall be provided by the party offering such products or services and not by CETECOM ICT Services GmbH.

In no case this test report can be considered as a Letter of Approval.

This test report is electronically signed and valid without handwritten signature. For verification of the electronic signatures, the public keys can be requested at the testing laboratory.

### 2.2 Application details

Date of receipt of order:	2012-11-30
Date of receipt of test item:	2012-12-01
Start of test:	2012-12-01
End of test:	2013-01-04
Person(s) present during the test:	-/-

## 3 Test standard/s

Test standard	Date	Test standard description
47 CFR Part 15	2010-10	Title 47 of the Code of Federal Regulations; Chapter I Part 15 - Radio frequency devices
RSS - 210 Issue 8	2010-12	Spectrum Management and Telecommunications - Radio Standards Specification Low-power Licence-exempt Radiocommunication Devices (All Frequency Bands): Category I Equipment

#### 4 Test environment

Temperature:	$T_{nom}$	+22 °C during room temperature tests
	$T_{max}$	-/- °C during high temperature tests
	$T_{min}$	-/- °C during low temperature tests
Relative humidity content:		43 %
Barometric pressure:		not relevant for this kind of testing
Power supply:	$V_{nom}$	3.8 V DC by Li - Ion battery
	$V_{max}$	-/- V
	$V_{min}$	-/- V

#### 5 Test item

Kind of test item	:	Blackberry GSM Phones
Type identification	:	RFN81UW
S/N serial number	:	Radiated units: BT MAC 34 BB 1F 6B 13 3F BT MAC 34 BB 1F 6B 10 69
HW hardware status	:	CER-53015-001-Rev 2-905-01 / CER-53015-001-Rev 3-905-01
SW software status	:	127.0.1.3123 / 127.0.1.3901
Frequency band [MHz]	:	ISM band 2400 MHz to 2483.5 MHz (lowest channel 2402 MHz, highest channel 2480 MHz)
Type of radio transmission	:	FHSS
Use of frequency spectrum	:	
Channel access method	:	FDMA
Type of modulation	:	GFSK, Pi/4 DQPSK and 8 DPSK
Number of channels	:	79
Antenna	:	Integrated antenna
Power supply	:	3.8 V DC by Li - Ion battery
Temperature range	:	Not needed – normal test conditions only!

#### 5.1 Additional information

Test setup- and EUT-photos are included in test reports: 1-5579/12-01-01\_AnnexA  
1-5579/12-01-01\_AnnexD

#### 6 Test laboratories sub-contracted

None

## 7 Summary of measurement results

- No deviations from the technical specifications were ascertained
- There were deviations from the technical specifications ascertained

TC Identifier	Description	Verdict	Date	Remark
RF-Testing	CFR Part 15 RSS 210, Issue 8, Annex 8	Passed	2013-03-08	Reduced tests according manufacturer test plan!

Test specification clause	Test case	Temperature conditions	Power source voltages	Mode	Pass	Fail	NA	NP	Remark
§15.247(b)(4) RSS 210 / A8.4(2)	Antenna gain	Nominal	Nominal	GFSK	<input type="checkbox"/>	<input type="checkbox"/>	<input type="checkbox"/>	<input checked="" type="checkbox"/>	-/-
§15.247(e) RSS 210 / A8.2(b)	Power spectral density	Nominal	Nominal	GFSK Pi/4 DQPSK 8 DPSK	<input type="checkbox"/>	<input type="checkbox"/>	<input checked="" type="checkbox"/>	<input type="checkbox"/>	-/-
§15.247(a)(1) RSS 210 / A8.1(b)	Carrier frequency separation	Nominal	Nominal	GFSK	<input type="checkbox"/>	<input type="checkbox"/>	<input type="checkbox"/>	<input checked="" type="checkbox"/>	-/-
§15.247(a)(1) RSS 210 / A8.1(d)	Number of hopping channels	Nominal	Nominal	GFSK	<input type="checkbox"/>	<input type="checkbox"/>	<input type="checkbox"/>	<input checked="" type="checkbox"/>	-/-
§15.247(a)(1) (iii) RSS 210 / A8.3(1)	Time of occupancy (dwell time)	Nominal	Nominal	GFSK Pi/4 DQPSK 8 DPSK	<input type="checkbox"/>	<input type="checkbox"/>	<input type="checkbox"/>	<input checked="" type="checkbox"/>	-/-
§15.247(a)(1) RSS 210 / A8.2(a)	Spectrum bandwidth of a FHSS system 20dB bandwidth	Nominal	Nominal	GFSK Pi/4 DQPSK 8 DPSK	<input type="checkbox"/> <input type="checkbox"/> <input type="checkbox"/>	<input type="checkbox"/> <input type="checkbox"/> <input type="checkbox"/>	<input type="checkbox"/> <input type="checkbox"/> <input type="checkbox"/>	<input checked="" type="checkbox"/> <input checked="" type="checkbox"/> <input checked="" type="checkbox"/>	-/-
§15.247(b)(1) RSS-210 / A8.4(2)	Maximum output power	Nominal	Nominal	GFSK Pi/4 DQPSK 8 DPSK	<input type="checkbox"/> <input type="checkbox"/> <input type="checkbox"/>	<input type="checkbox"/> <input type="checkbox"/> <input type="checkbox"/>	<input type="checkbox"/> <input type="checkbox"/> <input type="checkbox"/>	<input checked="" type="checkbox"/> <input checked="" type="checkbox"/> <input checked="" type="checkbox"/>	-/-
§15.247(d) RSS-210 / A8.5	Band edge compliance conducted	Nominal	Nominal	GFSK Pi/4 DQPSK 8 DPSK	<input type="checkbox"/> <input type="checkbox"/> <input type="checkbox"/>	<input type="checkbox"/> <input type="checkbox"/> <input type="checkbox"/>	<input type="checkbox"/> <input type="checkbox"/> <input type="checkbox"/>	<input checked="" type="checkbox"/> <input checked="" type="checkbox"/> <input checked="" type="checkbox"/>	-/-
§15.205 RSS-210 / A8.5	Band edge compliance radiated	Nominal	Nominal	GFSK Pi/4 DQPSK 8 DPSK	<input checked="" type="checkbox"/> <input checked="" type="checkbox"/> <input checked="" type="checkbox"/>	<input type="checkbox"/> <input type="checkbox"/> <input type="checkbox"/>	<input type="checkbox"/> <input type="checkbox"/> <input type="checkbox"/>	<input type="checkbox"/> <input type="checkbox"/> <input type="checkbox"/>	complies
§15.247(d) RSS-210 / A8.5	TX spurious emissions conducted	Nominal	Nominal	GFSK Pi/4 DQPSK 8 DPSK	<input type="checkbox"/> <input type="checkbox"/> <input type="checkbox"/>	<input type="checkbox"/> <input type="checkbox"/> <input type="checkbox"/>	<input type="checkbox"/> <input type="checkbox"/> <input type="checkbox"/>	<input checked="" type="checkbox"/> <input checked="" type="checkbox"/> <input checked="" type="checkbox"/>	-/-
§15.247(d) RSS-210 / A8.5	TX spurious emissions radiated	Nominal	Nominal	GFSK	<input checked="" type="checkbox"/>	<input type="checkbox"/>	<input type="checkbox"/>	<input type="checkbox"/>	complies
§15.109 RSS-Gen	RX spurious emissions radiated	Nominal	Nominal	-/-	<input checked="" type="checkbox"/>	<input type="checkbox"/>	<input type="checkbox"/>	<input type="checkbox"/>	complies
§15.209(a) RSS-Gen	TX spurious emissions radiated < 30 MHz	Nominal	Nominal	GFSK	<input type="checkbox"/>	<input type="checkbox"/>	<input type="checkbox"/>	<input checked="" type="checkbox"/>	-/-
§15.107(a)	Conducted emissions < 30 MHz	Nominal	Nominal	GFSK	<input checked="" type="checkbox"/>	<input type="checkbox"/>	<input type="checkbox"/>	<input type="checkbox"/>	complies

**Note:** NA = Not Applicable; NP = Not Performed

## 8 RF measurements

### 8.1 Description of test setup

#### 8.1.1 Radiated measurements

The radiated measurements are performed in vertical and horizontal plane in the frequency range from 9 kHz to 25 GHz in semi-anechoic chambers. The EUT is positioned on a non-conductive support with a height of 0.80 m above a conductive ground plane that covers the whole chamber. The receiving antennas are confirmed with specifications ANSI C63.2-1996 clause 15 and ANSI C63.4-2009 clause 4.1.5. These antennas can be moved over the height range between 1.0 m and 4.0 m in order to search for maximum field strength emitted from EUT. The measurement distances between EUT and receiving antennas are indicated in the test setups for the various frequency ranges. For each measurement, the EUT is rotated in all three axes until the maximum field strength is received. The wanted and unwanted emissions are received by spectrum analysers where the detector modes and resolution bandwidths over various frequency ranges are set according to requirement ANSI C63-4-2009 clause 4.2.

Antennas are confirmed with ANSI C63.2-1996 item 15.

Semi anechoic chamber

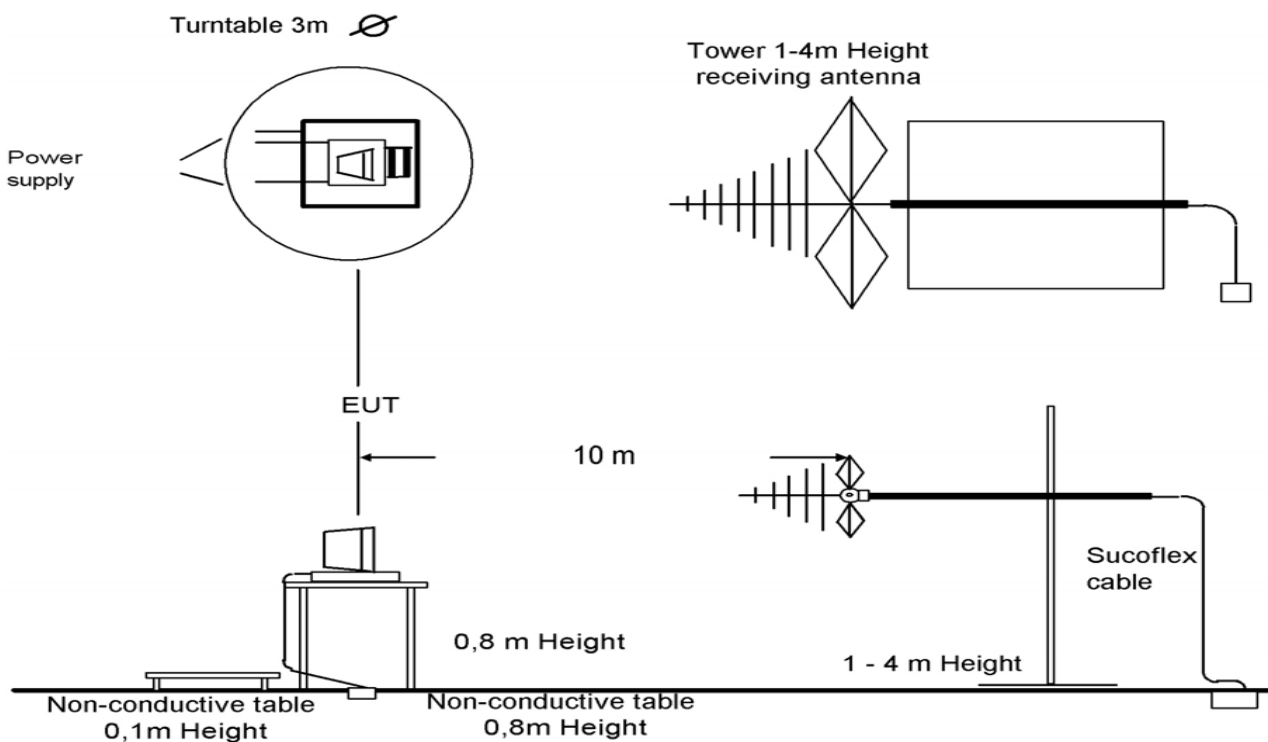

Picture 1: Diagram radiated measurements

9 kHz - 30 MHz:	active loop antenna
30 MHz – 1 GHz:	tri-log antenna
> 1 GHz:	horn antenna

All measurements are done in accordance with the Filing and Measurement Guidelines for Frequency Hopping Spread Spectrum Systems DA 00-705 and Appendix A “BLUETOOTH® APPROVALS”

The EUT is powered by an external power supply with nominal voltage. The signalling is performed from outside the chamber with a signalling unit (CMU200 or other) by air link using signalling antenna.

### 8.1.2 Conducted measurements

The EUT's RF signal is coupled out by the antenna connector which is supplied by the manufacturer. The signal is first 10dB attenuated before it is power divided (~6dB loss per branch). One of the signal paths is connected to the communication base Station (CMU200 or other), the other one is connected to the spectrum analyzer. The specific losses for both signal paths are first checked within a calibration. The measurement readings on the signalling unit/spectrum analyzer are corrected by the specific test set-up loss. The attenuator, power divider, signalling unit and the spectrum analyzer are impedance matched on 50 Ohm.

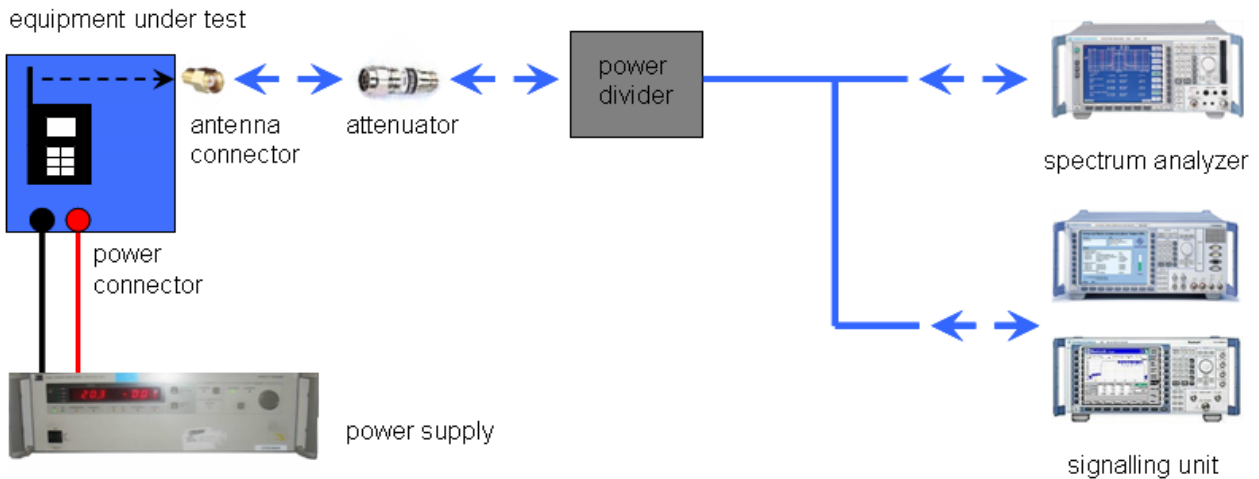

Picture 2: Diagram conducted measurements

### 8.2 Additional comments

The Bluetooth® word mark and logos are owned by the Bluetooth SIG Inc. and any use of such marks by Cetecom ICT Services GmbH is under license.

Reference documents: None

Special test descriptions: None

Configuration descriptions: TX tests: were performed with x-DH5 packets and static PRBS pattern payload.  
RX/Standby tests: BT test mode enabled, scan enabled, TX Idle

Test mode:

- Bluetooth Test mode loop back enabled (EUT is controlled over CBT/CMU)
- Special software is used. EUT is transmitting pseudo random data by itself

## 9 Measurement results

### 9.1 Antenna gain

Not performed!

### 9.2 Power spectral density

Not applicable!

### 9.3 Carrier frequency separation

Not performed!

### 9.4 Number of hopping channels

Not performed!



## 9.5 Time of occupancy (dwell time)

### Measurement:

For Bluetooth® devices no measurements mandatory depending on the fixed requirements according to the Bluetooth® Core Specifications!

### For Bluetooth® devices:

The channel staying time of 0.4 s within a 31.6 second period in data mode is constant for Bluetooth® devices and independent from the packet type (packet length). The calculation for a 31.6 second period is as follows:

Channel staying time = time slot length \* hop rate / number of hopping channels \* 31.6 s

Example for a DH1 packet (with a maximum length of one time slot)

Channel staying time =  $625 \mu\text{s} * 1600 * 1/\text{s} / 79 * 31.6 \text{ s} = 0.4 \text{ s}$  (in a 31.6 s period)

For multi-slot packets the hopping is reduced according to the length of the packet.

Example for a DH3 packet (with a maximum length of three time slots)

Channel staying time =  $3 * 625 \mu\text{s} * 1600/3 * 1/\text{s} / 79 * 31.6 \text{ s} = 0.4 \text{ s}$  (in a 31.6 s period)

Example for a DH5 packet (with a maximum length of five time slots)

Channel staying time =  $5 * 625 \mu\text{s} * 1600/5 * 1/\text{s} / 79 * 31.6 \text{ s} = 0.4 \text{ s}$  (in a 31.6 s period)

This is according to the Bluetooth® Core Specification V2.0 & V2.1 & V3.0 & V4.0 (+ critical errata) for all Bluetooth® devices.

### The following table shows the relations:

Packet Size	Pulse Width [ms] *	Max. number of transmissions per channel in 31.6 sec
DH1	0.366	640
DH3	1.622	214
DH5	2.870	128

\* according Bluetooth® specification

### Results:

Packet Size	Pulse Width [ms]*	Max. number of transmissions in 31.6 sec	Dwell time [Pulse width * Number of transmissions]
DH1	0.366	640	234.2 ms
DH3	1.622	214	347.1 ms
DH5	2.870	128	367.4 ms

### Limits:

FCC	IC
Time of occupancy (dwell time)	
The frequency hopping operation shall have an average time of occupancy on any frequency not exceeding 0.4 seconds within a duration in seconds equal to the number of hopping frequencies multiplied by 0.4.	

**Result: Passed**

**9.6 Spectrum bandwidth of a FHSS system – 20 dB bandwidth**

Not performed!

**9.7 Maximum output power**

Not performed!

**9.8 Band edge compliance conducted**

Not performed!

## 9.9 Band edge compliance radiated

### Description:

Measurement of the radiated band edge compliance. The EUT is turned in the position that results in the maximum level at the band edge. Then a sweep over the corresponding restricted band is performed. The EUT is set to single channel mode and the transmit channel is channel 00 for the lower restricted band and channel 78 for the upper restricted band. The measurement is repeated for all modulations. Measurement distance is 3m.

### Measurement:

Measurement parameter	
Detector:	Peak
Sweep time:	Auto
Video bandwidth:	10 Hz
Resolution bandwidth:	1 MHz
Span:	Lower Band: 2300 – 2400 MHz Upper Band: 2480 – 2500 MHz
Trace-Mode:	Max Hold

### Limits:

FCC	IC
Band edge compliance radiated	
<p>In any 100 kHz bandwidth outside the frequency band in which the spread spectrum or digitally modulated intentional radiator is operating, the radio frequency power that is produced by the intentional radiator shall be at least 20 dB below that in the 100 kHz bandwidth within the band that contains the highest level of the desired power, based on either an RF conducted or a radiated measurement. Attenuation below the general limits specified in Section 15.209(a) is not required. In addition, radiated emissions which fall in the restricted bands, as defined in Section 15.205(a), must also comply with the radiated emission limits specified in Section 15.209(a) (see Section 5.205(c)).</p>	
54 dB $\mu$ V/m AVG	

### Results:

Scenario	Band edge compliance radiated [dB $\mu$ V/m]		
	GFSK	Pi/4 DQPSK	8DPSK
Modulation			
Lower restricted band	< 54	< 54	< 54
Upper restricted band	< 54	< 54	< 54
Measurement uncertainty	$\pm$ 3 dB		

**Result:** Passed

**Plots: peak**

**Plot 1: Lower band edge, GFSK modulation, vertical & horizontal polarization**

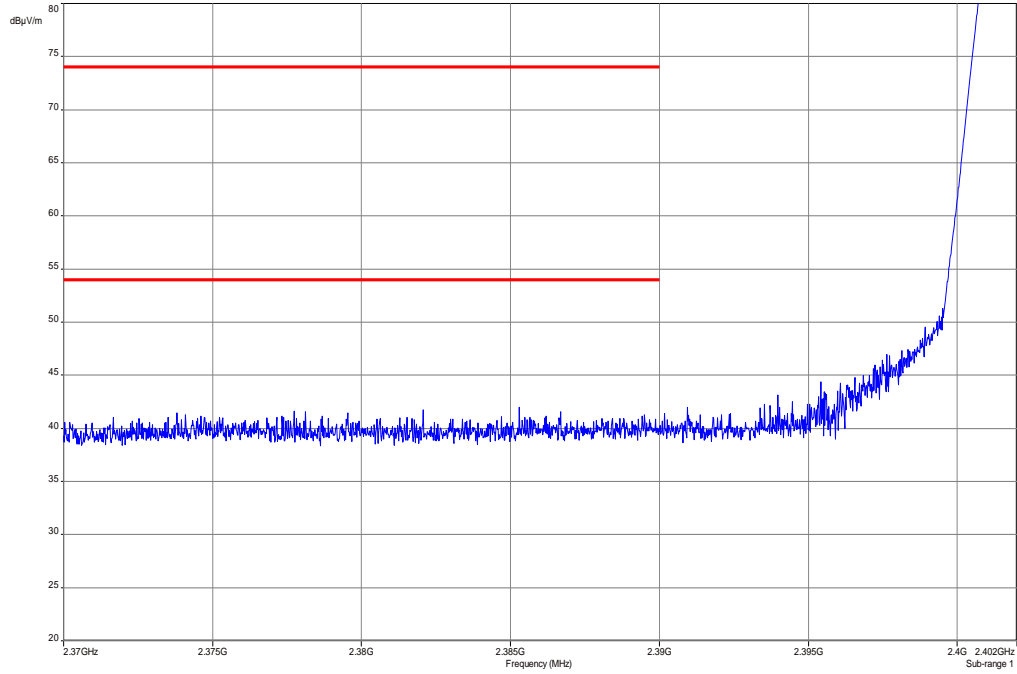

**Plot 2: Upper band edge, GFSK modulation, vertical & horizontal polarization**

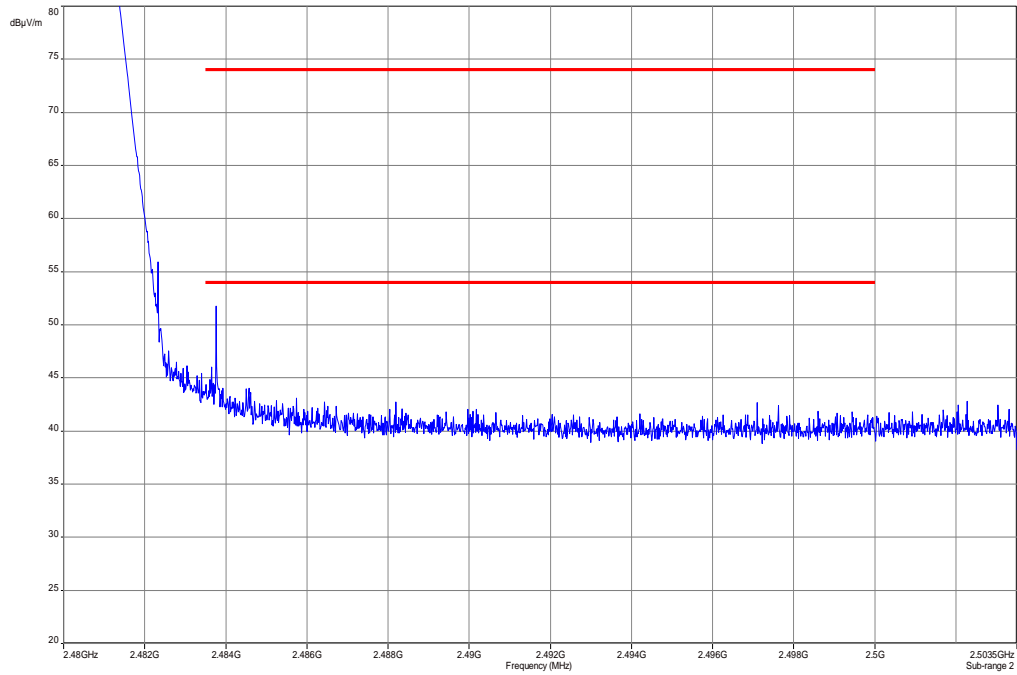

**Plot 3:** Lower band edge, Pi/4 DQPSK modulation, vertical & horizontal polarization

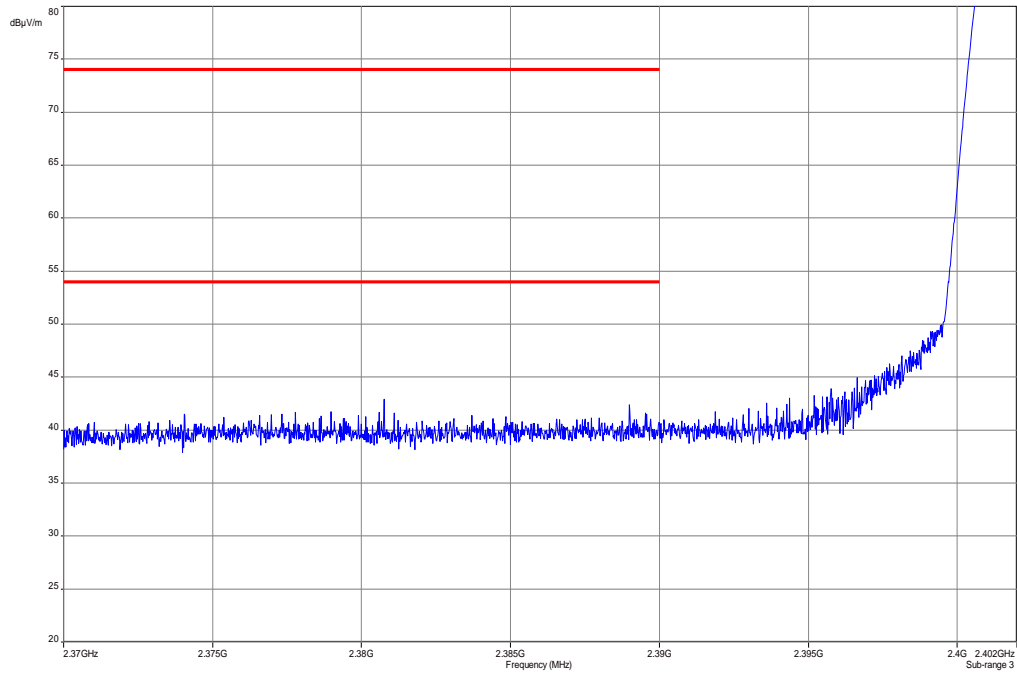

**Plot 4:** Upper band edge, Pi/4 DQPSK modulation, vertical & horizontal polarization

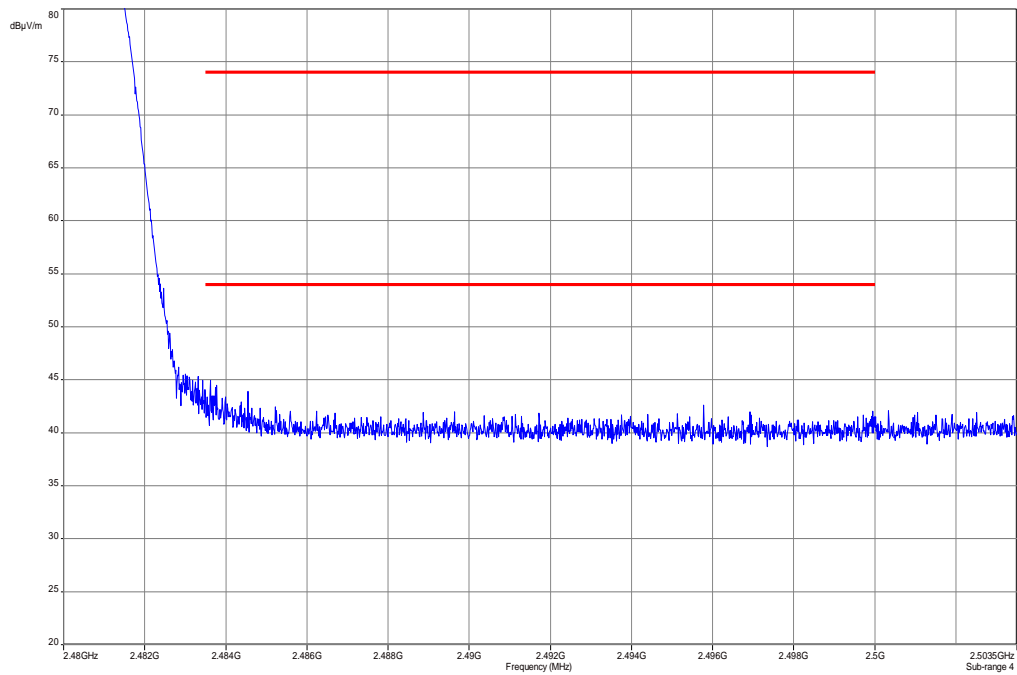

**Plot 5:** Lower band edge, 8 DPSK modulation, vertical & horizontal polarization

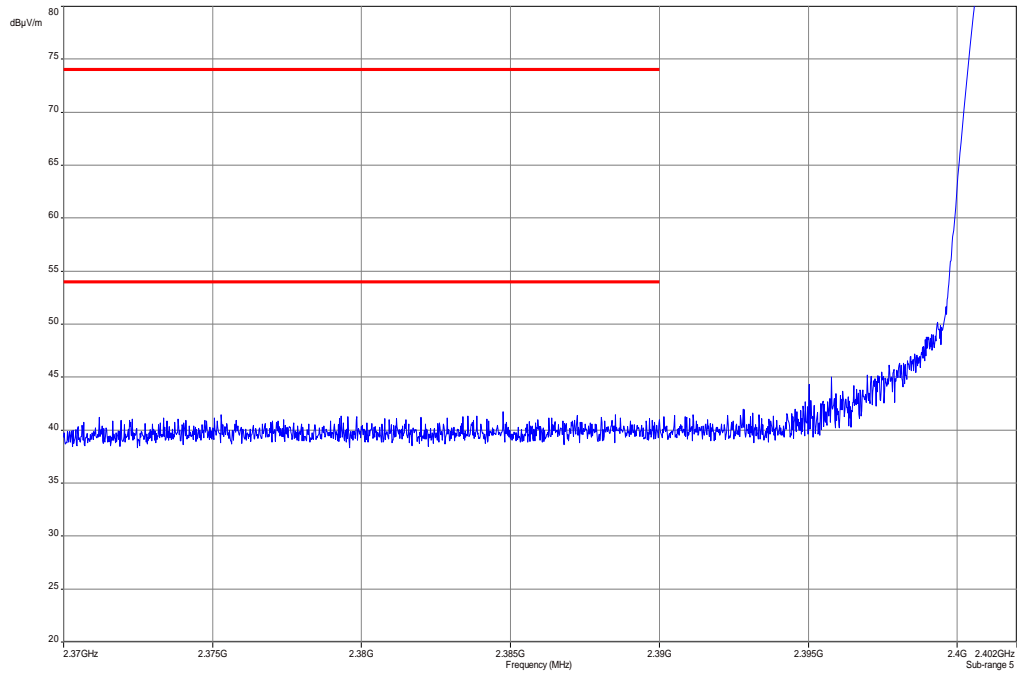

**Plot 6:** Upper band edge, 8 DPSK modulation, vertical & horizontal polarization

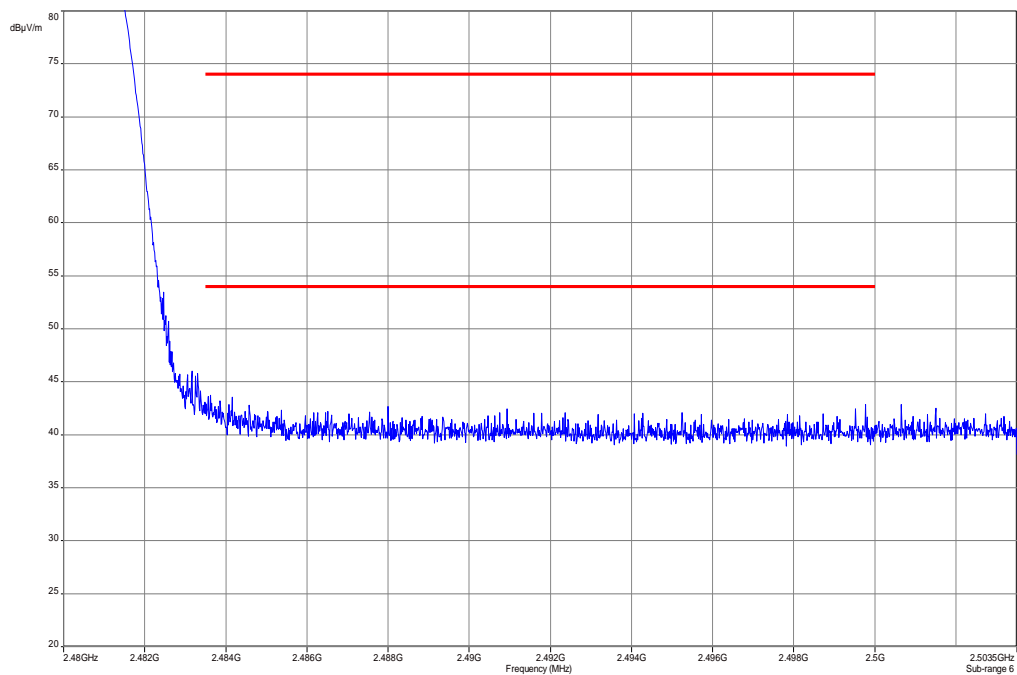

**Plots: average**

**Plot 1: Lower band edge, GFSK modulation, vertical & horizontal polarization**

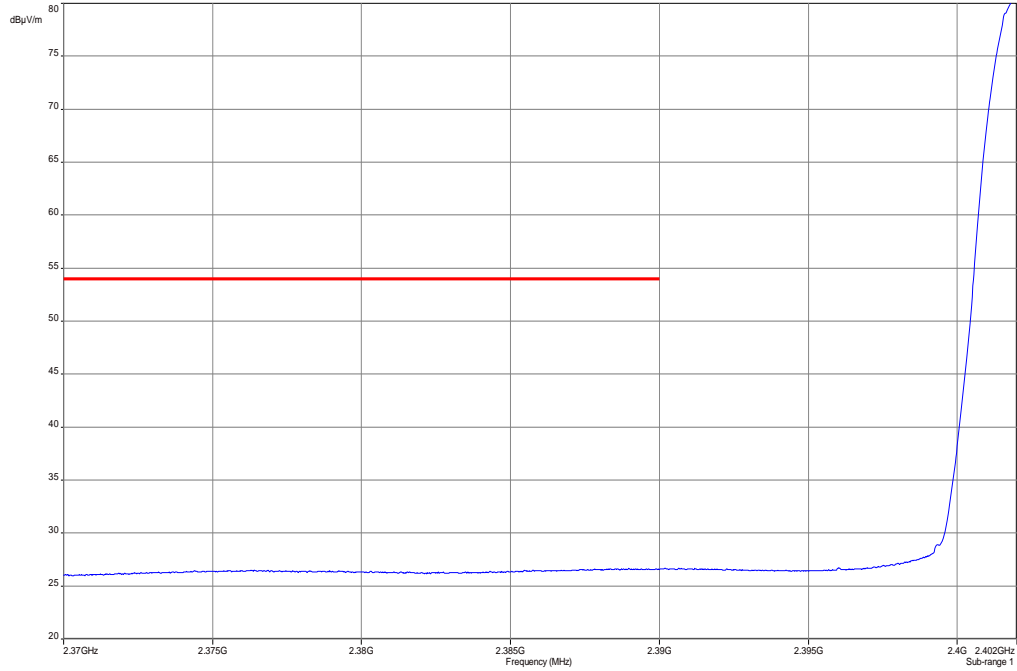

**Plot 2: Upper band edge, GFSK modulation, vertical & horizontal polarization**

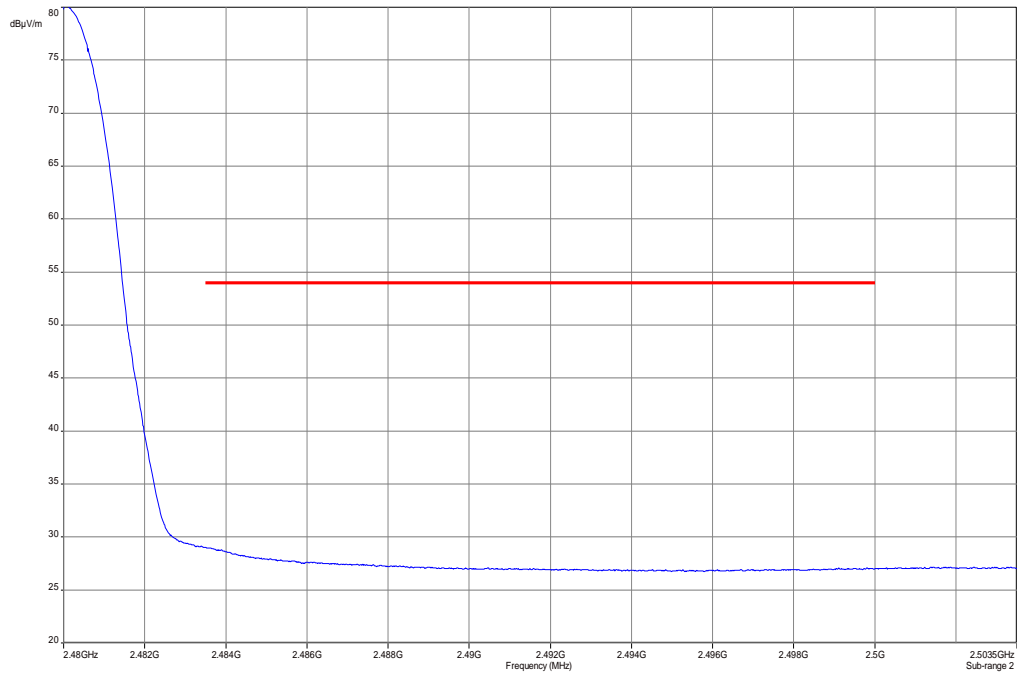

**Plot 3:** Lower band edge, Pi/4 DQPSK modulation, vertical & horizontal polarization

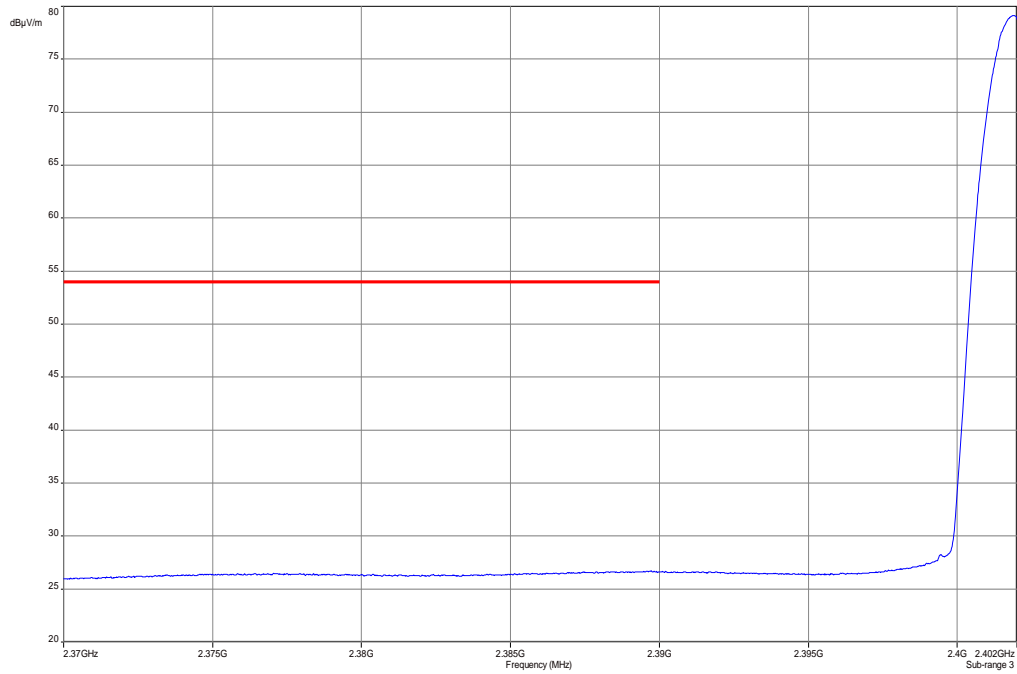

**Plot 4:** Upper band edge, Pi/4 DQPSK modulation, vertical & horizontal polarization

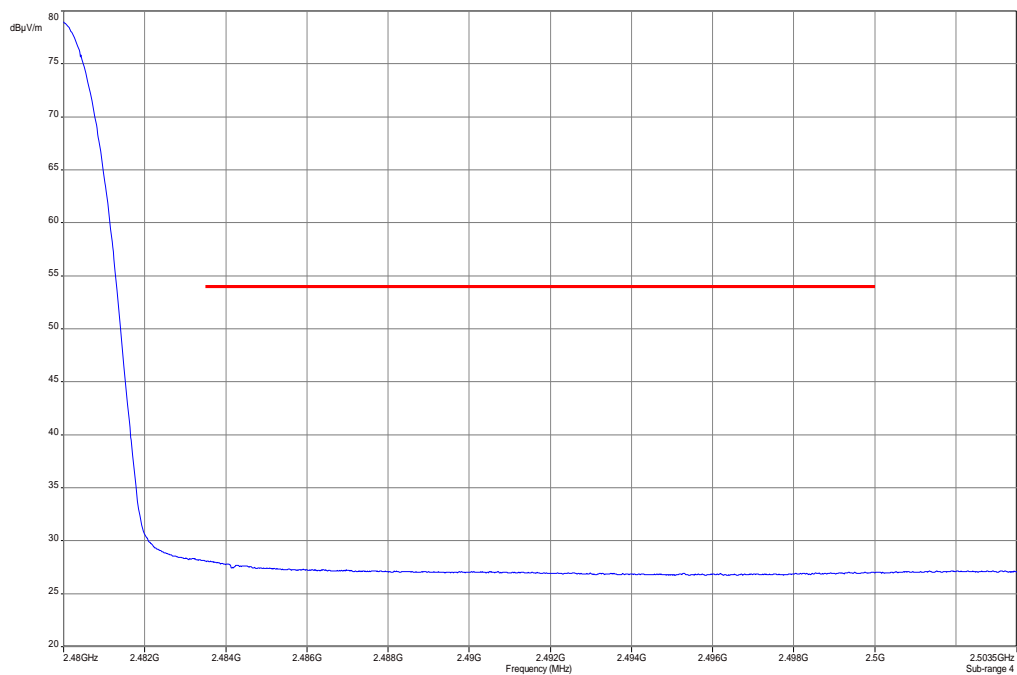



**Plot 5:** Lower band edge, 8 DPSK modulation, vertical & horizontal polarization

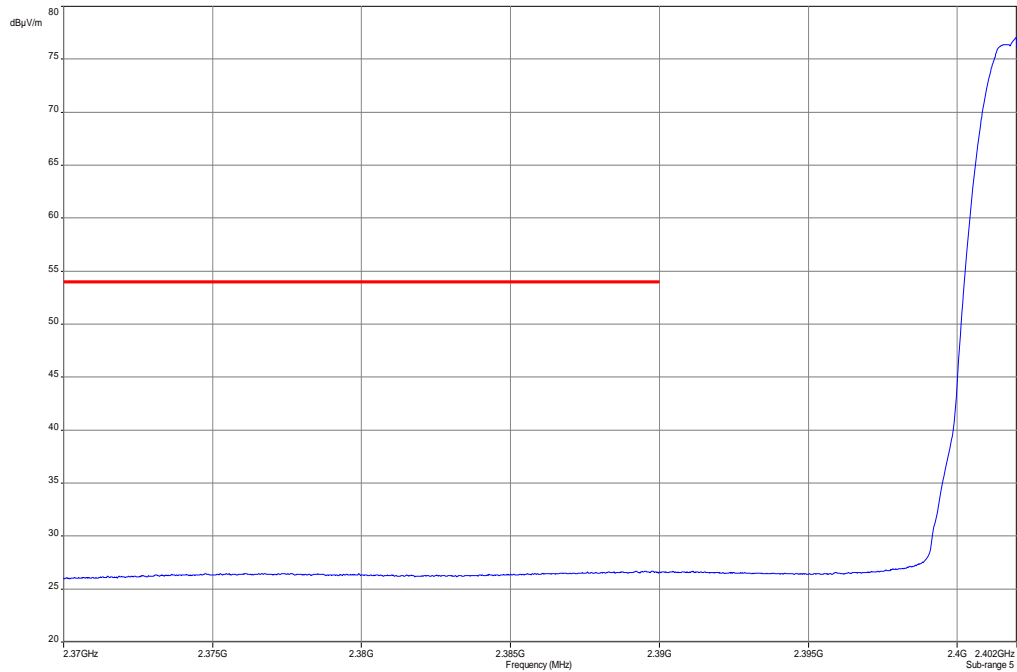

**Plot 6:** Upper band edge, 8 DPSK modulation, vertical & horizontal polarization

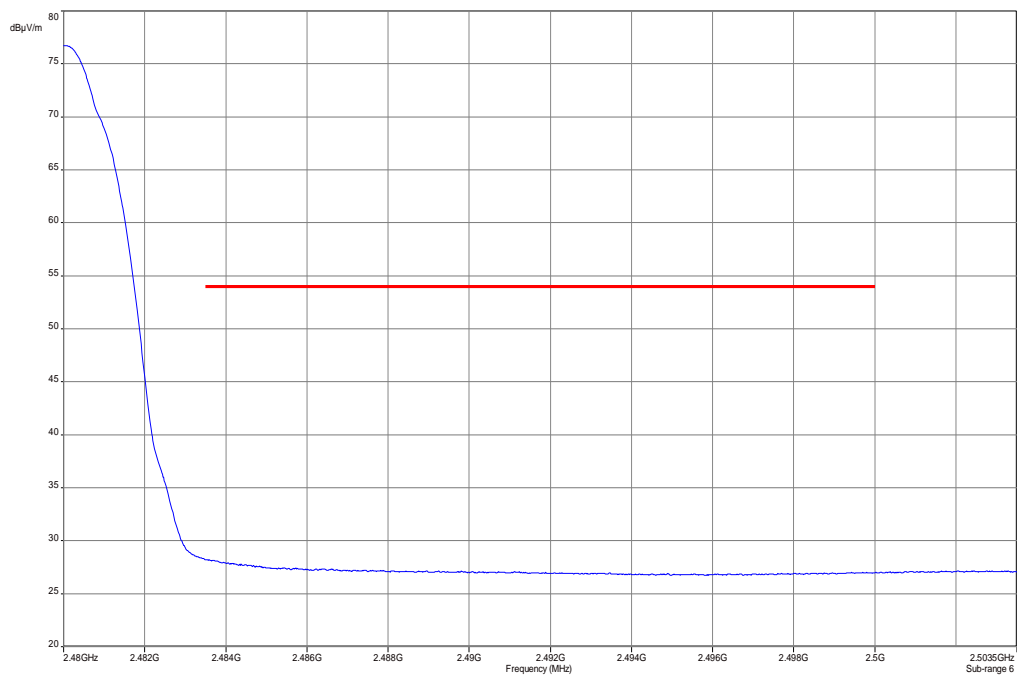

## 9.10 TX spurious emissions conducted

Not performed!

### 9.11 TX spurious emissions radiated

**Description:**

Measurement of the radiated spurious emissions in transmit mode. The EUT is set to single channel mode and the transmit channel is channel 00, channel 39 and channel 78. The measurement is performed in the mode with the highest output power.

**Measurement:**

Measurement parameter	
Detector:	Peak / Quasi Peak
Sweep time:	Auto
Video bandwidth:	Sweep: 100 kHz Remeasurement: 10 Hz
Resolution bandwidth:	F < 1 GHz: 100 kHz F > 1 GHz: 1 MHz
Span:	30 MHz to 25 GHz
Trace-Mode:	Max Hold
Measured Modulation:	<input checked="" type="checkbox"/> GFSK <input checked="" type="checkbox"/> Pi/4 DQPSK <input checked="" type="checkbox"/> 8DPSK

The modulation with the highest output power was used to perform the transmitter spurious emissions. If spurious were detected a re-measurement was performed on the detected frequency with each modulation.

**Limits:**

FCC		IC	
TX spurious emissions radiated			
In any 100 kHz bandwidth outside the frequency band in which the spread spectrum or digitally modulated intentional radiator is operating, the radio frequency power that is produced by the intentional radiator shall be at least 20 dB below that in the 100 kHz bandwidth within the band that contains the highest level of the desired power, based on either an RF conducted or a radiated measurement. Attenuation below the general limits specified in Section 15.209(a) is not required. In addition, radiated emissions which fall in the restricted bands, as defined in §15.205(a), must also comply with the radiated emission limits specified in §15.209(a) (see §15.205(c)).			
§15.209			
Frequency (MHz)	Field strength (dBµV/m)	Measurement distance	
30 - 88	30.0	10	
88 – 216	33.5	10	
216 – 960	36.0	10	
Above 960	54.0	3	

**Results: GFSK modulation**

TX spurious emissions radiated [dBµV/m]								
2402 MHz			2441 MHz			2480 MHz		
F [MHz]	Detector	Level [dBµV/m]	F [MHz]	Detector	Level [dBµV/m]	F [MHz]	Detector	Level [dBµV/m]
No critical peaks detected			No critical peaks detected			No critical peaks detected		
Measurement uncertainty			± 3 dB					

**Result: Passed**

**Results: Pi/4 DQPSK**

TX spurious emissions radiated [dBµV/m]								
2402 MHz			2441 MHz			2480 MHz		
F [MHz]	Detector	Level [dBµV/m]	F [MHz]	Detector	Level [dBµV/m]	F [MHz]	Detector	Level [dBµV/m]
No critical peaks detected			No critical peaks detected			No critical peaks detected		
Measurement uncertainty			± 3 dB					

**Result: Passed**

**Results: 8 DPSK**

TX spurious emissions radiated [dBµV/m]								
2402 MHz			2441 MHz			2480 MHz		
F [MHz]	Detector	Level [dBµV/m]	F [MHz]	Detector	Level [dBµV/m]	F [MHz]	Detector	Level [dBµV/m]
No critical peaks detected			No critical peaks detected			No critical peaks detected		
Measurement uncertainty			± 3 dB					

**Result: Passed**

**Plots:** GFSK modulation

**Plot 1:** 30 MHz to 1 GHz, TX mode, channel 00, vertical & horizontal polarization

### Common Information

EUT: RFN81UW  
 Test Description: FCC part 15 C class B @ 10m  
 Operating Conditions: BT DH5 Tx CH0  
 Operator Name: Medrow  
 Comment: battery powered

### Scan Setup: STAN\_Fin [EMI radiated]

Hardware Setup: Electric Field (NOS)  
 Receiver: [ESC1 3]  
 Level Unit: dBµV/m

Subrange	Step Size	Detectors	IF BW	Meas. Time	Preamp
30 MHz - 2 GHz	60 kHz	QPK	120 kHz	1 s	20 dB

FCC\_10m(B)

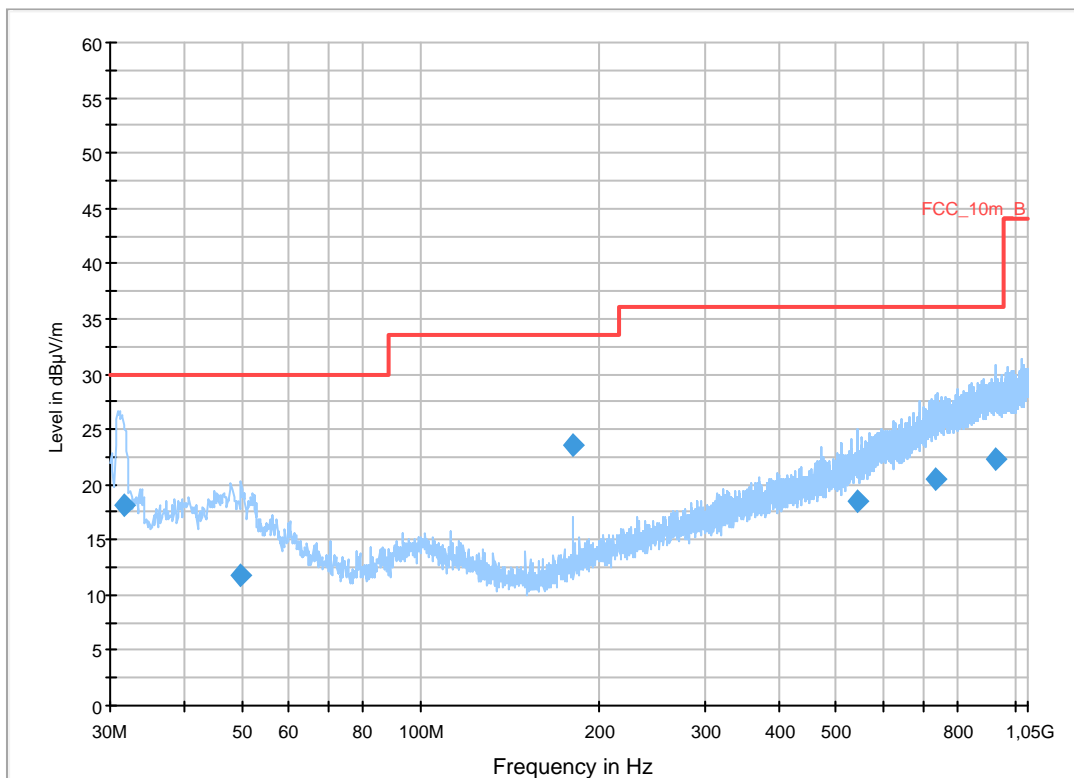

### Fnal Result 1

Frequency (MHz)	QuasiPeak (dBµV/m)	Meas. Time (ms)	Bandwidth (kHz)	Height (cm)	Polarization	Azimuth (deg)	Corr. (dB)	Margin (dB)	Limit (dBµV/m)	Comment
31.740300	18.1	1000.0	120.000	100.0	V	85.0	12.7	11.9	30.0	
49.791900	11.9	1000.0	120.000	194.0	V	45.0	13.4	18.1	30.0	
179.986050	23.5	1000.0	120.000	106.0	V	231.0	10.4	10.0	33.5	
544.073550	18.4	1000.0	120.000	200.0	V	-28.0	19.3	17.6	36.0	
732.711300	20.5	1000.0	120.000	277.0	H	54.0	23.3	15.5	36.0	
924.384150	22.4	1000.0	120.000	205.0	H	240.0	25.3	13.6	36.0	

**Plot 2:** 1 GHz to 12.75 GHz, TX mode, channel 00, vertical & horizontal polarization

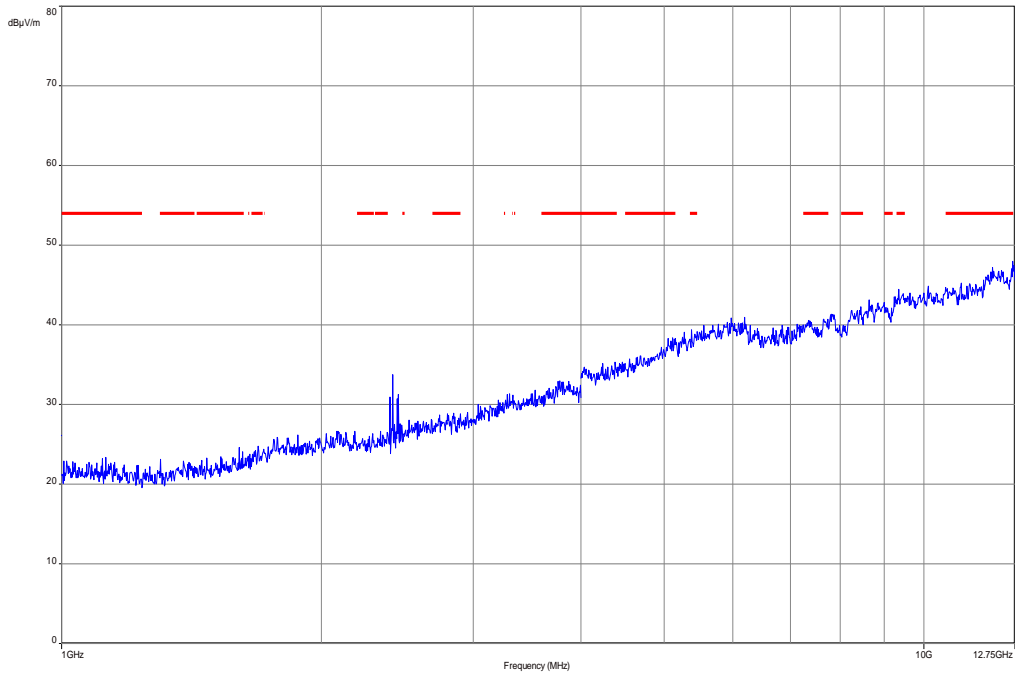

The carrier signal is notched with a 2.4 GHz band rejection filter.

**Plot 3:** 12.75 GHz to 18 GHz, TX mode, channel 00, vertical & horizontal polarization

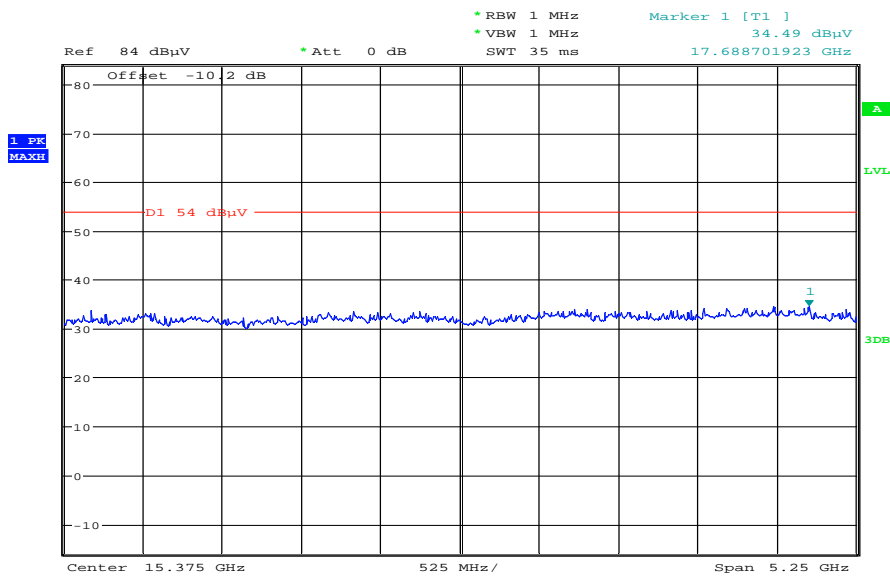

Date: 15.DEC.2012 09:03:38

Plot 4: 18 GHz to 26 GHz, TX mode, channel 00, vertical & horizontal polarization

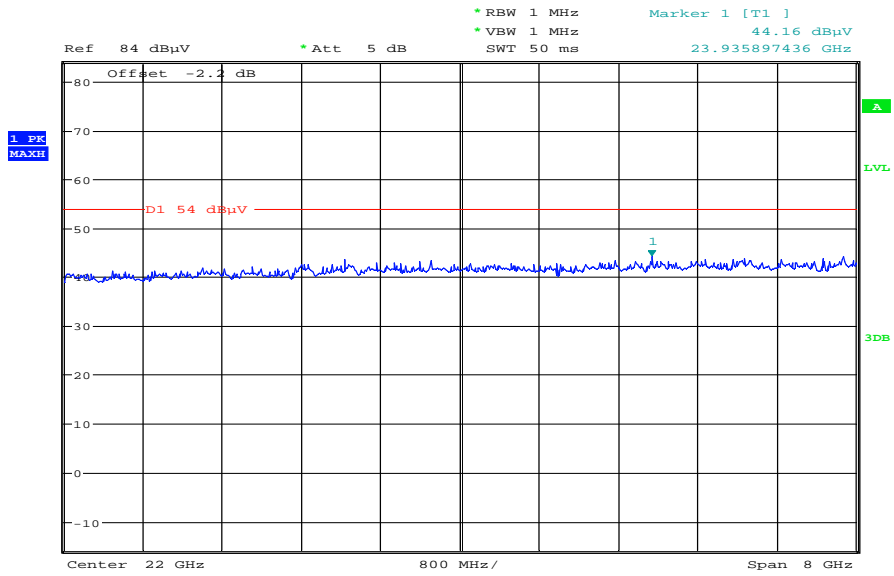

Date: 15.DEC.2012 09:16:23

Plot 5: 30 MHz to 1 GHz, TX mode, channel 39, vertical & horizontal polarization

### Common Information

EUT: RFN81UW  
 Test Description: FCC part 15 C class B @ 10m  
 Operating Conditions: BT DH5 Tx CH39  
 Operator Name: Medrow  
 Comment: battery powered

### Scan Setup: STAN\_Fin [EMI radiated]

Hardware Setup: Electric Field (NOS)  
 Receiver: [ESCI 3]  
 Level Unit: dBµV/m

Subrange	Step Size	Detectors	IF BW	Meas. Time	Preamp
30 MHz - 2 GHz	60 kHz	QPK	120 kHz	1 s	20 dB

FCC\_10m(B)\_3

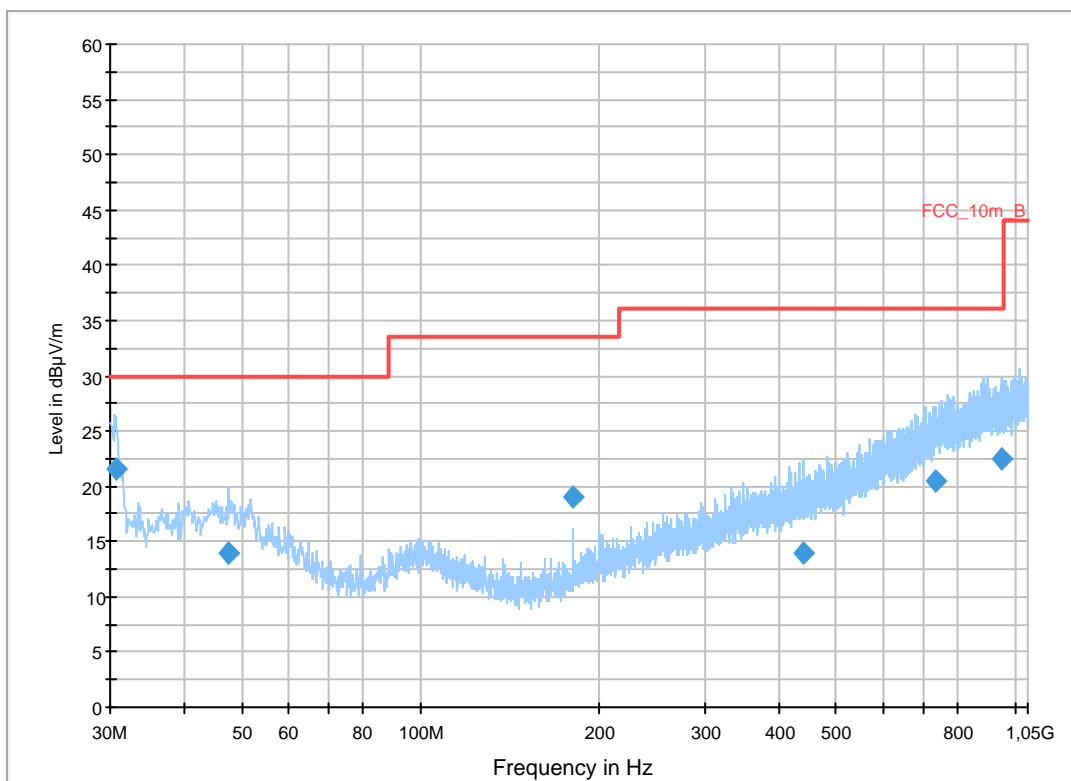

### Final Result 1

Frequency (MHz)	QuasiPeak (dBµV/m)	Meas. Time (ms)	Bandwidth (kHz)	Height (cm)	Polarization	Azimuth (deg)	Corr. (dB)	Margin (dB)	Limit (dBµV/m)	Comment
30.743006	21.5	1000.0	120.000	130.0	V	-10.0	12.6	8.5	30.0	
47.592150	14.0	1000.0	120.000	170.0	V	280.0	13.3	16.0	30.0	
180.009900	19.0	1000.0	120.000	104.0	V	-10.0	10.4	14.5	33.5	
439.522050	14.0	1000.0	120.000	170.0	H	100.0	17.5	22.0	36.0	
734.093100	20.5	1000.0	120.000	112.0	H	170.0	23.3	15.5	36.0	
948.612300	22.4	1000.0	120.000	170.0	H	-10.0	25.3	13.6	36.0	



**Plot 6:** 1 GHz to 12.75 GHz, TX mode, channel 39, vertical & horizontal polarization

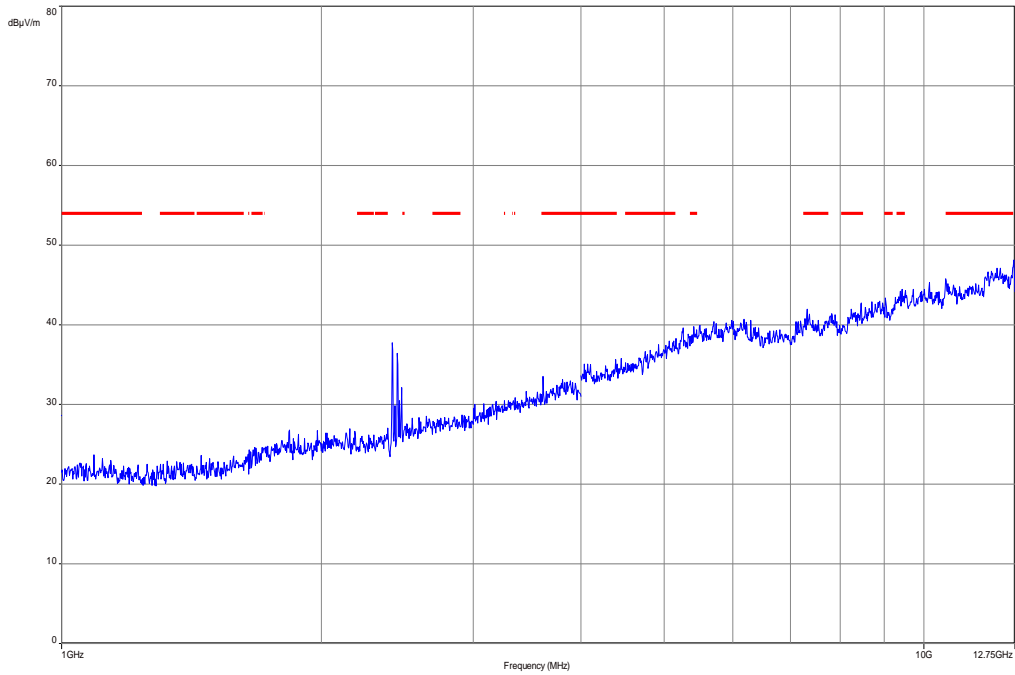

The carrier signal is notched with a 2.4 GHz band rejection filter.

**Plot 7:** 12.75 GHz to 18 GHz, TX mode, channel 39, vertical & horizontal polarization

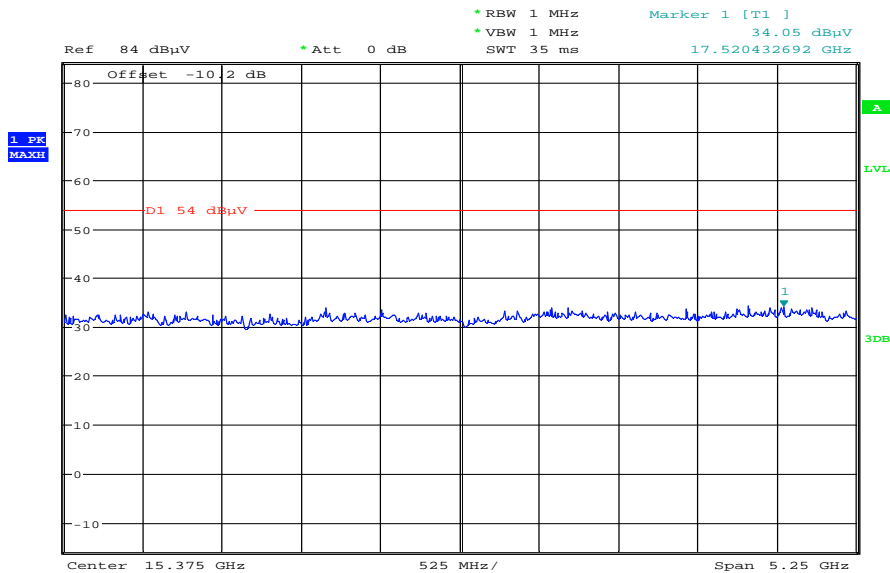

Date: 15.DEC.2012 09:04:33

Plot 8: 18 GHz to 26 GHz, TX mode, channel 39, vertical & horizontal polarization

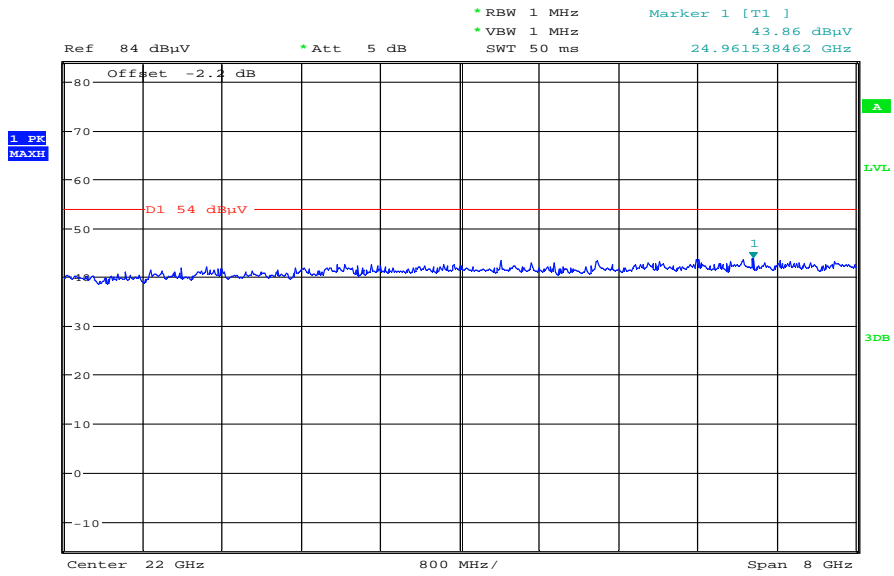

Date: 15.DEC.2012 09:19:49

Plot 9: 30 MHz to 1 GHz, TX mode, channel 78, vertical & horizontal polarization

### Common Information

EUT: RFN81UW  
 Test Description: FCC part 15 C class B @ 10m  
 Operating Conditions: BT DH5 Tx CH78  
 Operator Name: Medrow  
 Comment: battery powered

### Scan Setup: STAN\_Fin [EMI radiated]

Hardware Setup: Electric Field (NOS)  
 Receiver: [ESCI 3]  
 Level Unit: dBµV/m

Subrange	Step Size	Detectors	IF BW	Meas. Time	Preamp
30 MHz - 2 GHz	60 kHz	QPK	120 kHz	1 s	20 dB

FCC\_10m(B)\_3

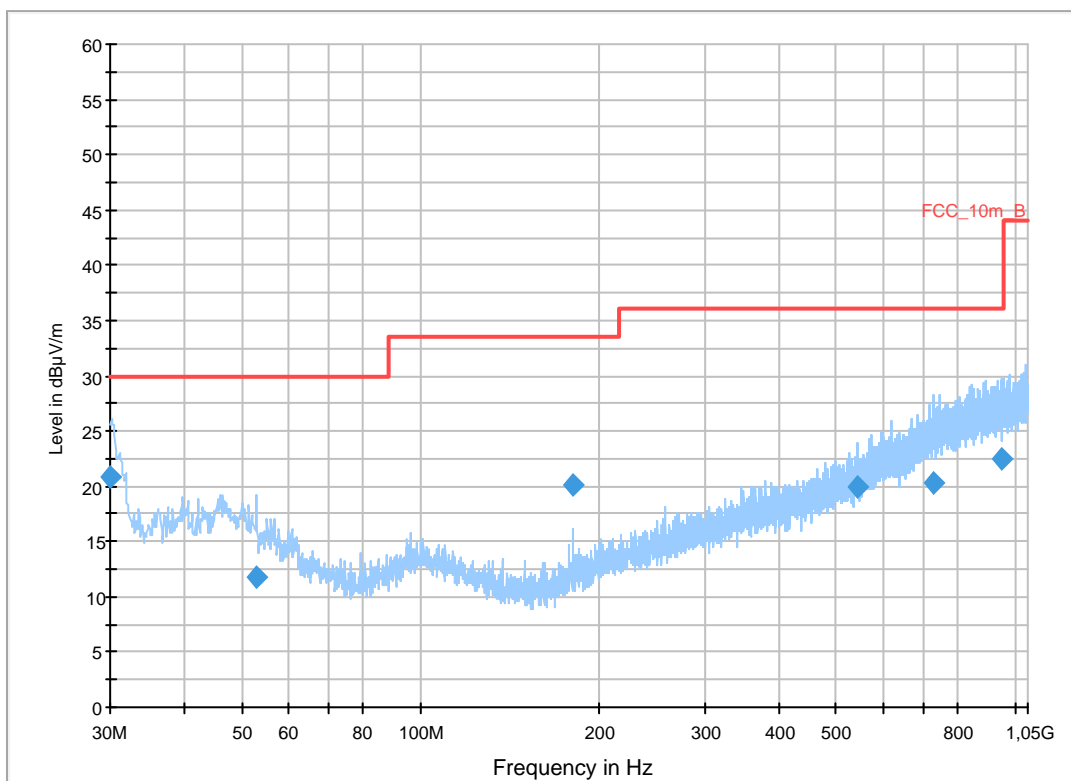

### Final Result 1

Frequency (MHz)	QuasiPeak (dBµV/m)	Meas. Time (ms)	Bandwidth (kHz)	Height (cm)	Polarization	Azimuth (deg)	Corr. (dB)	Margin (dB)	Limit (dBµV/m)	Comment
30.080752	20.9	1000.0	120.000	98.0	V	270.0	12.5	9.1	30.0	
52.686600	11.8	1000.0	120.000	98.0	V	10.0	13.1	18.2	30.0	
179.981100	20.1	1000.0	120.000	98.0	V	272.0	10.4	13.4	33.5	
544.050000	19.9	1000.0	120.000	161.0	H	100.0	19.3	16.1	36.0	
726.704100	20.3	1000.0	120.000	132.0	H	85.0	23.1	15.7	36.0	
951.119850	22.4	1000.0	120.000	142.0	H	100.0	25.4	13.6	36.0	

**Plot 10:** 1 GHz to 12.75 GHz, TX mode, channel 78, vertical & horizontal polarization

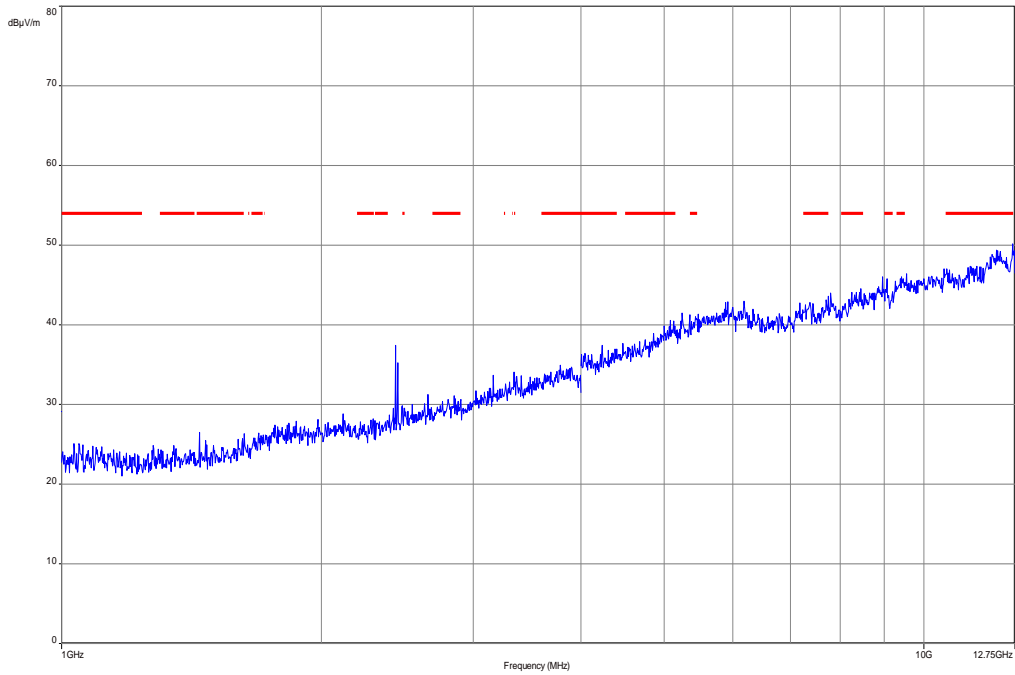

The carrier signal is notched with a 2.4 GHz band rejection filter.

**Plot 11:** 12.75 GHz to 18 GHz, TX mode, channel 78, vertical & horizontal polarization

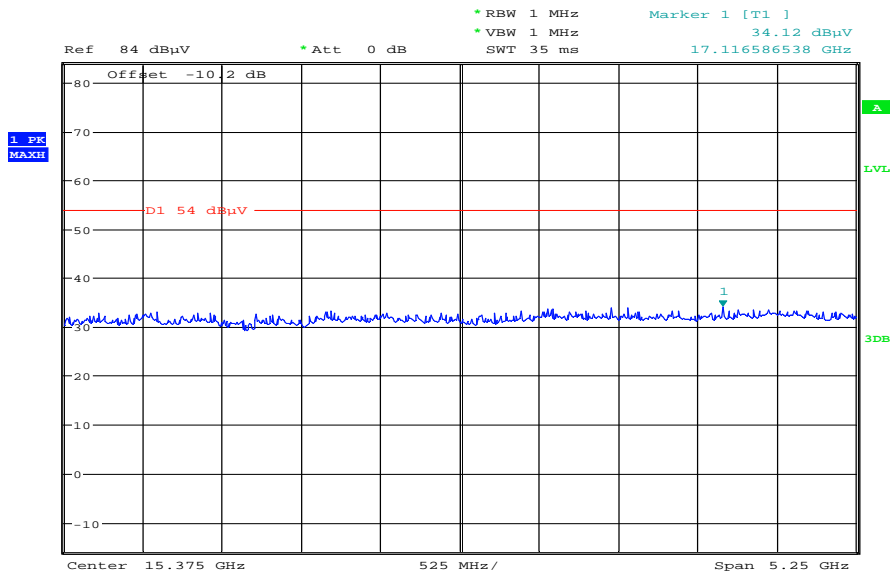

Date: 15.DEC.2012 09:05:28

Plot 12: 18 GHz to 26 GHz, TX mode, channel 78, vertical & horizontal polarization

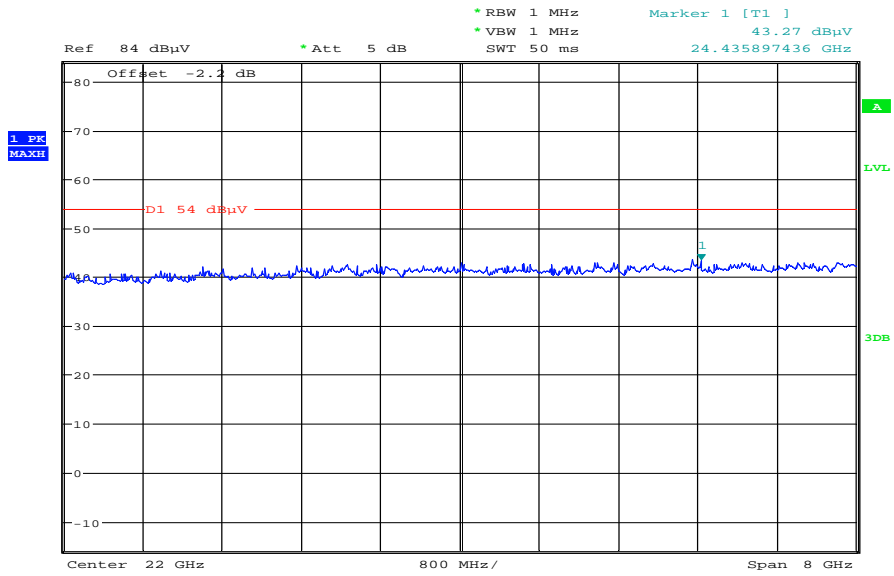

Date: 15.DEC.2012 09:20:33

**Plots:** Pi/4 DQPSK modulation

**Plot 1:** 30 MHz to 1 GHz, TX mode, channel 00, vertical & horizontal polarization

### Common Information

EUT: RFN81UW  
 Test Description: FCC part 15 C class B @ 10m  
 Operating Conditions: BT 2DH5 Tx CH0  
 Operator Name: Medrow  
 Comment: battery powered

### Scan Setup: STAN\_Fin [EMI radiated]

Hardware Setup: Electric Field (NOS)  
 Receiver: [ESCI 3]  
 Level Unit: dBµV/m

Subrange	Step Size	Detectors	IF BW	Meas. Time	Preamp
30 MHz - 2 GHz	60 kHz	QPK	120 kHz	1 s	20 dB

FCC\_10m(B)\_3

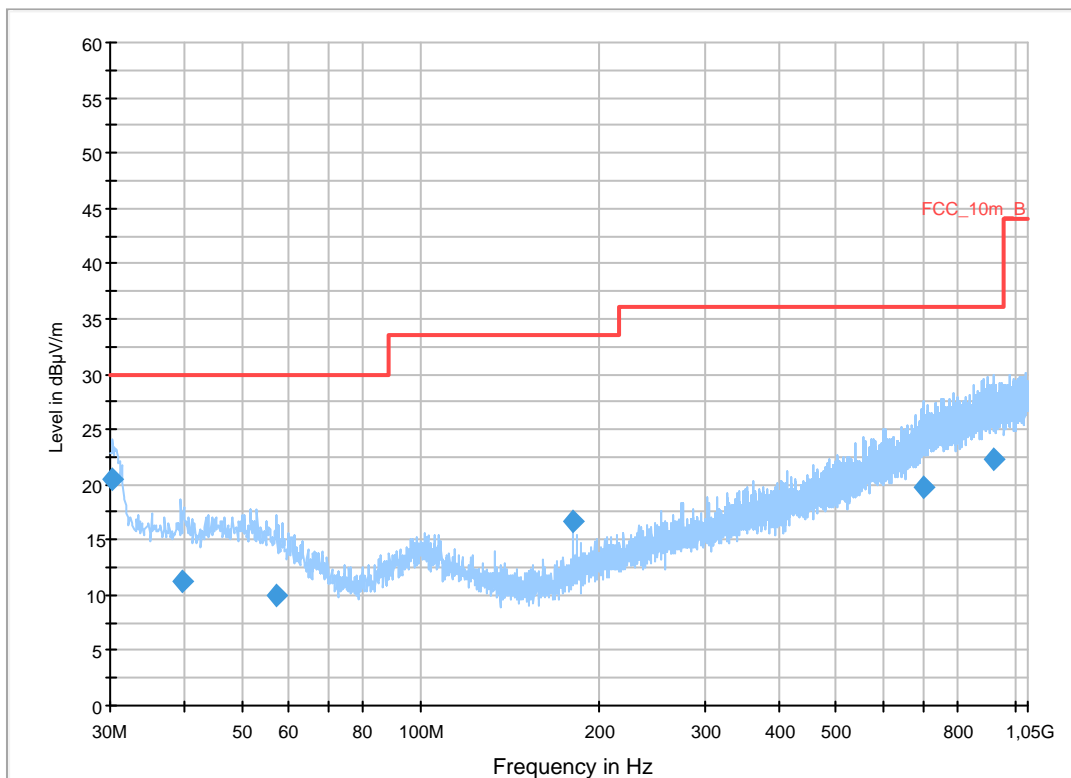

### Final Result 1

Frequency (MHz)	QuasiPeak (dBµV/m)	Meas. Time (ms)	Bandwidth (kHz)	Height (cm)	Polarization	Azimuth (deg)	Corr. (dB)	Margin (dB)	Limit (dBµV/m)	Comment
30.302670	20.4	1000.0	120.000	130.0	V	273.0	12.5	9.6	30.0	
39.749400	11.2	1000.0	120.000	98.0	V	280.0	13.4	18.8	30.0	
57.354000	9.9	1000.0	120.000	132.0	V	190.0	12.3	20.1	30.0	
180.001650	16.6	1000.0	120.000	104.0	V	280.0	10.4	16.9	33.5	
699.630300	19.8	1000.0	120.000	170.0	V	190.0	22.5	16.2	36.0	
917.169900	22.3	1000.0	120.000	170.0	V	280.0	25.3	13.7	36.0	

**Plot 2:** 1 GHz to 12.75 GHz, TX mode, channel 00, vertical & horizontal polarization

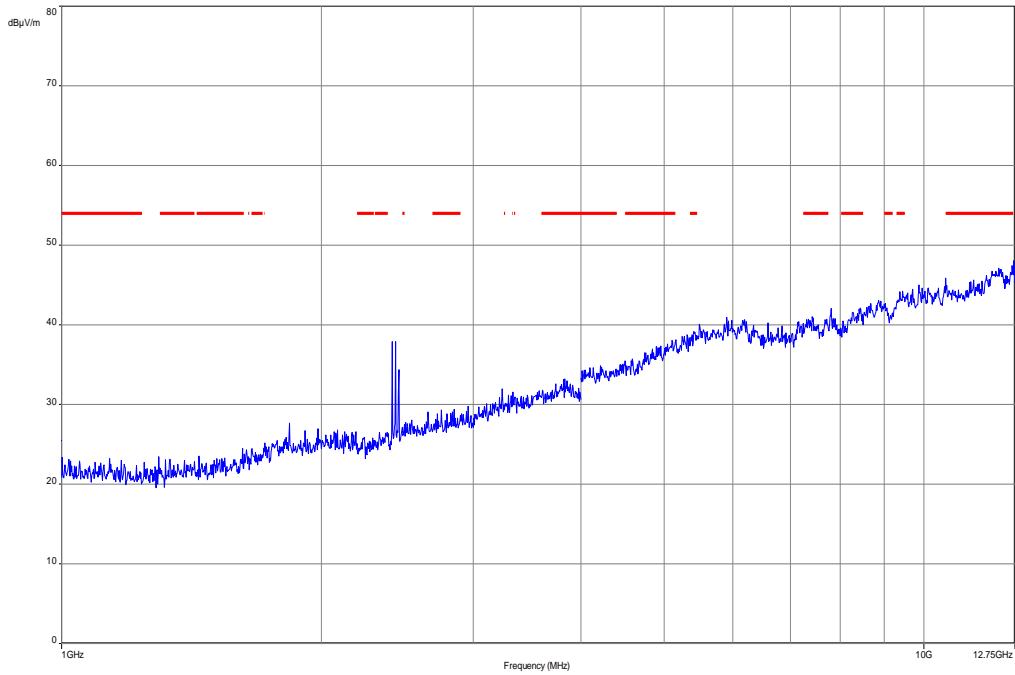

The carrier signal is notched with a 2.4 GHz band rejection filter.

**Plot 3:** 12.75 GHz to 18 GHz, TX mode, channel 00, vertical & horizontal polarization

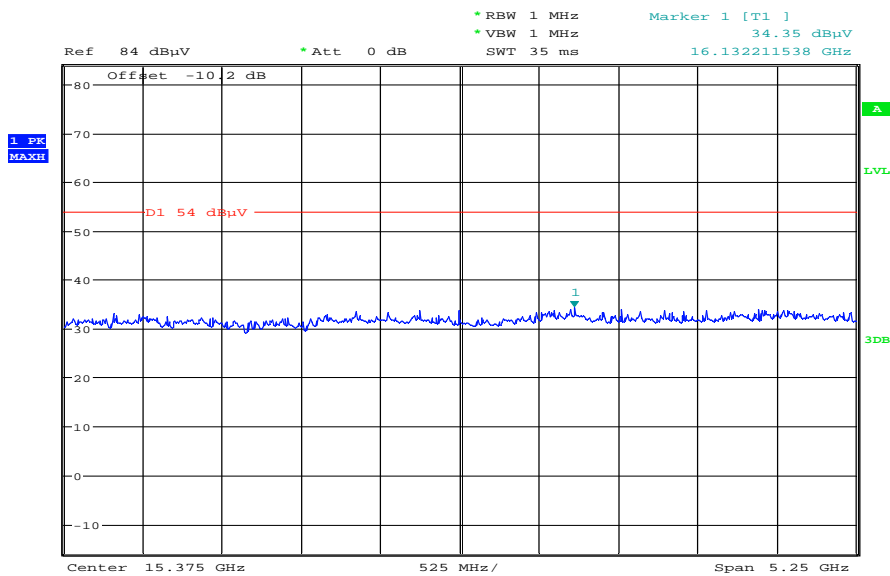

Date: 15.DEC.2012 09:06:44

Plot 4: 18 GHz to 26 GHz, TX mode, channel 00, vertical & horizontal polarization

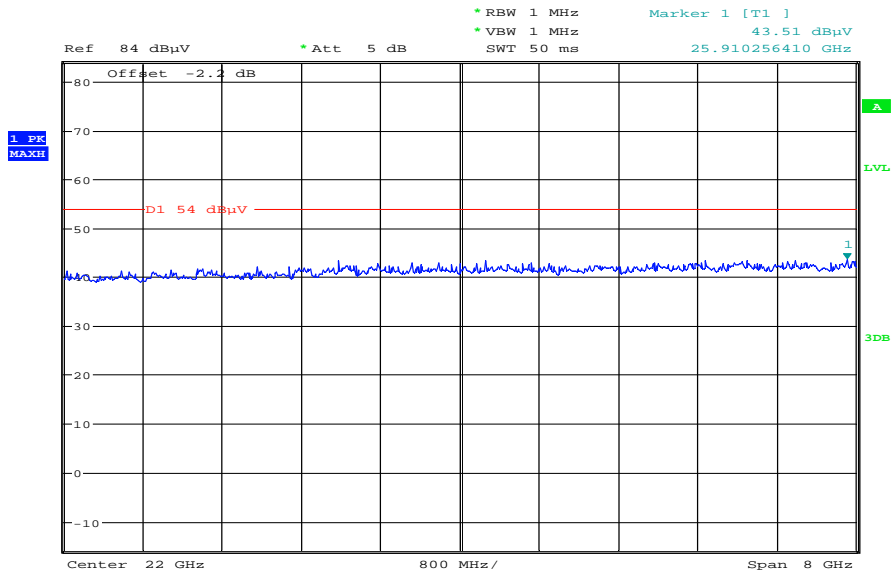

Date: 15.DEC.2012 09:21:58



Plot 5: 30 MHz to 1 GHz, TX mode, channel 39, vertical & horizontal polarization

### Common Information

EUT: RFN81UW  
 Serial Number:  
 Test Description: FCC part 15 C class B @ 10m  
 Operating Conditions: BT 2DH5 Tx CH39  
 Operator Name: Medrow  
 Comment: battery powered

### Scan Setup: STAN\_Fin [EMI radiated]

Hardware Setup: Electric Field (NOS)  
 Receiver: [ESCI 3]  
 Level Unit: dBµV/m

Subrange	Step Size	Detectors	IF BW	Meas. Time	Preamp
30 MHz - 2 GHz	60 kHz	QPK	120 kHz	1 s	20 dB

FCC\_10m(B)\_3

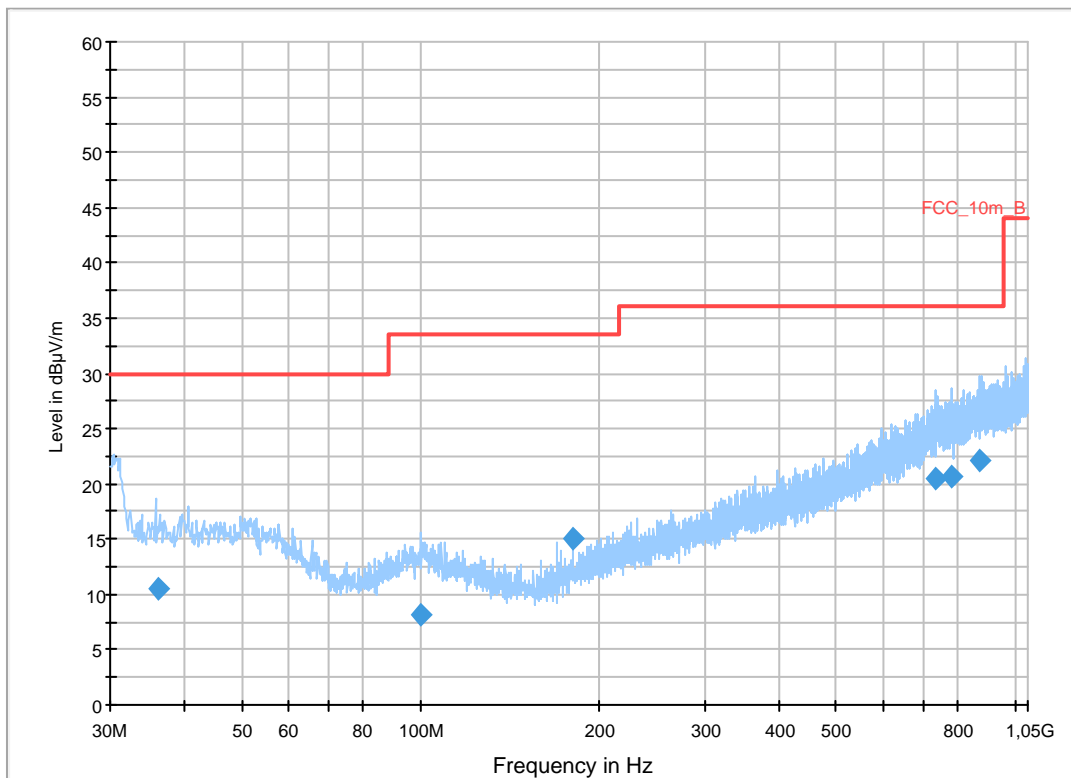

### Final Result 1

Frequency (MHz)	QuasiPeak (dBµV/m)	Meas. Time (ms)	Bandwidth (kHz)	Height (cm)	Polarization	Azimuth (deg)	Corr. (dB)	Margin (dB)	Limit (dBµV/m)	Comment
36.220650	10.5	1000.0	120.000	170.0	V	81.0	13.1	19.5	30.0	
99.722700	8.1	1000.0	120.000	170.0	V	178.0	11.9	25.4	33.5	
179.969700	15.0	1000.0	120.000	98.0	V	268.0	10.4	18.5	33.5	
734.253000	20.5	1000.0	120.000	170.0	V	190.0	23.3	15.5	36.0	
779.664000	20.7	1000.0	120.000	170.0	V	190.0	23.7	15.3	36.0	
874.791600	22.1	1000.0	120.000	170.0	V	2.0	24.9	13.9	36.0	

**Plot 6:** 1 GHz to 12.75 GHz, TX mode, channel 39, vertical & horizontal polarization

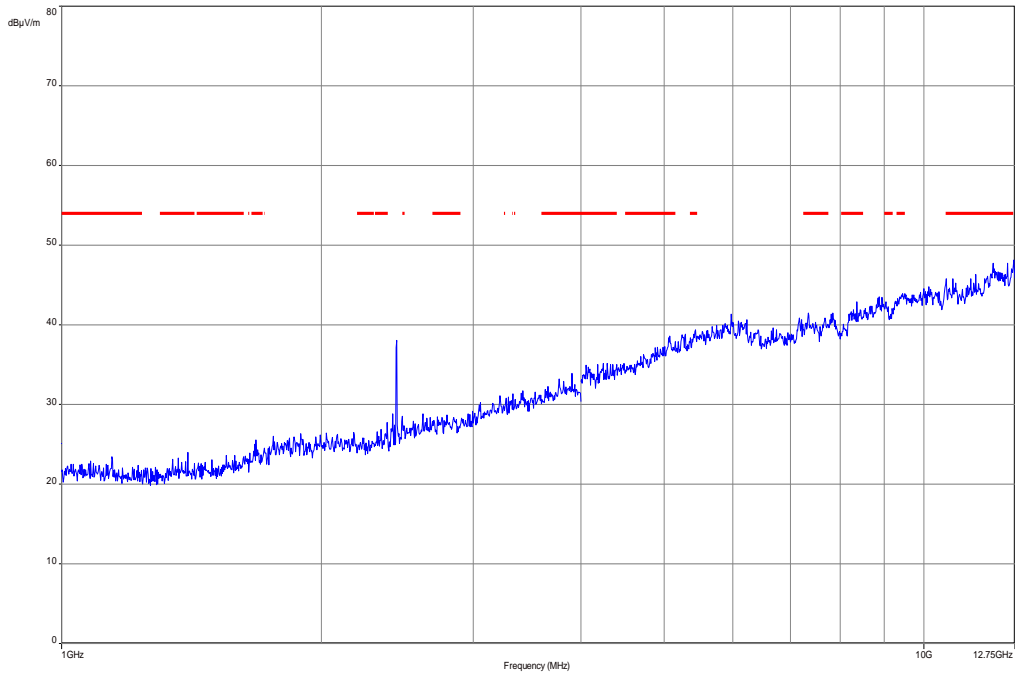

The carrier signal is notched with a 2.4 GHz band rejection filter.

**Plot 7:** 12.75 GHz to 18 GHz, TX mode, channel 39, vertical & horizontal polarization

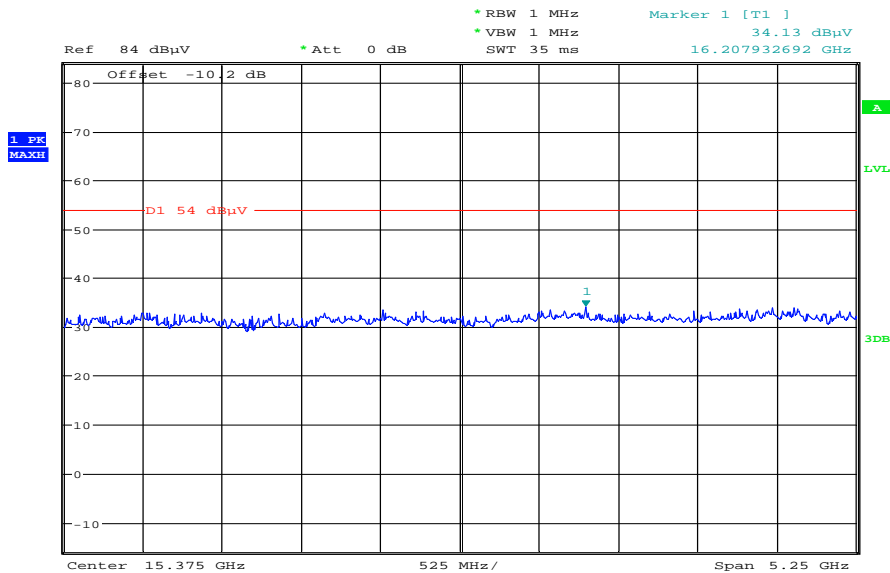

Date: 15.DEC.2012 09:07:29

Plot 8: 18 GHz to 26 GHz, TX mode, channel 39, vertical & horizontal polarization

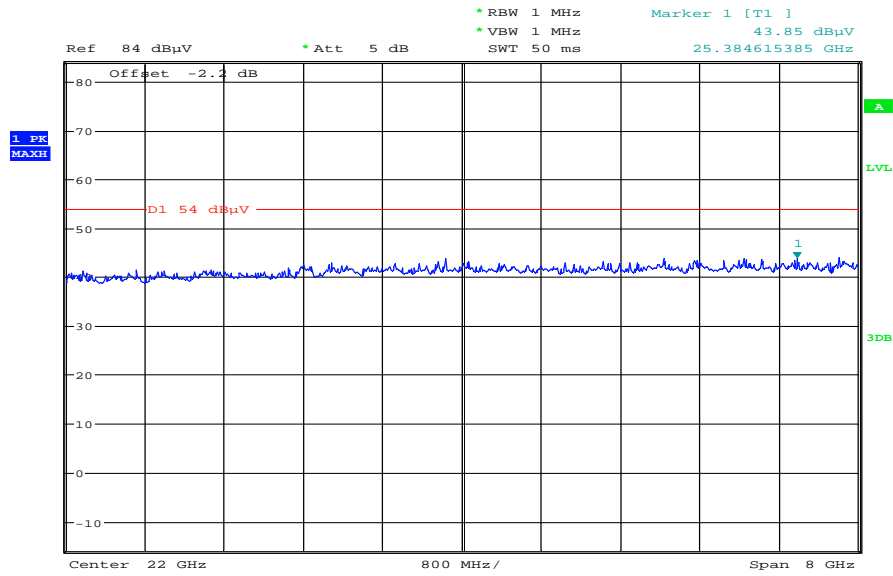

Date: 15.DEC.2012 09:23:04

Plot 9: 30 MHz to 1 GHz, TX mode, channel 78, vertical & horizontal polarization

### Common Information

EUT: RFN81UW  
 Test Description: FCC part 15 C class B @ 10m  
 Operating Conditions: BT 2DH5 Tx CH78  
 Operator Name: Medrow  
 Comment: battery powered

### Scan Setup: STAN\_Fin [EMI radiated]

Hardware Setup: Electric Field (NOS)  
 Receiver: [ESCI 3]  
 Level Unit: dBµV/m

Subrange	Step Size	Detectors	IF BW	Meas. Time	Preamp
30 MHz - 2 GHz	60 kHz	QPK	120 kHz	1 s	20 dB

FCC\_10m(B)\_3

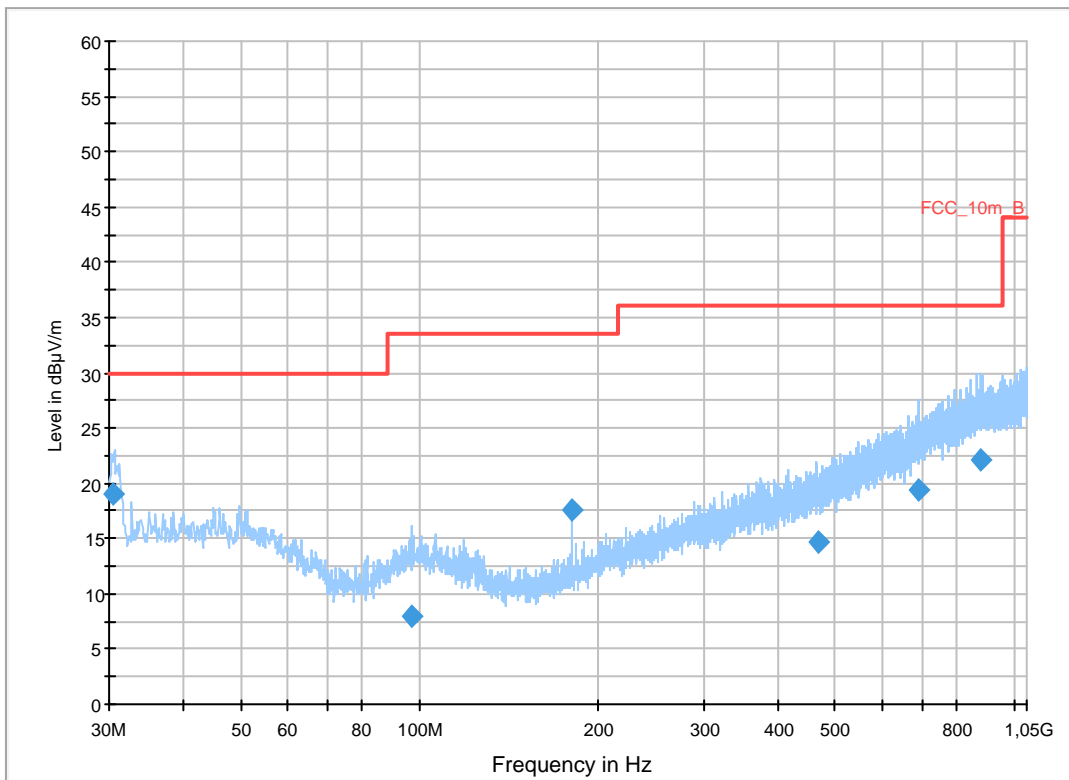

### Final Result 1

Frequency (MHz)	QuasiPeak (dBµV/m)	Meas. Time (ms)	Bandwidth (kHz)	Height (cm)	Polarization	Azimuth (deg)	Corr. (dB)	Margin (dB)	Limit (dBµV/m)	Comment
30.443700	18.9	1000.0	120.000	104.0	V	280.0	12.5	11.1	30.0	
96.623100	8.1	1000.0	120.000	170.0	V	175.0	11.5	25.4	33.5	
180.016950	17.5	1000.0	120.000	98.0	V	261.0	10.4	16.0	33.5	
466.856700	14.6	1000.0	120.000	170.0	H	10.0	18.0	21.4	36.0	
690.255900	19.4	1000.0	120.000	170.0	V	190.0	22.2	16.6	36.0	
876.170850	22.2	1000.0	120.000	170.0	V	261.0	24.9	13.8	36.0	

**Plot 10:** 1 GHz to 12.75 GHz, TX mode, channel 78, vertical & horizontal polarization

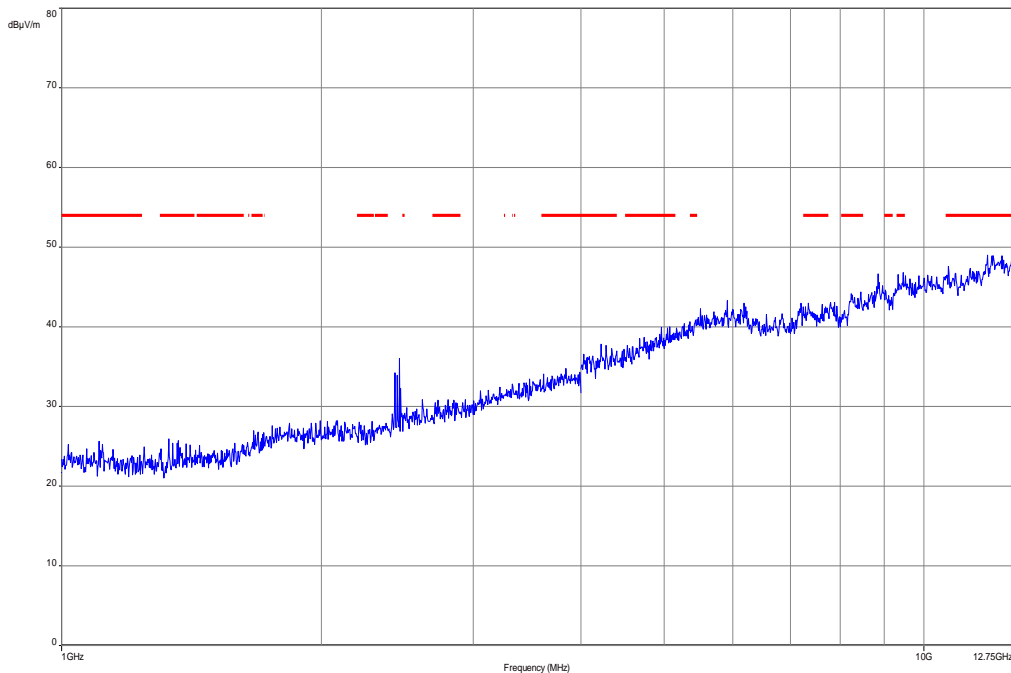

The carrier signal is notched with a 2.4 GHz band rejection filter.

**Plot 11:** 12.75 GHz to 18 GHz, TX mode, channel 78, vertical & horizontal polarization

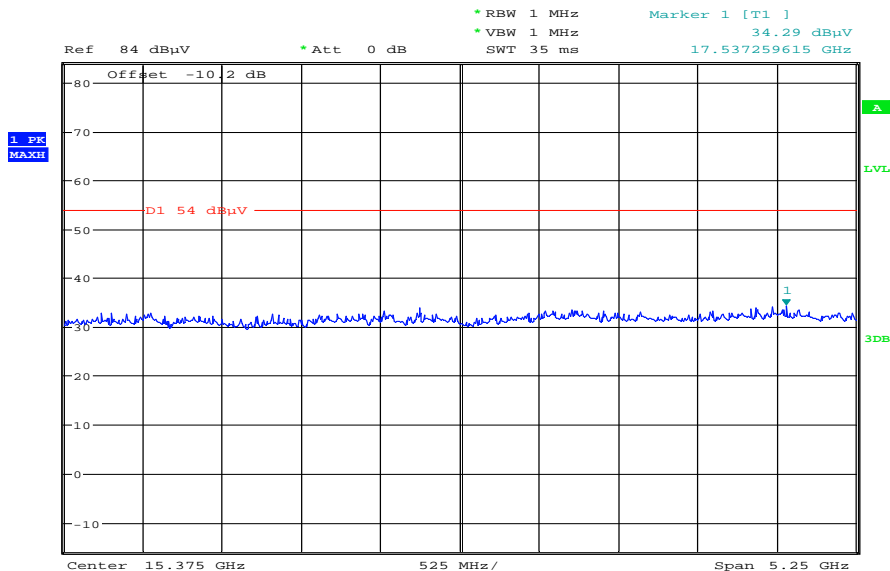

Date: 15.DEC.2012 09:08:23

Plot 12: 18 GHz to 26 GHz, TX mode, channel 78, vertical & horizontal polarization

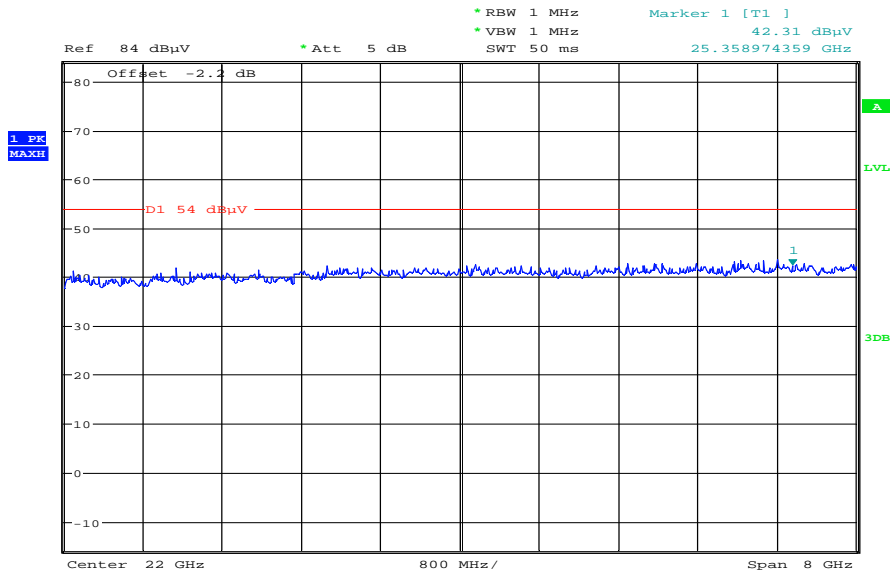

Date: 15.DEC.2012 09:23:50

**Plots:** 8 DPSK modulation

**Plot 1:** 30 MHz to 1 GHz, TX mode, channel 00, vertical & horizontal polarization

### Common Information

EUT: RFN81UW  
 Test Description: FCC part 15 C class B @ 10m  
 Operating Conditions: BT 3DH5 Tx CH0  
 Operator Name: Medrow  
 Comment: battery powered

### Scan Setup: STAN\_Fin [EMI radiated]

Hardware Setup: Electric Field (NOS)  
 Receiver: [ESC1 3]  
 Level Unit: dBµV/m

Subrange	Step Size	Detectors	IF BW	Meas. Time	Preamp
30 MHz - 2 GHz	60 kHz	QPK	120 kHz	1 s	20 dB

FCC\_10m(B)\_3

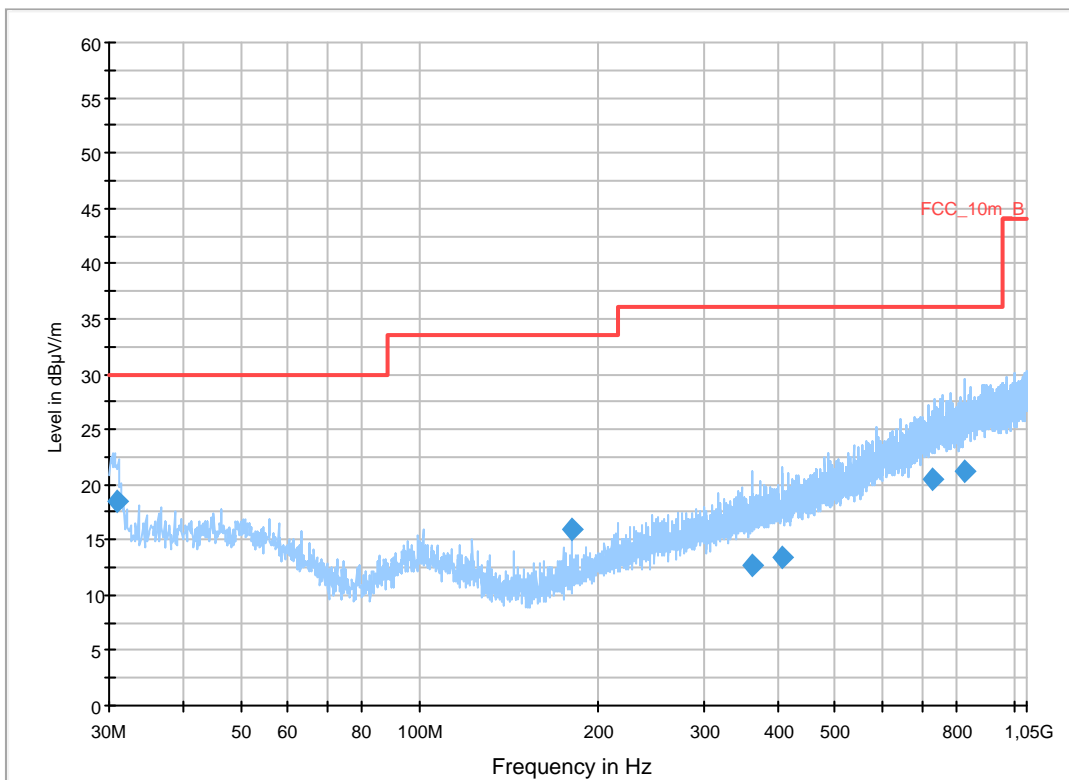

### Final Result 1

Frequency (MHz)	QuasiPeak (dBµV/m)	Meas. Time (ms)	Bandwidth (kHz)	Height (cm)	Polarization	Azimuth (deg)	Corr. (dB)	Margin (dB)	Limit (dBµV/m)	Comment
30.942450	18.5	1000.0	120.000	131.0	V	0.0	12.6	11.5	30.0	
180.022050	16.0	1000.0	120.000	170.0	V	0.0	10.4	17.5	33.5	
361.287750	12.6	1000.0	120.000	112.0	H	261.0	16.3	23.4	36.0	
406.736250	13.5	1000.0	120.000	170.0	V	175.0	17.0	22.5	36.0	
731.822250	20.4	1000.0	120.000	170.0	H	175.0	23.2	15.6	36.0	
825.166350	21.3	1000.0	120.000	161.0	H	260.0	24.2	14.7	36.0	

**Plot 2:** 1 GHz to 12.75 GHz, TX mode, channel 00, vertical & horizontal polarization

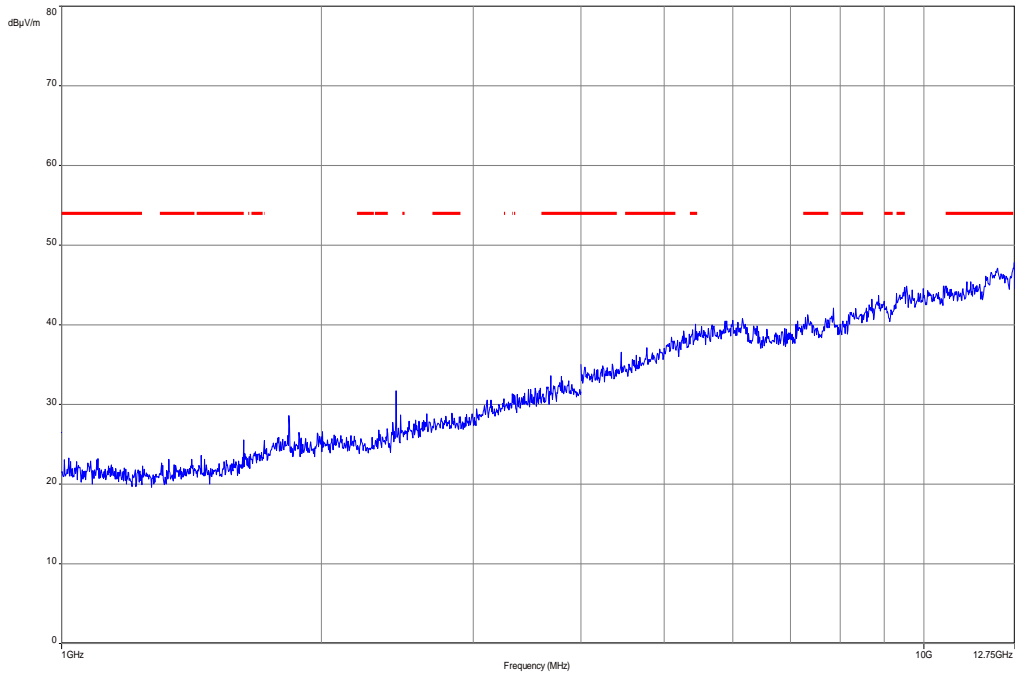

The carrier signal is notched with a 2.4 GHz band rejection filter.

**Plot 3:** 12.75 GHz to 18 GHz, TX mode, channel 00, vertical & horizontal polarization

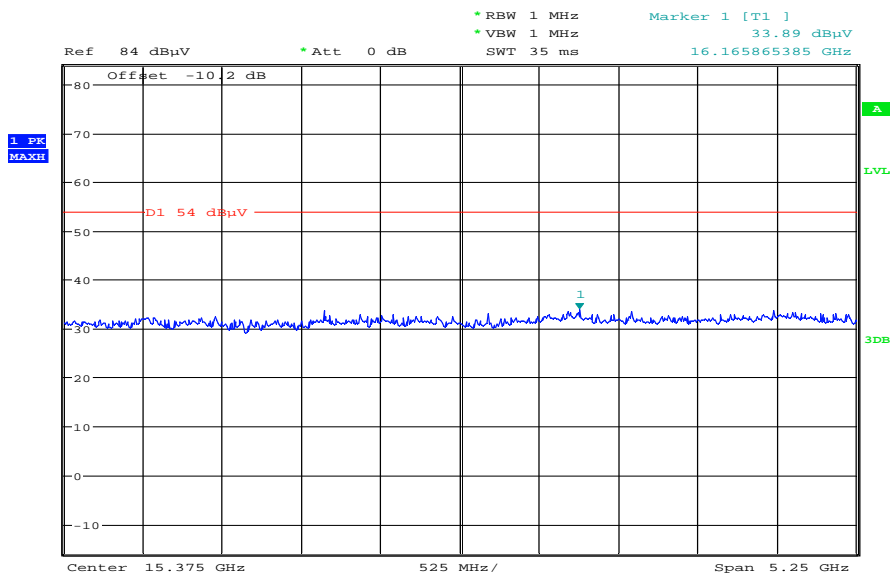

Date: 15.DEC.2012 09:09:32



Plot 4: 18 GHz to 26 GHz, TX mode, channel 00, vertical & horizontal polarization

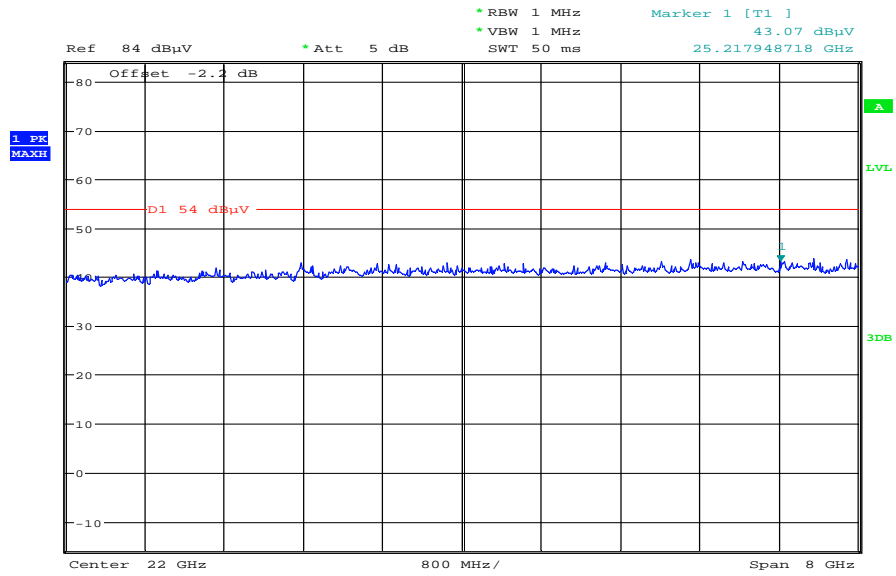

Date: 15.DEC.2012 09:25:38

Plot 5: 30 MHz to 1 GHz, TX mode, channel 39, vertical & horizontal polarization

### Common Information

EUT: RFN81UW  
 Test Description: FCC part 15 C class B @ 10m  
 Operating Conditions: BT 3DH5 Tx CH39  
 Operator Name: Medrow  
 Comment: battery powered

### Scan Setup: STAN\_Fin [EMI radiated]

Hardware Setup: Electric Field (NOS)  
 Receiver: [ESCI 3]  
 Level Unit: dBµV/m

Subrange	Step Size	Detectors	IF BW	Meas. Time	Preamp
30 MHz - 2 GHz	60 kHz	QPK	120 kHz	1 s	20 dB

FCC\_10m(B)\_3

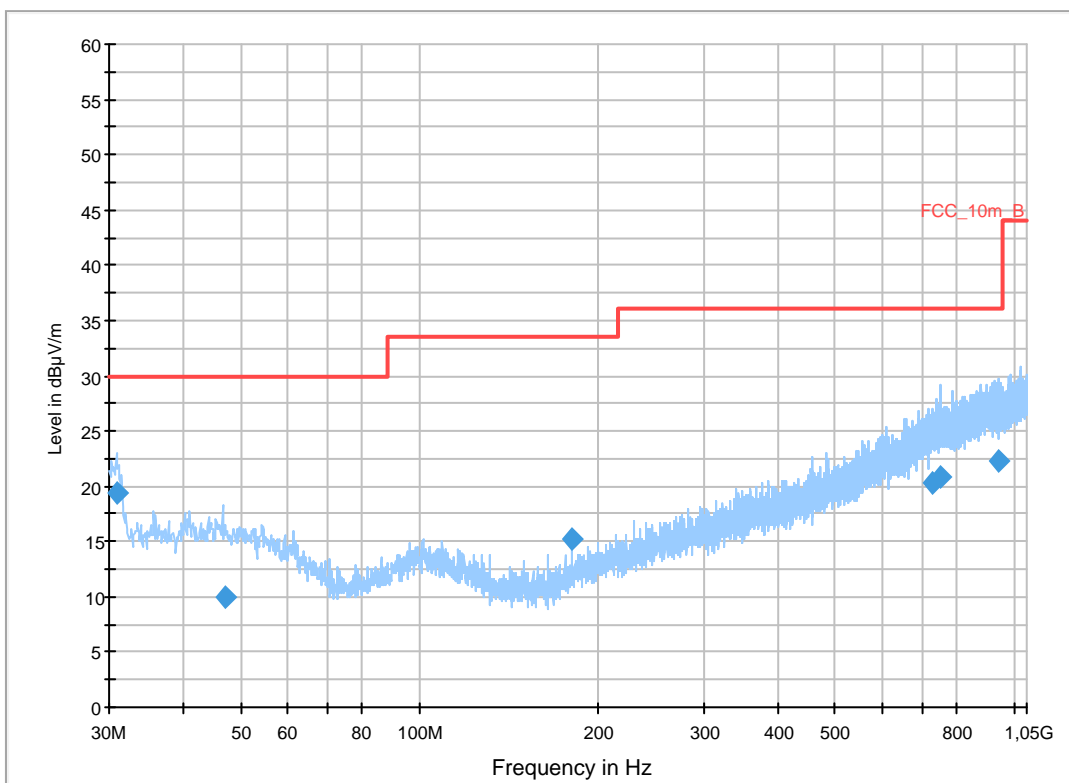

### Final Result 1

Frequency (MHz)	QuasiPeak (dBµV/m)	Meas. Time (ms)	Bandwidth (kHz)	Height (cm)	Polarization	Azimuth (deg)	Corr. (dB)	Margin (dB)	Limit (dBµV/m)	Comment
30.919800	19.3	1000.0	120.000	98.0	V	-10.0	12.6	10.7	30.0	
46.909950	9.9	1000.0	120.000	170.0	V	-10.0	13.3	20.1	30.0	
180.000750	15.2	1000.0	120.000	170.0	V	272.0	10.4	18.3	33.5	
729.223350	20.4	1000.0	120.000	121.0	V	261.0	23.2	15.6	36.0	
754.236000	20.8	1000.0	120.000	170.0	V	280.0	23.7	15.2	36.0	
938.785200	22.3	1000.0	120.000	120.0	V	-2.0	25.3	13.7	36.0	

Plot 6: 1 GHz to 12.75 GHz, TX mode, channel 39, vertical & horizontal polarization

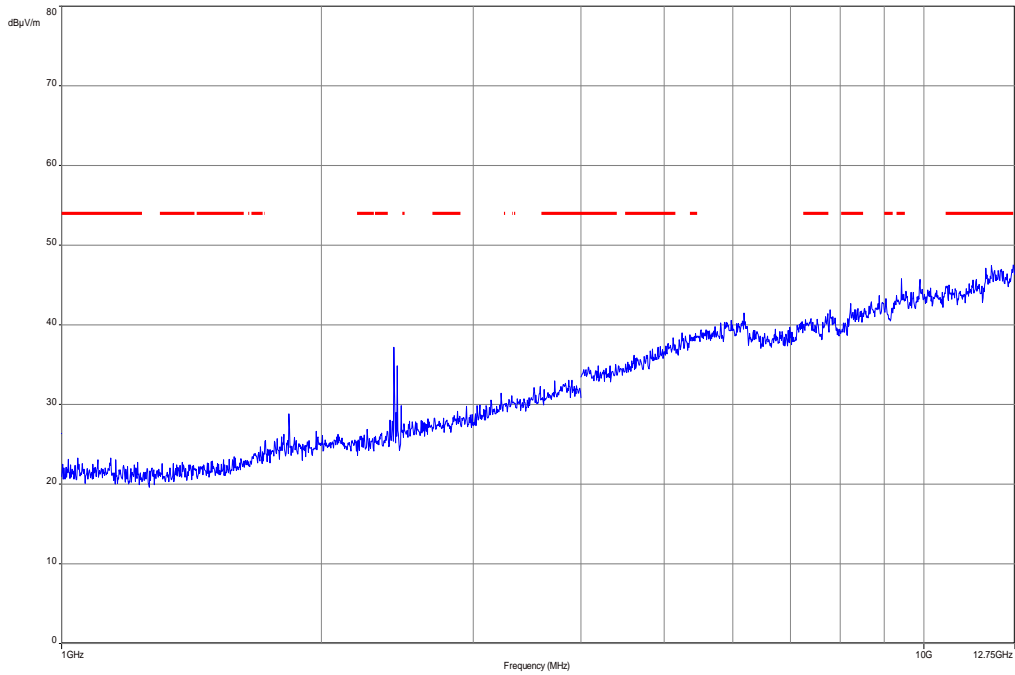

The carrier signal is notched with a 2.4 GHz band rejection filter.

Plot 7: 12.75 GHz to 18 GHz, TX mode, channel 39, vertical & horizontal polarization

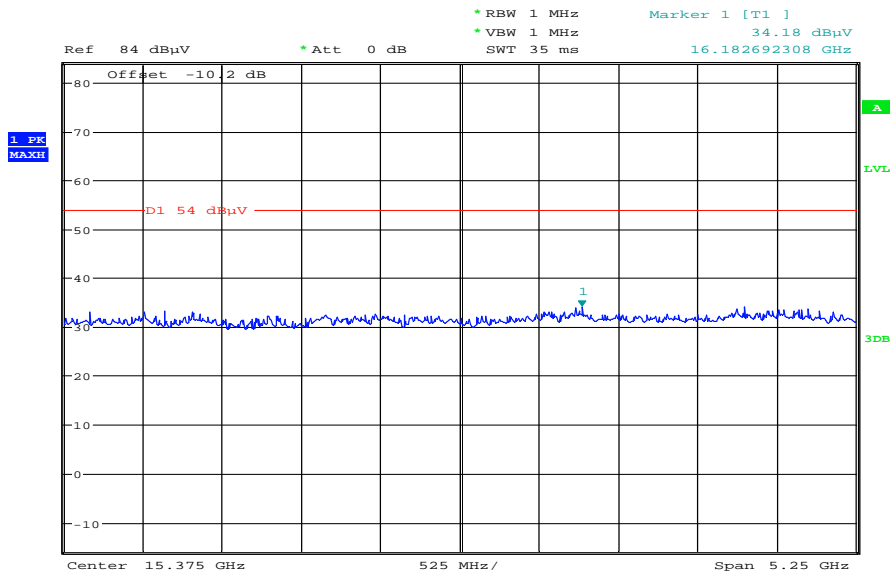

Date: 15.DEC.2012 09:10:43

Plot 8: 18 GHz to 26 GHz, TX mode, channel 39, vertical & horizontal polarization

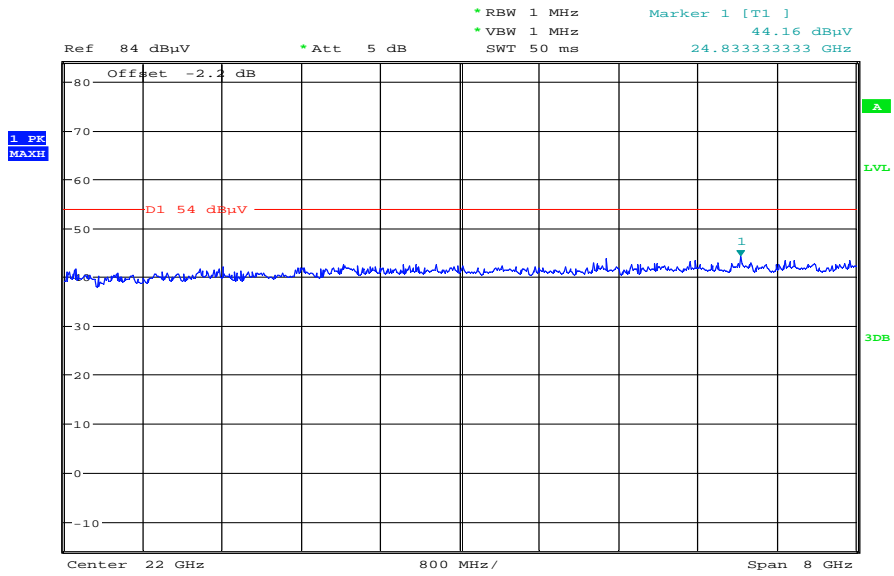

Date: 15.DEC.2012 09:26:28

Plot 9: 30 MHz to 1 GHz, TX mode, channel 78, vertical & horizontal polarization

### Common Information

EUT: RFN81UW  
 Test Description: FCC part 15 C class B @ 10m  
 Operating Conditions: BT 3DH5 Tx CH78  
 Operator Name: Medrow  
 Comment: battery powered

### Scan Setup: STAN\_Fin [EMI radiated]

Hardware Setup: Electric Field (NOS)  
 Receiver: [ESCI 3]  
 Level Unit: dBµV/m

Subrange	Step Size	Detectors	IF BW	Meas. Time	Preamp
30 MHz - 2 GHz	60 kHz	QPK	120 kHz	1 s	20 dB

FCC\_10m(B)\_3

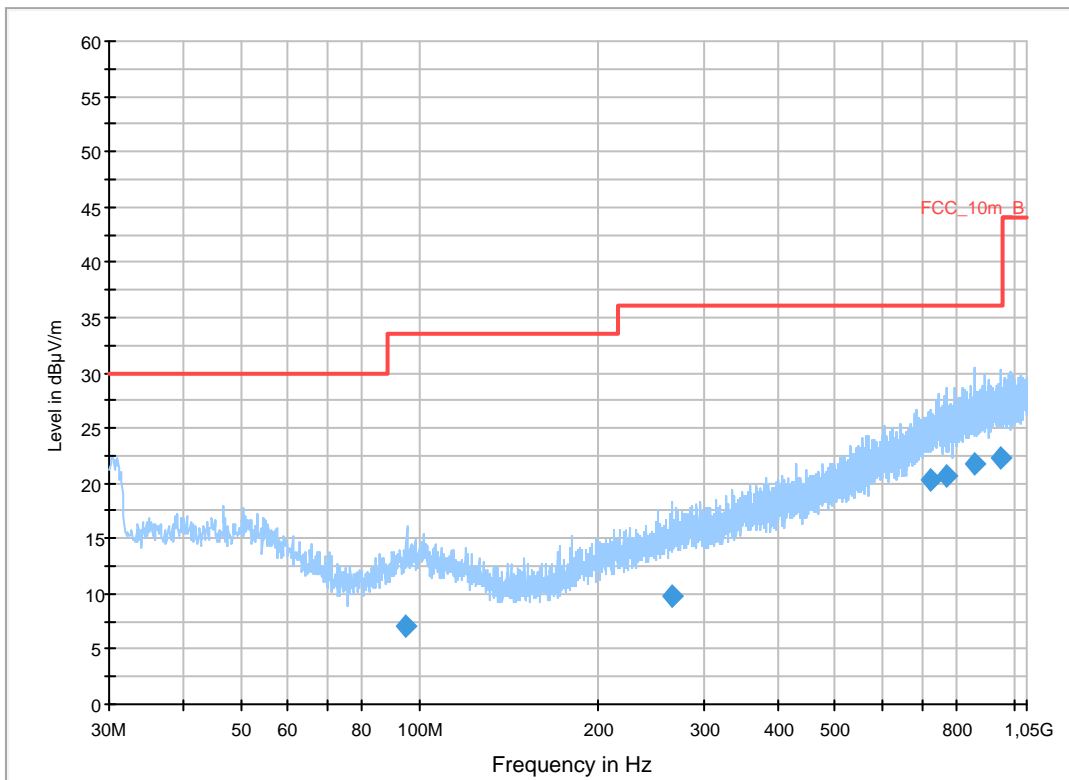

### Final Result 1

Frequency (MHz)	QuasiPeak (dBµV/m)	Meas. Time (ms)	Bandwidth (kHz)	Height (cm)	Polarization	Azimuth (deg)	Corr. (dB)	Margin (dB)	Limit (dBµV/m)	Comment
94.599300	7.1	1000.0	120.000	170.0	H	170.0	11.2	26.4	33.5	
265.974900	9.8	1000.0	120.000	170.0	V	10.0	13.7	26.2	36.0	
725.407350	20.3	1000.0	120.000	170.0	H	-10.0	23.1	15.7	36.0	
769.240650	20.7	1000.0	120.000	170.0	V	80.0	23.7	15.3	36.0	
856.603350	21.8	1000.0	120.000	170.0	H	100.0	24.6	14.2	36.0	
950.038950	22.4	1000.0	120.000	155.0	V	270.0	25.4	13.6	36.0	

**Plot 10:** 1 GHz to 12.75 GHz, TX mode, channel 78, vertical & horizontal polarization

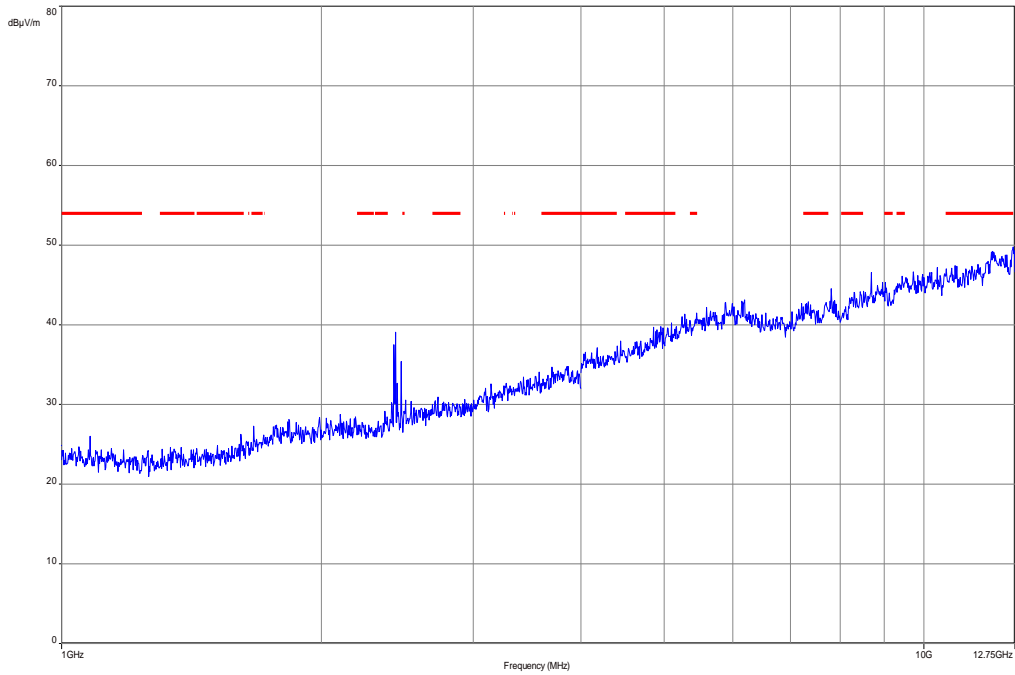

The carrier signal is notched with a 2.4 GHz band rejection filter.

**Plot 11:** 12.75 GHz to 18 GHz, TX mode, channel 78, vertical & horizontal polarization

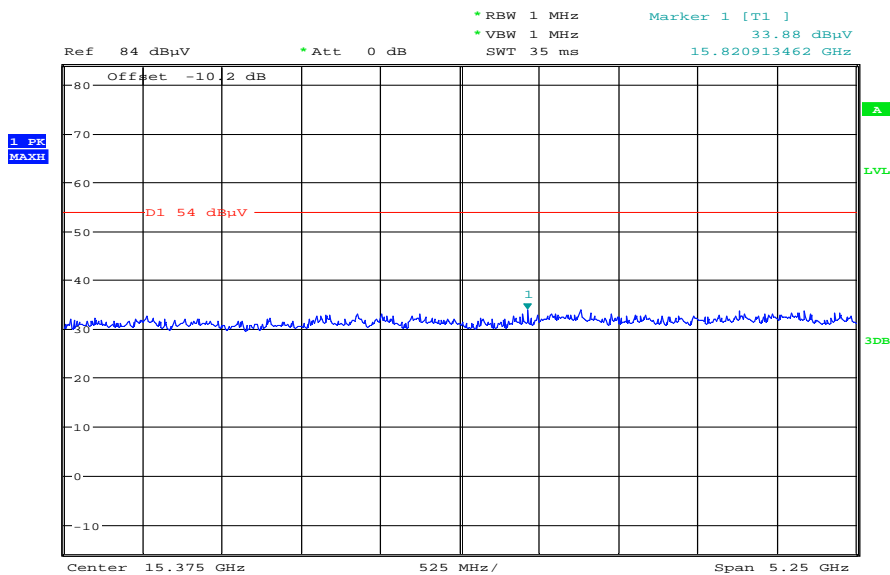

Date: 15.DEC.2012 09:11:40

Plot 12: 18 GHz to 26 GHz, TX mode, channel 78, vertical & horizontal polarization

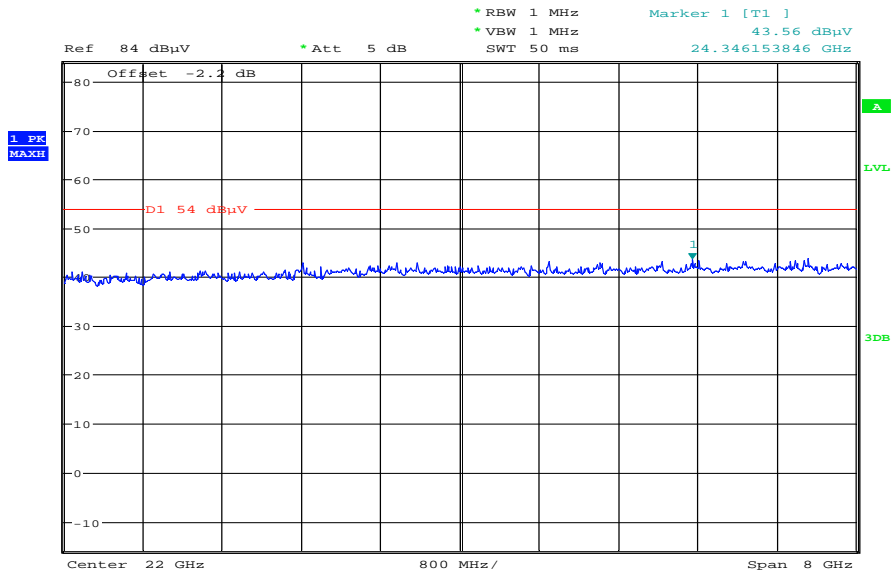

Date: 15.DEC.2012 09:27:18

## 9.12 RX spurious emissions radiated

### Description:

Measurement of the radiated spurious emissions in idle/receive mode. The EUT is detached so all oscillators are active.

### Measurement:

Measurement parameter	
Detector:	Peak / Quasi peak
Sweep time:	Auto
Video bandwidth:	Sweep: 100 kHz Remeasurement: 10 Hz
Resolution bandwidth:	F < 1 GHz: 100 kHz F > 1 GHz: 1 MHz
Span:	30 MHz to 25 GHz
Trace-Mode:	Max Hold

### Limits:

FCC		IC
RX Spurious Emissions Radiated		
Frequency (MHz)	Field strength (dB $\mu$ V/m)	Measurement distance
30 - 88	30.0	10
88 - 216	33.5	10
216 - 960	36.0	10
Above 960	54.0	3

### Results:

RX spurious emissions radiated [dB $\mu$ V/m]		
F [MHz]	Detector	Level [dB $\mu$ V/m]
No critical peaks detected		
Measurement uncertainty	$\pm 3$ dB	

**Result: Passed**



**Plots:**

**Plot 1:** 30 MHz to 1 GHz, RX mode, vertical & horizontal polarization

**Common Information**

EUT: RFN81UW  
 Test Description: FCC part 15 C class B @ 10m  
 Operating Conditions: BT Rx  
 Operator Name: Medrow  
 Comment: battery powered

**Scan Setup: STAN\_Fin [EMI radiated]**

Hardware Setup: Electric Field (NOS)  
 Receiver: [ESC1 3]  
 Level Unit: dBµV/m

Subrange	Step Size	Detectors	IF BW	Meas. Time	Preamp
30 MHz - 2 GHz	60 kHz	QPK	120 kHz	1 s	20 dB

FCC\_10m(B)\_3

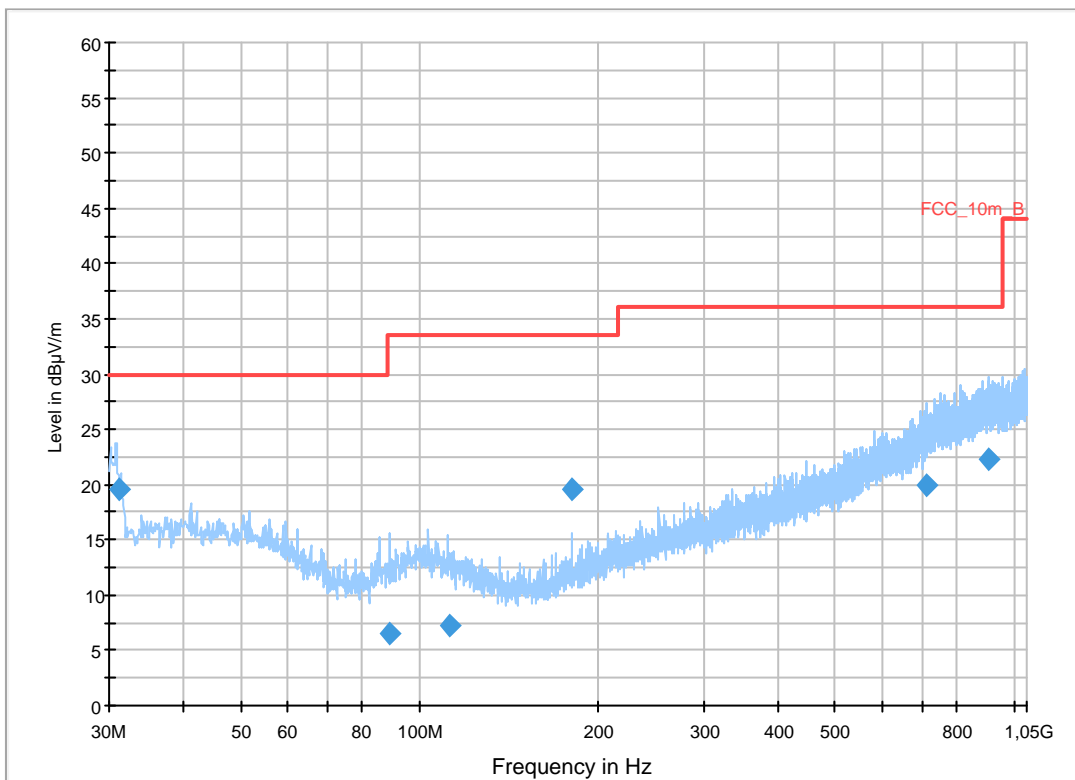

**Final Result 1**

Frequency (MHz)	QuasiPeak (dBµV/m)	Meas. Time (ms)	Bandwidth (kHz)	Height (cm)	Polarization	Azimuth (deg)	Corr. (dB)	Margin (dB)	Limit (dBµV/m)	Comment
31.218900	19.6	1000.0	120.000	98.0	V	10.0	12.6	10.4	30.0	
89.234100	6.6	1000.0	120.000	170.0	H	270.0	10.4	26.9	33.5	
111.908250	7.3	1000.0	120.000	170.0	H	88.0	10.9	26.2	33.5	
180.006300	19.6	1000.0	120.000	98.0	V	2.0	10.4	13.9	33.5	
710.670150	20.0	1000.0	120.000	98.0	H	10.0	22.8	16.0	36.0	
904.816800	22.3	1000.0	120.000	120.0	H	-10.0	25.2	13.7	36.0	

Plot 2: 1 GHz to 12.75 GHz, RX mode, vertical & horizontal polarization

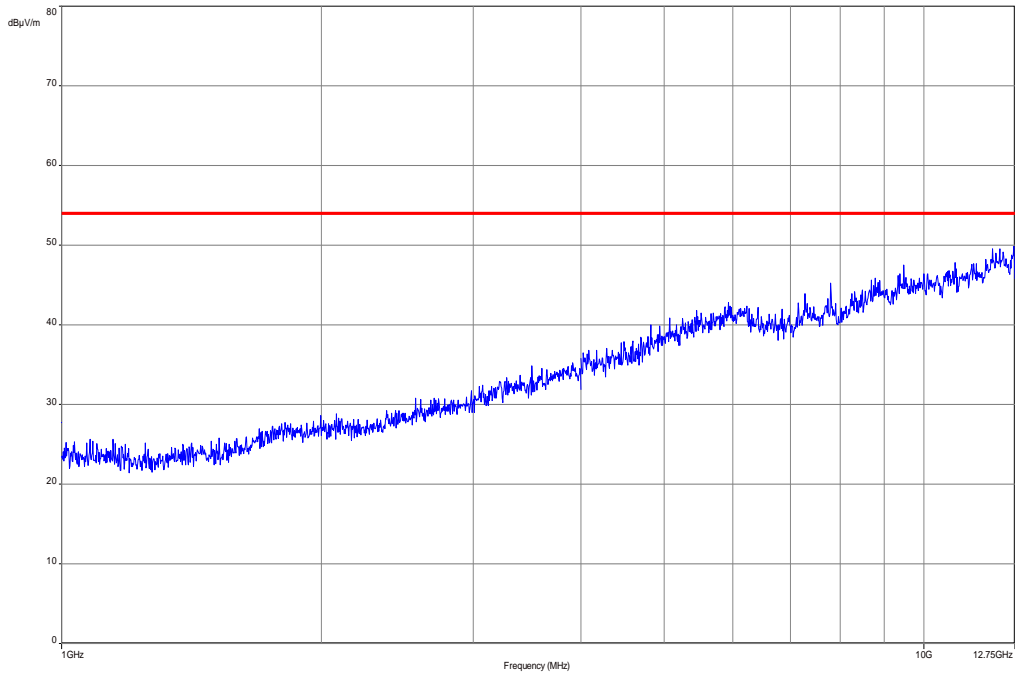

Plot 3: 12.75 GHz to 18 GHz, RX mode, vertical & horizontal polarization

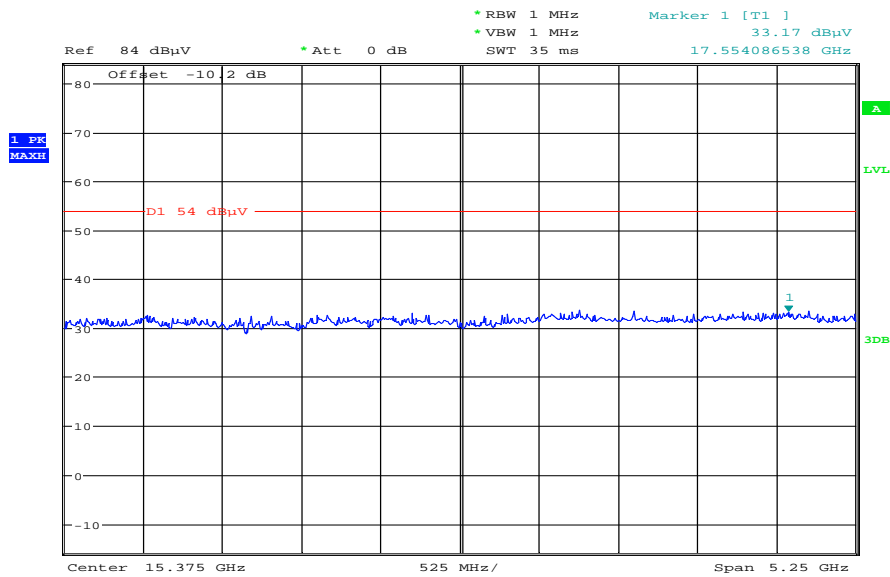

Date: 15.DEC.2012 09:13:02

Plot 4: 18 GHz to 26 GHz, RX mode, vertical & horizontal polarization

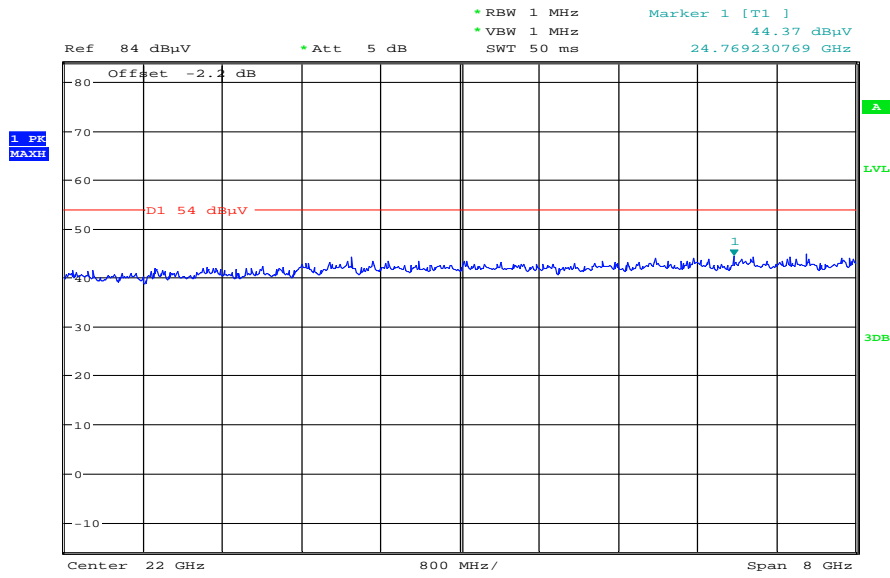

Date: 15.DEC.2012 09:15:10

**9.13 Spurious emissions radiated < 30 MHz**

Not performed!

**9.14 Spurious emissions conducted < 30 MHz**

**Description:**

Measurement of the conducted spurious emissions in transmit mode below 30 MHz. The EUT is set to single channel mode and the transmit channel is channel 39. This measurement is representative for all channels and modes. If critical peaks are found channel 00 and channel 78 will be measured too. The measurement is performed in the mode with the highest output power. Both power lines, phase and neutral line, are measured. Found peaks are remeasured with average and quasi peak detection to show compliance to the limits.

**Measurement:**

Measurement parameter	
Detector:	Peak - Quasi peak / average
Sweep time:	Auto
Video bandwidth:	F < 150 kHz: 200 Hz F > 150 kHz: 9 kHz
Resolution bandwidth:	F < 150 kHz: 1 kHz F > 150 kHz: 100 kHz
Span:	9 kHz to 30 MHz
Trace-Mode:	Max Hold

**Limits:**

FCC		IC
TX spurious emissions conducted < 30 MHz		
Frequency (MHz)	Quasi-peak (dBµV/m)	Average (dBµV/m)
0.15 – 0.5	66 to 56*	56 to 46*
0.5 – 5	56	46
5 – 30.0	60	50

\*Decreases with the logarithm of the frequency

**Results:**

TX spurious emissions conducted < 30 MHz [dBµV/m]		
F [MHz]	Detector	Level [dBµV/m]
No critical peaks detected		
Measurement uncertainty	± 3 dB	

**Result: Passed**

**Plots:**

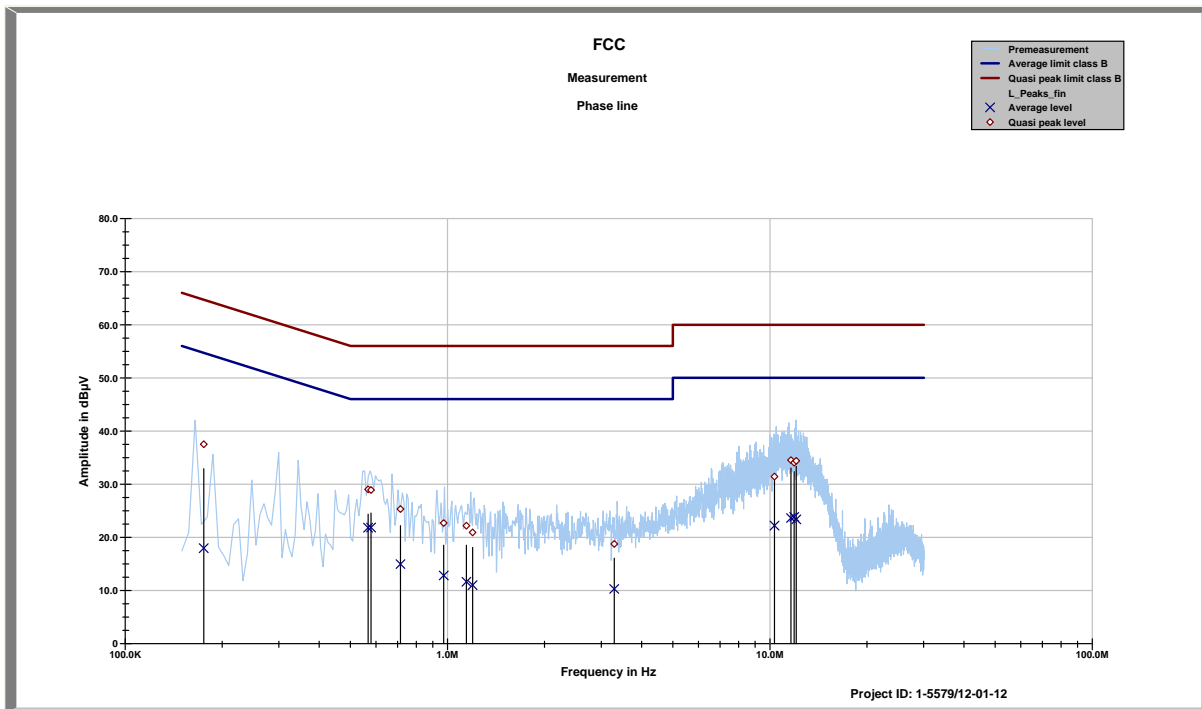

FCC  
Phase line tbl

Project ID: 1-5579/12-01-12

11:08:55 AM, Friday, December 21, 2012

Frequency	Quasi peak level	Margin quasi peak	Average level	Margin average
MHz	dBµV	dBµV	dBµV	dBµV
0.17534	37.51	27.20	17.96	37.31
0.56687	29.02	26.98	21.80	24.20
0.57922	28.90	27.10	21.85	24.15
0.71442	25.32	30.68	14.97	31.03
0.97324	22.69	33.31	12.83	33.17
1.14421	22.19	33.81	11.63	34.37
1.19511	20.93	35.07	11.01	34.99
3.2868	18.75	37.25	10.29	35.71
10.3247	31.43	28.57	22.22	27.78
11.616	34.52	25.48	23.63	26.37
11.8827	34.07	25.93	23.84	26.16
12.0645	34.41	25.59	23.38	26.62

Project ID - 1-5579/12-01-12  
 EUT - RFN81UW  
 Serial Number - IMEI:004401139252122  
 Operating mode - AC115V/60Hz BT CH39 TX DH5 + charging

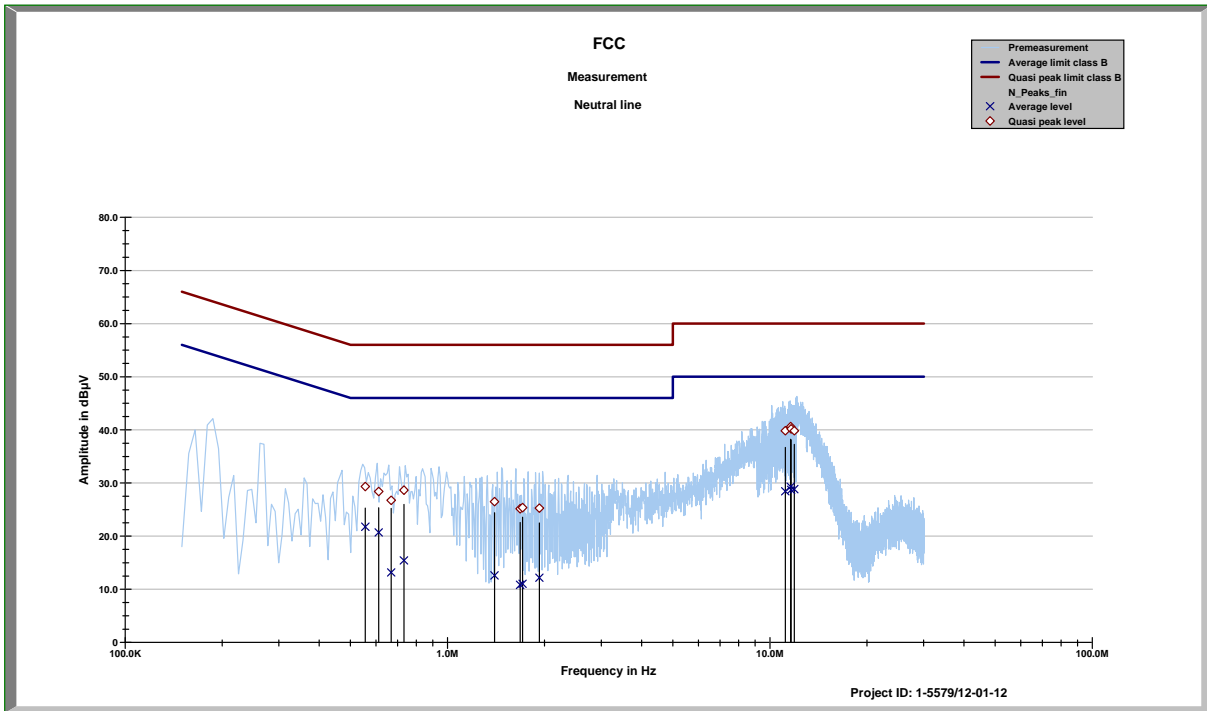

FCC

Neutral line tbl

Project ID: 1-5579/12-01-12

11:08:55 AM, Friday, December 21, 2012

Frequency	Quasi peak level	Margin quasi peak	Average level	Margin average
MHz	dBµV	dBµV	dBµV	dBµV
0.55589	29.32	26.68	21.75	24.25
0.61167	28.38	27.62	20.68	25.32
0.6684	26.72	29.28	13.16	32.84
0.73236	28.64	27.36	15.42	30.58
1.3985	26.48	29.52	12.60	33.40
1.6787	25.16	30.84	10.83	35.17
1.709	25.37	30.63	11.03	34.97
1.9254	25.26	30.74	12.16	33.84
11.1527	39.82	20.18	28.42	21.58
11.591	40.59	19.41	29.31	20.69
11.6313	40.17	19.83	28.70	21.30
11.8936	39.83	20.17	28.82	21.18

Project ID - 1-5579/12-01-12

EUT - RFN81UW

Serial Number - IMEI:004401139252122

Operating mode - AC115V/60Hz BT CH39 TX DH5 + charging

## 10 Test equipment and ancillaries used for tests

Typically, the calibrations of the test apparatus are commissioned to and performed by an accredited calibration laboratory. The calibration intervals are determined in accordance with the DIN EN ISO/IEC 17025. In addition to the external calibrations, the laboratory executes comparison measurements with other calibrated test systems or effective verifications. Weekly chamber inspections and range calibrations are performed. Where possible, rf-generating and signalling equipment as well as measuring receivers and analyzers are connected to an external high-precision 10 MHz reference (GPS-based or rubidium frequency standard).

In order to simplify the identification of the equipment used at some special tests, some items of test equipment and ancillaries can be provided with an identifier or number in the equipment list below (Labor/Item).

No.	Lab / Item	Equipment	Type	Manufact.	Serial No.	INV. No Cetecom	Kind of Calibration	Last Calibration	Next Calibration
1	n. a.	Isolating Transformer	RT5A	Grundig	8041	300001626	g		
2	n. a.	Double-Ridged Waveguide Horn Antenna 1-18.0GHz	3115	EMCO	8812-3088	300001032	vIKI!	11.05.2011	11.05.2013
3	n. a.	Active Loop Antenna	6502	EMCO	2210	300001015	ne		
4	n. a.	Anechoic chamber	FAC 3/5m	MWB / TDK	87400/02	300000996	ev		
5	n. a.	Switch / Control Unit	3488A	HP Meßtechnik	2719A15013	300001156	ne		
6	n. a.	Relais Matrix	PSU	R&S	890167/024	300001168	ne		
7	n. a.	Isolating Transformer	RT5A	Grundig	9242	300001263	ne		
8	n. a.	Three-Way Power Splitter, 50 Ohm	11850C	HP Meßtechnik		300000997	ne		
9	n. a.	Switch / Control Unit	3488A	HP Meßtechnik	2605e08770	300001443	ne		
10	n. a.	Amplifier	js42-00502650-28-5a	Parzich GMBH	928979	300003143	ne		
11	n. a.	Band Reject filter	WRCG2400/2483-2375/2505-50/10SS	Wainwright	11	300003351	ev		
12	n. a.	TRILOG Broadband Test-Antenna 30 MHz - 3 GHz	VULB9163	Schwarzbeck	371	300003854	vIKI!	14.10.2011	14.10.2014
13	n. a.	MXE EMI Receiver 20 Hz bis 26,5 GHz	N9038A	Agilent Technologies	MY51210197	300004405	k		
14	45	Switch-Unit	3488A	HP Meßtechnik	2719A14505	300000368	g		
15	50	DC power supply, 60Vdc, 50A, 1200 W	6032A	HP Meßtechnik	2920A04466	300000580	ne		
16	n. a.	software	SPS_PHE 1.4f	Spitzberger & Spieß	B5981; 5D1081; B5979	300000210	ne		
17	n. a.	EMI Test Receiver	ESCI 1166.5950.03	R&S	100083	300003312	k	04.01.2012	04.01.2013
18	n. a.	Analyzer-Reference-System (Harmonics and Flicker)	ARS 16/1	SPS	A3509 07/0 0205	300003314	k	14.07.2011	14.07.2013
19	n. a.	Amplifier	JS42-00502650-28-5A	MITEQ	1084532	300003379	ev		
20	n. a.	Antenna Tower	Model 2175	ETS-LINDGREN	64762	300003745	izw		
21	n. a.	Positioning Controller	Model 2090	ETS-LINDGREN	64672	300003746	izw		
22	n. a.	Turntable Interface-Box	Model 105637	ETS-LINDGREN	44583	300003747	izw		
23	n. a.	TRILOG Broadband Test-Antenna 30 MHz - 3 GHz	VULB9163	Schwarzbeck	295	300003787	k	12.04.2012	12.04.2014



24	n. a.	Spectrum-Analyzer	FSU26	R&S	200809	300003874	k	06.01.2012	06.01.2014
25	A026	Std. Gain Horn Antenna 12.4 to 18.0 GHz	639	Narda		300000787	ne		
26	A029	Std. Gain Horn Antenna 18.0 to 26.5 GHz	638	Narda		300002442	ne		
27	n. a.	Spectrum Analyzer 20 Hz - 50 GHz	FSU50	R&S	200012	300003443	Ve	09.10.2012	09.10.2014
28	11b	Microwave System Amplifier, 0.5-26.5 GHz	83017A	HP Meßtechnik	00419	300002268	ev		

**Agenda:** Kind of Calibration

- |      |  |     |  |
|------|--|-----|--|
| k    | calibration / calibrated                   | EK  | limited calibration                                  |
| ne   | not required (k, ev, izw, zw not required) | zw  | cyclical maintenance (external cyclical maintenance) |
| ev   | periodic self verification                 | izw | internal cyclical maintenance                        |
| Ve   | long-term stability recognized             | g   | blocked for accredited testing                       |
| vlk! | Attention: extended calibration interval   |     |  |
| NK!  | Attention: not calibrated                  | *)  | next calibration ordered / currently in progress     |

## 11 Observations

No observations exceeding those reported with the single test cases have been made.

**Annex A Document history**

Version	Applied changes	Date of release
1.0	Initial release	2013-01-07
-A	Addition of HW / SW status and FCC / IC number	2013-03-01
-B	Editorial changes	2013-03-08

**Annex B Further information****Glossary**

AVG	-	Average
DUT	-	Device under test
EMC	-	Electromagnetic Compatibility
EN	-	European Standard
EUT	-	Equipment under test
ETSI	-	European Telecommunications Standard Institute
FCC	-	Federal Communication Commission
FCC ID	-	Company Identifier at FCC
HW	-	Hardware
IC	-	Industry Canada
Inv. No.	-	Inventory number
N/A	-	Not applicable
PP	-	Positive peak
QP	-	Quasi peak
S/N	-	Serial number
SW	-	Software

**Annex C Accreditation Certificate**



Deutsche Akkreditierungsstelle GmbH  
German Accreditation Body

Entrusted according to Section 8 subsection 1 AkkStelleG in connection with Section 1 subsection 1 AkkStelleGBV  
Signatory to the Multilateral Agreements of EA, ILAC and IAF for Mutual Recognition

**Accreditation**



The Deutsche Akkreditierungsstelle GmbH (German Accreditation Body) attests that the testing laboratory

**CETECOM ICT Services GmbH**  
Untertürkheimer Straße 6-10  
66117 Saarbrücken

is competent under the terms of DIN EN ISO/IEC 17025:2005 to carry out tests in the following fields:

- Wired communications and DECT
- Acoustic
- Radio
- Shirt Range Devices (SRD)
- RFID
- WiMax and Richtfunk
- Mobile radio (GSM / DCS), Over the Air (OTA) Performance
- Electromagnetic Compatibility (EMC) incl. Automotive
- Product safety
- SAR and Hearing Aid Compatibility (HAC)
- Environmental simulation
- Smart Card Terminals
- Bluetooth
- Wi-Fi-Services

The accreditation certificate shall only apply in connection with the notice of accreditation of 13.04.2011 with the accreditation number D-PL-12076-01 and is valid until 03.09.2014. It comprises the cover sheet, the reverse side of the cover sheet and the following annex with a total of 82 pages.

Registration number of the certificate: **D-PL-12076-01-01**

Frankfurt am Main, 13.04.2011

Dipl.-Ing. (FH) Dr. Egner  
Head of Division 2

This document is a translation. The definitive version is the original German accreditation certificate.  
[www.dakks.de](http://www.dakks.de)

Deutsche Akkreditierungsstelle GmbH

Office Berlin  
Spittelmarkt 10  
10117 Berlin

Office Frankfurt am Main  
Gartenstraße 6  
60594 Frankfurt am Main

Office Braunschweig  
Bundesallee 100  
38116 Braunschweig

The publication of extracts of the accreditation certificate is subject to the prior written approval by Deutsche Akkreditierungsstelle GmbH (DAKKS). Exempted is the unchanged form of separate disseminations of the cover sheet by the conformity assessment body mentioned overleaf.

No impression shall be made that the accreditation also extends to fields beyond the scope of accreditation attested by DAKKS.

The accreditation was granted pursuant to the Act on the Accreditation Body (AkkStelleG) of 31 July 2009 (Federal Law Gazette I p. 2625) and the Regulation (EC) No 765/2008 of the European Parliament and of the Council of 9 July 2008 setting out the requirements for accreditation and market surveillance relating to the marketing of products (Official Journal of the European Union L 218 of 9 July 2008; p. 30). DAKKS is a signatory to the Multilateral Agreements for Mutual Recognition of the European co-operation for Accreditation (EA), International Accreditation Forum (IAF) and International Laboratory Accreditation Cooperation (ILAC). The signatories to these agreements recognise each other's accreditations.

The up-to-date state of membership can be retrieved from the following websites:  
EA: [www.european-accreditation.org](http://www.european-accreditation.org)  
ILAC: [www.ilac.org](http://www.ilac.org)  
IAF: [www.iaf.eu](http://www.iaf.eu)

Front side of certificate

Back side of certificate

**Note:**

The current certificate including annex is published on our website (see link below) or may be received from CETECOM ICT Services on request.

[http://www.cetecom.com/fileadmin/de/CETECOM\\_D\\_Saarbruecken/accreditations\\_Jan\\_2010/DAKKS\\_Akkredi\\_Urk\\_EN17025-En\\_incl\\_Annex.pdf](http://www.cetecom.com/fileadmin/de/CETECOM_D_Saarbruecken/accreditations_Jan_2010/DAKKS_Akkredi_Urk_EN17025-En_incl_Annex.pdf)