

TEST REPORT

Test report no.: 1-5579/12-02-14-B



Testing laboratory

CETECOM ICT Services GmbH
 Untertuerkheimer Strasse 6 – 10
 66117 Saarbruecken / Germany
 Phone: + 49 681 5 98 - 0
 Fax: + 49 681 5 98 - 9075
 Internet: <http://www.cetecom.com>
 e-mail: ict@cetecom.com

Accredited Testing Laboratory:

The testing laboratory (area of testing) is accredited according to DIN EN ISO/IEC 17025 (2005) by the Deutsche Akkreditierungsstelle GmbH (DAkkS). The accreditation is valid for the scope of testing procedures as stated in the accreditation certificate with the registration number: D-PL-12076-01-01. Area of Testing: Radio/Satellite Communications

Applicant

Research In Motion Limited
 305 Phillip Street
 Waterloo, ON N2L 3W8 / CANADA
 Phone: +1 51 98 88 74 65
 Fax: +1 51 98 88 69 06
 Contact: Masud Attayi
 e-mail: mattayi@rim.com
 Phone: +1 51 98 88 74 65

Manufacturer

Research In Motion Limited
 305 Phillip Street
 Waterloo, ON N2L 3W8 / CANADA

Test standard/s

47 CFR Part 22 Title 47 of the Code of Federal Regulations; Chapter I
 Part 22 - Public mobile services
 47 CFR Part 24 Title 47 of the Code of Federal Regulations; Chapter I
 Part 24 - Personal communications services

For further applied test standards please refer to section 3 of this test report.

Test Item

Kind of test item: Blackberry GSM Phones
Model name: RFM121LW
FCC ID: L6ARFM120LW
IC: 2503A-RFM120LW
Frequency: GSM: 824.2 – 848.8 MHz; 1850.2 – 1909.8 MHz
 UMTS: 826.4 – 846.6 MHz; 1712.4 – 1752.6 MHz, 1852.4 – 1907.6 MHz
 CMA2000: 824.7 – 848.31 MHz, 1851.2 – 1908.75 MHz
 BT: ISM band 2400 MHz to 2483.5 MHz
 WLAN: ISM band 2400 MHz to 2483.5 MHz
 UNII bands 5150 MHz to 5250 MHz; 5250 MHz to 5350 MHz;
 5470 MHz to 5725 MHz; 5725 MHz to 5850 MHz
 LTE band IV: 1710.70 MHz – 1754.30 MHz
 LTE band XIII: 776 MHz – 787 MHz
Technology tested: GSM, UMTS, Bluetooth®, WLAN, LTE, CDMA
Antenna: Integrated antenna
Power Supply: 3.8V DC by Li - Ion battery

This test report is electronically signed and valid without handwriting signature. For verification of the electronic signatures, the public keys can be requested at the testing laboratory.

Test report authorised:

Marco Bertolino
 Testing Manager

Test performed:

p.o.
 Andreas Luckenbill
 Expert

1 Table of contents

1	Table of contents	2
2	General information	4
2.1	Notes and disclaimer	4
2.2	Application details	4
3	Test standard/s	5
4	Test environment	6
5	Test item	6
5.1	Additional information	6
6	Test laboratories sub-contracted	6
7	Summary of measurement results	7
7.1	GSM 850	7
7.2	PCS 1900	7
7.3	UMTS band II	8
7.4	UMTS band V	8
7.5	LTE FDD 4	9
7.6	LTE FDD 13	9
8	RF measurements	10
8.1	Description of test setup	10
8.1.1	Radiated measurements	10
8.1.2	Conducted measurements	11
8.2	Results GSM 850	12
8.2.1	RF output power	12
8.2.2	Frequency stability	12
8.2.3	Spurious emissions radiated	13
8.2.4	Spurious emissions conducted	16
8.2.5	Block edge compliance	16
8.2.6	Occupied bandwidth	16
8.3	Results PCS 1900	17
8.3.1	RF output power	17
8.3.2	Frequency stability	17
8.3.3	Spurious emissions radiated	18
8.3.4	Spurious emissions conducted	21
8.3.5	Block edge compliance	21
8.3.6	Occupied bandwidth	21
8.4	Results UMTS band II	22
8.4.1	RF output power	22
8.4.2	Frequency stability	22
8.4.3	Spurious emissions radiated	23
8.4.4	Spurious emissions conducted	26
8.4.5	Block edge compliance	26
8.4.6	Occupied bandwidth	26
8.5	Results UMTS band V	27
8.5.1	RF output power	27
8.5.2	Frequency stability	27
8.5.3	Spurious emissions radiated	28
8.5.4	Spurious emissions conducted	31
8.5.5	Block edge compliance	31
8.5.6	Occupied bandwidth	31
8.6	Results LTE – Band 4	32
8.6.1	RF output power	32

8.6.2	Frequency stability.....	32
8.6.3	Spurious emissions radiated	33
8.6.4	Spurious emissions conducted	36
8.6.5	Block edge compliance.....	36
8.6.6	Occupied bandwidth	36
8.7	Results LTE – Band 13.....	37
8.7.1	RF output power	37
8.7.2	Frequency stability.....	37
8.7.3	Spurious emissions radiated	38
8.7.4	Spurious emissions conducted.....	41
8.7.5	Block edge compliance.....	41
8.7.6	Occupied bandwidth	41
9	Test equipment and ancillaries used for tests	42
10	Observations	42
Annex A	Document history	43
Annex B	Further information.....	43
Annex C	Accreditation Certificate	44

2 General information

2.1 Notes and disclaimer

The test results of this test report relate exclusively to the test item specified in this test report. CETECOM ICT Services GmbH does not assume responsibility for any conclusions and generalizations drawn from the test results with regard to other specimens or samples of the type of the equipment represented by the test item.

The test report may only be reproduced or published in full. Reproduction or publication of extracts from the report requires the prior written approval of CETECOM ICT Services GmbH.

The testing service provided by CETECOM ICT Services GmbH has been rendered under the current "General Terms and Conditions for CETECOM ICT Services GmbH".

CETECOM ICT Services GmbH will not be liable for any loss or damage resulting from false, inaccurate, inappropriate or incomplete product information provided by the customer.

Under no circumstances does the CETECOM ICT Services GmbH test report include any endorsement or warranty regarding the functionality, quality or performance of any other product or service provided.

Under no circumstances does the CETECOM ICT Services GmbH test report include or imply any product or service warranties from CETECOM ICT Services GmbH, including, without limitation, any implied warranties of merchantability, fitness for purpose, or non-infringement, all of which are expressly disclaimed by CETECOM ICT Services GmbH.

All rights and remedies regarding vendor's products and services for which CETECOM ICT Services GmbH has prepared this test report shall be provided by the party offering such products or services and not by CETECOM ICT Services GmbH.

In no case this test report can be considered as a Letter of Approval.

This test report is electronically signed and valid without handwritten signature. For verification of the electronic signatures, the public keys can be requested at the testing laboratory.

2.2 Application details

Date of receipt of order:	2013-01-04
Date of receipt of test item:	2013-03-12
Start of test:	2013-03-12
End of test:	2013-03-27
Person(s) present during the test:	-/-

3 Test standard/s

Test standard	Date	Test standard description
47 CFR Part 22	2012-10	Title 47 of the Code of Federal Regulations; Chapter I Part 22 - Public mobile services
47 CFR Part 24	2012-10	Title 47 of the Code of Federal Regulations; Chapter I Part 24 - Personal communications services
47 CFR Part 27	2012-10	Title 47 of the Code of Federal Regulations; Chapter I Part 27 - Miscellaneous Wireless Communications Service
RSS - 132 Issue 3	2013-01	Spectrum Management and Telecommunications Policy - Radio Standards Specifications Cellular Telephones Employing New Technologies Operating in the Bands 824-849 MHz and 869-894 MHz
RSS - 133 Issue 6	2013-01	Spectrum Management and Telecommunications Policy - Radio Standards Specifications 2 GHz Personal Communication Services
RSS - 139 Issue 2	2009-02	Advanced Wireless Services Equipment Operating in the Bands 1710-1755 MHz and 2110-2155 MHz

4 Test environment

Temperature:	T_{nom}	+22 °C during room temperature tests
	T_{max}	-/- °C during high temperature tests
	T_{min}	-/- °C during low temperature tests
Relative humidity content:		42 %
Barometric pressure:		not relevant for this kind of testing
Power supply:	V_{nom}	3.8 V DC by Li - Ion battery
	V_{max}	-/- V
	V_{min}	-/- V

5 Test item

Kind of test item	:	Blackberry GSM Phones
Type identification	:	RFM121LW
S/N serial number	:	Radiated unit: IMEI 990002430036416: PIN 303E5B59
HW hardware status	:	CER-53013-001Rev2-905-00
SW software status	:	127.0.1.4429
Frequency band [MHz]	:	GSM: 824.2 – 848.8 MHz; 1850.2 – 1909.8 MHz UMTS: 826.4 – 846.6 MHz; 1712.4 – 1752.6 MHz, 1852.4 – 1907.6 MHz CMA2000: 824.7 – 848.31 MHz, 1851.2 – 1908.75 MHz BT: ISM band 2400 MHz to 2483.5 MHz WLAN: ISM band 2400 MHz to 2483.5 MHz UNII bands 5150 MHz to 5250 MHz; 5250 MHz to 5350 MHz; 5470 MHz to 5725 MHz; 5725 MHz to 5850 MHz LTE band IV: 1710.70 MHz – 1754.30 MHz LTE band XIII: 776 MHz – 787 MHz
Type of modulation	:	GMSK, 8-PSK, QPSK, 16 – QAM, GFSK, Pi/4 DQPSK, 8 DPSK, BPSK
Antenna	:	Integrated antenna
Power supply	:	3.8 V DC by Li - Ion battery
Temperature range	:	No deviation over tests.

5.1 Additional information

Test setup- and EUT-photos are included in test reports: 1-5579/12-02-01_AnnexA
1-5579/12-02-01_AnnexC

6 Test laboratories sub-contracted

None

7 Summary of measurement results

- No deviations from the technical specifications were ascertained
- There were deviations from the technical specifications ascertained

TC identifier	Description	verdict	date	Remark
RF-Testing	CFR Part 22, 24, 27 RSS 132, 133, 139	passed	2013-04-04	Tests according manufacturer test plan!

7.1 GSM 850

Test Case	temperature conditions	power source voltages	Not rated	NP	Remark
RF Output Power	Nominal	Nominal	<input type="checkbox"/>	<input checked="" type="checkbox"/>	-/-
Frequency Stability	Nominal	Nominal	<input type="checkbox"/>	<input checked="" type="checkbox"/>	-/-
Spurious Emissions Radiated	Nominal	Nominal	<input checked="" type="checkbox"/>	<input type="checkbox"/>	Simultaneous transmission with BT & WLAN
Spurious Emissions Conducted	Nominal	Nominal	<input type="checkbox"/>	<input checked="" type="checkbox"/>	-/-
Block Edge Compliance	Nominal	Nominal	<input type="checkbox"/>	<input checked="" type="checkbox"/>	-/-
Occupied Bandwidth	Nominal	Nominal	<input type="checkbox"/>	<input checked="" type="checkbox"/>	-/-

Note: NA = Not applicable; NP = Not performed

7.2 PCS 1900

Test Case	temperature conditions	power source voltages	Not rated	NP	Remark
RF Output Power	Nominal	Nominal	<input type="checkbox"/>	<input checked="" type="checkbox"/>	-/-
Frequency Stability	Nominal	Nominal	<input type="checkbox"/>	<input checked="" type="checkbox"/>	-/-
Spurious Emissions Radiated	Nominal	Nominal	<input checked="" type="checkbox"/>	<input type="checkbox"/>	Simultaneous transmission with BT & WLAN
Spurious Emissions Conducted	Nominal	Nominal	<input type="checkbox"/>	<input checked="" type="checkbox"/>	-/-
Block Edge Compliance	Nominal	Nominal	<input type="checkbox"/>	<input checked="" type="checkbox"/>	-/-
Occupied Bandwidth	Nominal	Nominal	<input type="checkbox"/>	<input checked="" type="checkbox"/>	-/-

Note: NA = Not applicable; NP = Not performed

7.3 UMTS band II

Test Case	temperature conditions	power source voltages	Not rated	NP	Remark
RF Output Power	Nominal	Nominal	<input type="checkbox"/>	<input checked="" type="checkbox"/>	-/-
Frequency Stability	Nominal	Nominal	<input type="checkbox"/>	<input checked="" type="checkbox"/>	-/-
Spurious Emissions Radiated	Nominal	Nominal	<input checked="" type="checkbox"/>	<input type="checkbox"/>	Simultaneous transmission with BT & WLAN
Spurious Emissions Conducted	Nominal	Nominal	<input type="checkbox"/>	<input checked="" type="checkbox"/>	-/-
Block Edge Compliance	Nominal	Nominal	<input type="checkbox"/>	<input checked="" type="checkbox"/>	-/-
Occupied Bandwidth	Nominal	Nominal	<input type="checkbox"/>	<input checked="" type="checkbox"/>	-/-

Note: NA = Not applicable; NP = Not performed

7.4 UMTS band V

Test Case	temperature conditions	power source voltages	Not rated	NP	Remark
RF Output Power	Nominal	Nominal	<input type="checkbox"/>	<input checked="" type="checkbox"/>	-/-
Frequency Stability	Nominal	Nominal	<input type="checkbox"/>	<input checked="" type="checkbox"/>	-/-
Spurious Emissions Radiated	Nominal	Nominal	<input checked="" type="checkbox"/>	<input type="checkbox"/>	Simultaneous transmission with BT & WLAN
Spurious Emissions Conducted	Nominal	Nominal	<input type="checkbox"/>	<input checked="" type="checkbox"/>	-/-
Block Edge Compliance	Nominal	Nominal	<input type="checkbox"/>	<input checked="" type="checkbox"/>	-/-
Occupied Bandwidth	Nominal	Nominal	<input type="checkbox"/>	<input checked="" type="checkbox"/>	-/-

Note: NA = Not applicable; NP = Not performed

7.5 LTE FDD 4

Test Case	temperature conditions	power source voltages	Not rated	NP	Remark
RF Output Power	Nominal	Nominal	<input type="checkbox"/>	<input checked="" type="checkbox"/>	-/-
Frequency Stability	Nominal	Nominal	<input type="checkbox"/>	<input checked="" type="checkbox"/>	-/-
Spurious Emissions Radiated	Nominal	Nominal	<input checked="" type="checkbox"/>	<input type="checkbox"/>	Simultaneous transmission with CDMA 2000 & BT & WLAN
Spurious Emissions Conducted	Nominal	Nominal	<input type="checkbox"/>	<input checked="" type="checkbox"/>	-/-
Block Edge Compliance	Nominal	Nominal	<input type="checkbox"/>	<input checked="" type="checkbox"/>	-/-
Occupied Bandwidth	Nominal	Nominal	<input type="checkbox"/>	<input checked="" type="checkbox"/>	-/-

Note: NA = Not applicable; NP = Not performed

7.6 LTE FDD 13

Test Case	temperature conditions	power source voltages	Not rated	NP	Remark
RF Output Power	Nominal	Nominal	<input type="checkbox"/>	<input checked="" type="checkbox"/>	-/-
Frequency Stability	Nominal	Nominal	<input type="checkbox"/>	<input checked="" type="checkbox"/>	-/-
Spurious Emissions Radiated	Nominal	Nominal	<input checked="" type="checkbox"/>	<input type="checkbox"/>	Simultaneous transmission with CDMA 2000 & BT & WLAN
Spurious Emissions Conducted	Nominal	Nominal	<input type="checkbox"/>	<input checked="" type="checkbox"/>	-/-
Block Edge Compliance	Nominal	Nominal	<input type="checkbox"/>	<input checked="" type="checkbox"/>	-/-
Occupied Bandwidth	Nominal	Nominal	<input type="checkbox"/>	<input checked="" type="checkbox"/>	-/-

Note: NA = Not applicable; NP = Not performed

8 RF measurements

8.1 Description of test setup

For the spurious measurements we use the substitution method according TIA/EIA 603.

8.1.1 Radiated measurements

The radiated emissions from the EUT are performed in a semi anechoic chamber. The EUT is placed on a conductive turntable and powered with nominal voltage. The signalling is performed either from outside the chamber with a signalling unit (AP or other) by air link using a signalling antenna or directly by special test software from the customer.

Semi anechoic chamber

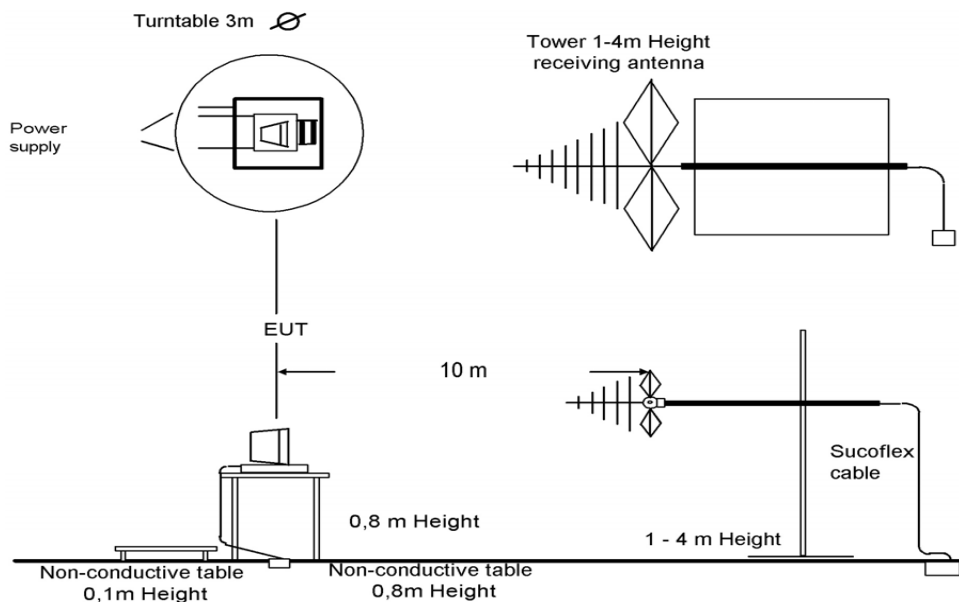

Picture 1: Diagram radiated measurements

9 kHz - 30 MHz:	active loop antenna
30 MHz – 1 GHz:	tri-log antenna
> 1 GHz:	horn antenna

8.1.2 Conducted measurements

The EUT's RF signal is coupled out by the antenna connector which is supplied by the manufacturer. The signal is first 10dB attenuated before it is power divided (~6dB loss per branch). One of the signal paths is connected to the signalling unit (AP or other), the other one is connected to the spectrum analyzer. The specific losses for both signal paths are first checked within a calibration. The measurement readings on the signalling unit/spectrum analyzer are corrected by the specific test set-up loss. The attenuator, power divider, signalling unit and the spectrum analyzer are impedance matched on 50 Ohm. If special software is used, there is no power divider necessary.

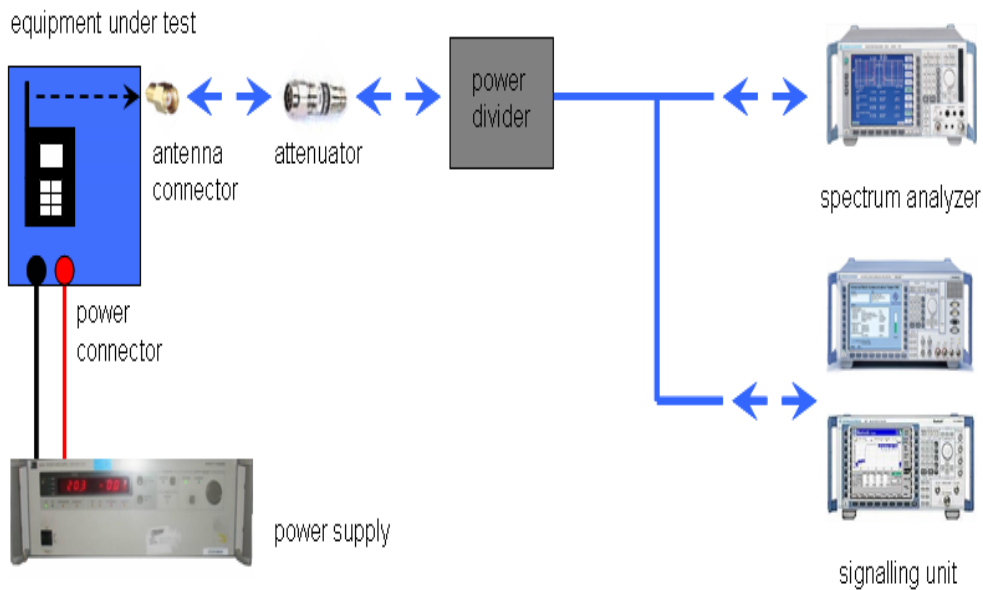

Picture 2: Diagram conducted measurements

The term measuring receiver refers to either a selective voltmeter or a spectrum analyser.

Frequency being measured f	Measuring receiver bandwidth 6 dB	Spectrum analyser bandwidth 3dB
$f < 150 \text{ kHz}$	200 Hz or	300 Hz
$150 \text{ kHz} \leq f < 25 \text{ MHz}$	9 kHz or	10 kHz
$25 \text{ MHz} \leq f < 1000 \text{ MHz}$	120 kHz or	100 kHz
$1000 \text{ MHz} \leq f$		1 MHz
NOTE: Specific requirements in CEPT/ERC/Recommendation 70-03 [2] shall be applied where applicable.		

8.2 Results GSM 850

8.2.1 RF output power

Not performed!

8.2.2 Frequency stability

Not performed!

8.2.3 Spurious emissions radiated

Description:

The mobile is transmitting on the GSM channel 190. Simultaneous the EUT is transmitting Bluetooth in testmode on CH00 and WiFi on channel 11. Bluetooth is transmitting PBRs data in GFSK and WiFi is transmitting random data with 1 Mbps in DSSS.

The measurement is done with respect to ANSI C63.4 / FCC Part 22 and RSS-132.

Measurement:

Measurement parameters	
Detector:	Peak
Sweep time:	2 sec.
Video bandwidth:	Below 1 GHz: 100 kHz Above 1 GHz: 1 MHz
Resolution bandwidth:	Below 1 GHz: 100 kHz Above 1 GHz: 1 MHz
Span:	100 MHz Steps
Trace-Mode:	Max Hold

Limits:

FCC	IC
CFR Part 22.917 CFR Part 2.1053	RSS 132
Spurious Emissions Radiated	
Attenuation $\geq 43 + 10\log(P)$ (P, Power in Watts)	
-13 dBm	

Results:

All measurements were done in horizontal and vertical polarization; the plots show the worst case.

The detected spurious values are stated in the table below.

SPURIOUS EMISSION LEVEL (dBm)		
Frequency	Detector	Level [dBm]
2340 MHz	PP	-42.8 dBm
2402 MHz	PP	-1.4 dBm
Measurement uncertainty		± 3dB

Result: **Passed**

Plots:

Plot 1: Channel 190 (30 MHz – 12.75 GHz)

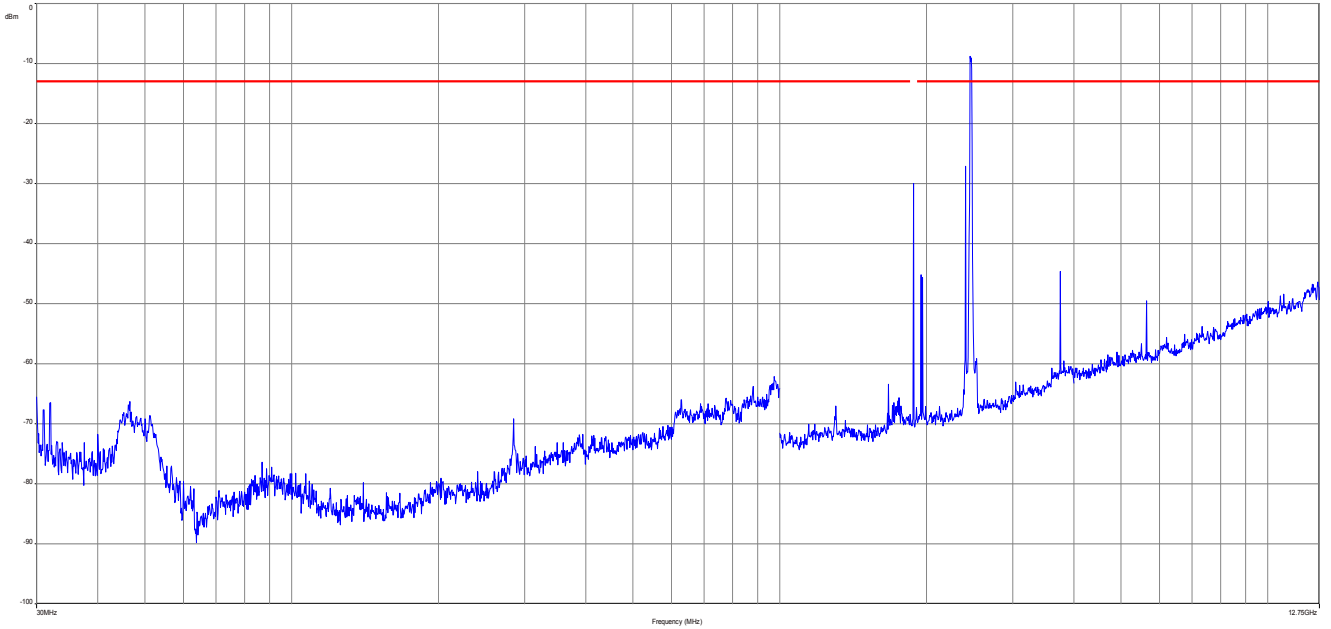

Plot 2: Channel 190 (12.75 GHz – 18 GHz)

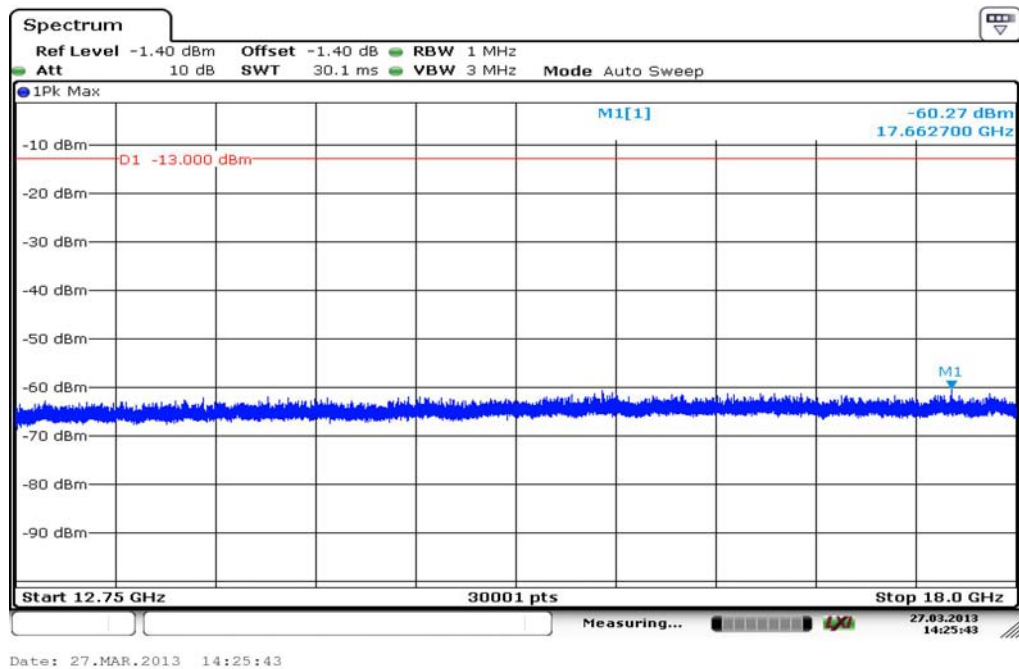

8.2.4 Spurious emissions conducted

Not performed!

8.2.5 Block edge compliance

Not performed!

8.2.6 Occupied bandwidth

Not performed!

8.3 Results PCS 1900

8.3.1 RF output power

Not performed!

8.3.2 Frequency stability

Not performed!

8.3.3 Spurious emissions radiated

Description:

The mobile is transmitting on the GSM channel 661. Simultaneous the EUT is transmitting Bluetooth in testmode on CH00 and WiFi on channel 11. Bluetooth is transmitting PBRS data in Pi/4 DQPSK and WiFi is transmitting random data with 6 Mbps in OFDM (g-mode).

The measurement is done with respect to ANSI C63.4 / FCC Part 24 and RSS-133.

Measurement:

Measurement parameters	
Detector:	Peak
Sweep time:	2 sec.
Video bandwidth:	Below 1 GHz: 100 kHz Above 1 GHz: 1 MHz
Resolution bandwidth:	Below 1 GHz: 100 kHz Above 1 GHz: 1 MHz
Span:	100 MHz Steps
Trace-Mode:	Max Hold

Limits:

FCC	IC
CFR Part 24.238 CFR Part 2.1053	RSS 133
Spurious Emissions Radiated	
Attenuation $\geq 43 + 10\log(P)$ (P, Power in Watts)	
-13 dBm	

Results:

All measurements were done in horizontal and vertical polarization; the plots show the worst case.

The detected spurious values are stated in the table below.

SPURIOUS EMISSION LEVEL (dBm)		
Frequency	Detector	Level [dBm]
1879 MHz	PP	-30.0
1947 MHz	PP	-45.2
1960 MHz	PP	-45.7
2402 MHz	PP	-27.1
3760 MHz	PP	-44.6
5640 MHz	PP	-49.6
Measurement uncertainty		± 3dB

Result: **Passed**

8.3.4 Spurious emissions conducted

Not performed!

8.3.5 Block edge compliance

Not performed!

8.3.6 Occupied bandwidth

Not performed!

8.4 Results UMTS band II

8.4.1 RF output power

Not performed!

8.4.2 Frequency stability

Not performed!

8.4.3 Spurious emissions radiated

Description:

The mobile is transmitting on the UMTS channel 9262. Simultaneous the EUT is transmitting Bluetooth in testmode on CH00 and WiFi on channel 11. Bluetooth is transmitting PBRS data in 8DPSK and WiFi is transmitting random data with MCS0 in OFDM (n-mode).

The measurement is done with respect to ANSI C63.4 / FCC Part 24 and RSS-133.

Measurement:

Measurement parameters	
Detector:	Peak
Sweep time:	2 sec.
Video bandwidth:	Below 1 GHz: 100 kHz Above 1 GHz: 1 MHz
Resolution bandwidth:	Below 1 GHz: 100 kHz Above 1 GHz: 1 MHz
Span:	100 MHz Steps
Trace-Mode:	Max Hold

Limits:

FCC	IC
CFR Part 24.238 CFR Part 2.1053	RSS 133
Spurious Emissions Radiated	
Attenuation $\geq 43 + 10\log(P)$ (P, Power in Watts)	
-13 dBm	

Results:

All measurements were done in horizontal and vertical polarization; the plots show the worst case.

The detected spurious values are stated in the table below.

SPURIOUS EMISSION LEVEL (dBm)		
Frequency	Detector	Level [dBm]
1880 MHz	PP	-27.6 dBm
1947 MHz	PP	-46.8 dBm
1960 MHz	PP	-45.1 dBm
2402 MHz	PP	-32.0 dBm
3760 MHz	PP	-44.8 dBm
3819 MHz	PP	-42.9 dBm
Measurement uncertainty		± 3dB

Result: **Passed**

Plots:

Plot 1: Channel 9262 (30 MHz – 12.75 GHz)

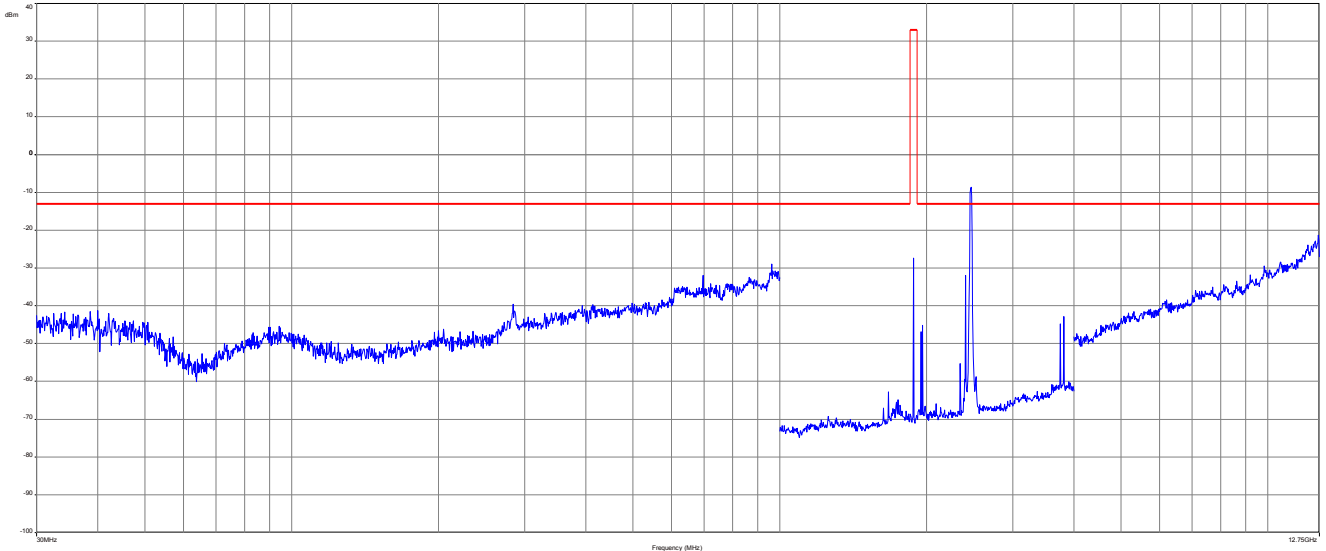

Carrier notched with 1.9 GHz rejection filter

Plot 2: Channel 9262 (12.75 GHz – 18 GHz)

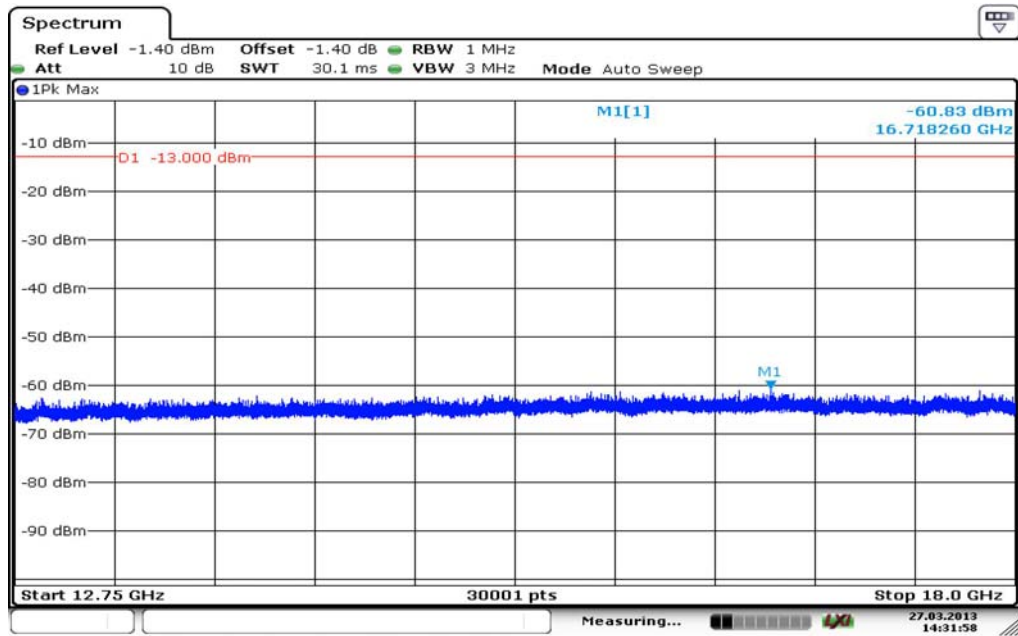

8.4.4 Spurious emissions conducted

Not performed!

8.4.5 Block edge compliance

Not performed!

8.4.6 Occupied bandwidth

Not performed!

8.5 Results UMTS band V

8.5.1 RF output power

Not performed!

8.5.2 Frequency stability

Not performed!

8.5.3 Spurious emissions radiated

Description:

The mobile is transmitting on the UMTS channel 4182. Simultaneous the EUT is transmitting Bluetooth in testmode on CH00 and WiFi on channel 36. Bluetooth is transmitting PBRS data in 8DQPSK and WiFi is transmitting random data with 6 Mbps in OFDM (a-mode).

The measurement is done with respect to ANSI C63.4 / FCC Part 22 and RSS-132.

Measurement:

Measurement parameters	
Detector:	Peak
Sweep time:	2 sec.
Video bandwidth:	Below 1 GHz: 100 kHz Above 1 GHz: 1 MHz
Resolution bandwidth:	Below 1 GHz: 100 kHz Above 1 GHz: 1 MHz
Span:	100 MHz Steps
Trace-Mode:	Max Hold

Limits:

FCC	IC
CFR Part 22.917 CFR Part 2.1053	RSS 132
Spurious Emissions Radiated	
Attenuation $\geq 43 + 10\log(P)$ (P, Power in Watts)	
-13 dBm	

Results:

All measurements were done in horizontal and vertical polarization; the plots show the worst case.

The detected spurious values are stated in the table below.

SPURIOUS EMISSION LEVEL (dBm)		
Frequency	Detector	Level [dBm]
1673 MHz	PP	-52.3 dBm
2510 MHz	PP	-47.3 dBm
2784 MHz	PP	-43.1 dBm
10359 MHz	PP	-33.3 dBm
Measurement uncertainty		± 3dB

Result: Passed

Plots:

Plot 1: Channel 4182 (30 MHz – 12.75 GHz)

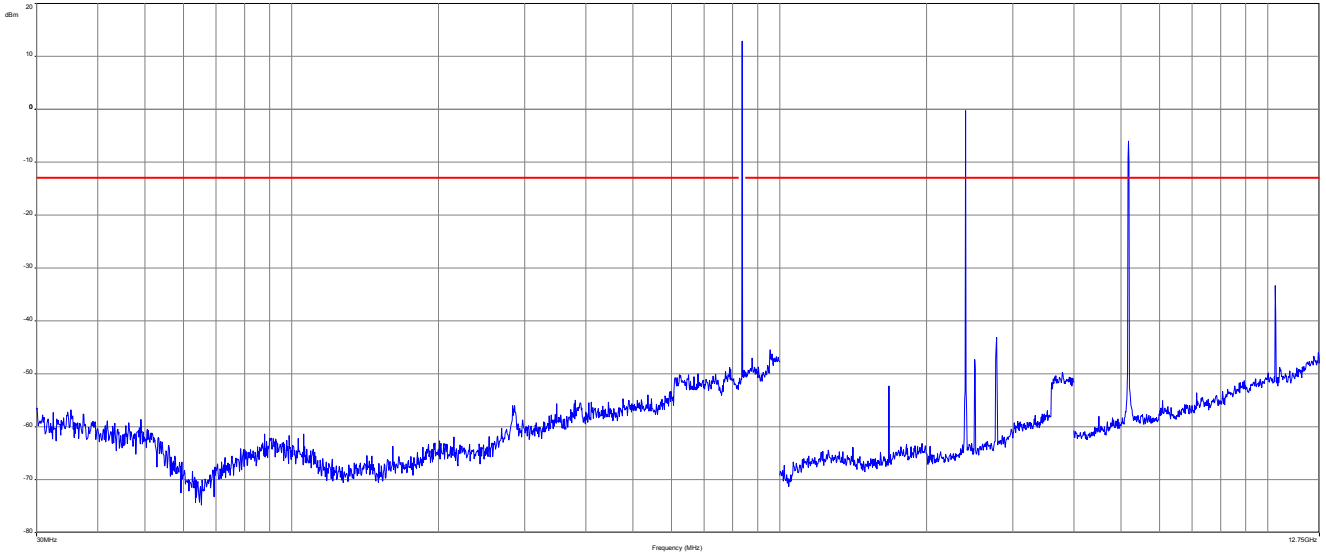

Plot 2: Channel 4182 (12.75 GHz – 18 GHz)

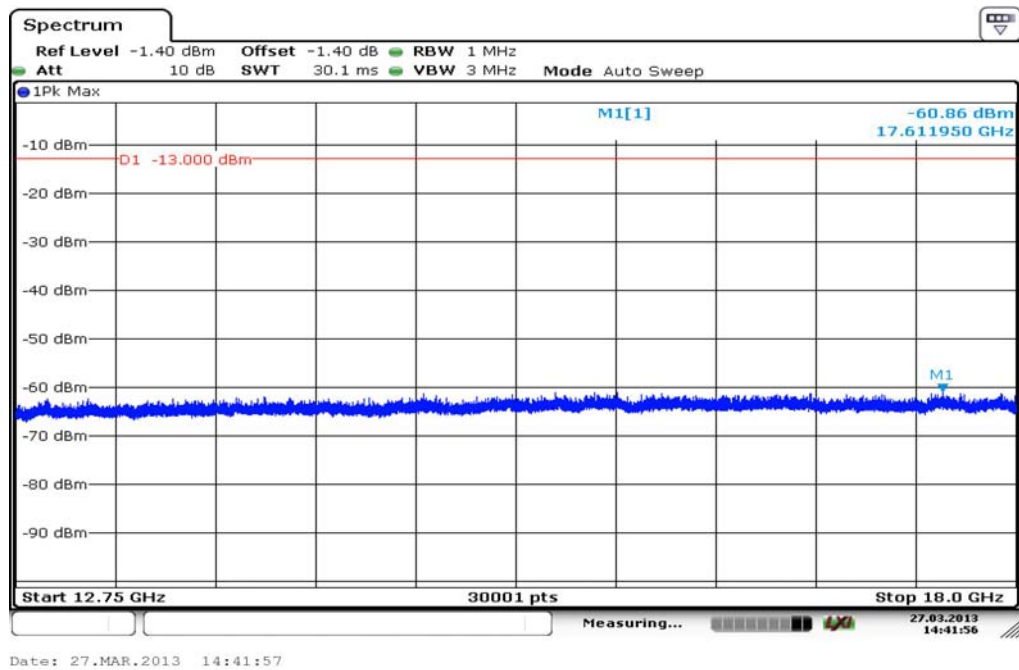

8.5.4 Spurious emissions conducted

Not performed!

8.5.5 Block edge compliance

Not performed!

8.5.6 Occupied bandwidth

Not performed!

8.6 Results LTE – Band 4

8.6.1 RF output power

Not performed!

8.6.2 Frequency stability

Not performed!

8.6.3 Spurious emissions radiated

Description:

The mobile is transmitting on the LTE FDD 4 Band (channel 20175, 20 MHz). The EUT is transmitting simultaneously Bluetooth in GFSK testmode on channel 00 and WiFi on channel 64 while using the CDMA2000 mobile technology standard (channel 384).

The measurement is done with respect to ANSI C63.4 / FCC Part 22 and RSS-132.

Measurement:

Measurement parameters	
Detector:	Peak
Sweep time:	2 sec.
Video bandwidth:	Below 1 GHz: 100 kHz Above 1 GHz: 1 MHz
Resolution bandwidth:	Below 1 GHz: 100 kHz Above 1 GHz: 1 MHz
Span:	100 MHz Steps
Trace-Mode:	Max Hold

Limits:

FCC	IC
CFR Part 27.53(g) CFR Part 2.1053	RSS 139
Spurious Emissions Radiated	
Attenuation $\geq 43 + 10\log(P)$ (P, Power in Watts)	
-13 dBm	

Results:

All measurements were done in horizontal and vertical polarization; the plots show the worst case.

The detected spurious values are stated in the table below.

SPURIOUS EMISSION LEVEL (dBm)		
Frequency	Detector	Level [dBm]
No peak detected!		
Measurement uncertainty		± 3dB

Result: Passed

Plots:

Plot 1: 1 GHz – 9 GHz

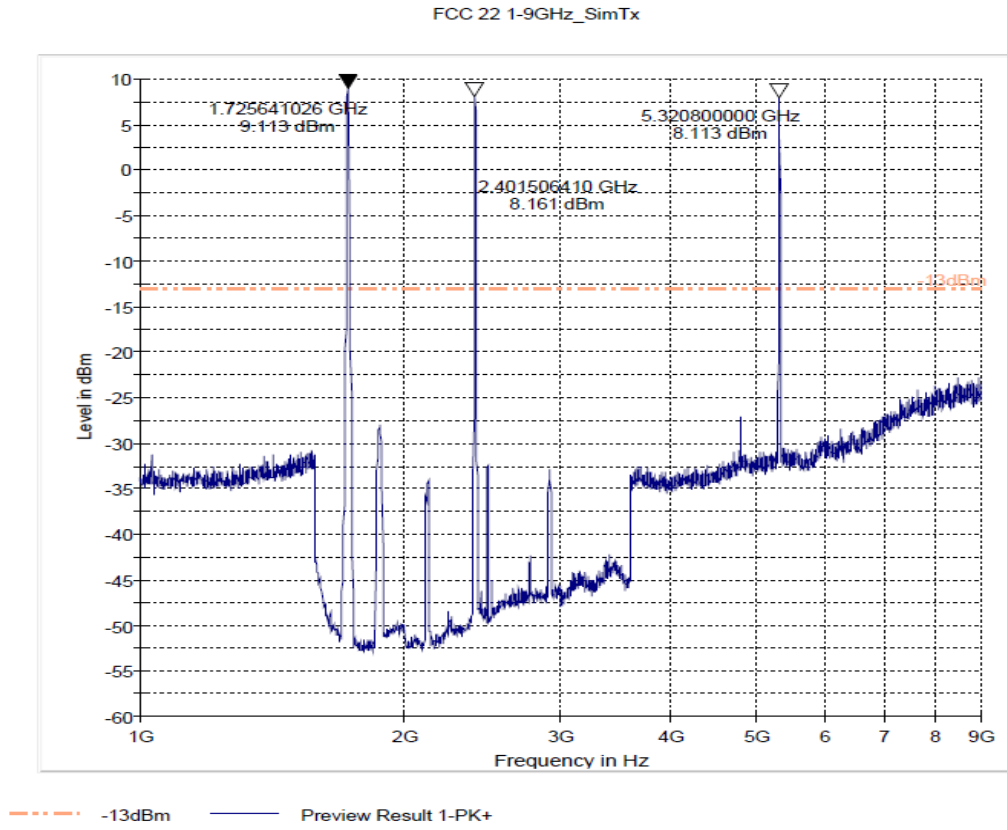

8.6.4 Spurious emissions conducted

Not performed!

8.6.5 Block edge compliance

Not performed!

8.6.6 Occupied bandwidth

Not performed!

8.7 Results LTE – Band 13

8.7.1 RF output power

Not performed!

8.7.2 Frequency stability

Not performed!

8.7.3 Spurious emissions radiated

Description:

The mobile is transmitting on the LTE FDD 13 Band (channel 20230, 10 MHz). The EUT is transmitting simultaneously Bluetooth in GFSK testmode on channel 00 and WiFi on channel 64 while using the CDMA2000 mobile technology standard (channel 600).

The measurement is done with respect to ANSI C63.4 / FCC Part 24 and RSS-133.

Measurement:

Measurement parameters	
Detector:	Peak
Sweep time:	2 sec.
Video bandwidth:	Below 1 GHz: 100 kHz Above 1 GHz: 1 MHz
Resolution bandwidth:	Below 1 GHz: 100 kHz Above 1 GHz: 1 MHz
Span:	100 MHz Steps
Trace-Mode:	Max Hold

Limits:

FCC	IC
CFR Part 27.53(g) CFR Part 2.1053	-/-
Spurious Emissions Radiated	
Attenuation $\geq 43 + 10\log(P)$ (P, Power in Watts)	
-13 dBm	

Results:

All measurements were done in horizontal and vertical polarization; the plots show the worst case.

The detected spurious values are stated in the table below.

SPURIOUS EMISSION LEVEL (dBm)		
Frequency	Detector	Level [dBm]
No peak detected!		
Measurement uncertainty		± 3dB

Result: Passed

Plots:

Plot 1: 1 GHz – 18 GHz

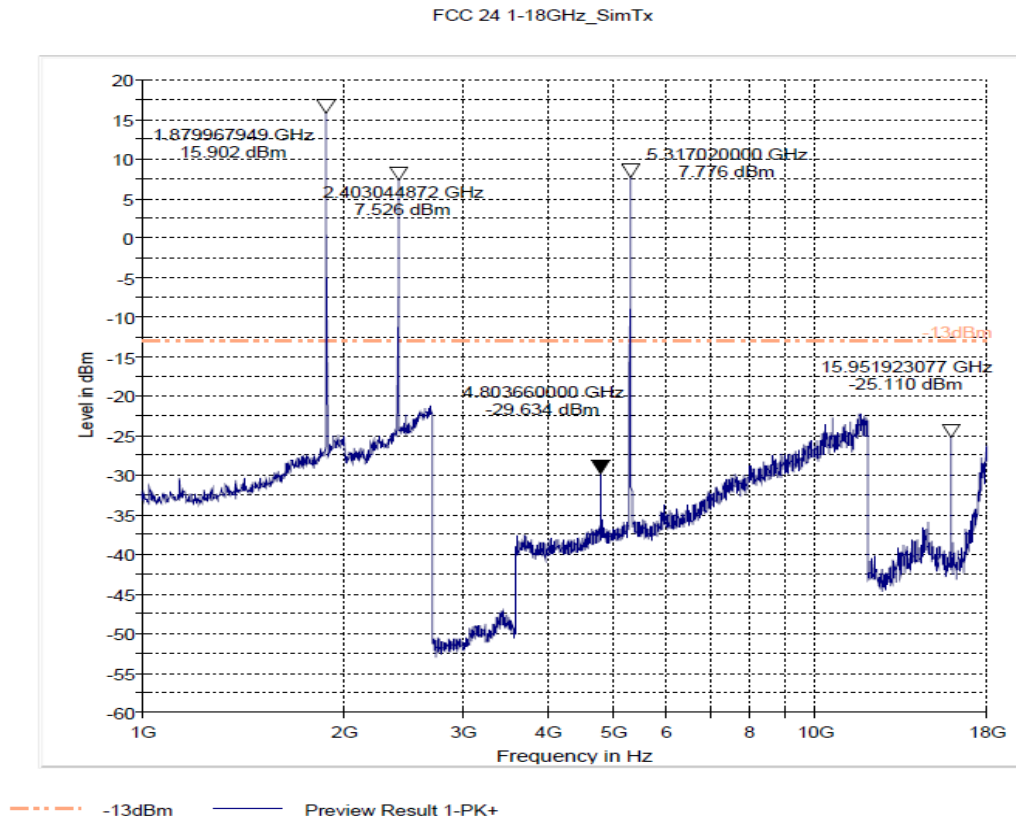

8.7.4 Spurious emissions conducted

Not performed!

8.7.5 Block edge compliance

Not performed!

8.7.6 Occupied bandwidth

Not performed!

9 Test equipment and ancillaries used for tests

Typically, the calibrations of the test apparatus are commissioned to and performed by an accredited calibration laboratory. The calibration intervals are determined in accordance with the DIN EN ISO/IEC 17025. In addition to the external calibrations, the laboratory executes comparison measurements with other calibrated test systems or effective verifications. Weekly chamber inspections and range calibrations are performed. Where possible, rf-generating and signalling equipment as well as measuring receivers and analyzers are connected to an external high-precision 10 MHz reference (GPS-based or rubidium frequency standard).

In order to simplify the identification of the equipment used at some special tests, some items of test equipment and ancillaries can be provided with an identifier or number in the equipment list below (Labor/Item).

No.	Lab / Item	Equipment	Type	Manufact.	Serial No.	INV. No Cetecom	Kind of Calibration	Last Calibration	Next Calibration
1	n. a.	Double-Ridged Waveguide Horn Antenna 1-18.0GHz	3115	EMCO	8812-3088	300001032	vKI!	11.05.2011	11.05.2013
2	n. a.	Active Loop Antenna	6502	EMCO	2210	300001015	ne		
3	n. a.	Anechoic chamber	FAC 3/5m	MWB / TDK	87400/02	300000996	ev		
4	n. a.	Switch / Control Unit	3488A	HP Meßtechnik	*	300000199	ne		
5	n. a.	Switch / Control Unit	3488A	HP Meßtechnik	2719A15013	300001156	ne		
6	n. a.	Three-Way Power Splitter, 50 Ohm	11850C	HP Meßtechnik		300000997	ne		
7	n. a.	Amplifier	js42-00502650-28-5a	Parzich GMBH	928979	300003143	ne		
8	n. a.	Band Reject filter	WRCG185 5/1910-1835/1925-40/8SS	Wainwright	7	300003350	ev		
9	n. a.	TRILOG Broadband Test-Antenna 30 MHz - 3 GHz	VULB9163	Schwarzbeck	371	300003854	vKI!	14.10.2011	14.10.2014
10	n. a.	MXE EMI Receiver 20 Hz bis 26,5 GHz	N9038A	Agilent Technologies	MY51210197	300004405	k	21.02.2013	21.02.2014
11	n. a.	PXA Spectrum Analyzer 3Hz to 50GHz	N9030A PXA Signal Analyzer	Agilent Technologies	US51350267	300004338	k	16.12.2012	16.12.2013

Agenda: Kind of Calibration

k	calibration / calibrated	EK	limited calibration
ne	not required (k, ev, izw, zw not required)	zw	cyclical maintenance (external cyclical maintenance)
ev	periodic self verification	izw	internal cyclical maintenance
Ve	long-term stability recognized	g	blocked for accredited testing
vKI!	Attention: extended calibration interval	*	next calibration ordered / currently in progress
NK!	Attention: not calibrated		

10 Observations

No observations exceeding those reported with the single test cases have been made.

Annex A Document history

Version	Applied changes	Date of release
1.0	Initial release	2013-03-28
-A	Addition of PIN; correction of result tables	2013-04-02
-B	Changed standard version	2013-04-04

Annex B Further information**Glossary**

AVG	-	Average
DUT	-	Device under test
EMC	-	Electromagnetic Compatibility
EN	-	European Standard
EUT	-	Equipment under test
ETSI	-	European Telecommunications Standard Institute
FCC	-	Federal Communication Commission
FCC ID	-	Company Identifier at FCC
HW	-	Hardware
IC	-	Industry Canada
Inv. No.	-	Inventory number
N/A	-	Not applicable
PP	-	Positive peak
QP	-	Quasi peak
S/N	-	Serial number
SW	-	Software

Annex C Accreditation Certificate



Deutsche Akkreditierungsstelle GmbH

Befehlene gemäß § 8 Absatz 1 AkkStelleG i.V.m. § 1 Absatz 1 AkkStelleGBV
 Unterzeichnerin der Multilateralen Abkommen
 von EA, ILAC und IAF zur gegenseitigen Anerkennung

Akkreditierung



Die Deutsche Akkreditierungsstelle GmbH bestätigt hiermit, dass das Prüflaboratorium

CETECOM ICT Services GmbH
 Untertürkheimer Straße 6-10, 66117 Saarbrücken

die Kompetenz nach DIN EN ISO/IEC 17025:2005 besitzt, Prüfungen in folgenden Bereichen durchzuführen:

- Drahtgebundene Kommunikation einschließlich xDSL
- VoIP und DECT
- Akustik
- Funk einschließlich WLAN
- Short Range Devices (SRD)
- RFID
- WiMax und Richtfunk
- Mobilfunk (GSM / DCS, Over the Air (OTA) Performance)
- Elektromagnetische Verträglichkeit (EMV) einschließlich Automotive
- Produktsicherheit
- SAR und Hearing Aid Compatibility (HAC)
- Umweltsimulation
- Smart Card Terminals
- Bluetooth
- Wi-Fi Services

Die Akkreditierungsurkunde gilt nur in Verbindung mit dem Bescheid vom 18.01.2013 mit der Akkreditierungsnummer D-PL-12076-01 und ist gültig 17.01.2018. Sie besteht aus diesem Deckblatt, der Rückseite des Deckblatts und der folgenden Anlage mit insgesamt 80 Seiten.

Registrierungsnummer der Urkunde: D-PL-12076-01-01

Frankfurt am Main, 18.01.2013
 Bitte Hinweisen auf der Rückseite

Im Auftrag
 Dr. Ingrid (FH) Pfeiffer
 Abteilungsleiterin

Deutsche Akkreditierungsstelle GmbH

Standort Berlin
 Spittelmarkt 10
 10117 Berlin

Standort Frankfurt am Main
 Gartenstraße 6
 60594 Frankfurt am Main

Standort Braunschweig
 Rundesallee 100
 38116 Braunschweig

Die auszugsweise Veröffentlichung der Akkreditierungsurkunde bedarf der vorherigen schriftlichen Zustimmung der Deutsche Akkreditierungsstelle GmbH (DAKKS). Ausgenommen davon ist die separate Weiterverarbeitung des Deckblattes durch die umseitig genannte Konformitätsbewertungsstelle in unveränderter Form.

Es darf nicht der Anschein erweckt werden, dass sich die Akkreditierung auch auf Bereiche erstreckt, die über den durch die DAKKS bestätigten Akkreditierungsbereich hinausgehen.

Die Akkreditierung erfolgte gemäß des Gesetzes über die Akkreditierungsstelle (AkkStelleG) vom 31. Juli 2009 (BGBl. I S. 2625) sowie der Verordnung (EG) Nr. 765/2008 des Europäischen Parlaments und des Rates vom 9. Juli 2008 über die Vorschriften für die Akkreditierung und Marktüberwachung im Zusammenhang mit der Vermarktung von Produkten (Abi. L 218 vom 9. Juli 2008, S. 30). Die DAKKS ist Unterzeichnerin der Multilateralen Abkommen zur gegenseitigen Anerkennung der European co-operation for Accreditation (EA), des International Accreditation Forum (IAF) und der International Laboratory Accreditation Cooperation (ILAC). Die Unterzeichner dieser Abkommen erkennen ihre Akkreditierungen gegenseitig an.

Der aktuelle Stand der Mitgliedschaft kann folgenden Webseiten entnommen werden:
 EA: www.european-accreditation.org
 ILAC: www.ilac.org
 IAF: www.iaf.nu

Note:

The current certificate including annex is published on our website (see link below) or may be received from CETECOM ICT Services on request.

<http://www.cetecom.com/eu/de/cetecom-group/europa/deutschland-saarbruecken/akkreditierungen.html>