

TEST REPORT

Test report no.: 1-5579/12-02-04-D



Testing laboratory

CETECOM ICT Services GmbH
Untertuerkheimer Strasse 6 – 10
66117 Saarbruecken / Germany
Phone: + 49 681 5 98 - 0
Fax: + 49 681 5 98 - 9075
Internet: <http://www.cetecom.com>
e-mail: ict@cetecom.com

Accredited Testing Laboratory:

The testing laboratory (area of testing) is accredited according to DIN EN ISO/IEC 17025 (2005) by the Deutsche Akkreditierungsstelle GmbH (DAkkS). The accreditation is valid for the scope of testing procedures as stated in the accreditation certificate with the registration number: D-PL-12076-01-01
Area of Testing: Radio/Satellite Communications

Applicant

Research In Motion Limited
305 Phillip Street
Waterloo, ON N2L 3W8 / CANADA
Phone: +1 51 98 88 74 65
Fax: +1 51 98 88 69 06
Contact: Masud Attayi
e-mail: mattayi@rim.com
Phone: +1 51 98 88 74 65

Manufacturer

Research In Motion Limited
305 Phillip Street
Waterloo, ON N2L 3W8 / CANADA

Test standard/s

47 CFR Part 27 Title 47 of the Code of Federal Regulations; Chapter I
Part 27 - Miscellaneous Wireless Communications Service

For further applied test standards please refer to section 3 of this test report.

Test Item

Kind of test item: Blackberry GSM Phones
Model name: RFM121LW
FCC ID: L6ARFM120LW
IC: 2503A-RFM120LW
Frequency: LTE band XIII: 776 MHz – 787 MHz
Technology tested: LTE
Antenna: Integrated antenna
Power Supply: 3.8V DC by Li-Ion battery
Temperature Range: -20°C to +55°C

This test report is electronically signed and valid without handwriting signature. For verification of the electronic signatures, the public keys can be requested at the testing laboratory.

Test report authorised:



Christoph Schneider
Expert

Test performed:

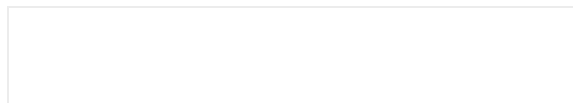

Tobias Wittenmeier
Expert

1 Table of contents

1 Table of contents2

2 General information3

 2.1 Notes and disclaimer3

 2.2 Application details.....3

3 Test standard/s3

4 Test environment.....4

5 Test item4

 5.1 Additional information5

6 Test laboratories sub-contracted5

7 Summary of measurement results6

 7.1 LTE – Band 13.....6

 7.2 Receiver.....6

8 RF measurements7

 8.1 Description of test setup7

 8.1.1 Radiated measurements.....7

 8.1.2 Conducted measurements.....8

 8.2 LTE technologies supported by EUT9

 8.3 Results LTE – Band 13.....10

 8.3.1 RF output power10

 8.3.2 Frequency stability14

 8.3.3 Spurious emissions radiated15

 8.3.4 Spurious emissions conducted24

 8.3.5 Block edge compliance.....29

 8.3.6 Occupied bandwidth34

9 Test equipment and ancillaries used for tests44

10 Observations45

Annex A Document history46

Annex B Further information.....46

Annex C Accreditation Certificate47

2 General information

2.1 Notes and disclaimer

The test results of this test report relate exclusively to the test item specified in this test report. CETECOM ICT Services GmbH does not assume responsibility for any conclusions and generalizations drawn from the test results with regard to other specimens or samples of the type of the equipment represented by the test item.

The test report may only be reproduced or published in full. Reproduction or publication of extracts from the report requires the prior written approval of CETECOM ICT Services GmbH.

The testing service provided by CETECOM ICT Services GmbH has been rendered under the current "General Terms and Conditions for CETECOM ICT Services GmbH".

CETECOM ICT Services GmbH will not be liable for any loss or damage resulting from false, inaccurate, inappropriate or incomplete product information provided by the customer.

Under no circumstances does the CETECOM ICT Services GmbH test report include any endorsement or warranty regarding the functionality, quality or performance of any other product or service provided.

Under no circumstances does the CETECOM ICT Services GmbH test report include or imply any product or service warranties from CETECOM ICT Services GmbH, including, without limitation, any implied warranties of merchantability, fitness for purpose, or non-infringement, all of which are expressly disclaimed by CETECOM ICT Services GmbH.

All rights and remedies regarding vendor's products and services for which CETECOM ICT Services GmbH has prepared this test report shall be provided by the party offering such products or services and not by CETECOM ICT Services GmbH.

In no case this test report can be considered as a Letter of Approval.

This test report is electronically signed and valid without handwritten signature. For verification of the electronic signatures, the public keys can be requested at the testing laboratory.

2.2 Application details

Date of receipt of order:	2013-01-04
Date of receipt of test item:	2013-01-14
Start of test:	2013-01-14
End of test:	2013-03-28
Person(s) present during the test:	-/-

3 Test standard/s

Test standard	Date	Test standard description
47 CFR Part 27	2012-10	Title 47 of the Code of Federal Regulations; Chapter I Part 27 - Miscellaneous Wireless Communications Service

4 Test environment

Temperature:	T_{nom}	+22 °C during room temperature tests
	T_{max}	+55 °C during high temperature tests
	T_{min}	-20 °C during low temperature tests
Relative humidity content:		52 %
Barometric pressure:		not relevant for this kind of testing
Power supply:	V_{nom}	3.8 V DC by Li-Ion battery
	V_{max}	-/- V
	V_{min}	-/- V

5 Test item

Kind of test item	:	Blackberry GSM Phones
Type identification	:	RFM121LW
S/N serial number	:	Radiated unit: IMEI 990002430036416; PIN 303E5B59 Conducted unit: IMEI 990002430036333; PIN 303E5851
HW hardware status	:	CER-53013-001Rev2-905-00
SW software status	:	127.0.1.4429
Frequency band [MHz]	:	LTE band XIII: 776 MHz – 787 MHz
Type of modulation	:	QPSK, 16 – QAM
Antenna	:	Integrated antenna
Power supply	:	3.8 V DC by Li-Ion battery
Temperature range	:	-20°C to +55 °C

5.1 Additional information

Test setup- and EUT-photos are included in test reports: 1-5579/12-02-01_AnnexA
1-5579/12-02-01_AnnexC

Emission Designator table according customers demand:

Frequency Range (MHz)	Output Power (Watts)	Emission Designator	TC Notes
782	0.175	4M50G7D	LTE B13 5M QPSK
782	0.156	4M54W7D	LTE B13 5M 16QAM
782	0.163	8M97G7D	LTE B13 10M QPSK
782	0.130	9M00W7D	LTE B13 10M 16QAM

6 Test laboratories sub-contracted

None

7 Summary of measurement results

- No deviations from the technical specifications were ascertained
- There were deviations from the technical specifications ascertained

TC identifier	Description	verdict	date	Remark
RF-Testing	CFR Part 27 RSS 139	passed	2013-04-10	-/-

7.1 LTE – Band 13

Test Case	temperature conditions	power source voltages	Pass	Fail	NA	NP	Remark
RF Output Power	Nominal	Nominal	<input checked="" type="checkbox"/>	<input type="checkbox"/>	<input type="checkbox"/>	<input type="checkbox"/>	
Frequency Stability	Nominal	Nominal	<input type="checkbox"/>	<input type="checkbox"/>	<input type="checkbox"/>	<input checked="" type="checkbox"/>	
Spurious Emissions Radiated	Nominal	Nominal	<input checked="" type="checkbox"/>	<input type="checkbox"/>	<input type="checkbox"/>	<input type="checkbox"/>	
Spurious Emissions Conducted	Nominal	Nominal	<input checked="" type="checkbox"/>	<input type="checkbox"/>	<input type="checkbox"/>	<input type="checkbox"/>	
Block Edge Compliance	Nominal	Nominal	<input checked="" type="checkbox"/>	<input type="checkbox"/>	<input type="checkbox"/>	<input type="checkbox"/>	
Occupied Bandwidth	Nominal	Nominal	<input checked="" type="checkbox"/>	<input type="checkbox"/>	<input type="checkbox"/>	<input type="checkbox"/>	

Note:
NA = Not applicable; NP = Not performed

7.2 Receiver

Test Case	temperature conditions	power source voltages	Pass	Fail	NA	NP	Remark
Spurious Emissions Radiated	Nominal	Nominal	<input type="checkbox"/>	<input type="checkbox"/>	<input type="checkbox"/>	<input checked="" type="checkbox"/>	

Note:
NA = Not applicable; NP = Not performed

8 RF measurements

8.1 Description of test setup

For the spurious measurements we use the substitution method according TIA/EIA 603.

8.1.1 Radiated measurements

The radiated emissions from the EUT are performed in a semi anechoic chamber. The EUT is placed on a conductive turntable and powered with nominal voltage. The signalling is performed either from outside the chamber with a signalling unit (AP or other) by air link using a signalling antenna or directly by special test software from the customer.

Semi anechoic chamber

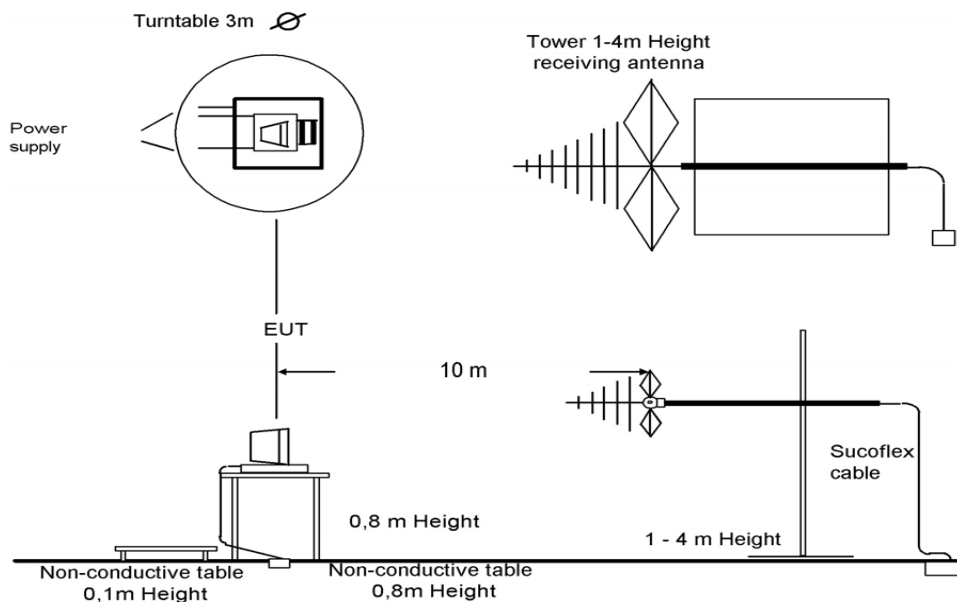

Picture 1: Diagram radiated measurements

9 kHz - 30 MHz:	active loop antenna
30 MHz – 1 GHz:	tri-log antenna
> 1 GHz:	horn antenna

8.1.2 Conducted measurements

The EUT's RF signal is coupled out by the antenna connector which is supplied by the manufacturer. The signal is first 10dB attenuated before it is power divided (~6dB loss per branch). One of the signal paths is connected to the signalling unit (AP or other), the other one is connected to the spectrum analyzer. The specific losses for both signal paths are first checked within a calibration. The measurement readings on the signalling unit/spectrum analyzer are corrected by the specific test set-up loss. The attenuator, power divider, signalling unit and the spectrum analyzer are impedance matched on 50 Ohm. If special software is used, there is no power divider necessary.

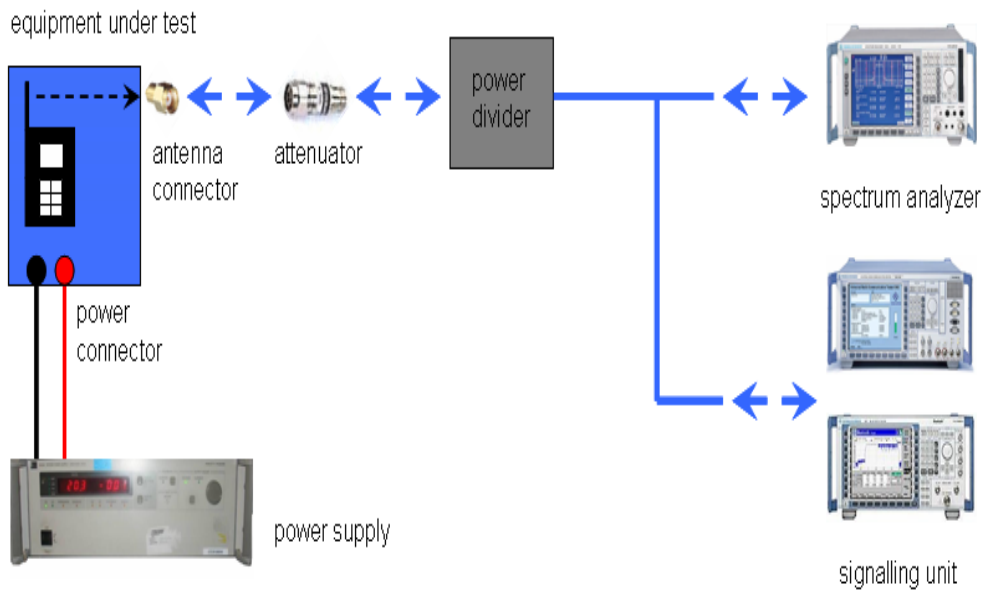

Picture 2: Diagram conducted measurements

The term measuring receiver refers to either a selective voltmeter or a spectrum analyser.

Frequency being measured f	Measuring receiver bandwidth 6 dB	Spectrum analyser bandwidth 3dB
$f < 150 \text{ kHz}$	200 Hz or	300 Hz
$150 \text{ kHz} \leq f < 25 \text{ MHz}$	9 kHz or	10 kHz
$25 \text{ MHz} \leq f < 1000 \text{ MHz}$	120 kHz or	100 kHz
$1000 \text{ MHz} \leq f$		1 MHz
NOTE: Specific requirements in CEPT/ERC/Recommendation 70-03 [2] shall be applied where applicable.		

8.2 LTE technologies supported by EUT

Channel bandwidth

	Band 4	Band 13
[MHz]		
1.4	<input type="checkbox"/>	<input type="checkbox"/>
3	<input type="checkbox"/>	<input type="checkbox"/>
5	<input type="checkbox"/>	<input checked="" type="checkbox"/>
10	<input type="checkbox"/>	<input checked="" type="checkbox"/>
15	<input type="checkbox"/>	<input type="checkbox"/>
20	<input type="checkbox"/>	<input type="checkbox"/>

Antenna

SISO	<input checked="" type="checkbox"/>
SIMO	<input type="checkbox"/>
MISO	<input type="checkbox"/>
MIMO	<input type="checkbox"/>

8.3 Results LTE – Band 13

The EUT was set to transmit the maximum power.

8.3.1 RF output power

Description:

This paragraph contains average power, peak output power and EIRP measurements for the mobile station. In all cases, the peak output power is within the required mask (this mask is specified in the JTC standards, TIA PN3389 Vol. 1 Chap 7, and is no FCC requirement).

Measurement:

The mobile was set up for the maximum output power with pseudo random data modulation.

To determine the Peak-To-Average Power Ratio (PAPR) the measurement was performed with the Power Complementary Cumulative Distribution Function (CCDF).

Measurement parameters	
Detector:	Peak and RMS (Power in Burst)
Sweep time:	Auto
Video bandwidth:	Depends on Channel Bandwidth
Resolution bandwidth:	Depends on Channel Bandwidth
Span:	Zero Span
Trace-Mode:	Max Hold

Limits:

FCC	IC
CFR Part 27.1101 CFR Part 2.1046	-/-
Nominal Peak Output Power	
+30.00 dBm	
In measuring transmissions in this band using an average power technique, the peak-to-average ratio (PAR) of the transmission may not exceed 13 dB.	

Results:

Output Power (conducted)							
Bandwidth (MHz)	Frequency (MHz)	Resource block allocation	Average Output Power (dBm) QPSK	Peak to Average Ratio (dB)	Average Output Power (dBm) 16-QAM	Peak to Average Ratio (dB)	
1.4	-/-	1 RB low	Np	Np	Np	Np	
		1 RB high	Np	Np	Np	Np	
		50% RB mid	Np	Np	Np	Np	
		100% RB	Np	Np	Np	Np	
	-/-	6 RB low	Np	Np	Np	Np	Np
		3 RB low	NP	NP	Np	Np	Np
		50% RB mid	Np	Np	Np	Np	Np
		100% RB	Np	Np	Np	Np	Np
	-/-	1 RB low	Np	Np	Np	Np	Np
		1 RB high	Np	Np	Np	Np	Np
		50% RB mid	Np	Np	Np	Np	Np
		100% RB	Np	Np	Np	Np	Np
3	-/-	1 RB low	Np	Np	Np	Np	
		1 RB high	Np	Np	Np	Np	
		50% RB mid	Np	Np	Np	Np	
		100% RB	Np	Np	Np	Np	
	-/-	1 RB low	Np	Np	Np	Np	Np
		1 RB high	Np	Np	Np	Np	Np
		50% RB mid	Np	Np	Np	Np	Np
		100% RB	Np	Np	Np	Np	
	-/-	1 RB low	Np	Np	Np	Np	Np
		1 RB high	Np	Np	Np	Np	Np
		50% RB mid	Np	Np	Np	Np	Np
		100% RB	Np	Np	Np	Np	
5	779	1 RB low	23.37	4.17	22.11	5.19	
		1 RB high	23.55	4.01	22.26	5.06	
		50% RB mid	22.48	5.20	21.91	5.87	
		100% RB	22.27	5.79	12.25	6.89	
	782	1 RB low	23.34	4.16	22.73	4.63	
		1 RB high	23.58	4.30	22.89	4.81	
		50% RB mid	22.44	5.33	21.92	5.79	
		100% RB	22.35	5.85	21.32	6.22	
	785	1 RB low	23.32	4.37	22.07	5.36	
		1 RB high	25.91	2.03	24.99	2.94	
		50% RB mid	22.04	5.63	21.39	6.02	
		100% RB	22.14	5.94	21.11	7.02	

10	-/-	1 RB low	Np	Np	Np	Np
		1 RB high	Np	Np	Np	Np
		50% RB mid	Np	Np	Np	Np
		100% RB	Np	Np	Np	Np
	782	1 RB low	23.55	4.06	22.25	5.11
		1 RB high	23.65	4.33	22.36	5.33
		50% RB low	22.13	5.60	21.68	6.13
		100% RB	22.13	6.22	21.14	7.11
	-/-	1 RB low	Np	Np	Np	Np
		1 RB high	Np	Np	Np	Np
		50% RB mid	Np	Np	Np	Np
		100% RB	Np	Np	Np	Np
15	-/-	1 RB low	Np	Np	Np	Np
		1 RB high	Np	Np	Np	Np
		50% RB mid	Np	Np	Np	Np
		100% RB	Np	Np	Np	Np
	-/-	1 RB low	Np	Np	Np	Np
		1 RB high	Np	Np	Np	Np
		50% RB mid	Np	Np	Np	Np
		100% RB	Np	Np	Np	Np
	-/-	1 RB low	Np	Np	Np	Np
		1 RB high	Np	Np	Np	Np
		50% RB mid	Np	Np	Np	Np
		100% RB	Np	Np	Np	Np
20	-/-	1 RB low	Np	Np	Np	Np
		1 RB high	Np	Np	Np	Np
		50% RB mid	Np	Np	Np	Np
		100% RB	Np	Np	Np	Np
	-/-	1 RB low	Np	Np	Np	Np
		1 RB high	Np	Np	Np	Np
		50% RB low	Np	Np	Np	Np
		100% RB	Np	Np	Np	np
	-/-	1 RB low	Np	Np	Np	Np
		1 RB high	Np	Np	Np	Np
		50% RB mid	Np	Np	Np	Np
		100% RB	Np	Np	Np	Np
Measurement uncertainty			± 0.5 dB			

Np: Not performed according manufacturer test plan

Output Power (radiated)			
Bandwidth (MHz)	Frequency (MHz)	Average Output Power (dBm)	
		QPSK	16-QAM
1.4 (6 RB)	-/-	Np	Np
	-/-	Np	Np
	-/-	Np	Np
3 (15 RB)	-/-	Np	Np
	-/-	Np	Np
	-/-	Np	Np
5 (25 RB)	779	26.15	25.22
	782	26.83	25.71
	785	26.71	25.65
10 (50 RB)	-/-	Np	Np
	782	25.98	25.46
	-/-	Np	Np
10 (1 RB)	-/-	Np	Np
	782	26.11	25.23
	-/-	Np	Np
15 (75 RB)	-/-	Np	Np
	-/-	Np	Np
	-/-	Np	Np
20 (100 RB)	-/-	Np	Np
	-/-	Np	Np
	-/-	Np	Np
20 (1 RB)	-/-	Np	Np
	-/-	Np	Np
	-/-	Np	Np
Measurement uncertainty		± 3.0 dB	

Np: Not performed according manufacturer test plan

Result: Passed

8.3.2 Frequency stability

Not performed

8.3.3 Spurious emissions radiated

Description:

The following steps outline the procedure used to measure the radiated emissions from the mobile station. The site is constructed in accordance with ANSI C63.4:2009 requirements and is recognized by the FCC to be in compliance for a 3 and a 10 meter site. The spectrum was scanned from 30 MHz to the 10th harmonic of the highest frequency generated within the equipment, which is the transmitted carrier that can be as high as 1755 MHz. This was rounded up to 20 GHz. The resolution bandwidth is set as outlined in Part 27.53. The spectrum was scanned with the mobile station transmitting at carrier frequencies that pertain to low, mid and high channels of the LTE band 4.

The final open field emission (here 10m semi-anechoic chamber listed by FCC) test procedure is as follows:

- The test item was placed on a 0.8 meter high non-conductive stand at a 3 meter test distance from the receive antenna.
- The antenna output was terminated in a 50 ohm load (if possible).
- A double ridged wave guide antenna was placed on an adjustable height antenna mast 3 meters from the test item for emission measurements.
- Detected emissions were maximized at each frequency by rotating the test item and adjusting the receive antenna height and polarization. The maximum meter reading was recorded. The radiated emission measurements of the harmonics of the transmit frequency through the 10th harmonic were measured with peak detector and 1 MHz bandwidth. If the harmonic could not be detected above the noise floor, the ambient level was recorded. The equivalent power into a dipole antenna was calculated from the field intensity levels measured at 3 meters.
- Now each detected emissions were substituted by the substitution method, in accordance with the TIA/EIA 603 .

Measurement:

Measurement parameters	
Detector:	Peak
Sweep time:	2 sec.
Video bandwidth:	Below 1 GHz: 100 kHz Above 1 GHz: 1 MHz
Resolution bandwidth:	Below 1 GHz: 100 kHz Above 1 GHz: 1 MHz
Span:	100 MHz Steps
Trace-Mode:	Max Hold

Limits:

FCC	IC
CFR Part 27.53(g) CFR Part 2.1053	-/-
Spurious Emissions Radiated	
Attenuation $\geq 43 + 10\log(P)$ (P, Power in Watts)	
-13 dBm	

Results:

Radiated emissions measurements were made only at the upper, center, and lower carrier frequencies of the LTE band 13 (779 MHz, 782 MHz and 785 MHz). It was decided that measurements at these three carrier frequencies would be sufficient to demonstrate compliance with emissions limits because it was seen that all the significant spurs occur well outside the band and no radiation was seen from a carrier in one block of the LTE band 13 into any of the other blocks. The equipment must still, however, meet emissions requirements with the carrier at all frequencies over which it is capable of operating and it is the manufacturer's responsibility to verify this.

The final open field radiated levels are presented on the next pages.

All measurements were done in horizontal and vertical polarization; the plots show the worst case.

The plots show only the middle channel at the channel bandwidth and resource blocks with the highest output power. If spurious were detected, the lowest and highest channel and all supported channel bandwidths were checked, too.

As can be seen from this data, the emissions from the test item were within the specification limit.

QPSK

SPURIOUS EMISSION LEVEL (dBm)								
Harmonic	Lowest channel Freq. (MHz)	Level [dBm]	Harmonic	Middle channel Freq. (MHz)	Level [dBm]	Harmonic	Highest channel Freq. (MHz)	Level [dBm]
2	1558.0	-	2	1564.0	-	2	1570.0	-
3	2337.0	-	3	2346.0	-	3	2355.0	-
4	3116.0	-	4	3128.0	-	4	3140.0	-
5	3895.0	-	5	3910.0	-	5	3925.0	-
6	4674.0	-	6	4692.0	-	6	4710.0	-
7	5453.0	-	7	5474.0	-	7	5495.0	-
8	6232.0	-	8	6256.0	-	8	6280.0	-
9	7011.0	-	9	7038.0	-	9	7065.0	-
10	7790.0	-	10	7820.0	-	10	7850.0	-
Measurement uncertainty					± 3dB			

16-QAM

SPURIOUS EMISSION LEVEL (dBm)								
Harmonic	Lowest channel Freq. (MHz)	Level [dBm]	Harmonic	Middle channel Freq. (MHz)	Level [dBm]	Harmonic	Highest channel Freq. (MHz)	Level [dBm]
2	1558.0	-	2	1564.0	-	2	1570.0	-
3	2337.0	-	3	2346.0	-	3	2355.0	-
4	3116.0	-	4	3128.0	-	4	3140.0	-
5	3895.0	-	5	3910.0	-	5	3925.0	-
6	4674.0	-	6	4692.0	-	6	4710.0	-
7	5453.0	-	7	5474.0	-	7	5495.0	-
8	6232.0	-	8	6256.0	-	8	6280.0	-
9	7011.0	-	9	7038.0	-	9	7065.0	-
10	7790.0	-	10	7820.0	-	10	7850.0	-
Measurement uncertainty					± 3dB			

Result: Passed

QPSK with 5 MHz channel bandwidth

Plot 1: Channel 23205; RB=25 (30 MHz – 12.75 GHz)

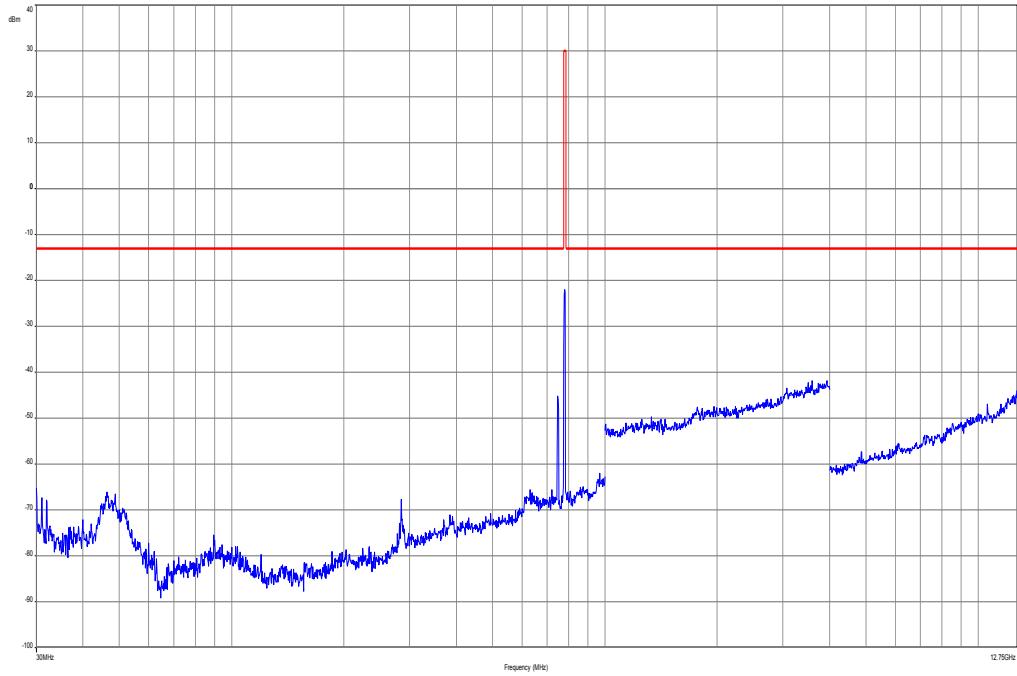

Plot 2: Channel 23230; RB=25 (30 MHz – 12.75 GHz)

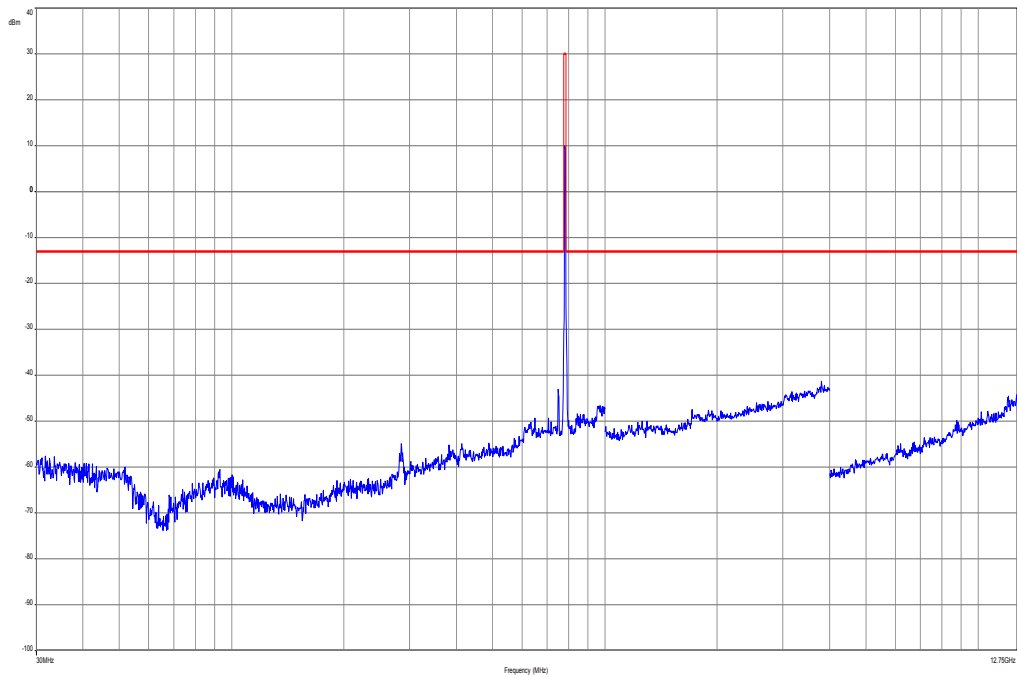

Plot 3: Channel 20354; RB=25 (30 MHz – 12.75 GHz)

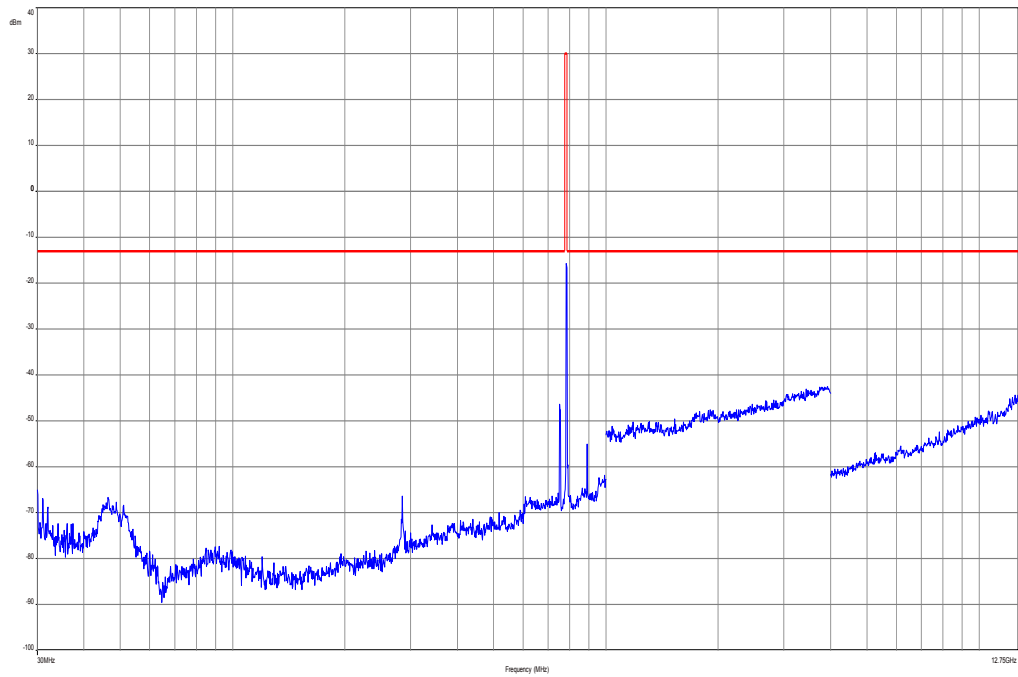

16-QAM with 5 MHz channel bandwidth

Plot 1: Channel 23210; RB=25 (30 MHz – 12.75 GHz)

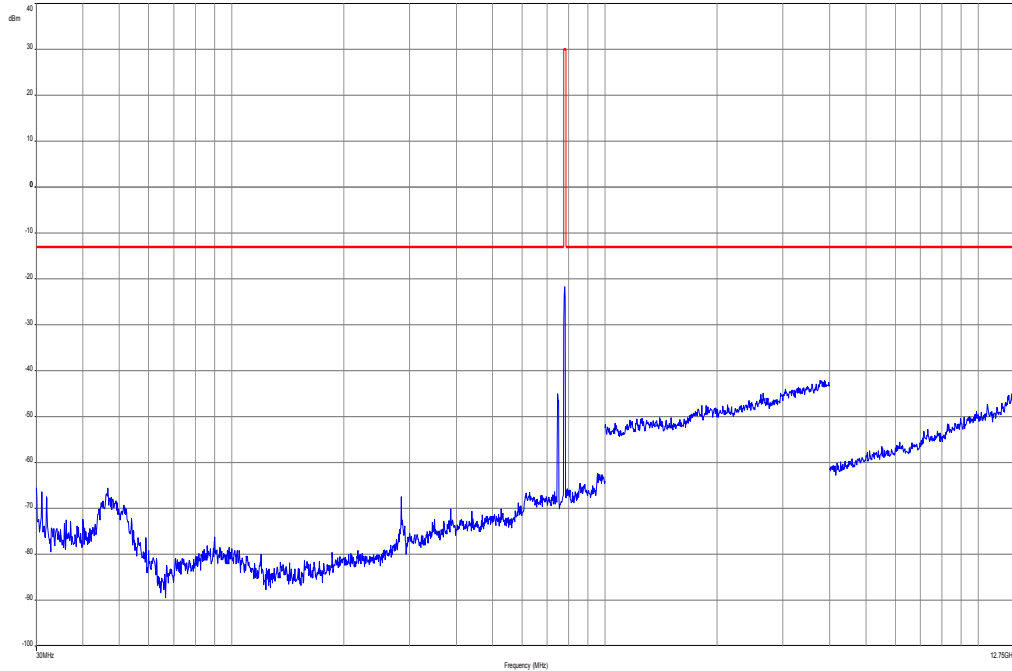

Plot 2: Channel 23230; RB=25 (30 MHz – 12.75 GHz)

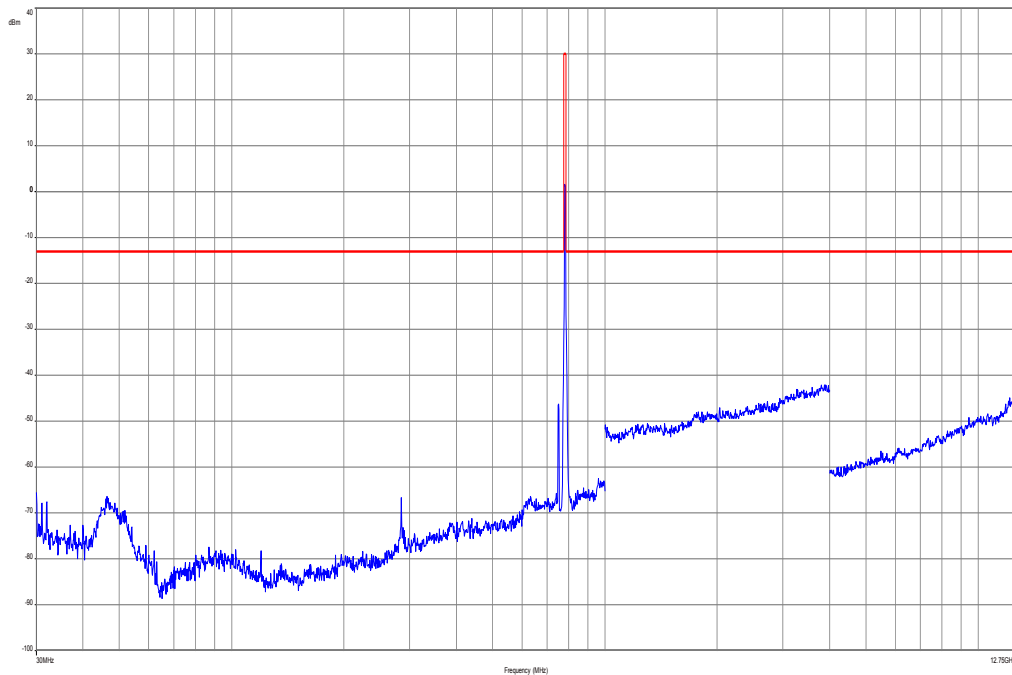

Plot 3: Channel 20350; RB=25 (30 MHz – 12.75 GHz)

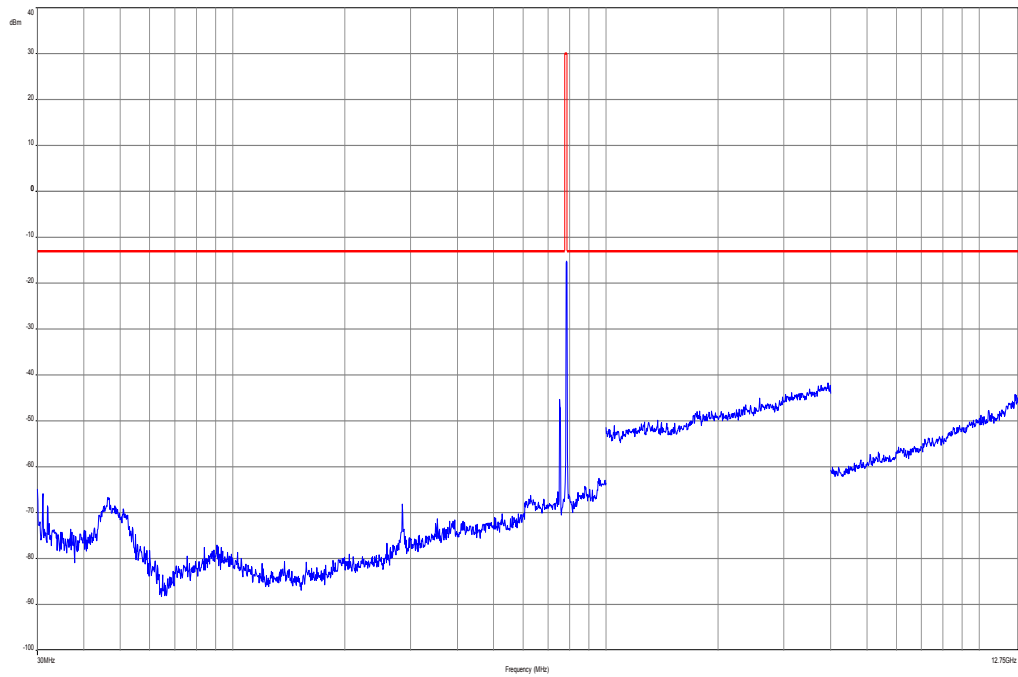

QPSK with 10 MHz channel bandwidth

Plot 1: Channel 23230; RB=50 (30 MHz – 12.75 GHz)

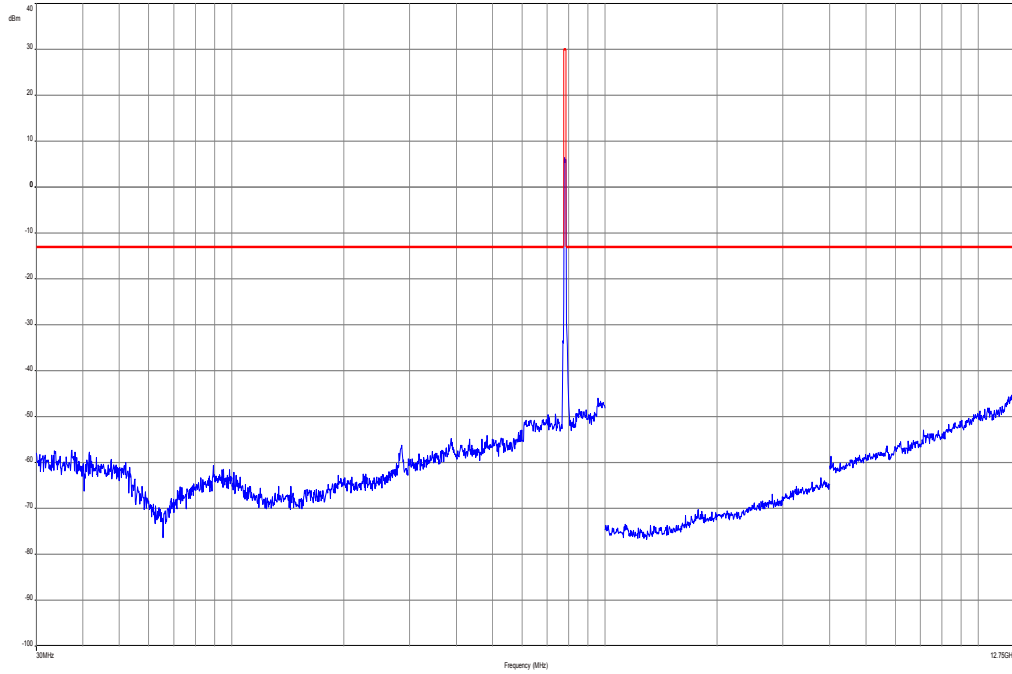

Plot 2: Channel 23230; RB=1 (30 MHz – 12.75 GHz)

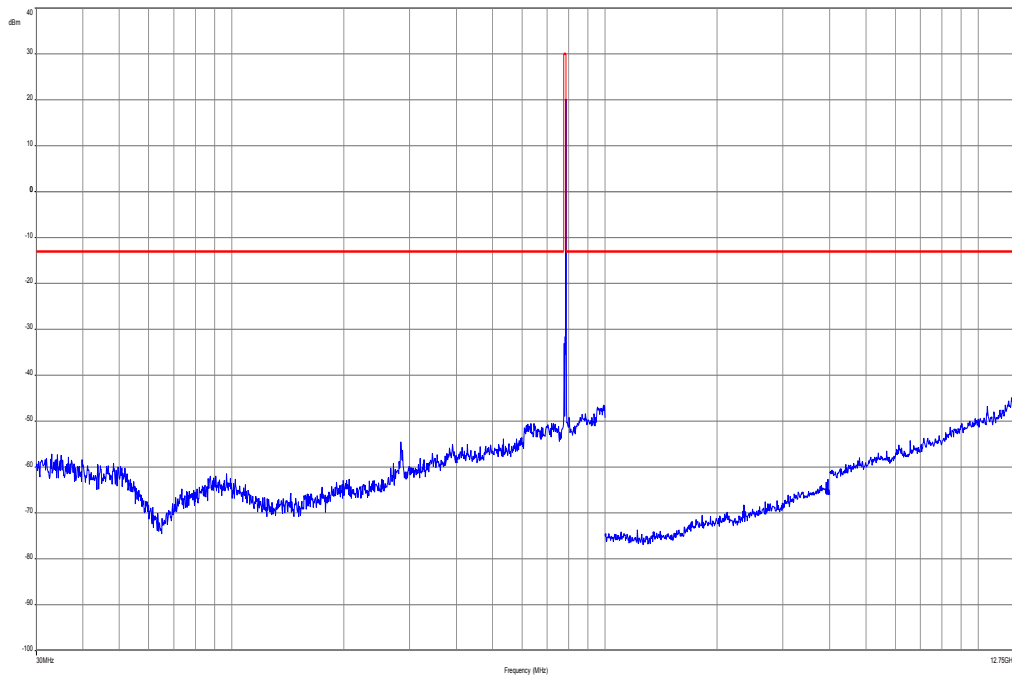

16-QAM with 10 MHz channel bandwidth

Plot 1: Channel 23230; RB=50 (30 MHz – 12.75 GHz)

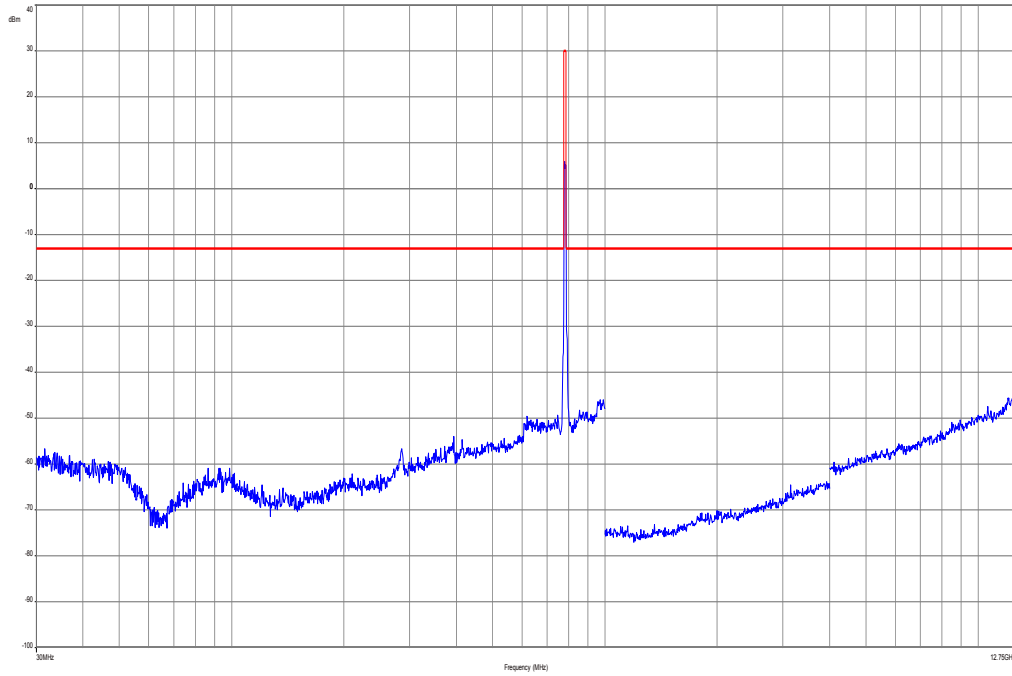

Plot 2: Channel 23230; RB=1 (30 MHz – 12.75 GHz)

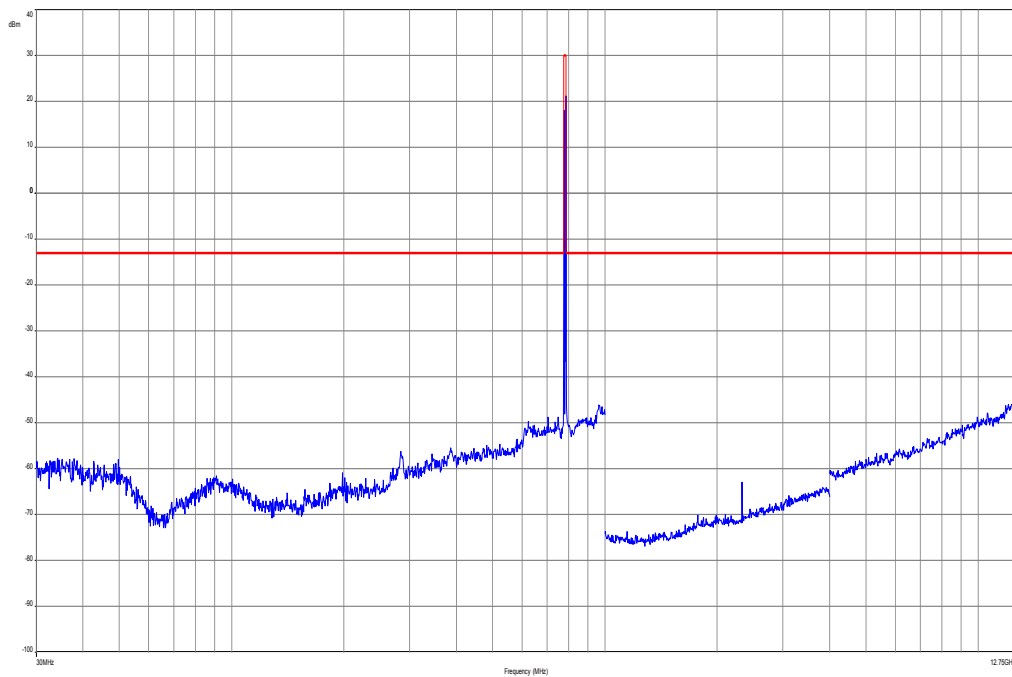

8.3.4 Spurious emissions conducted

Description:

The following steps outline the procedure used to measure the conducted emissions from the mobile station.

1. Determine frequency range for measurements: From CFR 2.1057 the spectrum should be investigated from the lowest radio frequency generated in the equipment up to at least the 10th harmonic of the carrier frequency. For the mobile station equipment tested, this equates to a frequency range of 13 MHz to 17.6 GHz, data taken from 10 MHz to 25 GHz.
2. Determine mobile station transmits frequencies: below outlines the band edge frequencies pertinent to conducted emissions testing.

For the measurement the lowest, middle and highest channel bandwidth was used. If spurious were found the other bandwidths were measured, too.

Measurement:

Measurement parameters	
Detector:	Peak
Sweep time:	Auto
Video bandwidth:	Pre-measurement with 1 MHz On spurious detection re-measurement below 1 GHz with 100 kHz Above 1 GHz with 1 MHz
Resolution bandwidth:	Pre-measurement with 1 MHz On spurious detection re-measurement below 1 GHz with 100 kHz Above 1 GHz with 1 MHz
Span:	10 MHz – 25 GHz
Trace-Mode:	Max Hold

Limits:

FCC	IC
CFR Part 27.53(g) CFR Part 2.1053	-/-
Spurious Emissions Conducted	
Attenuation $\geq 43 + 10\log(P)$ (P, Power in Watts)	
-13 dBm	

Results: for 5 MHz channel bandwidth

QPSK

SPURIOUS EMISSION LEVEL (dBm)								
Harmonic	Lowest channel Freq. (MHz)	Level [dBm]	Harmonic	Middle channel Freq. (MHz)	Level [dBm]	Harmonic	Highest channel Freq. (MHz)	Level [dBm]
2	1558.0	-	2	1564.0	-	2	1570.0	-
3	2337.0	-	3	2346.0	-	3	2355.0	-
4	3116.0	-	4	3128.0	-	4	3140.0	-
5	3895.0	-	5	3910.0	-	5	3925.0	-
6	4674.0	-	6	4692.0	-	6	4710.0	-
7	5453.0	-	7	5474.0	-	7	5495.0	-
8	6232.0	-	8	6256.0	-	8	6280.0	-
9	7011.0	-	9	7038.0	-	9	7065.0	-
10	7790.0	-	10	7820.0	-	10	7850.0	-
Measurement uncertainty					± 3dB			

Results: for 10 MHz channel bandwidth

QPSK

SPURIOUS EMISSION LEVEL (dBm)								
Harmonic	Lowest channel Freq. (MHz)	Level [dBm]	Harmonic	Middle channel Freq. (MHz)	Level [dBm]	Harmonic	Highest channel Freq. (MHz)	Level [dBm]
2	-/-	-	2	1564.0	-	2	-/-	-
3	-/-	-	3	2346.0	-	3	-/-	-
4	-/-	-	4	3128.0	-	4	-/-	-
5	-/-	-	5	3910.0	-	5	-/-	-
6	-/-	-	6	4692.0	-	6	-/-	-
7	-/-	-	7	5474.0	-	7	-/-	-
8	-/-	-	8	6256.0	-	8	-/-	-
9	-/-	-	9	7038.0	-	9	-/-	-
10	-/-	-	10	7820.0	-	10	-/-	-
Measurement uncertainty					± 3dB			

Result: Passed

Results: for 5 MHz channel bandwidth

Plots: QPSK; RB=25

Plot 1: Lowest Channel (30 MHz - 25 GHz)

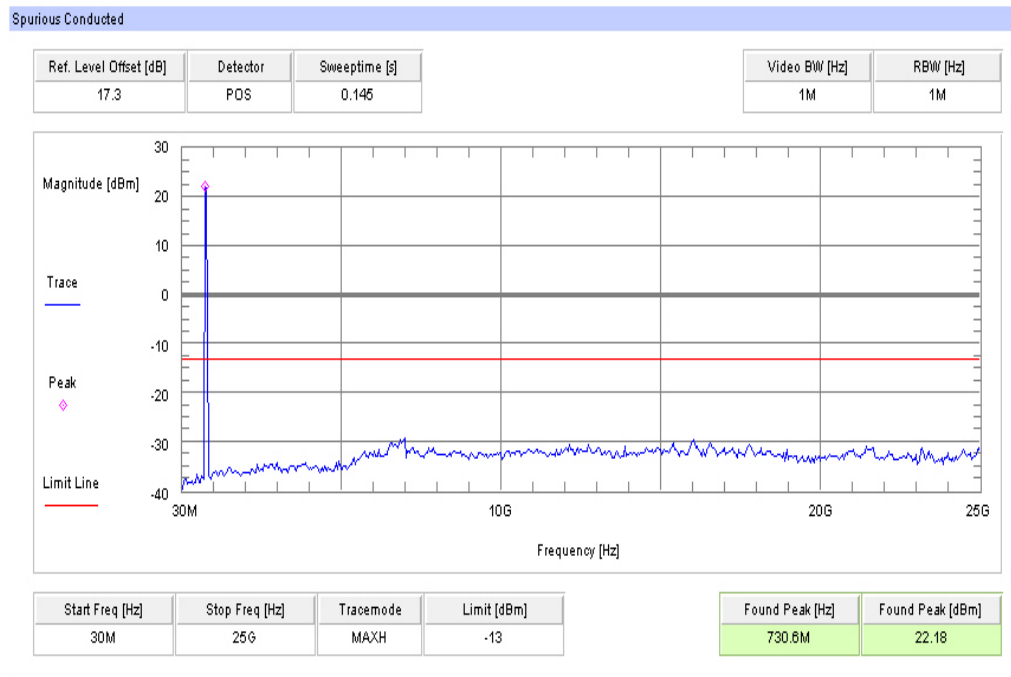

Plot 2: Middle Channel (30 MHz - 25 GHz)

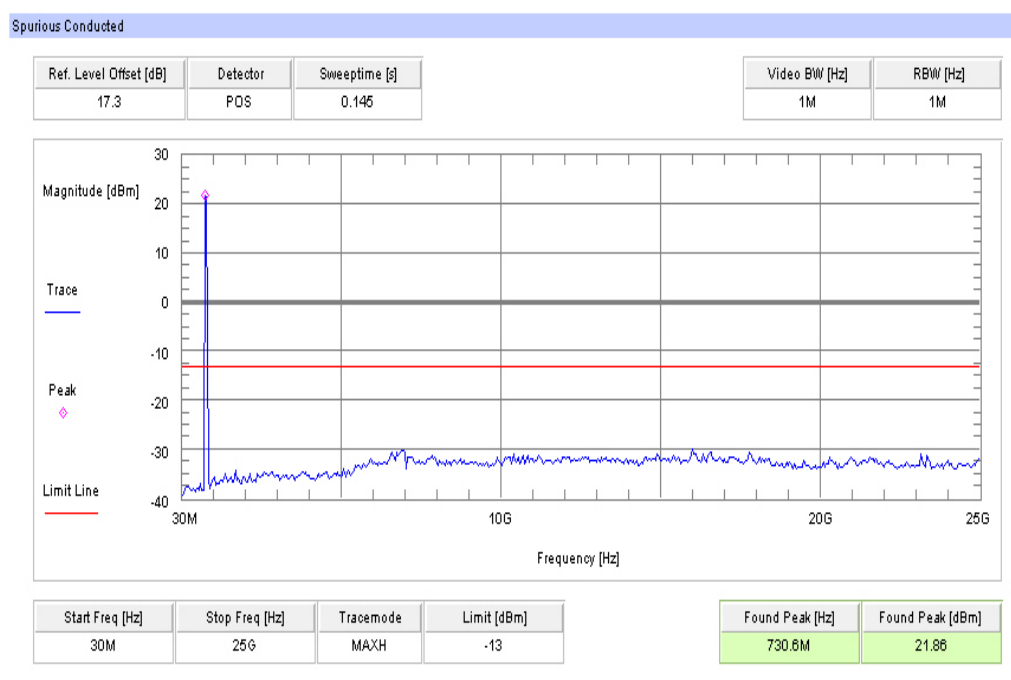

Plot 3: Highest Channel (30 MHz - 25 GHz)

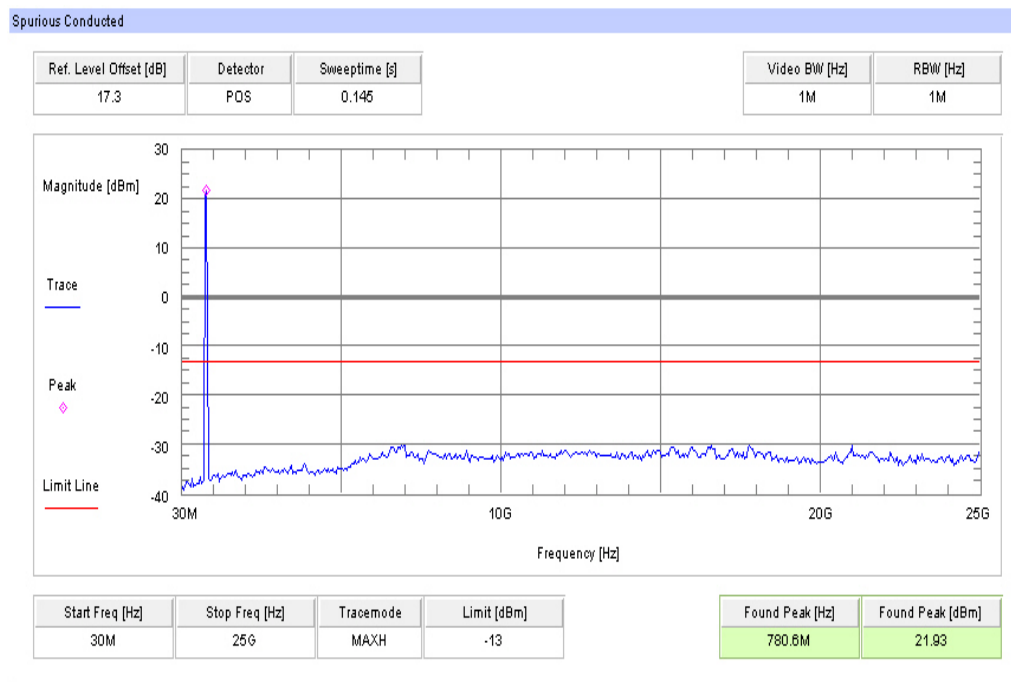

Results: for 10 MHz channel bandwidth

Plots: 16-QAM

Plot 1: Middle Channel; RB = 50 (30 MHz - 25 GHz)

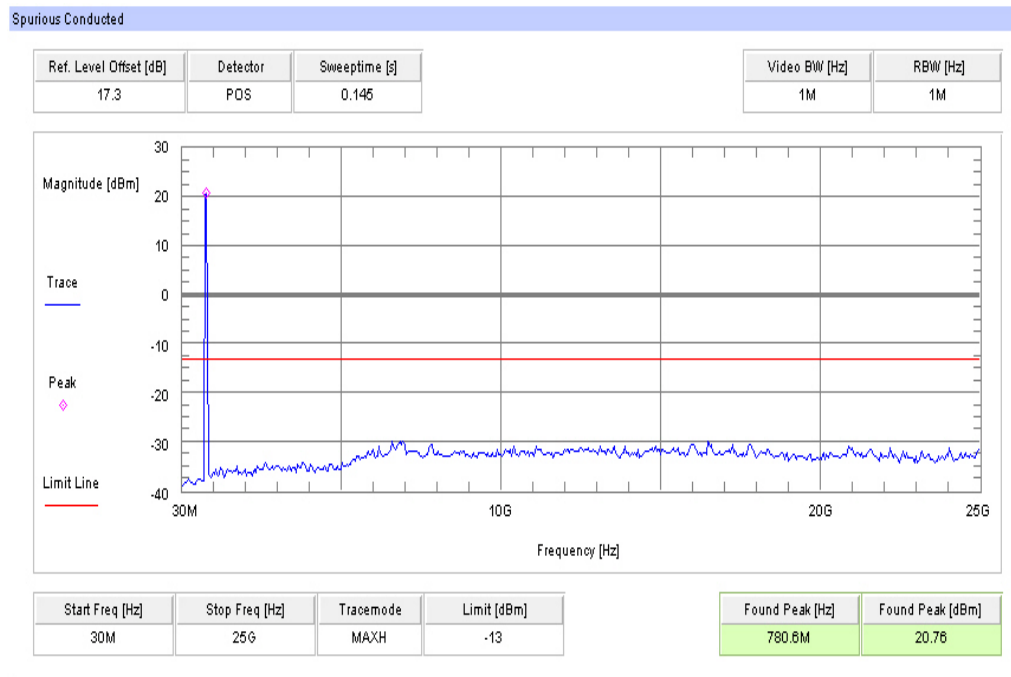

Plot 2: Middle Channel; RB=1 (30 MHz - 25 GHz)

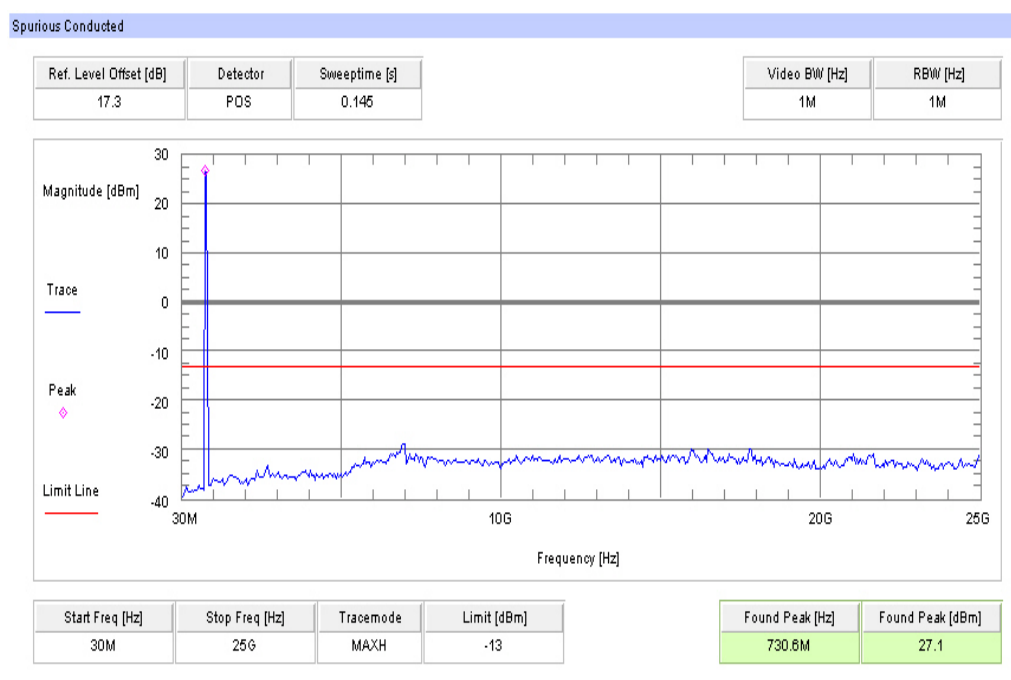

8.3.5 Block edge compliance

Description:

The spectrum at the band edges must comply with the spurious emissions limits.

For the measurement the lowest, middle and highest channel bandwidth was used. If spurious were found the other bandwidths were measured, too.

Measurement:

Measurement parameters	
Detector:	RMS
Sweep time:	20 sec.
Video bandwidth:	30 kHz
Resolution bandwidth:	30 kHz
Span:	1 MHz
Trace-Mode:	Max Hold

Limits:

FCC	IC
CFR Part 27.53(h) CFR Part 2.1053	-/-
Block Edge Compliance	
<p>Part 27.53 specifies that “the power of any emission outside of the authorized operating frequency ranges must be attenuated below the transmitting power (P) by a factor of at least 43 + 10 log(P) dB.”</p> <p>However, in publication number 890810, The FCC Office of Engineering and Technology specified the following correction to the limits when a resolution bandwidth smaller than 1% of the emission bandwidth is used:</p> <p>“An alternative is to add an additional correction factor of 10 Log (RBW1/ RBW2) to the 43 +10 log(P) limit. RBW1 is the narrower measurement resolution bandwidth and RBW2 is either the 1% emissions bandwidth or 1 MHz.”</p> <p>When using a 30 kHz bandwidth, this yields a -2.2185 adjustment to the limit [10 log(30kHz/(Bw/100)kHz) = -X.XX]. When this adjustment is applied to the limit, the limit becomes -13 -X.XX dBm.</p>	
<p>1.4 MHz: -6.38 dBm 3 MHz: -13.00 dBm 5 MHz: -15.22 dBm 10 MHz: -18.23 dBm 15 MHz: -19.99 dBm 20 MHz: -21.24 dBm</p>	

Results: 5 MHz channel bandwidth

Plot 1: Lowest Channel– QPSK / 1 RB low

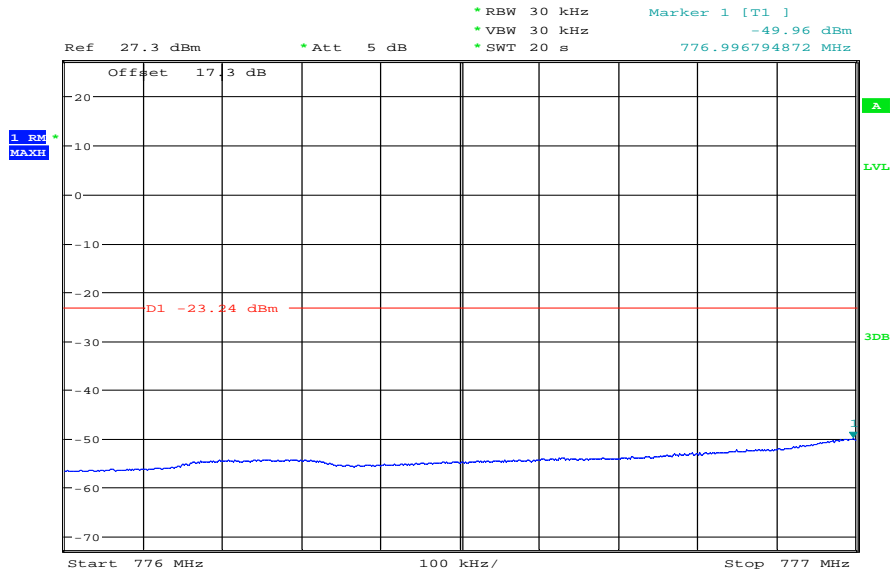

Date: 27.MAR.2013 14:16:57

Plot 2: Highest Channel– QPSK / 1 RB high

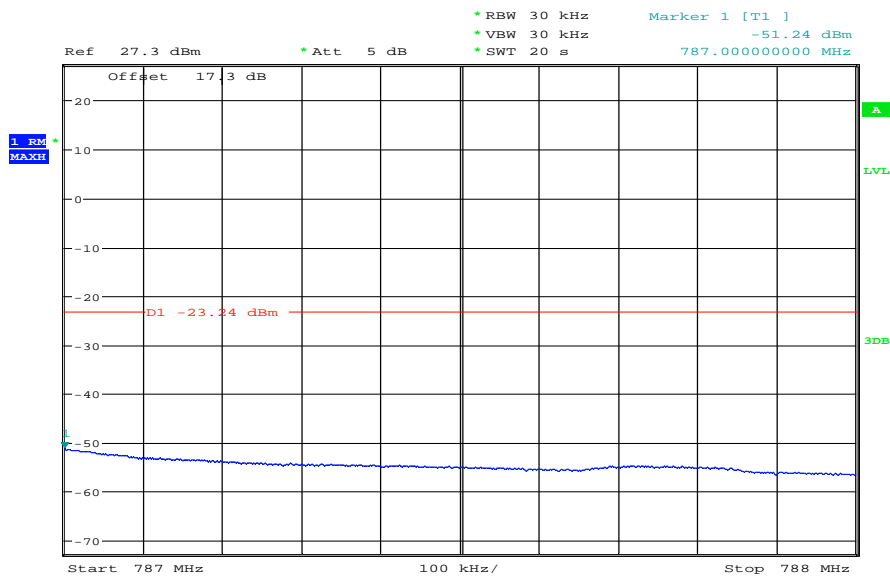

Date: 27.MAR.2013 14:20:51

Plot 3: Lowest Channel- QPSK / 25 RB

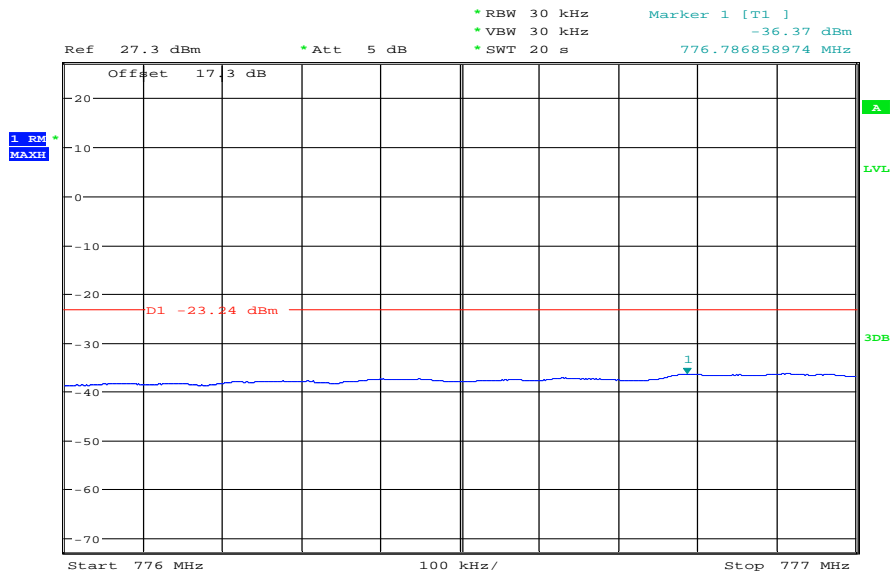

Date: 27.MAR.2013 14:15:53

Plot 4: Highest Channel- QPSK / 25 RB

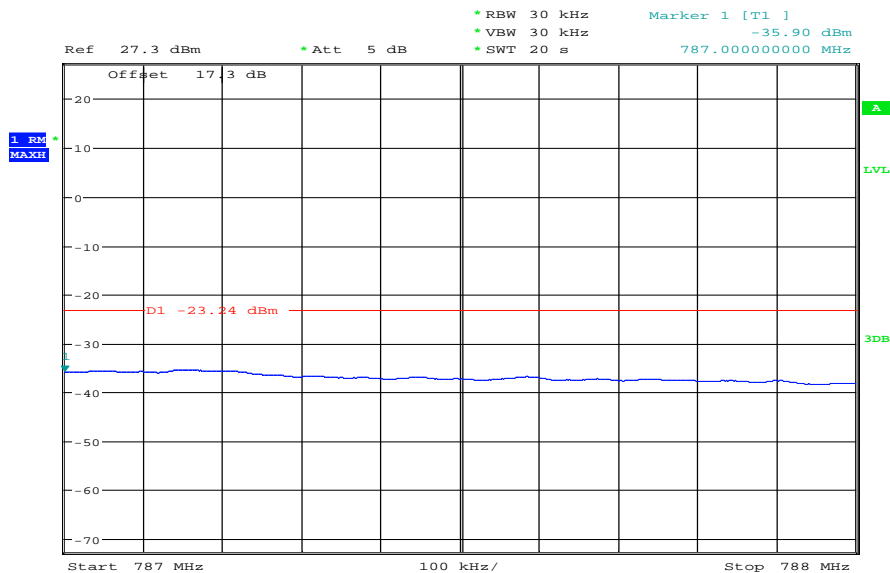

Date: 27.MAR.2013 14:19:42

Results: 10 MHz channel bandwidth

Plot 1: Middle Channel- QPSK / 1 RB low

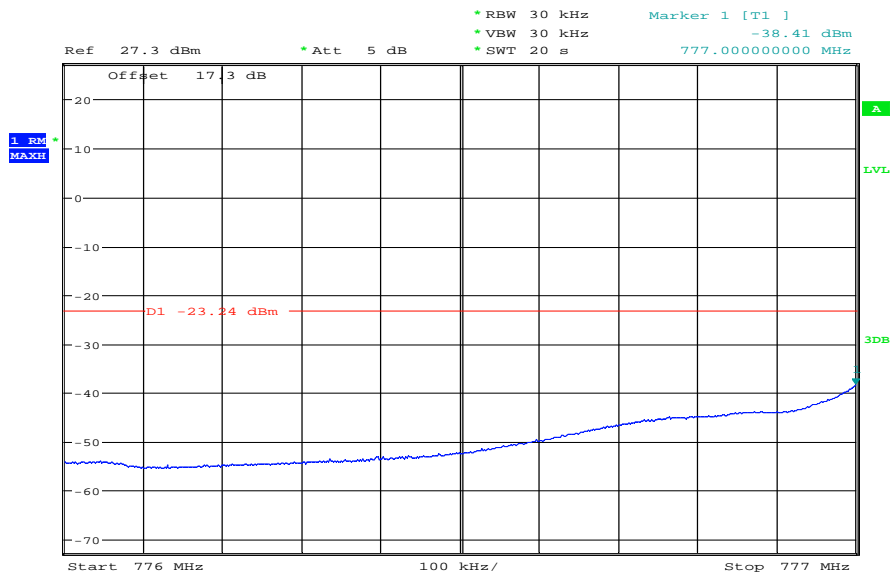

Date: 27.MAR.2013 14:12:21

Plot 2: Middle Channel- QPSK / 1 RB high

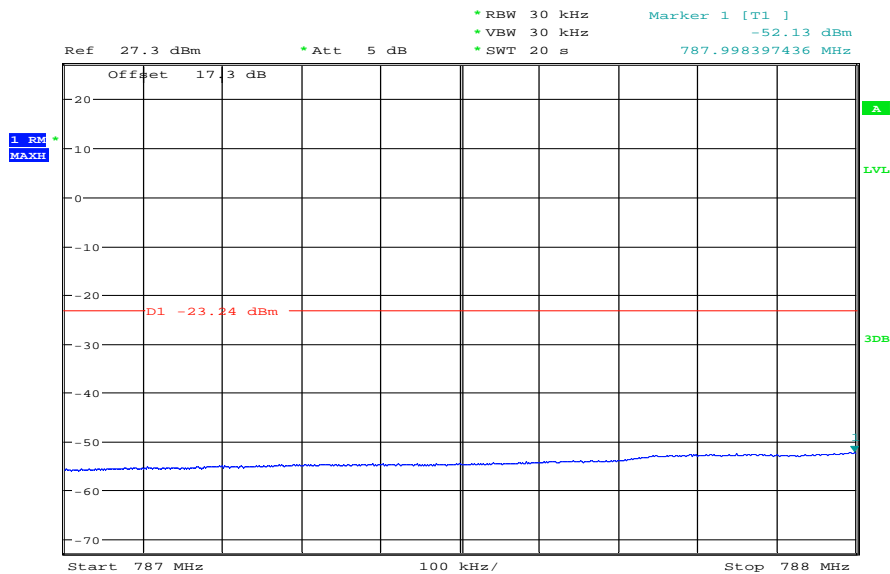

Date: 27.MAR.2013 14:07:48

Plot 3: Middle Channel- QPSK / 50 RB

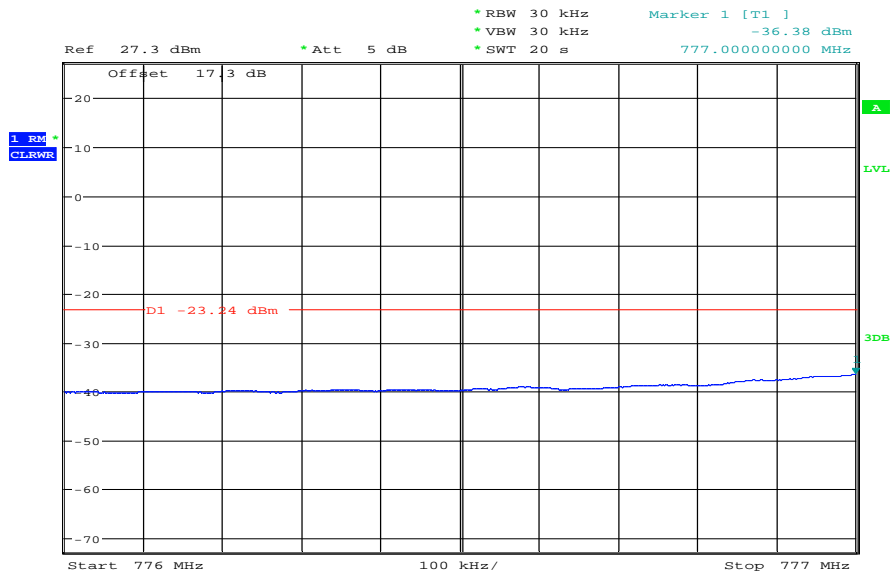

Date: 27.MAR.2013 14:11:02

Plot 4: Middle Channel- QPSK / 50 RB

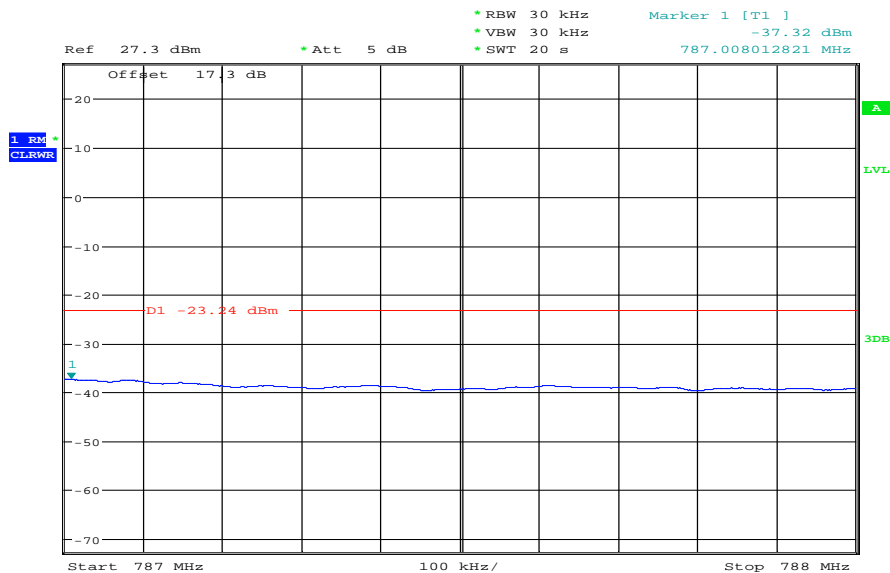

Date: 27.MAR.2013 14:10:03

Result: Passed

8.3.6 Occupied bandwidth

Description:

Measurement of the occupied bandwidth of the transmitted signal.

Measurement:

Similar to conducted emissions, occupied bandwidth measurements are only provided for selected frequencies in order to reduce the amount of submitted data. Data were taken at the mid frequencies of the LTE band 4 frequency band. The table below lists the measured 99% power and -26dBc occupied bandwidths. Spectrum analyzer plots are included on the following pages.

Part 27.53 requires a measurement bandwidth of at least 1% of the occupied bandwidth.

Measurement parameters	
Detector:	Peak
Sweep time:	Auto
Video bandwidth:	Depends on Channel Bandwidth
Resolution bandwidth:	Depends on Channel Bandwidth
Span:	Depends on Channel Bandwidth
Trace-Mode:	Max Hold

Limits:

FCC	IC
CFR Part 27.53(h) CFR Part 2.1049	-/-
Occupied Bandwidth	
Spectrum must fall completely in the specified band	

Results:

Occupied Bandwidth - QPSK		
Bandwidth [MHz]	99% OBW (MHz)	-26 dBc BW (MHz)
-/-	Np	Np
	Np	Np
	Np	Np
-/-	Np	Np
5	4.49	5.01
	4.50	4.96
	4.49	4.97
10	8.97	9.89
-/-	Np	Np
-/-	Np	Np
	Np	Np
	Np	Np
Measurement uncertainty	± 100 kHz	

Occupied Bandwidth – 16 QAM		
Bandwidth [MHz]	99% OBW (MHz)	-26 dBc BW (MHz)
-/-	Np	Np
	Np	Np
	Np	Np
-/-	Np	Np
5	4.52	5.10
	4.54	5.10
	4.54	5.20
10	9.00	9.96
-/-	Np	Np
-/-	Np	Np
	Np	Np
	Np	Np
Measurement uncertainty	± 100 kHz	

Result: Passed

Plots: QPSK

Plot 1: 5 MHz (99% - OBW) / Channel low

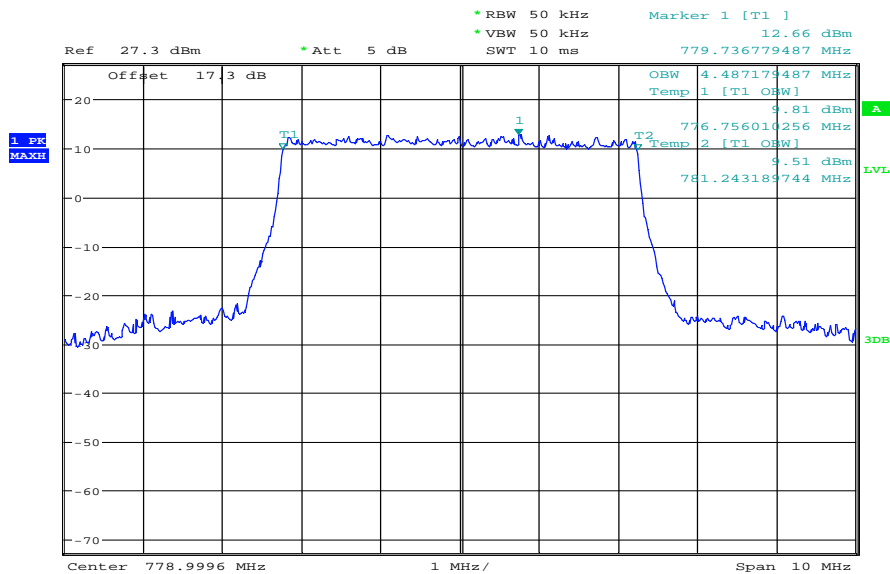

Date: 27.MAR.2013 13:14:39

Plot 2: 5 MHz (-26 dBc BW) / Channel low

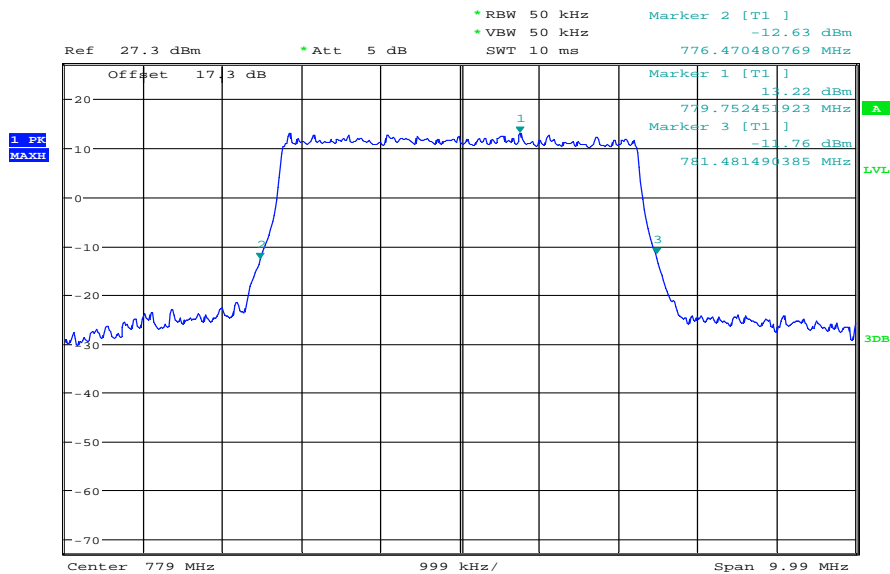

Date: 27.MAR.2013 12:51:48

Plot 3: 5 MHz (99% - OBW) / Channel mid

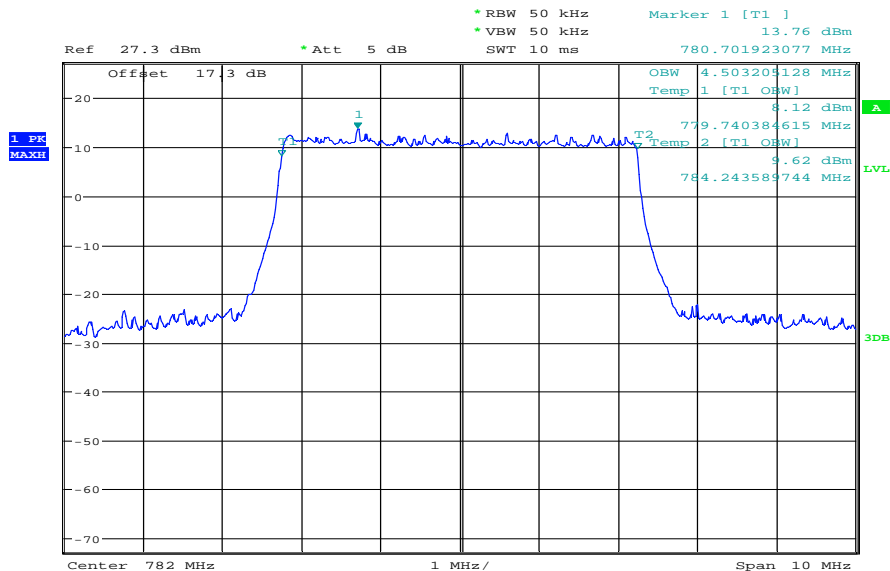

Date: 27.MAR.2013 13:18:03

Plot 4: 5 MHz (-26 dBc BW) / Channel mid

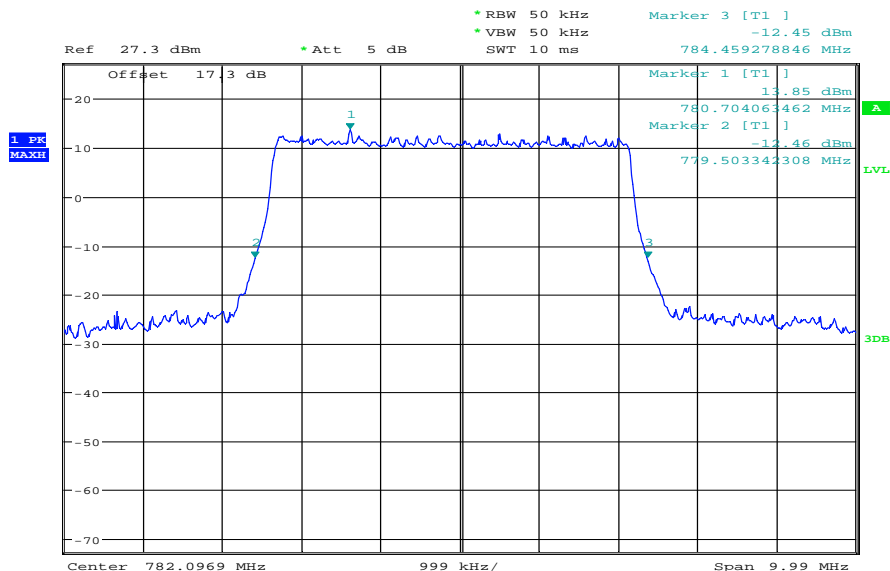

Date: 27.MAR.2013 12:55:16

Plot 5: 5 MHz (99% - OBW) / Channel high

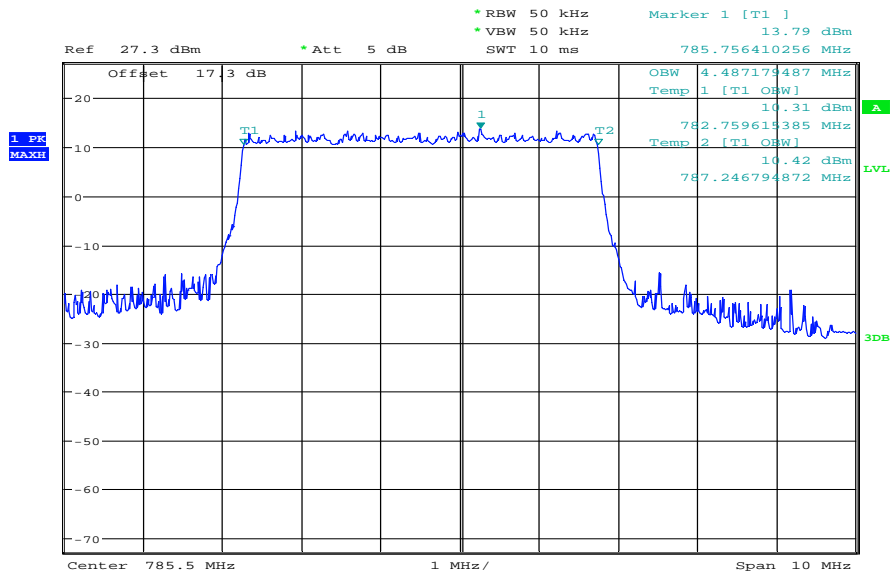

Date: 27.MAR.2013 13:20:53

Plot 6: 5 MHz (-26 dBc BW) / Channel high

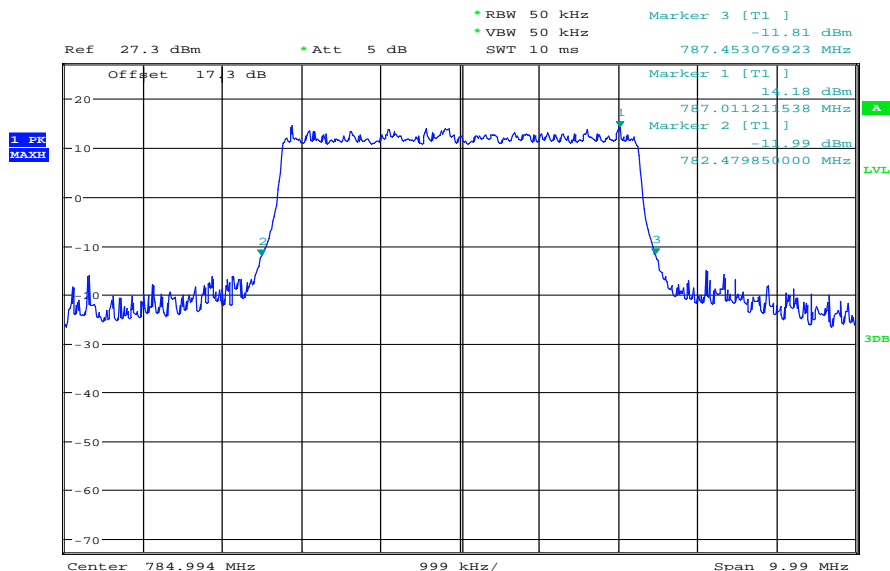

Date: 27.MAR.2013 12:57:21

Plot 7: 10 MHz (99% - OBW) / Channel mid

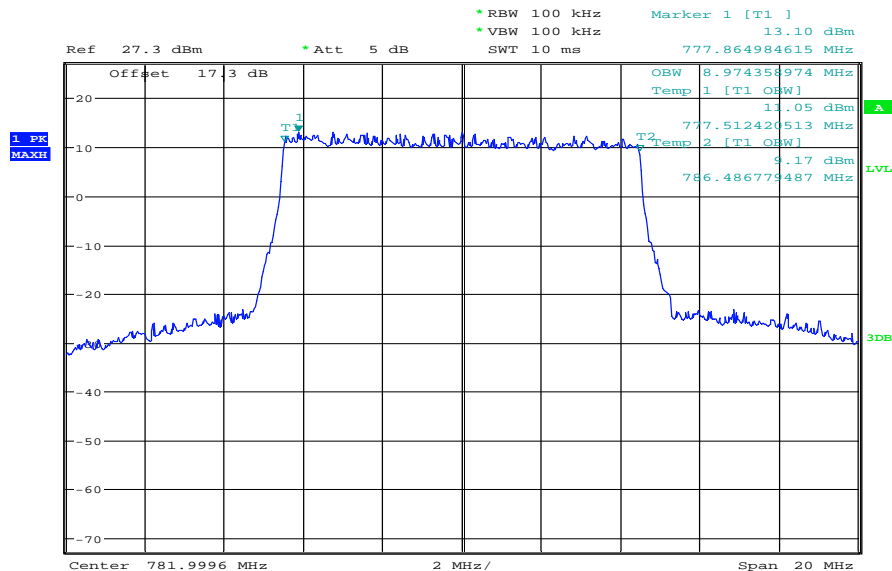

Date: 27.MAR.2013 13:11:30

Plot 8: 10 MHz (-26 dBc BW) / Channel mid

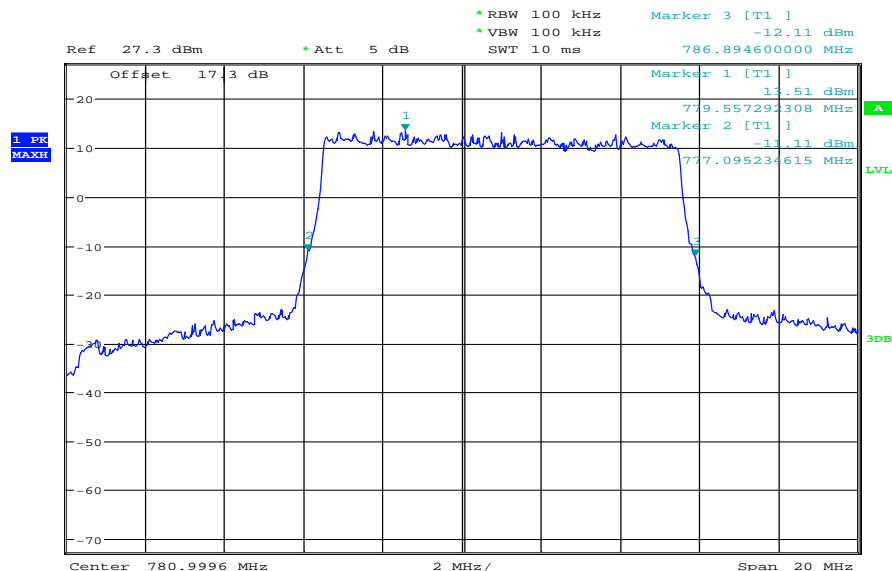

Date: 27.MAR.2013 13:02:44

Plots: 16 - QAM

Plot 1: 5 MHz (99% - OBW) / Channel low

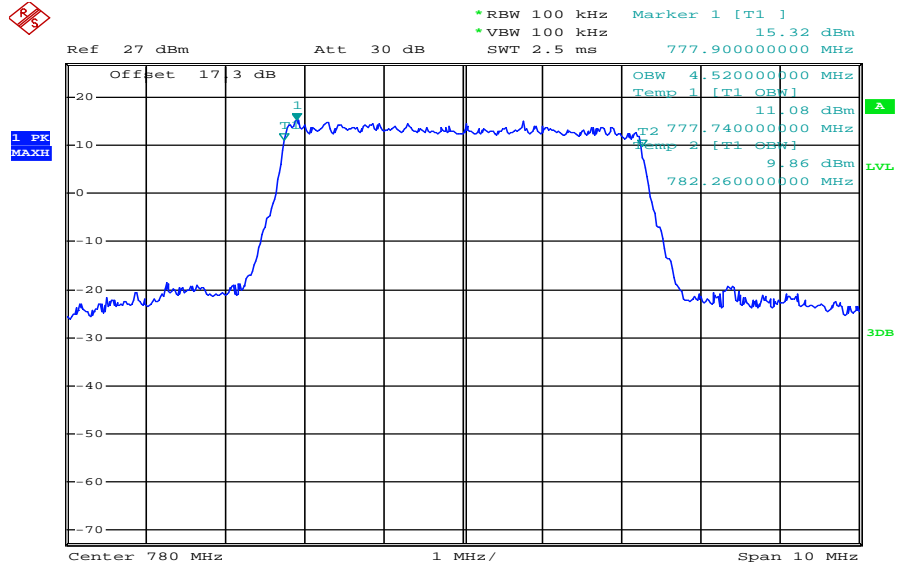

Date: 4.APR.2013 15:01:30

Plot 2: 5 MHz (-26 dBc BW) / Channel low

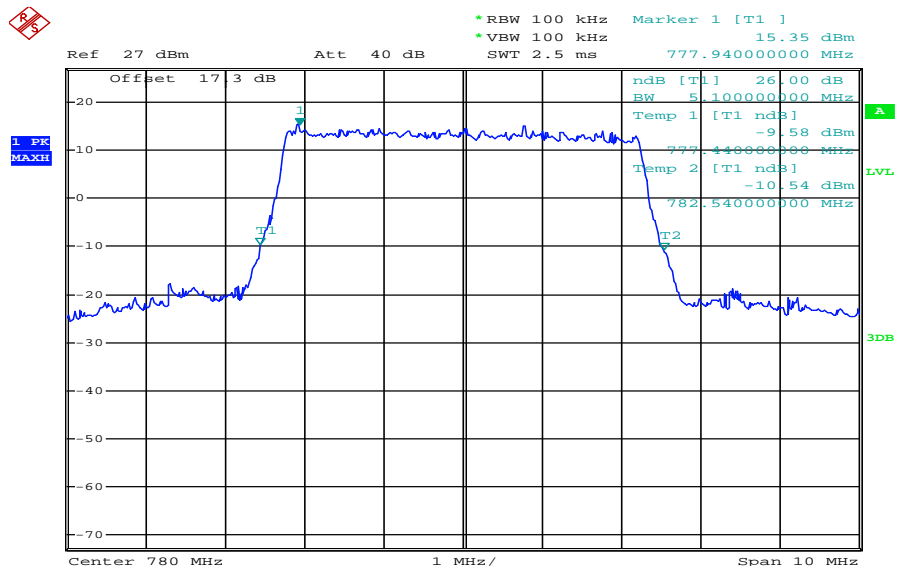

Date: 4.APR.2013 15:00:46

Plot 3: 5 MHz (99% - OBW) / Channel mid

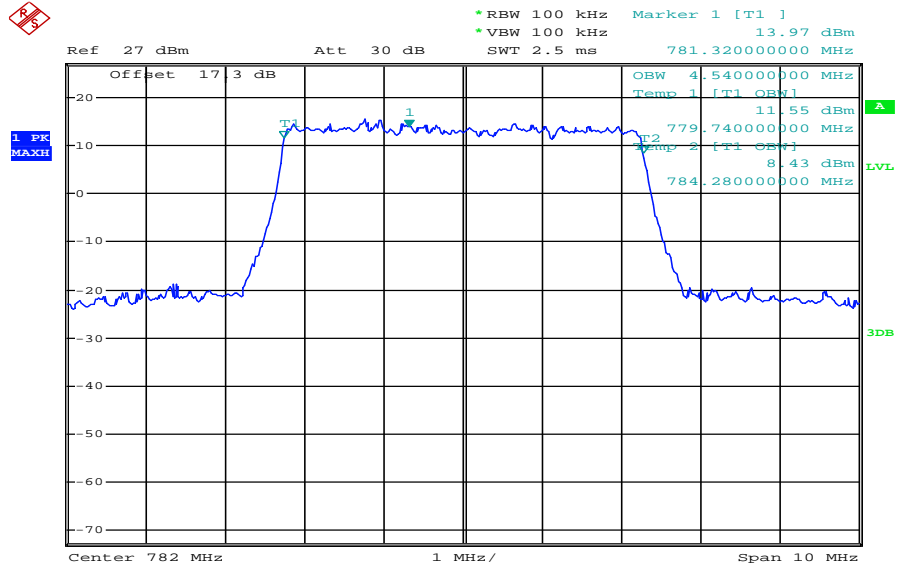

Date: 4.APR.2013 14:59:18

Plot 4: 5 MHz (-26 dBc BW) / Channel mid

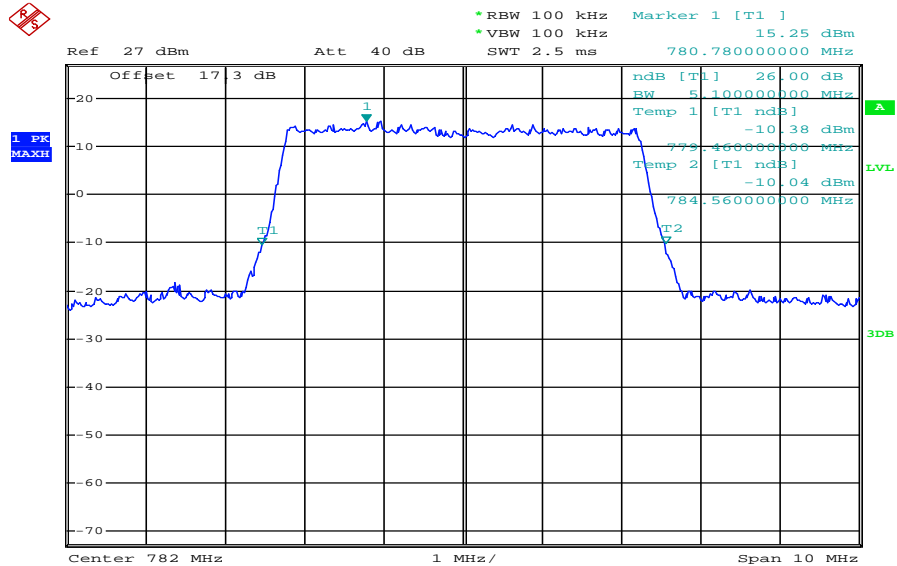

Date: 4.APR.2013 14:59:56

Plot 5: 5 MHz (99% - OBW) / Channel high

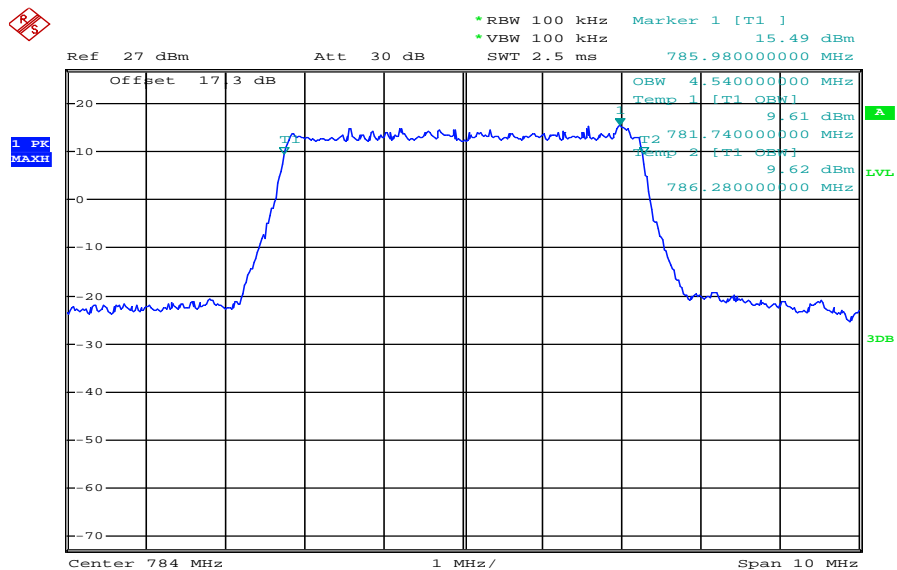

Date: 4.APR.2013 14:58:18

Plot 6: 5 MHz (-26 dBc BW) / Channel high

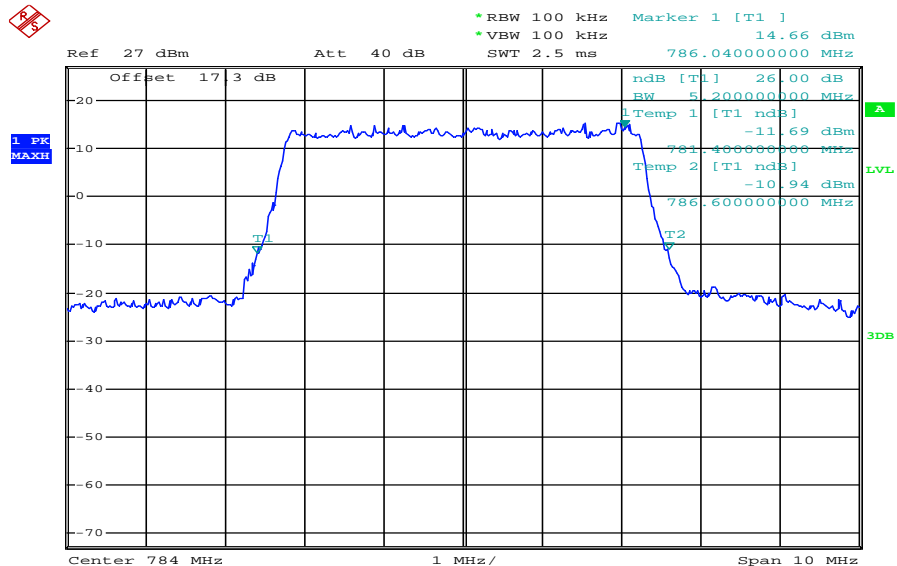

Date: 4.APR.2013 14:57:32

Plot 7: 10 MHz (99% - OBW) / Channel mid

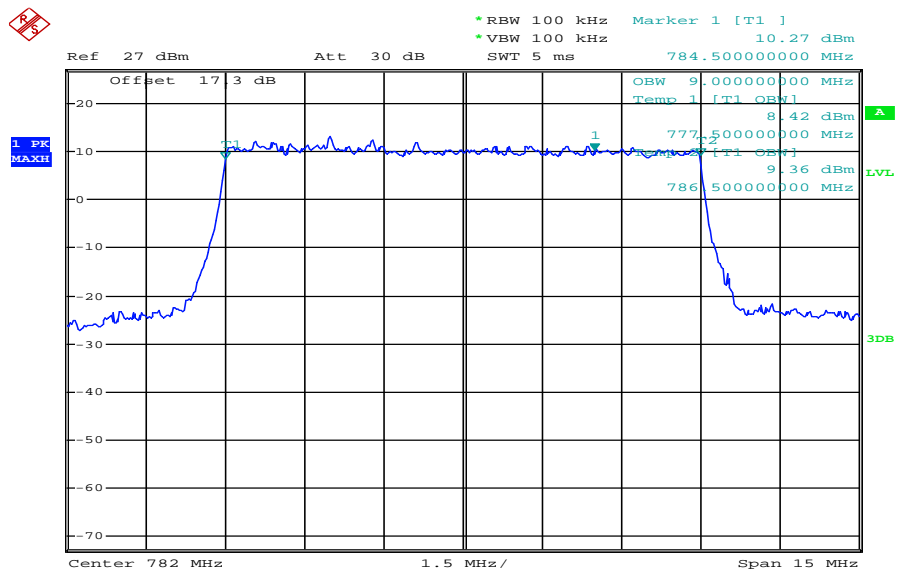

Date: 4.APR.2013 14:51:30

Plot 8: 10 MHz (-26 dBc BW) / Channel mid

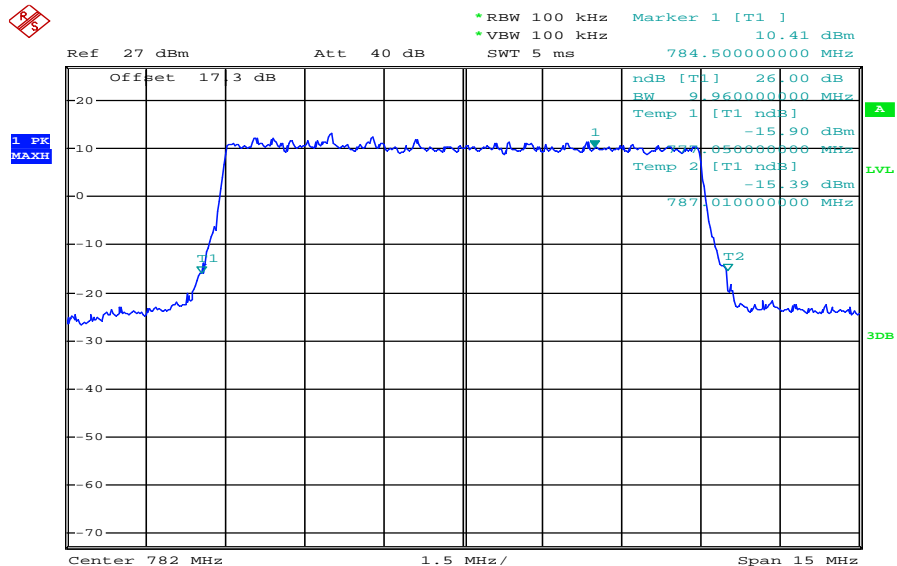

Date: 4.APR.2013 14:52:22

9 Test equipment and ancillaries used for tests

Typically, the calibrations of the test apparatus are commissioned to and performed by an accredited calibration laboratory. The calibration intervals are determined in accordance with the DIN EN ISO/IEC 17025. In addition to the external calibrations, the laboratory executes comparison measurements with other calibrated test systems or effective verifications. Weekly chamber inspections and range calibrations are performed. Where possible, rf-generating and signalling equipment as well as measuring receivers and analyzers are connected to an external high-precision 10 MHz reference (GPS-based or rubidium frequency standard).

In order to simplify the identification of the equipment used at some special tests, some items of test equipment and ancillaries can be provided with an identifier or number in the equipment list below (Labor/Item).

No.	Lab / Item	Equipment	Type	Manufact.	Serial No.	INV. No Cetecom	Kind of Calibration	Last Calibration	Next Calibration
1	CR 79	Std. Gain Horn Antenna 26.5- 40.0 GHz	V637	Narda	7911	300001751	ne		
2	11b	Microwave System Amplifier, 0.5- 26.5 GHz	83017A	HP Meßtechnik	00419	300002268	ev		
3	A025	Std. Gain Horn Antenna 12.4 to 18.0 GHz	639	Narda		300000786	ne		
4	A026	Std. Gain Horn Antenna 12.4 to 18.0 GHz	639	Narda		300000787	ne		
5	A027	Std. Gain Horn Antenna 18.0 to 26.5 GHz	638	Narda		300000486	ne		
6	A028	Std. Gain Horn Antenna 18.0 to 26.5 GHz	638	Narda		300002440	ne		
7	A029	Std. Gain Horn Antenna 18.0 to 26.5 GHz	638	Narda		300002442	ne		
8	A030	Std. Gain Horn Antenna 18.0 to 26.5 GHz	638	Narda		300000487	ne		
9	n. a.	Std. Gain Horn Antenna 26.5- 40.0 GHz	V637	Narda	7911	300001752	ne		
10	n. a.	Spectrum Analyzer 20 Hz - 50 GHz	FSU50	R&S	200012	300003443	Ve	09.10.2012	09.10.2014
11	n. a.	Spectrum Analyzer 9kHz to 30GHz - 140...+30dBm	FSP30	R&S	100886	300003575	k	22.08.2012	22.08.2014
12	n. a.	MXA Signal Analyzer 20 Hz - 26.5 GHz	N9020A MXA Signal Analyzer	Agilent Technologi es	US46220229	300003805	vIKI!	16.01.2013	16.01.2015
13	n. a.	Broadband Low Noise Amplifier 18-50 GHz	CBL18503 070-XX	CERNEX	19338	300004273	ne		
14	n. a.	PXA Spectrum Analyzer 3Hz to 50GHz	N9030A PXA Signal Analyzer	Agilent Technologi es	US51350267	300004338	k	16.12.2012	16.12.2013
15	n. a.	Signal Analyzer 40 GHz	FSV40	R&S	101042	300004517	k	22.10.2012	22.10.2013
16	n. a.	DC power supply, 60Vdc, 50A, 1200 W	6032A	HP Meßtechnik	2818A03450	300001040	Ve	12.01.2012	12.01.2015
17	n. a.	Double-Ridged Waveguide Horn Antenna 1-18.0GHz	3115	EMCO	8812-3088	300001032	vIKI!	11.05.2011	11.05.2013
18	n. a.	Active Loop Antenna	6502	EMCO	2210	300001015	ne		
19	n. a.	Anechoic chamber	FAC 3/5m	MWB / TDK	87400/02	300000996	ev		
20	n. a.	Switch / Control Unit	3488A	HP Meßtechnik	*	300000199	ne		
21	n. a.	Switch / Control Unit	3488A	HP Meßtechnik	2719A15013	300001156	ne		
22	9	Isolating Transformer	MPL IEC625	Erfi	91350	300001155	ne		

			Bus Regeltrenn- ravo						
23	n. a.	Three-Way Power Splitter, 50 Ohm	11850C	HP Meßtechnik		300000997	ne		
24	n. a.	Amplifier	js42- 00502650- 28-5a	Parzich GMBH	928979	300003143	ne		
25	n. a.	Band Reject filter	WRCG185 5/1910- 1835/1925- 40/8SS	Wainwright	7	300003350	ev		
26	n. a.	Band Reject filter	WRCG240 0/2483- 2375/2505- 50/10SS	Wainwright	11	300003351	ev		
27	n. a.	Highpass Filter	WHKX7.0/1 8G-8SS	Wainwright	18	300003789	ne		
28	n. a.	TRILOG Broadband Test-Antenna 30 MHz - 3 GHz	VULB9163	Schwarzbe- ck	371	300003854	vlk!	14.10.2011	14.10.2014
29	n. a.	MXE EMI Receiver 20 Hz bis 26,5 GHz	N9038A	Agilent Technologi- es	MY51210197	300004405	k	21.02.2013	21.02.2014
30	n. a.	Switch / Control Unit	3488A	HP Meßtechnik	2605e08770	300001443	ne		
31	n. a.	Signal Analyzer 20Hz-26,5GHz- 150 to + 30 DBM	FSiQ26	R&S	835111/0004	300002678	Ve	15.01.2013	15.01.2015
32	n. a.	Power Supply 0-20V; 0-5A	6632B	HP	US37478366	400000117	vlk!	20.08.2012	20.08.2014

Agenda: Kind of Calibration

k	calibration / calibrated	EK	limited calibration
ne	not required (k, ev, izw, zw not required)	zw	cyclical maintenance (external cyclical maintenance)
ev	periodic self verification	izw	internal cyclical maintenance
Ve	long-term stability recognized	g	blocked for accredited testing
vlk!	Attention: extended calibration interval	*)	next calibration ordered / currently in progress
NK!	Attention: not calibrated		

10 Observations

No observations exceeding those reported with the single test cases have been made.

Annex A Document history

Version	Applied changes	Date of release
1.0	Initial release	2013-03-28
-A	Addition of ERP measurement results and PIN; correction of result tables	2013-04-02
-B	Changed standard version	2013-04-04
-C	Addition of -26dBc and OBW measurements	2013-04-04
-D	Addition of output power values and emission designator table	2013-04-10

Annex B Further information

Glossary

AVG	-	Average
DUT	-	Device under test
EMC	-	Electromagnetic Compatibility
EN	-	European Standard
EUT	-	Equipment under test
ETSI	-	European Telecommunications Standard Institute
FCC	-	Federal Communication Commission
FCC ID	-	Company Identifier at FCC
HW	-	Hardware
IC	-	Industry Canada
Inv. No.	-	Inventory number
N/A	-	Not applicable
PP	-	Positive peak
QP	-	Quasi peak
S/N	-	Serial number
SW	-	Software

Annex C Accreditation Certificate

Front side of certificate



Deutsche Akkreditierungsstelle GmbH

Befähigung gemäß § 8 Absatz 1 AkkStelleG i.V.m. § 1 Absatz 1 AkkStelleGBV
 Unterzeichnerin der Multilateralen Abkommen
 von EA, ILAC und IAF zur gegenseitigen Anerkennung

Akkreditierung



Die Deutsche Akkreditierungsstelle GmbH bestätigt hiermit, dass das Prüflaboratorium

CETECOM ICT Services GmbH
 Untertürkheimer Straße 6-10, 66117 Saarbrücken

die Kompetenz nach DIN EN ISO/IEC 17025:2005 besitzt, Prüfungen in folgenden Bereichen durchzuführen:

- Drahtgebundene Kommunikation einschließlich xDSL**
- VoIP und DECT
- Akustik
- Funk einschließlich WLAN
- Short Range Devices (SRD)
- RFID
- WiMax und Richtfunk
- Mobilfunk (GSM / DCS, Over the Air (OTA) Performance)
- Elektromagnetische Verträglichkeit (EMV) einschließlich Automotive
- Produktsicherheit
- SARS und Hearing Aid Compatibility (HAC)
- Umweltsimulation
- Smart Card Terminals
- Bluetooth
- Wi-Fi- Services

Die Akkreditierungskurde gilt nur in Verbindung mit dem Bescheid vom 18.01.2013 mit der Akkreditierungsnummer D-PL-12076-01 und ist gültig 17.01.2018. Sie besteht aus diesem Deckblatt, der Rückseite des Deckblatts und der folgenden Anlage mit insgesamt 80 Seiten.

Registrierungsnummer der Urkunde: D-PL-12076-01-01

Frankfurt am Main, 18.01.2013
Siehe Hinweis auf der Rückseite

Im Auftrag
 Dr. Ingrid Röhler
 Abteilungsleiter

Back side of certificate

Deutsche Akkreditierungsstelle GmbH

Standort Berlin Spittelmarkt 10 10117 Berlin	Standort Frankfurt am Main Gartenstraße 6 60594 Frankfurt am Main	Standort Braunschweig Rundesallee 100 38116 Braunschweig
--	---	--

Die auszugsweise Veröffentlichung der Akkreditierungskurde bedarf der vorherigen schriftlichen Zustimmung der Deutschen Akkreditierungsstelle GmbH (DAkkS). Ausgenommen davon ist die separate Weiterverbreitung des Deckblatts durch die umseitig genannte Konformitätsbewertungsstelle in unveränderter Form.

Es darf nicht der Anschein erweckt werden, dass sich die Akkreditierung auch auf Bereiche erstreckt, die über den durch die DAkkS bestätigten Akkreditierungsbereich hinausgehen.

Die Akkreditierung erfolgte gemäß des Gesetzes über die Akkreditierungsstelle (AkkStelleG) vom 31. Juli 2009 (BGBl. I S. 2625) sowie der Verordnung (EG) Nr. 765/2008 des Europäischen Parlaments und des Rates vom 9. Juli 2008 über die Vorschriften für die Akkreditierung und Marktüberwachung im Zusammenhang mit der Vermarktung von Produkten (Abt. L 218 vom 9. Juli 2008, S. 30). Die DAkkS ist Unterzeichnerin der Multilateralen Abkommen zur gegenseitigen Anerkennung der European co-operation for Accreditation (EA), des International Accreditation Forum (IAF) und der International Laboratory Accreditation Cooperation (ILAC). Die Unterzeichner dieser Abkommen erkennen ihre Akkreditierungen gegenseitig an.

Der aktuelle Stand der Mitgliedschaft kann folgenden Webseiten entnommen werden:
 EA: www.european-accreditation.org
 ILAC: www.ilac.org
 IAF: www.iaf.nu

Note:

The current certificate including annex is published on our website (see link below) or may be received from CETECOM ICT Services on request.

<http://www.cetecom.com/eu/de/cetecom-group/europa/deutschland-saarbruecken/akkreditierungen.html>