

FCC DFS Test Report

Tested in accordance with
Federal Communications Commission (FCC)
Personal Communications Services
CFR 47, Parts 15.407
&
Industry Canada (IC), RSS-210



A division of Research In Motion Limited

REPORT NO.: RTS-6012-1211-36

PRODUCT MODEL NO.: RFH121LW
TYPE NAME: BlackBerry® smartphone
FCC ID: L6ARFH120LW
IC: 2503A-RFH120LW

DATE: November 26, 2012

**RTS is accredited
according to
EN ISO/IEC 17025 by:**



592

	DFS Test Report for the BlackBerry® smartphone Model RFH121LW	
Test Report No. RTS-6012-1211-36	Date of Test November 19 - 21, 2012	FCC ID: L6ARFH120LW IC : 2503A-RFH120LW

Statement of Performance:

The BlackBerry® smartphone, model RFH121LW, part number CER-52836-001 Rev 2 and accessories when configured and operated per RIM's operation instructions, and performs within the requirements of the test standards.

Declaration:

We hereby certify that:

The test data reported herein is an accurate record of the performance of the sample(s) tested.

The test results are valid for the tested unit (s) only.

The test equipment used was suitable for the tests performed and within manufacturer's published specifications and operating parameters.

The test methods were consistent with the methods described in the relevant standards.

Documented by:

Reviewed by:

Heng Lin
Regulatory Compliance Specialist

Feras Obeid
Regulatory Compliance Associate

Reviewed and Approved by:

Masud S. Attayi, P.Eng.
Manager, Regulatory Compliance

	DFS Test Report for the BlackBerry® smartphone Model RFH121LW	
Test Report No. RTS-6012-1211-36	Date of Test November 19 - 21, 2012	FCC ID: L6ARFH120LW IC : 2503A-RFH120LW

Table of Contents

A. Scope4

B. Associated Documents.....4

C. Product Identification.....4

D. Support Equipment Used for the Testing of the EUT5

E. Test Results Chart – FCC Part 15, Client Device.....6

F. Summary of Result.....6

G. Compliance Test Equipment Used.....6

APPENDIX 1 - DFS TEST PLOTS and DATA7

	DFS Test Report for the BlackBerry® smartphone Model RFH121LW	
Test Report No. RTS-6012-1211-36	Date of Test November 19 - 21, 2012	FCC ID: L6ARFH120LW IC : 2503A-RFH120LW

A. Scope

This report details the results of compliance tests that were performed in accordance with the requirements of:

- FCC CFR 47 Part 15.407, October, 2011
- Industry Canada, RSS-210, Issue 8, December 2010, Licence-exempt Radio Apparatus

B. Associated Documents

None

C. Product Identification

Manufactured by Research In Motion Limited whose headquarters is located at:

295 Phillip Street
 Waterloo, Ontario
 Canada, N2L 3W8
 Phone: 519 888 7465
 Fax: 519 888 6906

The equipment under test (EUT) was tested at the following locations:

RIM Testing Services
 440 Phillip Street
 Waterloo, Ontario
 Canada, N2L 5R9
 Phone: 519 888 7465
 Fax: 519 888 6906

The testing was performed on November 19 - 21, 2012.

		DFS Test Report for the BlackBerry® smartphone Model RFH121LW		
Test Report No. RTS-6012-1211-36	Date of Test November 19 - 21, 2012	FCC ID: L6ARFH120LW	IC : 2503A-RFH120LW	

BlackBerry® smartphone Samples Tested

SAMPLE	MODEL	CER NUMBER	PIN	SOFTWARE
1	RFH121LW	CER-52836-001 Rev 2	25B217A6	10.0.9.785

DFS testing was performed on sample 1.

The manufacturer declared modes for the EUT operational characteristics that affect DFS are as follows:

Operating Modes (5250 -5350 MHz, 5470-5725MHz)

- Master Device
- Client Device (no In-Service Monitoring, no Ad – Hoc mode)
- Client Device with In-Service Monitoring

Channel Protocol

- IP Based
- Frame Based
- Other _____

D. Support Equipment Used for the Testing of the EUT

Manufacturer	Description	Model	Serial Number	FCC ID and IC
Cisco	Access Point	AIR-RM1252G-A-K9	FCW1336Z03R	LDK102061/2 2461B-102061/2
Lenovo	Laptop	8742-C2U	L3-B3615 07/06	MCLJ07H081 2878D-J07H081
D-Link	Router	WBR-1310	P10317B010096	KA2WBR1310 4216A-WBR1310

		DFS Test Report for the BlackBerry® smartphone Model RFH121LW	
Test Report No. RTS-6012-1211-36	Date of Test November 19 - 21, 2012	FCC ID: L6ARFH120LW IC : 2503A-RFH120LW	

E. Test Results Chart – FCC Part 15, Client Device

SPECIFICATION		TEST TYPE	Meets Requirement	Test Data APPENDIX
FCC CFR 47	IC			
Part 15.407	RSS-210, A9.3	Channel closing transmission time	Yes	1
Part 15.407	RSS-210, A9.3	Channel move time	Yes	1
Part 15.407	RSS-210, A9.3	Non-occupancy period - associated	Yes	1

F. Summary of Result

- a). The BlackBerry® smartphone met the requirement of the Channel Closing Transmission and Time, Channel Move time and Non-occupancy period requirement as per FCC 15.407 and RSS 210. The measurement was performed on Channel 56 (5280 MHz) of the DFS band. Radar Type 1 of the Short Pulse Test waveform was used for tests.

See APPENDIX 1 for the test data.

Measurement Uncertainties:

Measurement	Measurement Unit	Expanded Uncertainty
DFS Threshold (Conducted)	dBm	1.2

G. Compliance Test Equipment Used

UNIT	MANUFACTURER	MODEL	SERIAL NUMBER	CAL DUE DATE (YY MM DD)	USE
Spectrum Analyzer	Rohde & Schwarz	FSV	101820	12-12-03	DFS
DFS RF Modulator	National Instruments	PXIe-5611	EC157C	12-12-11	DFS
DFS I/Q Signal Generator	National Instruments	PXIe-5450	EC6BB1	12-12-11	DFS
DFS RF Signal Generator	National Instruments	PXIe-5620	ED2167	12-12-11	DFS
T/RH Meter	OMEGA	iTHX-SD	0380564	13-10-30	DFS

	DFS Test Report for the BlackBerry® smartphone Model RFH121LW APPENDIX 1	
Test Report No. RTS-6012-1211-36	Date of Test November 19 - 21, 2012	FCC ID: L6ARFH120LW IC : 2503A-RFH120LW

APPENDIX 1 - DFS TEST PLOTS and DATA

	DFS Test Report for the BlackBerry® smartphone Model RFH121LW	
	APPENDIX 1	
Test Report No. RTS-6012-1211-36	Date of Test November 19 - 21, 2012	FCC ID: L6ARFH120LW IC : 2503A-RFH120LW

DFS Conducted Test Results

DFS Test Methods

Conducted Test Method

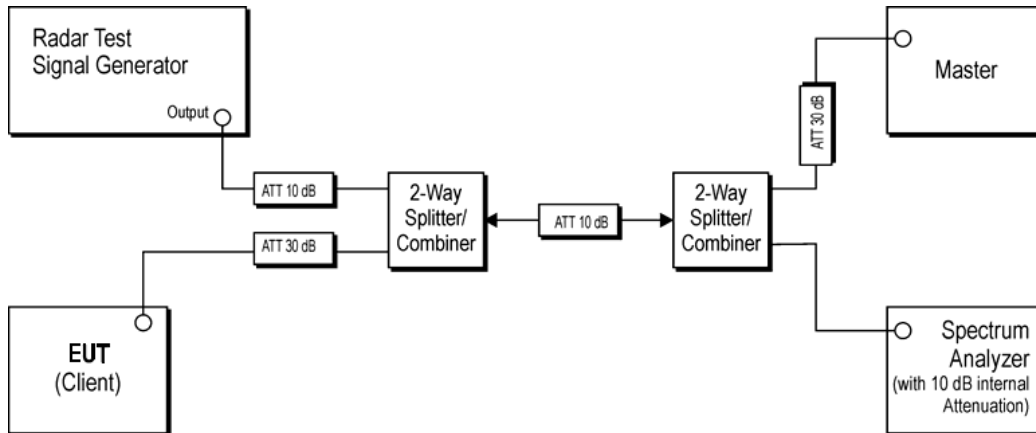

A spectrum analyzer is used as a monitor to verify that the EUT has vacated the Channel within the Channel Closing Transmission Time and Channel Move Time, and does not transmit on a Channel during the Non-Occupancy Period after the detection and Channel Move. It is also used to monitor EUT transmissions during the Channel Availability Check Time.

	DFS Test Report for the BlackBerry® smartphone Model RFH121LW	
	APPENDIX 1	
Test Report No. RTS-6012-1211-36	Date of Test November 19 - 21, 2012	FCC ID: L6ARFH120LW IC : 2503A-RFH120LW

DFS Conducted Test Results Cont'd

Radar Waveforms

FCC Short Pulse Radar Test Waveforms					
Radar Type	Pulse Width (µsec)	PRI (µsec)	Number of Pulses	Minimum Detection Percentage	Minimum Number of Trials
1	1	1428	18	60%	30
2	1-5	150-230	23-29	60%	30
3	6-10	200-500	16-18	60%	30
4	11-20	200-500	12-16	60%	30
Aggregate (Radar Types 1-4)				80%	120

FCC Long Pulse Radar Test Waveforms							
Radar Type	Pulse Width (µsec)	Chirp Width (MHz)	PRI (µs)	Number of Pulses per Burst	Number of Bursts	Minimum Detection Percentage	Minimum Number of Trials
5	50-100	5-20	1000-2000	1-3	8-20	80%	30

Frequency Hopping Radar Test Waveforms							
Radar Type	Pulse Width (µsec)	PRI (µsec)	Pulses per Hop	Hopping Rate (kHz)	Hopping Sequence Length (msec)	Minimum Detection Percentage	Minimum Number of Trials
6	1	333	9	0.333	300	70%	30

	DFS Test Report for the BlackBerry® smartphone Model RFH121LW	
	APPENDIX 1	
Test Report No. RTS-6012-1211-36	Date of Test November 19 - 21, 2012	FCC ID: L6ARFH120LW IC : 2503A-RFH120LW

DFS Conducted Test Results Cont'd

The following tests were performed by Heng Lin

Date of the test: November 19 - 21, 2012

The environmental conditions were: Temperature: 24.2 – 24.5 °C
 Humidity: 25.2 – 25.8 %

Wave form Type	Channel Closing Transmission Time		Channel Move Time		Result
	Measured	Limit	Measured	Limit	
Radar Type 1	34.78 ms	260 ms	0.283 s	10 s	PASS

Channel Closing Transmission Time

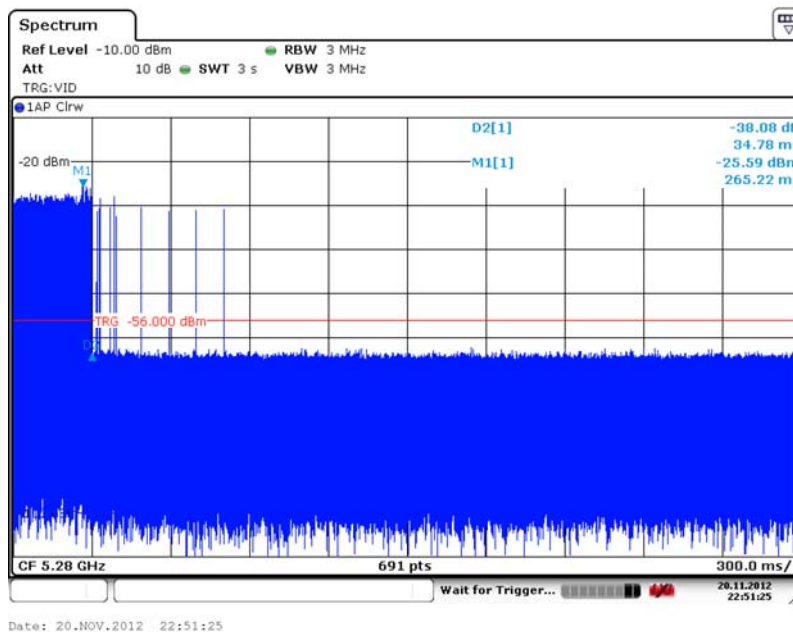

Test Report No.
 RTS-6012-1211-36

Date of Test
 November 19 - 21, 2012

FCC ID: L6ARFH120LW IC : 2503A-RFH120LW

DFS Conducted Test Results Cont'd

Channel Move Time

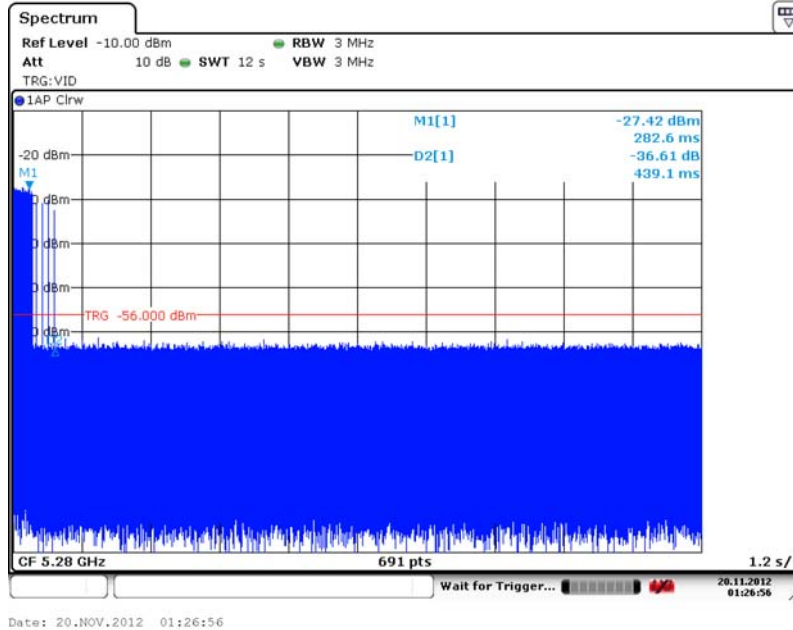

Non-Occupancy Period ≥ 30 min.

