

EMI Test Report

Tested in accordance with
Federal Communications Commission (FCC)
Personal Communications Services
CFR 47 Parts 2, 22, 24 and 90
&
Industry Canada (IC) RSS- Gen, 132 and 133



A division of Research In Motion Limited

REPORT NO: RTS-5994-1203-69A

PRODUCT MODEL NO:	REY21CW, RFD31CW
TYPE NAME:	BlackBerry® smartphone
FCC ID:	L6AREY20CW, L6ARFD30CW
IC:	2503A-REY20CW, 2503A-RFD30CW
EMISSION DESIGNATOR (CDMA):	1M28F9W

DATE: April 09, 2012



EMI Test Report for the BlackBerry® smartphone Model REY21CW, RFD31CW

Test Report No.:
RTS-5994-1203-69A

Dates of Test:
February 23 – April 03, 2012

FCC ID: L6AREY20CW
FCC ID: L6ARFD30CW

IC: 2503A-REY20CW
IC: 2503A-RFD30CW

Statement of Performance:

The BlackBerry® smartphone, model REY21CW, part number CER-48923-001 Rev1 and accessories perform within the requirements of the test standards when configured and operated per RIM's instructions.

The BlackBerry® smartphone, model RFD31CW, part number CER-49832-001 Rev1 and accessories perform within the requirements of the test standards when configured and operated per RIM's instructions

Declaration:

We hereby certify that:

The test data reported herein is an accurate record of the performance of the sample(s) tested. The test results are valid for the tested unit(s) only. The test equipment used was suitable for the tests performed and within manufacturer's published specifications and operating parameters. The test methods were consistent with the methods described in the relevant standards.

Documented by:

Reviewed by:

Savtej S. Sandhu
Regulatory Compliance Specialist
Date: April 05, 2012

Heng Lin
Regulatory Compliance Specialist
Date: April 09, 2012

Reviewed and Approved by:

Masud S. Attayi, P.Eng.
Manager, Regulatory Compliance
Date: April 09, 2012



Test Report No.:
RTS-5994-1203-69A

Dates of Test:
February 23 – April 03, 2012

FCC ID: L6AREY20CW
FCC ID: L6ARFD30CW

IC: 2503A-REY20CW
IC: 2503A-RFD30CW

Table of Contents

A) Scope 4

B) ~~A~~ssociated Documents 4

C) ~~P~~roduct Identification 4

D) ~~S~~upport Equipment Used for the Testing of the EUT 5

E) ~~T~~est Results Chart 6

F) ~~S~~ummary of Results 7

H) ~~C~~ompliance Test Equipment Used..... 11

APPENDIX 1A – CDMA CELL and PCS bands CONDUCTED RF EMISSIONS TEST DATA/PLOTS
..... 13

APPENDIX 1B – CDMA BC10 CONDUCTED RF EMISSIONS TEST DATA/PLOTS..... 29

APPENDIX 2 – CDMA CONDUCTED RF OUTPUT POWER TEST DATA 39

APPENDIX 3 – CDMA FREQUENCY STABILITY TEST DATA..... 41

APPENDIX 4 – CDMA RADIATED EMISSIONS TEST DATA..... 57

		EMI Test Report for the BlackBerry® smartphone Model REY21CW, RFD31CW	
Test Report No.: RTS-5994-1203-69A	Dates of Test: February 23 – April 03, 2012	FCC ID: L6AREY20CW FCC ID: L6ARFD30CW	IC: 2503A-REY20CW IC: 2503A-RFD30CW

A) Scope

This report details the results of compliance tests which were performed in accordance to the requirements of:

- FCC CFR 47 Part 2, Oct, 2011
- FCC CFR 47 Part 22, Subpart H, Cellular Radiotelephone Services, Oct., 2011
- FCC CFR 47 Part 24 Subpart E, Broadband PCS, Oct., 2011
- FCC CFR 47 Part 90, Oct, 2010*
- Industry Canada, RSS-132 Issue 2, September 2005, Cellular Telephones Employing New Technologies Operating in the Bands 824-849 MHz and 869-894 MHz.
- Industry Canada, RSS-133 Issue 5, February 2009, 2 GHz Personal Communications Services.
- Industry Canada, RSS-GEN Issue 3, December 2010, General Requirements and Information for the Certification of Radio communication Equipment

* *Applicable to model RFD31CW only*

B) Associated Documents

- BlackBerrySystemSimilarity_REY21CW_RFD31CW_Rev2

C) Product Identification

Manufactured by Research In Motion Limited whose headquarters is located at:

295 Phillip Street
Waterloo, Ontario
Canada, N2L 3W8
Phone: 519 888 7465
Fax: 519 888 6906

The equipment under test (EUT) was tested at the following locations:

RIM Testing Services EMI test facilities

305 Phillip Street
Waterloo, Ontario
Canada, N2L 3W8
Phone: 519 888 7465
Fax: 519 888 6906

440 Phillip Street
Waterloo, Ontario,
Canada , N2L 5R9
Phone: 519 888 7465
Fax: 519 888 6906

The testing was performed from February 23 – April 03, 2012.



Test Report No.:
RTS-5994-1203-69A

Dates of Test:
February 23 – April 03, 2012

FCC ID: L6AREY20CW
FCC ID: L6ARFD30CW

IC: 2503A-REY20CW
IC: 2503A-RFD30CW

The sample EUT included:

Sample	Model	CER NUMBER	PIN	Software Information
1	REY21CW	CER-48923-001 Rev1	297DF935	v7.1.0.282 (Platform: 5.1.0.246) Bundle 990
2	REY21CW	CER-48923-001 Rev1	297EBD8A	v7.1.0.282 (Platform: 5.1.0.246) Bundle 990
3	REY21CW	CER-48923-001 Rev1	297EC32C	v7.1.0.282 (Platform: 5.1.0.246) Bundle 990
4	REY21CW	CER-48923-001 Rev1	297DF7ED	v7.1.0.282 (Platform: 5.1.0.246) Bundle 990
5	RFD31CW	CER-49832-001 Rev1	297ECFF2	v7.1.0.282 (Platform: 5.1.0.246) Bundle 990
6	RFD31CW	CER-49832-001 Rev1	297ECFA5	v7.1.0.282 (Platform: 5.1.0.246) Bundle 990
7	RFD31CW	CER-49832-001 Rev1	297ECFA3	v7.1.0.282 (Platform: 5.1.0.246) Bundle 990

RF Conducted Emissions testing was performed on samples 1, 2, 5 and 6
RF Radiated Emissions testing was performed on samples 3, 4 and 7.

Only the characteristics that may have been affected by the changes from model REV71UW to REW71UW were re-tested. For more information, see BlackBerrySystemSimilarity_REY21CW_RFD31CW_rev2.

BlackBerry® smartphone Accessories Tested

- 1) Bat. JS1, part number BAT-44582-001.
- 2) Alt. Bat. JS1, part number BAT-44582-002.

D) Support Equipment Used for the Testing of the EUT

No support equipment required; for list of equipment refer to section H, Compliance Test Equipment Used.



Test Report No.: RTS-5994-1203-69A	Dates of Test: February 23 – April 03, 2012	FCC ID: L6AREY20CW FCC ID: L6ARFD30CW	IC: 2503A-REY20CW IC: 2503A-RFD30CW
--	---	--	--

E) Test Results Chart

Part 2.1051 Part 22.917 Part 22.901(d)	RSS-GEN, 4.9	CDMA Cell Conducted Spurious Emissions	Pass	1A
Part 2.1051 Part 24.238(a)	RSS-GEN, 4.9	CDMA PCS Conducted Spurious Emissions	Pass	1A
Part 2.1051 Part 90.210	-	CDMA BC10 Conducted Spurious Emissions	Pass	1B
Part 2.202 Part 22.917	RSS-GEN, 4.6	CDMA Cell Occupied Bandwidth and Channel Mask	Pass	1A
Part 2.202 Part 24.238	RSS-GEN, 4.6	CDMA PCS Occupied Bandwidth and Channel Mask	Pass	1A
Part 2.202 Part 90.691	-	CDMA BC10 Occupied Bandwidth and Channel Mask	Pass	1B
Part 2.1046(a)	RSS-133, 6.4 RSS-132, 4.4	CDMA Conducted RF Output Power	Pass	2
Part 2.1055(a)(d) Part 22.917	RSS-132, 4.3	CDMA Cell Frequency Stability vs. Temperature and Voltage	Pass	3
Part 2.1055(a)(d) Part 24.235	RSS-GEN, 4.7	CDMA PCS Frequency Stability vs. Temperature and Voltage	Pass	3
Part 2.1055(a)(d) Part 90.213	-	CDMA BC10 Frequency Stability vs. Temperature and Voltage	Pass	3
Part 22, Subpart H	RSS-GEN, 4.9	CDMA Cell Radiated Spurious/Harmonic Emissions, ERP	Pass	4
Part 24, Subpart E	RSS-GEN, 4.9	CDMA PCS Radiated Spurious/Harmonic Emissions, EIRP	Pass	4
Part 90, Subpart S	-	CDMA BC10 Radiated Spurious/Harmonic Emissions, EIRP	Pass	4

		EMI Test Report for the BlackBerry® smartphone Model REY21CW, RFD31CW	
Test Report No.: RTS-5994-1203-69A	Dates of Test: February 23 – April 03, 2012	FCC ID: L6AREY20CW FCC ID: L6ARFD30CW	IC: 2503A-REY20CW IC: 2503A-RFD30CW

F) Summary of Results

1) Conducted Emission Measurements

The following test configurations were measured for model REY21CW:

a) The EUT met the requirements of the Conducted Spurious Emissions in the CDMA Cellular band as per 47 CFR 22.917, CFR 22.901(d) and RSS-132. The EUT was measured in Loopback and 1xEVDO mode on the low, middle and high channels. The frequency range investigated was from 10 MHz to 10 GHz. See APPENDIX 1A for the test data.

The BlackBerry® smartphone met the requirements of the Conducted Spurious Emissions in the CDMA PCS band as per 47 CFR 2.1057, CFR 24.238 and RSS-133. The EUT was measured in Loopback and 1xEVDO mode on the low, middle and high channels. The frequency range investigated was from 10 MHz to 20 GHz. See APPENDIX 1A for the test data.

b) The BlackBerry® smartphone met the requirements of the Occupied Bandwidth in the CDMA Cellular band as per 47 CFR 2.202, CFR 22.917 and RSS-132. The EUT was measured in Loopback and 1xEVDO mode on the low, middle and high channels. The worst case occupied bandwidth was 1.280 MHz on the high channel in Loopback mode and 1.280 MHz on middle and high channel in 1xEVDO mode. See APPENDIX 1A for the test data.

The BlackBerry® smartphone met the requirements of the Occupied Bandwidth and channel mask in the CDMA PCS band as per 47 CFR 2.202, CFR 24.238 and RSS-133. The EUT was measured in Loopback and 1xEVDO mode on the low, middle and high channels. The worst case occupied bandwidth was 1.280 MHz on the high channel in Loopback mode and 1.273 MHz on low and middle channels in 1xEVDO mode. See APPENDIX 1A for the test data.

c) The BlackBerry® smartphone met the requirements of the Conducted RF Output Power for both the CDMA Cellular and PCS bands. The EUT was measured in Loopback and 1xEVDO mode on the low, middle and high channels. See APPENDIX 2 for test data.

d) The BlackBerry® smartphone met the requirements of the Frequency Stability vs. Temperature and Voltage for CDMA Cellular band as per 22.917 and RSS-132. The EUT was measured in Cellular mode on the low, middle and high channels. See APPENDIX 3 for test data.

		EMI Test Report for the BlackBerry® smartphone Model REY21CW, RFD31CW	
Test Report No.: RTS-5994-1203-69A	Dates of Test: February 23 – April 03, 2012	FCC ID: L6AREY20CW FCC ID: L6ARFD30CW	IC: 2503A-REY20CW IC: 2503A-RFD30CW

The BlackBerry® smartphone met the requirements of the Frequency Stability vs. Temperature and Voltage requirements for the PCS band as per 24.235 and RSS-133. The EUT was measured in CDMA PCS mode on the low, middle and high channels.

See APPENDIX 3 for test data.

The following test configurations were measured for model RFD31CW:

a) The BlackBerry® smartphone met the requirements of the Conducted Spurious Emissions in the CDMA BC10 as per 47 CFR 2.1051, CFR 90 (J), 90.210, and 90.691. The EUT was measured in BC10 mode on the low, middle and high channels. The frequency range investigated was from 10 MHz to 10 GHz. See APPENDIX 1B for the test data.

The BlackBerry® smartphone met the requirements of the Occupied Bandwidth and channel mask in the CDMA BC10 as per 47 CFR 2.202, and CFR 90 (I). The EUT was measured in Loopback and 1xEVDO mode on the low, middle and high channels. The worst case occupied bandwidth was 1.280 MHz on the middle channel in Loopback mode and 1.280 MHz on high channel in 1xEVDO mode. See APPENDIX 1B for the test data.

b) The BlackBerry® smartphone met the requirements of the Tx Conducted RF output Power requirements in the CDMA BC10 as per 47 CFR 2.1046, and CFR 90.635. The EUT was measured on the low, middle and high channels. See APPENDIX 2 for test data.

c) The BlackBerry® smartphone met the requirements of the Frequency Stability requirements in the CDMA BC10 as per 47 CFR 2.1055, and CFR 90.213. The EUT was measured in CDMA BC10 mode on the low, middle and high channels. See APPENDIX 3 for test data.

2) Radiated Emission Measurements

The following test configurations were measured for model REY21CW:

a) The radiated spurious emissions/harmonics and ERP/EIRP were measured for CDMA Cellular, CDMA PCS and CDMA BC10 bands. The results are within the limits. The BlackBerry® smartphone was placed on a nonconductive styrofoam table, 100 cm high that was positioned on a remotely controlled turntable. The test distance used between the BlackBerry® smartphone and the receiving antenna was three meters. Then the emissions were maximized by elevating the antenna in the range of 1 to 4 meters. The turntable was rotated to determine the azimuth of the

		EMI Test Report for the BlackBerry® smartphone Model REY21CW, RFD31CW	
Test Report No.: RTS-5994-1203-69A	Dates of Test: February 23 – April 03, 2012	FCC ID: L6AREY20CW FCC ID: L6ARFD30CW	IC: 2503A-REY20CW IC: 2503A-RFD30CW

peak emissions. Both the horizontal and vertical polarizations of the emissions were measured. The maximum emissions level was recorded. The BlackBerry® smartphone was then substituted with an antenna placed in the same location as the BlackBerry® smartphone. A Dipole antenna was used for the ERP measurements and a Horn antenna was used for EIRP measurements. The substitution antenna was connected into a signal generator that was set to the test frequency.

The emissions were maximized by elevating the antenna in the range of 1 to 4 meters. The signal generator output was then adjusted to match the BlackBerry® smartphone output reading. The signal generator output was recorded. Both the horizontal and vertical polarizations of the emissions were measured.

The following measurements were done in a semi-anechoic chamber (SAC) below 1 GHz and a Semi-anechoic Chamber ((SAC) with floor absorber) above 1 GHz. The SAC's FCC registration number is **778487** and the Industry Canada (IC) file number is **2503B-1**. The SAC with floor absorber's FCC registration number is **959115** and the IC file number is **2503C-1**. The BlackBerry® smartphone was measured on the low, middle and high channels.

The highest ERP measured in the Cellular band, Loopback Service mode, was 25.65 dBm (0.37 W) at 848.32 MHz (channel 777).

The highest ERP measured in the Cellular band, 1xEVDO mode, was 26.96 dBm (0.50 W) at 824.70 MHz (channel 1013).

The highest EIRP measured in the PCS band, Loopback Service mode, was 27.30 dBm (0.54 W) at 1880.00 MHz (channel 600).

The highest EIRP measured in the PCS band, 1xEVDO mode, was 27.13 dBm (0.52 W) at 1880.00 MHz (channel 600).

The radiated carrier harmonics were measured up to the 10th harmonic for low, middle and high channels in the Cellular, PCS and BC10 bands. Each band was measured in Call, and EVDO modes, with both the horizontal and vertical polarizations.

All test margins in the CDMA Cellular band harmonic emissions were greater than 25 dB below the accepted limits for all test frequencies.

All test margins in the CDMA PCS band harmonic emissions were greater than 25 dB below the accepted limits for all test frequencies.

		EMI Test Report for the BlackBerry® smartphone Model REY21CW, RFD31CW	
Test Report No.: RTS-5994-1203-69A	Dates of Test: February 23 – April 03, 2012	FCC ID: L6AREY20CW FCC ID: L6ARFD30CW	IC: 2503A-REY20CW IC: 2503A-RFD30CW

The following test configurations were measured for model RFD31CW:

The highest EIRP measured in the BC10 band, Loopback Service mode, was 28.37 dBm (0.69 W) at 820.50 MHz (channel 580).

The highest EIRP measured in the BC10 band, 1xEVDO mode, was 28.21 dBm (0.66 W) at 820.50 MHz (channel 580).

The radiated carrier harmonics were measured up to the 10th harmonic for low, middle and high channels in the Cellular, PCS and BC10 bands. Each band was measured in Call, and EVDO modes, with both the horizontal and vertical polarizations.

All test margins in the CDMA BC10 band harmonic emissions were greater than 25 dB below the accepted limits for all test frequencies.

b) Co-Location Measurements

The radiated emissions were measured up to 18 GHz for middle channels for simultaneous transmission in the following test configuration combinations:

- CDMA CELL + Bluetooth + 802.11b.
- CDMA PCS + Bluetooth + 802.11g.

Both the horizontal and vertical polarizations were measured. The emissions due to different simultaneous transmission did not increase the amplitude of any emissions nor did it produce any new inter-modulation products as a result of mixing.

Sample Calculation:

Corrected Signal level (CSL) is calculated as follows:

$$\text{CSL (dBm)} = \text{Measured Level (dB}\mu\text{V)} - \text{Antenna Gain (dBi)} + \text{Free Space loss (dB)} - 107(\text{dB}) + \text{Cable Loss (dB)} - \text{Preamp (dB)} + \text{Filter Loss (dB)} - 2.15(\text{dB})$$

See APPENDIX 4 and 4 for test data.

Measurement Uncertainty ±4.6 dB



Test Report No.:
RTS-5994-1203-69A

Dates of Test:
February 23 – April 03, 2012

FCC ID: L6AREY20CW
FCC ID: L6ARFD30CW

IC: 2503A-REY20CW
IC: 2503A-RFD30CW

H) Compliance Test Equipment Used

<u>UNIT</u>	<u>MANUFACTURER</u>	<u>MODEL</u>	<u>SERIAL NUMBER</u>	<u>CAL DUE DATE</u> (YY MM DD)	<u>USE</u>
Preamplifier	Sonoma	310N/11909A	185831	12-10-17	Radiated Emissions
Preamplifier system	TDK RF Solutions	PA-02	080010	12-10-17	Radiated Emissions
Preamplifier	Rohde & Schwarz	TS-ANA4-SP	001	12-09-01	Radiated Emissions
Preamplifier	Rohde & Schwarz	TS-ANA-SP	001	12-09-01	Radiated Emissions
Hybrid Log Antenna	EMC Automation	HLP-3003C	017301	13-08-23	Radiated Emissions
Horn Antenna	EMC Automation	HRN-0118	030101	12-07-20	Radiated Emissions
Horn Antenna	EMC Automation	HRN-0118	030201	12-09-22	Radiated Emissions
Horn Antenna	Emco	3117	47563	13-08-04	Radiated Emissions
Horn Antenna	ETS	3116	2538	12-09-24	Radiated Emissions
Dipole Antenna	Schwarzbeck	UHAP	1013	12-04-21	Radiated Emissions
Dipole Antenna	Schwarzbeck	UHAP	974	12-11-08	Radiated Emissions
Universal Radio Communication Tester	Rohde & Schwarz	CMU 200	837493/073	12-11-30	Radiated Emissions
Universal Radio Communication Tester	Rohde & Schwarz	CMU 200	112394	12-11-21	Radiated Emissions
Universal Radio Communication Tester	Rohde & Schwarz	CMU 200	109747	12-11-20	RF Conducted Emissions
EMI Receiver	Rohde & Schwarz	ESIB-40	100255	12-12-08	Radiated Emissions
EMI Receiver	Rohde & Schwarz	ESU-40	100162	12-12-07	Radiated Emissions
Spectrum Analyzer	HP	8563E	3745A08112	13-10-05	RF Conducted Emissions
DC Power Supply	HP	6632B	US37472178	12-09-27	RF Conducted Emissions
Environment Monitor	Omega	iTHX-SD	0380561	12-10-20	Radiated Emissions



EMI Test Report for the BlackBerry® smartphone Model REY21CW, RFD31CW

Test Report No.:
RTS-5994-1203-69A

Dates of Test:
February 23 – April 03, 2012

FCC ID: L6AREY20CW
FCC ID: L6ARFD30CW

IC: 2503A-REY20CW
IC: 2503A-RFD30CW

Compliance Test Equipment Used cont'd

<u>UNIT</u>	<u>MANUFACTURER</u>	<u>MODEL</u>	<u>SERIAL NUMBER</u>	<u>CAL DUE DATE</u> (YY MM DD)	<u>USE</u>
Environment Monitor	Omega	iTHX-SD	0340060	12-10-20	RF Conducted Emissions
Environment Monitor	Omega	iTHX-SD	0380567	12-10-20	Radiated Emissions
Signal Generator	Agilent	E8257D	MY45140527	12-11-18	Radiated Emissions
Signal Generator	Agilent	83630B	3844A00927	12-10-28	Radiated Emissions

APPENDIX 1A – CDMA CELL and PCS bands CONDUCTED RF EMISSIONS TEST
DATA/PLOTS

Test Report No.: RTS-5994-1203-69A	Dates of Test: February 23 – April 03, 2012	FCC ID: L6AREY20CW FCC ID: L6ARFD30CW	IC: 2503A-REY20CW IC: 2503A-RFD30CW
--	---	--	--

CDMA Conducted RF Emission Test Data

The following test configurations were measured for model REY21CW:

This appendix contains measurement data pertaining to conducted spurious emissions, 99% power bandwidth and the channel mask.

Test Setup Diagram

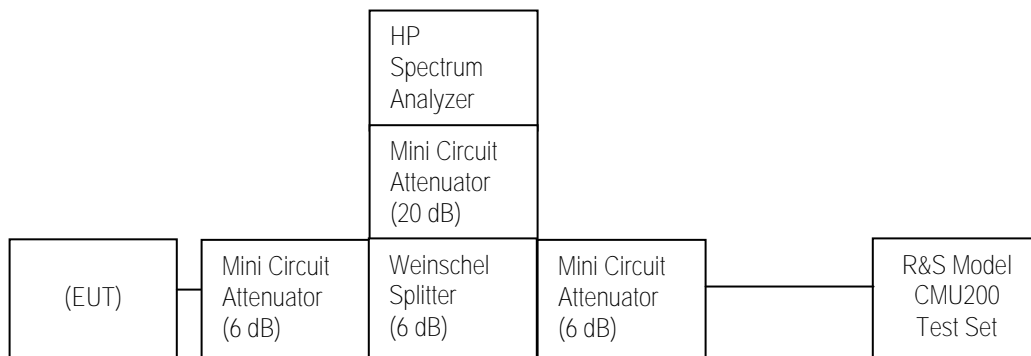

The environmental test conditions were: Temperature: 25.5 °C
Relative Humidity: 34.4 %



Test Report No.:
 RTS-5994-1203-69A

Dates of Test:
 February 23 – April 03, 2012

FCC ID: L6AREY20CW IC: 2503A-REY20CW
 FCC ID: L6ARFD30CW IC: 2503A-RFD30CW

CDMA Conducted RF Emission Test Data cont'd

The conducted spurious emissions – As per 47 CFR 2.1051, CFR 24.238(a), CFR 4.202, CFR 22 Subpart H, RSS-132 and RSS - 133 were measured from 10 MHz to 20 GHz.
 Date of Test: March 12, 2012

Test Data for Cellular and PCS selected Frequencies in Loopback mode

Cellular Frequency (MHz)	99% Occupied Bandwidth (MHz)
824.700	1.273
836.520	1.273
848.310	1.280

PCS Frequency (MHz)	99% Occupied Bandwidth (MHz)
1851.200	1.267
1880.000	1.267
1908.750	1.280

Test Data for Cellular and PCS selected Frequencies in Loopback mode

Refer to the following measurement plots for more detail.

See Figures 1-1 to 1-12 for the plots of the conducted spurious emissions.

See Figures 1-13 to 1-18 for the plots of 99% Occupied Bandwidth.

See Figures 1-19 to 1-24 for the plots of the Channel mask.

The RF power output was at maximum for all the recorded measurements shown below.

Test Report No.:
 RTS-5994-1203-69A

Dates of Test:
 February 23 – April 03, 2012

FCC ID: L6AREY20CW
 FCC ID: L6ARFD30CW

IC: 2503A-REY20CW
 IC: 2503A-RFD30CW

CDMA Conducted RF Emission Test Data cont'd

Figure 1-1: Cellular, Spurious Conducted Emissions, Low channel

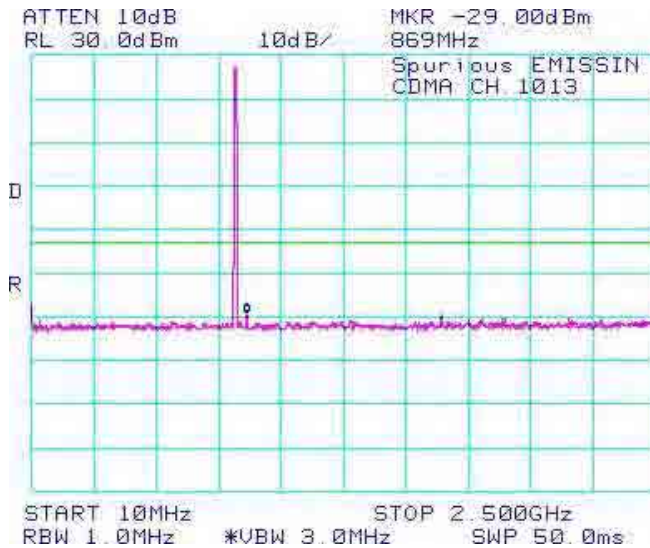

Figure 1-2: Cellular, Spurious Conducted Emissions, Low channel

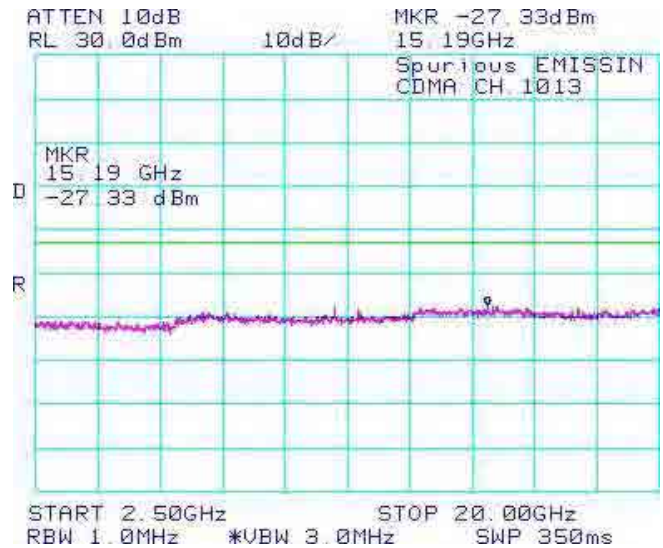

Figure 1-3: Cellular, Spurious Conducted Emissions, Middle channel

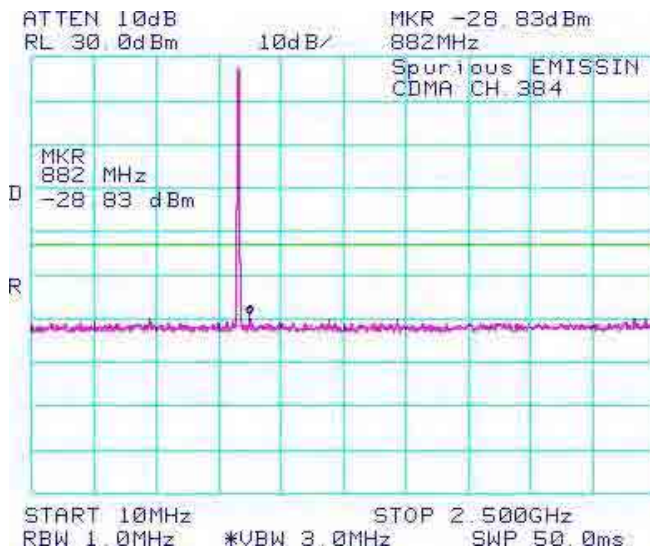
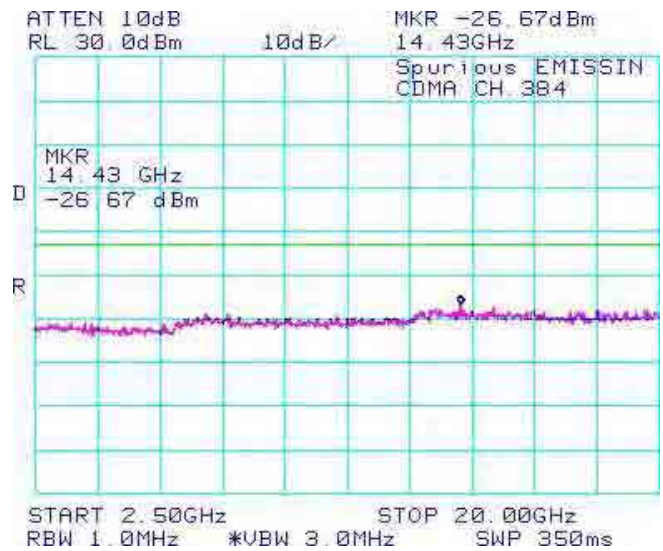

Figure 1-4: Cellular, Spurious Conducted Emissions, Middle channel



Test Report No.:
 RTS-5994-1203-69A

Dates of Test:
 February 23 – April 03, 2012

FCC ID: L6AREY20CW
 FCC ID: L6ARFD30CW

IC: 2503A-REY20CW
 IC: 2503A-RFD30CW

CDMA Conducted RF Emission Test Data cont'd

Figure 1-5: Cellular, Spurious Conducted Emissions, High Channel

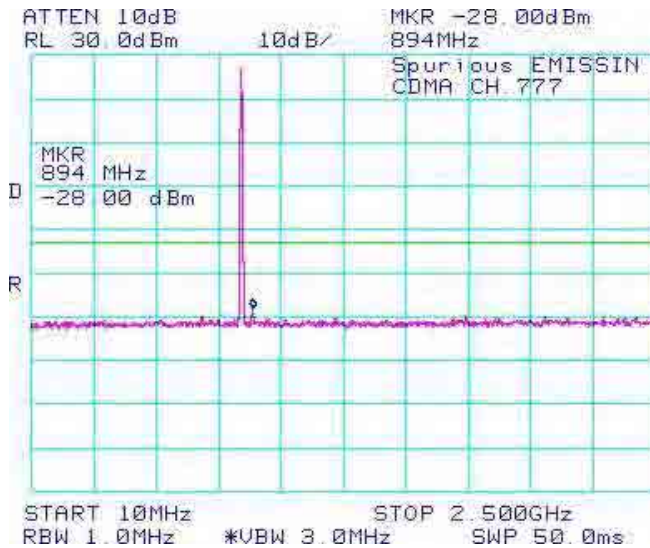

Figure 1-6: Cellular, Spurious Conducted Emissions, High Channel

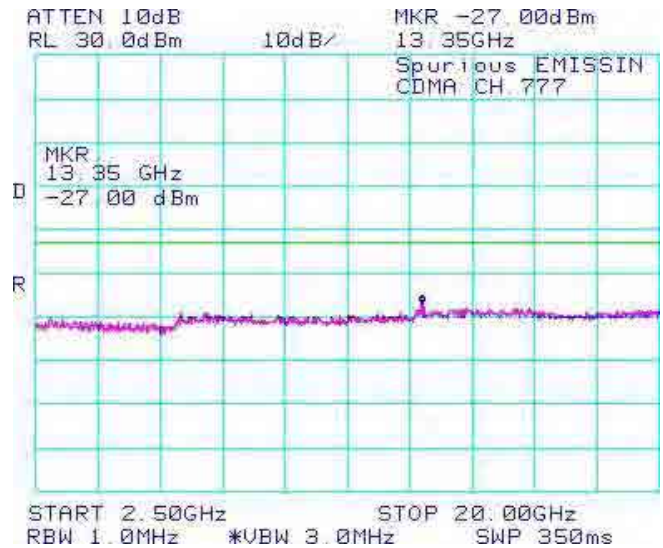

Figure 1-7: PCS, Spurious Conducted Emissions, Low Channel

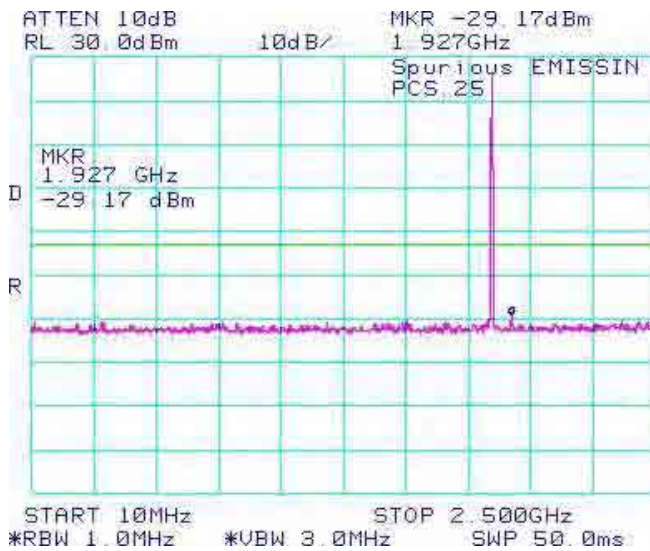
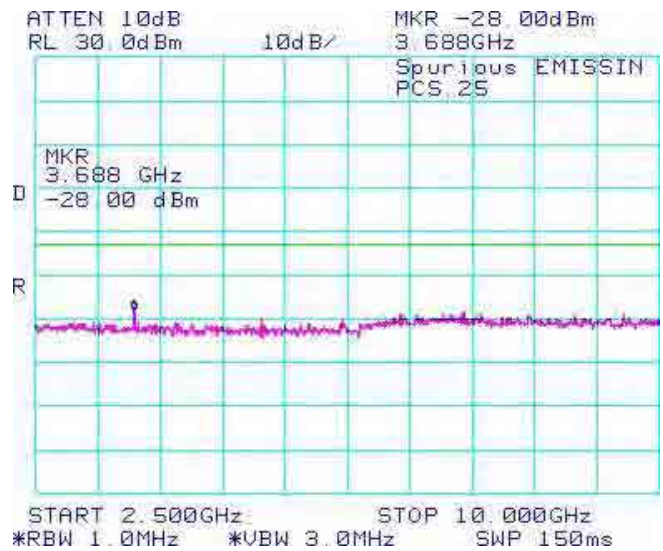

Figure 1-8: PCS, Spurious Conducted Emissions, Low Channel



Test Report No.:
 RTS-5994-1203-69A

Dates of Test:
 February 23 – April 03, 2012

FCC ID: L6AREY20CW
 FCC ID: L6ARFD30CW

IC: 2503A-REY20CW
 IC: 2503A-RFD30CW

CDMA Conducted RF Emission Test Data cont'd

Figure 1-9: PCS, Spurious Conducted Emissions, Middle Channel

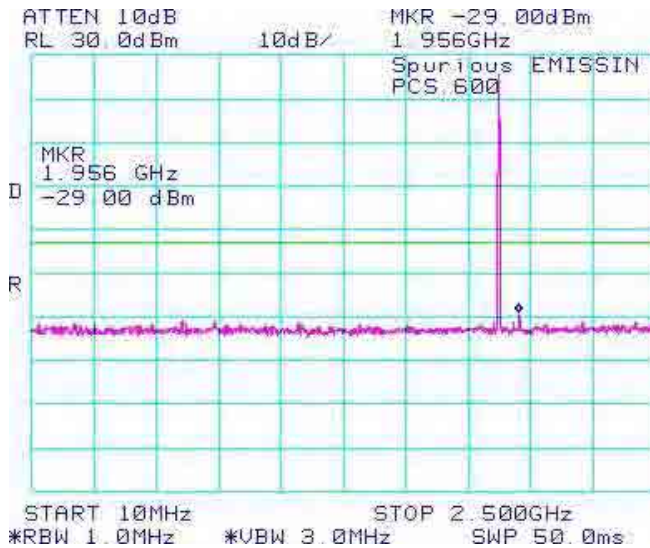

Figure 1-10: PCS, Spurious Conducted Emissions, Middle Channel

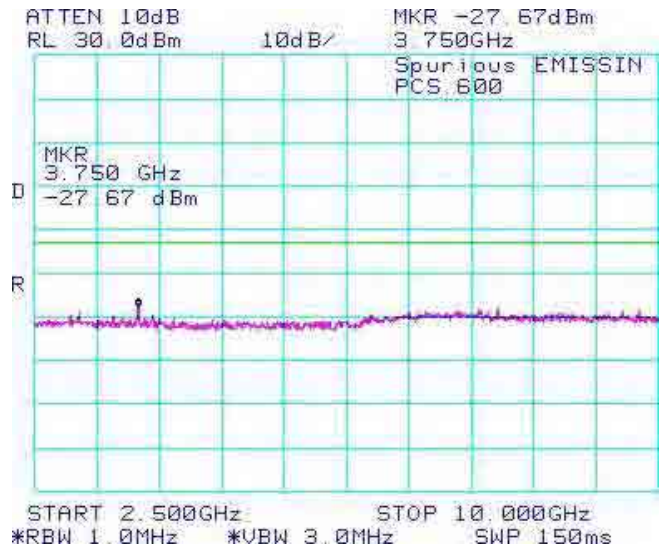

Figure 1-11: PCS, Spurious Conducted Emissions, High Channel

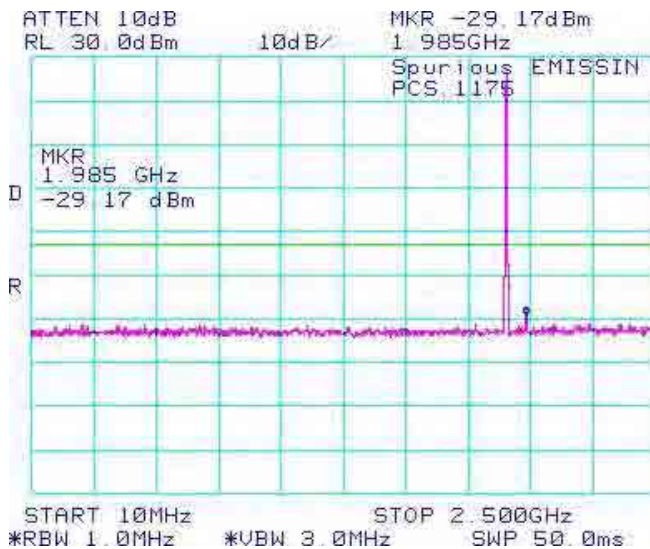
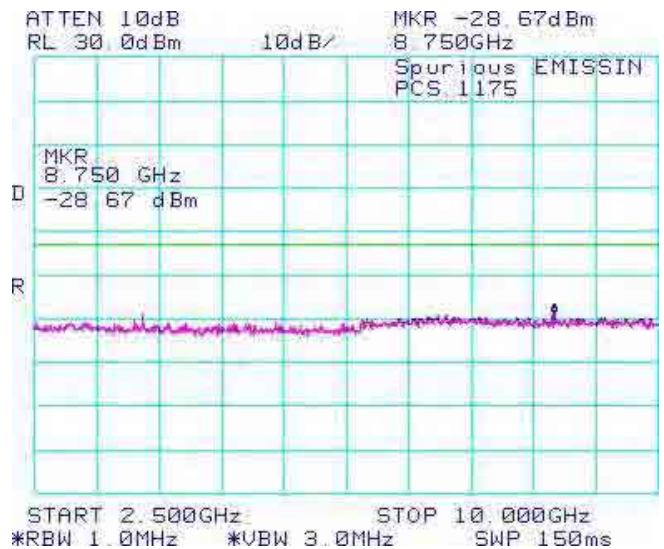

Figure 1-12: PCS, Spurious Conducted Emissions, High Channel



Test Report No.:
 RTS-5994-1203-69A

Dates of Test:
 February 23 – April 03, 2012

FCC ID: L6AREY20CW
 FCC ID: L6ARFD30CW

IC: 2503A-REY20CW
 IC: 2503A-RFD30CW

CDMA Conducted RF Emission Test Data cont'd

Figure 1-13: Occupied Bandwidth, Cellular Low Channel

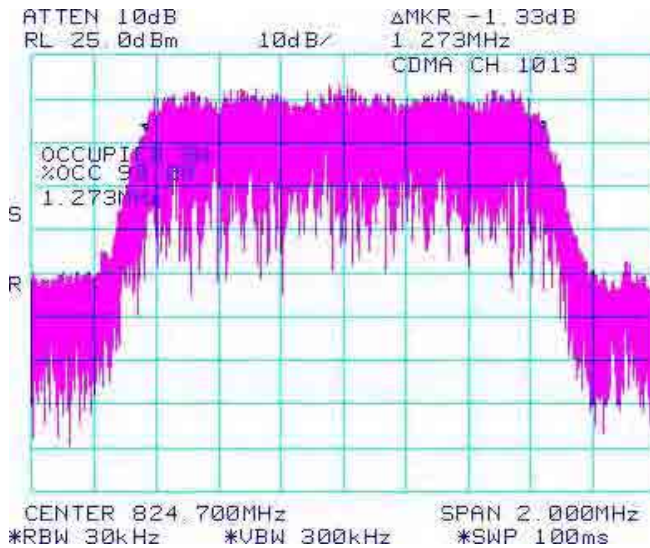

Figure 1-14: Occupied Bandwidth, Cellular Middle Channel

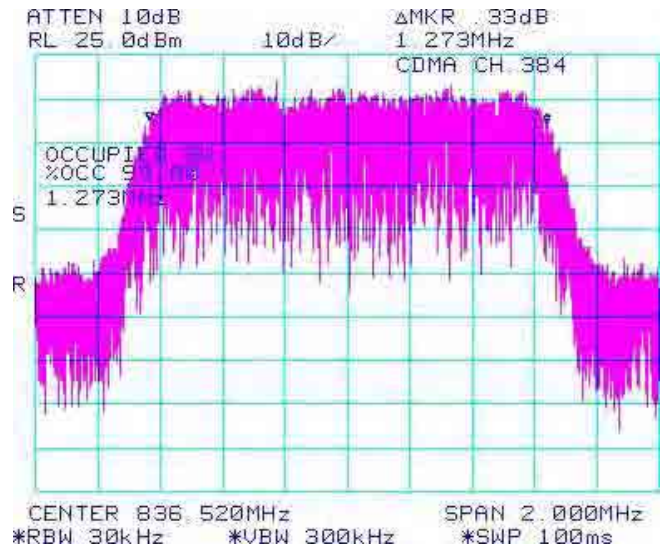

Figure 1-15: Occupied Bandwidth, Cellular High Channel

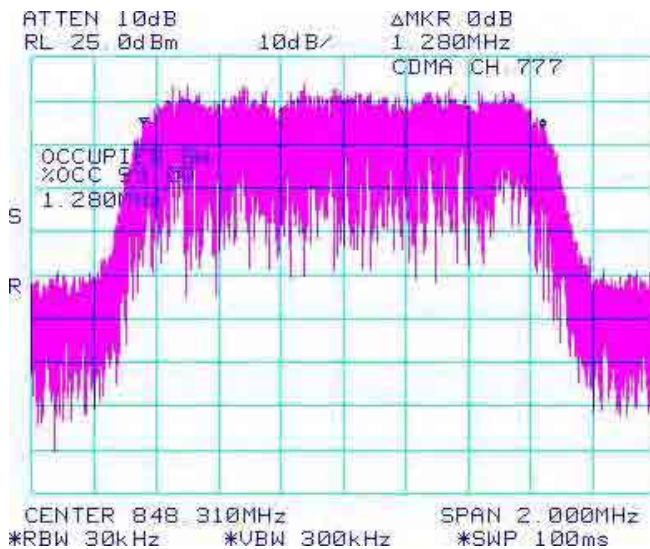
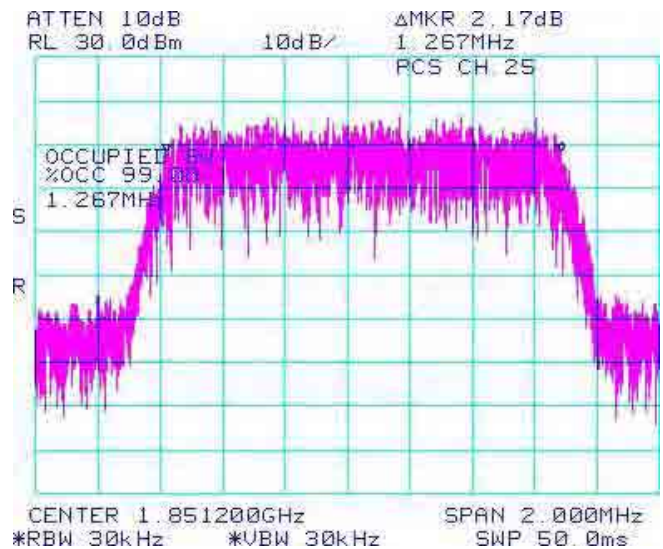

Figure 1-16: Occupied Bandwidth, PCS Low Channel



Test Report No.:
 RTS-5994-1203-69A

Dates of Test:
 February 23 – April 03, 2012

FCC ID: L6AREY20CW
 FCC ID: L6ARFD30CW

IC: 2503A-REY20CW
 IC: 2503A-RFD30CW

CDMA Conducted RF Emission Test Data cont'd

Figure 1-17: Occupied Bandwidth, PCS Middle Channel

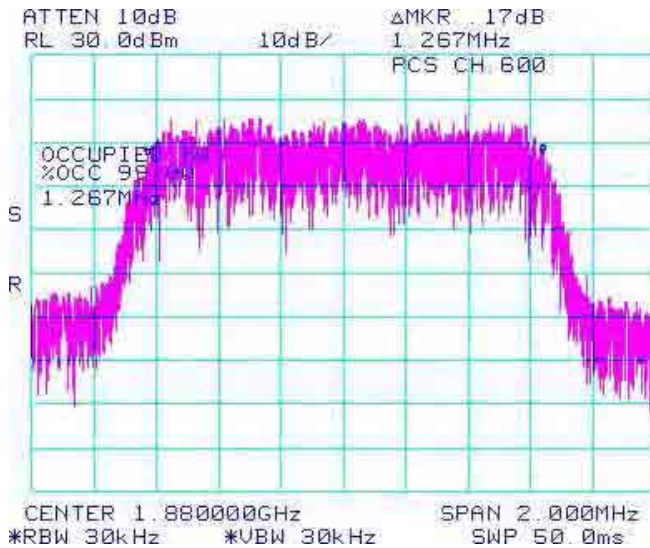

Figure 1-18: Occupied Bandwidth, PCS High Channel

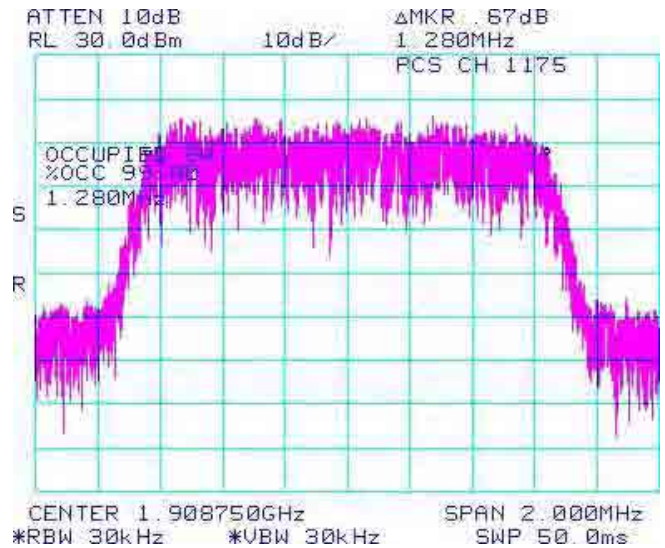

Figure 1-19: Cellular Low Channel Mask

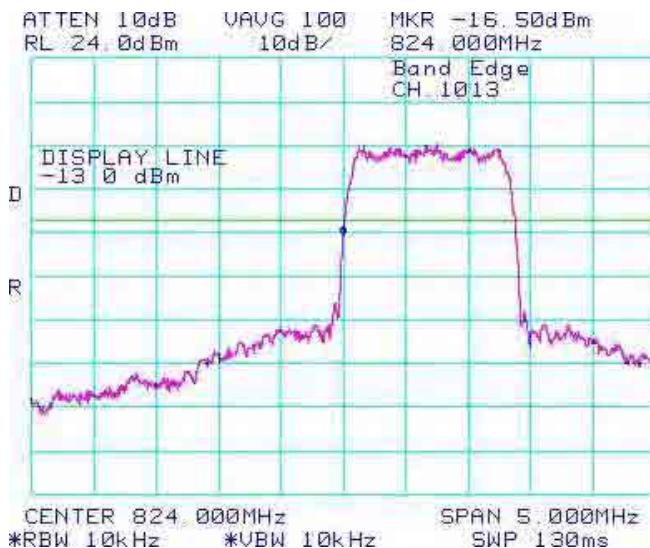
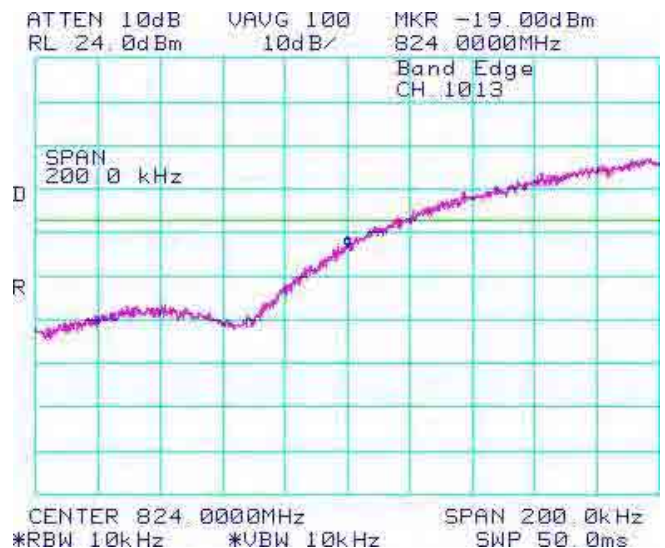

Figure 1-20: Cellular Low Channel Mask



Test Report No.:
 RTS-5994-1203-69A

Dates of Test:
 February 23 – April 03, 2012

FCC ID: L6AREY20CW
 FCC ID: L6ARFD30CW

IC: 2503A-REY20CW
 IC: 2503A-RFD30CW

CDMA Conducted RF Emission Test Data cont'd

Figure 1-21: Cellular High Channel Mask

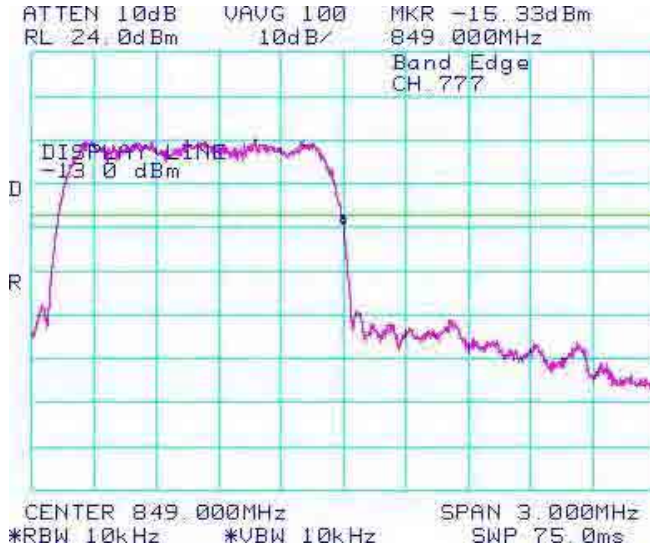

Figure 1-22: Cellular High Channel Mask

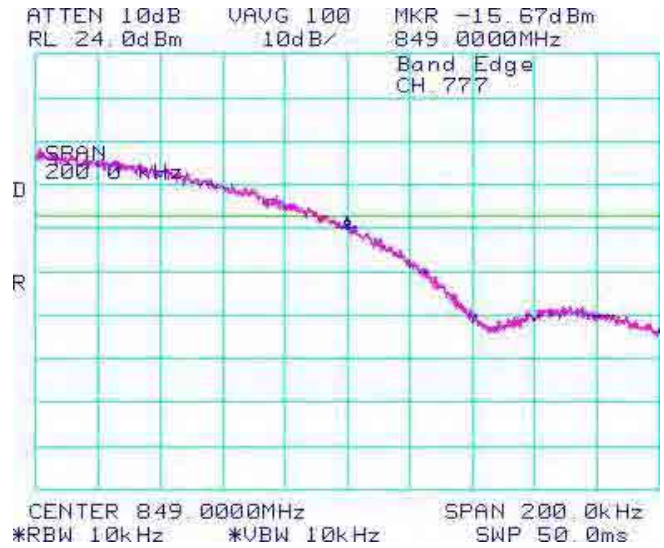

Figure 1-23: PCS Low Channel Mask

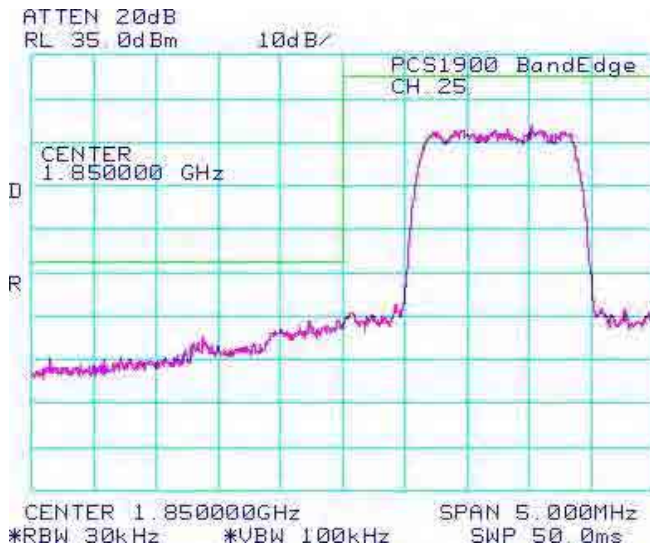
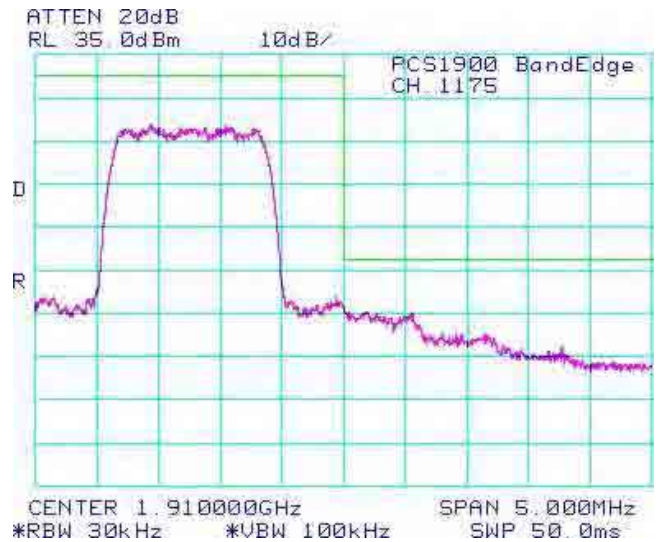

Figure 1-24: PCS High Channel Mask



Test Report No.:
 RTS-5994-1203-69A

Dates of Test:
 February 23 – April 03, 2012

FCC ID: L6AREY20CW
 FCC ID: L6ARFD30CW

IC: 2503A-REY20CW
 IC: 2503A-RFD30CW

CDMA EVDO Conducted RF Emission Test Data cont'd

Figure 1-25: Cellular , Spurious Conducted Emissions, Low channel

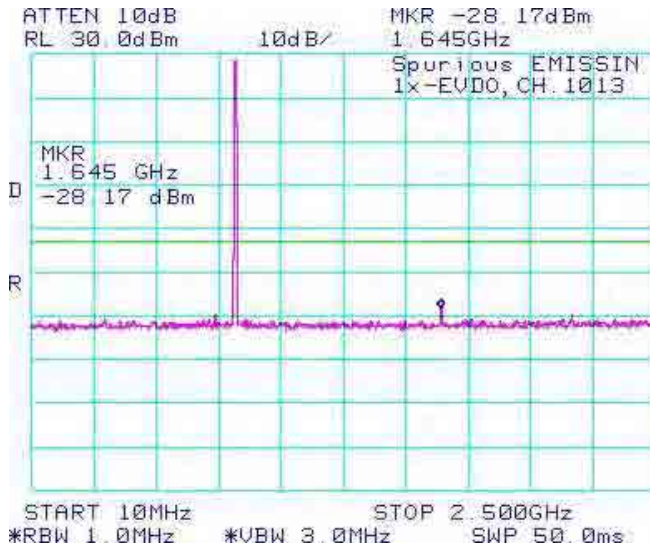

Figure 1-26: Cellular , Spurious Conducted Emissions, Low channel



Figure 1-27: Cellular , Spurious Conducted Emissions, Middle channel

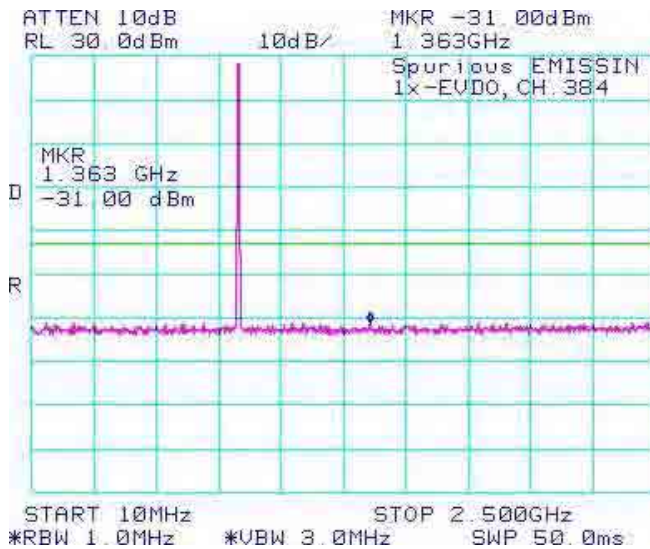
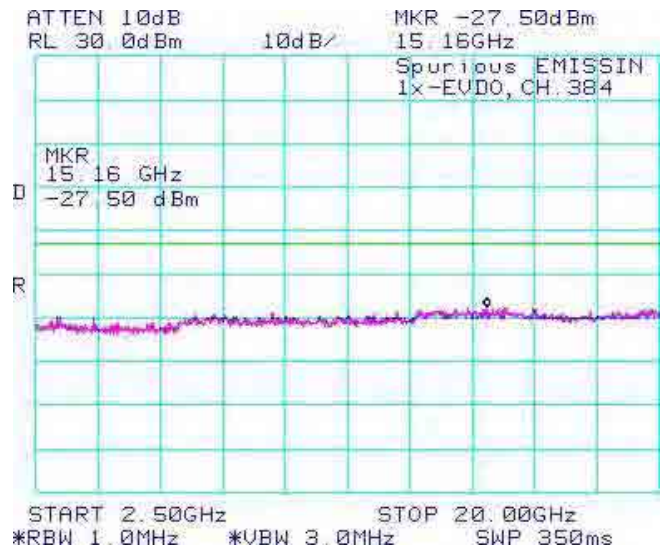

Figure 1-28: Cellular , Spurious Conducted Emissions, Middle channel



Test Report No.:
 RTS-5994-1203-69A

Dates of Test:
 February 23 – April 03, 2012

FCC ID: L6AREY20CW
 FCC ID: L6ARFD30CW

IC: 2503A-REY20CW
 IC: 2503A-RFD30CW

CDMA Conducted RF Emission Test Data cont'd

Figure 1-29: Cellular , Spurious Conducted Emissions, High Channel

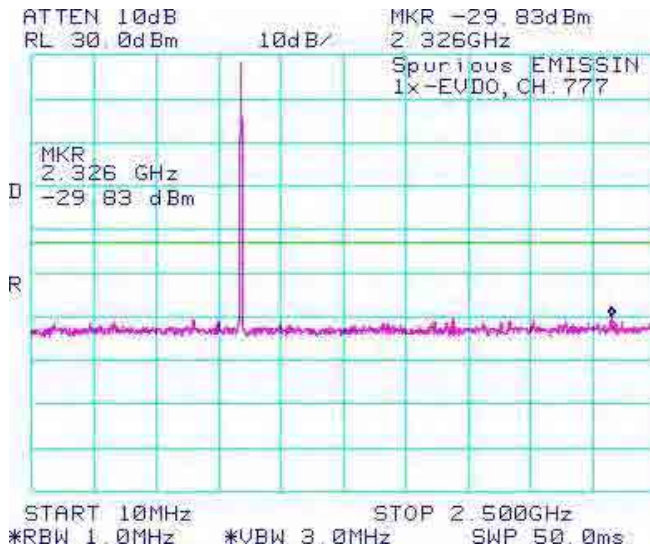

Figure 1-30: Cellular , Spurious Conducted Emissions, High Channel

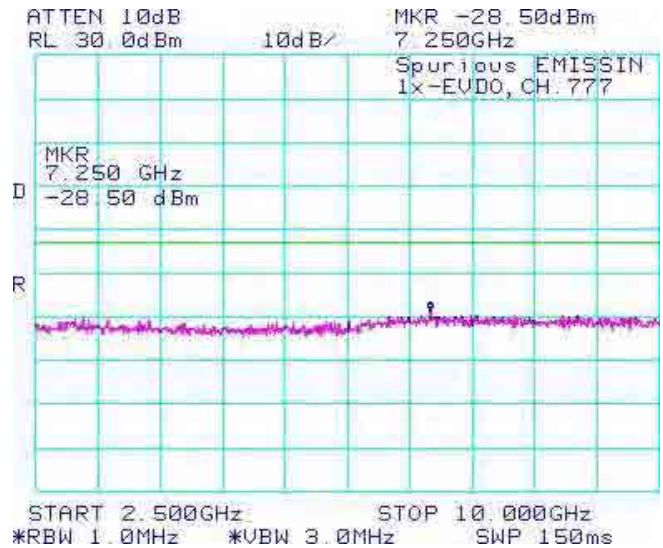

Figure 1-31: CDMA PCS, Spurious Conducted Emissions, Low Channel

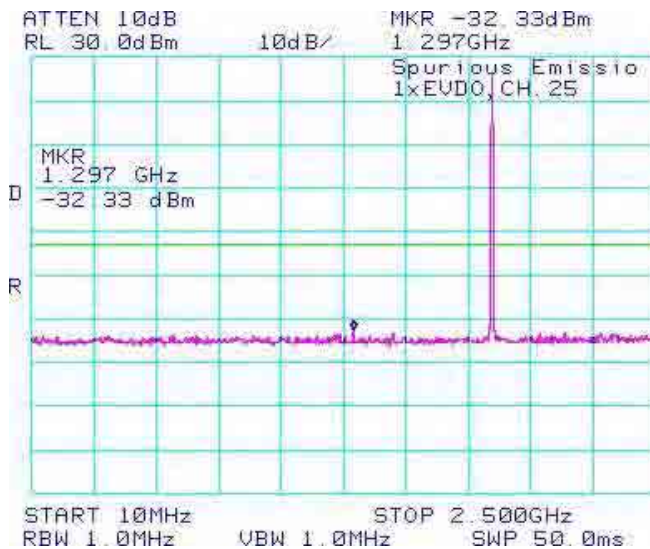
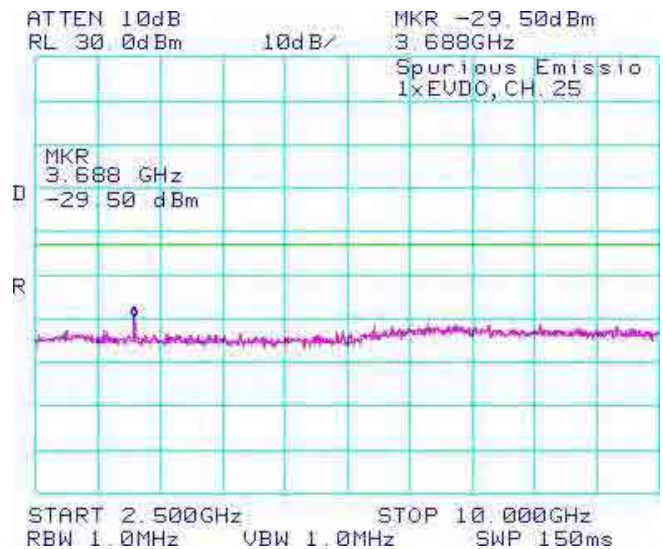

Figure 1-32: CDMA PCS, Spurious Conducted Emissions, Low Channel



Test Report No.:
 RTS-5994-1203-69A

Dates of Test:
 February 23 – April 03, 2012

FCC ID: L6AREY20CW
 FCC ID: L6ARFD30CW

IC: 2503A-REY20CW
 IC: 2503A-RFD30CW

CDMA Conducted RF Emission Test Data cont'd

Figure 1-33: CDMA PCS, Spurious Conducted Emissions, Middle Channel

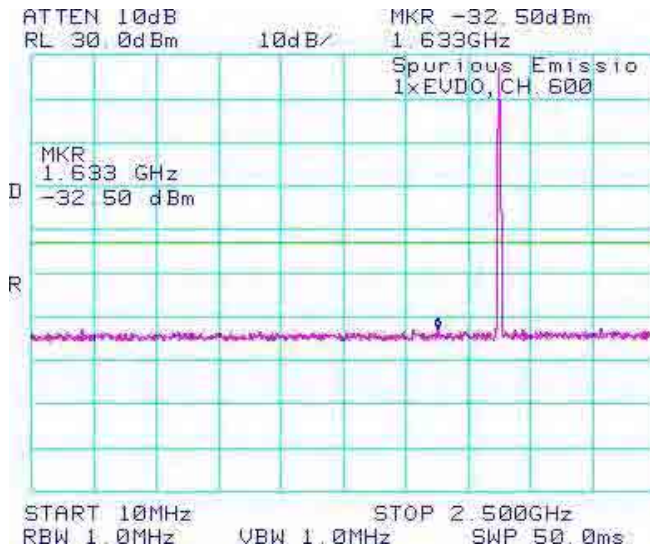

Figure 1-34: CDMA PCS, Spurious Conducted Emissions, Middle Channel

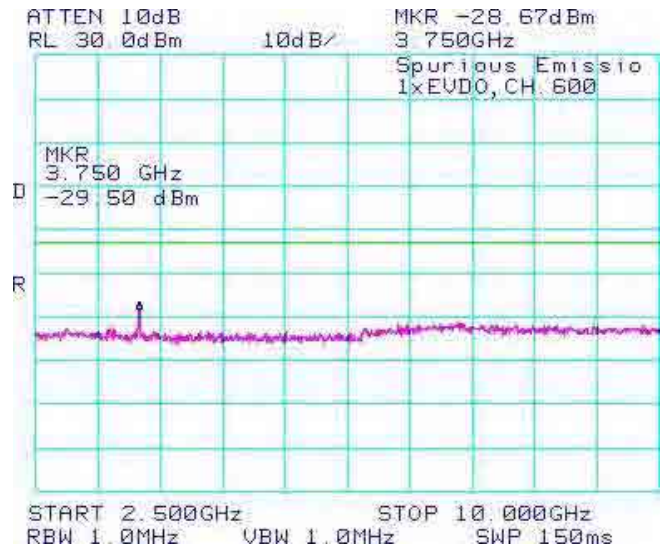

Figure 1-35: CDMA PCS, Spurious Conducted Emissions, High Channel

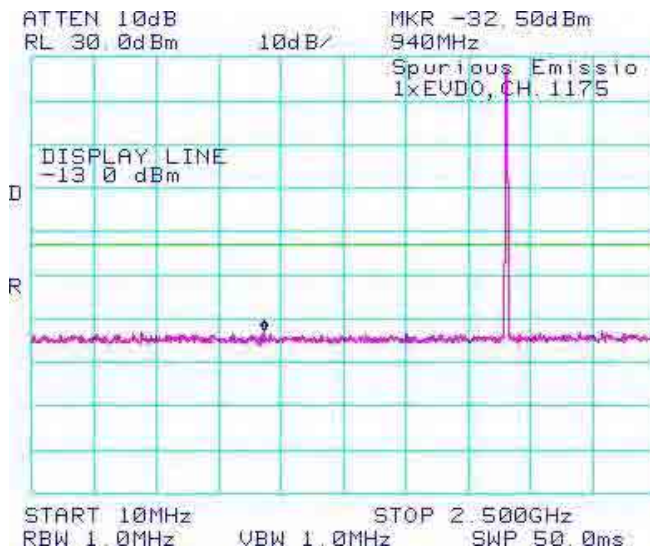
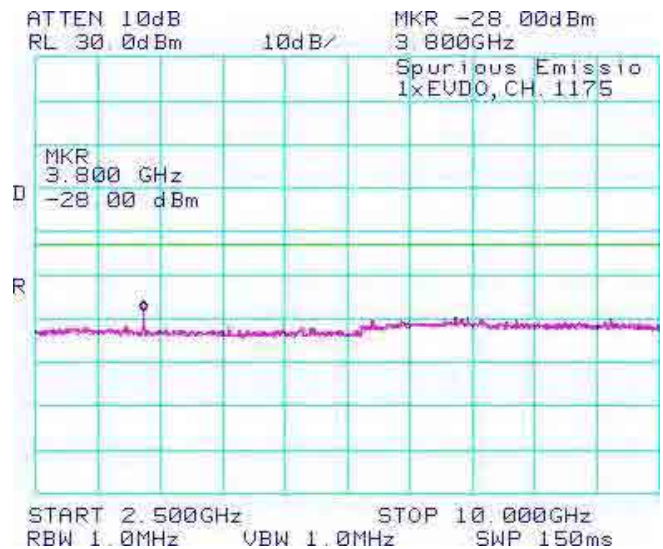

Figure 1-36: CDMA PCS, Spurious Conducted Emissions, High Channel



Test Report No.:
 RTS-5994-1203-69A

Dates of Test:
 February 23 – April 03, 2012

FCC ID: L6AREY20CW
 FCC ID: L6ARFD30CW

IC: 2503A-REY20CW
 IC: 2503A-RFD30CW

CDMA Conducted RF Emission Test Data cont'd

Figure 1-37: Occupied Bandwidth, Cellular Low Channel

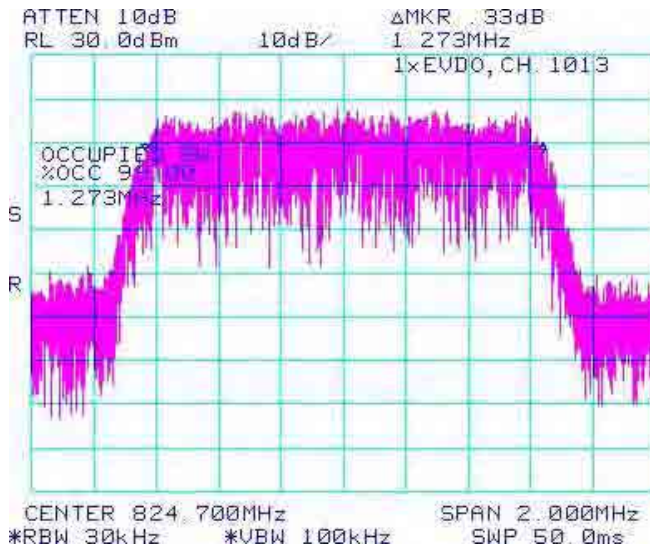

Figure 1-38: Occupied Bandwidth, Cellular Middle Channel

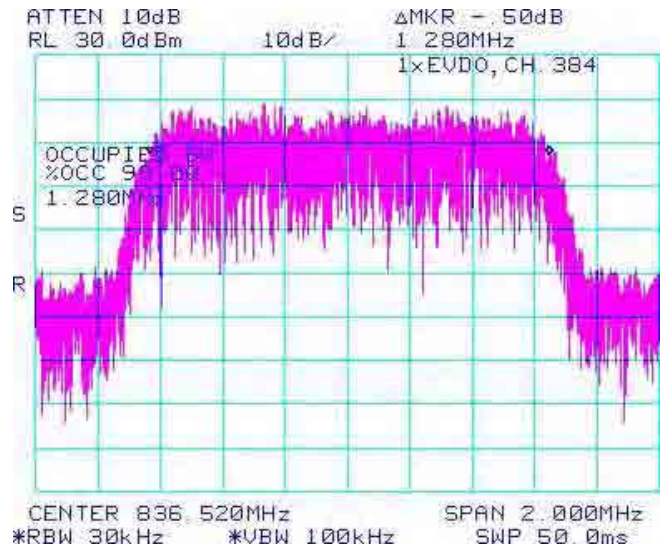

Figure 1-39: Occupied Bandwidth, Cellular High Channel

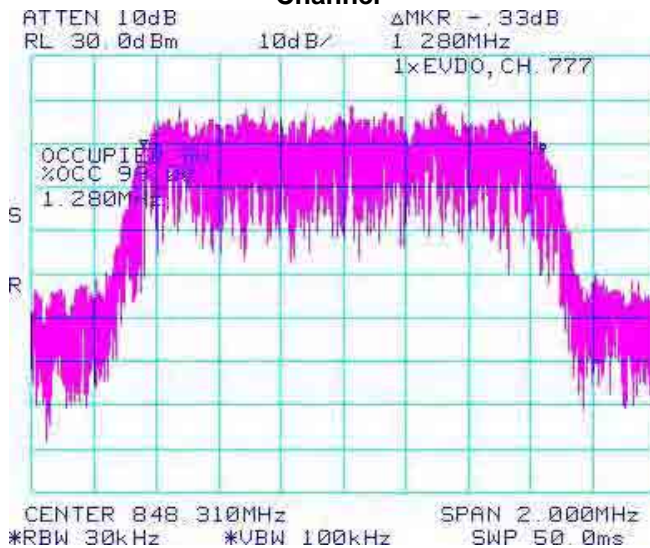
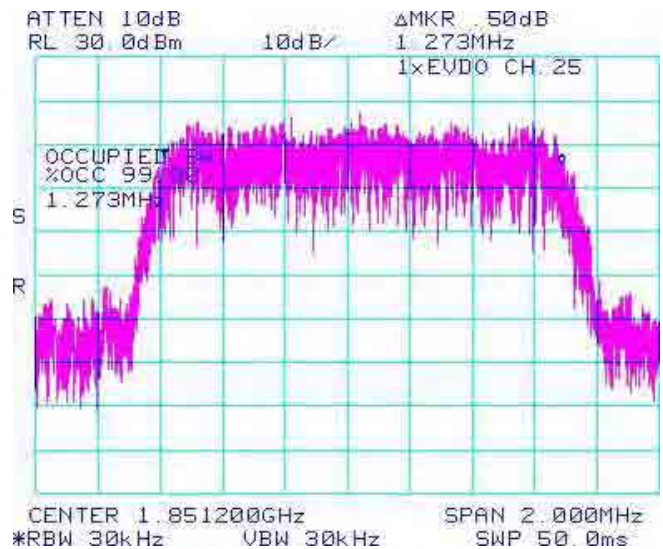

Figure 1-40: Occupied Bandwidth, PCS Low Channel



Test Report No.:
 RTS-5994-1203-69A

Dates of Test:
 February 23 – April 03, 2012

FCC ID: L6AREY20CW
 FCC ID: L6ARFD30CW

IC: 2503A-REY20CW
 IC: 2503A-RFD30CW

CDMA Conducted RF Emission Test Data cont'd

Figure 1-41: Occupied Bandwidth, PCS Middle Channel

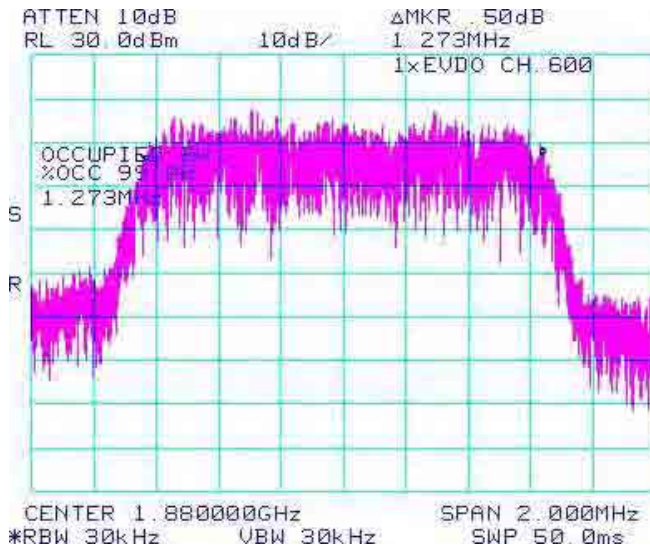

Figure 1-42: Occupied Bandwidth, PCS High Channel

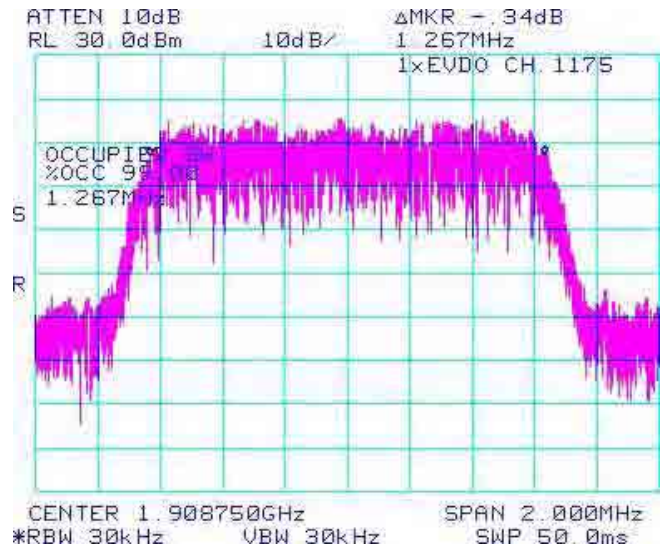

Figure 1-43: Cellular , Low Channel Mask

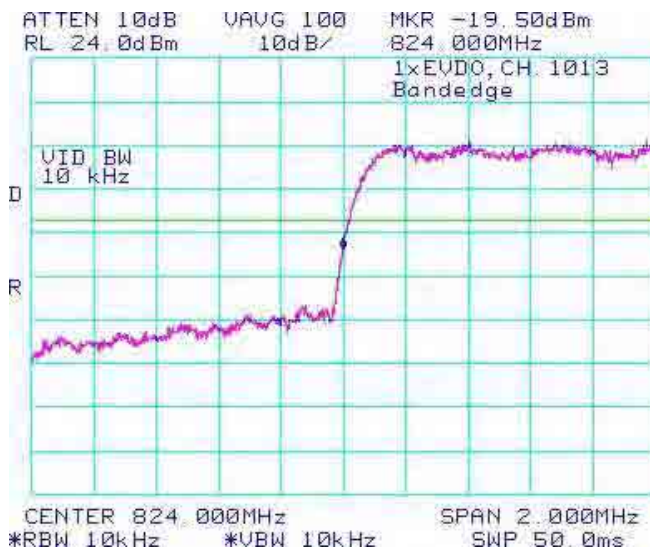
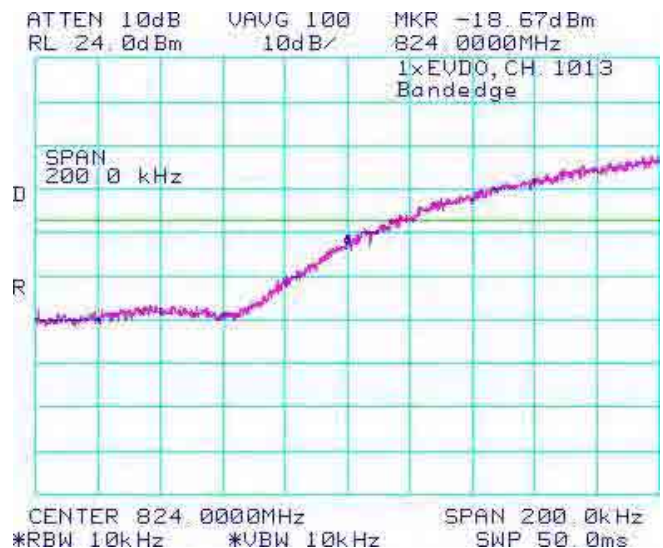

Figure 1-44: Cellular , Low Channel Mask



Test Report No.:
 RTS-5994-1203-69A

Dates of Test:
 February 23 – April 03, 2012

FCC ID: L6AREY20CW
 FCC ID: L6ARFD30CW

IC: 2503A-REY20CW
 IC: 2503A-RFD30CW

CDMA Conducted RF Emission Test Data cont'd

Figure 1-45: Cellular , High Channel Mask

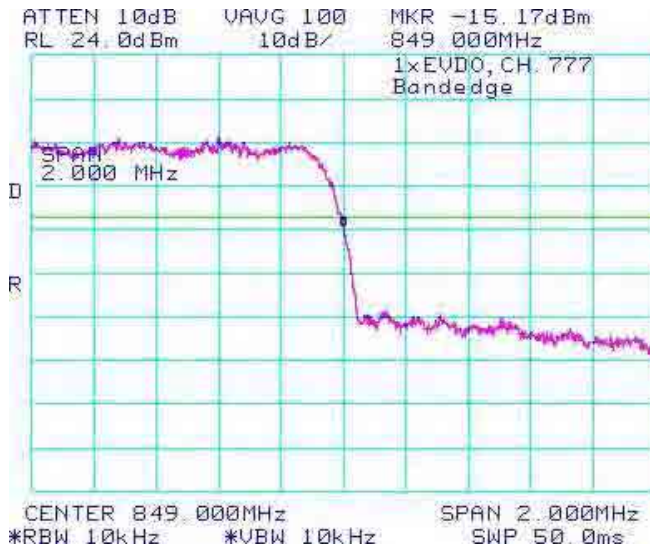

Figure 1-46: Cellular , High Channel Mask

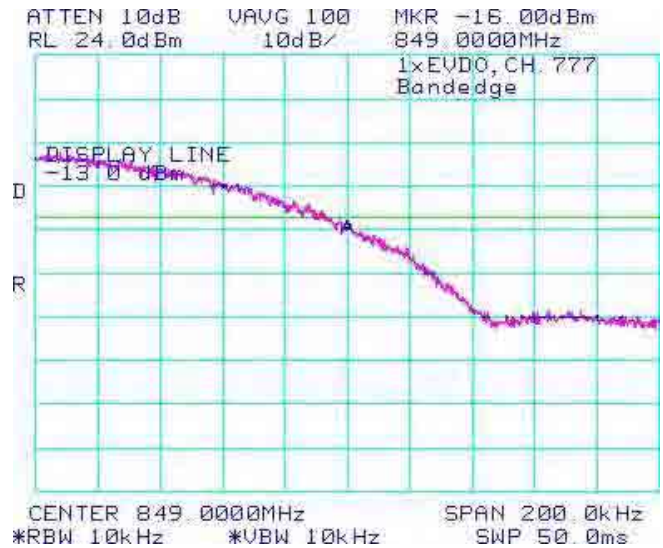

Figure 1-47: PCS , Low Channel Mask

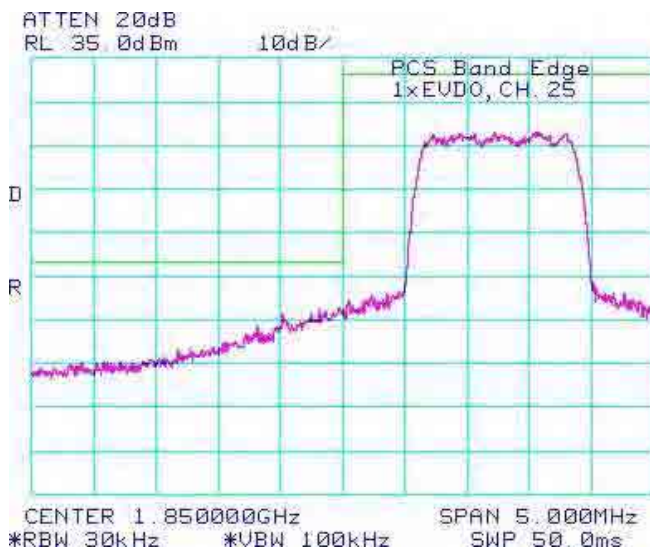
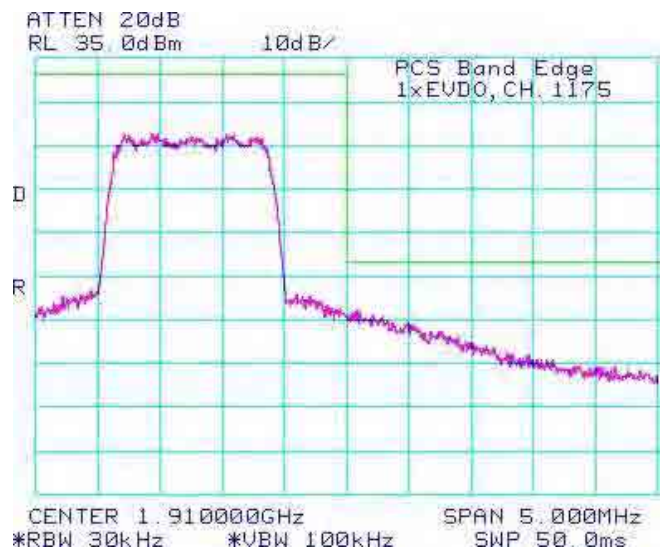



Figure 1-48: PCS , High Channel Mask



APPENDIX 1B – CDMA BC10 CONDUCTED RF EMISSIONS TEST DATA/PLOTS

	EMI Test Report for the BlackBerry® smartphone Model REY21CW, RFD31CW		
	APPENDIX 1B		
Test Report No.: RTS-5994-1203-69A	Dates of Test: February 23 – April 03, 2012	FCC ID: L6AREY20CW FCC ID: L6ARFD30CW	IC: 2503A-REY20CW IC: 2503A-RFD30CW

CDMA BC10 Conducted RF Emission Test Data

The following test configurations were measured for model RFD31CW:

This appendix contains measurement data pertaining to conducted spurious emissions, 99% power bandwidth and the channel mask on BlackBerry® smartphone.

Test Setup Diagram

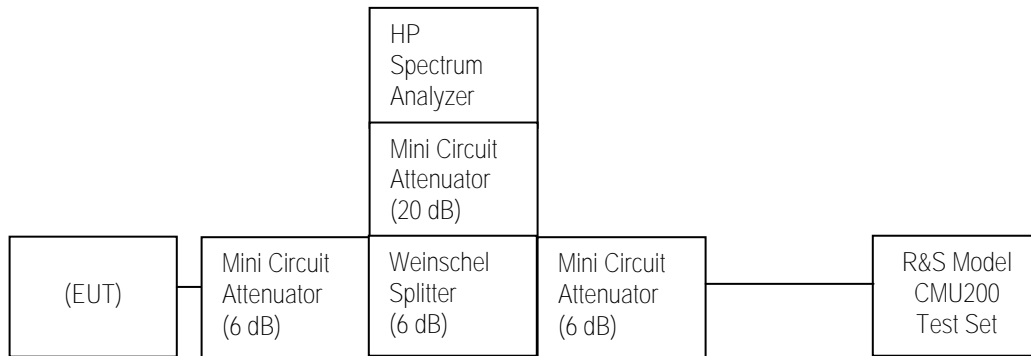

The environmental test conditions were:

Temperature: 24.5 °C
Relative Humidity: 37.0 %

	EMI Test Report for the BlackBerry® smartphone Model REY21CW, RFD31CW APPENDIX 1B		
Test Report No.: RTS-5994-1203-69A	Dates of Test: February 23 – April 03, 2012	FCC ID: L6AREY20CW FCC ID: L6ARFD30CW	IC: 2503A-REY20CW IC: 2503A-RFD30CW

CDMA BC10 Conducted RF Emission Test Data cont'd

The conducted spurious emissions – As per 47 CFR 2 Subpart J, CFR 90(I), CFR 90 (J), 90.210, and 90.691 were measured from 10 MHz to 10 GHz.

Date of Test: March 20, 2012

Test Data for Cellular selected Frequencies for BC10 band in Loopback mode:

Cellular Frequency (MHz)	99% Occupied Bandwidth (MHz)
817.90	1.270
820.50	1.280
823.10	1.270

Test Data for Cellular selected Frequencies for BC10 and in Loopback mode

Refer to the following measurement plots for more detail.

See Figures 1-1b to 1-6b for the plots of the conducted spurious emissions.

See Figures 1-7b to 1-9b for the plots of 99% Occupied Bandwidth.

See Figures 1-10b to 1-11b for the plots of the Channel mask.

The RF power output was at maximum for all the recorded measurements shown below.

Test Report No.:
 RTS-5994-1203-69A

Dates of Test:
 February 23 – April 03, 2012

FCC ID: L6AREY20CW
 FCC ID: L6ARFD30CW

IC: 2503A-REY20CW
 IC: 2503A-RFD30CW

CDMA BC10 Conducted RF Emission Test Data cont'd

Figure 1-1b: BC10, Spurious Conducted Emissions, Low channel

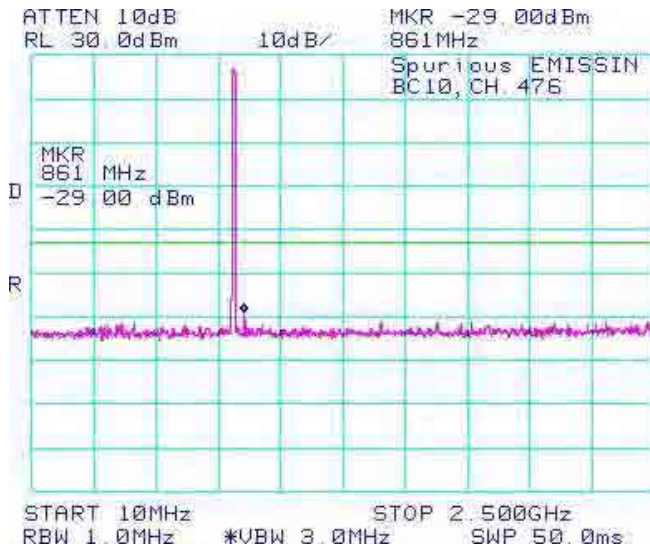

Figure 1-2b: BC10, Spurious Conducted Emissions, Low channel

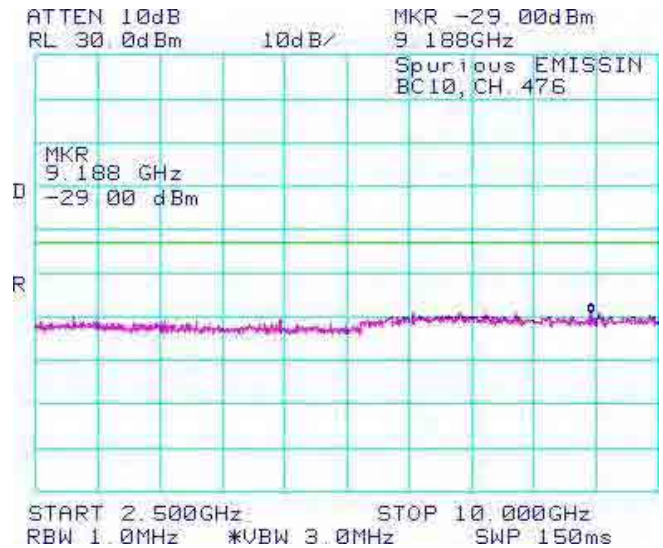

Figure 1-3b: BC10, Spurious Conducted Emissions, Middle channel

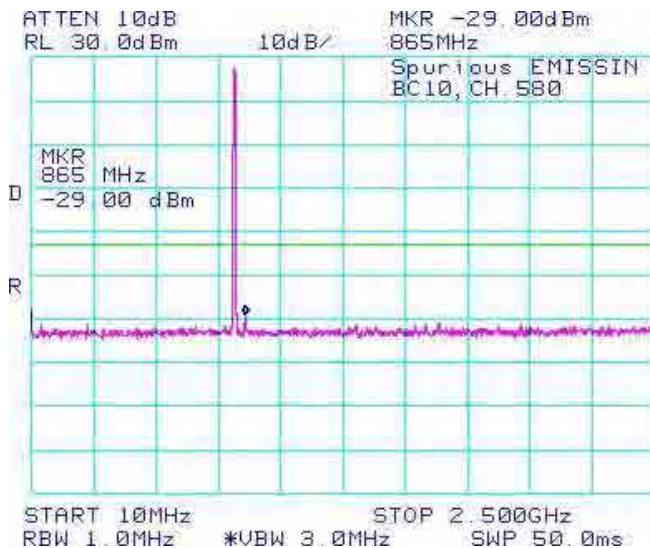
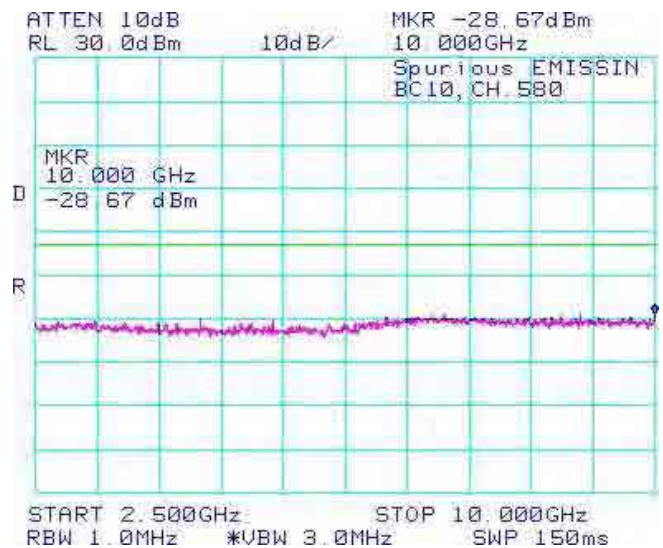

Figure 1-4b: BC10, Spurious Conducted Emissions, Middle channel



Test Report No.:
 RTS-5994-1203-69A

Dates of Test:
 February 23 – April 03, 2012

FCC ID: L6AREY20CW
 FCC ID: L6ARFD30CW

IC: 2503A-REY20CW
 IC: 2503A-RFD30CW

CDMA BC10 Conducted RF Emission Test Data cont'd

Figure 1-5b: BC10, Spurious Conducted Emissions, High Channel

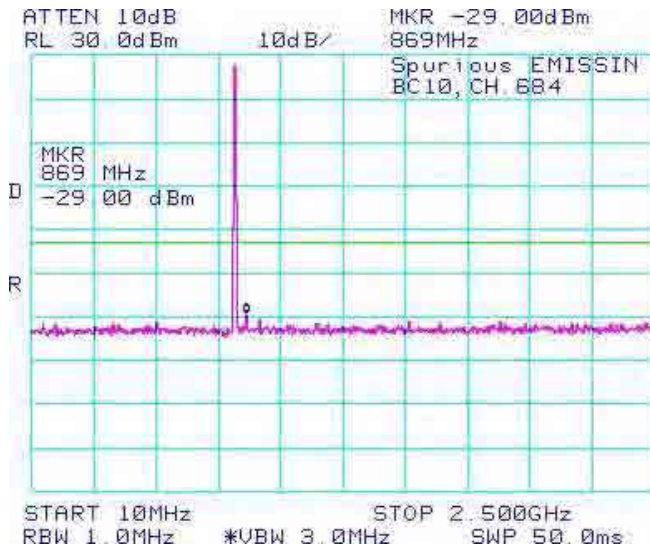

Figure 1-6b: BC10, Spurious Conducted Emissions, High Channel

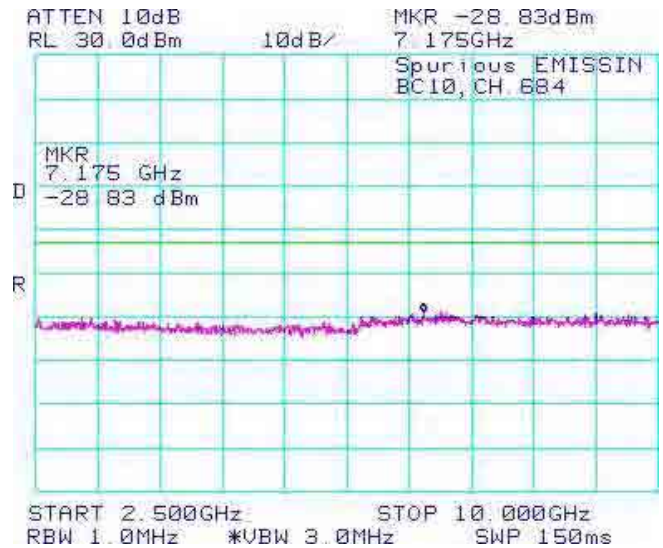

Figure 1-7b: Occupied Bandwidth, BC10 Low Channel

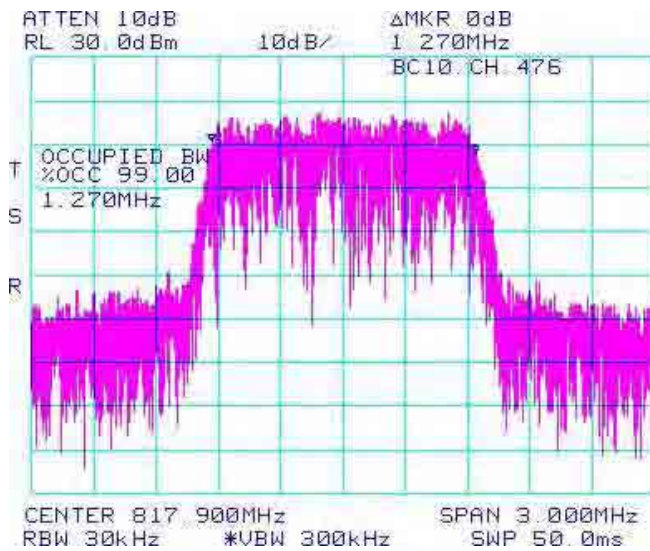
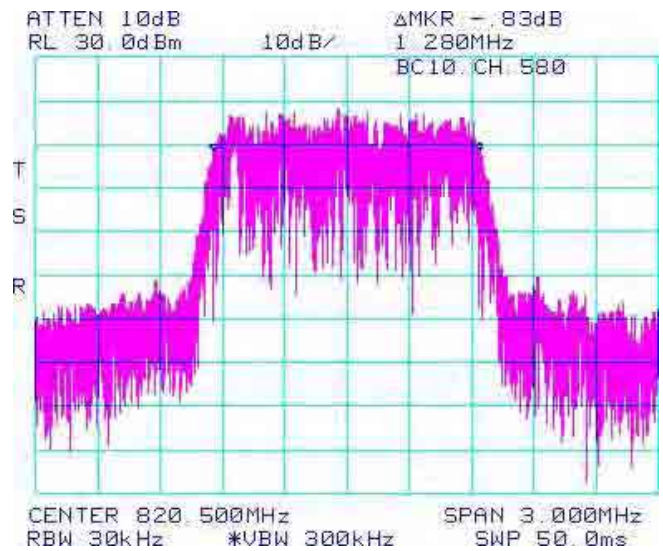

Figure 1-8b: Occupied Bandwidth, BC10 Middle Channel



Test Report No.:
 RTS-5994-1203-69A

Dates of Test:
 February 23 – April 03, 2012

FCC ID: L6AREY20CW
 FCC ID: L6ARFD30CW

IC: 2503A-REY20CW
 IC: 2503A-RFD30CW

CDMA BC10 Conducted RF Emission Test Data cont'd

Figure 1-9b: Occupied Bandwidth, BC10 High Channel

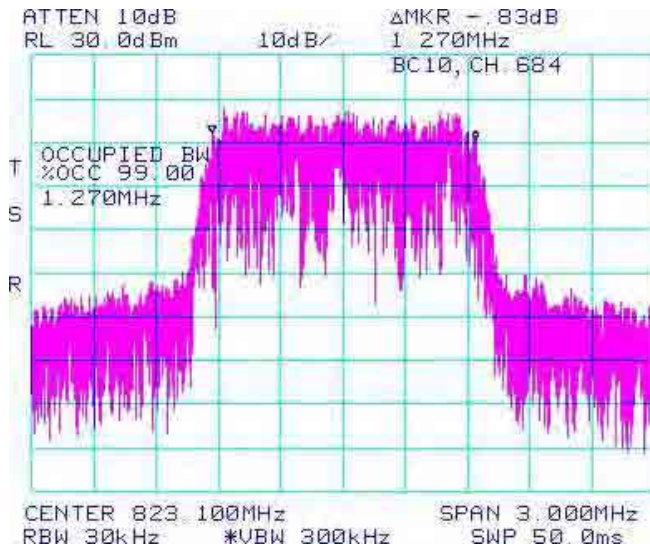

Figure 1-10b: BC10, Low Channel Mask

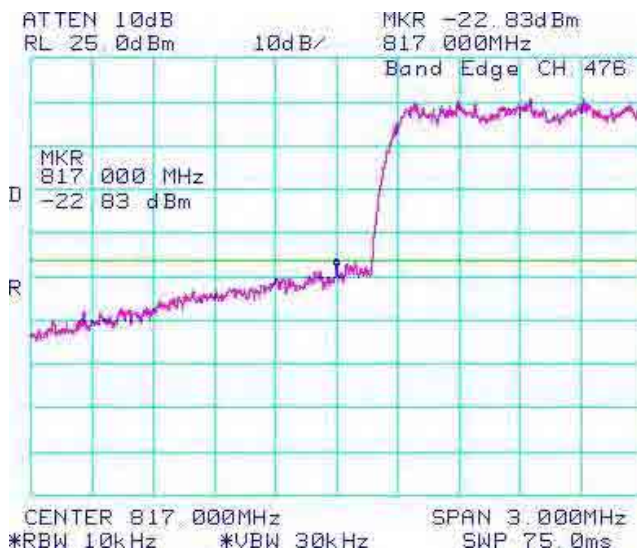

Figure 1-11b: BC10, High Channel Mask



**Since the Spectrum Analyzer's RBW cannot be set to 13 kHz, the measurement for channel masks was done at 10 kHz and the limit adjusted using the calculation $10\log(13\text{kHz}/10\text{kHz}) = 1.14\text{ dB}$. $-20\text{dBm} - 1.14\text{ dBm} = -21.14\text{ dBm}$ adjusted

	EMI Test Report for the BlackBerry® smartphone Model REY21CW, RFD31CW APPENDIX 1B		
Test Report No.: RTS-5994-1203-69A	Dates of Test: February 23 – April 03, 2012	FCC ID: L6AREY20CW FCC ID: L6ARFD30CW	IC: 2503A-REY20CW IC: 2503A-RFD30CW

CDMA BC10 Conducted RF Emission Test Data cont'd

The conducted spurious emissions – As per 47 CFR 2 Subpart J, CFR 90(I), CFR 90 (J), 90.210, and 90.691 were measured from 10 MHz to 10 GHz.

Date of Test: March 20, 2012

Test Data for Cellular selected Frequencies for BC10 band in 1x-EVDO mode:

Cellular Frequency (MHz)	99% Occupied Bandwidth (MHz)
817.90	1.270
820.50	1.270
823.10	1.280

Refer to the following measurement plots for more detail.

See Figures 1-12b to 1-17b for the plots of the conducted spurious emissions.
See Figures 1-18b to 1-20b for the plots of 99% Occupied Bandwidth.
See Figures 1-21b to 1-22b for the plots of the Channel mask.

The RF power output was at maximum for all the recorded measurements shown below.

Test Report No.:
 RTS-5994-1203-69A

Dates of Test:
 February 23 – April 03, 2012

FCC ID: L6AREY20CW
 FCC ID: L6ARFD30CW

IC: 2503A-REY20CW
 IC: 2503A-RFD30CW

CDMA BC10 Conducted RF Emission Test Data cont'd

Figure 1-12b: BC10, Spurious Conducted Emissions, Low channel

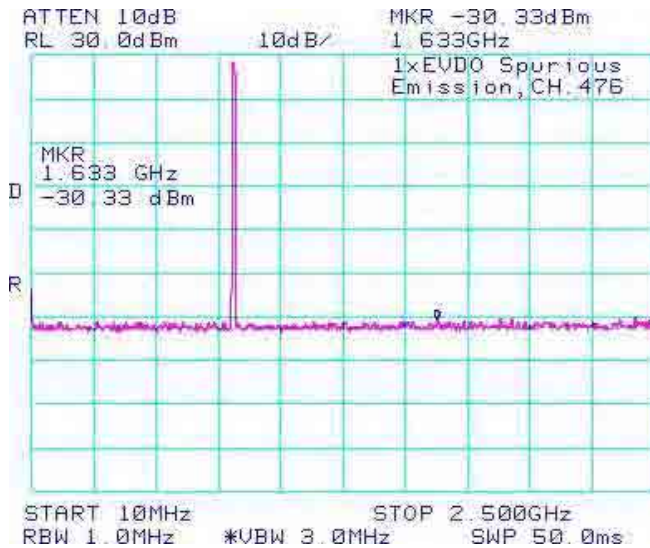

Figure 1-13b: BC10, Spurious Conducted Emissions, Low channel

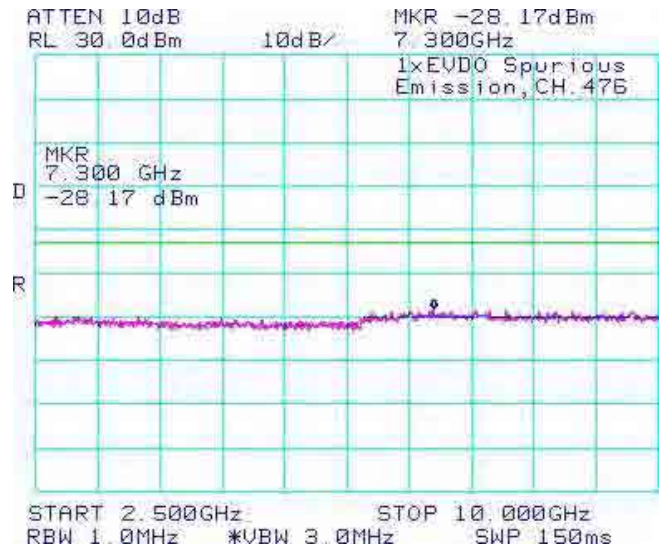

Figure 1-14b: BC10, Spurious Conducted Emissions, Middle channel

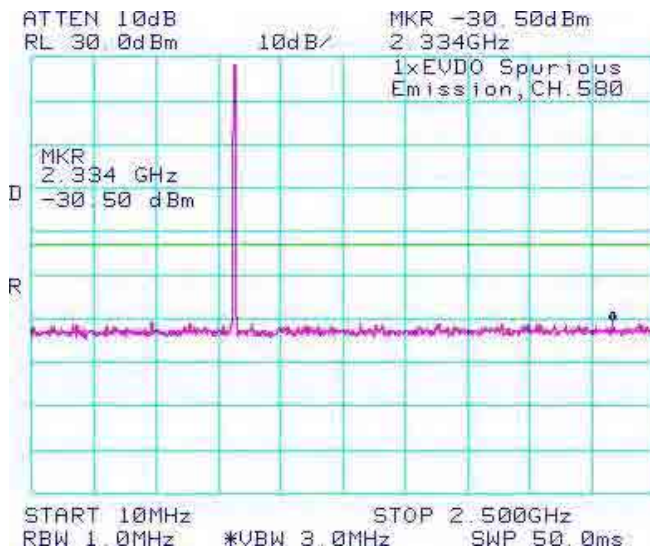
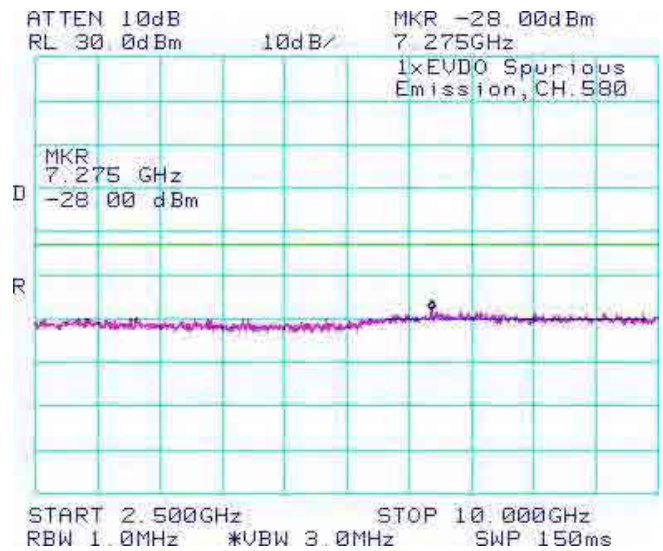

Figure 1-15b: BC10, Spurious Conducted Emissions, Middle channel



Test Report No.:
 RTS-5994-1203-69A

Dates of Test:
 February 23 – April 03, 2012

FCC ID: L6AREY20CW
 FCC ID: L6ARFD30CW

IC: 2503A-REY20CW
 IC: 2503A-RFD30CW

CDMA BC10 Conducted RF Emission Test Data cont'd

Figure 1-16b: BC10, Spurious Conducted Emissions, High Channel

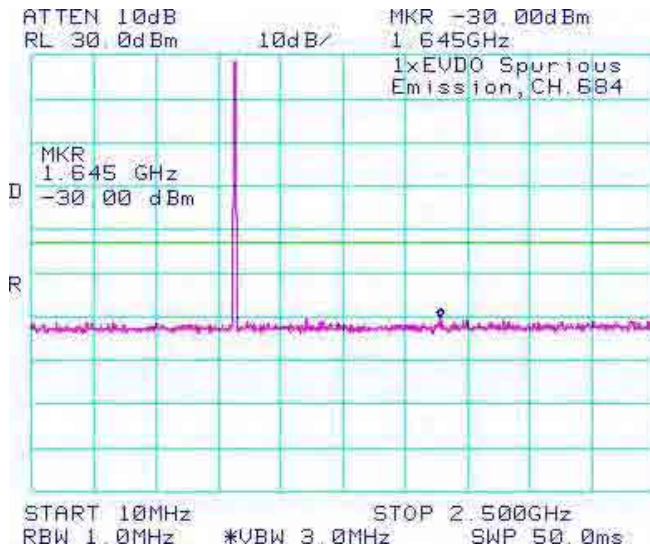

Figure 1-17b: BC10, Spurious Conducted Emissions, High Channel

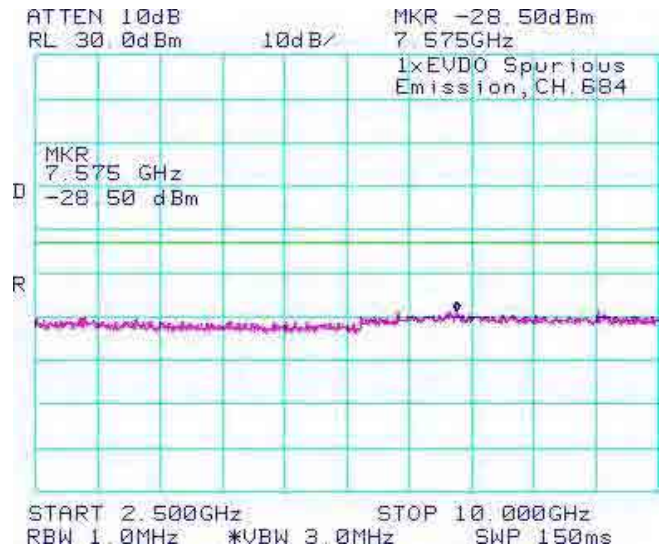

Figure 1-18b: Occupied Bandwidth, BC10 Low Channel

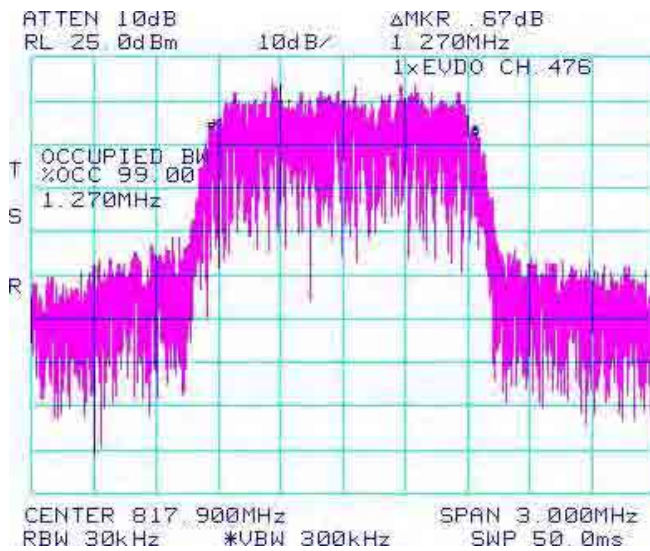
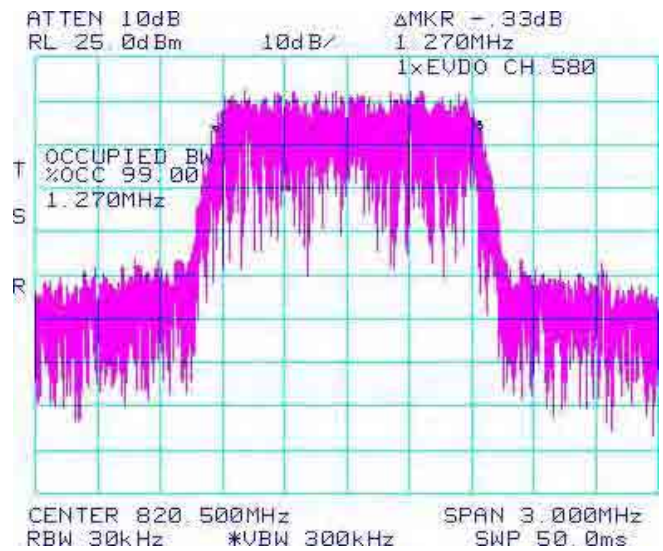

Figure 1-19b: Occupied Bandwidth, BC10 Middle Channel



Test Report No.:
 RTS-5994-1203-69A

Dates of Test:
 February 23 – April 03, 2012

FCC ID: L6AREY20CW
 FCC ID: L6ARFD30CW

IC: 2503A-REY20CW
 IC: 2503A-RFD30CW

CDMA BC10 Conducted RF Emission Test Data cont'd

Figure 1-20b: Occupied Bandwidth, BC10 High Channel

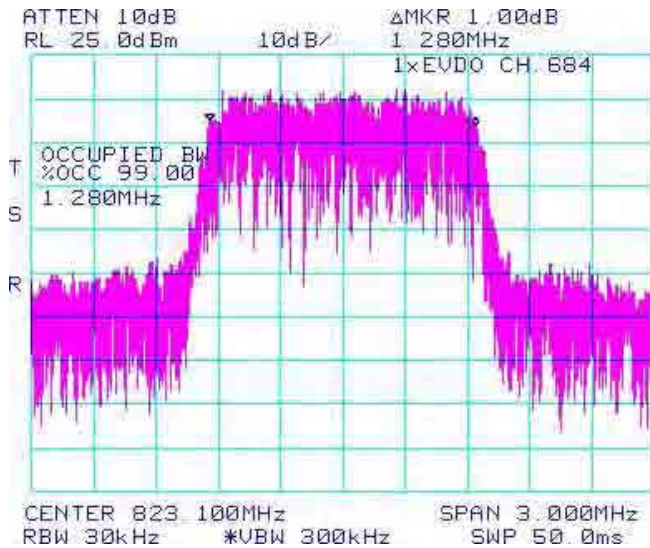

Figure 1-21b: BC10, Low Channel Mask

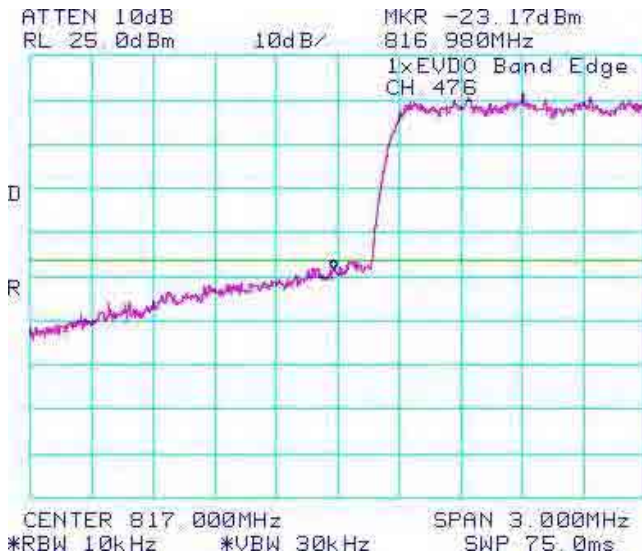
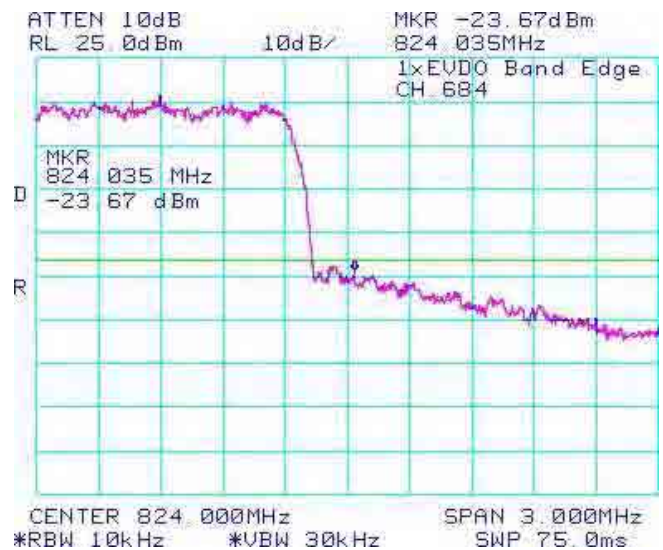

Figure 1-22b: BC10, High Channel Mask



**Since the Spectrum Analyzer's RBW cannot be set to 13 kHz, the measurement for channel masks was done at 10 kHz and the limit adjusted using the calculation $10\log(13\text{kHz}/10\text{kHz}) = 1.14\text{ dB}$. $-20\text{dBm} - 1.14\text{ dB} = -21.14\text{ dBm}$ adjusted



EMI Test Report for the BlackBerry® smartphone Model REY21CW, RFD31CW
APPENDIX 1B

Test Report No.:
RTS-5994-1203-69A

Dates of Test:
February 23 – April 03, 2012

FCC ID: L6AREY20CW IC: 2503A-REY20CW
FCC ID: L6ARFD30CW IC: 2503A-RFD30CW

APPENDIX 2 – CDMA CONDUCTED RF OUTPUT POWER TEST DATA

Test Report No.: RTS-5994-1203-69A	Dates of Test: February 23 – April 03, 2012	FCC ID: L6AREY20CW FCC ID: L6ARFD30CW	IC: 2503A-REY20CW IC: 2503A-RFD30CW
--	---	--	--

CDMA Conducted RF Output Power Test Data

The conducted RF output power was measured using the CDMA base station simulator. Low, middle and high channels were measured at maximum radio output power at different service options and modes.
Date of Test: February 23, 2012

The environmental conditions were: Temperature: 24.0 °C
Humidity: 36.1 %

The measurements were performed by Daoud Attayi

Band	Channel	1x EvDO (153.6kbps)		CDMA2000 RC	SO2 Loopback		SO55 Loopback		TDSO SO32	
		(dBm)	(Watts)		(dBm)	(Watts)	(dBm)	(Watts)	(dBm)	(Watts)
CDMA Cellular	1013	23.9	0.25	RC1	23.8	0.24	23.8	0.24	N/A	-
				RC3	23.9	0.25	23.9	0.25	23.8	0.24
	384	24.0	0.25	RC1	24.0	0.25	24.0	0.25	N/A	-
				RC3	24.0	0.25	24.0	0.25	23.9	0.25
	777	24.0	0.25	RC1	24.0	0.25	23.9	0.25	N/A	-
				RC3	23.9	0.25	23.9	0.25	24.0	0.25

Band	Channel	1x EvDO (153.6kbps)		CDMA2000 RC	SO2 Loopback		SO55 Loopback		TDSO SO32	
		(dBm)	(Watts)		(dBm)	(Watts)	(dBm)	(Watts)	(dBm)	(Watts)
CDMA PCS	25	23.1	0.20	RC1	23.5	0.22	23.4	0.22	N/A	-
				RC3	23.3	0.21	23.5	0.22	23.3	0.21
	600	22.8	0.19	RC1	23.2	0.21	23.3	0.21	N/A	-
				RC3	23.2	0.21	23.4	0.22	23.2	0.21
	1175	22.9	0.19	RC1	23.3	0.21	23.5	0.22	N/A	-
				RC3	23.3	0.21	23.5	0.22	23.5	0.22

Band	Channel	1x EvDO (153.6kbps)		CDMA2000 RC	SO2 Loopback		SO55 Loopback		TDSO SO32	
		(dBm)	(Watts)		(dBm)	(Watts)	(dBm)	(Watts)	(dBm)	(Watts)
CDMA BC10	476	24.3	0.27	RC1	24.1	0.26	24.1	0.26	N/A	-
				RC3	24.2	0.26	24.2	0.26	24.2	0.26
	580	24.3	0.27	RC1	24.2	0.26	24.2	0.26	N/A	-
				RC3	24.2	0.26	24.2	0.26	24.2	0.26
	684	24.3	0.27	RC1	24.1	0.26	24.1	0.26	N/A	-
				RC3	24.1	0.26	24.1	0.26	24.1	0.26

APPENDIX 3 – CDMA FREQUENCY STABILITY TEST DATA

Test Report No.:
RTS-5994-1203-69A

Dates of Test:
February 23 – April 03, 2012

FCC ID: L6AREY20CW
FCC ID: L6ARFD30CW

IC: 2503A-REY20CW
IC: 2503A-RFD30CW

CDMA Frequency Stability Test Data

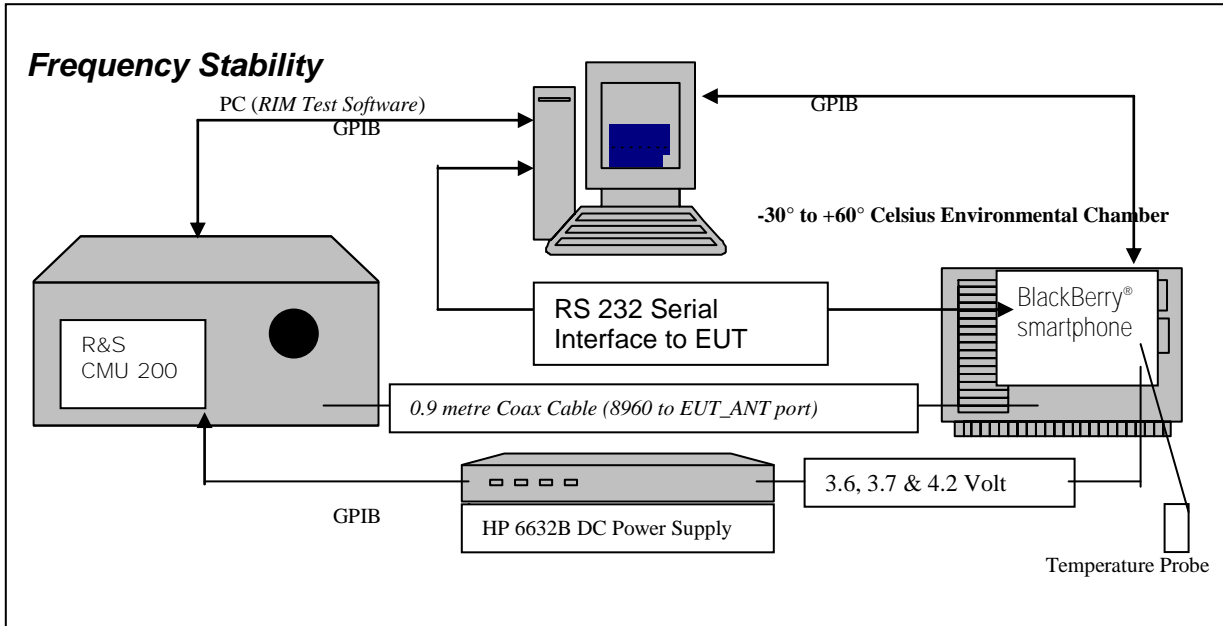

CFR 47 Chapter 1 - Federal Communications Commission Rules

Part 2 Required Measurements

2.1055 Frequency Stability - Procedures

(a, b) Frequency Stability - Temperature Variation

(d) Frequency Stability - Voltage Variation

22.917/24.235/90.213 Frequency Stability.

The frequency stability shall be sufficient to ensure that the fundamental emission stays within the authorized frequency block.

The BlackBerry® smartphone, transmitted frequencies are less than 0.1 ppm of the received frequency from the Agilent 8960 CDMA Base Station Simulator

The EUT meets the requirements as stated in CFR 47 chapter 1, Section 24.235, RSS-133, Section 22.917, Section 90.213 and RSS-132 Frequency Stability.

Frequency Stability measurement devices were configured as presented in the block diagram recording frequency, power, data, temperatures, and stepped voltages controlled via a GPIB interface linked to the Environmental chamber, a DC power supply, and the Communications Test Set. A 0.9-metre coax cable was calibrated to characterize the insertion loss for the transmitted frequencies between the RF input/output of the base station simulator and the EUT antenna port; located inside the environmental chamber.

Test Report No.:
RTS-5994-1203-69A

Dates of Test:
February 23 – April 03, 2012

FCC ID: L6AREY20CW IC: 2503A-REY20CW
FCC ID: L6ARFD30CW IC: 2503A-RFD30CW

Calibration for the Cable Loss was performed in the RF Laboratory using the Giga-tronics power metre and Agilent Signal Generator. The cable assembly from the RF input to the RF output was measured at the following Frequencies:

PCS Frequency (MHz)	Cable loss (dB)
1851.20	1.10
1880.00	1.10
1908.75	1.10

Cellular Frequency (MHz)	Cable loss (dB)
824.70	0.50
836.52	0.50
848.31	0.50

BC10 Frequency (MHz)	Cable loss (dB)
817.90	1.00
820.50	1.00
823.10	1.00

Test Setup:

The EUT was placed in the Temperature chamber and connected to the Agilent 8960 outside as shown in the figure above. Dry air was pumped inside the temperature chamber to maintain a backpressure during the test. The EUT was kept in the off condition at all times except when the measurements were to be made.

The chamber was switched on and the temperature was set to -30°C. After the chamber stabilized at -30 °C there was a soak period of one hour to alleviate moisture in the chamber, the EUT voltage was enabled. The system software recorded the frequency, power, and associated measurements.

A Computer system controlled the automated software. This application was given the command of activating all machines intrinsic to the temperature and voltage tests controlling the base station simulator via the GPIB Bus. The Environmental Chamber was instructed through an RS-232 serial line. The EUT dialogue was passed through a serial connection.

The EUT repetitively transmitted 100 bursts for each set of programmed parameters recording temperature, voltage settings, and systematically selected frequencies. The power supply was cycled from minimum voltage 3.6 volts, to 3.7 volts nominal voltage to 4.2 volts maximum voltage. The frequency error was measured at a maximum output power and recorded by the automated system test software.

Test Report No.:
RTS-5994-1203-69A**Dates of Test:**
February 23 – April 03, 2012FCC ID: L6AREY20CW IC: 2503A-REY20CW
FCC ID: L6ARFD30CW IC: 2503A-RFD30CW

The EUT output power and frequency was measured at 3.6 volts, 3.7 volts and 4.2 volts. The transmit frequency was varied in 3 steps consisting of 824.70, 836.52, and 848.31 MHz for the cellular band; 1851.20, 1880.00 and 1908.75 MHz for the PCS band; and 817.9 MHz, 820.5 MHz and 823.1 MHz for the BC15 band. This frequency was recorded in MHz and deviation from nominal, in Parts per Million.

After the initial one-hour soak at the beginning of the tests, a period of thirty minutes soak was initialized between each ascending temperature step, before proceeding to the next measurement test cycle.

Procedure:

The test system software for commencing the Frequency Stability Tests carried through the following cycle.

1. Switch on the HP 6632B power supply; CMU 200 Communications test Set, and Environmental Chamber.
2. Start test program
3. Set the Temperature to -30°C and maintain a period of one- hour soak time, with the EUT supply voltage disabled.
4. Set power supply voltage to 3.6 volts.
5. Set up CMU 200 Radio Communication Tester.
6. Command the CMU 200 to switch to the low channel.
7. Enable the voltage to the EUT, and connect a link to the CMU 200 test set.
8. EUT is commanded to Transmit 100 Bursts.
9. Software logs the following data from the CMU 200, power supply and temperature chamber: Traffic Channel Number, Traffic Channel Frequency, Power Level, Chamber Temperature, Supply Voltage, Power and Frequency Error.
10. The CMU 200 commands the EUT to change frequency to the middle channel and high channel and repeats steps 7 to 9.
11. Repeat steps 5 to 10 changing the supply voltage to 3.7 Volts
12. Increase temperature by 10°C and soak for 1/2 hour.
13. Repeat steps 4 - 12 for temperatures -30°C to 60°C .
14. Repeat steps 5 to 10 changing the supply voltage to 4.2 volts

Procedure 5 to 10 was repeated at room temperature (20°C) with the power supply voltage set to 3.6, 3.7 and 4.2 volts

The maximum frequency error in the CDMA Cellular band measured was **-0.0275 PPM**.
The maximum frequency error in the CDMA PCS band measured was **0.0108 PPM**.
The maximum frequency error in the CDMA BC10 band measured was **0.0293 PPM**.

Test Report No.:
RTS-5994-1203-69A

Dates of Test:
February 23 – April 03, 2012

FCC ID: L6AREY20CW
FCC ID: L6ARFD30CW

IC: 2503A-REY20CW
IC: 2503A-RFD30CW

The following test configurations were measured for model REY21CW:

CDMA Cellular band results: channels 1013, 384 and 777 @ 20°C maximum transmitted power

The

Traffic Channel Number	Cellular Frequency (MHz)	Voltage (Volts)	Temperature (Celsius)	Frequency Error (Hz)	PPM
1013	824.70	3.6	20	14.00	0.0170
384	836.52	3.6	20	-15.00	-0.0179
777	848.31	3.6	20	11.00	0.0130

Traffic Channel Number	Cellular Frequency (MHz)	Voltage (Volts)	Temperature (Celsius)	Frequency Error (Hz)	PPM
1013	824.70	3.7	20	-8.00	-0.0097
384	836.52	3.7	20	-13.00	-0.0155
777	848.31	3.7	20	10.00	0.0118

Traffic Channel Number	Cellular Frequency (MHz)	Voltage (Volts)	Temperature (Celsius)	Frequency Error (Hz)	PPM
1013	824.70	4.2	20	-5.00	-0.0061
384	836.52	4.2	20	-12.00	-0.0143
777	848.31	4.2	20	-12.00	-0.0141



Test Report No.:
RTS-5994-1203-69A

Dates of Test:
February 23 – April 03, 2012

FCC ID: L6AREY20CW
FCC ID: L6ARFD30CW

IC: 2503A-REY20CW
IC: 2503A-RFD30CW

Cellular Results: channel 1013 @ maximum transmitted power

Traffic Channel Number	Frequency (MHz)	Voltage (Volts)	Temperature (Celsius)	Frequency Error (Hz)	PPM
1013	824.70	3.6	-30	-19.00	-0.0230
1013	824.70	3.6	-20	11.00	0.0133
1013	824.70	3.6	-10	17.00	0.0206
1013	824.70	3.6	0	10.00	-0.0097
1013	824.70	3.6	10	11.00	0.0133
1013	824.70	3.6	20	14.00	0.0170
1013	824.70	3.6	30	-13.00	-0.0158
1013	824.70	3.6	40	-16.00	-0.0194
1013	824.70	3.6	50	-13.00	-0.0158
1013	824.70	3.6	60	-8.00	-0.0097

Traffic Channel Number	Frequency (MHz)	Voltage (Volts)	Temperature (Celsius)	Frequency Error (Hz)	PPM
1013	824.70	3.7	-30	18.00	0.0218
1013	824.70	3.7	-20	15.00	0.0182
1013	824.70	3.7	-10	9.00	0.0109
1013	824.70	3.7	0	-9.00	-0.0109
1013	824.70	3.7	10	12.00	0.0146
1013	824.70	3.7	20	-8.00	-0.0097
1013	824.70	3.7	30	-18.00	-0.0218
1013	824.70	3.7	40	22.00	0.0267
1013	824.70	3.7	50	-9.00	-0.0109
1013	824.70	3.7	60	14.00	0.0170

Traffic Channel Number	Frequency (MHz)	Voltage (Volts)	Temperature (Celsius)	Frequency Error (Hz)	PPM
1013	824.70	4.2	-30	-19.00	-0.0230
1013	824.70	4.2	-20	-13.00	-0.0158
1013	824.70	4.2	-10	11.00	0.0133
1013	824.70	4.2	0	10.00	0.0121
1013	824.70	4.2	10	-5.00	-0.0061
1013	824.70	4.2	20	-5.00	-0.0061
1013	824.70	4.2	30	-9.00	-0.0109
1013	824.70	4.2	40	7.00	0.0085
1013	824.70	4.2	50	13.00	0.0158
1013	824.70	4.2	60	16.00	0.0194

Test Report No.:
RTS-5994-1203-69A

Dates of Test:
February 23 – April 03, 2012

FCC ID: L6AREY20CW
FCC ID: L6ARFD30CW

IC: 2503A-REY20CW
IC: 2503A-RFD30CW

Cellular Results: channel 384 @ maximum transmitted power

Traffic Channel Number	Frequency (MHz)	Voltage (Volts)	Temperature (Celsius)	Frequency Error (Hz)	PPM
384	836.52	3.6	-30	14.00	0.0167
384	836.52	3.6	-20	-12.00	-0.0143
384	836.52	3.6	-10	-13.00	-0.0155
384	836.52	3.6	0	-12.00	-0.0275
384	836.52	3.6	10	13.00	0.0155
384	836.52	3.6	20	-15.00	-0.0179
384	836.52	3.6	30	11.00	0.0131
384	836.52	3.6	40	-10.00	-0.0120
384	836.52	3.6	50	-18.00	-0.0215
384	836.52	3.6	60	-23.00	-0.0275

Traffic Channel Number	Frequency (MHz)	Voltage (Volts)	Temperature (Celsius)	Frequency Error (Hz)	PPM
384	836.52	3.7	-30	-10.00	-0.0120
384	836.52	3.7	-20	8.00	0.0096
384	836.52	3.7	-10	-13.00	-0.0155
384	836.52	3.7	0	-13.00	-0.0155
384	836.52	3.7	10	-7.00	-0.0084
384	836.52	3.7	20	-13.00	-0.0155
384	836.52	3.7	30	-12.00	-0.0143
384	836.52	3.7	40	-10.00	-0.0120
384	836.52	3.7	50	-14.00	-0.0167
384	836.52	3.7	60	-13.00	-0.0155

Traffic Channel Number	Frequency (MHz)	Voltage (Volts)	Temperature (Celsius)	Frequency Error (Hz)	PPM
384	836.52	4.2	-30	-12.00	-0.0143
384	836.52	4.2	-20	-9.00	-0.0108
384	836.52	4.2	-10	-14.00	-0.0167
384	836.52	4.2	0	-13.00	-0.0155
384	836.52	4.2	10	11.00	0.0131
384	836.52	4.2	20	-12.00	-0.0143
384	836.52	4.2	30	-12.00	-0.0143
384	836.52	4.2	40	-17.00	-0.0203
384	836.52	4.2	50	9.00	0.0108
384	836.52	4.2	60	13.00	0.0155

Test Report No.:
RTS-5994-1203-69A

Dates of Test:
February 23 – April 03, 2012

FCC ID: L6AREY20CW
FCC ID: L6ARFD30CW

IC: 2503A-REY20CW
IC: 2503A-RFD30CW

Cellular Results: channel 777 @ maximum transmitted power

Traffic Channel Number	Frequency (MHz)	Voltage (Volts)	Temperature (Celsius)	Frequency Error (Hz)	PPM
777	848.31	3.6	-30	9.00	0.0106
777	848.31	3.6	-20	13.00	0.0153
777	848.31	3.6	-10	11.00	0.0130
777	848.31	3.6	0	9.00	-0.0130
777	848.31	3.6	10	-9.00	-0.0106
777	848.31	3.6	20	11.00	0.0130
777	848.31	3.6	30	14.00	0.0165
777	848.31	3.6	40	-14.00	-0.0165
777	848.31	3.6	50	-13.00	-0.0153
777	848.31	3.6	60	-11.00	-0.0130

Traffic Channel Number	Frequency (MHz)	Voltage (Volts)	Temperature (Celsius)	Frequency Error (Hz)	PPM
777	848.31	3.7	-30	-7.00	-0.0083
777	848.31	3.7	-20	-12.00	-0.0141
777	848.31	3.7	-10	-15.00	-0.0177
777	848.31	3.7	0	7.00	0.0083
777	848.31	3.7	10	9.00	0.0106
777	848.31	3.7	20	10.00	0.0118
777	848.31	3.7	30	-15.00	-0.0177
777	848.31	3.7	40	-13.00	-0.0153
777	848.31	3.7	50	-11.00	-0.0130
777	848.31	3.7	60	-16.00	-0.0189

Traffic Channel Number	Frequency (MHz)	Voltage (Volts)	Temperature (Celsius)	Frequency Error (Hz)	PPM
777	848.31	4.2	-30	-13.00	-0.0153
777	848.31	4.2	-20	-9.00	-0.0106
777	848.31	4.2	-10	-13.00	-0.0153
777	848.31	4.2	0	12.00	0.0141
777	848.31	4.2	10	11.00	0.0130
777	848.31	4.2	20	-12.00	-0.0141
777	848.31	4.2	30	-14.00	-0.0165
777	848.31	4.2	40	-13.00	-0.0153
777	848.31	4.2	50	-11.00	-0.0130
777	848.31	4.2	60	-14.00	-0.0165

Test Report No.:
RTS-5994-1203-69A

Dates of Test:
February 23 – April 03, 2012

FCC ID: L6AREY20CW IC: 2503A-REY20CW
FCC ID: L6ARFD30CW IC: 2503A-RFD30CW

The following test configurations were measured for model REY21CW:

PCS band results: channels 25, 600, & 1175 @ 20°C maximum transmitted power

Traffic Channel Number	PCS Frequency (MHz)	Voltage (Volts)	Temperature (Celsius)	Frequency Error (Hz)	PPM
25	1851.20	3.6	20	-7.00	-0.0038
600	1880.00	3.6	20	-11.00	-0.0059
1175	1908.75	3.6	20	-13.00	-0.0068

Traffic Channel Number	PCS Frequency (MHz)	Voltage (Volts)	Temperature (Celsius)	Frequency Error (Hz)	PPM
25	1851.20	3.7	20	9.00	0.0049
600	1880.00	3.7	20	-12.00	-0.0064
1175	1908.75	3.7	20	-16.00	-0.0084

Traffic Channel Number	PCS Frequency (MHz)	Voltage (Volts)	Temperature (Celsius)	Frequency Error (Hz)	PPM
25	1851.20	4.2	20	-6.00	-0.0032
600	1880.00	4.2	20	-10.00	-0.0053
1175	1908.75	4.2	20	-11.00	-0.0058



Test Report No.:
RTS-5994-1203-69A

Dates of Test:
February 23 – April 03, 2012

FCC ID: L6AREY20CW
FCC ID: L6ARFD30CW

IC: 2503A-REY20CW
IC: 2503A-RFD30CW

PCS Results: channel 25 @ maximum transmitted power

Traffic Channel Number	Frequency (MHz)	Voltage (Volts)	Temperature (Celsius)	Frequency Error (Hz)	PPM
25	1851.20	3.6	-30	20.00	0.0108
25	1851.20	3.6	-20	-13.00	-0.0070
25	1851.20	3.6	-10	-16.00	-0.0086
25	1851.20	3.6	0	-19.00	0.0054
25	1851.20	3.6	10	-8.00	-0.0043
25	1851.20	3.6	20	-7.00	-0.0038
25	1851.20	3.6	30	-8.00	-0.0043
25	1851.20	3.6	40	11.00	0.0059
25	1851.20	3.6	50	10.00	0.0054
25	1851.20	3.6	60	10.00	0.0054

Traffic Channel Number	Frequency (MHz)	Voltage (Volts)	Temperature (Celsius)	Frequency Error (Hz)	PPM
25	1851.20	3.7	-30	-13.00	-0.0070
25	1851.20	3.7	-20	-16.00	-0.0086
25	1851.20	3.7	-10	-13.00	-0.0070
25	1851.20	3.7	0	-13.00	-0.0070
25	1851.20	3.7	10	-17.00	-0.0092
25	1851.20	3.7	20	9.00	0.0049
25	1851.20	3.7	30	11.00	0.0059
25	1851.20	3.7	40	12.00	0.0065
25	1851.20	3.7	50	13.00	0.0070
25	1851.20	3.7	60	11.00	0.0059

Traffic Channel Number	Frequency (MHz)	Voltage (Volts)	Temperature (Celsius)	Frequency Error (Hz)	PPM
25	1851.20	4.2	-30	-9.00	-0.0049
25	1851.20	4.2	-20	-14.00	-0.0076
25	1851.20	4.2	-10	13.00	0.0070
25	1851.20	4.2	0	14.00	0.0076
25	1851.20	4.2	10	12.00	0.0065
25	1851.20	4.2	20	-6.00	-0.0032
25	1851.20	4.2	30	-12.00	-0.0065
25	1851.20	4.2	40	11.00	0.0059
25	1851.20	4.2	50	-9.00	-0.0049
25	1851.20	4.2	60	-13.00	-0.0070



Test Report No.:
RTS-5994-1203-69A

Dates of Test:
February 23 – April 03, 2012

FCC ID: L6AREY20CW
FCC ID: L6ARFD30CW

IC: 2503A-REY20CW
IC: 2503A-RFD30CW

PCS Results: channel 600 @ maximum transmitted power

Traffic Channel Number	Frequency (MHz)	Voltage (Volts)	Temperature (Celsius)	Frequency Error (Hz)	PPM
600	1880.00	3.6	-30	-16.00	-0.0085
600	1880.00	3.6	-20	-11.00	-0.0059
600	1880.00	3.6	-10	-11.00	-0.0059
600	1880.00	3.6	0	17.00	0.0059
600	1880.00	3.6	10	11.00	0.0059
600	1880.00	3.6	20	-11.00	-0.0059
600	1880.00	3.6	30	-11.00	-0.0059
600	1880.00	3.6	40	15.00	0.0080
600	1880.00	3.6	50	9.00	0.0048
600	1880.00	3.6	60	11.00	0.0059

Traffic Channel Number	Frequency (MHz)	Voltage (Volts)	Temperature (Celsius)	Frequency Error (Hz)	PPM
600	1880.00	3.7	-30	-6.00	-0.0032
600	1880.00	3.7	-20	13.00	0.0069
600	1880.00	3.7	-10	-11.00	-0.0059
600	1880.00	3.7	0	11.00	0.0059
600	1880.00	3.7	10	-13.00	-0.0069
600	1880.00	3.7	20	-12.00	-0.0064
600	1880.00	3.7	30	11.00	0.0059
600	1880.00	3.7	40	13.00	0.0069
600	1880.00	3.7	50	-9.00	-0.0048
600	1880.00	3.7	60	-13.00	-0.0069

Traffic Channel Number	Frequency (MHz)	Voltage (Volts)	Temperature (Celsius)	Frequency Error (Hz)	PPM
600	1880.00	4.2	-30	-12.00	-0.0064
600	1880.00	4.2	-20	-12.00	-0.0064
600	1880.00	4.2	-10	9.00	0.0048
600	1880.00	4.2	0	-12.00	-0.0064
600	1880.00	4.2	10	-9.00	-0.0048
600	1880.00	4.2	20	-10.00	-0.0053
600	1880.00	4.2	30	-8.00	-0.0043
600	1880.00	4.2	40	13.00	0.0069
600	1880.00	4.2	50	11.00	0.0059
600	1880.00	4.2	60	-11.00	-0.0059



Test Report No.:
RTS-5994-1203-69A

Dates of Test:
February 23 – April 03, 2012

FCC ID: L6AREY20CW
FCC ID: L6ARFD30CW

IC: 2503A-REY20CW
IC: 2503A-RFD30CW

PCS Results: channel 1175 @ maximum transmitted power

Traffic Channel Number	Frequency (MHz)	Voltage (Volts)	Temperature (Celsius)	Frequency Error (Hz)	PPM
1175	1908.75	3.6	-30	-11.00	-0.0058
1175	1908.75	3.6	-20	15.00	0.0079
1175	1908.75	3.6	-10	9.00	0.0047
1175	1908.75	3.6	0	15.00	-0.0047
1175	1908.75	3.6	10	13.00	0.0068
1175	1908.75	3.6	20	-13.00	-0.0068
1175	1908.75	3.6	30	-13.00	-0.0068
1175	1908.75	3.6	40	-15.00	-0.0079
1175	1908.75	3.6	50	14.00	0.0073
1175	1908.75	3.6	60	-9.00	-0.0047

Traffic Channel Number	Frequency (MHz)	Voltage (Volts)	Temperature (Celsius)	Frequency Error (Hz)	PPM
1175	1908.75	3.7	-30	-16.00	-0.0084
1175	1908.75	3.7	-20	11.00	0.0058
1175	1908.75	3.7	-10	7.00	0.0037
1175	1908.75	3.7	0	11.00	0.0058
1175	1908.75	3.7	10	11.00	0.0058
1175	1908.75	3.7	20	-16.00	-0.0084
1175	1908.75	3.7	30	-13.00	-0.0068
1175	1908.75	3.7	40	-15.00	-0.0079
1175	1908.75	3.7	50	-11.00	-0.0058
1175	1908.75	3.7	60	-13.00	-0.0068

Traffic Channel Number	Frequency (MHz)	Voltage (Volts)	Temperature (Celsius)	Frequency Error (Hz)	PPM
1175	1908.75	4.2	-30	-11.00	-0.0058
1175	1908.75	4.2	-20	13.00	0.0068
1175	1908.75	4.2	-10	13.00	0.0068
1175	1908.75	4.2	0	-10.00	-0.0052
1175	1908.75	4.2	10	-11.00	-0.0058
1175	1908.75	4.2	20	-11.00	-0.0058
1175	1908.75	4.2	30	-11.00	-0.0058
1175	1908.75	4.2	40	-11.00	-0.0058
1175	1908.75	4.2	50	-12.00	-0.0063
1175	1908.75	4.2	60	-11.00	-0.0058

Test Report No.:
RTS-5994-1203-69A

Dates of Test:
February 23 – April 03, 2012

FCC ID: L6AREY20CW IC: 2503A-REY20CW
FCC ID: L6ARFD30CW IC: 2503A-RFD30CW

The following test configurations were measured for model RFD31CW:

BC10 band results: channels 476, 580 and 684 @ 20°C maximum transmitted power

Traffic Channel Number	Cellular Frequency (MHz)	Voltage (Volts)	Temperature (Celsius)	Frequency Error (Hz)	PPM
476	817.900	3.6	20	-14	-0.0171
580	820.500	3.6	20	-11	-0.0134
684	823.100	3.6	20	-9	-0.0109

Traffic Channel Number	Cellular Frequency (MHz)	Voltage (Volts)	Temperature (Celsius)	Frequency Error (Hz)	PPM
476	817.900	3.7	20	-12	-0.0147
580	820.500	3.7	20	-11	-0.0134
684	823.100	3.7	20	9	0.0109

Traffic Channel Number	Cellular Frequency (MHz)	Voltage (Volts)	Temperature (Celsius)	Frequency Error (Hz)	PPM
476	817.900	4.2	20	-11	-0.0134
580	820.500	4.2	20	-10	-0.0122
684	823.100	4.2	20	-6	-0.0073



Test Report No.:
RTS-5994-1203-69A

Dates of Test:
February 23 – April 03, 2012

FCC ID: L6AREY20CW
FCC ID: L6ARFD30CW

IC: 2503A-REY20CW
IC: 2503A-RFD30CW

BC10 Results: channel 476 @ maximum transmitted power

Traffic Channel Number	Frequency (MHz)	Voltage (Volts)	Temperature (Celsius)	Frequency Error (Hz)	PPM
476	817.900	3.6	-30	-17	-0.0208
476	817.900	3.6	-20	-15	-0.0183
476	817.900	3.6	-10	-20	-0.0245
476	817.900	3.6	0	-22	-0.0269
476	817.900	3.6	10	-18	-0.0220
476	817.900	3.6	20	-14	-0.0171
476	817.900	3.6	30	13	0.0159
476	817.900	3.6	40	17	0.0208
476	817.900	3.6	50	15	0.0183
476	817.900	3.6	60	24	0.0293

Traffic Channel Number	Frequency (MHz)	Voltage (Volts)	Temperature (Celsius)	Frequency Error (Hz)	PPM
476	817.900	3.7	-30	-15	-0.0183
476	817.900	3.7	-20	-11	-0.0134
476	817.900	3.7	-10	-18	-0.0220
476	817.900	3.7	0	-16	-0.0196
476	817.900	3.7	10	-17	-0.0208
476	817.900	3.7	20	-12	-0.0147
476	817.900	3.7	30	-14	-0.0171
476	817.900	3.7	40	23	0.0281
476	817.900	3.7	50	17	0.0208
476	817.900	3.7	60	18	0.0220

Traffic Channel Number	Frequency (MHz)	Voltage (Volts)	Temperature (Celsius)	Frequency Error (Hz)	PPM
476	817.900	4.2	-30	-16	-0.0196
476	817.900	4.2	-20	-13	-0.0159
476	817.900	4.2	-10	-19	-0.0232
476	817.900	4.2	0	-15	-0.0183
476	817.900	4.2	10	-21	-0.0257
476	817.900	4.2	20	-11	-0.0134
476	817.900	4.2	30	-15	-0.0183
476	817.900	4.2	40	-20	-0.0245
476	817.900	4.2	50	21	0.0257
476	817.900	4.2	60	22	0.0269



Test Report No.:
RTS-5994-1203-69A

Dates of Test:
February 23 – April 03, 2012

FCC ID: L6AREY20CW
FCC ID: L6ARFD30CW

IC: 2503A-REY20CW
IC: 2503A-RFD30CW

BC10 Results: channel 580 @ maximum transmitted power

Traffic Channel Number	Frequency (MHz)	Voltage (Volts)	Temperature (Celsius)	Frequency Error (Hz)	PPM
580	820.500	3.6	-30	-13	-0.0158
580	820.500	3.6	-20	-14	-0.0171
580	820.500	3.6	-10	-19	-0.0232
580	820.500	3.6	0	-17	-0.0207
580	820.500	3.6	10	-18	-0.0219
580	820.500	3.6	20	-11	-0.0134
580	820.500	3.6	30	12	0.0146
580	820.500	3.6	40	19	0.0232
580	820.500	3.6	50	13	0.0158
580	820.500	3.6	60	17	0.0207

Traffic Channel Number	Frequency (MHz)	Voltage (Volts)	Temperature (Celsius)	Frequency Error (Hz)	PPM
580	820.500	3.7	-30	-9	-0.0110
580	820.500	3.7	-20	-13	-0.0158
580	820.500	3.7	-10	-16	-0.0195
580	820.500	3.7	0	-11	-0.0134
580	820.500	3.7	10	-15	-0.0183
580	820.500	3.7	20	-11	-0.0134
580	820.500	3.7	30	-11	-0.0134
580	820.500	3.7	40	18	0.0219
580	820.500	3.7	50	11	0.0134
580	820.500	3.7	60	16	0.0195

Traffic Channel Number	Frequency (MHz)	Voltage (Volts)	Temperature (Celsius)	Frequency Error (Hz)	PPM
580	820.500	4.2	-30	-19	-0.0232
580	820.500	4.2	-20	-11	-0.0134
580	820.500	4.2	-10	-21	-0.0256
580	820.500	4.2	0	-11	-0.0134
580	820.500	4.2	10	-19	-0.0232
580	820.500	4.2	20	-10	-0.0122
580	820.500	4.2	30	9	0.0110
580	820.500	4.2	40	-17	-0.0207
580	820.500	4.2	50	15	0.0183
580	820.500	4.2	60	14	0.0171

Test Report No.:
RTS-5994-1203-69A

Dates of Test:
February 23 – April 03, 2012

FCC ID: L6AREY20CW
FCC ID: L6ARFD30CW

IC: 2503A-REY20CW
IC: 2503A-RFD30CW

BC10 Results: channel 684 @ maximum transmitted power

Traffic Channel Number	Frequency (MHz)	Voltage (Volts)	Temperature (Celsius)	Frequency Error (Hz)	PPM
684	823.100	3.6	-30	-16	-0.0194
684	823.100	3.6	-20	-11	-0.0134
684	823.100	3.6	-10	-15	-0.0182
684	823.100	3.6	0	-13	-0.0158
684	823.100	3.6	10	-14	-0.0170
684	823.100	3.6	20	-9	-0.0109
684	823.100	3.6	30	9	0.0109
684	823.100	3.6	40	19	0.0231
684	823.100	3.6	50	18	0.0219
684	823.100	3.6	60	16	0.0194

Traffic Channel Number	Frequency (MHz)	Voltage (Volts)	Temperature (Celsius)	Frequency Error (Hz)	PPM
684	823.100	3.7	-30	-15	-0.0182
684	823.100	3.7	-20	-17	-0.0207
684	823.100	3.7	-10	-13	-0.0158
684	823.100	3.7	0	-15	-0.0182
684	823.100	3.7	10	-16	-0.0194
684	823.100	3.7	20	9	0.0109
684	823.100	3.7	30	13	0.0158
684	823.100	3.7	40	13	0.0158
684	823.100	3.7	50	13	0.0158
684	823.100	3.7	60	11	0.0134

Traffic Channel Number	Frequency (MHz)	Voltage (Volts)	Temperature (Celsius)	Frequency Error (Hz)	PPM
684	823.100	4.2	-30	-21	-0.0255
684	823.100	4.2	-20	-18	-0.0219
684	823.100	4.2	-10	-18	-0.0219
684	823.100	4.2	0	-13	-0.0158
684	823.100	4.2	10	15	0.0182
684	823.100	4.2	20	-6	-0.0073
684	823.100	4.2	30	8	0.0097
684	823.100	4.2	40	18	0.0219
684	823.100	4.2	50	18	0.0219
684	823.100	4.2	60	14	0.0170

APPENDIX 4 – CDMA RADIATED EMISSIONS TEST DATA



Test Report No.: RTS-5994-1203-69A	Dates of Test: February 23 – April 03, 2012	FCC ID: L6AREY20CW FCC ID: L6ARFD30CW	IC: 2503A-REY20CW IC: 2503A-RFD30CW
--	---	--	--

Radiated Power Test Data Results

The following test configurations were measured for model REY21CW:

Date of Test: March 15, 2012

The following measurements were performed by Nielven Olis.

The environmental tests conditions were: Temperature: 26.6 °C
 Relative Humidity: 26.5 %

The BlackBerry® smartphone was standalone vertically, top down, with LCD facing the RX antenna when the turntable is at 0 degree position.

Test Distance was 3.0 meters with the RX antenna height scans between 1-4 meters height.

Cellular Loopback Service Mode

EUT				Rx Antenna		Spectrum Analyzer		Substitution Method Tracking Generator					
Type	Ch	Frequency (MHz)	Band	Type	Pol.	Reading (dBuV)	Max (V,H) (dBuV)	Pol. Tx-Rx	Reading (dBm)	Corrected Reading (relative to Dipole)		Limit (dBm)	Diff. To Limit (dB)
										(dBm)	(W)		
F0	1013	824.70	Cell	Dipole	V	77.04	77.04	V-V	7.84	25.52	0.36	39.0	13.48
F0	1013	824.70	Cell	Dipole	H	69.82		H-H	6.92				
F0	384	836.52	Cell	Dipole	V	76.99	76.99	V-V	7.66	25.12	0.33	39.0	13.88
F0	384	836.52	Cell	Dipole	H	70.35		H-H	7.37				
F0	777	848.32	Cell	Dipole	V	77.72	77.72	V-V	8.11	25.65	0.37	39.0	13.35
F0	777	848.32	Cell	Dipole	H	70.40		H-H	7.39				

Cellular EVDO Mode

EUT				Rx Antenna		Spectrum Analyzer		Substitution Method Tracking Generator					
Type	Ch	Frequency (MHz)	Band	Type	Pol.	Reading (dBuV)	Max (V,H) (dBuV)	Pol. Tx-Rx	Reading (dBm)	Corrected Reading (relative to Dipole)		Limit (dBm)	Diff. To Limit (dB)
										(dBm)	(W)		
F0	1013	824.70	Cell	Dipole	V	78.44	78.44	V-V	9.28	26.96	0.50	39.0	12.04
F0	1013	824.70	Cell	Dipole	H	71.31		H-H	8.38				
F0	384	836.52	Cell	Dipole	V	78.26	78.26	V-V	8.90	26.36	0.43	39.0	12.64
F0	384	836.52	Cell	Dipole	H	71.93		H-H	8.62				
F0	777	848.32	Cell	Dipole	V	78.73	78.73	V-V	9.10	26.64	0.46	39.0	12.36
F0	777	848.32	Cell	Dipole	H	69.49		H-H	8.42				

This report shall NOT be reproduced except in full without the written consent of RIM Testing Services
 - A division of Research in Motion Limited.



Test Report No.: RTS-5994-1203-69A	Dates of Test: February 23 – April 03, 2012	FCC ID: L6AREY20CW FCC ID: L6ARFD30CW	IC: 2503A-REY20CW IC: 2503A-RFD30CW
--	---	--	--

Radiated Power Test Data Results cont'd

The following test configurations were measured for model REY21CW:

Date of Test: March 15, 2012

The following measurements were performed by Nielven Olis.

The environmental tests conditions were: Temperature: 26.6 °C
 Relative Humidity: 26.5 %

The BlackBerry® smartphone was standalone with USB jack pointing down and LCD facing the RX antenna when the turntable is at 0 degree position.

Test Distance was 3.0 meters with the RX antenna height scans between 1-4 meters height.

PCS Loopback Service Mode

										Substitution Method			
EUT				Receive Antenna		Spectrum Analyzer		Tracking Generator					
Type	Ch	Frequency (MHz)	Band	Type	Pol.	Reading (dBuV)	Max (V,H) (dBuV)	Pol. Tx-Rx	Reading (dBm)	(dBm)	(W)	Limit (dBm)	Diff to Limit (dB)
F0	25	1851.25	PCS	Horn	V	78.99	78.99	VV	-13.27	26.23	0.42	33.00	6.77
F0	25	1851.25	PCS	Horn	H	77.78		HH	-12.82				
F0	600	1880.00	PCS	Horn	V	79.15	79.15	VV	-12.18	27.30	0.54	33.00	5.70
F0	600	1880.00	PCS	Horn	H	76.82		HH	-11.63				
F0	1175	1908.75	PCS	Horn	V	78.42	78.42	VV	-13.27	26.81	0.48	33.00	6.19
F0	1175	1908.75	PCS	Horn	H	76.87		HH	-12.27				

PCS EVDO Mode

										Substitution Method			
EUT				Receive Antenna		Spectrum Analyzer		Tracking Generator					
Type	Ch	Frequency (MHz)	Band	Type	Pol.	Reading (dBuV)	Max (V,H) (dBuV)	Pol. Tx-Rx	Reading (dBm)	(dBm)	(W)	Limit (dBm)	Diff to Limit (dB)
F0	25	1851.25	PCS	Horn	V	79.04	79.04	VV	-13.23	26.31	0.43	33.00	6.69
F0	25	1851.25	PCS	Horn	H	77.84		HH	-12.74				
F0	600	1880.00	PCS	Horn	V	78.88	78.88	VV	-12.45	27.13	0.52	33.00	5.87
F0	600	1880.00	PCS	Horn	H	76.96		HH	-11.80				
F0	1175	1908.75	PCS	Horn	V	78.49	78.49	VV	-13.25	26.79	0.48	33.00	6.21
F0	1175	1908.75	PCS	Horn	H	76.91		HH	-12.29				



Test Report No.: RTS-5994-1203-69A	Dates of Test: February 23 – April 03, 2012	FCC ID: L6AREY20CW FCC ID: L6ARFD30CW	IC: 2503A-REY20CW IC: 2503A-RFD30CW
--	---	--	--

Radiated Power Test Data Results cont'd

The following test configurations were measured for model RFD31CW:

Date of Test: April 03, 2012

The following measurements were performed by Nielven Olis.

The environmental tests conditions were: Temperature: 27.8 °C
 Relative Humidity: 11.9 %

The BlackBerry® smartphone was standalone horizontally, with LCD facing up and top pointing to the RX antenna when the turntable is at 0 degree position.

Test Distance was 3.0 meters with the RX antenna height scans between 1-4 meters height.

BC10 Loopback Service Mode

										Substitution Method			
EUT				Receive Antenna		Spectrum Analyzer		Tracking Generator					
Type	Ch	Frequency (MHz)	Band	Type	Pol.	Reading (dBuV)	Max (V,H) (dBuV)	Pol. Tx-Rx	Reading (dBm)	(dBm)	(W)	Limit (dBm)	Diff to Limit (dB)
F0	476	817.90	BC10	Horn	V	61.55	78.66	VV	10.68	28.15	0.65	39.00	10.85
F0	476	817.90	BC10	Horn	H	78.66		HH	9.16				
F0	580	820.50	BC10	Horn	V	61.12	78.86	VV	10.66	28.37	0.69	39.00	10.63
F0	580	820.50	BC10	Horn	H	78.86		HH	9.16				
F0	684	823.10	BC10	Horn	V	60.30	78.20	VV	10.14	27.90	0.62	39.00	11.10
F0	684	823.10	BC10	Horn	H	78.20		HH	8.69				

BC10 EVDO Mode

										Substitution Method			
EUT				Receive Antenna		Spectrum Analyzer		Tracking Generator					
Type	Ch	Frequency (MHz)	Band	Type	Pol.	Reading (dBuV)	Max (V,H) (dBuV)	Pol. Tx-Rx	Reading (dBm)	(dBm)	(W)	Limit (dBm)	Diff to Limit (dB)
F0	476	817.90	BC10	Horn	V	57.90	78.50	VV	10.45	27.92	0.62	39.00	11.08
F0	476	817.90	BC10	Horn	H	78.50		HH	9.00				
F0	580	820.50	BC10	Horn	V	57.37	78.77	VV	10.50	28.21	0.66	39.00	10.79
F0	580	820.50	BC10	Horn	H	78.77		HH	9.08				
F0	684	823.10	BC10	Horn	V	57.93	77.91	VV	9.92	27.68	0.59	39.00	11.32
F0	684	823.10	BC10	Horn	H	77.91		HH	8.42				

