	Document <b>Appendix C2 for the BlackBerry® Smartphone Model REY21CW SAR Report</b>			Page <b>1(48)</b>
	Author Data <b>Andrew Becker</b>	Dates of Test <b>February 23 – March 6 , 2012</b>	Test Report No <b>RTS-5994-1203-47</b>	FCC ID: <b>L6AREY20CW</b>

**APPENDIX C2: SAR DISTRIBUTION PLOTS FOR MOBILE HOT SPOT**

	Document <b>Appendix C2 for the BlackBerry® Smartphone Model REY21CW SAR Report</b>			Page <b>2(48)</b>
	Author Data <b>Andrew Becker</b>	Dates of Test <b>February 23 – March 6 , 2012</b>	Test Report No <b>RTS-5994-1203-47</b>	FCC ID: <b>L6AREY20CW</b>

Date/Time: 2/27/2012 4:54:00 PM

Test Laboratory: RIM Testing Services

**MHS\_Back\_CDMA850\_low\_chan\_amb\_temp\_22.8C\_liq\_temp\_20.5C**

**DUT: BlackBerry Smartphone; Type: Sample ; Serial: 297DF9E4**

Communication System: CDMA 850; Frequency: 824.7 MHz

Medium parameters used:  $f = 825$  MHz;  $\sigma = 0.967$  mho/m;  $\epsilon_r = 54.748$ ;  $\rho = 1000$  kg/m<sup>3</sup>

Phantom section: Flat Section

Measurement Standard: DASYS (IEEE/IEC/ANSI C63.19-2007)

DASY Configuration:

- Probe: ES3DV3 - SN3225; ConvF(6.07, 6.07, 6.07); Calibrated: 1/11/2012
- Sensor-Surface: 3mm (Mechanical Surface Detection),  $z = 2.0, 32.0$
- Electronics: DAE3 Sn473; Calibrated: 1/13/2012
- Phantom: SAM 2; Type: SAM 4.0; Serial: 1080
- DASYS2 52.8.0(692); SEMCAD X 14.6.4(4989)

**Configuration/Touch position -/Area Scan (61x91x1):** Measurement grid:

$dx=15$ mm,  $dy=15$ mm

Maximum value of SAR (interpolated) = 1.172 mW/g

**Configuration/Touch position -/Zoom Scan (5x5x7) (6x7x7)/Cube 0:**

Measurement grid:  $dx=7.5$ mm,  $dy=7.5$ mm,  $dz=5$ mm

Reference Value = 31.508 V/m; Power Drift = -0.08 dB

Peak SAR (extrapolated) = 1.4770

**SAR(1 g) = 1.01 mW/g; SAR(10 g) = 0.732 mW/g**

Maximum value of SAR (measured) = 1.175 mW/g

Author Data  
**Andrew Becker**

Dates of Test  
**February 23 – March 6 , 2012**

Test Report No  
**RTS-5994-1203-47**

FCC ID:  
**L6AREY20CW**

IC ID  
**2503A-REY20CW**

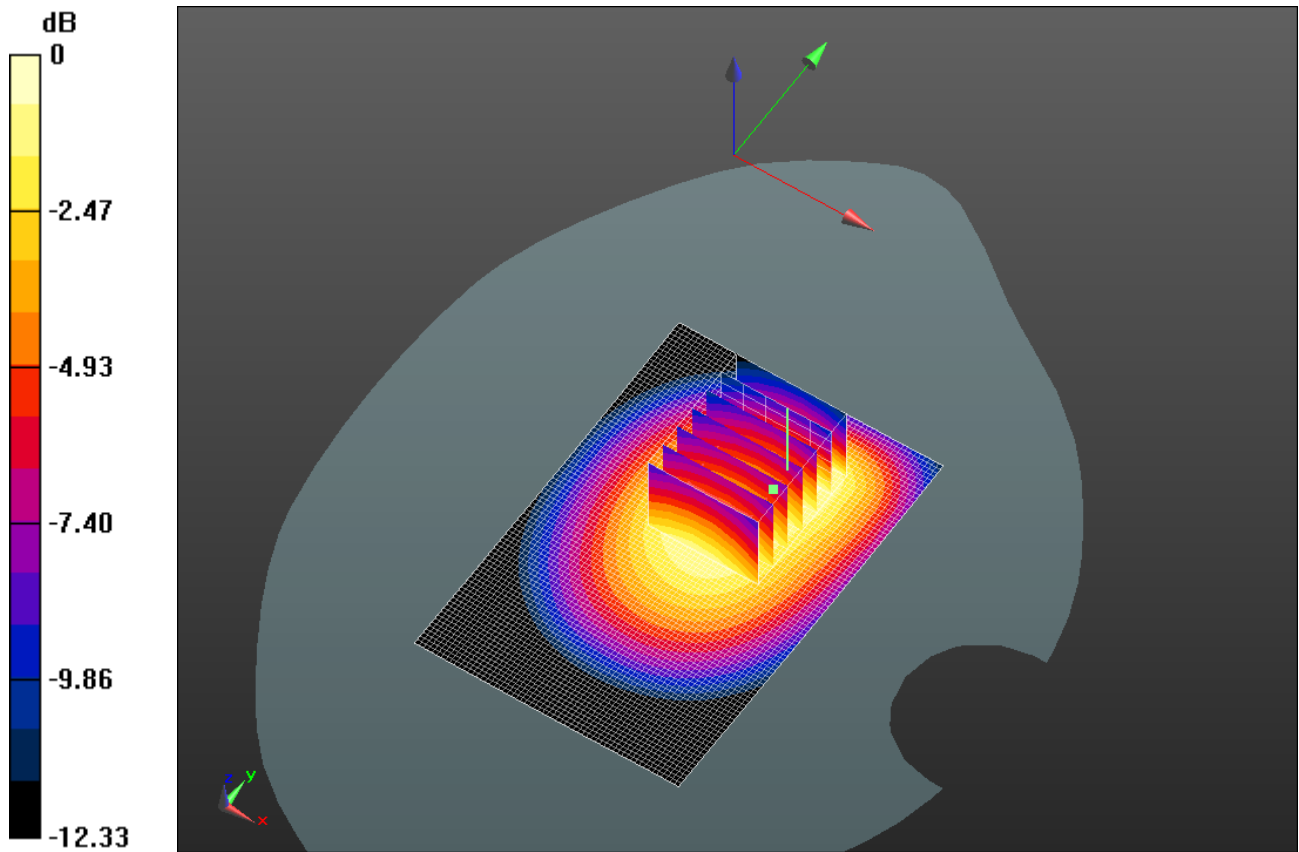

0 dB = 1.170mW/g = 1.36 dB mW/g

	Document <b>Appendix C2 for the BlackBerry® Smartphone Model REY21CW SAR Report</b>			Page <b>4(48)</b>
	Author Data <b>Andrew Becker</b>	Dates of Test <b>February 23 – March 6 , 2012</b>	Test Report No <b>RTS-5994-1203-47</b>	FCC ID: <b>L6AREY20CW</b>

Date/Time: 2/27/2012 4:29:51 PM

Test Laboratory: RIM Testing Services

## MHS\_Back\_CDMA850\_mid\_chan\_amb\_temp\_22.8C\_liq\_temp\_20.5C

**DUT: BlackBerry Smartphone; Type: Sample ; Serial: 297DF9E4**

Communication System: CDMA 850; Frequency: 836.52 MHz

Medium parameters used (interpolated):  $f = 836.52$  MHz;  $\sigma = 0.977$  mho/m;  $\epsilon_r = 54.633$ ;  
 $\rho = 1000$  kg/m<sup>3</sup>

Phantom section: Flat Section

Measurement Standard: DASYS (IEEE/IEC/ANSI C63.19-2007)

DASY Configuration:

- Probe: ES3DV3 - SN3225; ConvF(6.07, 6.07, 6.07); Calibrated: 1/11/2012
- Sensor-Surface: 3mm (Mechanical Surface Detection),  $z = 2.0, 32.0$
- Electronics: DAE3 Sn473; Calibrated: 1/13/2012
- Phantom: SAM 2; Type: SAM 4.0; Serial: 1080
- DASYS2 52.8.0(692); SEMCAD X 14.6.4(4989)

**Configuration/Touch position -/Area Scan (61x91x1):** Measurement grid:  
 $dx=15$ mm,  $dy=15$ mm

[Info: Interpolated medium parameters used for SAR evaluation.](#)

Maximum value of SAR (interpolated) = 1.083 mW/g

**Configuration/Touch position -/Zoom Scan (5x5x7) (6x7x7)/Cube 0:**

Measurement grid:  $dx=7.5$ mm,  $dy=7.5$ mm,  $dz=5$ mm

Reference Value = 30.480 V/m; Power Drift = 0.01 dB

Peak SAR (extrapolated) = 1.3240

**SAR(1 g) = 0.943 mW/g; SAR(10 g) = 0.682 mW/g**

[Info: Interpolated medium parameters used for SAR evaluation.](#)

Maximum value of SAR (measured) = 1.068 mW/g

Author Data  
**Andrew Becker**

Dates of Test  
**February 23 – March 6 , 2012**

Test Report No  
**RTS-5994-1203-47**

FCC ID:  
**L6AREY20CW**

IC ID  
**2503A-REY20CW**

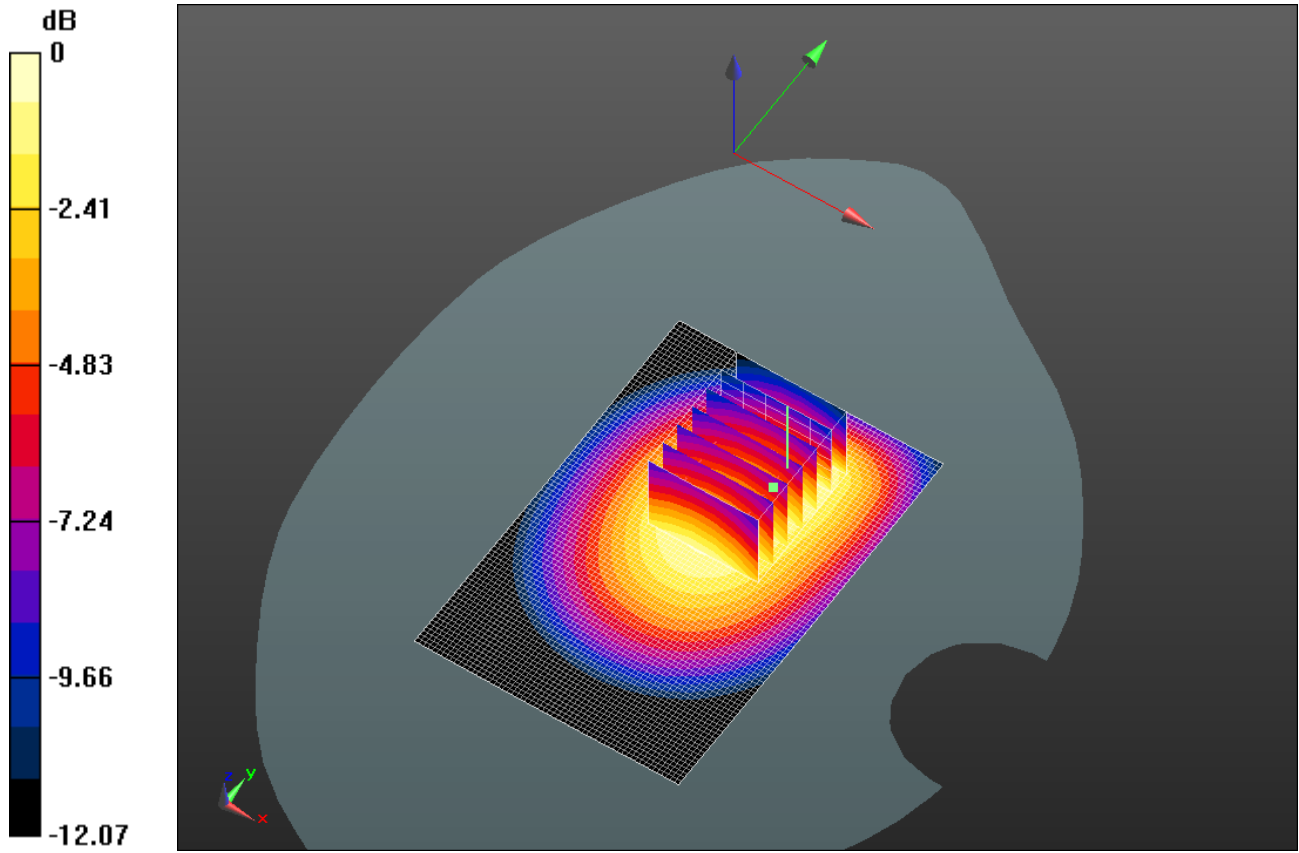

0 dB = 1.070mW/g = 0.59 dB mW/g

	Document <b>Appendix C2 for the BlackBerry® Smartphone Model REY21CW SAR Report</b>			Page <b>6(48)</b>
	Author Data <b>Andrew Becker</b>	Dates of Test <b>February 23 – March 6 , 2012</b>	Test Report No <b>RTS-5994-1203-47</b>	FCC ID: <b>L6AREY20CW</b>

Date/Time: 2/27/2012 5:16:10 PM

Test Laboratory: RIM Testing Services

## MHS\_Back\_CDMA850\_high\_chan\_amb\_temp\_22.9C\_liq\_temp\_20.5C

**DUT: BlackBerry Smartphone; Type: Sample ; Serial: 297DF9E4**

Communication System: CDMA 850; Frequency: 848.52 MHz

Medium parameters used (interpolated):  $f = 848.52$  MHz;  $\sigma = 0.99$  mho/m;  $\epsilon_r = 54.554$ ;  $\rho = 1000$  kg/m<sup>3</sup>

Phantom section: Flat Section

Measurement Standard: DASY5 (IEEE/IEC/ANSI C63.19-2007)

DASY Configuration:

- Probe: ES3DV3 - SN3225; ConvF(6.07, 6.07, 6.07); Calibrated: 1/11/2012
- Sensor-Surface: 3mm (Mechanical Surface Detection),  $z = 2.0, 32.0$
- Electronics: DAE3 Sn473; Calibrated: 1/13/2012
- Phantom: SAM 2; Type: SAM 4.0; Serial: 1080
- DASY52 52.8.0(692); SEMCAD X 14.6.4(4989)

**Configuration/Touch position -/Area Scan (61x91x1):** Measurement grid:  
 $dx=15$ mm,  $dy=15$ mm

[Info: Interpolated medium parameters used for SAR evaluation.](#)

Maximum value of SAR (interpolated) = 0.955 mW/g

**Configuration/Touch position -/Zoom Scan (5x5x7) (6x7x7)/Cube 0:**

Measurement grid:  $dx=7.5$ mm,  $dy=7.5$ mm,  $dz=5$ mm

Reference Value = 27.913 V/m; Power Drift = 0.02 dB

Peak SAR (extrapolated) = 1.2390

**SAR(1 g) = 0.821 mW/g; SAR(10 g) = 0.586 mW/g**

[Info: Interpolated medium parameters used for SAR evaluation.](#)

Maximum value of SAR (measured) = 0.961 mW/g

Author Data  
**Andrew Becker**

Dates of Test  
**February 23 – March 6 , 2012**

Test Report No  
**RTS-5994-1203-47**

FCC ID:  
**L6AREY20CW**

IC ID  
**2503A-REY20CW**

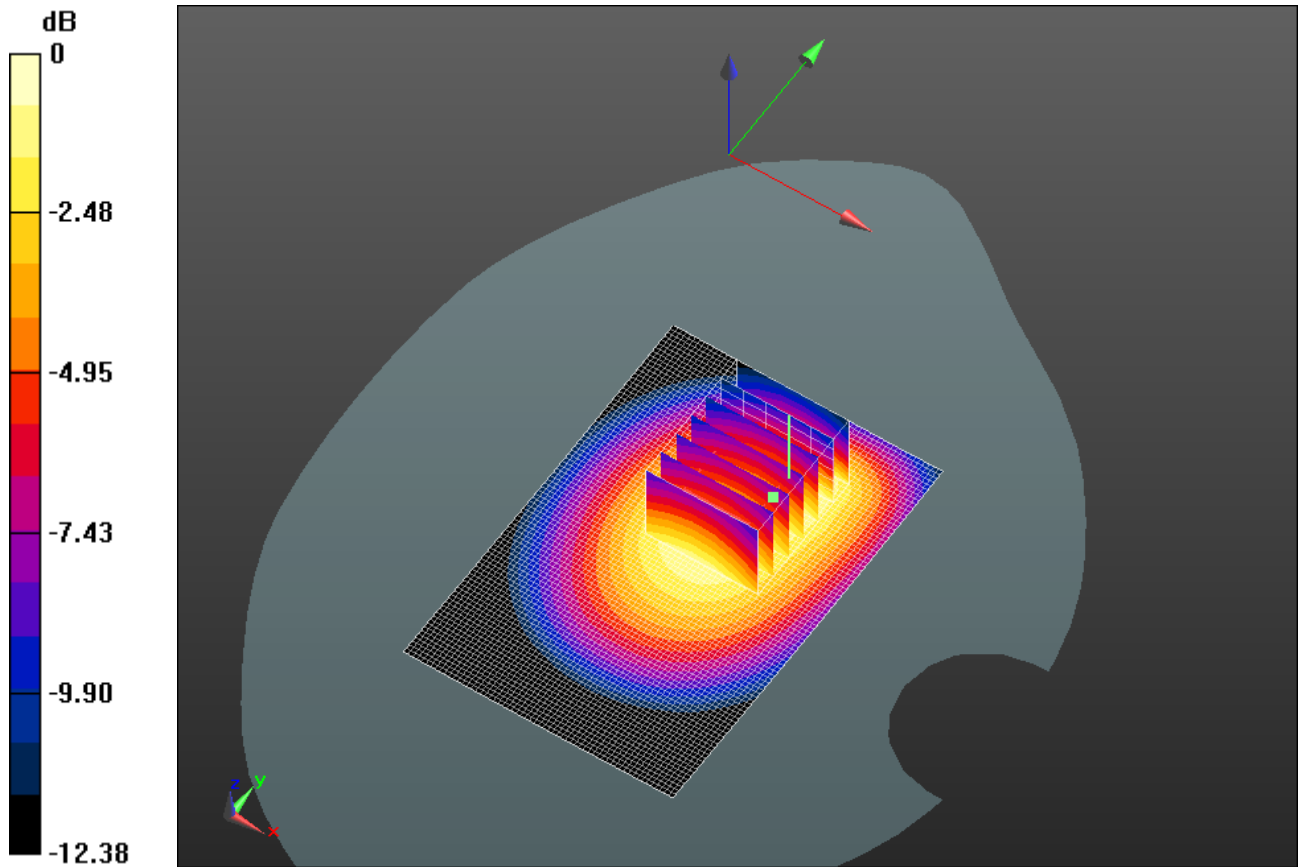

0 dB = 0.960mW/g = -0.35 dB mW/g

	Document <b>Appendix C2 for the BlackBerry® Smartphone Model REY21CW SAR Report</b>			Page <b>8(48)</b>
	Author Data <b>Andrew Becker</b>	Dates of Test <b>February 23 – March 6 , 2012</b>	Test Report No <b>RTS-5994-1203-47</b>	FCC ID: <b>L6AREY20CW</b>

Date/Time: 2/27/2012 6:21:00 PM

Test Laboratory: RIM Testing Services

**MHS\_Front\_CDMA850\_low\_chan\_amb\_temp\_22.9C\_liq\_temp\_20.5C**

**DUT: BlackBerry Smartphone; Type: Sample ; Serial: 297DF9E4**

Communication System: CDMA 850; Frequency: 824.7 MHz

Medium parameters used:  $f = 825$  MHz;  $\sigma = 0.967$  mho/m;  $\epsilon_r = 54.748$ ;  $\rho = 1000$  kg/m<sup>3</sup>

Phantom section: Flat Section

Measurement Standard: DASYS (IEEE/IEC/ANSI C63.19-2007)

DASY Configuration:

- Probe: ES3DV3 - SN3225; ConvF(6.07, 6.07, 6.07); Calibrated: 1/11/2012
- Sensor-Surface: 3mm (Mechanical Surface Detection),  $z = 2.0, 32.0$
- Electronics: DAE3 Sn473; Calibrated: 1/13/2012
- Phantom: SAM 2; Type: SAM 4.0; Serial: 1080
- DASYS2 52.8.0(692); SEMCAD X 14.6.4(4989)

**Configuration/Touch position -/Area Scan (61x91x1):** Measurement grid:

$dx=15$ mm,  $dy=15$ mm

Maximum value of SAR (interpolated) = 0.919 mW/g

**Configuration/Touch position -/Zoom Scan (5x5x7) (5x5x7)/Cube 0:**

Measurement grid:  $dx=7.5$ mm,  $dy=7.5$ mm,  $dz=5$ mm

Reference Value = 29.544 V/m; Power Drift = -0.07 dB

Peak SAR (extrapolated) = 1.0560

**SAR(1 g) = 0.833 mW/g; SAR(10 g) = 0.623 mW/g**

Maximum value of SAR (measured) = 0.915 mW/g



Author Data  
**Andrew Becker**

Dates of Test  
**February 23 – March 6 , 2012**

Test Report No  
**RTS-5994-1203-47**

FCC ID:  
**L6AREY20CW**

IC ID  
**2503A-REY20CW**

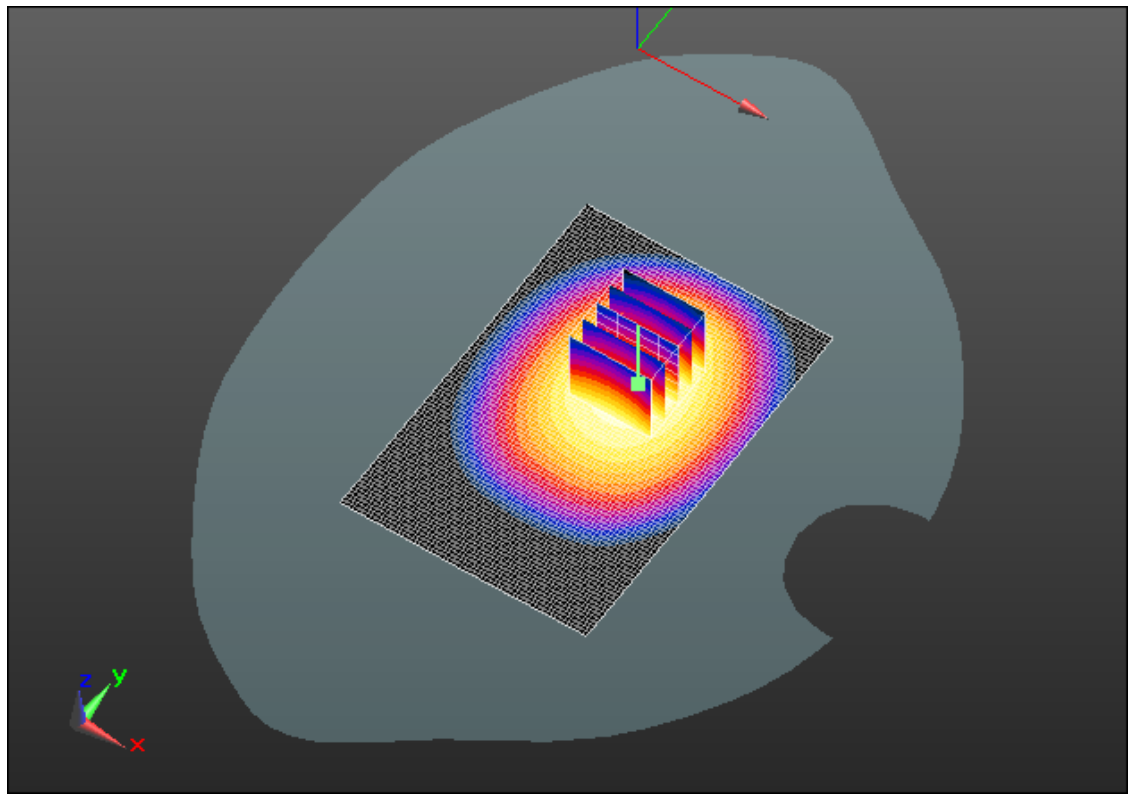
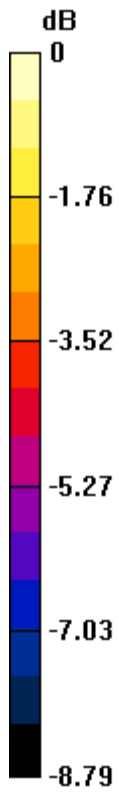

0 dB = 0.920mW/g = -0.72 dB mW/g

	Document <b>Appendix C2 for the BlackBerry® Smartphone Model REY21CW SAR Report</b>			Page <b>10(48)</b>
	Author Data <b>Andrew Becker</b>	Dates of Test <b>February 23 – March 6 , 2012</b>	Test Report No <b>RTS-5994-1203-47</b>	FCC ID: <b>L6AREY20CW</b>

Date/Time: 2/27/2012 6:01:47 PM

Test Laboratory: RIM Testing Services

## MHS\_Front\_CDMA850\_mid\_chan\_amb\_temp\_22.9C\_liq\_temp\_20.5C

**DUT: BlackBerry Smartphone; Type: Sample ; Serial: 297DF9E4**

Communication System: CDMA 850; Frequency: 836.52 MHz

Medium parameters used (interpolated):  $f = 836.52$  MHz;  $\sigma = 0.977$  mho/m;  $\epsilon_r = 54.633$ ;  
 $\rho = 1000$  kg/m<sup>3</sup>

Phantom section: Flat Section

Measurement Standard: DASYS (IEEE/IEC/ANSI C63.19-2007)

DASY Configuration:

- Probe: ES3DV3 - SN3225; ConvF(6.07, 6.07, 6.07); Calibrated: 1/11/2012
- Sensor-Surface: 3mm (Mechanical Surface Detection),  $z = 2.0, 32.0$
- Electronics: DAE3 Sn473; Calibrated: 1/13/2012
- Phantom: SAM 2; Type: SAM 4.0; Serial: 1080
- DASYS2 52.8.0(692); SEMCAD X 14.6.4(4989)

**Configuration/Touch position -/Area Scan (61x91x1):** Measurement grid:  
 $dx=15$ mm,  $dy=15$ mm

[Info: Interpolated medium parameters used for SAR evaluation.](#)

Maximum value of SAR (interpolated) = 0.884 mW/g

**Configuration/Touch position -/Zoom Scan (5x5x7) (5x5x7)/Cube 0:**

Measurement grid:  $dx=7.5$ mm,  $dy=7.5$ mm,  $dz=5$ mm

Reference Value = 28.472 V/m; Power Drift = 0.19 dB

Peak SAR (extrapolated) = 1.0470

**SAR(1 g) = 0.813 mW/g; SAR(10 g) = 0.606 mW/g**

[Info: Interpolated medium parameters used for SAR evaluation.](#)

Maximum value of SAR (measured) = 0.901 mW/g

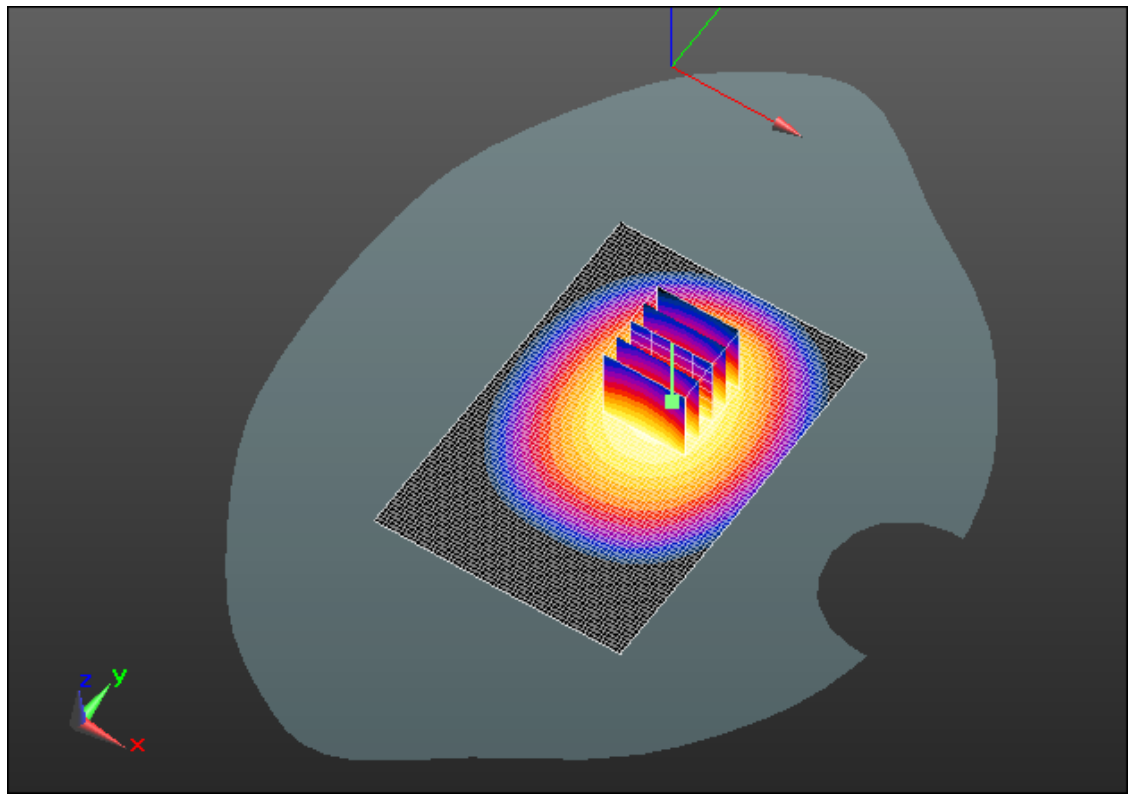
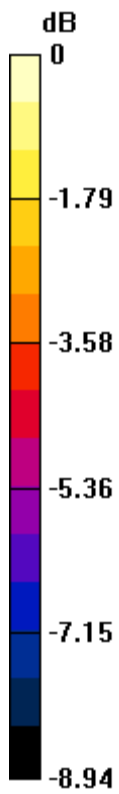

0 dB = 0.900mW/g = -0.92 dB mW/g

	Document <b>Appendix C2 for the BlackBerry® Smartphone Model REY21CW SAR Report</b>			Page <b>12(48)</b>
	Author Data <b>Andrew Becker</b>	Dates of Test <b>February 23 – March 6 , 2012</b>	Test Report No <b>RTS-5994-1203-47</b>	FCC ID: <b>L6AREY20CW</b>

Date/Time: 2/27/2012 6:37:11 PM

Test Laboratory: RIM Testing Services

## MHS\_Front\_CDMA850\_high\_chan\_amb\_temp\_22.9C\_liq\_temp\_20.5C

**DUT: BlackBerry Smartphone; Type: Sample ; Serial: 297DF9E4**

Communication System: CDMA 850; Frequency: 848.52 MHz

Medium parameters used (interpolated):  $f = 848.52$  MHz;  $\sigma = 0.99$  mho/m;  $\epsilon_r = 54.554$ ;  $\rho = 1000$  kg/m<sup>3</sup>

Phantom section: Flat Section

Measurement Standard: DASYS (IEEE/IEC/ANSI C63.19-2007)

DASY Configuration:

- Probe: ES3DV3 - SN3225; ConvF(6.07, 6.07, 6.07); Calibrated: 1/11/2012
- Sensor-Surface: 3mm (Mechanical Surface Detection),  $z = 2.0, 32.0$
- Electronics: DAE3 Sn473; Calibrated: 1/13/2012
- Phantom: SAM 2; Type: SAM 4.0; Serial: 1080
- DASYS2 52.8.0(692); SEMCAD X 14.6.4(4989)

**Configuration/Touch position -/Area Scan (61x91x1):** Measurement grid:  
 $dx=15$ mm,  $dy=15$ mm

[Info: Interpolated medium parameters used for SAR evaluation.](#)

Maximum value of SAR (interpolated) = 0.749 mW/g

**Configuration/Touch position -/Zoom Scan (5x5x7) (5x5x7)/Cube 0:**

Measurement grid:  $dx=7.5$ mm,  $dy=7.5$ mm,  $dz=5$ mm

Reference Value = 26.348 V/m; Power Drift = -0.0038 dB

Peak SAR (extrapolated) = 0.8700

**SAR(1 g) = 0.675 mW/g; SAR(10 g) = 0.502 mW/g**

[Info: Interpolated medium parameters used for SAR evaluation.](#)

Maximum value of SAR (measured) = 0.745 mW/g

Author Data  
**Andrew Becker**

Dates of Test  
**February 23 – March 6 , 2012**

Test Report No  
**RTS-5994-1203-47**

FCC ID:  
**L6AREY20CW**

IC ID  
**2503A-REY20CW**

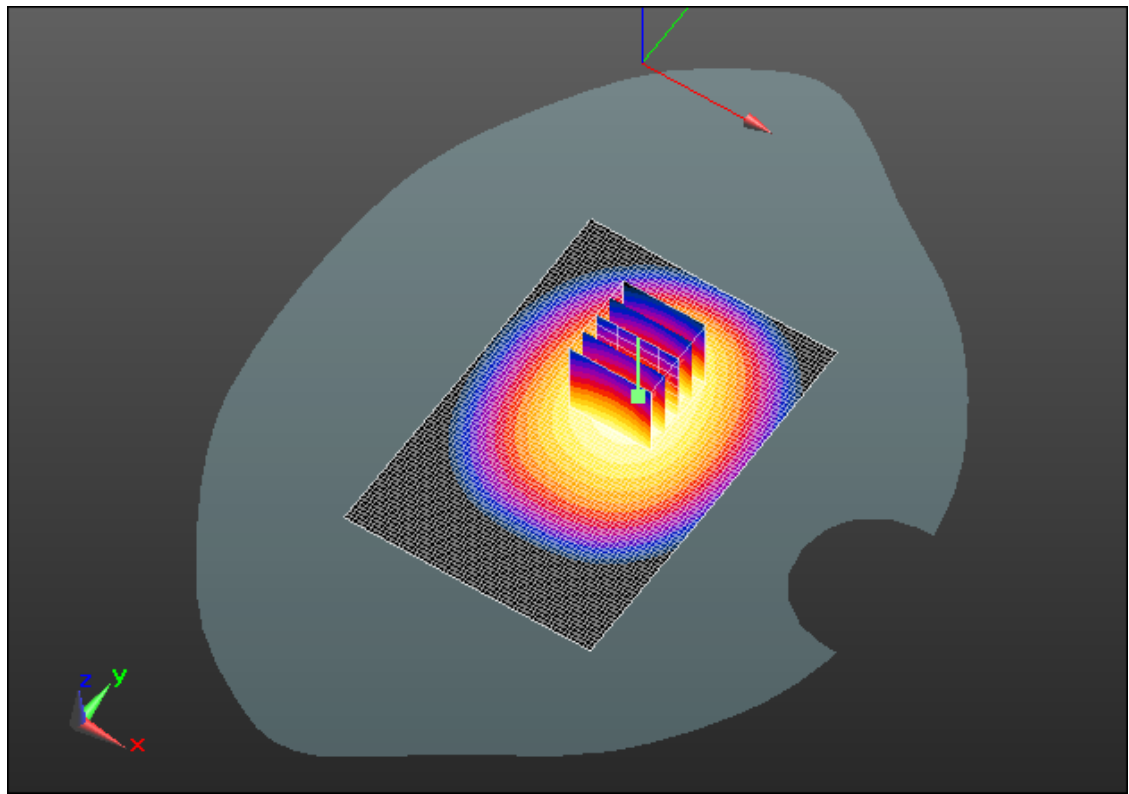
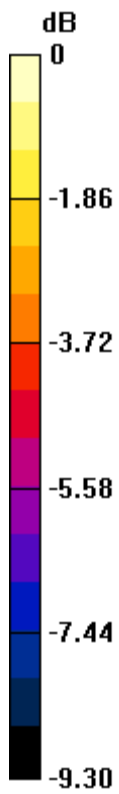

0 dB = 0.750mW/g = -2.50 dB mW/g

	Document <b>Appendix C2 for the BlackBerry® Smartphone Model REY21CW SAR Report</b>			Page <b>14(48)</b>
	Author Data <b>Andrew Becker</b>	Dates of Test <b>February 23 – March 6 , 2012</b>	Test Report No <b>RTS-5994-1203-47</b>	FCC ID: <b>L6AREY20CW</b>

Date/Time: 2/27/2012 7:06:49 PM

Test Laboratory: RIM Testing Services

## MHS\_Right\_CDMA850\_mid\_chan\_amb\_temp\_22.8C\_liq\_temp\_20.5C

**DUT: BlackBerry Smartphone; Type: Sample ; Serial: 297DF9E4**

Communication System: CDMA 850; Frequency: 836.52 MHz

Medium parameters used (interpolated):  $f = 836.52$  MHz;  $\sigma = 0.977$  mho/m;  $\epsilon_r = 54.633$ ;  
 $\rho = 1000$  kg/m<sup>3</sup>

Phantom section: Flat Section

Measurement Standard: DASYS (IEEE/IEC/ANSI C63.19-2007)

DASY Configuration:

- Probe: ES3DV3 - SN3225; ConvF(6.07, 6.07, 6.07); Calibrated: 1/11/2012
- Sensor-Surface: 3mm (Mechanical Surface Detection),  $z = 2.0, 32.0$
- Electronics: DAE3 Sn473; Calibrated: 1/13/2012
- Phantom: SAM 2; Type: SAM 4.0; Serial: 1080
- DASYS2 52.8.0(692); SEMCAD X 14.6.4(4989)

**Configuration/Touch position -/Area Scan (31x101x1):** Measurement grid:  
 $dx=15$ mm,  $dy=15$ mm

[Info: Interpolated medium parameters used for SAR evaluation.](#)

Maximum value of SAR (interpolated) = 0.597 mW/g

**Configuration/Touch position -/Zoom Scan (5x5x7) (5x5x7)/Cube 0:**

Measurement grid:  $dx=7.5$ mm,  $dy=7.5$ mm,  $dz=5$ mm

Reference Value = 25.317 V/m; Power Drift = 0.14 dB

Peak SAR (extrapolated) = 0.7480

**SAR(1 g) = 0.546 mW/g; SAR(10 g) = 0.384 mW/g**

[Info: Interpolated medium parameters used for SAR evaluation.](#)

Maximum value of SAR (measured) = 0.620 mW/g

Author Data  
**Andrew Becker**

Dates of Test  
**February 23 – March 6 , 2012**

Test Report No  
**RTS-5994-1203-47**

FCC ID:  
**L6AREY20CW**

IC ID  
**2503A-REY20CW**

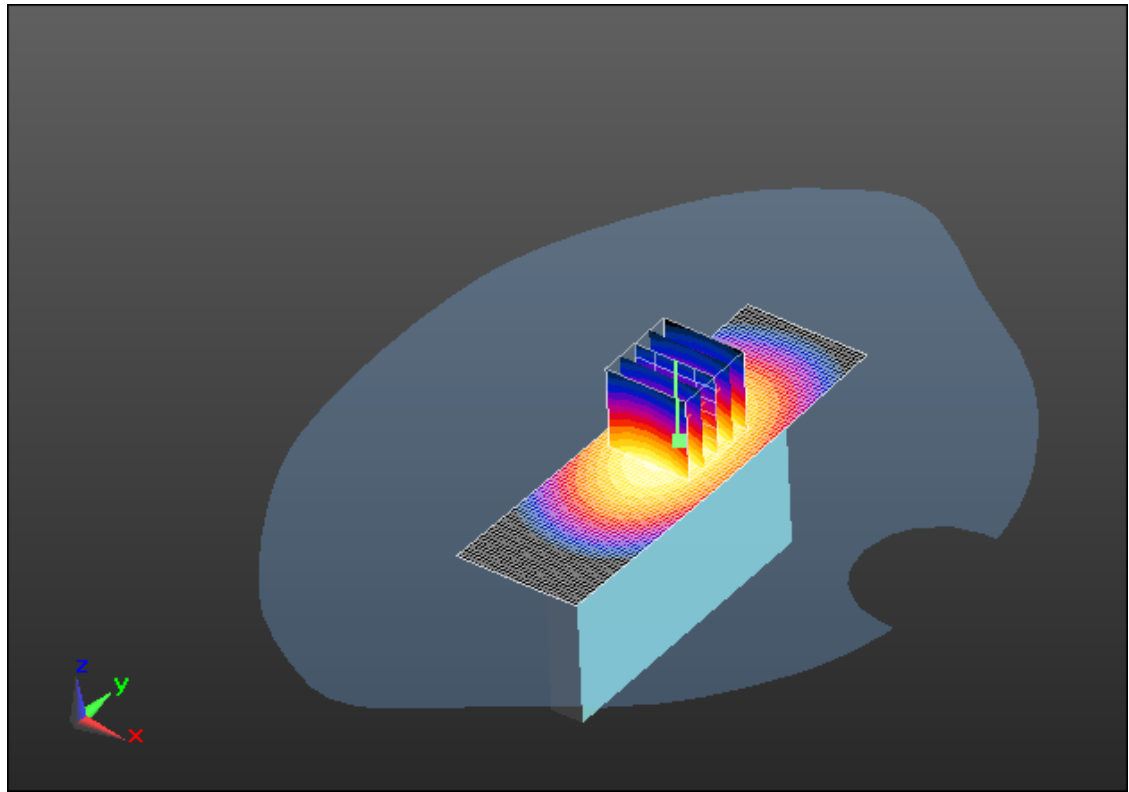
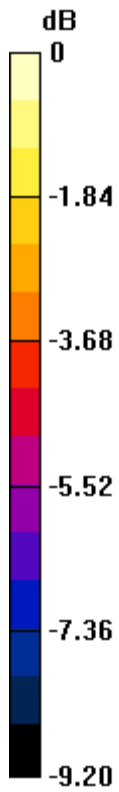

0 dB = 0.620mW/g = -4.15 dB mW/g

	Document <b>Appendix C2 for the BlackBerry® Smartphone Model REY21CW SAR Report</b>			Page <b>16(48)</b>
	Author Data <b>Andrew Becker</b>	Dates of Test <b>February 23 – March 6 , 2012</b>	Test Report No <b>RTS-5994-1203-47</b>	FCC ID: <b>L6AREY20CW</b>

Date/Time: 2/27/2012 7:26:27 PM

Test Laboratory: RIM Testing Services

## MHS\_Left\_CDMA850\_mid\_chan\_amb\_temp\_22.8C\_liq\_temp\_20.5C

**DUT: BlackBerry Smartphone; Type: Sample ; Serial: 297DF9E4**

Communication System: CDMA 850; Frequency: 836.52 MHz

Medium parameters used (interpolated):  $f = 836.52$  MHz;  $\sigma = 0.977$  mho/m;  $\epsilon_r = 54.633$ ;  
 $\rho = 1000$  kg/m<sup>3</sup>

Phantom section: Flat Section

Measurement Standard: DASY5 (IEEE/IEC/ANSI C63.19-2007)

DASY Configuration:

- Probe: ES3DV3 - SN3225; ConvF(6.07, 6.07, 6.07); Calibrated: 1/11/2012
- Sensor-Surface: 3mm (Mechanical Surface Detection),  $z = 2.0, 32.0$
- Electronics: DAE3 Sn473; Calibrated: 1/13/2012
- Phantom: SAM 2; Type: SAM 4.0; Serial: 1080
- DASY52 52.8.0(692); SEMCAD X 14.6.4(4989)

**Configuration/Touch position -/Area Scan (31x101x1):** Measurement grid:  
 $dx=15$ mm,  $dy=15$ mm

[Info: Interpolated medium parameters used for SAR evaluation.](#)

Maximum value of SAR (interpolated) = 0.638 mW/g

**Configuration/Touch position -/Zoom Scan (5x5x7) (5x5x7)/Cube 0:**

Measurement grid:  $dx=7.5$ mm,  $dy=7.5$ mm,  $dz=5$ mm

Reference Value = 24.271 V/m; Power Drift = 0.05 dB

Peak SAR (extrapolated) = 0.7970

**SAR(1 g) = 0.564 mW/g; SAR(10 g) = 0.389 mW/g**

[Info: Interpolated medium parameters used for SAR evaluation.](#)

Maximum value of SAR (measured) = 0.647 mW/g



Author Data  
**Andrew Becker**

Dates of Test  
**February 23 – March 6 , 2012**

Test Report No  
**RTS-5994-1203-47**

FCC ID:  
**L6AREY20CW**

IC ID  
**2503A-REY20CW**

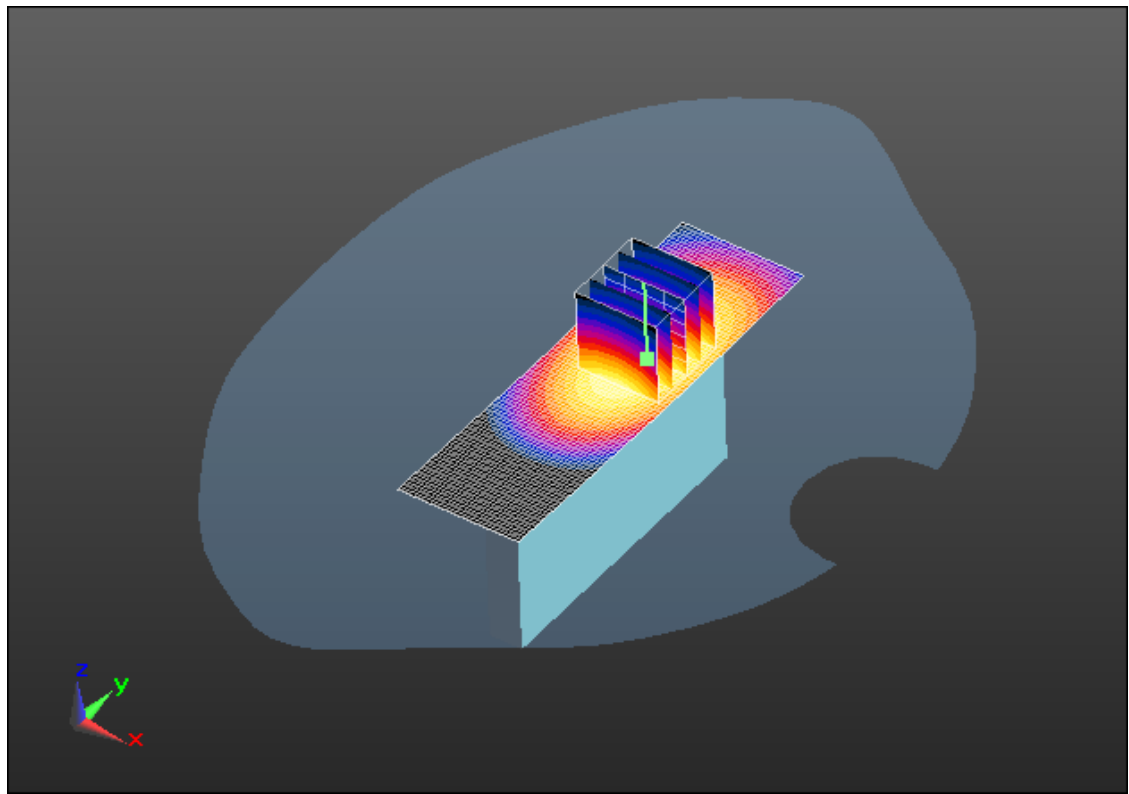

0 dB = 0.650mW/g = -3.74 dB mW/g

	Document <b>Appendix C2 for the BlackBerry® Smartphone Model REY21CW SAR Report</b>			Page <b>18(48)</b>
	Author Data <b>Andrew Becker</b>	Dates of Test <b>February 23 – March 6 , 2012</b>	Test Report No <b>RTS-5994-1203-47</b>	FCC ID: <b>L6AREY20CW</b>

Date/Time: 2/27/2012 9:01:19 PM

Test Laboratory: RIM Testing Services

## MHS\_Bottom\_CDMA850\_mid\_chan\_amb\_temp\_22.8C\_liq\_temp\_20.5C

**DUT: BlackBerry Smartphone; Type: Sample ; Serial: 297DF9E4**

Communication System: CDMA 850; Frequency: 836.52 MHz

Medium parameters used (interpolated):  $f = 836.52$  MHz;  $\sigma = 0.977$  mho/m;  $\epsilon_r = 54.633$ ;  
 $\rho = 1000$  kg/m<sup>3</sup>

Phantom section: Flat Section

Measurement Standard: DASYS (IEEE/IEC/ANSI C63.19-2007)

DASY Configuration:

- Probe: ES3DV3 - SN3225; ConvF(6.07, 6.07, 6.07); Calibrated: 1/11/2012
- Sensor-Surface: 3mm (Mechanical Surface Detection),  $z = 2.0, 32.0$
- Electronics: DAE3 Sn473; Calibrated: 1/13/2012
- Phantom: SAM 2; Type: SAM 4.0; Serial: 1080
- DASYS2 52.8.0(692); SEMCAD X 14.6.4(4989)

**Configuration/Touch position -/Area Scan (31x81x1):** Measurement grid:  
 $dx=15$ mm,  $dy=15$ mm

[Info: Interpolated medium parameters used for SAR evaluation.](#)

Maximum value of SAR (interpolated) = 0.117 mW/g

**Configuration/Touch position -/Zoom Scan (5x5x7) (6x6x7)/Cube 0:**

Measurement grid:  $dx=7.5$ mm,  $dy=7.5$ mm,  $dz=5$ mm

Reference Value = 10.896 V/m; Power Drift = 0.07 dB

Peak SAR (extrapolated) = 0.1960

**SAR(1 g) = 0.099 mW/g; SAR(10 g) = 0.066 mW/g**

[Info: Interpolated medium parameters used for SAR evaluation.](#)

Maximum value of SAR (measured) = 0.116 mW/g

Author Data  
**Andrew Becker**

Dates of Test  
**February 23 – March 6 , 2012**

Test Report No  
**RTS-5994-1203-47**

FCC ID:  
**L6AREY20CW**

IC ID  
**2503A-REY20CW**

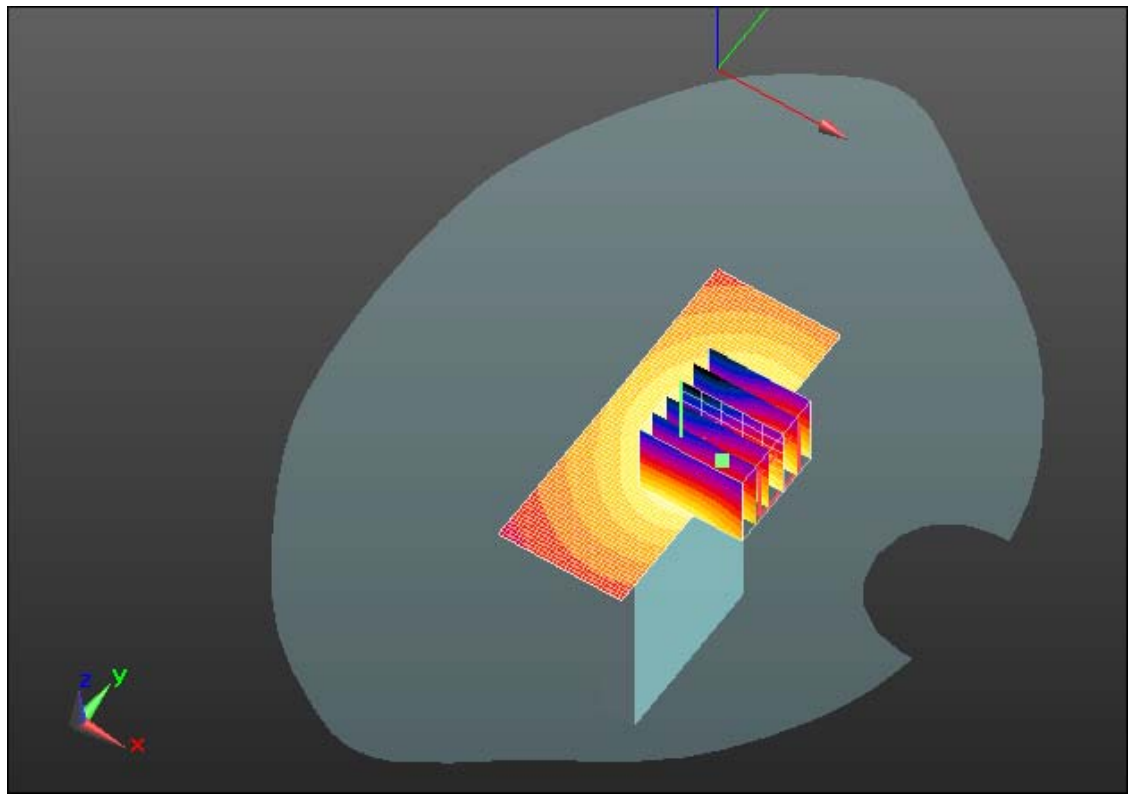
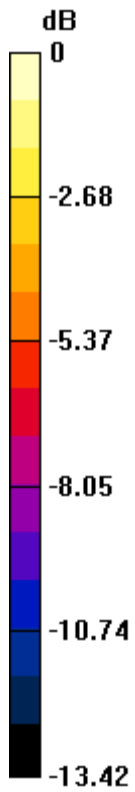

0 dB = 0.120mW/g = -18.42 dB mW/g

	Document <b>Appendix C2 for the BlackBerry® Smartphone Model REY21CW SAR Report</b>			Page <b>20(48)</b>
	Author Data <b>Andrew Becker</b>	Dates of Test <b>February 23 – March 6 , 2012</b>	Test Report No <b>RTS-5994-1203-47</b>	FCC ID: <b>L6AREY20CW</b>

Date/Time: 2/29/2012 1:05:27 AM

Test Laboratory: RIM Testing Services

## MHS\_Back\_CDMA1900\_mid\_chan\_amb\_temp\_22.6C\_liq\_temp\_20.0C

**DUT: BlackBerry Smartphone; Type: Sample ; Serial: 297DF9E4**

Communication System: CDMA 1900; Frequency: 1880 MHz

Medium parameters used:  $f = 1880$  MHz;  $\sigma = 1.563$  mho/m;  $\epsilon_r = 52.857$ ;  $\rho = 1000$  kg/m<sup>3</sup>

Phantom section: Flat Section

Measurement Standard: DASYS (IEEE/IEC/ANSI C63.19-2007)

DASY Configuration:

- Probe: ES3DV3 - SN3225; ConvF(4.92, 4.92, 4.92); Calibrated: 1/11/2012
- Sensor-Surface: 3mm (Mechanical Surface Detection),  $z = 2.0, 32.0$
- Electronics: DAE3 Sn473; Calibrated: 1/13/2012
- Phantom: SAM 2; Type: SAM 4.0; Serial: 1080
- DASYS2 52.8.0(692); SEMCAD X 14.6.4(4989)

**Configuration/Touch position -/Area Scan (61x91x1):** Measurement grid:

$dx=15$ mm,  $dy=15$ mm

Maximum value of SAR (interpolated) = 0.949 mW/g

**Configuration/Touch position -/Zoom Scan (5x5x7) (5x5x7)/Cube 0:**

Measurement grid:  $dx=7.5$ mm,  $dy=7.5$ mm,  $dz=5$ mm

Reference Value = 12.775 V/m; Power Drift = -0.03 dB

Peak SAR (extrapolated) = 1.2360

**SAR(1 g) = 0.742 mW/g; SAR(10 g) = 0.437 mW/g**

Maximum value of SAR (measured) = 0.902 mW/g

**Configuration/Touch position -/Zoom Scan 2 (5x5x7) (5x5x7)/Cube 0:**

Measurement grid:  $dx=7.5$ mm,  $dy=7.5$ mm,  $dz=5$ mm

Reference Value = 12.775 V/m; Power Drift = -0.03 dB

Peak SAR (extrapolated) = 0.7550

**SAR(1 g) = 0.503 mW/g; SAR(10 g) = 0.321 mW/g**

Maximum value of SAR (measured) = 0.586 mW/g

Author Data  
**Andrew Becker**

Dates of Test  
**February 23 – March 6 , 2012**

Test Report No  
**RTS-5994-1203-47**

FCC ID:  
**L6AREY20CW**

IC ID  
**2503A-REY20CW**

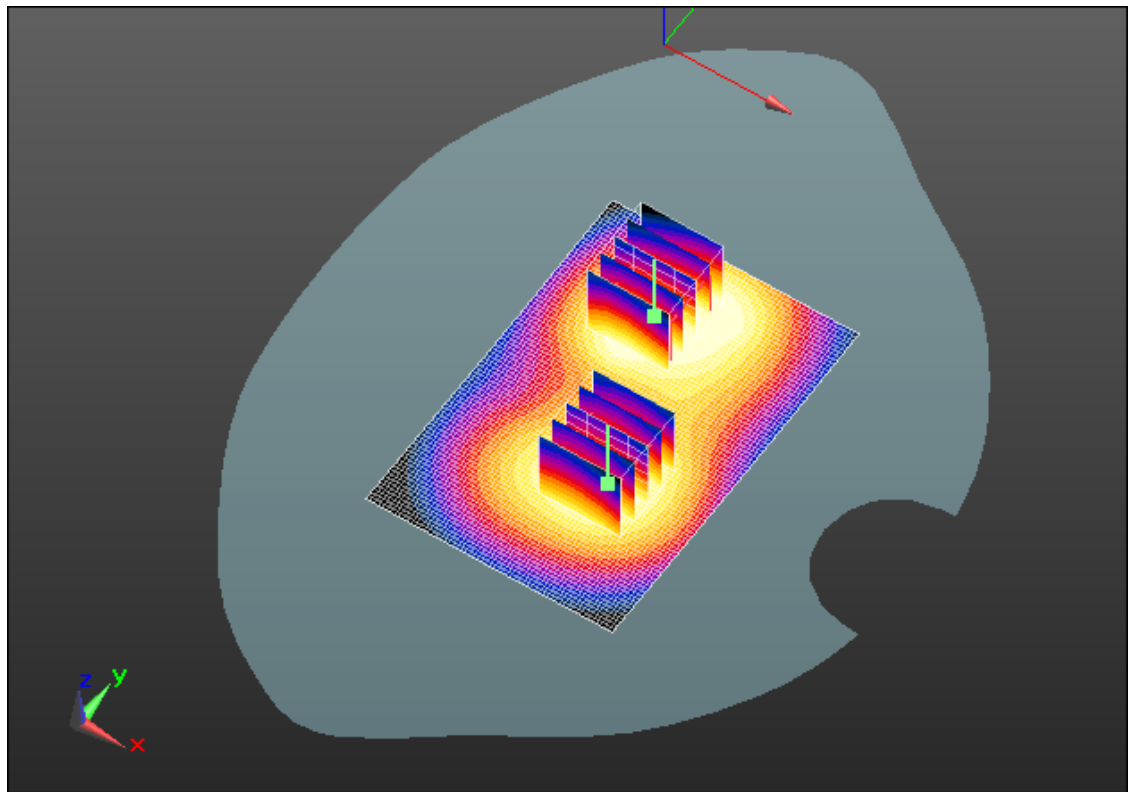
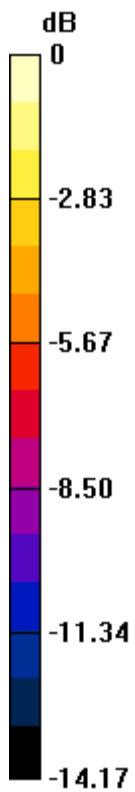

0 dB = 0.590mW/g = -4.58 dB mW/g

	Document <b>Appendix C2 for the BlackBerry® Smartphone Model REY21CW SAR Report</b>			Page <b>22(48)</b>
	Author Data <b>Andrew Becker</b>	Dates of Test <b>February 23 – March 6 , 2012</b>	Test Report No <b>RTS-5994-1203-47</b>	FCC ID: <b>L6AREY20CW</b>

Date/Time: 2/29/2012 1:29:43 AM

Test Laboratory: RIM Testing Services

**MHS\_Front\_CDMA1900\_mid\_chan\_amb\_temp\_22.6C\_liq\_temp\_20.0C**

**DUT: BlackBerry Smartphone; Type: Sample ; Serial: 297DF9E4**

Communication System: CDMA 1900; Frequency: 1880 MHz

Medium parameters used:  $f = 1880$  MHz;  $\sigma = 1.563$  mho/m;  $\epsilon_r = 52.857$ ;  $\rho = 1000$  kg/m<sup>3</sup>

Phantom section: Flat Section

Measurement Standard: DASYS (IEEE/IEC/ANSI C63.19-2007)

DASY Configuration:

- Probe: ES3DV3 - SN3225; ConvF(4.92, 4.92, 4.92); Calibrated: 1/11/2012
- Sensor-Surface: 3mm (Mechanical Surface Detection),  $z = 2.0, 32.0$
- Electronics: DAE3 Sn473; Calibrated: 1/13/2012
- Phantom: SAM 2; Type: SAM 4.0; Serial: 1080
- DASYS2 52.8.0(692); SEMCAD X 14.6.4(4989)

**Configuration/Touch position -/Area Scan (61x91x1):** Measurement grid:

$dx=15$ mm,  $dy=15$ mm

Maximum value of SAR (interpolated) = 0.771 mW/g

**Configuration/Touch position -/Zoom Scan (5x5x7) (5x5x7)/Cube 0:**

Measurement grid:  $dx=7.5$ mm,  $dy=7.5$ mm,  $dz=5$ mm

Reference Value = 15.184 V/m; Power Drift = -0.02 dB

Peak SAR (extrapolated) = 1.0490

**SAR(1 g) = 0.638 mW/g; SAR(10 g) = 0.384 mW/g**

Maximum value of SAR (measured) = 0.761 mW/g

**Configuration/Touch position -/Zoom Scan 2 (5x5x7) (5x5x7)/Cube 0:**

Measurement grid:  $dx=7.5$ mm,  $dy=7.5$ mm,  $dz=5$ mm

Reference Value = 15.184 V/m; Power Drift = 0.07 dB

Peak SAR (extrapolated) = 0.7320

**SAR(1 g) = 0.495 mW/g; SAR(10 g) = 0.323 mW/g**

Maximum value of SAR (measured) = 0.570 mW/g

Author Data  
**Andrew Becker**

Dates of Test  
**February 23 – March 6 , 2012**

Test Report No  
**RTS-5994-1203-47**

FCC ID:  
**L6AREY20CW**

IC ID  
**2503A-REY20CW**

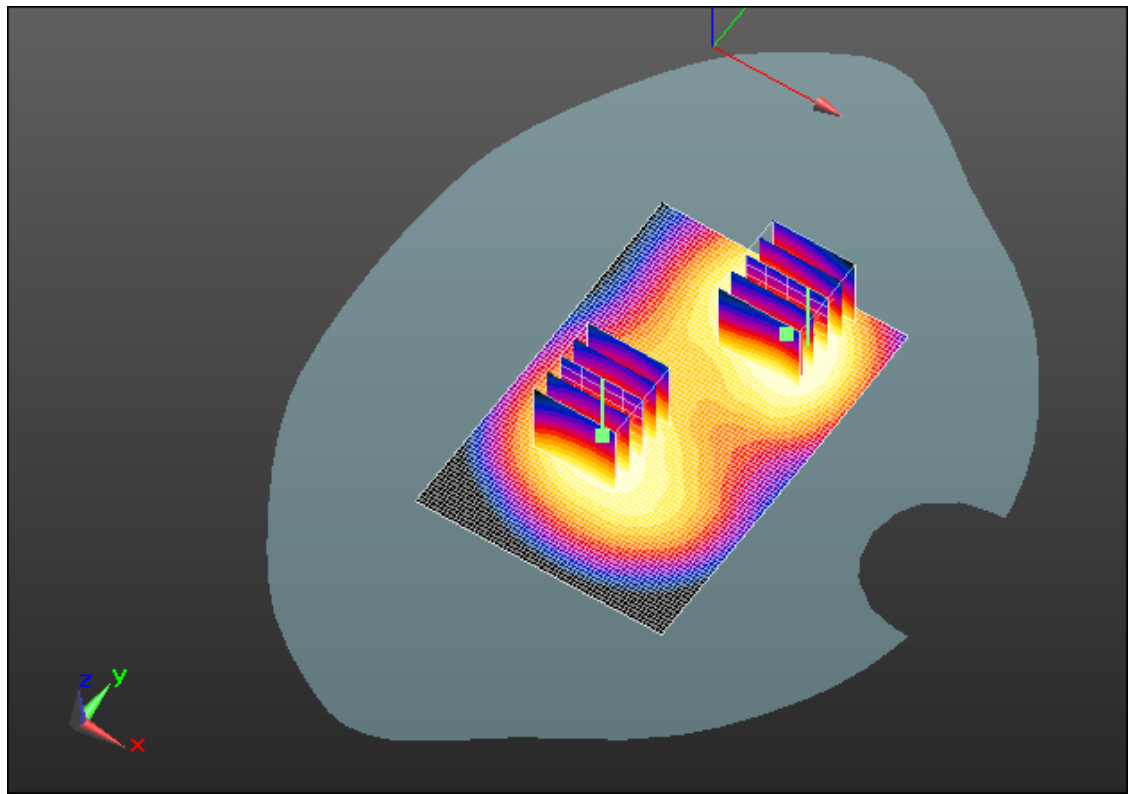
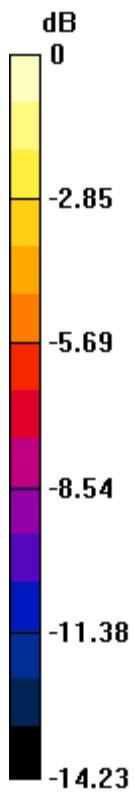

0 dB = 0.570mW/g = -4.88 dB mW/g

	Document <b>Appendix C2 for the BlackBerry® Smartphone Model REY21CW SAR Report</b>			Page <b>24(48)</b>
	Author Data <b>Andrew Becker</b>	Dates of Test <b>February 23 – March 6 , 2012</b>	Test Report No <b>RTS-5994-1203-47</b>	FCC ID: <b>L6AREY20CW</b>

Date/Time: 2/29/2012 5:26:49 PM

Test Laboratory: RIM Testing Services

**MHS\_Right\_CDMA1900\_mid\_chan\_amb\_temp\_23.2C\_liq\_temp\_21.5C**

**DUT: BlackBerry Smartphone; Type: Sample ; Serial: 297DF9E4**

Communication System: CDMA 1900; Frequency: 1880 MHz

Medium parameters used:  $f = 1880$  MHz;  $\sigma = 1.563$  mho/m;  $\epsilon_r = 52.857$ ;  $\rho = 1000$  kg/m<sup>3</sup>

Phantom section: Flat Section

Measurement Standard: DASYS (IEEE/IEC/ANSI C63.19-2007)

DASY Configuration:

- Probe: ES3DV3 - SN3225; ConvF(4.92, 4.92, 4.92); Calibrated: 1/11/2012
- Sensor-Surface: 3mm (Mechanical Surface Detection),  $z = 2.0, 32.0$
- Electronics: DAE3 Sn473; Calibrated: 1/13/2012
- Phantom: SAM 2; Type: SAM 4.0; Serial: 1080
- DASYS2 52.8.0(692); SEMCAD X 14.6.4(4989)

**Configuration/Touch position -/Area Scan (31x101x1):** Measurement grid:

$dx=15$ mm,  $dy=15$ mm

Maximum value of SAR (interpolated) = 0.286 mW/g

**Configuration/Touch position -/Zoom Scan (5x5x7) (5x5x7)/Cube 0:**

Measurement grid:  $dx=7.5$ mm,  $dy=7.5$ mm,  $dz=5$ mm

Reference Value = 12.730 V/m; Power Drift = -0.05 dB

Peak SAR (extrapolated) = 0.3700

**SAR(1 g) = 0.239 mW/g; SAR(10 g) = 0.145 mW/g**

Maximum value of SAR (measured) = 0.284 mW/g



Author Data  
**Andrew Becker**

Dates of Test  
**February 23 – March 6 , 2012**

Test Report No  
**RTS-5994-1203-47**

FCC ID:  
**L6AREY20CW**

IC ID  
**2503A-REY20CW**

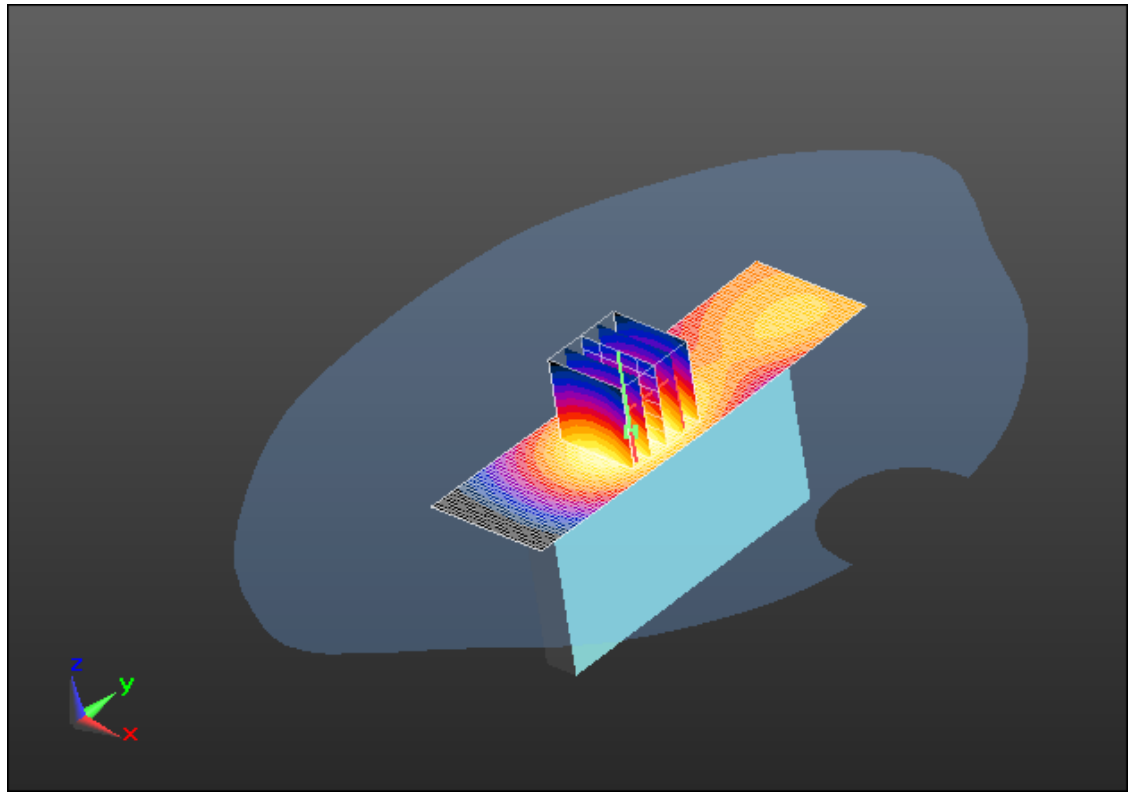
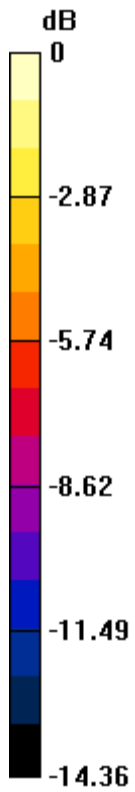

0 dB = 0.280mW/g = -11.06 dB mW/g

	Document <b>Appendix C2 for the BlackBerry® Smartphone Model REY21CW SAR Report</b>			Page <b>26(48)</b>
	Author Data <b>Andrew Becker</b>	Dates of Test <b>February 23 – March 6 , 2012</b>	Test Report No <b>RTS-5994-1203-47</b>	FCC ID: <b>L6AREY20CW</b>

Date/Time: 2/29/2012 6:13:03 PM

Test Laboratory: RIM Testing Services

**MHS\_Left\_CDMA1900\_mid\_chan\_amb\_temp\_23.0C\_liq\_temp\_21.5C**

**DUT: BlackBerry Smartphone; Type: Sample ; Serial: 297DF9E4**

Communication System: CDMA 1900; Frequency: 1880 MHz

Medium parameters used:  $f = 1880$  MHz;  $\sigma = 1.563$  mho/m;  $\epsilon_r = 52.857$ ;  $\rho = 1000$  kg/m<sup>3</sup>

Phantom section: Flat Section

Measurement Standard: DASYS (IEEE/IEC/ANSI C63.19-2007)

DASY Configuration:

- Probe: ES3DV3 - SN3225; ConvF(4.92, 4.92, 4.92); Calibrated: 1/11/2012
- Sensor-Surface: 3mm (Mechanical Surface Detection),  $z = 2.0, 32.0$
- Electronics: DAE3 Sn473; Calibrated: 1/13/2012
- Phantom: SAM 2; Type: SAM 4.0; Serial: 1080
- DASYS2 52.8.0(692); SEMCAD X 14.6.4(4989)

**Configuration/Touch position -/Area Scan (31x101x1):** Measurement grid:

$dx=15$ mm,  $dy=15$ mm

Maximum value of SAR (interpolated) = 0.273 mW/g

**Configuration/Touch position -/Zoom Scan (5x5x7) (5x5x7)/Cube 0:**

Measurement grid:  $dx=7.5$ mm,  $dy=7.5$ mm,  $dz=5$ mm

Reference Value = 8.812 V/m; Power Drift = -0.08 dB

Peak SAR (extrapolated) = 0.3490

**SAR(1 g) = 0.217 mW/g; SAR(10 g) = 0.125 mW/g**

Maximum value of SAR (measured) = 0.261 mW/g

Author Data  
**Andrew Becker**

Dates of Test  
**February 23 – March 6 , 2012**

Test Report No  
**RTS-5994-1203-47**

FCC ID:  
**L6AREY20CW**

IC ID  
**2503A-REY20CW**

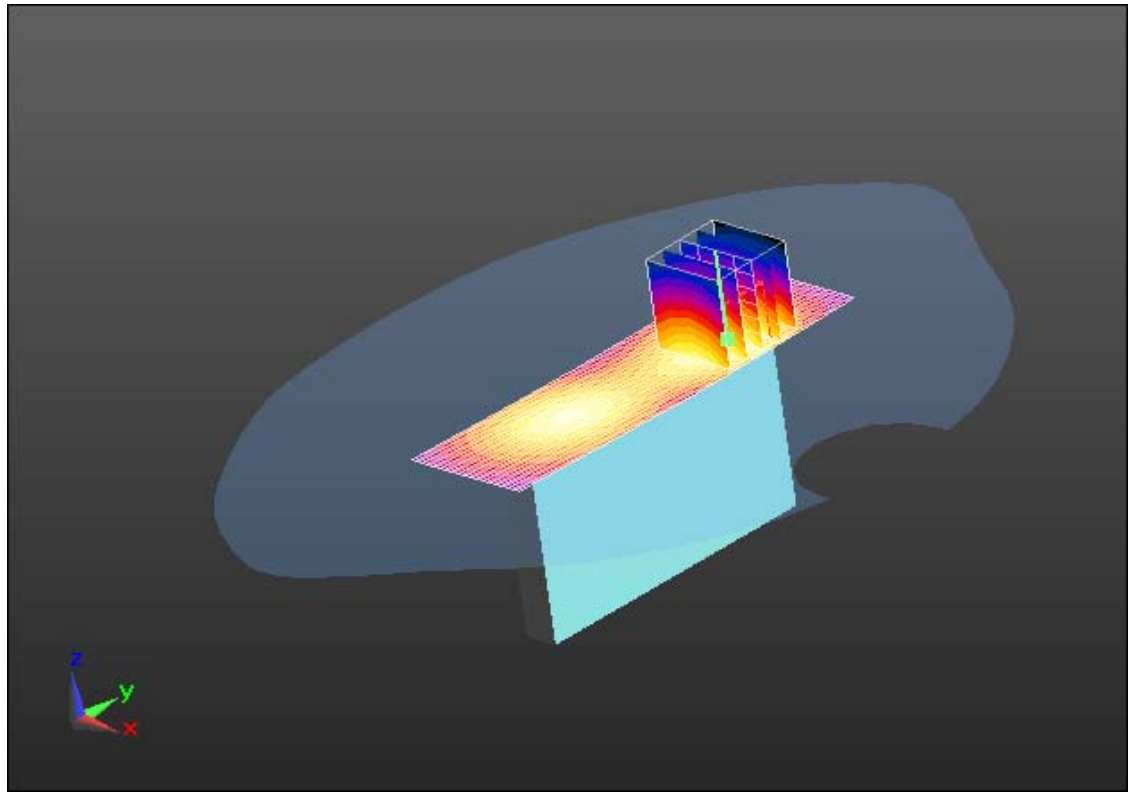
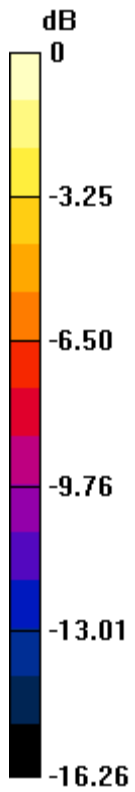

0 dB = 0.260mW/g = -11.70 dB mW/g

	Document <b>Appendix C2 for the BlackBerry® Smartphone Model REY21CW SAR Report</b>			Page <b>28(48)</b>
	Author Data <b>Andrew Becker</b>	Dates of Test <b>February 23 – March 6 , 2012</b>	Test Report No <b>RTS-5994-1203-47</b>	FCC ID: <b>L6AREY20CW</b>

Date/Time: 2/29/2012 6:42:36 PM

Test Laboratory: RIM Testing Services

## MHS\_Bottom\_CDMA1900\_low\_chan\_amb\_temp\_23.2C\_liq\_temp\_21.5C

**DUT: BlackBerry Smartphone; Type: Sample ; Serial: 297DF9E4**

Communication System: CDMA 1900; Frequency: 1851.25 MHz

Medium parameters used (interpolated):  $f = 1851.25$  MHz;  $\sigma = 1.535$  mho/m;  $\epsilon_r = 52.965$ ;  $\rho = 1000$  kg/m<sup>3</sup>

Phantom section: Flat Section

Measurement Standard: DASYS (IEEE/IEC/ANSI C63.19-2007)

DASY Configuration:

- Probe: ES3DV3 - SN3225; ConvF(4.92, 4.92, 4.92); Calibrated: 1/11/2012
- Sensor-Surface: 3mm (Mechanical Surface Detection),  $z = 2.0, 32.0$
- Electronics: DAE3 Sn473; Calibrated: 1/13/2012
- Phantom: SAM 2; Type: SAM 4.0; Serial: 1080
- DASYS2 52.8.0(692); SEMCAD X 14.6.4(4989)

**Configuration/Touch position -/Area Scan (31x81x1):** Measurement grid:  
 $dx=15$ mm,  $dy=15$ mm

[Info: Interpolated medium parameters used for SAR evaluation.](#)

Maximum value of SAR (interpolated) = 1.445 mW/g

**Configuration/Touch position -/Zoom Scan (5x5x7) (5x5x7)/Cube 0:**

Measurement grid:  $dx=7.5$ mm,  $dy=7.5$ mm,  $dz=5$ mm

Reference Value = 31.834 V/m; Power Drift = 0.02 dB

Peak SAR (extrapolated) = 1.8900

**SAR(1 g) = 1.2 mW/g; SAR(10 g) = 0.675 mW/g**

[Info: Interpolated medium parameters used for SAR evaluation.](#)

Maximum value of SAR (measured) = 1.459 mW/g

Author Data  
**Andrew Becker**

Dates of Test  
**February 23 – March 6 , 2012**

Test Report No  
**RTS-5994-1203-47**

FCC ID:  
**L6AREY20CW**

IC ID  
**2503A-REY20CW**

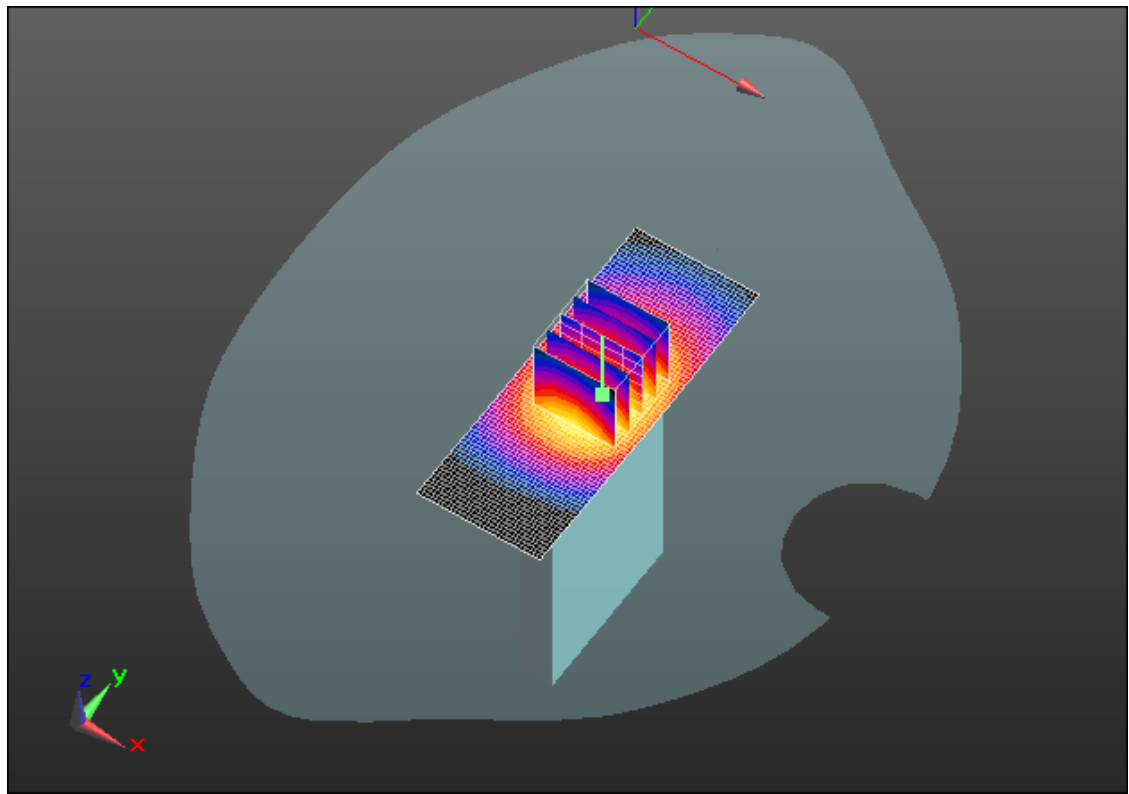
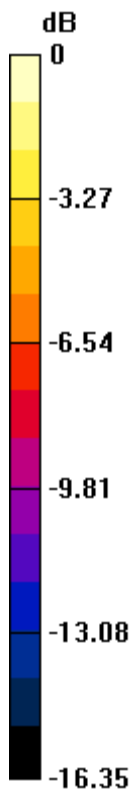

0 dB = 1.460mW/g = 3.29 dB mW/g

	Document <b>Appendix C2 for the BlackBerry® Smartphone Model REY21CW SAR Report</b>			Page <b>30(48)</b>
	Author Data <b>Andrew Becker</b>	Dates of Test <b>February 23 – March 6 , 2012</b>	Test Report No <b>RTS-5994-1203-47</b>	FCC ID: <b>L6AREY20CW</b>

Date/Time: 2/29/2012 6:26:59 PM

Test Laboratory: RIM Testing Services

## MHS\_Bottom\_CDMA1900\_mid\_chan\_amb\_temp\_23.2C\_liq\_temp\_21.5 C

**DUT: BlackBerry Smartphone; Type: Sample ; Serial: 297DF9E4**

Communication System: CDMA 1900; Frequency: 1880 MHz

Medium parameters used:  $f = 1880$  MHz;  $\sigma = 1.563$  mho/m;  $\epsilon_r = 52.857$ ;  $\rho = 1000$  kg/m<sup>3</sup>

Phantom section: Flat Section

Measurement Standard: DASYS (IEEE/IEC/ANSI C63.19-2007)

DASY Configuration:

- Probe: ES3DV3 - SN3225; ConvF(4.92, 4.92, 4.92); Calibrated: 1/11/2012
- Sensor-Surface: 3mm (Mechanical Surface Detection),  $z = 2.0, 32.0$
- Electronics: DAE3 Sn473; Calibrated: 1/13/2012
- Phantom: SAM 2; Type: SAM 4.0; Serial: 1080
- DASYS2 52.8.0(692); SEMCAD X 14.6.4(4989)

**Configuration/Touch position -/Area Scan (31x81x1):** Measurement grid:  
 $dx=15$ mm,  $dy=15$ mm

Maximum value of SAR (interpolated) = 1.527 mW/g

**Configuration/Touch position -/Zoom Scan (5x5x7) (5x5x7)/Cube 0:**

Measurement grid:  $dx=7.5$ mm,  $dy=7.5$ mm,  $dz=5$ mm

Reference Value = 32.500 V/m; Power Drift = 0.02 dB

Peak SAR (extrapolated) = 2.0740

**SAR(1 g) = 1.28 mW/g; SAR(10 g) = 0.717 mW/g**

Maximum value of SAR (measured) = 1.567 mW/g

Author Data  
**Andrew Becker**

Dates of Test  
**February 23 – March 6 , 2012**

Test Report No  
**RTS-5994-1203-47**

FCC ID:  
**L6AREY20CW**

IC ID  
**2503A-REY20CW**

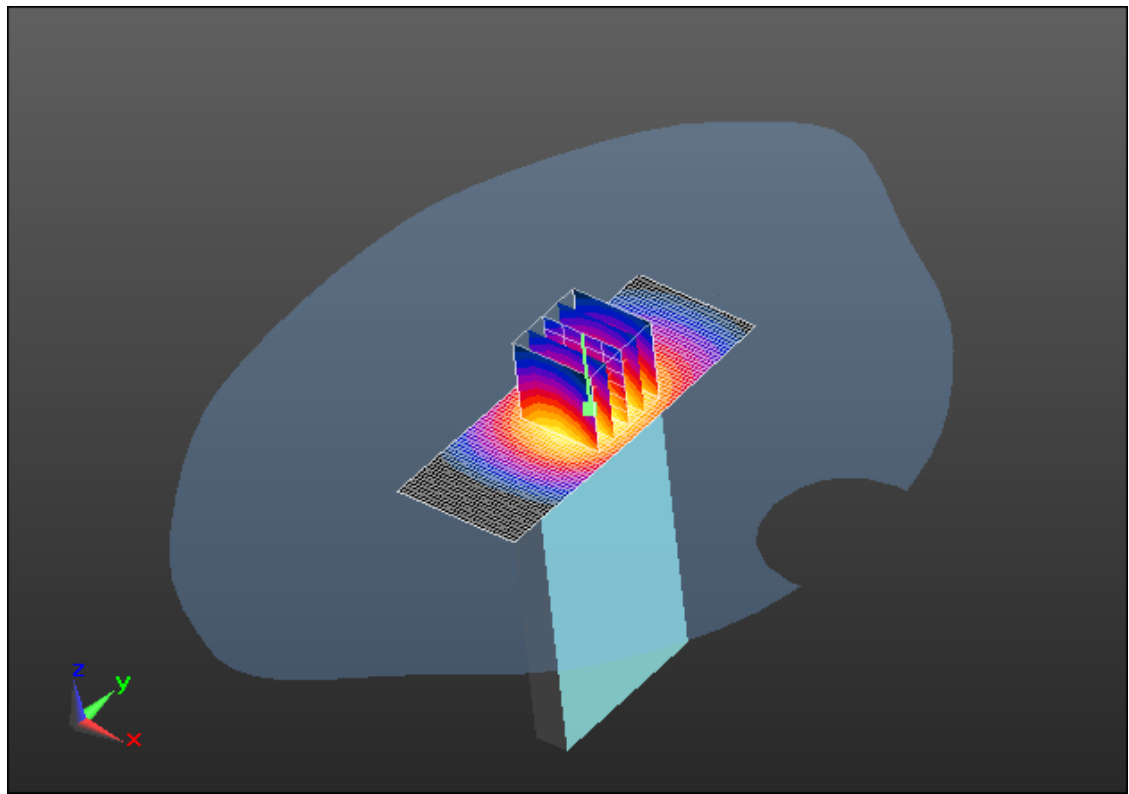
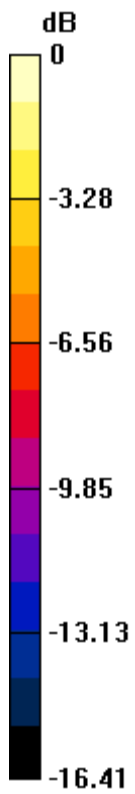

0 dB = 1.570mW/g = 3.92 dB mW/g

	Document <b>Appendix C2 for the BlackBerry® Smartphone Model REY21CW SAR Report</b>			Page <b>32(48)</b>
	Author Data <b>Andrew Becker</b>	Dates of Test <b>February 23 – March 6 , 2012</b>	Test Report No <b>RTS-5994-1203-47</b>	FCC ID: <b>L6AREY20CW</b>

Date/Time: 2/29/2012 7:16:20 PM

Test Laboratory: RIM Testing Services

## MHS\_Bottom\_CDMA1900\_high\_chan\_amb\_temp\_23.2C\_liq\_temp\_21.5 C

**DUT: BlackBerry Smartphone; Type: Sample ; Serial: 297DF9E4**

Communication System: CDMA 1900; Frequency: 1908.5 MHz

Medium parameters used (interpolated):  $f = 1908.5$  MHz;  $\sigma = 1.595$  mho/m;  $\epsilon_r = 52.761$ ;  
 $\rho = 1000$  kg/m<sup>3</sup>

Phantom section: Flat Section

Measurement Standard: DASYS (IEEE/IEC/ANSI C63.19-2007)

DASY Configuration:

- Probe: ES3DV3 - SN3225; ConvF(4.92, 4.92, 4.92); Calibrated: 1/11/2012
- Sensor-Surface: 3mm (Mechanical Surface Detection),  $z = 2.0, 32.0$
- Electronics: DAE3 Sn473; Calibrated: 1/13/2012
- Phantom: SAM 2; Type: SAM 4.0; Serial: 1080
- DASYS2 52.8.0(692); SEMCAD X 14.6.4(4989)

**Configuration/Touch position -/Area Scan (31x81x1):** Measurement grid:  
 $dx=15$ mm,  $dy=15$ mm

[Info: Interpolated medium parameters used for SAR evaluation.](#)

Maximum value of SAR (interpolated) = 1.624 mW/g

**Configuration/Touch position -/Zoom Scan (5x5x7) (5x5x7)/Cube 0:**

Measurement grid:  $dx=7.5$ mm,  $dy=7.5$ mm,  $dz=5$ mm

Reference Value = 31.693 V/m; Power Drift = -0.09 dB

Peak SAR (extrapolated) = 2.1700

**SAR(1 g) = 1.32 mW/g; SAR(10 g) = 0.730 mW/g**

[Info: Interpolated medium parameters used for SAR evaluation.](#)

Maximum value of SAR (measured) = 1.633 mW/g



Author Data  
**Andrew Becker**

Dates of Test  
**February 23 – March 6 , 2012**

Test Report No  
**RTS-5994-1203-47**

FCC ID:  
**L6AREY20CW**

IC ID  
**2503A-REY20CW**

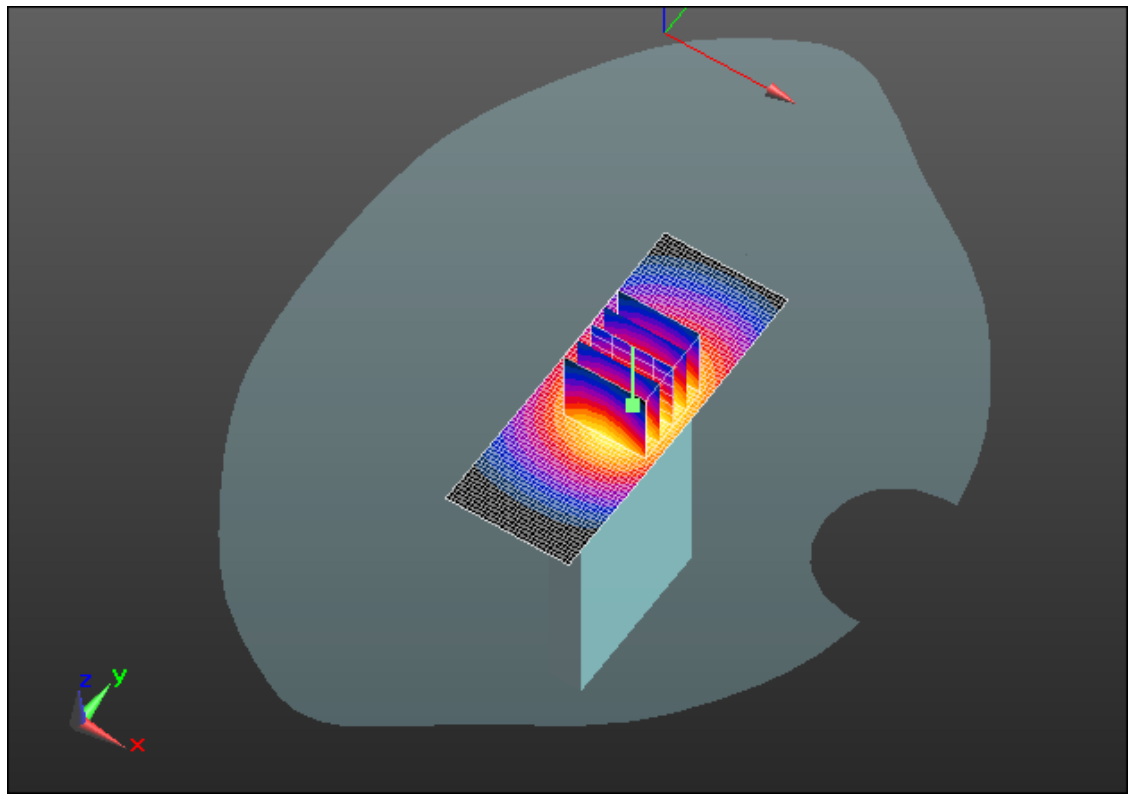
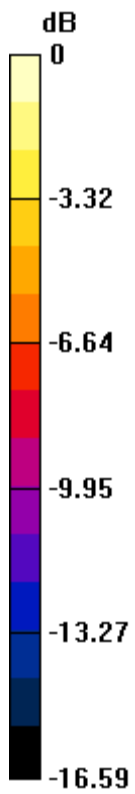

0 dB = 1.630mW/g = 4.24 dB mW/g

	Document <b>Appendix C2 for the BlackBerry® Smartphone Model REY21CW SAR Report</b>			Page <b>34(48)</b>
	Author Data <b>Andrew Becker</b>	Dates of Test <b>February 23 – March 6 , 2012</b>	Test Report No <b>RTS-5994-1203-47</b>	FCC ID: <b>L6AREY20CW</b>

Date/Time: 2/24/2012 12:38:29 PM

Test Laboratory: RIM Testing Services

## MHS\_Back\_802.11b\_low\_chan\_amb\_temp\_23.0C\_liq\_temp\_22.0C

**DUT: BlackBerry Smartphone; Type: Sample ; Serial: 297DF9E4**

Communication System: 802.11 b (2450); Frequency: 2412 MHz

Medium parameters used (interpolated):  $f = 2412$  MHz;  $\sigma = 1.868$  mho/m;  $\epsilon_r = 54.746$ ;  $\rho = 1000$  kg/m<sup>3</sup>

Phantom section: Flat Section

Measurement Standard: DASYS (IEEE/IEC/ANSI C63.19-2007)

DASY Configuration:

- Probe: ES3DV3 - SN3225; ConvF(4.3, 4.3, 4.3); Calibrated: 1/11/2012
- Sensor-Surface: 3mm (Mechanical Surface Detection),  $z = 2.0, 32.0$
- Electronics: DAE3 Sn473; Calibrated: 1/13/2012
- Phantom: SAM 2; Type: SAM 4.0; Serial: 1080
- DASYS2 52.8.0(692); SEMCAD X 14.6.4(4989)

**Configuration/Touch position -/Area Scan (61x91x1):** Measurement grid:  
 $dx=15$ mm,  $dy=15$ mm

[Info: Interpolated medium parameters used for SAR evaluation.](#)

Maximum value of SAR (interpolated) = 0.200 mW/g

**Configuration/Touch position -/Zoom Scan (5x5x7) (5x5x7)/Cube 0:**

Measurement grid:  $dx=7.5$ mm,  $dy=7.5$ mm,  $dz=5$ mm

Reference Value = 5.848 V/m; Power Drift = -0.26 dB

Peak SAR (extrapolated) = 0.3170

**SAR(1 g) = 0.152 mW/g; SAR(10 g) = 0.074 mW/g**

[Info: Interpolated medium parameters used for SAR evaluation.](#)

Maximum value of SAR (measured) = 0.191 mW/g

Author Data  
**Andrew Becker**

Dates of Test  
**February 23 – March 6 , 2012**

Test Report No  
**RTS-5994-1203-47**

FCC ID:  
**L6AREY20CW**

IC ID  
**2503A-REY20CW**

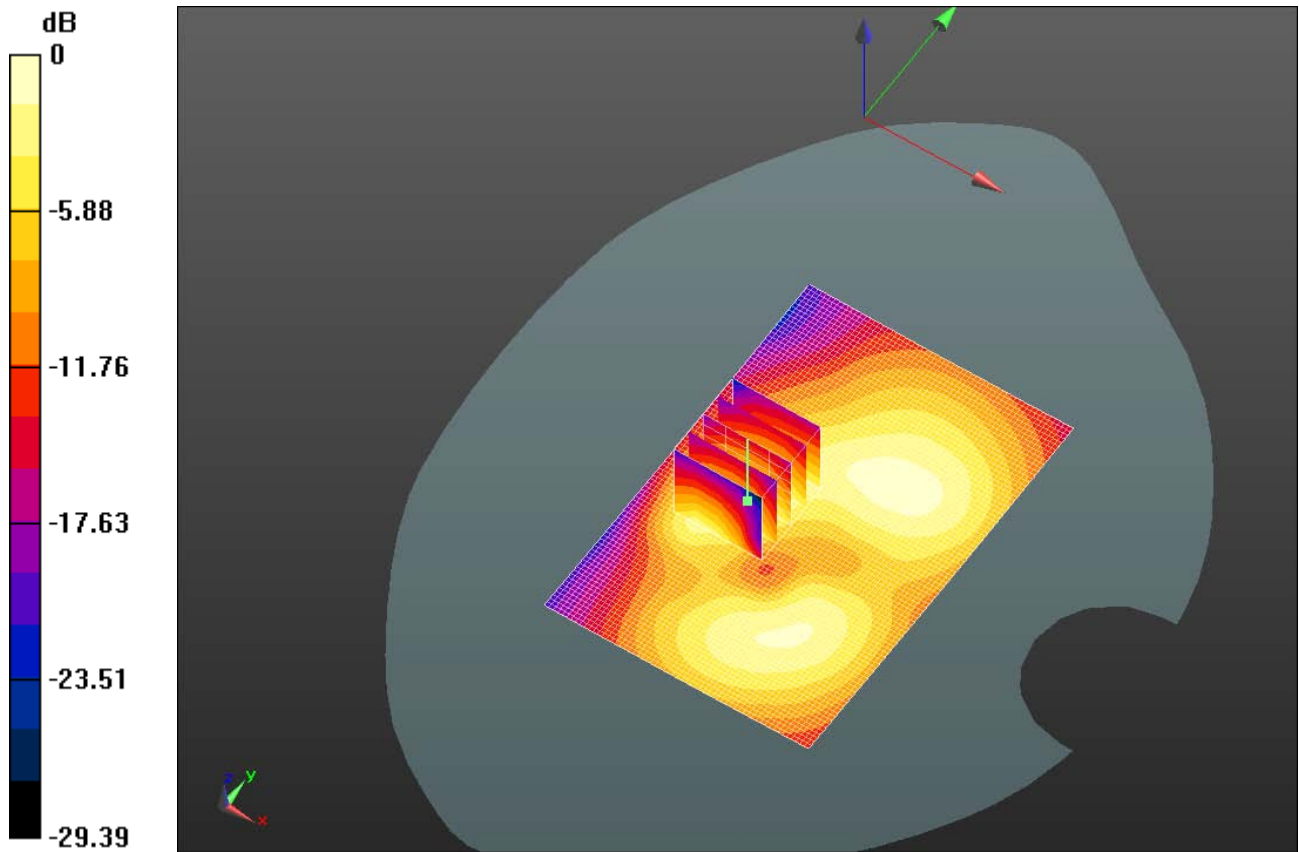

0 dB = 0.190mW/g = -14.42 dB mW/g

	Document <b>Appendix C2 for the BlackBerry® Smartphone Model REY21CW SAR Report</b>			Page <b>36(48)</b>
	Author Data <b>Andrew Becker</b>	Dates of Test <b>February 23 – March 6 , 2012</b>	Test Report No <b>RTS-5994-1203-47</b>	FCC ID: <b>L6AREY20CW</b>

Date/Time: 2/24/2012 1:30:15 PM

Test Laboratory: RIM Testing Services

## MHS\_Back\_802.11b\_mid\_chan\_amb\_temp\_23.0C\_liq\_temp\_22.0C

**DUT: BlackBerry Smartphone; Type: Sample ; Serial: 297DF9E4**

Communication System: 802.11 b (2450); Frequency: 2437 MHz

Medium parameters used (interpolated):  $f = 2437$  MHz;  $\sigma = 1.897$  mho/m;  $\epsilon_r = 54.648$ ;  $\rho = 1000$  kg/m<sup>3</sup>

Phantom section: Flat Section

Measurement Standard: DASYS (IEEE/IEC/ANSI C63.19-2007)

DASY Configuration:

- Probe: ES3DV3 - SN3225; ConvF(4.3, 4.3, 4.3); Calibrated: 1/11/2012
- Sensor-Surface: 3mm (Mechanical Surface Detection),  $z = 2.0, 32.0$
- Electronics: DAE3 Sn473; Calibrated: 1/13/2012
- Phantom: SAM 2; Type: SAM 4.0; Serial: 1080
- DASYS2 52.8.0(692); SEMCAD X 14.6.4(4989)

**Configuration/Touch position -/Area Scan (61x91x1):** Measurement grid:  
 $dx=15$ mm,  $dy=15$ mm

[Info: Interpolated medium parameters used for SAR evaluation.](#)

Maximum value of SAR (interpolated) = 0.339 mW/g

**Configuration/Touch position -/Zoom Scan (5x5x7) (5x5x7)/Cube 0:**

Measurement grid:  $dx=7.5$ mm,  $dy=7.5$ mm,  $dz=5$ mm

Reference Value = 6.261 V/m; Power Drift = -0.13 dB

Peak SAR (extrapolated) = 0.4790

**SAR(1 g) = 0.234 mW/g; SAR(10 g) = 0.118 mW/g**

[Info: Interpolated medium parameters used for SAR evaluation.](#)

Maximum value of SAR (measured) = 0.295 mW/g

Author Data  
**Andrew Becker**

Dates of Test  
**February 23 – March 6 , 2012**

Test Report No  
**RTS-5994-1203-47**

FCC ID:  
**L6AREY20CW**

IC ID  
**2503A-REY20CW**

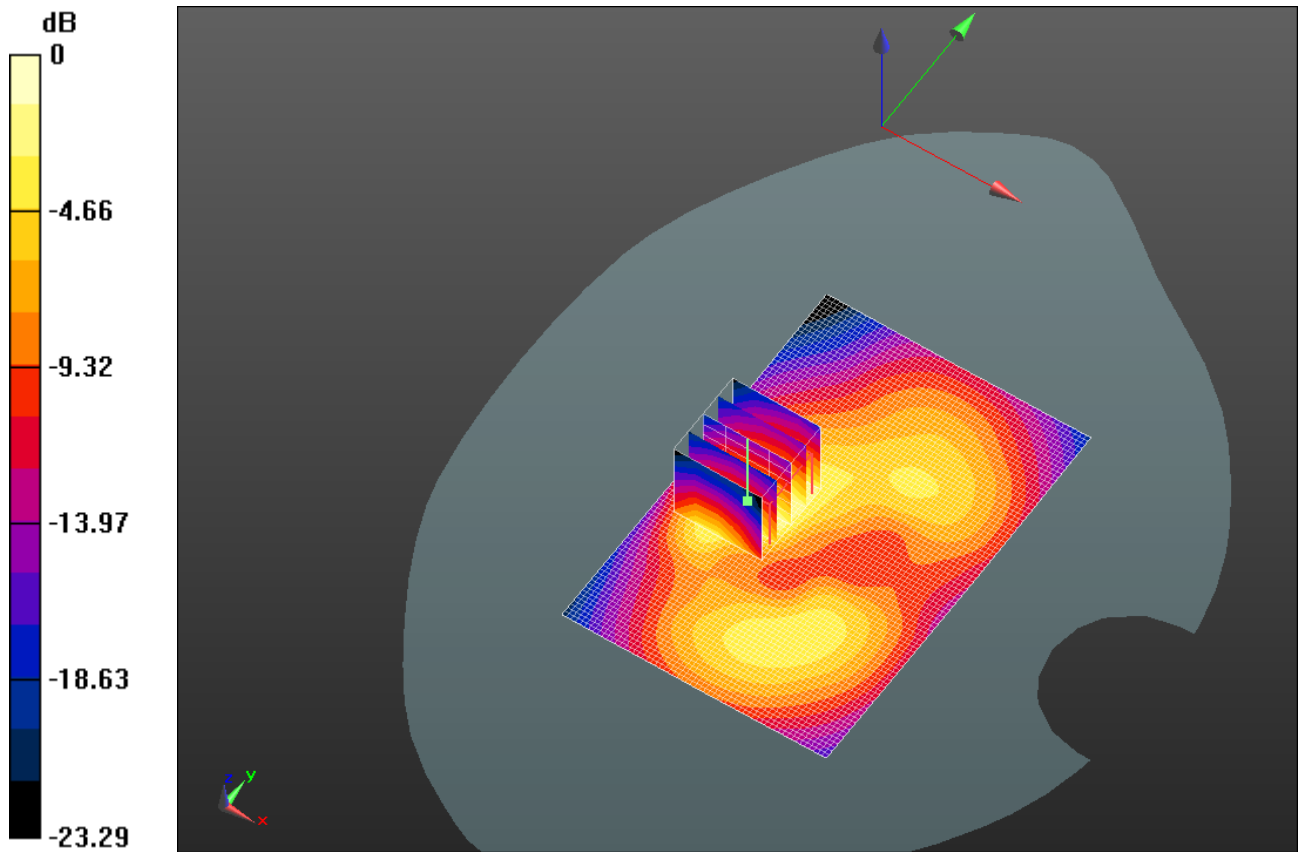

0 dB = 0.300mW/g = -10.46 dB mW/g

	Document <b>Appendix C2 for the BlackBerry® Smartphone Model REY21CW SAR Report</b>			Page <b>38(48)</b>
	Author Data <b>Andrew Becker</b>	Dates of Test <b>February 23 – March 6 , 2012</b>	Test Report No <b>RTS-5994-1203-47</b>	FCC ID: <b>L6AREY20CW</b>

Date/Time: 2/24/2012 1:50:31 PM

Test Laboratory: RIM Testing Services

## MHS\_Back\_802.11b\_high\_chan\_amb\_temp\_23.0C\_liq\_temp\_22.0C

**DUT: BlackBerry Smartphone; Type: Sample ; Serial: 297DF9E4**

Communication System: 802.11 b (2450); Frequency: 2462 MHz

Medium parameters used (interpolated):  $f = 2462$  MHz;  $\sigma = 1.928$  mho/m;  $\epsilon_r = 54.574$ ;  $\rho = 1000$  kg/m<sup>3</sup>

Phantom section: Flat Section

Measurement Standard: DASYS (IEEE/IEC/ANSI C63.19-2007)

DASY Configuration:

- Probe: ES3DV3 - SN3225; ConvF(4.3, 4.3, 4.3); Calibrated: 1/11/2012
- Sensor-Surface: 3mm (Mechanical Surface Detection),  $z = 2.0, 32.0$
- Electronics: DAE3 Sn473; Calibrated: 1/13/2012
- Phantom: SAM 2; Type: SAM 4.0; Serial: 1080
- DASYS2 52.8.0(692); SEMCAD X 14.6.4(4989)

**Configuration/Touch position -/Area Scan (61x91x1):** Measurement grid:  
 $dx=15$ mm,  $dy=15$ mm

[Info: Interpolated medium parameters used for SAR evaluation.](#)

Maximum value of SAR (interpolated) = 0.381 mW/g

**Configuration/Touch position -/Zoom Scan (5x5x7) (5x5x7)/Cube 0:**

Measurement grid:  $dx=7.5$ mm,  $dy=7.5$ mm,  $dz=5$ mm

Reference Value = 6.301 V/m; Power Drift = 0.16 dB

Peak SAR (extrapolated) = 0.5450

**SAR(1 g) = 0.262 mW/g; SAR(10 g) = 0.132 mW/g**

[Info: Interpolated medium parameters used for SAR evaluation.](#)

Maximum value of SAR (measured) = 0.332 mW/g

Author Data  
**Andrew Becker**

Dates of Test  
**February 23 – March 6 , 2012**

Test Report No  
**RTS-5994-1203-47**

FCC ID:  
**L6AREY20CW**

IC ID  
**2503A-REY20CW**

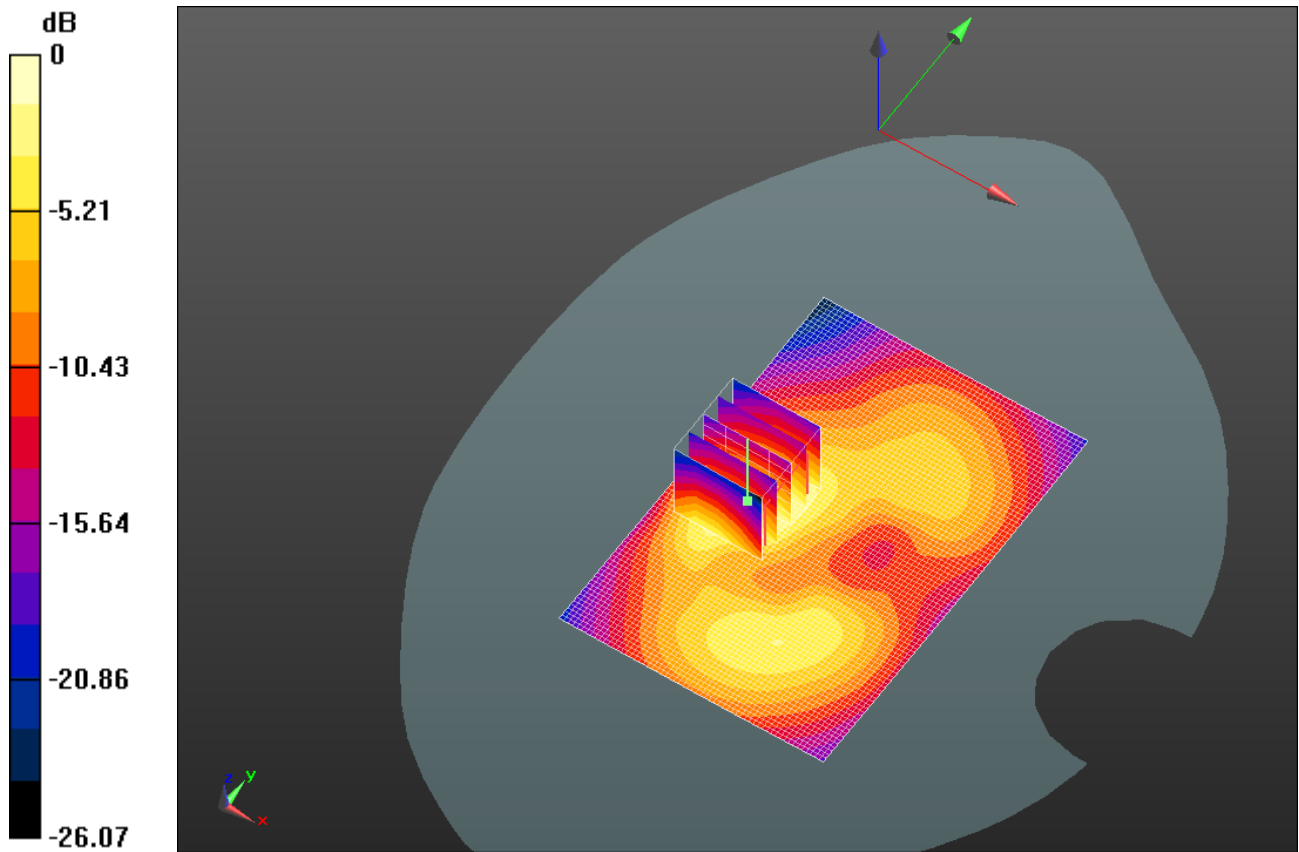

0 dB = 0.330mW/g = -9.63 dB mW/g

	Document <b>Appendix C2 for the BlackBerry® Smartphone Model REY21CW SAR Report</b>			Page <b>40(48)</b>
	Author Data <b>Andrew Becker</b>	Dates of Test <b>February 23 – March 6 , 2012</b>	Test Report No <b>RTS-5994-1203-47</b>	FCC ID: <b>L6AREY20CW</b>

Date/Time: 2/24/2012 2:24:33 PM

Test Laboratory: RIM Testing Services

## MHS\_Front\_802.11b\_high\_chan\_amb\_temp\_22.7C\_liq\_temp\_22.0C

**DUT: BlackBerry Smartphone; Type: Sample ; Serial: 297DF9E4**

Communication System: 802.11 b (2450); Frequency: 2462 MHz

Medium parameters used (interpolated):  $f = 2462$  MHz;  $\sigma = 1.928$  mho/m;  $\epsilon_r = 54.574$ ;  $\rho = 1000$  kg/m<sup>3</sup>

Phantom section: Flat Section

Measurement Standard: DASYS (IEEE/IEC/ANSI C63.19-2007)

DASY Configuration:

- Probe: ES3DV3 - SN3225; ConvF(4.3, 4.3, 4.3); Calibrated: 1/11/2012
- Sensor-Surface: 3mm (Mechanical Surface Detection),  $z = 2.0, 32.0$
- Electronics: DAE3 Sn473; Calibrated: 1/13/2012
- Phantom: SAM 2; Type: SAM 4.0; Serial: 1080
- DASYS2 52.8.0(692); SEMCAD X 14.6.4(4989)

**Configuration/Touch position -/Area Scan (61x91x1):** Measurement grid:  
 $dx=15$ mm,  $dy=15$ mm

[Info: Interpolated medium parameters used for SAR evaluation.](#)

Maximum value of SAR (interpolated) = 0.053 mW/g

**Configuration/Touch position -/Zoom Scan (5x5x7) (5x5x7)/Cube 0:**

Measurement grid:  $dx=7.5$ mm,  $dy=7.5$ mm,  $dz=5$ mm

Reference Value = 1.320 V/m; Power Drift = 0.63 dB

Peak SAR (extrapolated) = 0.0740

**SAR(1 g) = 0.039 mW/g; SAR(10 g) = 0.021 mW/g**

[Info: Interpolated medium parameters used for SAR evaluation.](#)

Maximum value of SAR (measured) = 0.047 mW/g



Author Data  
**Andrew Becker**

Dates of Test  
**February 23 – March 6 , 2012**

Test Report No  
**RTS-5994-1203-47**

FCC ID:  
**L6AREY20CW**

IC ID  
**2503A-REY20CW**

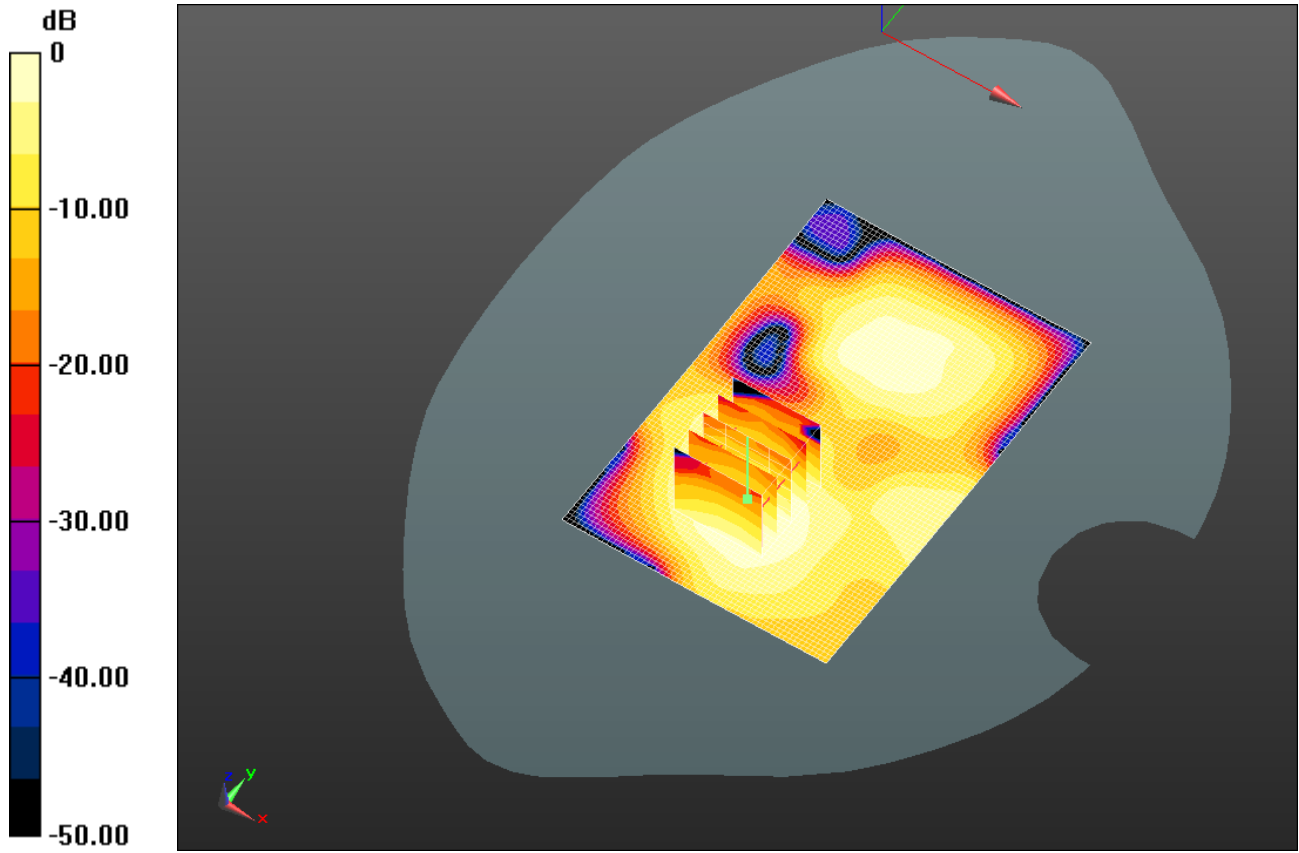

0 dB = 0.050mW/g = -26.02 dB mW/g

	Document <b>Appendix C2 for the BlackBerry® Smartphone Model REY21CW SAR Report</b>			Page <b>42(48)</b>
	Author Data <b>Andrew Becker</b>	Dates of Test <b>February 23 – March 6 , 2012</b>	Test Report No <b>RTS-5994-1203-47</b>	FCC ID: <b>L6AREY20CW</b>

Date/Time: 2/24/2012 5:20:27 PM

Test Laboratory: RIM Testing Services

## MHS\_Right\_802.11b\_high\_chan\_amb\_temp\_22.7C\_liq\_temp\_22.2C

**DUT: BlackBerry Smartphone; Type: Sample ; Serial: 297DF9E4**

Communication System: 802.11 b (2450); Frequency: 2462 MHz

Medium parameters used (interpolated):  $f = 2462$  MHz;  $\sigma = 1.928$  mho/m;  $\epsilon_r = 54.574$ ;  $\rho = 1000$  kg/m<sup>3</sup>

Phantom section: Flat Section

Measurement Standard: DASYS (IEEE/IEC/ANSI C63.19-2007)

DASY Configuration:

- Probe: ES3DV3 - SN3225; ConvF(4.3, 4.3, 4.3); Calibrated: 1/11/2012
- Sensor-Surface: 3mm (Mechanical Surface Detection),  $z = 2.0, 32.0$
- Electronics: DAE3 Sn473; Calibrated: 1/13/2012
- Phantom: SAM 2; Type: SAM 4.0; Serial: 1080
- DASYS2 52.8.0(692); SEMCAD X 14.6.4(4989)

**Configuration/Touch position -/Area Scan (31x101x1):** Measurement grid:  
 $dx=15$ mm,  $dy=15$ mm

[Info: Interpolated medium parameters used for SAR evaluation.](#)

Maximum value of SAR (interpolated) = 0.049 mW/g

**Configuration/Touch position -/Zoom Scan (5x5x7) (5x5x7)/Cube 0:**

Measurement grid:  $dx=7.5$ mm,  $dy=7.5$ mm,  $dz=5$ mm

Reference Value = 2.303 V/m; Power Drift = 0.33 dB

Peak SAR (extrapolated) = 0.0770

**SAR(1 g) = 0.039 mW/g; SAR(10 g) = 0.021 mW/g**

[Info: Interpolated medium parameters used for SAR evaluation.](#)

Maximum value of SAR (measured) = 0.049 mW/g

Author Data  
**Andrew Becker**

Dates of Test  
**February 23 – March 6 , 2012**

Test Report No  
**RTS-5994-1203-47**

FCC ID:  
**L6AREY20CW**

IC ID  
**2503A-REY20CW**

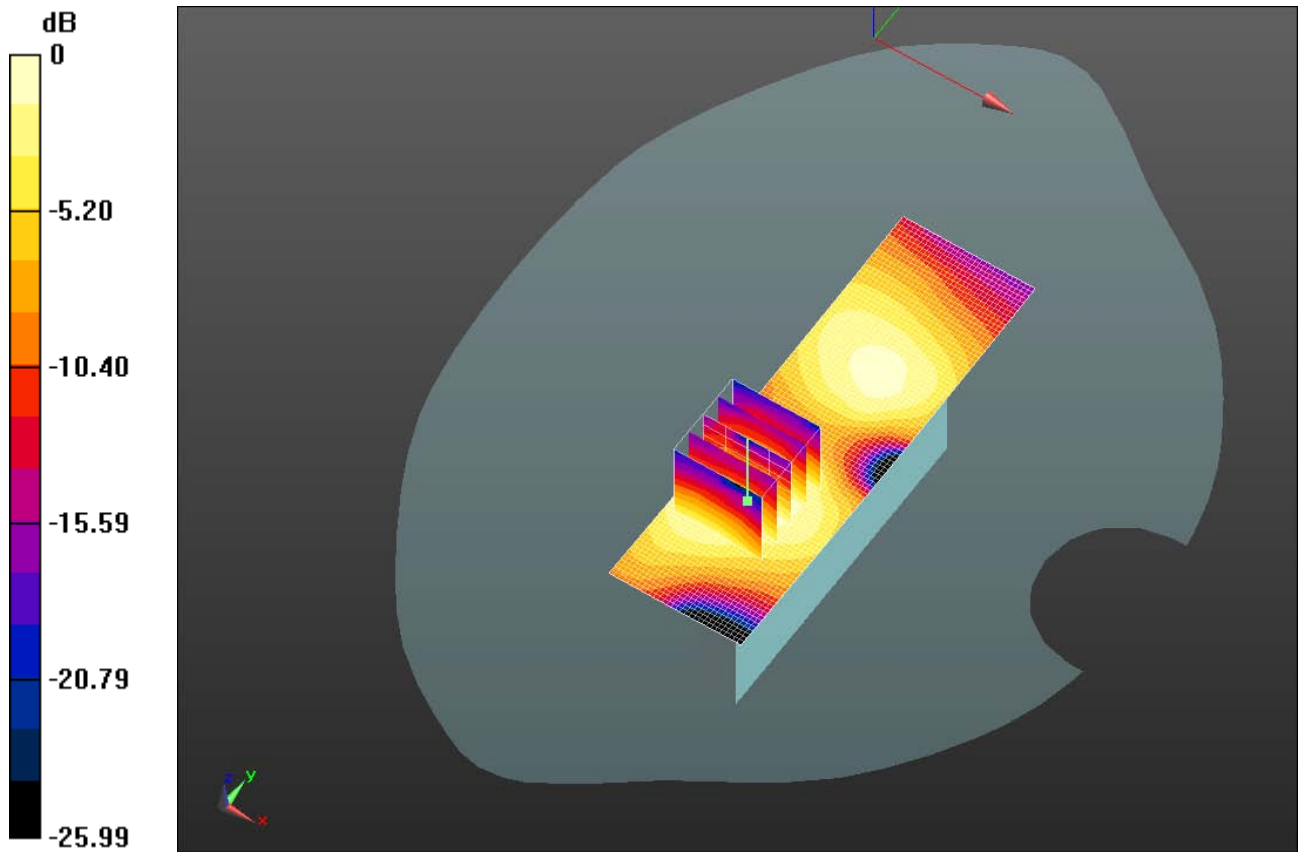

0 dB = 0.050mW/g = -26.02 dB mW/g

	Document <b>Appendix C2 for the BlackBerry® Smartphone Model REY21CW SAR Report</b>			Page <b>44(48)</b>
	Author Data <b>Andrew Becker</b>	Dates of Test <b>February 23 – March 6 , 2012</b>	Test Report No <b>RTS-5994-1203-47</b>	FCC ID: <b>L6AREY20CW</b>

Date/Time: 2/24/2012 3:24:23 PM

Test Laboratory: RIM Testing Services

## MHS\_Left\_802.11b\_high\_chan\_amb\_temp\_22.7C\_liq\_temp\_22.2C

**DUT: BlackBerry Smartphone; Type: Sample ; Serial: 297DF9E4**

Communication System: 802.11 b (2450); Frequency: 2462 MHz

Medium parameters used (interpolated):  $f = 2462$  MHz;  $\sigma = 1.928$  mho/m;  $\epsilon_r = 54.574$ ;  $\rho = 1000$  kg/m<sup>3</sup>

Phantom section: Flat Section

Measurement Standard: DASYS (IEEE/IEC/ANSI C63.19-2007)

DASY Configuration:

- Probe: ES3DV3 - SN3225; ConvF(4.3, 4.3, 4.3); Calibrated: 1/11/2012
- Sensor-Surface: 3mm (Mechanical Surface Detection),  $z = 2.0, 32.0$
- Electronics: DAE3 Sn473; Calibrated: 1/13/2012
- Phantom: SAM 2; Type: SAM 4.0; Serial: 1080
- DASYS2 52.8.0(692); SEMCAD X 14.6.4(4989)

**Configuration/Touch position -/Area Scan (31x101x1):** Measurement grid:  
 $dx=15$ mm,  $dy=15$ mm

[Info: Interpolated medium parameters used for SAR evaluation.](#)

Maximum value of SAR (interpolated) = 0.167 mW/g

**Configuration/Touch position -/Zoom Scan (5x5x7) (5x5x7)/Cube 0:**

Measurement grid:  $dx=7.5$ mm,  $dy=7.5$ mm,  $dz=5$ mm

Reference Value = 8.213 V/m; Power Drift = -0.33 dB

Peak SAR (extrapolated) = 0.2700

**SAR(1 g) = 0.128 mW/g; SAR(10 g) = 0.066 mW/g**

[Info: Interpolated medium parameters used for SAR evaluation.](#)

Maximum value of SAR (measured) = 0.164 mW/g

Author Data  
**Andrew Becker**

Dates of Test  
**February 23 – March 6 , 2012**

Test Report No  
**RTS-5994-1203-47**

FCC ID:  
**L6AREY20CW**

IC ID  
**2503A-REY20CW**

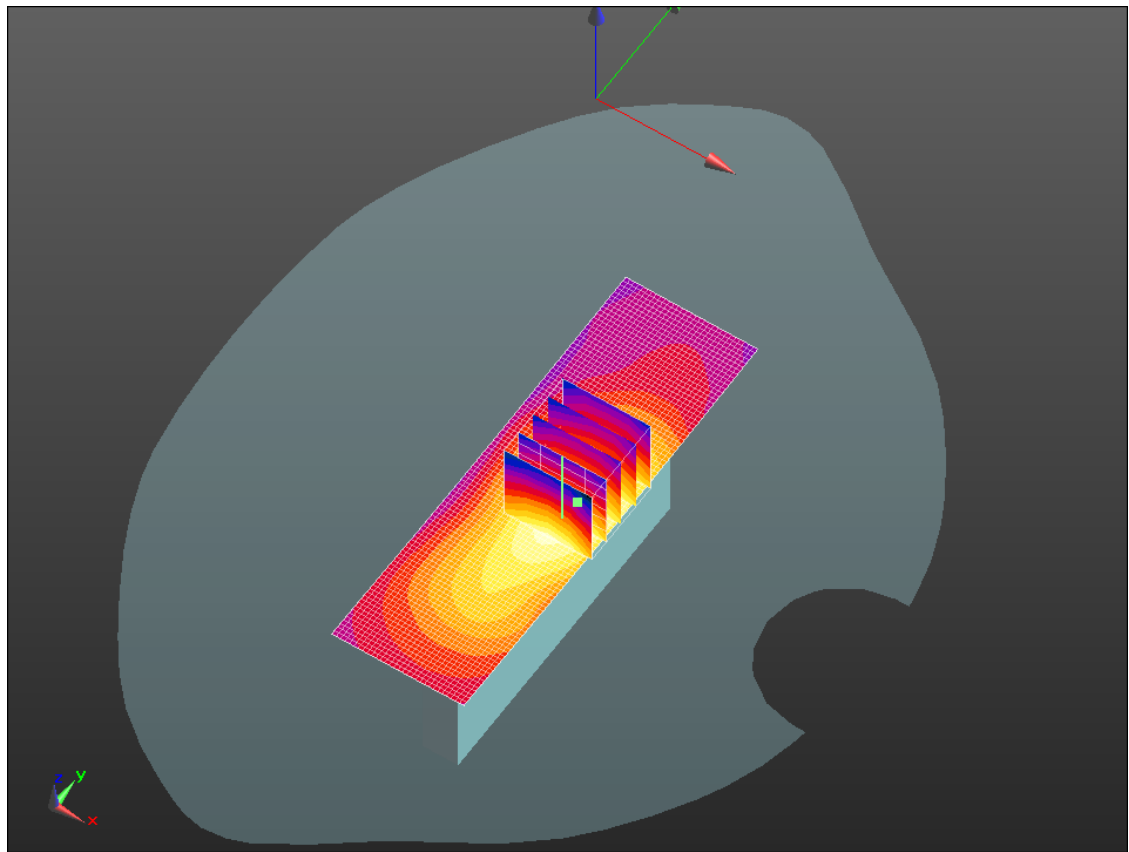
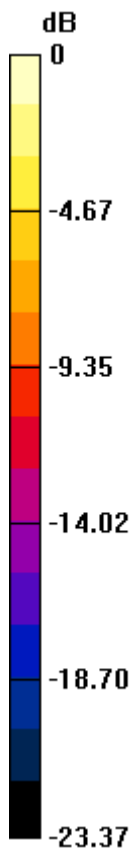

0 dB = 0.160mW/g = -15.92 dB mW/g

	Document <b>Appendix C2 for the BlackBerry® Smartphone Model REY21CW SAR Report</b>			Page <b>46(48)</b>
	Author Data <b>Andrew Becker</b>	Dates of Test <b>February 23 – March 6 , 2012</b>	Test Report No <b>RTS-5994-1203-47</b>	FCC ID: <b>L6AREY20CW</b>

Date/Time: 2/24/2012 5:37:20 PM

Test Laboratory: RIM Testing Services

## MHS\_Top\_802.11b\_high\_chan\_amb\_temp\_22.7\_liq\_temp\_22.2C

**DUT: BlackBerry Smartphone; Type: Sample ; Serial: 297DF9E4**

Communication System: 802.11 b (2450); Frequency: 2462 MHz

Medium parameters used (interpolated):  $f = 2462$  MHz;  $\sigma = 1.928$  mho/m;  $\epsilon_r = 54.574$ ;  $\rho = 1000$  kg/m<sup>3</sup>

Phantom section: Flat Section

Measurement Standard: DASYS (IEEE/IEC/ANSI C63.19-2007)

DASY Configuration:

- Probe: ES3DV3 - SN3225; ConvF(4.3, 4.3, 4.3); Calibrated: 1/11/2012
- Sensor-Surface: 3mm (Mechanical Surface Detection),  $z = 2.0, 32.0$
- Electronics: DAE3 Sn473; Calibrated: 1/13/2012
- Phantom: SAM 2; Type: SAM 4.0; Serial: 1080
- DASYS2 52.8.0(692); SEMCAD X 14.6.4(4989)

**Configuration/Touch position -/Area Scan (31x81x1):** Measurement grid:  
 $dx=15$ mm,  $dy=15$ mm

[Info: Interpolated medium parameters used for SAR evaluation.](#)

Maximum value of SAR (interpolated) = 0.110 mW/g

**Configuration/Touch position -/Zoom Scan (5x5x7) (5x5x7)/Cube 0:**

Measurement grid:  $dx=7.5$ mm,  $dy=7.5$ mm,  $dz=5$ mm

Reference Value = 7.608 V/m; Power Drift = -0.03 dB

Peak SAR (extrapolated) = 0.1730

**SAR(1 g) = 0.089 mW/g; SAR(10 g) = 0.047 mW/g**

[Info: Interpolated medium parameters used for SAR evaluation.](#)

Maximum value of SAR (measured) = 0.111 mW/g

Author Data  
**Andrew Becker**

Dates of Test  
**February 23 – March 6 , 2012**

Test Report No  
**RTS-5994-1203-47**

FCC ID:  
**L6AREY20CW**

IC ID  
**2503A-REY20CW**

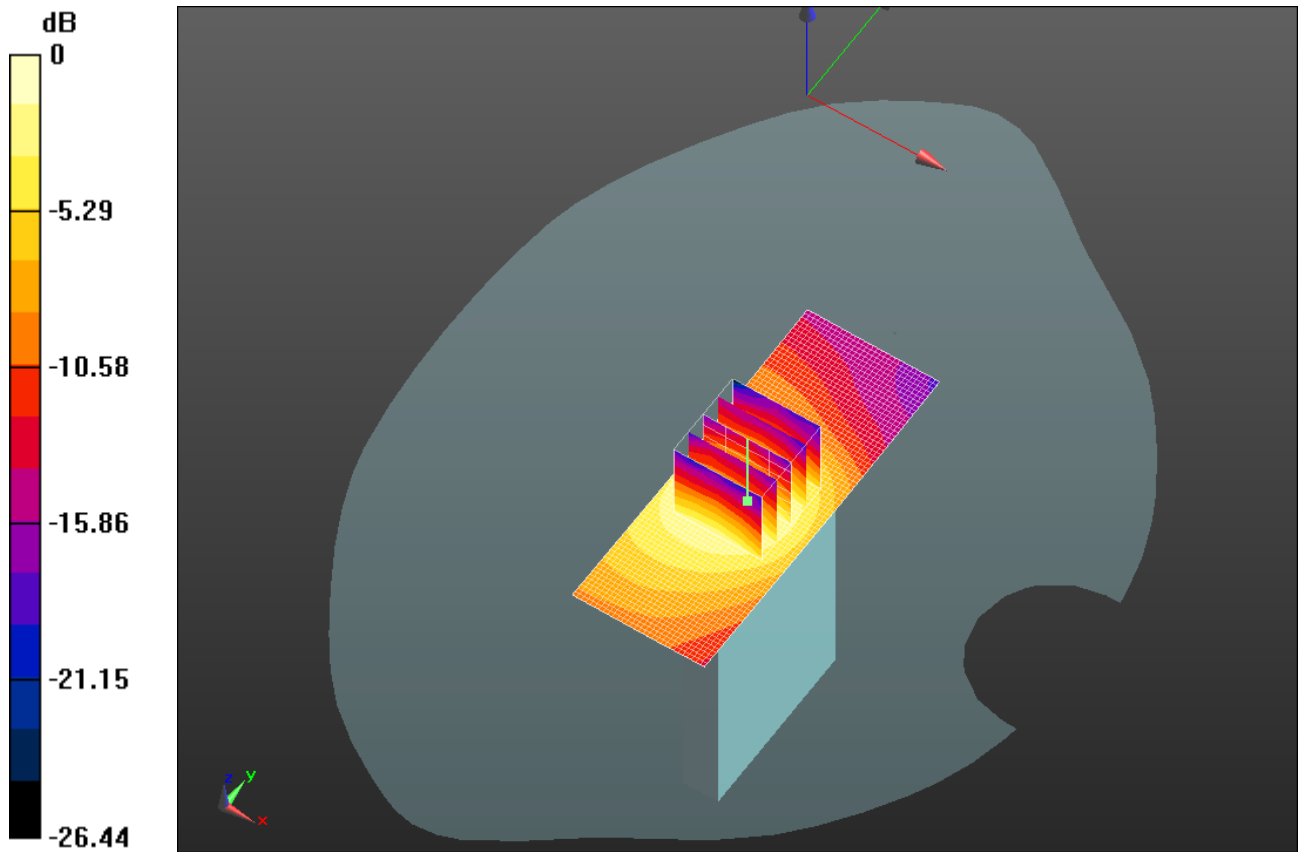

0 dB = 0.110mW/g = -19.17 dB mW/g



Document  
**Appendix C2 for the BlackBerry® Smartphone Model REY21CW SAR Report**

Page  
**48(48)**

Author Data  
**Andrew Becker**

Dates of Test  
**February 23 – March 6 , 2012**

Test Report No  
**RTS-5994-1203-47**

FCC ID:  
**L6AREY20CW**

IC ID  
**2503A-REY20CW**

### Z axis plot for the worst case body configuration

