



FCC RF Test Report

APPLICANT : Research In Motion Limited
EQUIPMENT : LTE band 4 & 17 / HSPA+ FDD 1, 2 & 5 Tablet PC
BRAND NAME : RIM
MODEL NAME : REG51LW
MARKETING NAME : P150-32***The stars "*" in model name can be 0 to 9, A to Z or blank, for marking purpose.

FCC ID : L6AREG50LW
STANDARD : FCC 47 CFR Part 2, 22(H), 24(E)
CLASSIFICATION : PCS Licensed Transmitter (PCB)
Tx/Rx FREQUENCY RANGE : WCDMA Band V : 826.4 ~ 846.6 MHz /
871.4 ~ 891.6 MHz
WCDMA Band II : 1852.4 ~ 1907.6 MHz /
1932.4 ~ 1987.6 MHz

MAX. ERP/EIRP POWER : WCDMA Band V (RMC 12.2Kbps) : 0.124 W
WCDMA Band II (RMC 12.2Kbps) : 0.163 W

The product was received on Dec. 07, 2011 and completely tested on Mar. 10, 2011. We, SPORTON INTERNATIONAL INC., would like to declare that the tested sample has been evaluated in accordance with the procedures given in ANSI / TIA / EIA-603-C-2004 and shown compliance with the applicable technical standards.

The test results in this report apply exclusively to the tested model / sample. Without written approval of SPORTON INTERNATIONAL INC., the test report shall not be reproduced except in full.

Reviewed by:

Jones Tsai / Manager



SPORTON INTERNATIONAL INC.

No. 52, Hwa Ya 1st Rd., Hwa Ya Technology Park, Kwei-Shan Hsiang, Tao Yuan Hsien, Taiwan, R.O.C.



TABLE OF CONTENTS

REVISION HISTORY..... 3

SUMMARY OF TEST RESULT 4

1 GENERAL DESCRIPTION 5

 1.1 Applicant..... 5

 1.2 Manufacturer 5

 1.3 Feature of Equipment Under Test..... 5

 1.4 Emission Designator and Maximum ERP/EIRP Power 6

 1.5 Testing Site..... 6

 1.6 Applied Standards 6

 1.7 Ancillary Equipment List 6

2 TEST CONFIGURATION OF EQUIPMENT UNDER TEST 7

 2.1 Test Mode..... 7

 2.2 Connection Diagram of Test System 8

3 TEST RESULT 9

 3.1 Conducted Output Average Power Measurement 9

 3.2 Effective Radiated Power and Effective Isotropic Radiated Power Measurement 12

 3.3 Occupied Bandwidth Measurement 15

 3.4 Band Edge Measurement..... 18

 3.5 Field Strength of Spurious Radiation Measurement 28

 3.6 Frequency Stability Measurement..... 34

4 LIST OF MEASURING EQUIPMENT 37

5 UNCERTAINTY OF EVALUATION 38

APPENDIX A. PHOTOGRAPHS OF EUT

APPENDIX B. SETUP PHOTOGRAPHS



SUMMARY OF TEST RESULT

Report Section	FCC Rule	IC Rule	Description	Limit	Result	Remark
3.1	§2.1046	N/A	Conducted Output Average Power	N/A	PASS	-
3.2	§22.913(a)(2)	RSS-132(4.4) SRSP-503(5.1.3)	Effective Radiated Power	< 7 Watts	PASS	-
3.2	§24.232(c)	RSS-133 (6.4) SRSP-510(5.1.2)	Equivalent Isotropic Radiated Power	< 2 Watts	PASS	-
3.3	§2.1049 §22.917(a) §24.238(a)	N/A	Occupied Bandwidth	N/A	PASS	-
3.4	§2.1051 §22.917(a) §24.238(a)	RSS-132 (4.5.1) RSS-133 (6.5.1)	Band Edge Measurement	< 43+10log ₁₀ (P[Watts])	PASS	-
3.4.6	§2.1051 §22.917(a) §24.238(a)	RSS-132 (4.5.1) RSS-133 (6.5.1)	Conducted Emission	< 43+10log ₁₀ (P[Watts])	PASS	-
3.5	§2.1053 §22.917(a) §24.238(a)	RSS-132 (4.5.1) RSS-133 (6.5.1)	Field Strength of Spurious Radiation	< 43+10log ₁₀ (P[Watts])	PASS	Under limit 26.78 dB at 7520.000 MHz
3.6	§2.1055 §22.355 §24.235	RSS-132(4.3) RSS-133(6.3)	Frequency Stability for Temperature & Voltage	< 2.5 ppm	PASS	-

1 General Description

1.1 Applicant

Research In Motion Limited
 295 Phillip Street, Waterloo, Ontario, Canada

1.2 Manufacturer

Quanta Computer Inc.
 No. 188, Wen Hwa 2nd Road, Kuei Shan Hsiang, Tao Yuan Shien, 333 Taiwan

1.3 Feature of Equipment Under Test

Product Feature & Specification	
Equipment	LTE band 4 & 17 / HSPA+ FDD 1, 2 & 5 Tablet PC
Brand Name	RIM
Model Name	REG51LW
Marketing Name	P150-32***The stars "*" in model name can be 0 to 9, A to Z or blank, for marking purpose.
FCC ID	L6AREG50LW
Tx Frequency	WCDMA Band V : 824 MHz ~ 849 MHz WCDMA Band II : 1850 MHz ~ 1910 MHz
Rx Frequency	WCDMA Band V : 869 MHz ~ 894 MHz WCDMA Band II : 1930 MHz ~ 1990 MHz
Maximum Output Average Power to Antenna	WCDMA Band V : 24.08 dBm WCDMA Band II : 22.87 dBm
Antenna Type	Fixed Internal Antenna
HW Version	DARU3MB1AD0 REVD
SW Version	1.0.0.0
Type of Modulation	WCDMA: QPSK (Uplink) HSDPA: QPSK (Uplink) HSUPA: QPSK (Uplink)
EUT Stage	Identical Prototype

Remark: The above EUT's information was declared by manufacturer. Please refer to the specifications or user's manual for more detailed description.

1.4 Emission Designator and Maximum ERP/EIRP Power

FCC Rule	System	Type of Modulation	Emission Designator	Maximum ERP/EIRP
Part 22	WCDMA Band V RMC 12.2Kbps	QPSK (Uplink)	4M16F9W	0.124 W
Part 24	WCDMA Band II RMC 12.2Kbps	QPSK (Uplink)	4M16F9W	0.163 W

1.5 Testing Site

Test Site	SPORTON INTERNATIONAL INC.		
Test Site Location	No. 52, Hwa Ya 1 st Rd., Hwa Ya Technology Park, Kwei-Shan Hsiang, Tao Yuan Hsien, Taiwan, R.O.C. TEL: +886-3-327-3456 FAX: +886-3-328-4978		
Test Site No.	Sporton Site No.		FCC/IC Registration No.
	TH02-HY	03CH05-HY / 03CH07-HY	722060/4086B-1

1.6 Applied Standards

According to the specifications of the manufacturer, the EUT must comply with the requirements of the following standards:

- ♦ Preliminary Guidance for Receiving Applications for Certification of 3G Device. May 9, 2006.
- ♦ FCC 47 CFR Part 2, 22(H), 24(E)
- ♦ ANSI / TIA / EIA-603-C-2004
- ♦ FCC KDB 971168 D01 Power Meas. License Digital Systems v01
- ♦ IC RSS-132 Issue 2
- ♦ IC RSS-133 Issue 5

Remark:

1. All test items were verified and recorded according to the standards and without any deviation during the test.
2. This EUT has also been tested and complied with the requirements of FCC Part 15, Subpart B, recorded in a separate test report.

1.7 Ancillary Equipment List

Item	Equipment	Trade Name	Model No.	FCC ID	Data Cable	Power Cord
1.	System Simulator	R&S	CMU200	N/A	N/A	Unshielded, 1.8 m
2.	iPod Earphone	Apple	N/A	FCC DoC	Unshielded, 1.2 m	N/A

2 Test Configuration of Equipment Under Test

2.1 Test Mode

During all testing, EUT is in link mode with base station emulator at maximum power level. The spurious emission measurements were carried out in semi-anechoic chamber with 3-meter test range, and EUT is rotated on three test planes to find out the worst emission.

Frequency range investigated for radiated emission is as follows:

1. 30 MHz to 9000 MHz for WCDMA Band V.
2. 30 MHz to 19000 MHz for WCDMA Band II.

Test Modes		
Band	Radiated TCs	Conducted TCs
WCDMA Band V	■ RMC 12.2Kbps Link	■ RMC 12.2Kbps Link
WCDMA Band II	■ RMC 12.2Kbps Link	■ RMC 12.2Kbps Link

Note:

1. The maximum power levels are, RMC 12.2Kbps mode for WCDMA band V, and RMC 12.2Kbps mode for WCDMA band II, only these modes were used for all tests.
2. Because there are individual antennas for each WWAN, WLAN, and Bluetooth, the co-location test modes are not required.

The conducted output average power tables are as follows:

Conducted Output Average Power (*Unit: dBm)						
Band	WCDMA Band V			WCDMA Band II		
Channel	4132	4182	4233	9262	9400	9538
Frequency	826.4	836.4	846.6	1852.4	1880.0	1907.6
RMC 12.2K	24.08	23.89	23.93	22.86	22.49	22.87
HSDPA Subtest-1	23.37	23.20	23.35	22.13	21.60	22.02
HSDPA Subtest-2	23.53	23.34	23.47	22.01	21.89	22.10
HSDPA Subtest-3	22.76	22.62	22.86	21.58	20.99	21.30
HSDPA Subtest-4	22.92	22.81	22.93	21.35	20.95	21.56
HSUPA Subtest-1	23.37	23.13	22.70	21.54	21.51	21.75
HSUPA Subtest-2	21.74	21.72	21.99	18.95	19.55	18.99
HSUPA Subtest-3	21.86	21.84	22.10	20.18	20.11	20.10
HSUPA Subtest-4	21.70	21.56	21.57	19.24	19.45	19.58
HSUPA Subtest-5	23.40	23.39	23.28	21.57	21.43	21.84

2.2 Connection Diagram of Test System

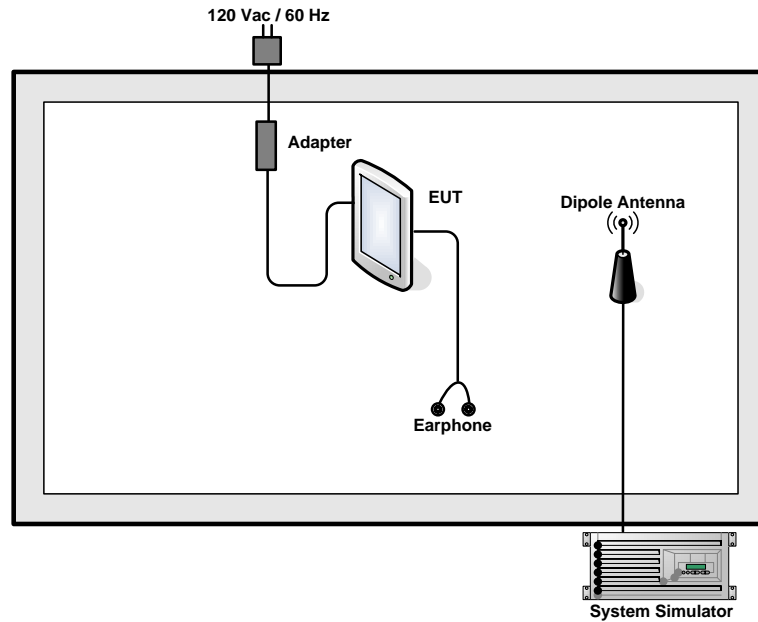

3 Test Result

3.1 Conducted Output Average Power Measurement

3.1.1 Description of the Conducted Output Average Power Measurement

A base station simulator was used to establish communication with the EUT. Its parameters were set to transmit the maximum power on the EUT. The measured power in the radio frequency on the transmitter output terminals shall be reported.

3.1.2 Measuring Instruments

See list of measuring instruments of this test report.

3.1.3 Test Procedures

1. The transmitter output port was connected to base station.
2. Set EUT at maximum power through base station.
3. Select lowest, middle, and highest channels for each band and different modulation.

3.1.4 Test Setup

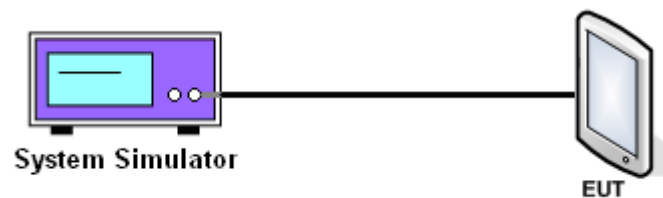



3.1.5 Test Result of Conducted Output Average Power

Cellular Band			
Modes	WCDMA Band V (RMC 12.2Kbps)		
Channel	4132 (Low)	4132 (Low)	4132 (Low)
Frequency (MHz)	826.4	826.4	826.4
Conducted Output Average Power (dBm)	24.08	23.89	23.93
Conducted Output Average Power (Watts)	0.26	0.24	0.25

PCS Band			
Modes	WCDMA Band II (RMC 12.2Kbps)		
Channel	9262 (Low)	9400 (Mid)	9538 (High)
Frequency (MHz)	1852.4	1880	1907.6
Conducted Output Average Power (dBm)	22.86	22.49	22.87
Conducted Output Average Power (Watts)	0.19	0.18	0.19



3.1.6 Peak to Average Power Ratio

WCDMA Band V (RMC 12.2Mbps) C.C.D.F.

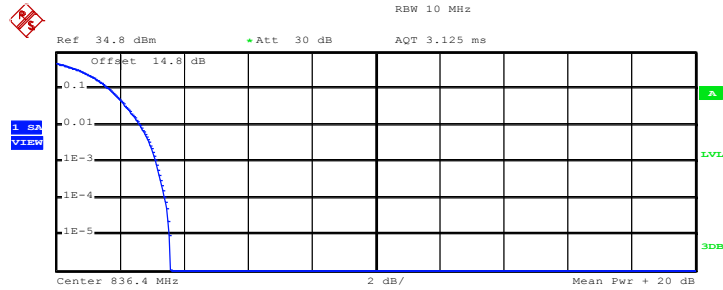

Complementary Cumulative Distribution Function (100000 samples)

Trace 1

Mean 18.27 dBm
 Peak 21.86 dBm
 Crest 3.59 dB

10 % 1.68 dB
 1 % 2.64 dB
 .1 % 3.16 dB
 .01 % 3.40 dB

Date: 15.DEC.2011 18:25:22

WCDMA Band II (RMC 12.2Mbps) C.C.D.F.

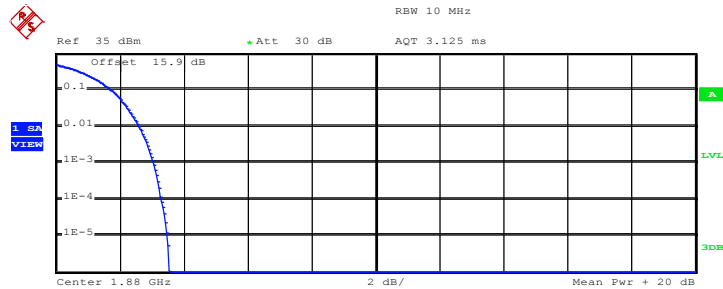

Complementary Cumulative Distribution Function (100000 samples)

Trace 1

Mean 20.98 dBm
 Peak 24.53 dBm
 Crest 3.55 dB

10 % 1.76 dB
 1 % 2.60 dB
 .1 % 3.08 dB
 .01 % 3.32 dB

Date: 15.DEC.2011 17:08:08



3.2 Effective Radiated Power and Effective Isotropic Radiated Power Measurement

3.2.1 Description of the ERP/EIRP Measurement

The substitution method, in ANSI / TIA / EIA-603-C-2004, was used for ERP/EIRP measurement, and the spectrum analyzer configuration follows KDB 971168 D01 Power Meas. License Digital Systems v01. The ERP of mobile transmitters must not exceed 7 Watts and the EIRP of mobile transmitters are limited to 2 Watts.

3.2.2 Measuring Instruments

See list of measuring instruments of this test report.

3.2.3 Test Procedures

1. The EUT was placed on a non-conductive rotating platform with 0.8 meter height in a semi-anechoic chamber. The radiated emission at the fundamental frequency was measured at 3 m with a test antenna and a spectrum analyzer with RBW= 300 KHz, VBW= 1 MHz, and RMS detector settings per section 4.0 of KDB 971168 D01.
2. During the measurement, the EUT was enforced in maximum power and linked with a base station. The highest emission was recorded from analyzer power level (LVL) from the 360 degrees rotation of the turntable and the test antenna raised and lowered over a range from 1 to 4 meters in both horizontally and vertically polarized orientations.
3. Effective Isotropic Radiated Power (EIRP) was measured by substitution method according to TIA/EIA-603-C. The EUT was replaced by dipole antenna (substitution antenna) at same location, and then a known power from S.G. was applied into the dipole antenna through a Tx cable, and then recorded the maximum Analyzer reading through raised and lowered the test antenna. The correction factor (in dB) = S.G. - Tx Cable loss + Substitution antenna gain - Analyzer reading. Then the EUT's EIRP was calculated with the correction factor, $EIRP = LVL + \text{Correction factor}$ and $ERP = EIRP - 2.15$.

3.2.4 Test Setup

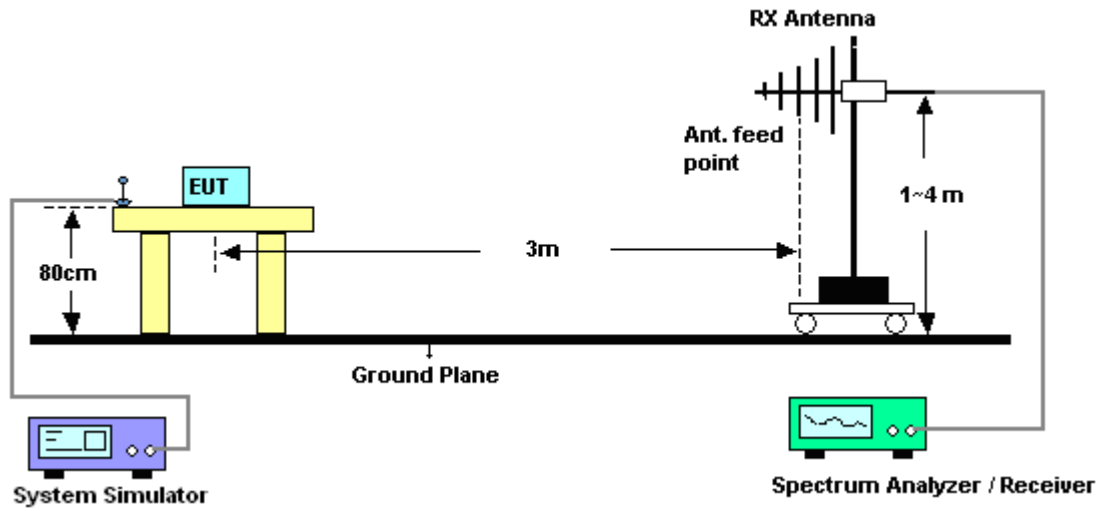



3.2.5 Test Result of ERP

WCDMA Band V (RMC 12.2Kbps) Radiated Power ERP				
Horizontal Polarization				
Frequency (MHz)	LVL (dBm)	Correction Factor (dB)	ERP (dBm)	ERP (W)
826.4	-7.78	30.74	20.81	0.121
836.4	-7.85	30.89	20.89	0.123
846.6	-8.21	31.29	20.93	0.124
Vertical Polarization				
Frequency (MHz)	LVL (dBm)	Correction Factor (dB)	ERP (dBm)	ERP (W)
826.4	-14.05	34.94	18.74	0.075
836.4	-13.78	34.88	18.95	0.079
846.6	-14.19	34.67	18.33	0.068

* ERP = LVL (dBm) + Correction Factor (dB) – 2.15

3.2.6 Test Result of EIRP

WCDMA Band II (RMC 12.2Kbps) Radiated Power EIRP				
Horizontal Polarization				
Frequency (MHz)	LVL (dBm)	Correction Factor (dB)	EIRP (dBm)	EIRP (W)
1852.4	-19.09	40.40	21.31	0.135
1880.0	-19.78	41.91	22.13	0.163
1907.6	-19.98	41.59	21.61	0.145
Vertical Polarization				
Frequency (MHz)	LVL (dBm)	Correction Factor (dB)	EIRP (dBm)	EIRP (W)
1852.4	-23.96	42.69	18.73	0.075
1880.0	-24.65	43.75	19.10	0.081
1907.6	-24.74	43.02	18.28	0.067

* EIRP = LVL (dBm) + Correction Factor (dB)

3.3 Occupied Bandwidth Measurement

3.3.1 Description of Occupied Bandwidth Measurement

The emission bandwidth is defined as the width of the signal between two points, located at the 2 sides of the carrier frequency, outside of which all emissions are attenuated at least 26 dB below the transmitter power.

3.3.2 Measuring Instruments

See list of measuring instruments of this test report.

3.3.3 Test Procedures

1. The EUT was connected to Spectrum Analyzer and Base Station via power divider.
2. The 99% and 26 dB occupied bandwidth (BW) of the middle channel for the highest RF powers were measured.

3.3.4 Test Setup

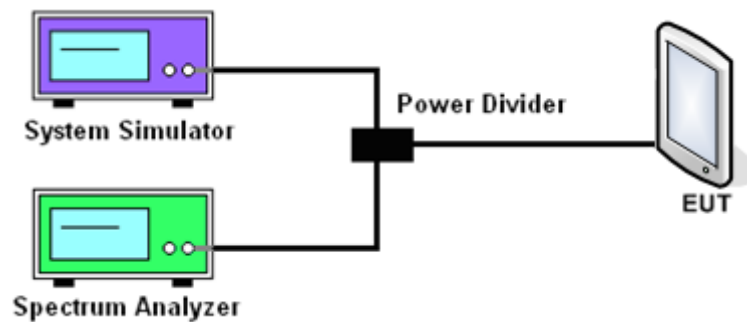



3.3.5 Test Result (Plots) of Occupied Bandwidth

Band :	WCDMA Band V	Power Stage :	High
Test Mode :	RMC 12.2Kbps Link		

99% Occupied Bandwidth Plot on Channel 4182

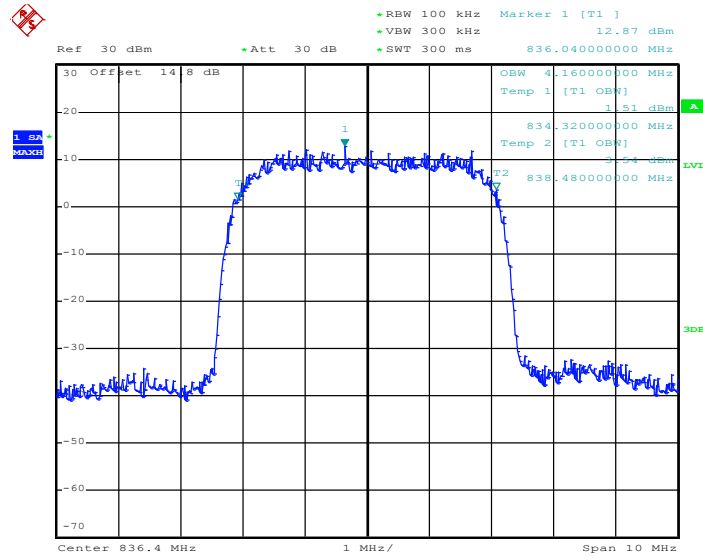

Date: 15.DEC.2011 18:20:56

26dB Bandwidth Plot on Channel 4182

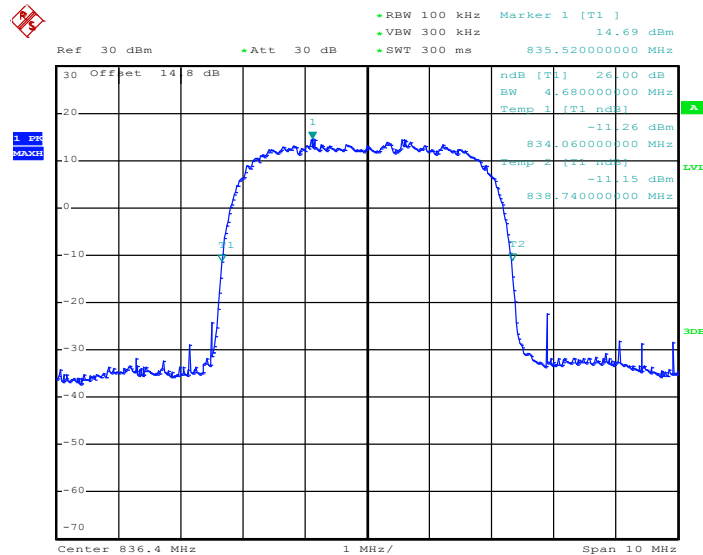

Date: 15.DEC.2011 18:19:36



Band :	WCDMA Band II	Power Stage :	High
Test Mode :	RMC 12.2Kbps Link		

99% Occupied Bandwidth Plot on Channel 9400

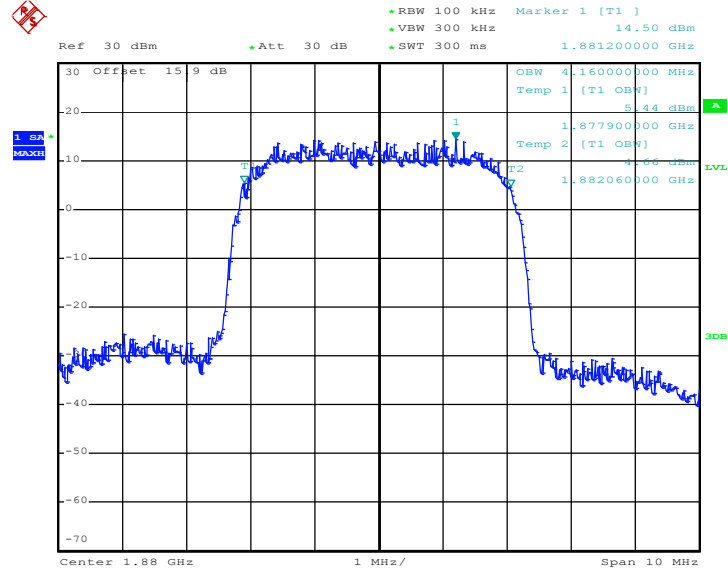

Date: 15.DEC.2011 17:39:17

26dB Bandwidth Plot on Channel 9400

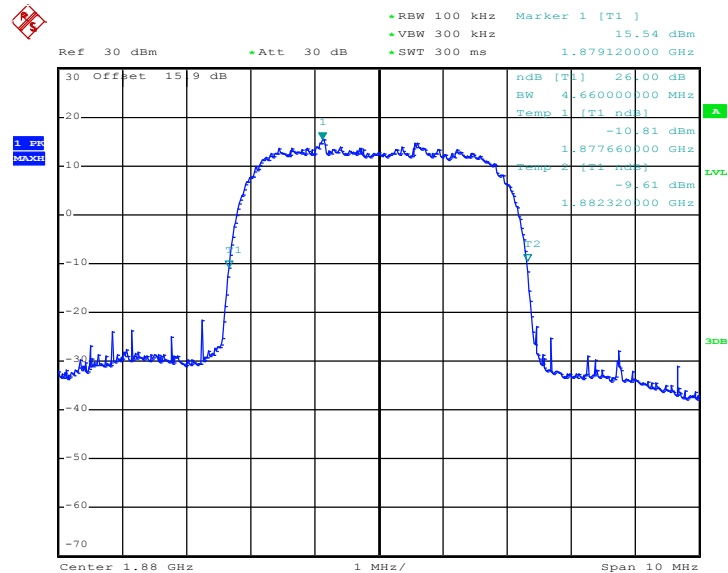

Date: 15.DEC.2011 17:11:11



3.4 Band Edge Measurement

3.4.1 Description of Band Edge Measurement

The power of any emission outside of the authorized operating frequency ranges must be lower than the transmitter power (P) by a factor of at least $43 + 10 \log (P)$ dB.

3.4.2 Measuring Instruments

See list of measuring instruments of this test report.

3.4.3 Test Procedures

1. The EUT was connected to Spectrum Analyzer and Base Station via power divider.
2. The band edges of low and high channels for the highest RF powers were measured. Setting RBW as roughly $BW/100$.

3.4.4 Test Setup

<Conducted Band Edge >

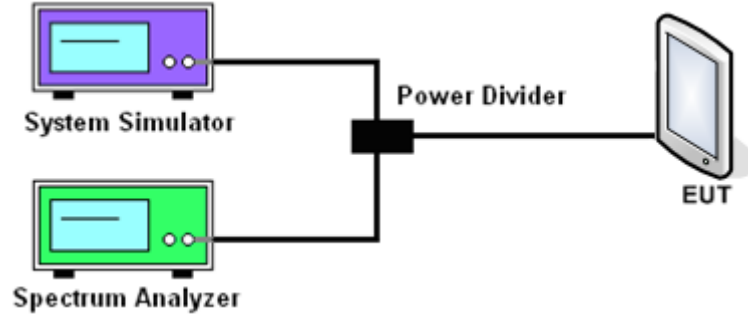

<Radiated Band Edge>

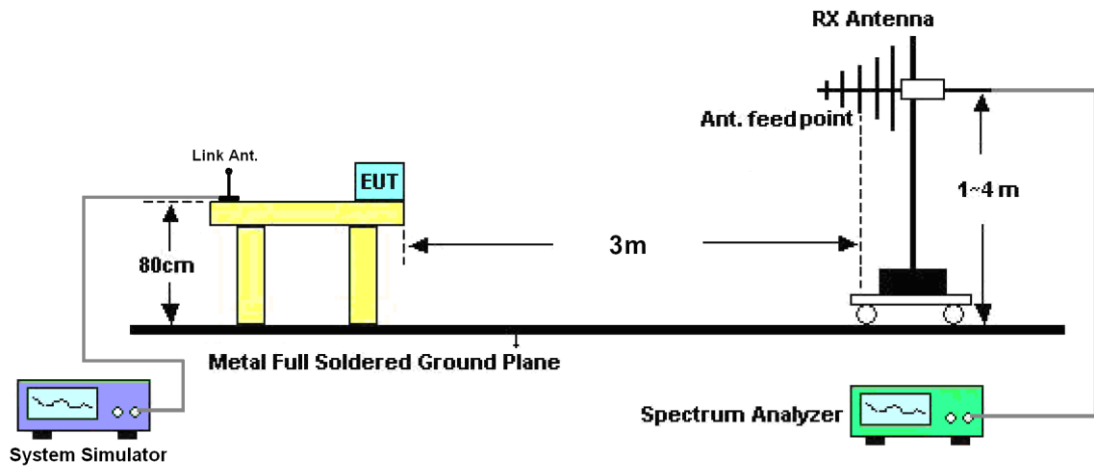



3.4.5 Test Result (Plots) of Conducted Band Edge

Band :	WCDMA Band V	Power Stage :	High
Test Mode :	RMC 12.2Kbps Link		

Lower Band Edge Plot on Channel 4132

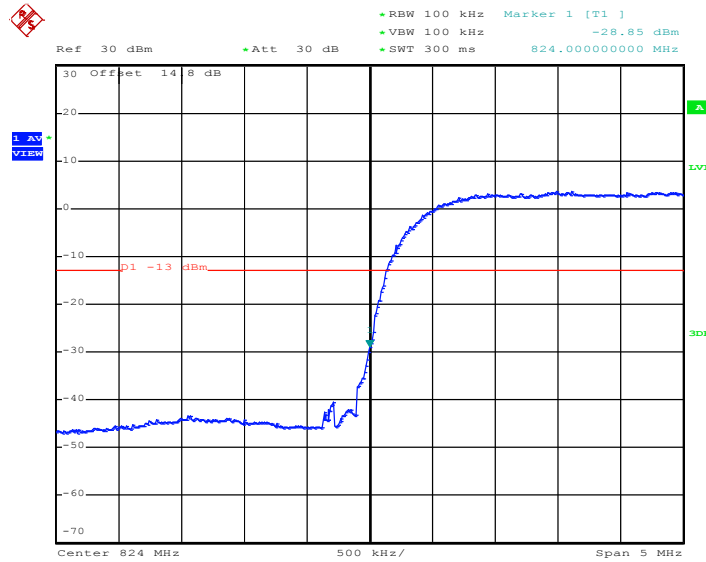

Date: 15.DEC.2011 18:22:50

Higher Band Edge Plot on Channel 4233

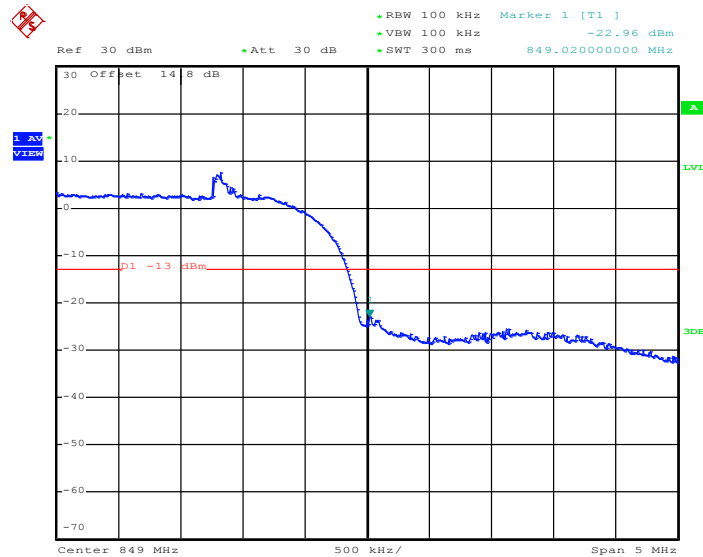

Date: 15.DEC.2011 18:23:16



Band :	WCDMA Band II	Power Stage :	High
Test Mode :	RMC 12.2Kbps Link		

Lower Band Edge Plot on Channel 9262

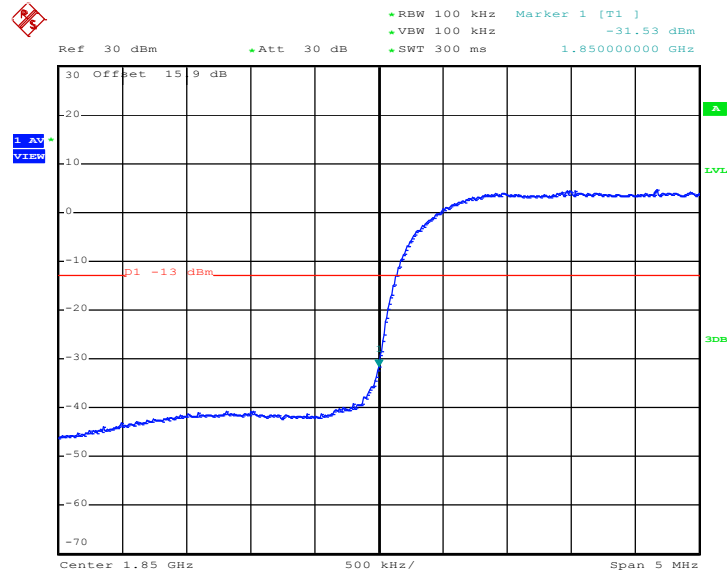

Date: 15.DEC.2011 17:14:25

Higher Band Edge Plot on Channel 9538

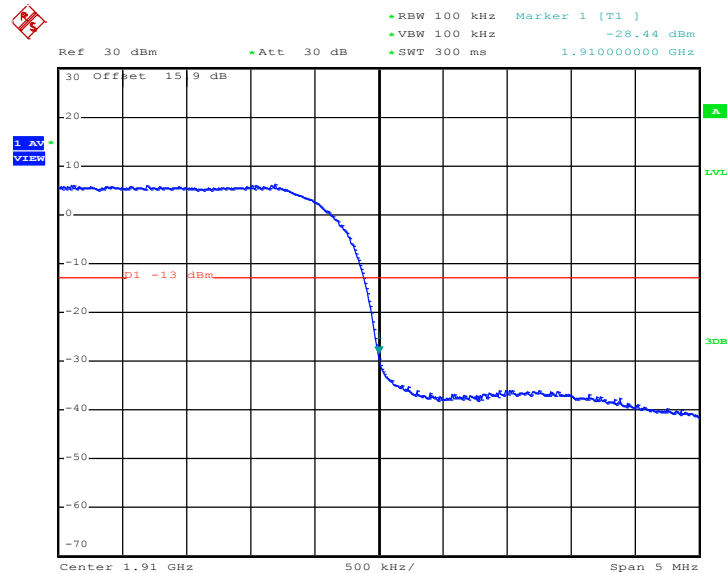

Date: 15.DEC.2011 17:41:38

3.4.6 Conducted Emission Measurement

3.4.7 Description of Conducted Emission Measurement

The power of any emission outside of the authorized operating frequency ranges must be lower than the transmitter power (P) by a factor of at least $43 + 10 \log (P)$ dB.

It is measured by means of a calibrated spectrum analyzer and scanned from 30 MHz up to a frequency including its 10th harmonic.

3.4.8 Measuring Instruments

See list of measuring instruments of this test report.

3.4.9 Test Procedures

1. The EUT was connected to spectrum analyzer and base station via power divider.
2. The middle channel for the highest RF power within the transmitting frequency was measured.
3. The conducted spurious emission for the whole frequency range was taken.

3.4.10 Test Setup

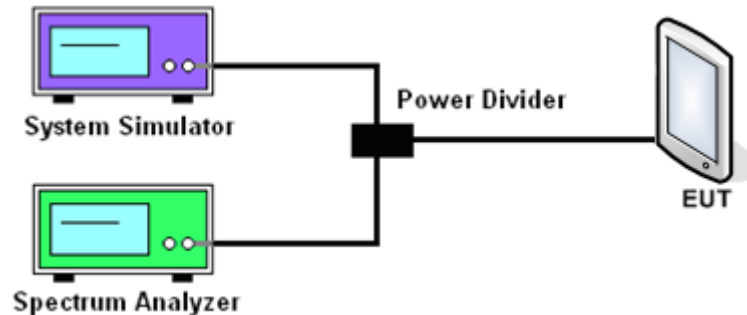



3.4.11 Test Result (Plots) of Conducted Emission

Band :	WCDMA Band V	Channel :	CH4182
Test Mode :	RMC 12.2Kbps Link		

Conducted Emission Plot between 30MHz ~ 1GHz

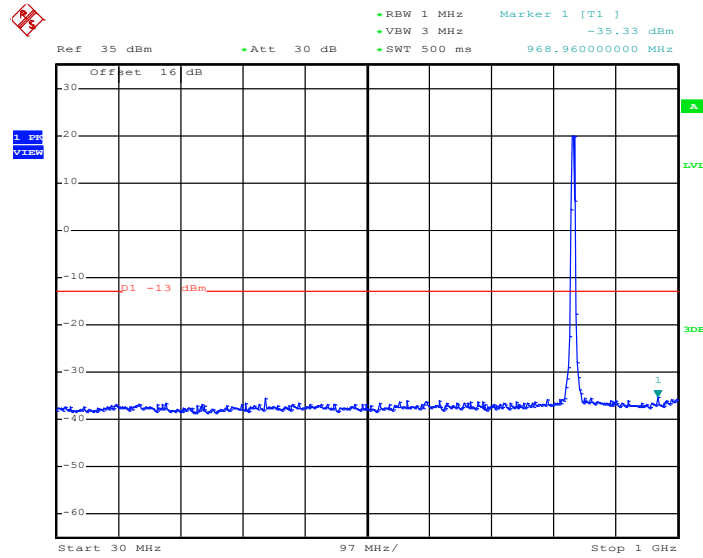

Date: 15.DEC.2011 18:17:44

Conducted Emission Plot between 1GHz ~ 3GHz

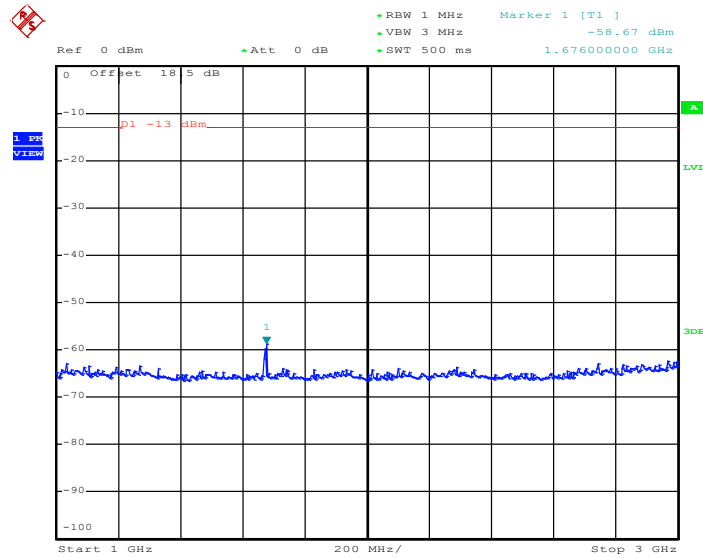

Date: 15.DEC.2011 18:18:00



Conducted Emission Plot between 3GHz ~ 7GHz

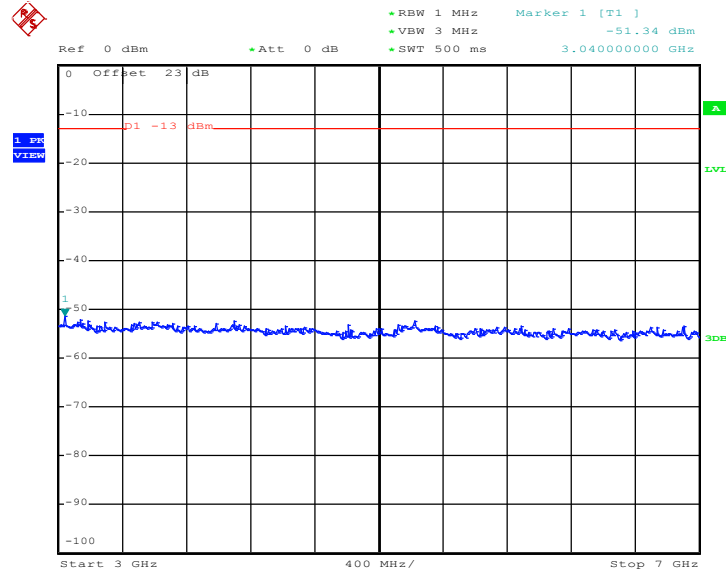

Date: 15.DEC.2011 18:18:13

Conducted Emission Plot between 7GHz ~ 9GHz

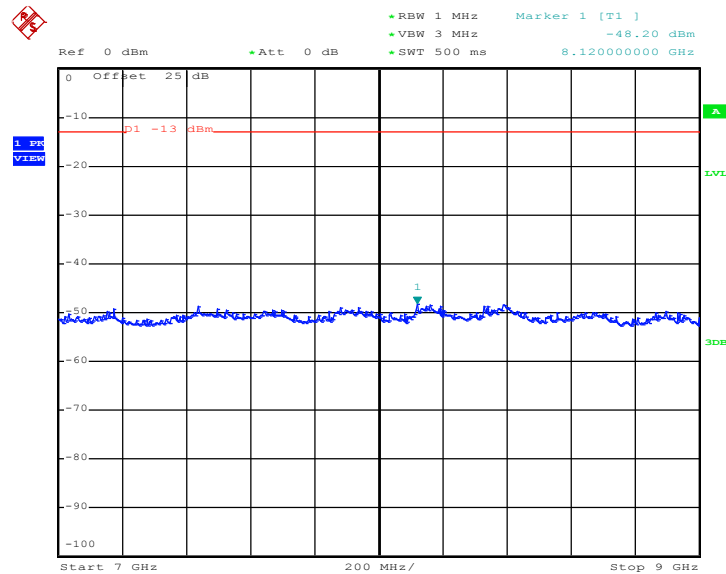

Date: 15.DEC.2011 18:18:25



Band :	WCDMA Band II	Channel :	CH9400
Test Mode :	RMC 12.2Kbps Link		

Conducted Emission Plot between 30MHz ~ 1GHz

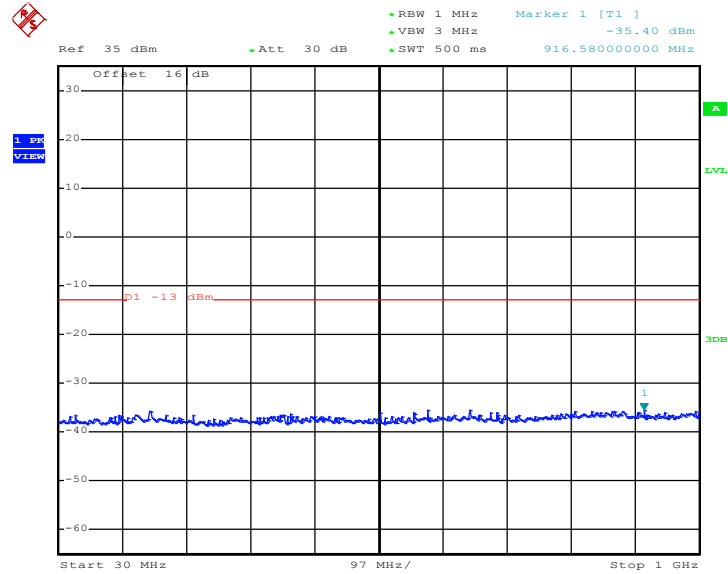

Date: 15.DEC.2011 17:45:02

Conducted Emission Plot between 1GHz ~ 3GHz

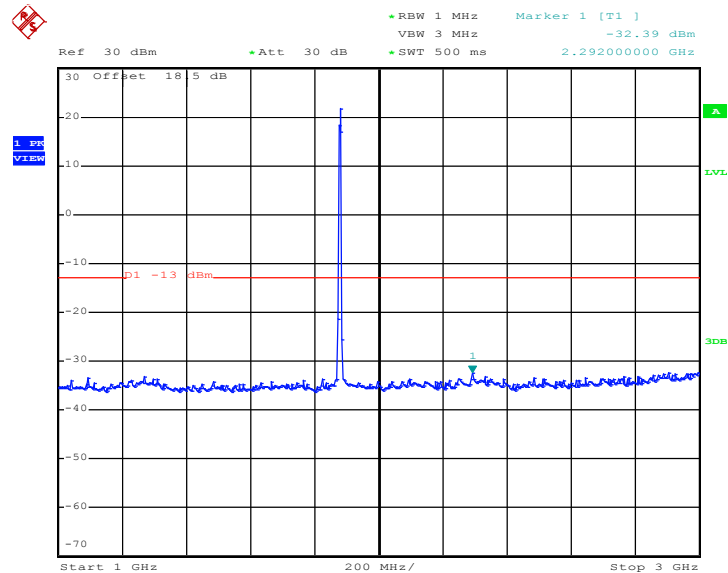

Date: 22.DEC.2011 23:29:50



Conducted Emission Plot between 13.6GHz ~ 19.1GHz

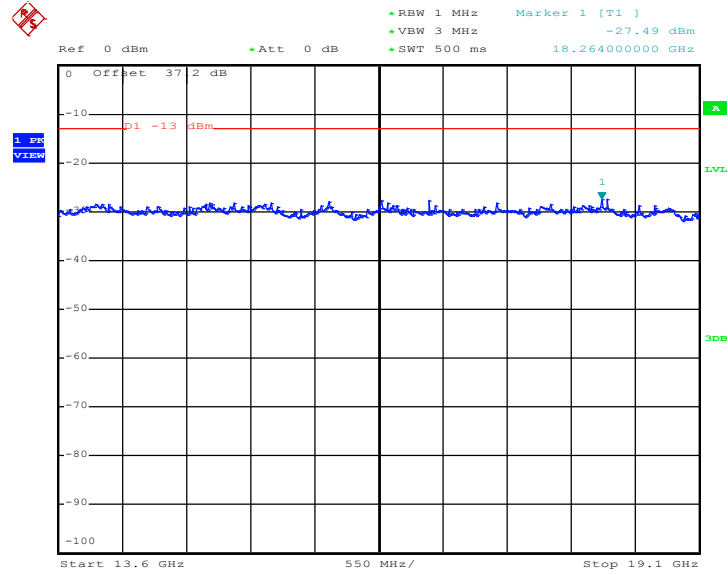

Date: 15.DEC.2011 17:45:56



3.5 Field Strength of Spurious Radiation Measurement

3.5.1 Description of Field Strength of Spurious Radiated Measurement

The radiated spurious emission was measured by substitution method according to ANSI / TIA / EIA-603-C-2004. The power of any emission outside of the authorized operating frequency ranges must be attenuated below the transmitter power (P) by a factor of at least $43 + 10 \log (P)$ dB. The spectrum is scanned from 30 MHz up to a frequency including its 10th harmonic.

3.5.2 Measuring Instruments

See list of measuring instruments of this test report.

3.5.3 Test Procedures

1. The EUT was placed on a rotatable wooden table with 0.8 meter about ground.
2. The EUT was set 3 meters from the receiving antenna, which was mounted on the antenna tower.
3. The table was rotated 360 degrees to determine the position of the highest spurious emission.
4. The height of the receiving antenna is varied between one meter and four meters to search the maximum spurious emission for both horizontal and vertical polarizations.
5. Make the measurement with the spectrum analyzer's RBW = 1MHz, VBW = 3MHz, Sweep = 500ms, Taking the record of maximum spurious emission.
6. A horn antenna was substituted in place of the EUT and was driven by a signal generator.
7. Tune the output power of signal generator to the same emission level with EUT maximum spurious emission.
8. Taking the record of output power at antenna port.
9. Repeat step 7 to step 8 for another polarization.
10. $EIRP \text{ (dBm)} = S.G. \text{ Power} - Tx \text{ Cable Loss} + Tx \text{ Antenna Gain}$
11. $ERP \text{ (dBm)} = EIRP - 2.15$

3.5.4 Test Setup

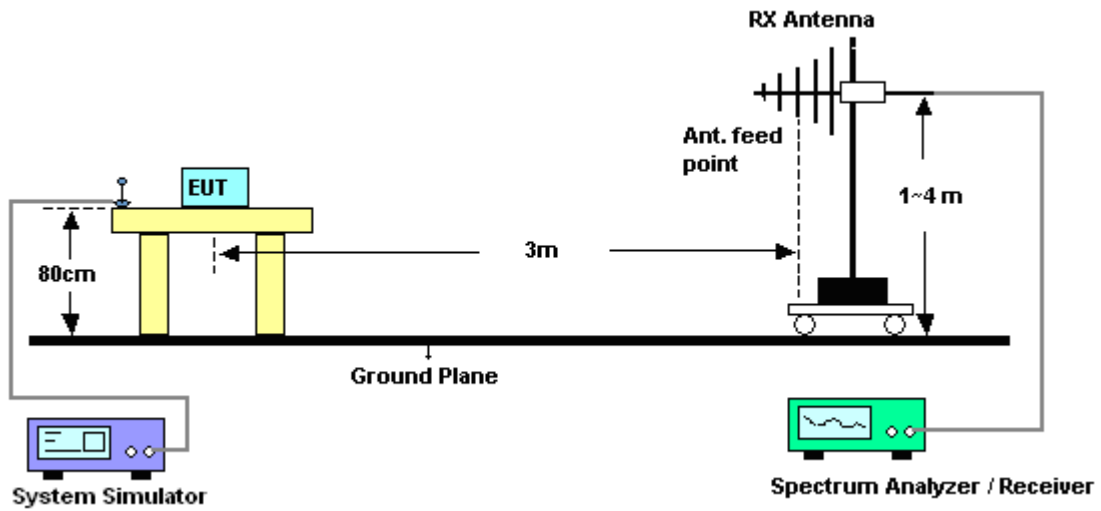



3.5.5 Test Result of Field Strength of Spurious Radiated

Band :	WCDMA Band V	Temperature :	21~23°C
Test Mode :	RMC 12.2Kbps Link	Relative Humidity :	50~51%
Test Engineer :	David Yang	Polarization :	Horizontal
Remark :	Spurious emissions within 30-1000MHz were found more than 20dB below limit line.		

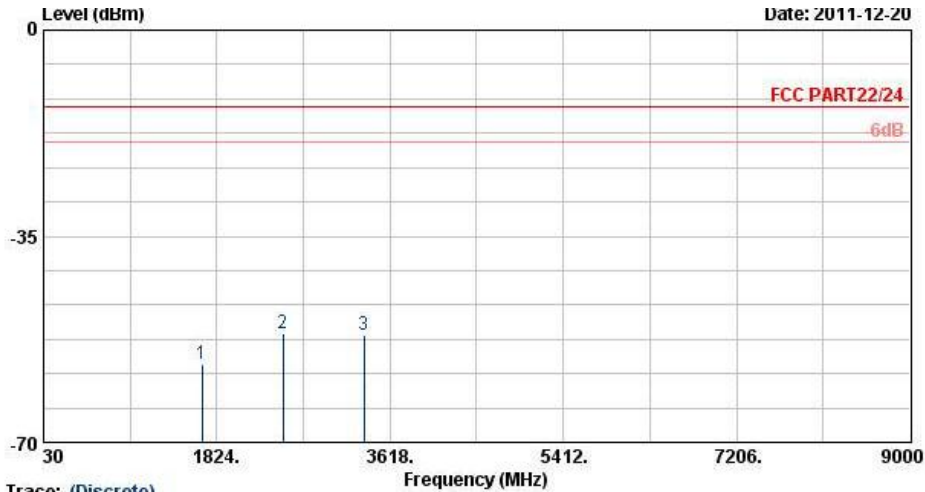

Trace: (Discrete)
 Site : 03CH07-HY
 Condition : FCC PART22/24 HF-ETRP(080306) HORIZONTAL
 Project : FG 1D0774

Frequency (MHz)	ERP (dBm)	Limit (dBm)	Over Limit (dB)	SPA Reading (dBm)	S.G. Power (dBm)	TX Cable loss (dB)	TX Antenna Gain (dBi)	Polarization (H/V)	Result
1672	-56.64	-13	-43.64	-65.33	-58.36	1.62	5.49	H	Pass
2509	-51.50	-13	-38.50	-66.01	-53.47	2.1	6.22	H	Pass
3345	-51.89	-13	-38.89	-66.12	-54.78	3.03	8.07	H	Pass



Band :	WCDMA Band V	Temperature :	21~23°C
Test Mode :	RMC 12.2Kbps Link	Relative Humidity :	50~51%
Test Engineer :	David Yang	Polarization :	Vertical
Remark :	Spurious emissions within 30-1000MHz were found more than 20dB below limit line.		

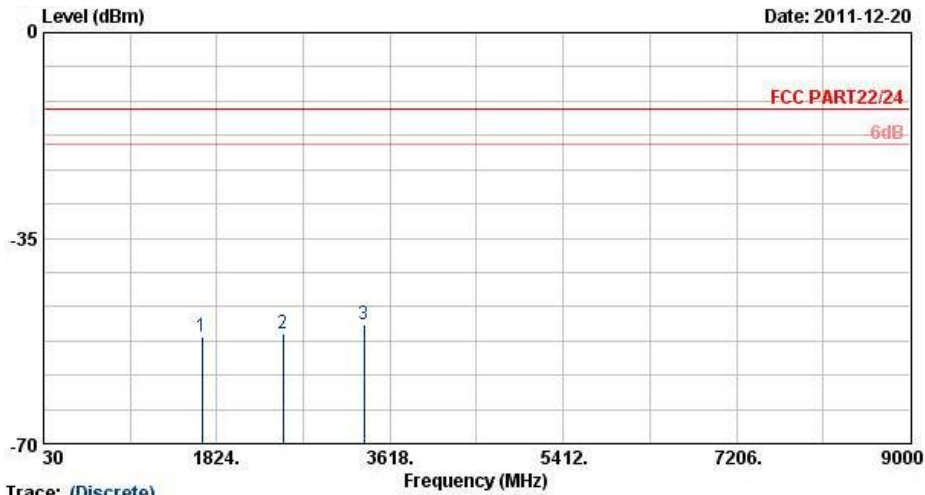

Trace: (Discrete)
 Site : 08CH07-HY
 Condition : FCC PART22/24 HF-ETRP(080306) VERTICAL
 Project : FG 1D0774

Frequency (MHz)	ERP (dBm)	Limit (dBm)	Over Limit (dB)	SPA Reading (dBm)	S.G. Power (dBm)	TX Cable loss (dB)	TX Antenna Gain (dBi)	Polarization (H/V)	Result
1672	-51.85	-13	-38.85	-64.34	-53.57	1.62	5.49	V	Pass
2509	-51.26	-13	-38.26	-66.48	-53.23	2.1	6.22	V	Pass
3345	-49.60	-13	-36.60	-65.73	-52.49	3.03	8.07	V	Pass



Band :	WCDMA Band II	Temperature :	21~23°C
Test Mode :	RMC 12.2Kbps Link	Relative Humidity :	50~51%
Test Engineer :	David Yang	Polarization :	Horizontal
Remark :	Spurious emissions within 30-1000MHz were found more than 20dB below limit line.		

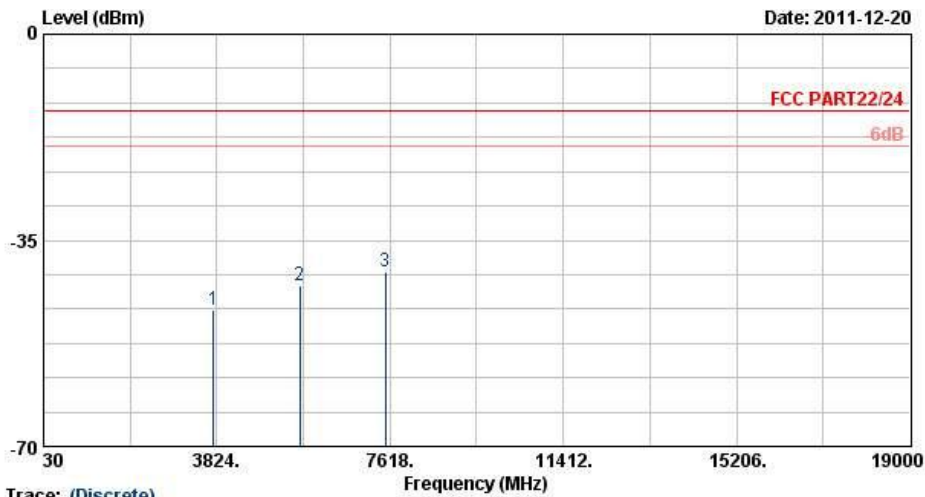

Trace: (Discrete)
 Site : 03CH07-RY
 Condition : FCC PART22/24 HF-EIRP(080306) HORIZONTAL
 Project : FG 1D0774

Frequency (MHz)	EIRP (dBm)	Limit (dBm)	Over Limit (dB)	SPA Reading (dBm)	S.G. Power (dBm)	TX Cable loss (dB)	TX Antenna Gain (dBi)	Polarization (H/V)	Result
3760	-46.91	-13	-33.91	-63.09	-53.21	2.51	8.81	H	Pass
5636	-42.57	-13	-29.57	-64.14	-50.28	2.99	10.70	H	Pass
7520	-40.22	-13	-27.22	-67.3	-48.75	3.59	12.12	H	Pass



Band :	WCDMA Band II	Temperature :	21~23°C
Test Mode :	RMC 12.2Kbps Link	Relative Humidity :	50~51%
Test Engineer :	David Yang	Polarization :	Vertical
Remark :	Spurious emissions within 30-1000MHz were found more than 20dB below limit line.		

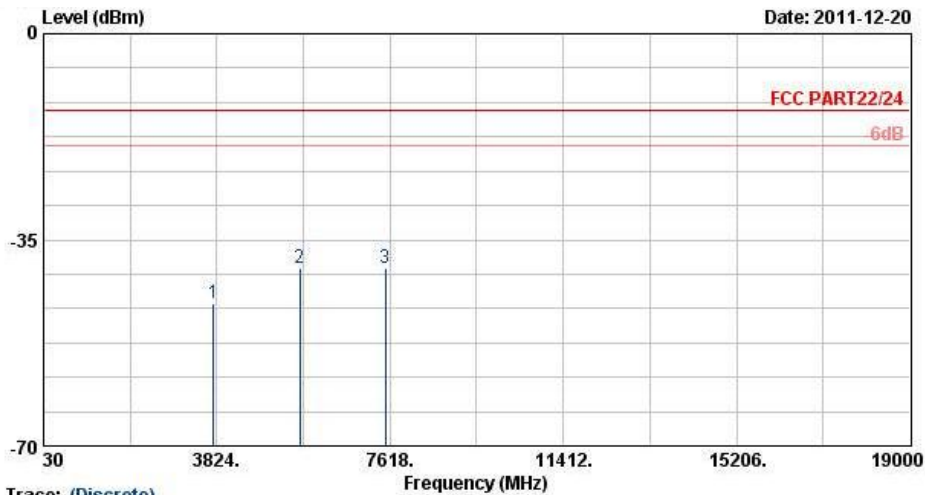

Trace: (Discrete)
 Site : 03CH07-HY
 Condition : FCC PART22/24 HF-EIRP(080306) VERTICAL
 Project : FG 1D0774

Frequency (MHz)	EIRP (dBm)	Limit (dBm)	Over Limit (dB)	SPA Reading (dBm)	S.G. Power (dBm)	TX Cable loss (dB)	TX Antenna Gain (dBi)	Polarization (H/V)	Result
3760	-45.89	-13	-32.89	-62.68	-52.19	2.51	8.81	V	Pass
5636	-39.87	-13	-26.87	-60.34	-47.58	2.99	10.70	V	Pass
7520	-39.78	-13	-26.78	-67.28	-48.31	3.59	12.12	V	Pass

3.6 Frequency Stability Measurement

3.6.1 Description of Frequency Stability Measurement

The frequency stability shall be measured by variation of ambient temperature and variation of primary supply voltage to ensure that the fundamental emission stays within the authorized frequency block. The frequency stability of the transmitter shall be maintained within $\pm 0.00025\%$ ($\pm 2.5\text{ppm}$) of the center frequency.

3.6.2 Measuring Instruments

See list of measuring instruments of this test report.

3.6.3 Test Procedures for Temperature Variation

1. The EUT was set up in the thermal chamber and connected with the base station.
2. With power OFF, the temperature was decreased to -30°C and the EUT was stabilized for three hours. Power was applied and the maximum change in frequency was recorded within one minute.
3. With power OFF, the temperature was raised in 10°C step up to 50°C . The EUT was stabilized at each step for at least half an hour. Power was applied and the maximum frequency change was recorded within one minute.
4. If the EUT cannot be turned on at -30°C , the testing lowest temperature will be raised in 10°C step until the EUT can be turned on.

3.6.4 Test Procedures for Voltage Variation

1. The EUT was placed in a temperature chamber at $25\pm 5^{\circ}\text{C}$ and connected with the base station.
2. The power supply voltage to the EUT was varied from BEP to 115% of the nominal value measured at the input to the EUT.
3. The variation in frequency was measured for the worst case.

3.6.5 Test Setup

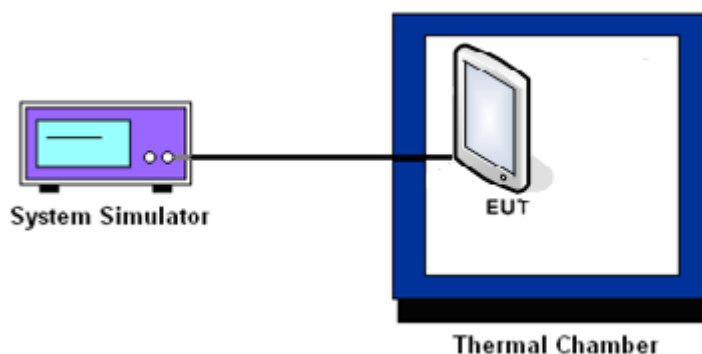

3.6.6 Test Result of Temperature Variation

Band :	WCDMA Band V	Channel :	4182
Limit (ppm) :	2.5		
Temperature (°C)	RMC 12.2Kbps		Result
	Freq. Dev. (Hz)	Deviation (ppm)	
-30	N/A	N/A	PASS
-20	N/A	N/A	
-10	N/A	N/A	
0	10	0.01	
10	7	0.01	
20	-6	-0.01	
30	-3	0.00	
40	4	0.00	
50	N/A	N/A	

Note: The manufacturer declared that the EUT could work properly between temperatures 0°C~40°C.



Band :	WCDMA Band II	Channel :	9400
Limit (ppm) :	2.5		

Temperature (°C)	RMC 12.2Kbps		Result
	Freq. Dev. (Hz)	Deviation (ppm)	
-30	N/A	N/A	PASS
-20	N/A	N/A	
-10	N/A	N/A	
0	10	0.01	
10	-6	0.00	
20	8	0.00	
30	-9	0.00	
40	-7	0.00	
50	N/A	N/A	

Note: The manufacturer declared that the EUT could work properly between temperatures 0°C~40°C.

3.6.7 Test Result of Voltage Variation

Band & Channel	Mode	Voltage (Volt)	Freq. Dev. (Hz)	Deviation (ppm)	Limit (ppm)	Result
WCDMA Band V CH4182	RMC 12.2Kbps	3.8	8	0.01	2.5	PASS
		BEP	4	0.00		
		4.2	-7	-0.01		
WCDMA Band II CH9400	RMC 12.2Kbps	3.8	5	0.00		
		BEP	7	0.00		
		4.2	-9	0.00		

Note:

1. Normal Voltage = 3.8V.
2. Battery End Point (BEP) = 3.4 V.



4 List of Measuring Equipment

Instrument	Manufacturer	Model No.	Serial No.	Characteristics	Calibration Date	Test Date	Due Date	Remark
System Simulator	R&S	CMU200	117995	N/A	Jul. 28, 2011	Dec. 15, 2011	Jul. 27, 2012	Conducted (TH02-HY)
Spectrum Analyzer	R&S	FSP40	100055	9kHz~40GHz	Jun. 13, 2011	Dec. 15, 2011	Jun. 12, 2012	Conducted (TH02-HY)
Thermal Chamber	Ten Billion	TTH-D35P	TBN-930701	N/A	Jul. 27, 2011	Dec. 15, 2011	Jul. 26, 2012	Conducted (TH02-HY)
Bilog Antenna	SCHAFFNER	CBL6111C	2726	30MHz ~ 1GHz	Oct. 22, 2011	Dec. 20, 2011 ~ Dec. 21, 2011	Oct. 21, 2012	Radiation (03CH07-HY)
Spectrum Analyzer	R&S	FSP30	101067	9KHz ~ 30GHz	Dec. 06, 2011	Dec. 20, 2011 ~ Dec. 21, 2011	Dec. 05, 2012	Radiation (03CH07-HY)
Double Ridge Horn Antenna	ESCO	3117	00075962	1GHz ~ 18GHz	Aug. 10, 2011	Dec. 20, 2011 ~ Dec. 21, 2011	Aug. 09, 2012	Radiation (03CH07-HY)
Pre Amplifier	Agilent	8449B	3008A02362	1GHz~ 26.5GHz	Dec. 05, 2011	Dec. 20, 2011 ~ Dec. 21, 2011	Dec. 04, 2012	Radiation (03CH07-HY)
Pre Amplifier	COM-POWER	PA-103A	161241	10-1000MHz.32dB. GAIN	Mar. 29, 2011	Dec. 20, 2011 ~ Dec. 21, 2011	Mar. 28, 2012	Radiation (03CH07-HY)
EMI TEST RECEIVER	R&S	ESCI 7	100724	9kHz~7GHz	Aug. 22, 2011	Dec. 20, 2011 ~ Dec. 21, 2011	Aug. 21, 2012	Radiation (03CH07-HY)
Pre Amplifier	MITEQ	AMF-7D-00 101800-30-1	159088	1GHz ~ 18GHz	Feb. 21, 2011	Dec. 20, 2011 ~ Dec. 21, 2011	Feb. 20, 2012	Radiation (03CH07-HY)
System Simulator	R&S	CMU200	117997	N/A	Aug. 22, 2011	Dec. 20, 2011 ~ Dec. 21, 2011	Aug. 21, 2012	Radiation (03CH07-HY)
Spectrum Analyzer	R&S	ESU26	100390	20Hz ~ 26.5GHz	Dec. 22, 2011	Mar. 10, 2012	Dec. 21, 2012	Radiation (03CH05-HY)
COM-POWER	Double Ridge Horn	AH-118	701030	1GHz ~ 18GHz	N/A	Mar. 10, 2012	N/A	Radiation (03CH05-HY)
Bilog Antenna	SCHAFFNER	CBL6111C	2725	30MHz ~ 2GHz	Oct. 22, 2011	Mar. 10, 2012	Oct. 21, 2012	Radiation (03CH05-HY)
Turn Table	HD	Deis HD 2000	420/611	0 ~ 360 degree	N/A	Mar. 10, 2012	N/A	Radiation (03CH05-HY)
Antenna Mast	HD	MA 240	240/666	1 m ~ 4 m	N/A	Mar. 10, 2012	N/A	Radiation (03CH05-HY)
Horn Antenna	ESCO	3117	66584	1GHz ~ 18GHz	Aug. 04, 2011	Mar. 10, 2012	Aug. 03, 2012	Radiation (03CH05-HY)
COM-POWER	COM-POWER	PA-103	161075	10Hz ~ 1000MHz Gain:32dB	Mar. 29, 2011	Mar. 10, 2012	Mar. 28, 2012	Radiation (03CH05-HY)
Pre Amplifier	EMCI	EMC051845	SN980048	1GHz~18GHz	Jul. 18, 2011	Mar. 10, 2012	Jul. 17, 2012	Radiation (03CH05-HY)
Pre Amplifier	Agilent	8449B	3008A01917	1GHz~26.5GHz	Aug. 30, 2011	Mar. 10, 2012	Aug. 29, 2012	Radiation (03CH05-HY)

5 Uncertainty of Evaluation

Uncertainty of Radiated Emission Measurement (30 MHz ~ 1000 MHz)

Contribution	Uncertainty of X_i		$u(X_i)$
	dB	Probability Distribution	
Receiver Reading	0.41	Normal (k=2)	0.21
Antenna Factor Calibration	0.83	Normal (k=2)	0.42
Cable Loss Calibration	0.25	Normal (k=2)	0.13
Pre-Amplifier Gain Calibration	0.27	Normal (k=2)	0.14
RCV/SPA Specification	2.50	Rectangular	0.72
Antenna Factor Interpolation for Frequency	1.00	Rectangular	0.29
Site Imperfection	1.43	Rectangular	0.83
Mismatch	+0.39 / -0.41	U-Shape	0.28
Combined Standard Uncertainty $U_c(y)$	1.27		
Measuring Uncertainty for a Level of Confidence of 95% ($U = 2U_c(y)$)	2.54		

Uncertainty of Radiated Emission Measurement (1 GHz ~ 40 GHz)

Contribution	Uncertainty of X_i		$u(X_i)$	C_i	$C_i * u(X_i)$
	dB	Probability Distribution			
Receiver Reading	± 0.10	Normal (k=2)	0.10	1	0.10
Antenna Factor Calibration	± 1.70	Normal (k=2)	0.85	1	0.85
Cable Loss Calibration	± 0.50	Normal (k=2)	0.25	1	0.25
Receiver Correction	± 2.00	Rectangular	1.15	1	1.15
Antenna Factor Directional	± 1.50	Rectangular	0.87	1	0.87
Site Imperfection	± 2.80	Triangular	1.14	1	1.14
Mismatch Receiver VSWR $\Gamma_1 = 0.197$ Antenna VSWR $\Gamma_2 = 0.194$ Uncertainty = $20\text{Log}(1-\Gamma_1*\Gamma_2)$	+0.34 / -0.35	U-Shape	0.244	1	0.244
Combined Standard Uncertainty $U_c(y)$	2.36				
Measuring Uncertainty for a Level of Confidence of 95% ($U = 2U_c(y)$)	4.72				



Appendix A. Photographs of EUT

Please refer to Sporton report number EP1D0774 as below.