

# EMI Test Report

Tested in accordance with  
Federal Communications Commission (FCC)  
Personal Communications Services  
CFR 47 Parts 2, 22, 24 and 27  
&  
Industry Canada (IC) RSS- Gen, 132, 133 and 139



**A division of Research In Motion Limited**

**REPORT NO: RTS-5385-1108-52A\_rev1**

<b>PRODUCT MODEL NO:</b>	REC71UW, RED71UW
<b>TYPE NAME:</b>	BlackBerry® smartphone
<b>FCC ID:</b>	L6AREC70UW, L6ARED70UW
<b>IC:</b>	2503A-REC70UW, 2503A-RED70UW
<b>EMISSION DESIGNATOR (GSM):</b>	247KGXW
<b>EMISSION DESIGNATOR (EDGE):</b>	247KG7W
<b>EMISSION DESIGNATOR (WCDMA):</b>	4M21F9W

This Report supersedes the report RTS-5385-1108-52A dated September 20, 2011

**DATE:** November 11, 2011

	EMI Test Report for the BlackBerry® smartphone Model REC71UW, RED71UW	
<b>Test Report No.</b> RTS-5385-1108-52A_rev1	<b>Dates of Test</b> July 26 to September 19 and November 11, 2011	FCC ID: L6AREC70UW IC ID: 2503A-REC70UW FCC ID: L6ARED70UW IC ID: 2503A-RED70UW

**Statement of Performance:**

The BlackBerry® smartphone, model REC71UW, part number CER-41249-001 Rev3 and accessories performs within the requirements of the test standards when configured and operated per RIM's instructions.

The BlackBerry® smartphone, model RED71UW, part number CER-41248-001 Rev3 and accessories performs within the requirements of the test standards when configured and operated per RIM's instructions.

**Declaration:**

We hereby certify that:

The test data reported herein is an accurate record of the performance of the sample(s) tested. The test results are valid for the tested unit (s) only. The test equipment used was suitable for the tests performed and within manufacturer's published specifications and operating parameters. The test methods were consistent with the methods described in the relevant standards.

Documented by:



Nielven Olis  
Regulatory Compliance Associate  
Date: November 11, 2011

Reviewed by:

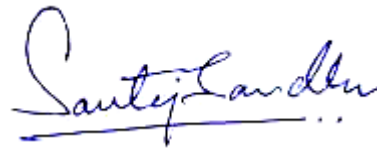

Savtej S. Sandhu  
Regulatory Compliance Specialist  
Date: November 11, 2011

Reviewed and Approved by:



Masud S. Attayi, P.Eng.  
Manager, Regulatory Compliance  
Date: November 11, 2011

	EMI Test Report for the BlackBerry® smartphone Model REC71UW, RED71UW	
<b>Test Report No.</b> RTS-5385-1108-52A_rev1	<b>Dates of Test</b> July 26 to September 19 and November 11, 2011	FCC ID: L6AREC70UW IC ID: 2503A-REC70UW FCC ID: L6ARED70UW IC ID: 2503A-RED70UW

## Table of Contents

A)	Scope .....	5
B)	Associated Documents.....	5
C)	Product Identification.....	6
D)	Support Equipment Used for the Testing of the EUT .....	8
E)	Test Voltage .....	8
F)	Test Results Chart.....	9
G)	Summary of Results .....	10
H)	Compliance Test Equipment Used .....	18
	APPENDIX 1A – GSM CONDUCTED RF EMISSIONS TEST DATA/PLOTS.....	20
	APPENDIX 1B– UMTS Band 2/5 CONDUCTED RF EMISSIONS TEST DATA/PLOTS .....	37
	APPENDIX 1C – UMTS Band 4 CONDUCTED RF EMISSIONS TEST DATA/PLOTS .....	54

	EMI Test Report for the BlackBerry® smartphone Model REC71UW, RED71UW	
<b>Test Report No.</b> RTS-5385-1108-52A_rev1	<b>Dates of Test</b> July 26 to September 19 and November 11, 2011	FCC ID: L6AREC70UW IC ID: 2503A-REC70UW FCC ID: L6ARED70UW IC ID: 2503A-RED70UW

APPENDIX 2A – GSM CONDUCTED RF OUTPUT POWER TEST DATA .....62

APPENDIX 2B – UMTS Band 2/5 CONDUCTED RF OUTPUT POWER TEST DATA.....64

APPENDIX 2C – UMTS Band 4 CONDUCTED RF OUTPUT POWER TEST DATA .....66

APPENDIX 3A – GSM FREQUENCY STABILITY TEST DATA .....68

APPENDIX 3B – UMTS Band 2/5 FREQUENCY STABILITY TEST DATA .....80

APPENDIX 3C – UMTS Band 4 FREQUENCY STABILITY TEST DATA .....92

APPENDIX 4A – GSM RADIATED EMISSIONS TEST DATA.....100

APPENDIX 4B – UMTS Band 2/5 RADIATED EMISSIONS TEST DATA .....109

APPENDIX 4C – UMTS Band 4 RADIATED EMISSIONS TEST DATA .....116

	EMI Test Report for the BlackBerry® smartphone Model REC71UW, RED71UW	
<b>Test Report No.</b> RTS-5385-1108-52A_rev1	<b>Dates of Test</b> July 26 to September 19 and November 11, 2011	FCC ID: L6AREC70UW IC ID: 2503A-REC70UW FCC ID: L6ARED70UW IC ID: 2503A-RED70UW

## A) Scope

This report details the results of compliance tests which were performed in accordance to the requirements of:

- FCC CFR 47 Part 2, Oct, 2010
- FCC CFR 47 Part 22, Subpart H, Cellular Radiotelephone Services, Oct., 2010
- FCC CFR 47 Part 24 Subpart E, Broadband PCS, Oct., 2010
- FCC CFR 47 Part 27, Subpart C, Technical Standards, Oct, 2010 (Model: RED71UW only)
- Industry Canada, RSS-132 Issue 2, September 2005, Cellular Telephones Employing New Technologies Operating in the Bands 824-849 MHz and 869-894 MHz.
- Industry Canada, RSS-133 Issue 5, February 2009, 2 GHz Personal Communications Services.
- Industry Canada, RSS-GEN Issue 3, December 2010, General Requirements and Information for the Certification of Radiocommunication Equipment
- Industry Canada, RSS-139 Issue 2, February 2009, Advanced Wireless Services Equipment Operating in the Bands 1710-1755 MHz and 2110-2155 MHz. (Model: RED71UW only)

## B) Associated Documents

1. REC71UW-HW\_Declaration\_CER-41249-001-Rev2
2. REC71UW-HW\_Declaration\_CER-41249-001-Rev3
3. RED71UW-HW\_Declaration\_CER-41248-001-Rev2
4. RED71UW-HW\_Declaration\_CER-41248-001-Rev3
5. MultiSourceDeclaration\_REC71UW\_7.0.0\_b1568
6. MultiSourceDeclaration\_REC71UW\_7.0.0\_b1763
7. BlackBerrySystemSimilarity \_REC71UW-RED71UW
8. Parts List\_Tune Up Exhibit

	EMI Test Report for the BlackBerry® smartphone Model REC71UW, RED71UW	
<b>Test Report No.</b> RTS-5385-1108-52A_rev1	<b>Dates of Test</b> July 26 to September 19 and November 11, 2011	FCC ID: L6AREC70UW IC ID: 2503A-REC70UW FCC ID: L6ARED70UW IC ID: 2503A-RED70UW

**C) Product Identification**

Manufactured by Research In Motion Limited whose headquarters is located at:  
295 Phillip Street  
Waterloo, Ontario  
Canada, N2L 3W8  
Phone: 519 888 7465  
Fax: 519 888 6906

The equipment under test (EUT) was tested at the following locations:

RIM Testing Services EMI test facilities

305 Phillip Street  
Waterloo, Ontario  
Canada, N2L 3W8  
Phone: 519 888 7465  
Fax: 519 888 6906

440 Phillip Street  
Waterloo, Ontario,  
Canada, N2L 5R9  
Phone: 519 888 7465  
Fax: 519 888 6906

The testing was performed from July 26 to September 19 and November 11, 2011.



EMI Test Report for the BlackBerry® smartphone Model REC71UW, RED71UW

**Test Report No.**  
RTS-5385-1108-52A\_rev1

**Dates of Test**  
July 26 to September 19 and  
November 11, 2011

FCC ID: L6AREC70UW IC ID: 2503A-REC70UW  
FCC ID: L6ARED70UW IC ID: 2503A-RED70UW

The sample EUT included:

Sample	Model	CER NUMBER	PIN	Software Information
1	REC71UW	CER-41249-001 Rev1	27DD7ADB	v7.0.0.285 Plat. 9.0.0.184 Bundle 1423
2	REC71UW	CER-41249-001 Rev1	27DD7A76	v7.0.0.285 Plat. 9.0.0.184 Bundle 1423
3	REC71UW	CER-41249-001 Rev2	282482BC	v7.0.0.327 Plat. 9.16.0.5 Bundle 1568
4	REC71UW	CER-41249-001 Rev3	2846E1CE	v7.0.0.382 Plat. 9.16.0.11 Bundle 1763
5	REC71UW	CER-41249-001 Rev3	2846E15F	v7.0.0.382 Plat. 9.16.0.11 Bundle 1763
6	REC71UW	CER-41249-001 Rev1	27DD7A7D	v7.0.0.285 Plat. 9.0.0.184 Bundle 1423
7	REC71UW	CER-41249-001 Rev1	27DD79E2	v7.0.0.285 Plat. 9.0.0.184 Bundle 1423
8	REC71UW	CER-41249-001 Rev3	2846E250	v7.0.0.382 Plat. 9.16.0.11 Bundle 1763
9	REC71UW	CER-41249-001 Rev3	2846E4A1	v7.0.0.382 Plat. 9.16.0.11 Bundle 1763
10	RED71UW	CER-41248-001 Rev3	28470CF0	v7.0.0.382 Plat. 9.16.0.11 Bundle 1763
11	RED71UW	CER-41248-001 Rev3	28470998	v7.0.0.382 Plat. 9.16.0.11 Bundle 1763
12	RED71UW	CER-41248-001 Rev3	28470C91	v7.0.0.382 Plat. 9.16.0.11 Bundle 1763
13	RED71UW	CER-41248-001 Rev3	28470977	v7.0.0.382 Plat. 9.16.0.11 Bundle 1763

	EMI Test Report for the BlackBerry® smartphone Model REC71UW, RED71UW	
<b>Test Report No.</b> RTS-5385-1108-52A_rev1	<b>Dates of Test</b> July 26 to September 19 and November 11, 2011	FCC ID: L6AREC70UW IC ID: 2503A-REC70UW FCC ID: L6ARED70UW IC ID: 2503A-RED70UW

RF Conducted Emissions testing was performed on samples 1, 2, 3, 4, 5, 10 and 11.  
RF Radiated Emissions testing was performed on samples 6, 7, 8, 9, 12 and 13.

Only the characteristics that have been affected by the changes from REC71UW Rev1 to REC71UW Rev3 were retested. For more information see document:  
REC71UW-HW\_Declaration\_CER-41249-001-Rev2 and  
REC71UW-HW\_Declaration\_CER-41249-001-Rev3

Only the characteristics that have been affected by the changes from RED71UW Rev1 to RED71UW Rev3 were retested. For more information see document:  
RED71UW-HW\_Declaration\_CER-41248-001-Rev2 and  
RED71UW-HW\_Declaration\_CER-41248-001-Rev3

Only the characteristics that have been affected by the changes from Model REC71UW to RED71UW were retested. For more information see document:  
BlackBerrySystemSimilarity\_REC71UW\_RED71UW

To view the differences between Bundle 1423 to 1763, see document:  
MultiSourceDeclaration\_REC71UW\_b1568 and  
MultiSourceDeclaration\_REC71UW\_b1763

#### D) Support Equipment Used for the Testing of the EUT

No support equipment required; for list of equipment refer to section H, Compliance Test Equipment Used.

#### E) Test Voltage

The ac input voltage was 120 volts, 60 Hz where applicable. This configuration was per RIM's specifications.





**Test Report No.**  
RTS-5385-1108-52A\_rev1

**Dates of Test**  
July 26 to September 19 and  
November 11, 2011

FCC ID: L6AREC70UW IC ID: 2503A-REC70UW  
FCC ID: L6ARED70UW IC ID: 2503A-RED70UW

## F) Test Results Chart

SPECIFICATION		TEST TYPE	RESULT	TEST DATA APPENDIX
FCC CFR 47	IC			
Part 2.1051 Part 22.917 Part 22.901	RSS-GEN, 4.9	GSM 850 Conducted Spurious Emissions	Pass	1A
Part 2.1051 Part 24.238(a)	RSS-GEN, 4.9	PCS 1900 Conducted Spurious Emissions	Pass	1A
Part 2.202 Part 22.917	RSS-GEN, 4.6	GSM 850 Occupied Bandwidth and Channel Mask	Pass	1A
Part 2.202 Part 24.238	RSS-GEN, 4.6	PCS 1900 Occupied Bandwidth and Channel Mask	Pass	1A
Part 2.1046(a)	RSS-133, 6.4 RSS-132, 4.4	GSM Conducted RF Output Power	Pass	2A
Part 2.1055(a)(d) Part 22.917	RSS-132, 4.3	GSM 850 Frequency Stability vs. Temperature and Voltage	Pass	3A
Part 2.1055(a)(d) Part 24.235	RSS-132, 4.3	PCS 1900 Frequency Stability vs. Temperature and Voltage	Pass	3A
Part 22, Subpart H, Part 24, Subpart E	RSS-GEN, 4.9	GSM ERP, EIRP	Pass	4A
Part 22, Subpart H Part 24, Subpart E	RSS-GEN, 4.9	GSM Radiated Spurious/Harmonic Emissions	Pass	4A
Part 2.1051 Part 22.917 Part 22.901(d)	RSS-GEN, 4.9	UMTS Band 5 Conducted Spurious Emissions	Pass	1B
Part 2.1051 Part 24.238(a)	RSS-GEN, 4.9	UMTS Band 2 Conducted Spurious Emissions	Pass	1B
Part 2.202 Part 22.917	RSS-GEN, 4.6	UMTS Band 5 Occupied Bandwidth and Channel Mask	Pass	1B
Part 2.202 Part 24.238	RSS-GEN, 4.6	UMTS Band 2 Occupied Bandwidth and Channel Mask	Pass	1B
Part 2.1046(a)	RSS-133, 6.4 RSS-132, 4.4	UMTS Band 2 and 5 Conducted RF Output Power	Pass	2B
Part 2.1055(a)(d) Part 22.917	RSS-132, 4.3	UMTS Band 5 Frequency Stability vs. Temperature and Voltage	Pass	3B

This report shall NOT be reproduced except in full without the written consent of RIM Testing Services  
- A division of Research in Motion Limited.

	EMI Test Report for the BlackBerry® smartphone Model REC71UW, RED71UW	
	<b>Test Report No.</b> RTS-5385-1108-52A_rev1	<b>Dates of Test</b> July 26 to September 19 and November 11, 2011

## Test Results Chart cont'd

Part 2.1055(a)(d) Part 24.235	RSS-GEN, 4.7	UMTS Band 2 Frequency Stability vs. Temperature and Voltage	Pass	3B
Part 22, Subpart H	RSS-GEN, 4.9	UMTS Band 5 Radiated Spurious/Harmonic Emissions, ERP	Pass	4B
Part 24, Subpart E	RSS-GEN, 4.9	UMTS Band 2 Radiated Spurious/Harmonic Emissions, EIRP	Pass	4B
Part 27.53	RSS-139, 6.5	WCDMA UMTS Band 4 Conducted Spurious Emissions	Pass	1C
Part 2.202 Part 27.53	RSS-GEN, 2.3	WCDMA UMTS Band 4 Occupied Bandwidth and Channel Mask	Pass	1C
Part 2.1046(a)	RSS-139, 6.4	WCDMA UMTS Band 4 Conducted RF Output Power	Pass	2C
Part 2.1055(a)(d) Part 27.54	RSS-139, 6.3	WCDMA UMTS Band 4 Frequency Stability vs. Temperature and Voltage	Pass	3C
Part 27.53	RSS-139, 6.5	WCDMA UMTS Band 4 Radiated Spurious/Harmonic Emissions	Pass	4C
Part 27.50	RSS-139, 6.4	WCDMA UMTS Band 4 EIRP	Pass	4C

## G) Summary of Results

### 1) Conducted Emission Measurements

The following test configurations were measured for model REC71UW:

a) The BlackBerry® smartphone met the requirements of the Tx Conducted Spurious Emissions requirements in the GSM850 as per 47 CFR 2.1051, CFR 22.917, CFR 22.901(d) and RSS-GEN, 4.9. The EUT was measured on the low, middle and high channels. The frequency range investigated was from 10 MHz to 10 GHz.

See APPENDIX 1A for test data.

The BlackBerry® smartphone met the requirements of the Tx Conducted Spurious Emissions requirements in the PCS1900 as per 47 CFR 2.1051, CFR 24.238(a)

This report shall NOT be reproduced except in full without the written consent of RIM Testing Services  
- A division of Research in Motion Limited.

	EMI Test Report for the BlackBerry® smartphone Model REC71UW, RED71UW	
<b>Test Report No.</b> RTS-5385-1108-52A_rev1	<b>Dates of Test</b> July 26 to September 19 and November 11, 2011	FCC ID: L6AREC70UW IC ID: 2503A-REC70UW FCC ID: L6ARED70UW IC ID: 2503A-RED70UW

and RSS-GEN, 4.9. The EUT was on the low, middle and high channels. The frequency range investigated was from 10 MHz to 20 GHz. See APPENDIX 1A for test data

b) The BlackBerry® smartphone met the requirements of the Occupied Bandwidth and channel mask requirements in the GSM850 as per 47 CFR 2.202, CFR 22.917 and RSS-GEN, 4.6. The EUT was measured in GSM and EDGE mode on the low, middle and high channels. The worst case occupied bandwidth was 247.0 kHz on middle channel in GSM mode, and 243.0 kHz on middle channel in EDGE mode. See APPENDIX 1A for test data.

The BlackBerry® smartphone met the requirements of the Occupied Bandwidth and channel mask requirements in the PCS1900 as per 47 CFR 2.202, CFR 24.238 and RSS-GEN, 4.6. The EUT was measured in GSM and EDGE mode on the low, middle and high channels. The worst case occupied bandwidth was 245.0 kHz on low and middle channels in GSM, and 247.0 kHz on high channel in EDGE mode. See APPENDIX 1A for test data.

c) The BlackBerry® smartphone met the requirements of the Tx Conducted RF output Power requirements in the GSM850 as per 47 CFR 2.1046, and RSS-GEN, 4.4. The EUT was measured on the low, middle and high channels. The frequency range investigated was from 10 MHz to 10 GHz. See APPENDIX 2A for test data.

The BlackBerry® smartphone met the requirements of the Tx Conducted RF output Power requirements in the PCS1900 as per 47 CFR 2.1046, and RSS-GEN, 6.4. The EUT was on the low, middle and high channels. The frequency range investigated was from 10 MHz to 20 GHz. See APPENDIX 2A for test data

d) The BlackBerry® smartphone met the requirements of the Frequency Stability requirements in the GSM850 as per 47 CFR 2.1055, CFR 22.917 and RSS-GEN, 4.3. The EUT was measured in GSM850 mode on the low, middle and high channels. See APPENDIX 3A for test data.

The BlackBerry® smartphone met the requirements of the Frequency Stability requirements in the PCS1900 as per 47 CFR 2.1055, CFR 24.235 and RSS-GEN, 4.7. The EUT was measured in PCS1900 mode on the low, middle and high channels. See APPENDIX 3A for test data.

	EMI Test Report for the BlackBerry® smartphone Model REC71UW, RED71UW	
<b>Test Report No.</b> RTS-5385-1108-52A_rev1	<b>Dates of Test</b> July 26 to September 19 and November 11, 2011	FCC ID: L6AREC70UW IC ID: 2503A-REC70UW FCC ID: L6ARED70UW IC ID: 2503A-RED70UW

e) The BlackBerry® smartphone met the requirements of the Tx Conducted Spurious Emissions requirements in the UMTS band 5 as per 47 CFR 2.1051, CFR 22.917, CFR 22.901(d) and RSS-GEN, 4.9. The EUT was measured on the low, middle and high channels. The frequency range investigated was from 10 MHz to 10 GHz.

See APPENDIX 1B for test data.

The BlackBerry® smartphone met the requirements of the Tx Conducted Spurious Emissions requirements in the UMTS band 2 as per 47 CFR 2.1051, CFR 24.238(a) and RSS-GEN, 4.9. The EUT was on the low, middle and high channels. The frequency range investigated was from 10 MHz to 20 GHz.

See APPENDIX 1B for test data

f) The BlackBerry® smartphone met the requirements of the Occupied Bandwidth and channel mask requirements in the UMTS band 5 as per 47 CFR 2.202, CFR 22.917 and RSS-GEN, 4.6. The EUT was measured in Loopback and HSUPA mode on the low, middle and high channels. The worst case occupied bandwidth was 4.208 MHz on high channel in Loopback mode, and 4.208 MHz on high channel in HSUPA mode.

See APPENDIX 1B for test data.

The BlackBerry® smartphone met the requirements of the Occupied Bandwidth and channel mask requirements in the UMTS band 2 as per 47 CFR 2.202, CFR 24.238 and RSS-GEN, 4.6. The EUT was measured in Loopback and HSUPA mode on the low, middle and high channels. The worst case occupied bandwidth was 4.208 MHz on middle and high channels in Loopback, and 4.208 MHz on middle channel in HSUPA mode.

See APPENDIX 1B for test data.

g) The BlackBerry® smartphone met the requirements of the Tx Conducted RF output Power requirements in the UMTS band 5 as per 47 CFR 2.1046, and RSS-GEN, 4.4. The EUT was measured on the low, middle and high channels. The frequency range investigated was from 10 MHz to 10 GHz.

See APPENDIX 2B for test data.

The BlackBerry® smartphone met the requirements of the Tx Conducted RF output Power requirements in the UMTS band 2 as per 47 CFR 2.1046, and RSS-GEN, 6.4. The EUT was on the low, middle and high channels. The frequency range investigated was from 10 MHz to 20 GHz.

See APPENDIX 2B for test data

	EMI Test Report for the BlackBerry® smartphone Model REC71UW, RED71UW	
<b>Test Report No.</b> RTS-5385-1108-52A_rev1	<b>Dates of Test</b> July 26 to September 19 and November 11, 2011	FCC ID: L6AREC70UW IC ID: 2503A-REC70UW FCC ID: L6ARED70UW IC ID: 2503A-RED70UW

h) The BlackBerry® smartphone met the requirements of the Frequency Stability requirements in the UMTS band 5 as per 47 CFR 2.1055, CFR 22.917 and RSS-GEN, 4.3. The EUT was measured in UMTS band 5 mode on the low, middle and high channels.  
See APPENDIX 3B for test data.

The BlackBerry® smartphone met the requirements of the Frequency Stability requirements in the UMTS band 2 as per 47 CFR 2.1055, CFR 24.235 and RSS-GEN, 4.7. The EUT was measured in UMTS band 2 mode on the low, middle and high channels.  
See APPENDIX 3B for test data.

The following test configurations were measured for model RED71UW:

i) The BlackBerry® smartphone met the requirements of the Tx Conducted Spurious Emissions requirements in UMTS band 4 as per 47 CFR 27.53 and RSS-139, 6.5. The EUT was measured on the low, middle and high channels. The frequency range investigated was from 10 MHz to 20 GHz.  
See APPENDIX 1C for test data.

j) The BlackBerry® smartphone met the requirements of the Occupied Bandwidth in the UMTS band 4 as per 47 CFR 2.202, CFR 27.53 and RSS-139, 2.3. The low, middle and high channels were measured. The worst case occupied bandwidth was 4.192 MHz on low and high channels in Loopback and 4.192 MHz on low and high channel in HSUPA mode.  
See APPENDIX 1C for test data.

k) The BlackBerry® smartphone met the requirements of the Conducted RF Output Power for the UMTS band 4 as per 47 CFR 2.1046(a), RSS-139, 6.4 and RSS-132, 4.4. The low, middle and high channels were measured.  
See APPENDIX 2C for test data.

l) The BlackBerry® smartphone met the requirements of the Frequency Stability vs. Temperature and Voltage for UMTS band 4 as per 47 CFR 2.1055(a)(d), CFR 27.54 and RSS-139, 6.3. The maximum frequency error measured was less than 0.1 ppm. The temperature range was from -30°C to +60°C in 10° temperature steps. The BlackBerry® smartphone was measured on low, middle and high channels at each temperature step. The BlackBerry® smartphone was measured at low (3.6 volts), nominal (3.7 volts) and high (4.2 volts) dc input voltage at each temperature step and channel at maximum output power.  
See APPENDIX 3C for test data.

	EMI Test Report for the BlackBerry® smartphone Model REC71UW, RED71UW	
<b>Test Report No.</b> RTS-5385-1108-52A_rev1	<b>Dates of Test</b> July 26 to September 19 and November 11, 2011	FCC ID: L6AREC70UW IC ID: 2503A-REC70UW FCC ID: L6ARED70UW IC ID: 2503A-RED70UW

## 2) Radiated Emission Measurements

The radiated spurious emissions/harmonics and ERP/EIRP were measured for GSM 850, PCS 1900, UMTS band 2, UMTS band 4 and UMTS band 5. The results are within the limits. The BlackBerry® smartphone was placed on a nonconductive styrofoam table, 100 cm high that was positioned on a remotely controlled turntable. The test distance used between the BlackBerry® smartphone and the receiving antenna was three metres. Then the emissions were maximized by elevating the antenna in the range of 1 to 4 metres. The turntable was rotated to determine the azimuth of the peak emissions. Both the horizontal and vertical polarizations of the emissions were measured. The maximum emissions level was recorded. The BlackBerry® smartphone was then substituted with an antenna placed in the same location as the BlackBerry® smartphone. A Dipole antenna was used for the ERP measurements and a Horn antenna was used for EIRP measurements. The substitution antenna was connected into a signal generator that was set to the test frequency.

The emissions were maximized by elevating the antenna in the range of 1 to 4 metres. The signal generator output was then adjusted to match the BlackBerry® smartphone output reading. The signal generator output was recorded. Both the horizontal and vertical polarizations of the emissions were measured.

The following measurements were done in a semi-anechoic chamber (SAC) below 1 GHz and a Semi-anechoic Chamber ((SAC) with floor absorber) above 1 GHz. The SAC's FCC registration number is **778487** and the Industry Canada (IC) file number is **2503B-1**. The SAC with floor absorber's FCC registration number is **959115** and the IC file number is **2503C-1**. The BlackBerry® smartphone was measured on the low, middle and high channels.

The following test configurations were measured for model REC71UW:

The highest ERP in the 850 band Call mode measured was 31.16 dBm (1.31 W) at 824.20 MHz (channel 128).

The highest ERP in the 850 band EDGE mode measured was 29.32 dBm (0.86 W) at 824.20 MHz (channel 128).

The highest EIRP in the PCS band Call mode measured was 32.53 dBm (1.79 W) at 1880.00 MHz (channel 661).

The highest EIRP in the PCS band EDGE mode measured was 28.62 dBm (0.73 W) at 1880.00 MHz (channel 661).

	EMI Test Report for the BlackBerry® smartphone Model REC71UW, RED71UW	
<b>Test Report No.</b> RTS-5385-1108-52A_rev1	<b>Dates of Test</b> July 26 to September 19 and November 11, 2011	FCC ID: L6AREC70UW IC ID: 2503A-REC70UW FCC ID: L6ARED70UW IC ID: 2503A-RED70UW

The radiated spurious emission and carrier harmonics were measured up to the 10<sup>th</sup> harmonic for low, middle, and high channels in the GSM850 and PCS 1900 bands. Each band was measured in GSM and EDGE mode, with both the horizontal and vertical polarizations.

The margins in the GSM 850 and PCS 1900 for harmonic emissions were greater than 25 dB below the accepted limits for all test frequencies.

The highest ERP in the UMTS band 5, Call Service mode was 25.39 dBm (0.35 W) at 826.40 MHz (channel 4132).

The highest ERP in the UMTS band 5, HSUPA mode was 27.42 dBm (0.55 W) at 826.40 MHz (channel 4132).

The highest EIRP in the UMTS band 2, Call Service mode measured was 21.04 dBm (0.13 W) at 1907.60 MHz (channel 9538).

The highest EIRP in the UMTS band 2, HSUPA mode measured was 22.16 dBm (0.16 W) at 1907.60 MHz (channel 9538).

The radiated carrier harmonics were measured up to the 10<sup>th</sup> harmonic for low, middle and high channels in the UMTS band 5 and UMTS band 2. Each band was measured in Call, and HSUPA modes. Both the horizontal and vertical polarizations were measured.

The margins in the UMTS band 5 for harmonic emissions were greater than 25 dB below the accepted limits for all test frequencies.

The margins in the UMTS band 2 for harmonic emissions were 12.67 dBm below the limits at 3813.47 MHz in Call Mode.

The margins in the UMTS band 2 for harmonic emissions were 12.79 dBm below the limits at 3817.01 MHz in HSUPA Mode.

The following test configurations were measured for model RED71UW:

The highest ERP in the 850 band call mode measured was 29.28 dBm (0.85 W) at 836.60 MHz (channel 190).

The highest ERP in the 850 band EDGE mode measured was 27.61 dBm (0.58 W) at 824.20 MHz (channel 128).

	EMI Test Report for the BlackBerry® smartphone Model REC71UW, RED71UW	
<b>Test Report No.</b> RTS-5385-1108-52A_rev1	<b>Dates of Test</b> July 26 to September 19 and November 11, 2011	FCC ID: L6AREC70UW IC ID: 2503A-REC70UW FCC ID: L6ARED70UW IC ID: 2503A-RED70UW

The highest EIRP in the PCS band call mode measured was 30.38 dBm (1.09 W) at 1909.80 MHz (channel 810).

The highest EIRP in the PCS band EDGE mode measured was 28.37 dBm (0.69 W) at 1909.80 MHz (channel 810).

The highest ERP in the UMTS band 4, Call Service mode was 26.44 dBm (0.44 W) at 1732.60 MHz (channel 1413).

The highest ERP in the UMTS band 4, HSUPA mode was 27.52 dBm (0.56 W) at 1732.60 MHz (channel 1413).

The radiated carrier harmonics were measured up to the 10<sup>th</sup> harmonic for low, middle and high channels in the UMTS band 4 and was measured in Call, and HSUPA modes. Both the horizontal and vertical polarizations were measured.

The margins in the UMTS band 4 for harmonic emissions were greater than 25 dB below the accepted limits for all test frequencies.

The UMTS band 4 transmit power control in the EUT is limited by calibration of an RF Power detector. For more details, please refer to Parts List\_Tune Up Exhibit.

### **b) Co-Location Measurements**

The radiated emissions were measured up to 18 GHz for middle channels for simultaneous transmission in the following test configuration combinations: UMTS band 5/Bluetooth/802.11b, UMTS band 2/Bluetooth/802.11b, GSM 850/Bluetooth/802.11b and PCS 1900/Bluetooth/802.11b.

Both the horizontal and vertical polarizations were measured. The emissions due to different simultaneous transmission did not increase the amplitude of any emissions nor did it produce any new inter-modulation products as a result of mixing.



	EMI Test Report for the BlackBerry® smartphone Model REC71UW, RED71UW	
<b>Test Report No.</b> RTS-5385-1108-52A_rev1	<b>Dates of Test</b> July 26 to September 19 and November 11, 2011	FCC ID: L6AREC70UW IC ID: 2503A-REC70UW FCC ID: L6ARED70UW IC ID: 2503A-RED70UW

**Sample Calculation:**

Corrected Signal level (CSL) is calculated as follows:

$$\text{CSL (dBm)} = \text{Measured Level (dB}\mu\text{V)} - \text{Antenna Gain (dBi)} + \text{Free Space loss (dB)} - 107(\text{dB}) + \text{Cable Loss (dB)} - \text{Preamp (dB)} + \text{Filter Loss (dB)} - 2.15(\text{dB})$$

To view the test data see APPENDIX 4A, 4B and 4C.

**Measurement Uncertainty ±4.6 dB**



EMI Test Report for the BlackBerry® smartphone Model REC71UW, RED71UW

Test Report No.  
RTS-5385-1108-52A\_rev1Dates of Test  
July 26 to September 19 and  
November 11, 2011FCC ID: L6AREC70UW IC ID: 2503A-REC70UW  
FCC ID: L6ARED70UW IC ID: 2503A-RED70UW

## H) Compliance Test Equipment Used

<u>UNIT</u>	<u>MANUFACTURER</u>	<u>MODEL</u>	<u>SERIAL NUMBER</u>	<u>CAL DUE DATE</u> (YY MM DD)	<u>USE</u>
Preamplifier	Sonoma	310N/11909A	185831	11-11-24	Radiated Emissions
Preamplifier system	TDK RF Solutions	PA-02	080010	11-11-24	Radiated Emissions
Preamplifier	Rohde & Schwarz	TS-ANA4-SP	001	11-12-01	Radiated Emissions
Preamplifier	Rohde & Schwarz	TS-ANA-SP	001	11-12-01	Radiated Emissions
Hybrid Log Antenna	EMC Automation	HLP-3003C	017401	12-01-04	Radiated Emissions
Horn Antenna	EMC Automation	HRN-0118	030101	12-07-20	Radiated Emissions
Horn Antenna	EMC Automation	HRN-0118	030201	12-09-22	Radiated Emissions
Horn Antenna	Emco	3117	47563	13-08-04	Radiated Emissions
Horn Antenna	CMT	LHA 0180	R52734-001	12-01-21	Radiated Emissions
Dipole Antenna	Schwarzbeck	UHAP	973	12-02-21	Radiated Emissions
Dipole Antenna	Schwarzbeck	UHAP	974	12-11-08	Radiated Emissions
Universal Radio Communication Tester	Rohde & Schwarz	CMU 200	837493/073	11-10-01	Radiated Emissions
Universal Radio Communication Tester	Rohde & Schwarz	CMU 200	112394	11-10-01	Radiated Emissions
Universal Radio Communication Tester	Rohde & Schwarz	CMU 200	102204	11-11-30	RF Conducted Emissions
EMI Receiver	Rohde & Schwarz	ESIB-40	100255	11-11-28	Radiated Emissions
EMI Receiver	Rohde & Schwarz	ESU-40	100162	11-11-30	Radiated Emissions
Spectrum Analyzer	HP	8563E	3745A08112	11-09-30	RF Conducted Emissions
DC Power Supply	HP	6632B	US37472178	11-11-19	RF Conducted Emissions
Environment Monitor	Omega	iTHX-SD	0380561	11-10-13	Radiated Emissions



EMI Test Report for the BlackBerry® smartphone Model REC71UW, RED71UW

**Test Report No.**  
RTS-5385-1108-52A\_rev1

**Dates of Test**  
July 26 to September 19 and  
November 11, 2011

FCC ID: L6AREC70UW IC ID: 2503A-REC70UW  
FCC ID: L6ARED70UW IC ID: 2503A-RED70UW

### Compliance Test Equipment Used cont'd

<u>UNIT</u>	<u>MANUFACTURER</u>	<u>MODEL</u>	<u>SERIAL NUMBER</u>	<u>CAL DUE DATE</u> (YY MM DD)	<u>USE</u>
Environment Monitor	Omega	iTHX-SD	0340060	11-10-13	RF Conducted Emissions
Environment Monitor	Omega	iTHX-SD	0380567	11-10-13	Radiated Emissions
Signal Generator	Agilent	E8257D	MY45140527	11-11-05	Radiated Emissions
Signal Generator	Agilent	83630B	3844A00927	12-10-28	Radiated Emissions

## APPENDIX 1A – GSM CONDUCTED RF EMISSIONS TEST DATA/PLOTS

	EMI Test Report for the BlackBerry® smartphone Model REC71UW, RED71UW <b>APPENDIX 1A</b>	
	<b>Test Report No.</b> RTS-5385-1108-52A_rev1	<b>Dates of Test</b> July 26 to September 19 and November 11, 2011

**GSM Conducted RF Emission Test Data**

The following test configurations were measured for model REC71UW:

This appendix contains measurement data pertaining to conducted spurious emissions, -26 dBc bandwidth, 99% power bandwidth and the channel mask on BlackBerry® smartphone.

**Test Setup Diagram**

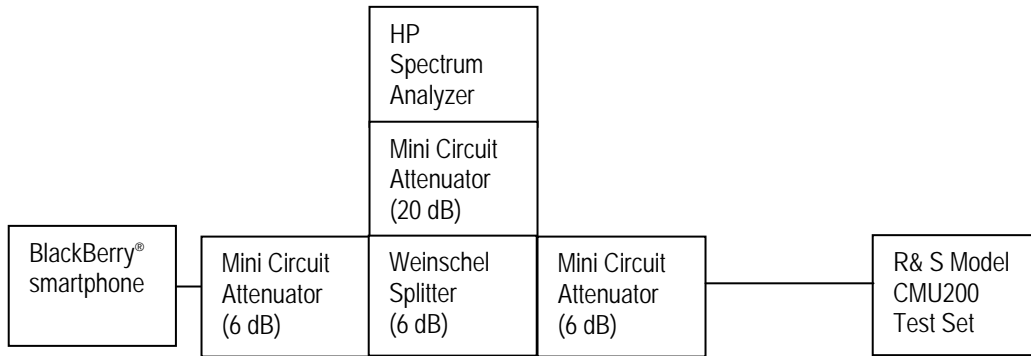

Date of Test: August 2, 2011

The environmental test conditions were:

Temperature: 24.0 °C  
Relative Humidity: 43.0 %

The following measurements were performed by Kevin Guo.

	EMI Test Report for the BlackBerry® smartphone Model REC71UW, RED71UW <b>APPENDIX 1A</b>	
	<b>Test Report No.</b> RTS-5385-1108-52A_rev1	<b>Dates of Test</b> July 26 to September 19 and November 11, 2011

GSM Conducted RF Emission Test Data cont'd

**The conducted spurious emissions** – As per 47 CFR 2.1051, CFR 24.238(a), RSS-GEN, 4.9, CFR 22 Subpart H and RSS-132 were measured from 10 MHz to 20 GHz. The EUT emissions were in the noise floor.  
See figures 1-1a to 1-12a for the plots of the conducted spurious emissions.

**–26 dBc Bandwidth and Occupied Bandwidth (99%)**

For each carrier frequency of low, middle and high, the modulation spectrum was measured by both methods of 99% power bandwidth and –26 dBc bandwidth.

The resolution bandwidth required for out-of-band emissions in the 1 MHz bands immediately outside and adjacent to the frequency block, was determined to be at least 1% of the emission bandwidth.

The worst case –26dBc bandwidth for the GSM850 band was measured to be 280 kHz, and for the PCS1900 band was measured to be 285 kHz as shown below. This results in a 3.0 kHz resolution bandwidth.

On any frequency outside the frequency block and outside the adjacent 1 MHz bands, a resolution bandwidth of at least 1 MHz was applied.

*Test Data for 850 band and 1900 band selected Frequencies in GSM mode.*

850 band Frequency (MHz)	-26dBc Bandwidth (kHz)	99% Occupied Bandwidth (kHz)
824.2	280	243.0
837.6	275	247.0
848.8	267	245.0

1900 band Frequency (MHz)	-26dBc Bandwidth (kHz)	99% Occupied Bandwidth (kHz)
1850.2	285	245.0
1880.0	278	245.0
1909.8	267	243.0

**Measurement Plots for 850 and 1900 in GSM mode**

Refer to the following measurement plots for more detail.

See Figures 1-13a to 1-24a for the plots of 26dBc/99% Occupied Bandwidth.

The RF power output was at maximum for all the recorded measurements shown below.

	EMI Test Report for the BlackBerry® smartphone Model REC71UW, RED71UW <b>APPENDIX 1A</b>	
	<b>Test Report No.</b> RTS-5385-1108-52A_rev1	<b>Dates of Test</b> July 26 to September 19 and November 11, 2011

GSM Conducted RF Emission Test Data cont'd

Date of Test: August 2, 2011

Test Data for 850 and 1900 bands selected Frequencies in EDGE mode.

850 band Frequency (MHz)	99% Occupied Bandwidth (kHz)
824.2	242.0
837.6	243.0
848.8	242.0

1900 band Frequency (MHz)	99% Occupied Bandwidth (kHz)
1850.2	245.0
1880.0	245.0
1909.8	247.0

***Measurement Plots for 850 and 1900 bands in EDGE mode***

Refer to the following measurement plots for more detail.

See Figures 1-1a to 1-12a for the plots of the conducted spurious emissions.

See Figures 1-13a to 1-24a for the plots of 26dBc/99% Occupied Bandwidth.

See Figures 1-25a to 1-28a for the plots of the Channel mask.

See Figures 1-29a to 1-34a for the plots of the 99% Occupied Bandwidth EDGE results.

See Figures 1-35a to 1-38a for the plots of channel mask EDGE results.

See Figures 1-39a to 1-50a for the plots of the conducted spurious emissions EDGE results

The RF power output was at maximum for all the recorded measurements shown below.

	EMI Test Report for the BlackBerry® smartphone Model REC71UW, RED71UW <b>APPENDIX 1A</b>	
	<b>Test Report No.</b> RTS-5385-1108-52A_rev1	<b>Dates of Test</b> July 26 to September 19 and November 11, 2011

GSM Conducted RF Emission Test Data cont'd

**Figure 1-1a: GSM850 band, Spurious Conducted Emissions, Low channel**

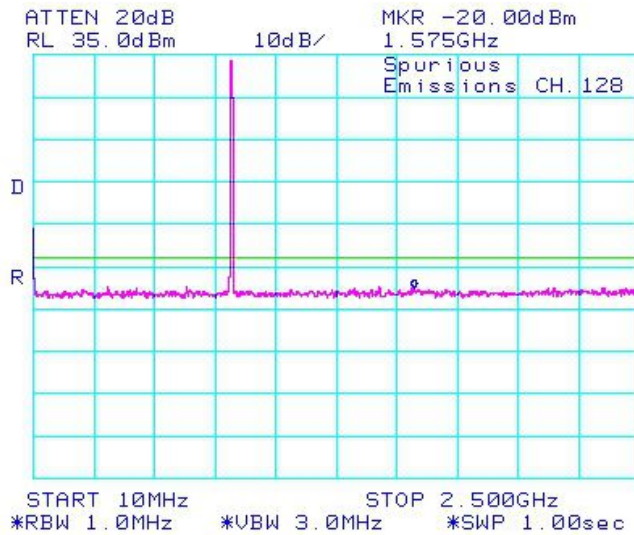

**Figure 1-2a: GSM850 band, Spurious Conducted Emissions, Low channel**

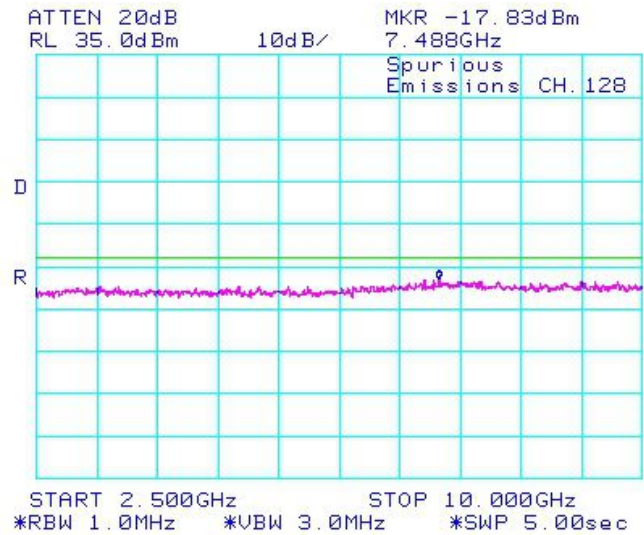

**Figure 1-3a: GSM850 band, Spurious Conducted Emissions, Middle Channel**

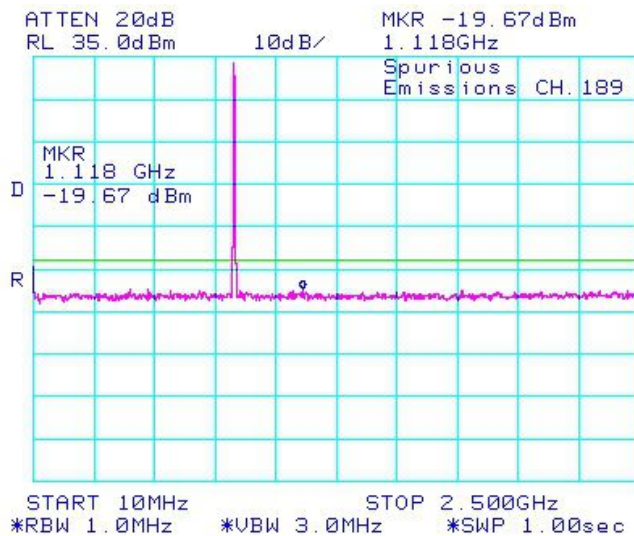

**Figure 1-4a: GSM850 band, Spurious Conducted Emissions, Middle Channel**

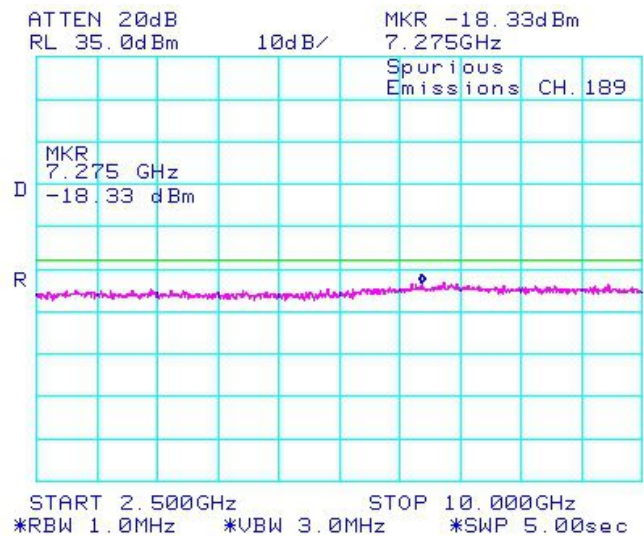



	EMI Test Report for the BlackBerry® smartphone Model REC71UW, RED71UW <b>APPENDIX 1A</b>	
	<b>Test Report No.</b> RTS-5385-1108-52A_rev1	<b>Dates of Test</b> July 26 to September 19 and November 11, 2011

GSM Conducted RF Emission Test Data cont'd

**Figure 1-5a: GSM850 band, Spurious Conducted Emissions, High Channel**

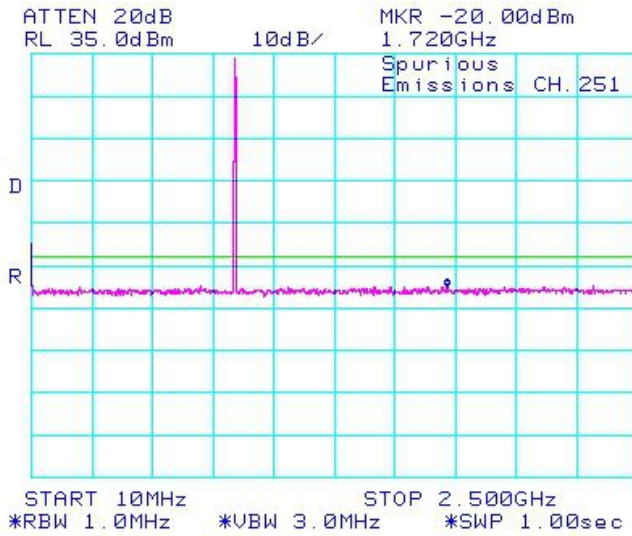

**Figure 1-6a: GSM850 band, Spurious Conducted Emissions, High Channel**

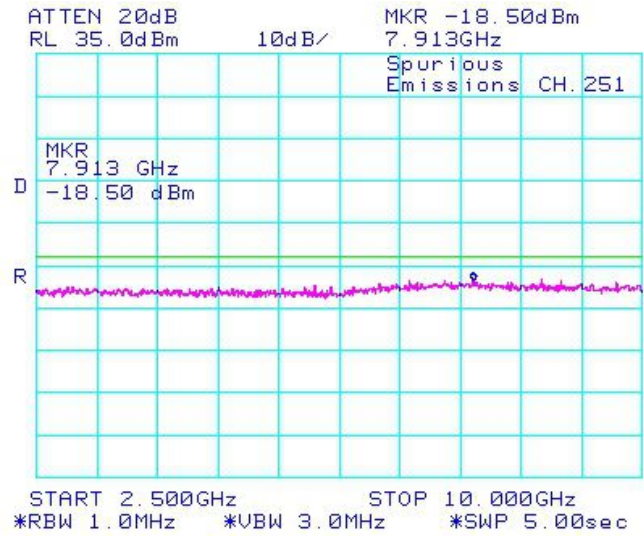

**Figure 1-7a: PCS1900 band, Spurious Conducted Emissions, Low Channel**

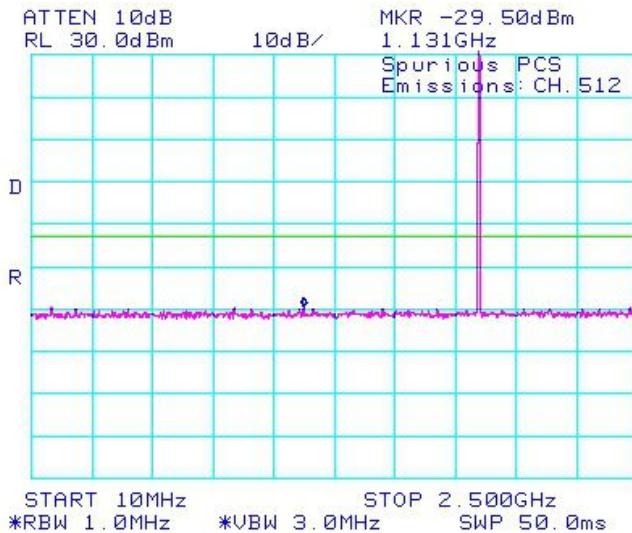

**Figure 1-8a: PCS1900 band, Spurious Conducted Emissions, Low Channel**

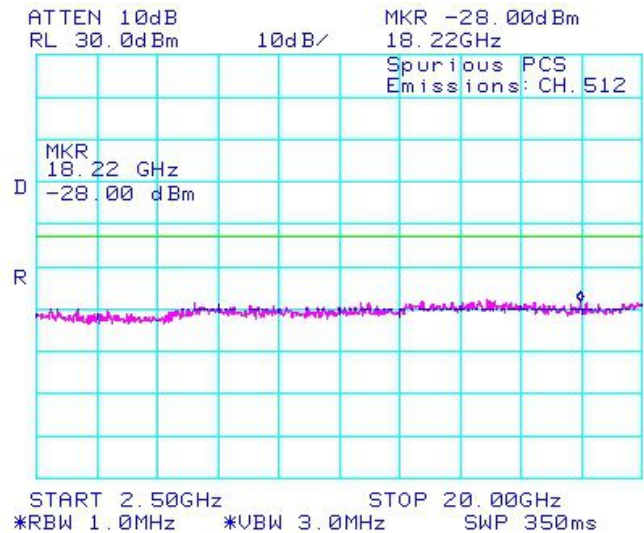

	EMI Test Report for the BlackBerry® smartphone Model REC71UW, RED71UW <b>APPENDIX 1A</b>	
	<b>Test Report No.</b> RTS-5385-1108-52A_rev1	<b>Dates of Test</b> July 26 to September 19 and November 11, 2011

GSM Conducted RF Emission Test Data cont'd

**Figure 1-9a: PCS1900 band, Spurious Conducted Emissions, Middle Channel**

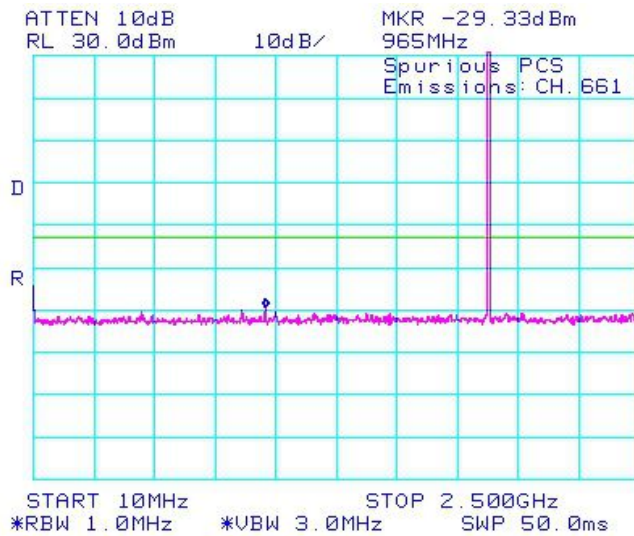

**Figure 1-10a: PCS1900 band, Spurious Conducted Emissions, Middle Channel**

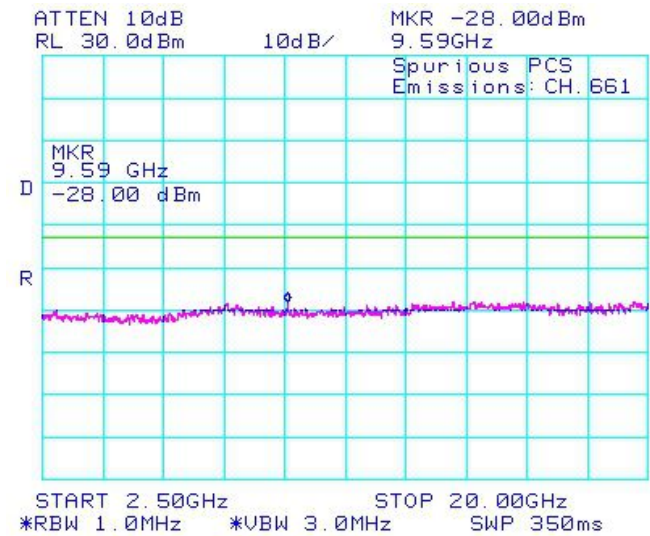

**Figure 1-11a: PCS1900 band, Spurious Conducted Emissions, High Channel**

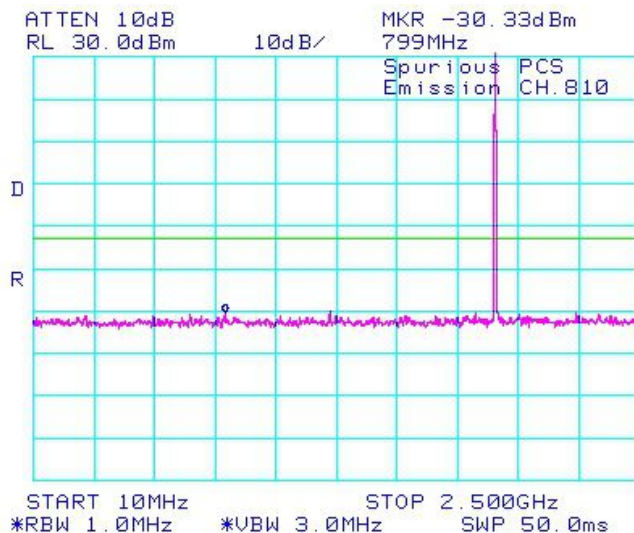

**Figure 1-12a: PCS1900 band, Spurious Conducted Emissions, High Channel**

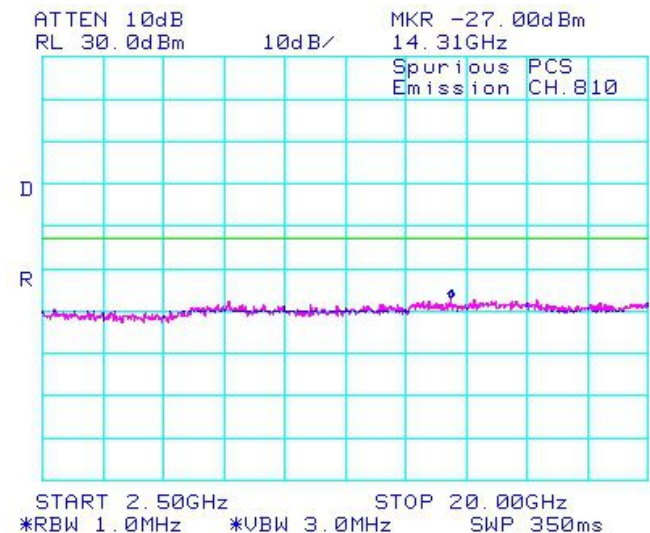

	EMI Test Report for the BlackBerry® smartphone Model REC71UW, RED71UW <b>APPENDIX 1A</b>	
	<b>Test Report No.</b> RTS-5385-1108-52A_rev1	<b>Dates of Test</b> July 26 to September 19 and November 11, 2011

GSM Conducted RF Emission Test Data cont'd

**Figure 1-13a: -26dBc bandwidth, GSM850 band Low Channel in GSM mode**

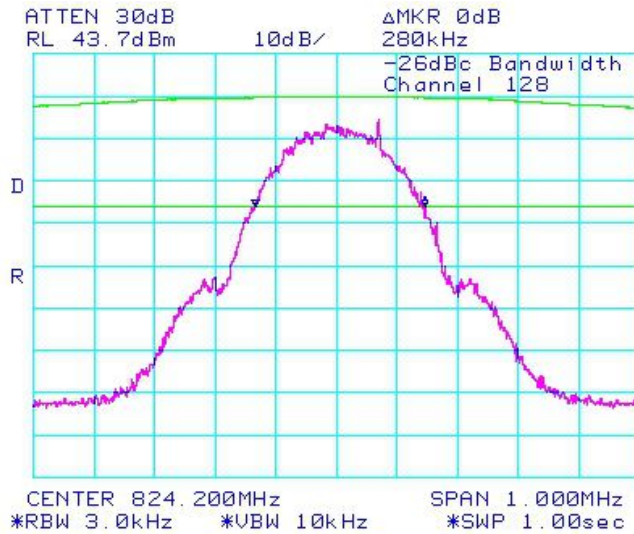

**Figure 1-14a: Occupied Bandwidth, GSM850 band Low Channel in GSM mode**

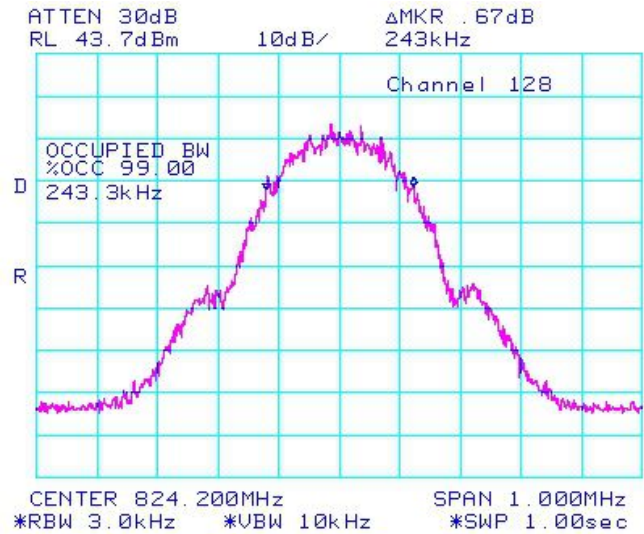

**Figure 1-15a: -26dBc bandwidth, GSM850 band Middle Channel in GSM mode**

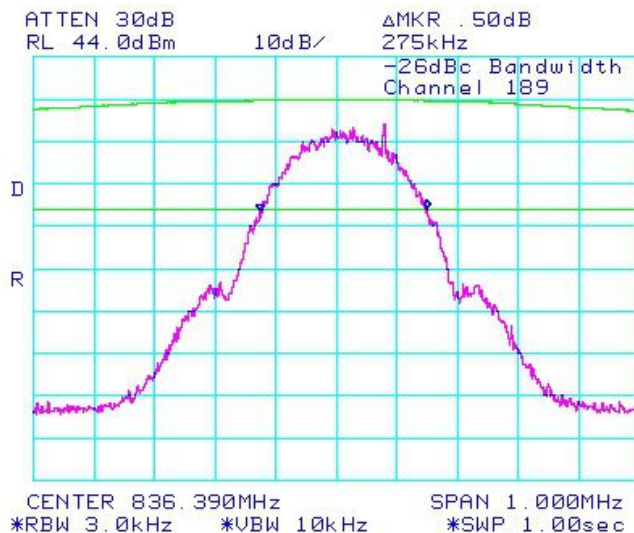

**Figure 1-16a: Occupied Bandwidth, GSM850 band Middle Channel in GSM mode**

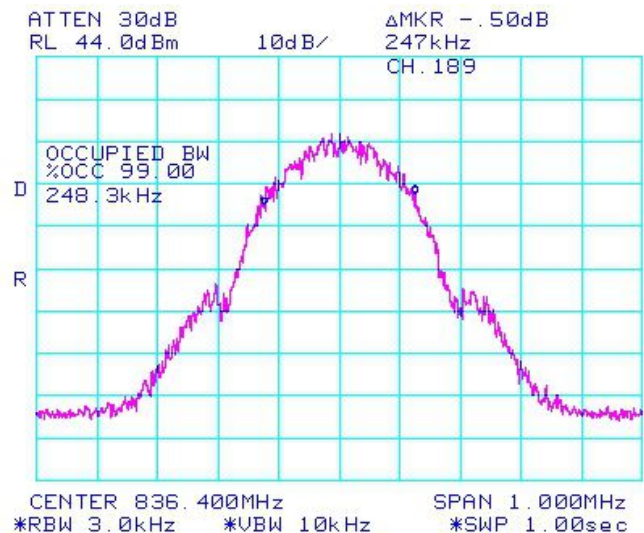

	EMI Test Report for the BlackBerry® smartphone Model REC71UW, RED71UW <b>APPENDIX 1A</b>	
<b>Test Report No.</b> RTS-5385-1108-52A_rev1	<b>Dates of Test</b> July 26 to September 19 and November 11, 2011	FCC ID: L6AREC70UW IC ID: 2503A-REC70UW FCC ID: L6ARED70UW IC ID: 2503A-RED70UW

GSM Conducted RF Emission Test Data cont'd

**Figure 1-17a: -26dBc bandwidth, GSM850 band High Channel in GSM mode**

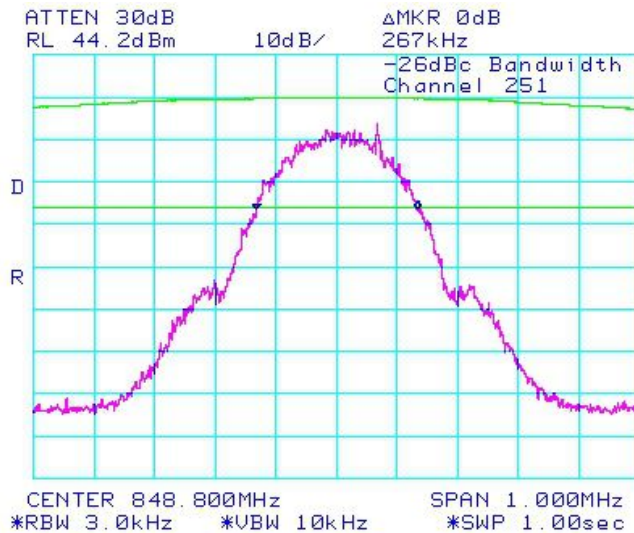

**Figure 1-18a: Occupied Bandwidth, GSM850 band High Channel in GSM mode**

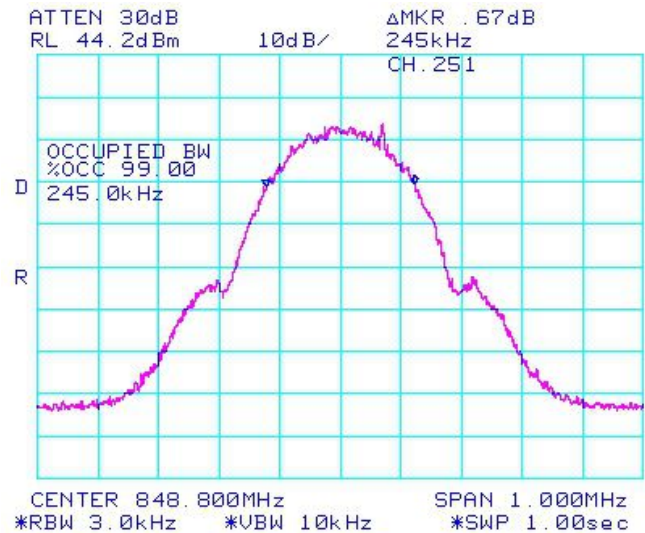

**Figure 1-19a: -26dBc bandwidth, PCS1900 Low Channel in GSM mode**

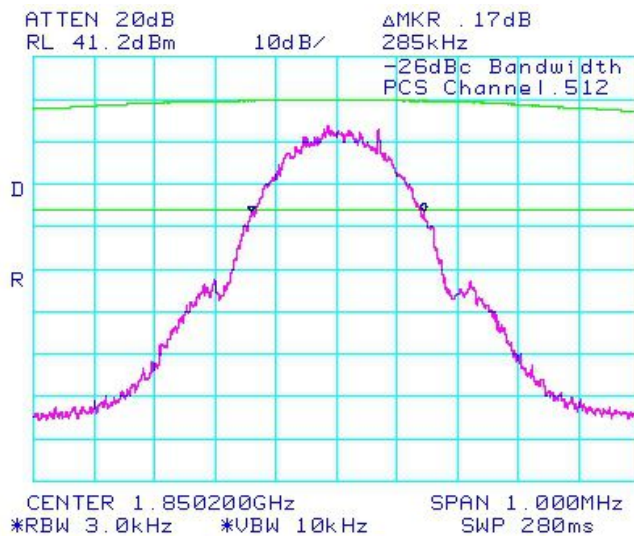

**Figure 1-20a: Occupied Bandwidth, PCS1900 Low Channel in GSM mode**

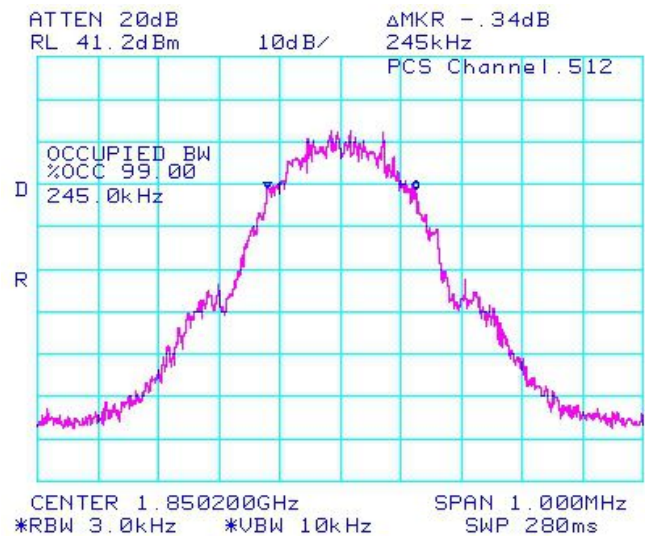

<b>Test Report No.</b> RTS-5385-1108-52A_rev1	<b>Dates of Test</b> July 26 to September 19 and November 11, 2011	FCC ID: L6AREC70UW IC ID: 2503A-REC70UW FCC ID: L6ARED70UW IC ID: 2503A-RED70UW
--	--	--

GSM Conducted RF Emission Test Data cont'd

**Figure 1-21a: -26dBc bandwidth, PCS1900 Middle Channel in GSM mode**

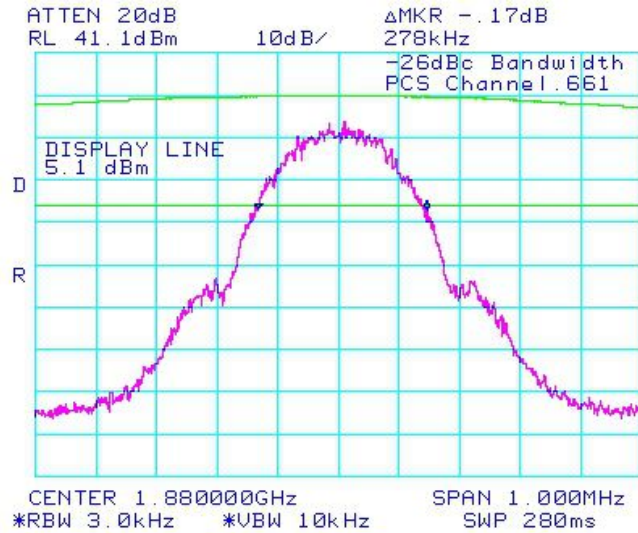

**Figure 1-22a: Occupied Bandwidth, PCS1900 Middle Channel in GSM mode**

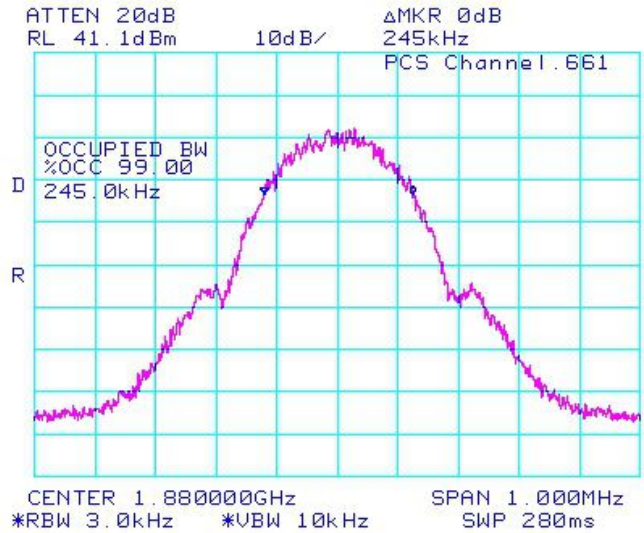

**Figure 1-23a: -26dBc bandwidth, PCS1900 High Channel in GSM mode**

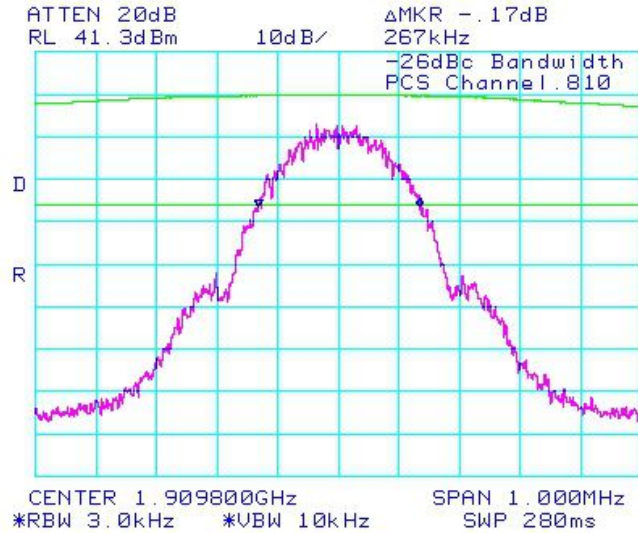

**Figure 1-24a: Occupied Bandwidth, PCS1900 High Channel in GSM mode**

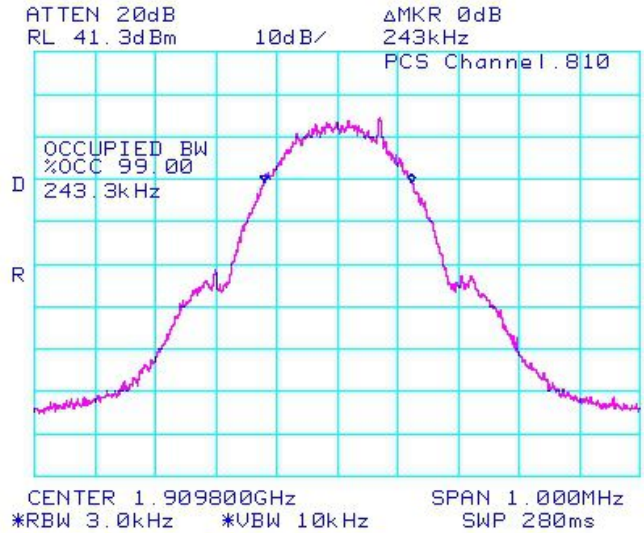

	EMI Test Report for the BlackBerry® smartphone Model REC71UW, RED71UW <b>APPENDIX 1A</b>	
<b>Test Report No.</b> RTS-5385-1108-52A_rev1	<b>Dates of Test</b> July 26 to September 19 and November 11, 2011	FCC ID: L6AREC70UW IC ID: 2503A-REC70UW FCC ID: L6ARED70UW IC ID: 2503A-RED70UW

GSM Conducted RF Emission Test Data cont'd

**Figure 1-25a: GSM850 band, Low Channel Mask in GSM mode**

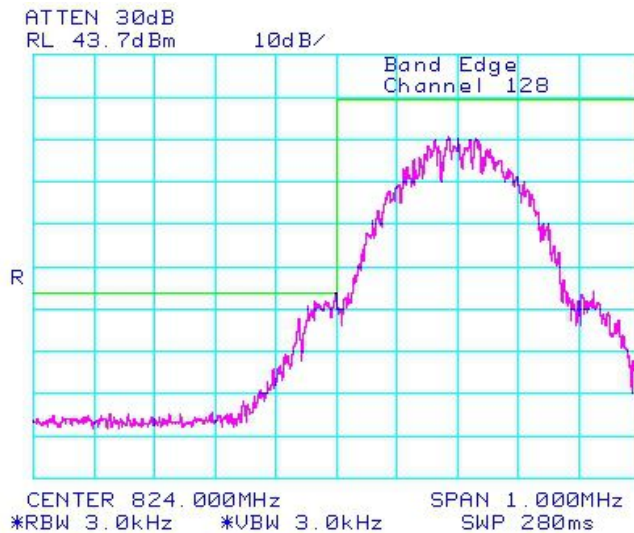

**Figure 1-26a: GSM850 band High Channel Mask in GSM mode**

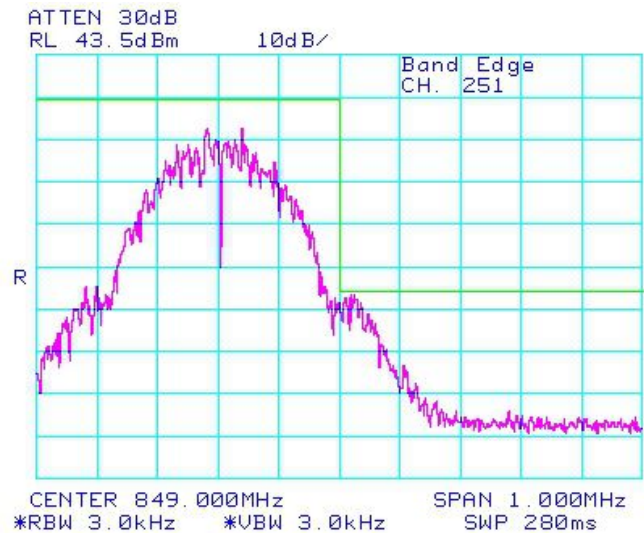

**Figure 1-27a: PCS1900, Low Channel Mask in GSM mode**

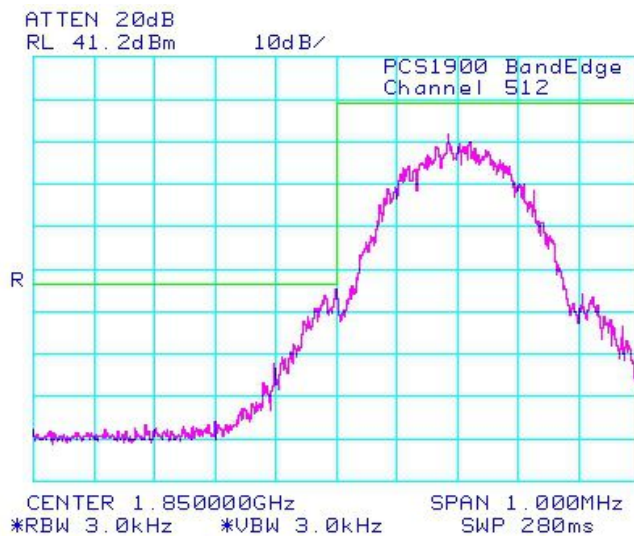

**Figure 1-28a: PCS1900, High Channel Mask in GSM mode**

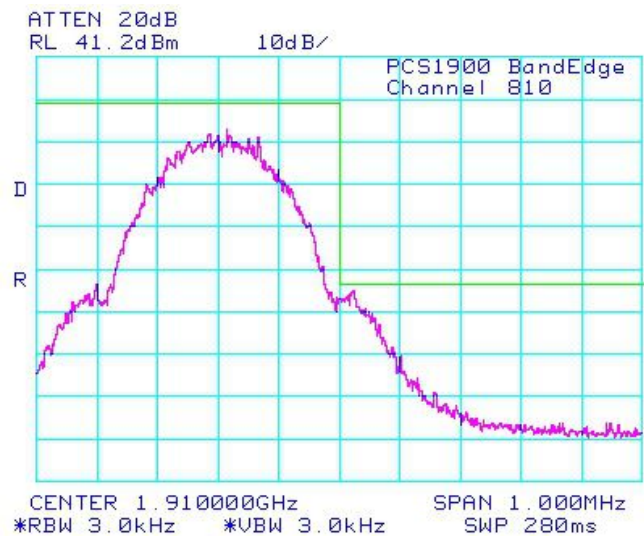

	EMI Test Report for the BlackBerry® smartphone Model REC71UW, RED71UW <b>APPENDIX 1A</b>	
	<b>Test Report No.</b> RTS-5385-1108-52A_rev1	<b>Dates of Test</b> July 26 to September 19 and November 11, 2011

GSM Conducted RF Emission Test Data cont'd

**Figure 1-29a: Occupied Bandwidth, GSM850 Band, Low Channel in EDGE mode**

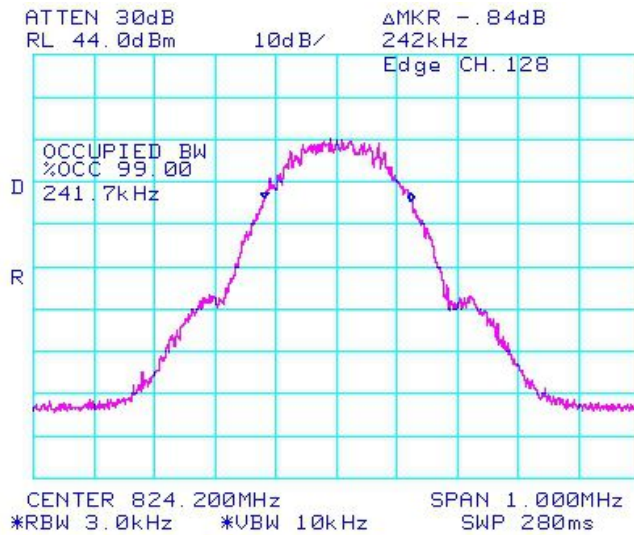

**Figure 1-30a: Occupied Bandwidth, GSM850 Band, Middle Channel in EDGE mode**

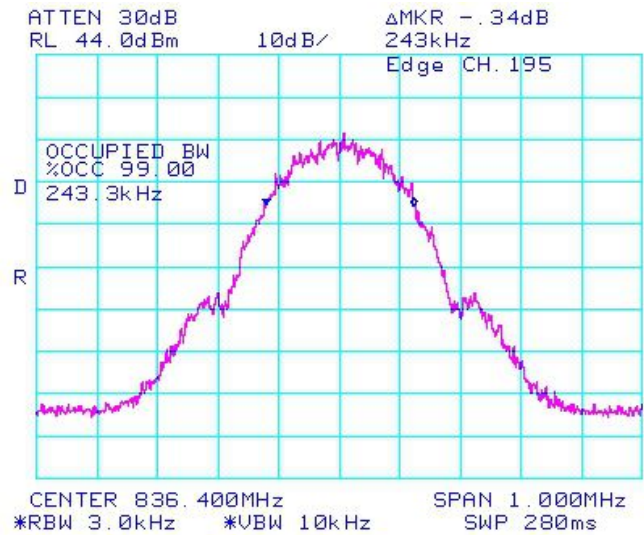

**Figure 1-31a: Occupied Bandwidth, GSM850 band, High Channel in EDGE mode**

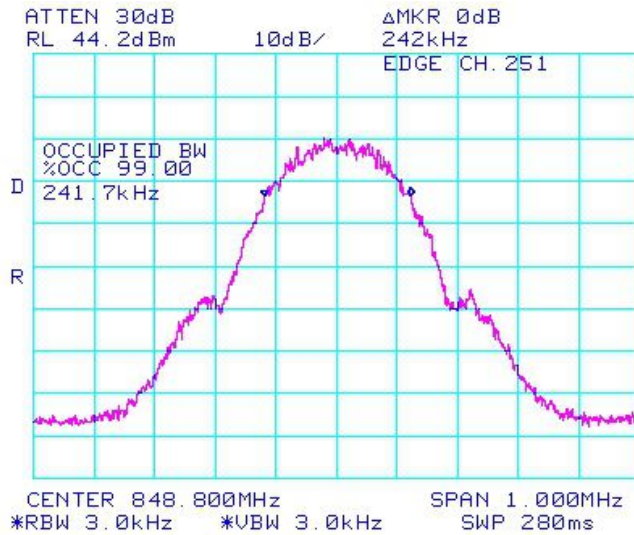

**Figure 1-32a: Occupied Bandwidth, PCS1900 Band, Low Channel in EDGE mode**

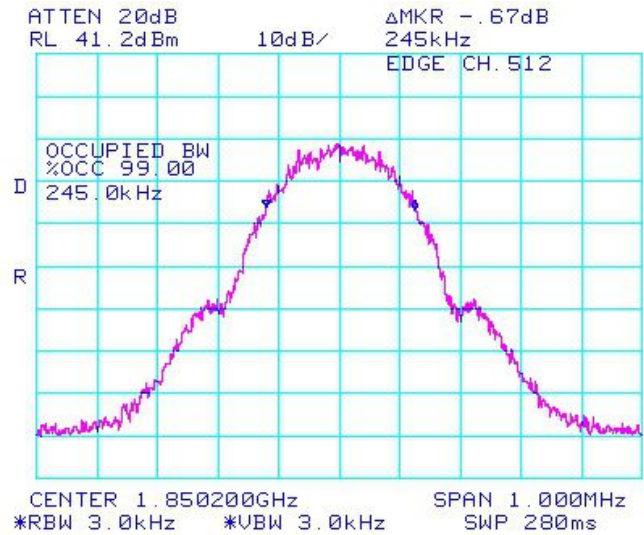

<b>Test Report No.</b> RTS-5385-1108-52A_rev1	<b>Dates of Test</b> July 26 to September 19 and November 11, 2011	FCC ID: L6AREC70UW IC ID: 2503A-REC70UW FCC ID: L6ARED70UW IC ID: 2503A-RED70UW
--	--	--

GSM Conducted RF Emission Test Data cont'd

**Figure 1-33a: Occupied Bandwidth, PCS1900 Band, Middle Channel in EDGE mode**

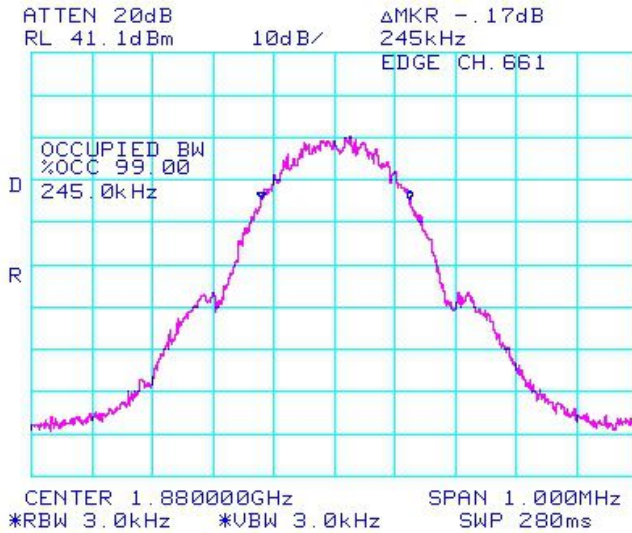

**Figure 1-34a: Occupied Bandwidth, PCS1900 Band, High Channel in EDGE mode**

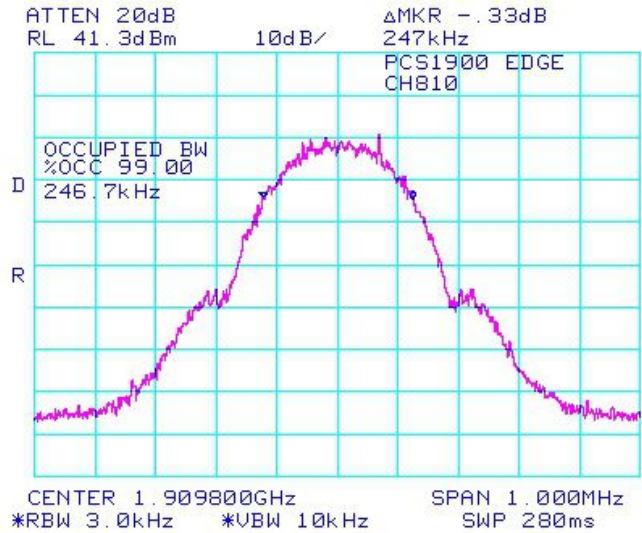

**Figure 1-35a: GSM850 Band, Low Channel Mask in EDGE mode**

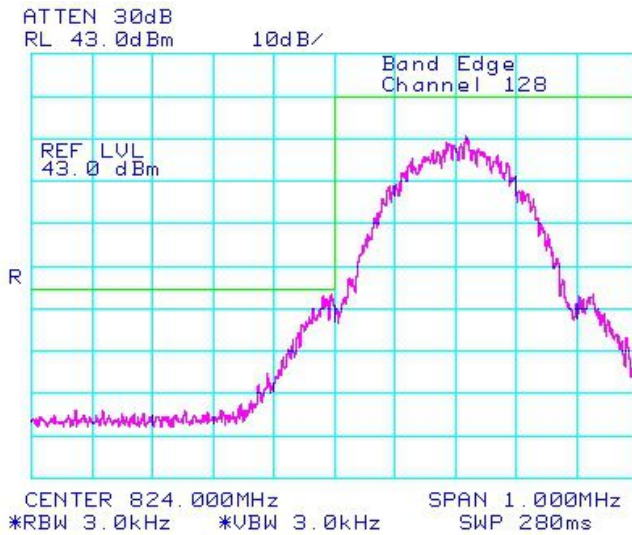

**Figure 1-36a: GSM850 Band, High Channel Mask in EDGE mode**

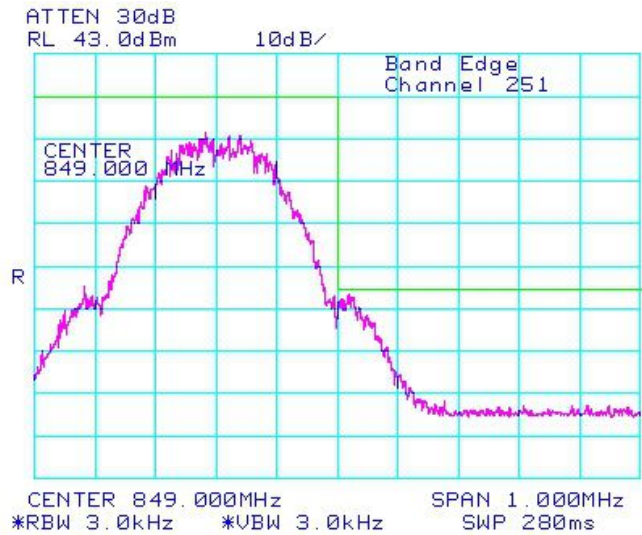



	EMI Test Report for the BlackBerry® smartphone Model REC71UW, RED71UW <b>APPENDIX 1A</b>	
<b>Test Report No.</b> RTS-5385-1108-52A_rev1	<b>Dates of Test</b> July 26 to September 19 and November 11, 2011	FCC ID: L6AREC70UW IC ID: 2503A-REC70UW FCC ID: L6ARED70UW IC ID: 2503A-RED70UW

GSM Conducted RF Emission Test Data cont'd

**Figure 1-37a: PCS1900 Band, Low Channel Mask in EDGE mode**

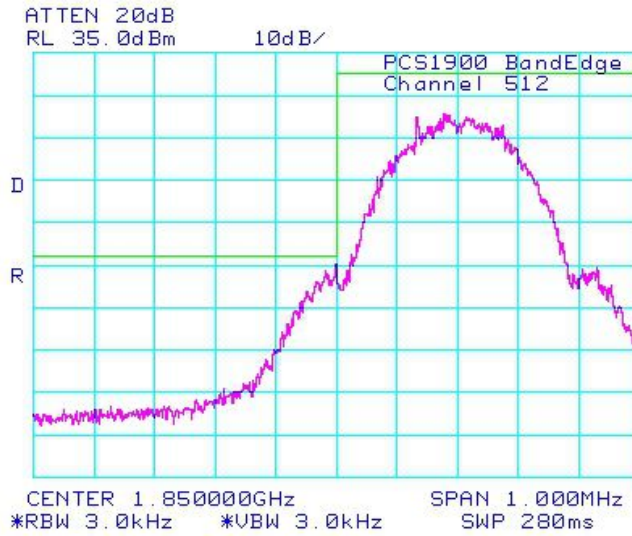

**Figure 1-38a: PCS1900 Band, High Channel Mask in EDGE mode**

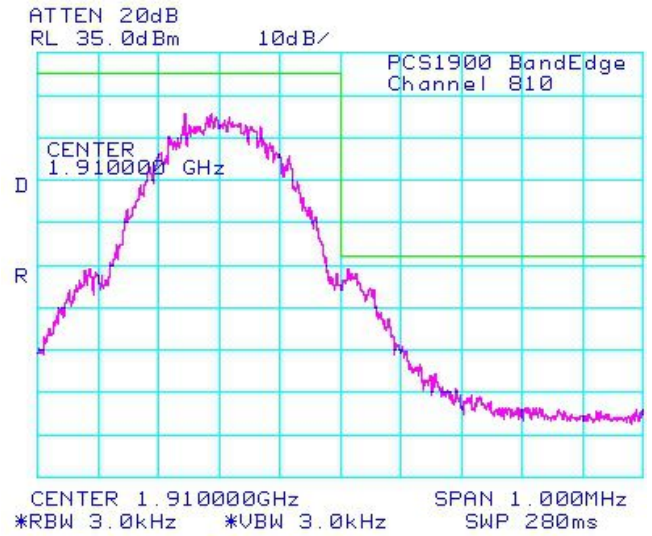

<b>Test Report No.</b> RTS-5385-1108-52A_rev1	<b>Dates of Test</b> July 26 to September 19 and November 11, 2011	FCC ID: L6AREC70UW IC ID: 2503A-REC70UW FCC ID: L6ARED70UW IC ID: 2503A-RED70UW
--	--	--

GSM Conducted RF Emission Test Data cont'd

**Figure 1-39a: GSM850 band, Spurious Conducted Emissions, Low channel in Edge Mode**

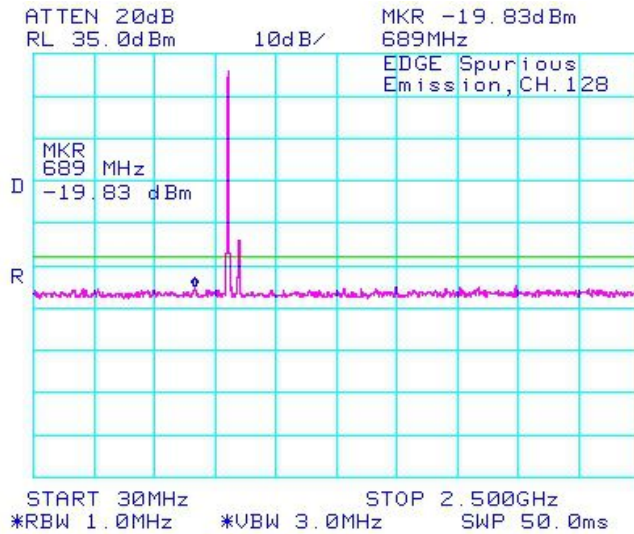

**Figure 1-40a: GSM850 band, Spurious Conducted Emissions, Low channel in Edge Mode**

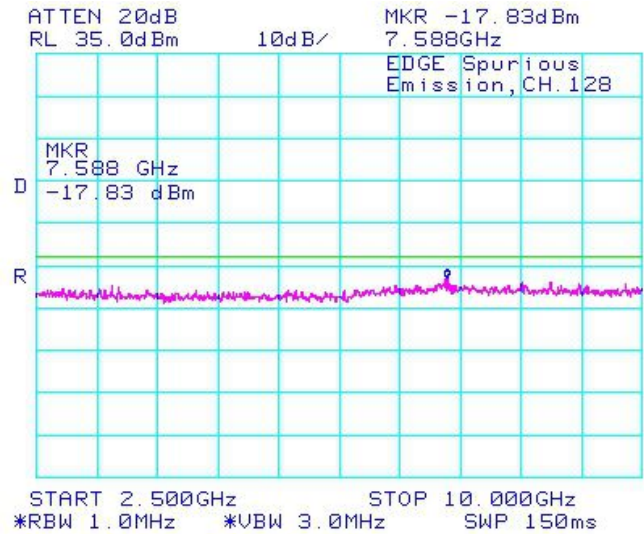

**Figure 1-41a: GSM850 band, Spurious Conducted Emissions, Middle channel in Edge Mode**

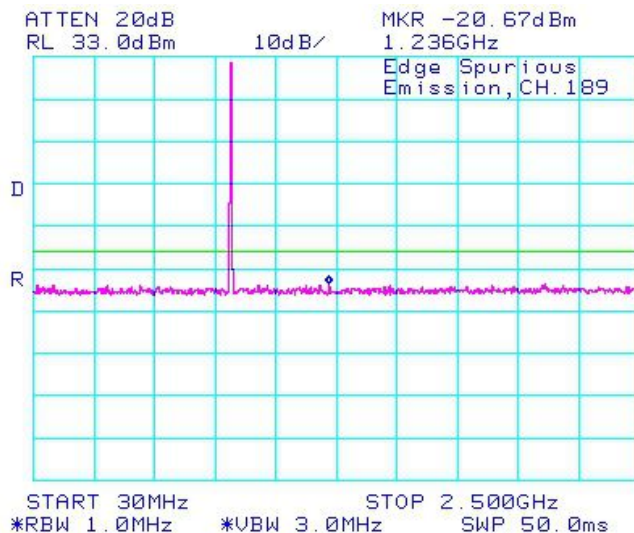

**Figure 1-42a: GSM850 band, Spurious Conducted Emissions, Middle channel in Edge Mode**

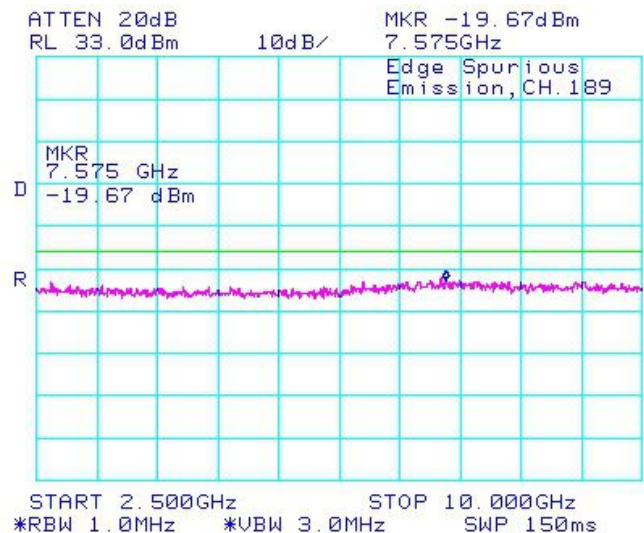

<b>Test Report No.</b> RTS-5385-1108-52A_rev1	<b>Dates of Test</b> July 26 to September 19 and November 11, 2011	FCC ID: L6AREC70UW IC ID: 2503A-REC70UW FCC ID: L6ARED70UW IC ID: 2503A-RED70UW
--	--	--

GSM Conducted RF Emission Test Data cont'd

**Figure 1-43a: GSM850 band, Spurious Conducted Emissions, High channel in Edge Mode**

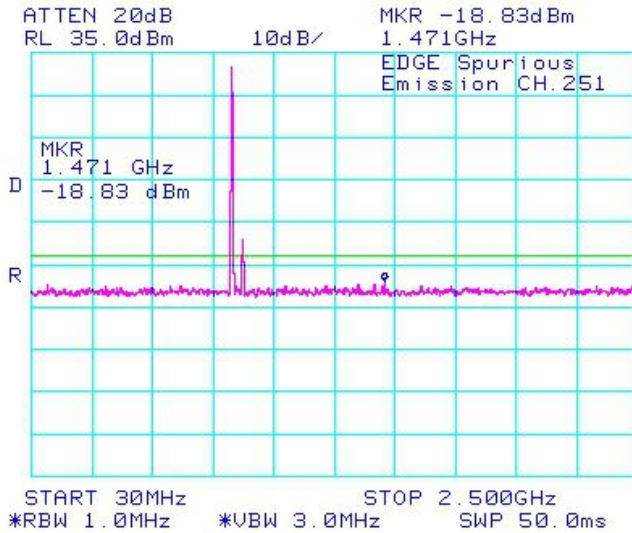

**Figure 1-44a: GSM850 band, Spurious Conducted Emissions, High channel in Edge Mode**

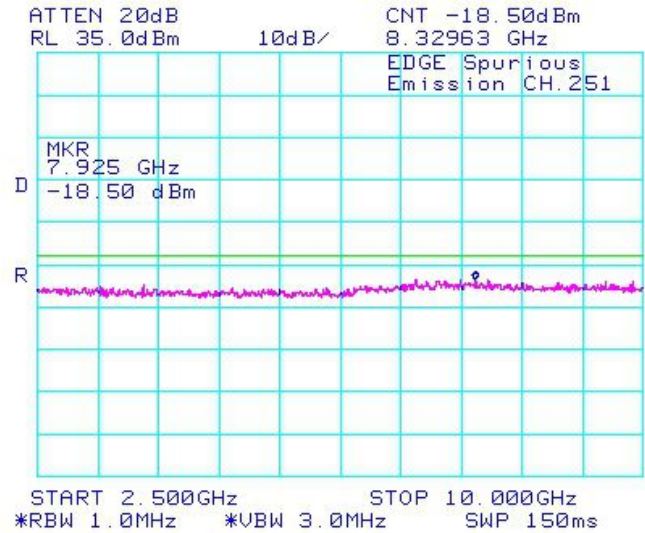

**Figure 1-45a: PCS1900 band, Spurious Conducted Emissions, Low channel in Edge Mode**

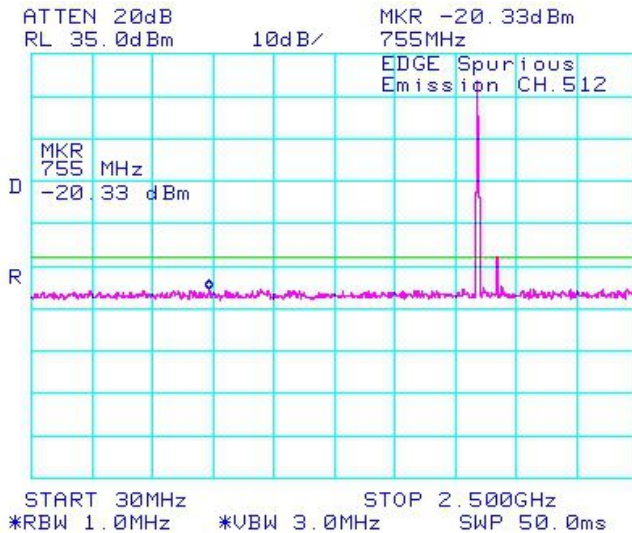

**Figure 1-46a: PCS1900 band, Spurious Conducted Emissions, Low channel in Edge Mode**

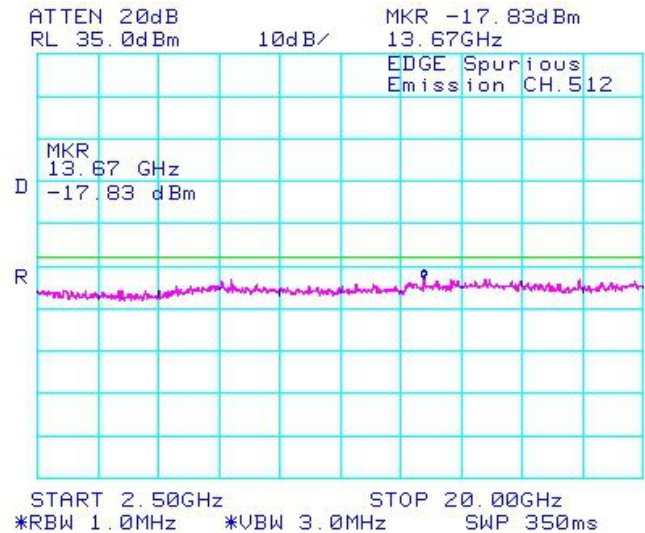

	EMI Test Report for the BlackBerry® smartphone Model REC71UW, RED71UW <b>APPENDIX 1A</b>	
	<b>Test Report No.</b> RTS-5385-1108-52A_rev1	<b>Dates of Test</b> July 26 to September 19 and November 11, 2011

GSM Conducted RF Emission Test Data cont'd

**Figure 1-47a: PCS1900 band, Spurious Conducted Emissions, middle channel in Edge Mode**

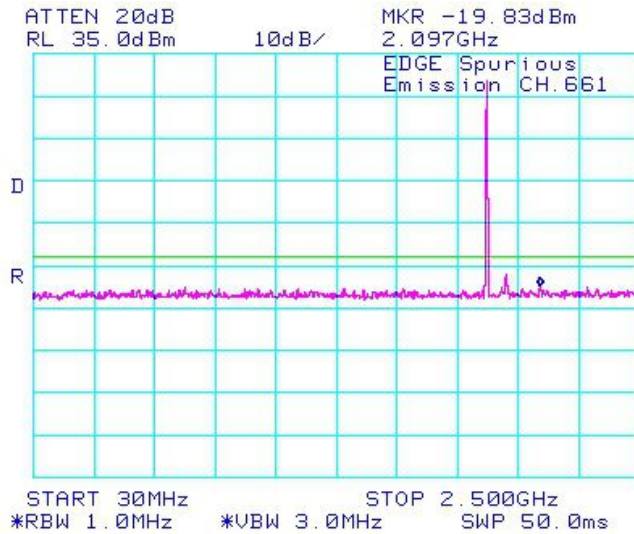

**Figure 1-48a: PCS1900 band, Spurious Conducted Emissions, middle channel in Edge Mode**

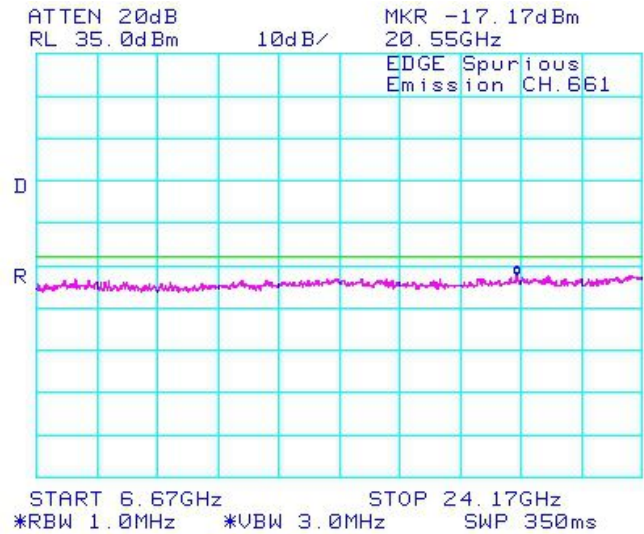

**Figure 1-49a: PCS1900 band, Spurious Conducted Emissions, High channel in Edge Mode**

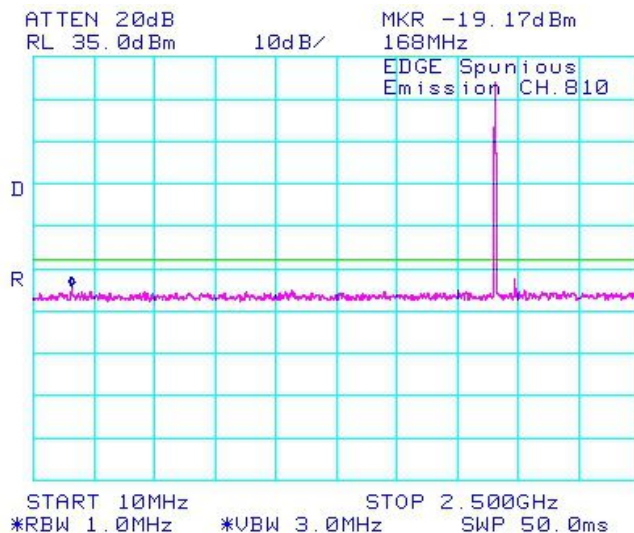

**Figure 1-50a: PCS1900 band, Spurious Conducted Emissions, High channel in Edge Mode**

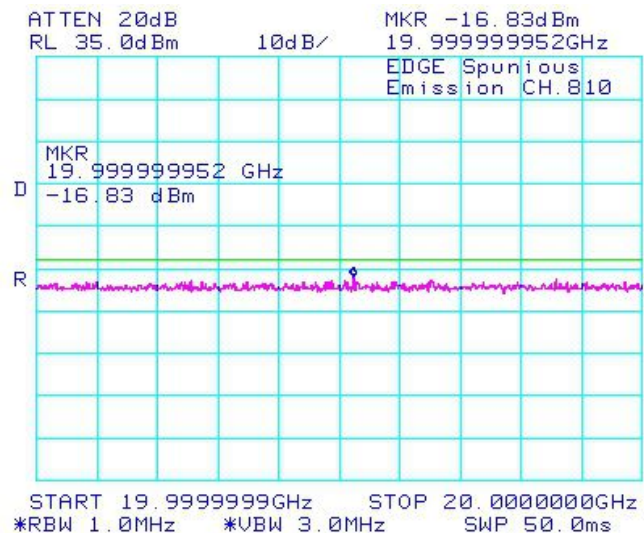

## APPENDIX 1B– UMTS Band 2/5 CONDUCTED RF EMISSIONS TEST DATA/PLOTS



	EMI Test Report for the BlackBerry® smartphone Model REC71UW, RED71UW <b>APPENDIX 1B</b>	
	<b>Test Report No.</b> RTS-5385-1108-52A_rev1	<b>Dates of Test</b> July 26 to September 19 and November 11, 2011

UMTS Conducted RF Emission Test Data cont'd

**The conducted spurious emissions** – As per 47 CFR 2.1051, CFR 24.238(a), CFR 4.202, CFR 22 Subpart H, RSS-132 and RSS - 133 were measured from 10 MHz to 20 GHz. See figures 1-1c to 1-12c for the plots of the conducted spurious emissions.

Date of Test: September 13, 2011

***Test Data for UMTS Band 5/2 selected Frequencies in Loopback mode***

UMTS band 5 Frequency (MHz)	26dBc Occupied Bandwidth (MHz)	99% Occupied Bandwidth (MHz)
826.400	4.725	4.192
836.400	4.750	4.200
846.600	4.767	4.208

UMTS band 2 Frequency (MHz)	26dBc Occupied Bandwidth (MHz)	99% Occupied Bandwidth (MHz)
1852.400	4.658	4.192
1880.000	4.633	4.208
1907.600	4.642	4.208

***Test Data for UMTS band 5/2 selected Frequencies in Call mode***

Refer to the following measurement plots for more detail.

See Figures 1-1c to 1-12c for the plots of the conducted spurious emissions.

See Figures 1-13c to 1-24c for the plots of 99% Occupied Bandwidth and -26 dBc Bandwidth.

See Figures 1-25c to 1-28c for the plots of the Channel mask.

The RF power output was at maximum for all the recorded measurements shown below.

**Test Report No.**  
 RTS-5385-1108-52A\_rev1

**Dates of Test**  
 July 26 to September 19 and  
 November 11, 2011

FCC ID: L6AREC70UW IC ID: 2503A-REC70UW  
 FCC ID: L6ARED70UW IC ID: 2503A-RED70UW

**UMTS Conducted RF Emission Test Data cont'd**

**Figure 1-1c: Band 5, Spurious Conducted Emissions, Low channel**

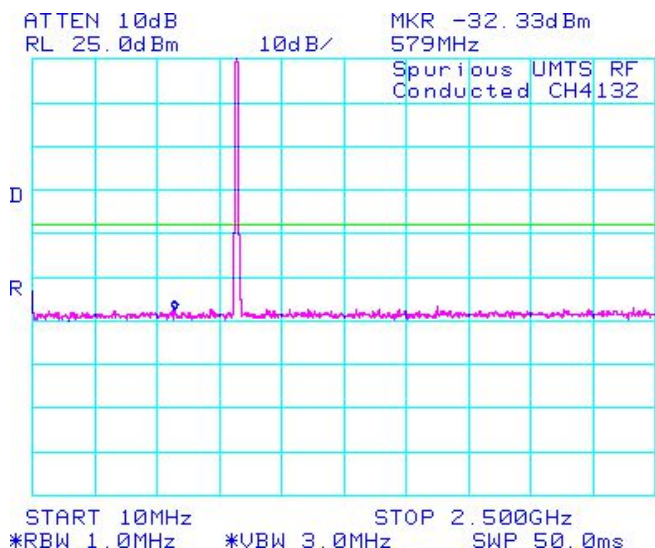

**Figure 1-2c: Band 5, Spurious Conducted Emissions, Low channel**

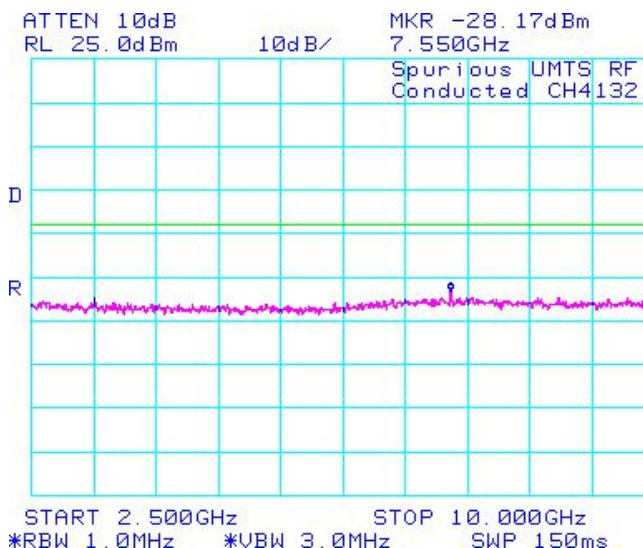

**Figure 1-3c: Band 5, Spurious Conducted Emissions, Middle channel**

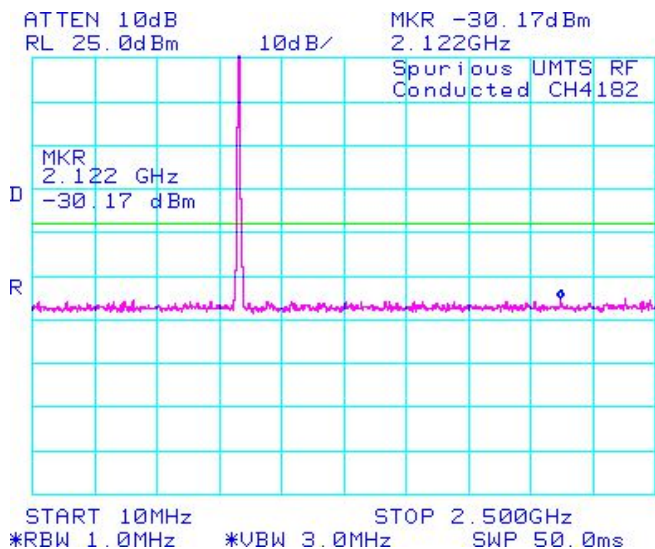

**Figure 1-4c: Band 5, Spurious Conducted Emissions, Middle channel**

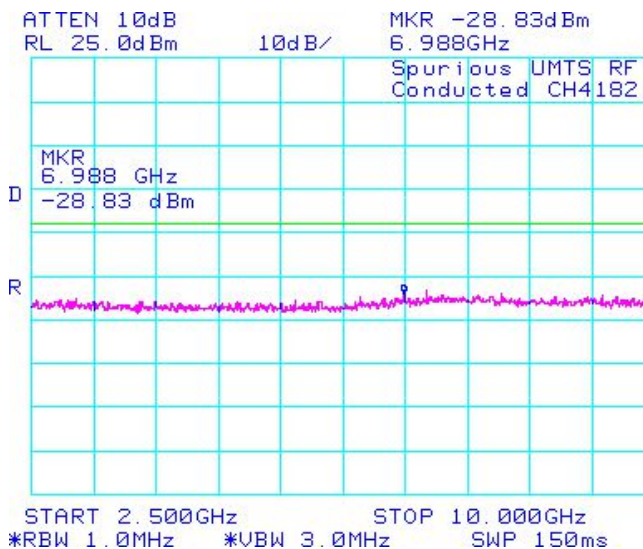



**Test Report No.**  
 RTS-5385-1108-52A\_rev1

**Dates of Test**  
 July 26 to September 19 and  
 November 11, 2011

FCC ID: L6AREC70UW IC ID: 2503A-REC70UW  
 FCC ID: L6ARED70UW IC ID: 2503A-RED70UW

UMTS Conducted RF Emission Test Data cont'd

**Figure 1-5c: Band 5, Spurious Conducted Emissions, High Channel**

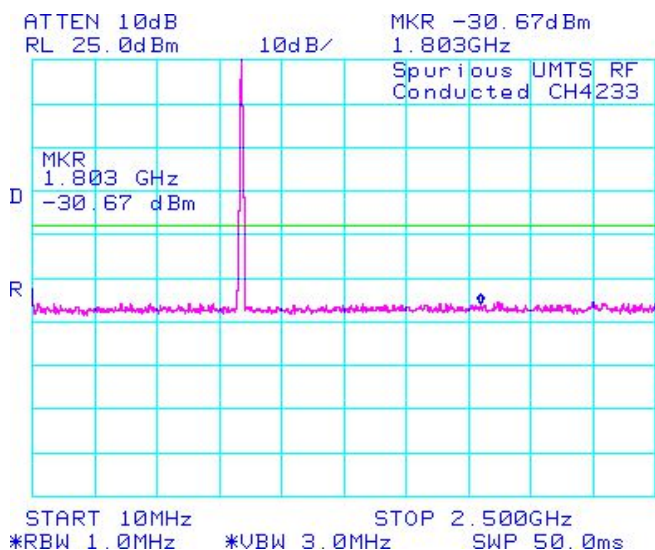

**Figure 1-6c: Band 5, Spurious Conducted Emissions, High Channel**

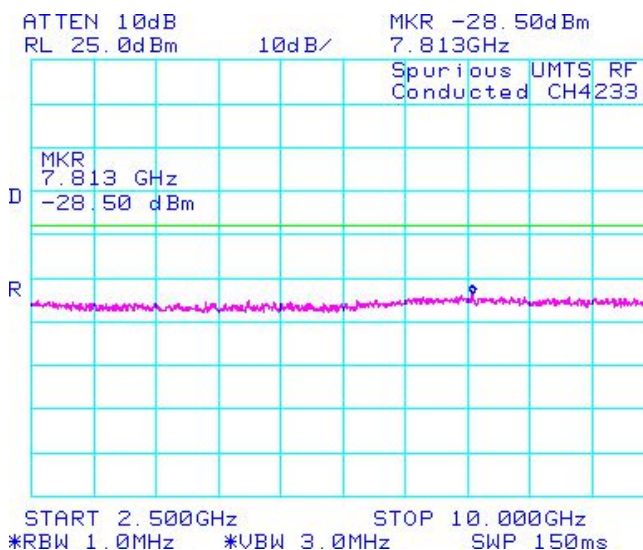

**Figure 1-7c: BAND 2 Spurious Conducted Emissions, Low Channel**

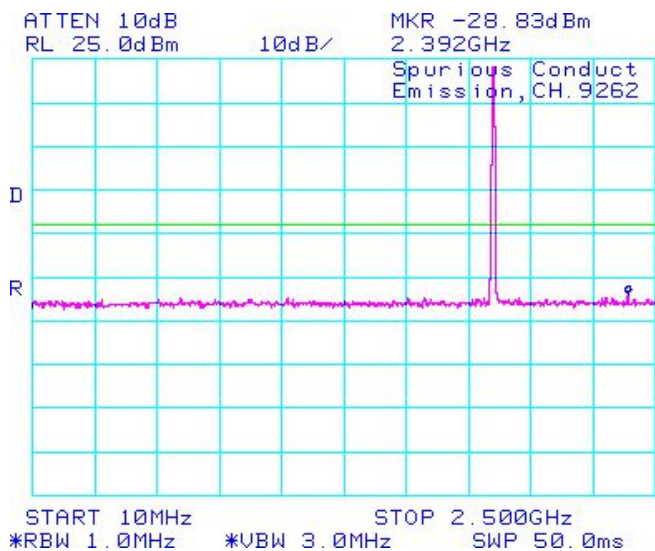

**Figure 1-8c: BAND 2, Spurious Conducted Emissions, Low Channel**

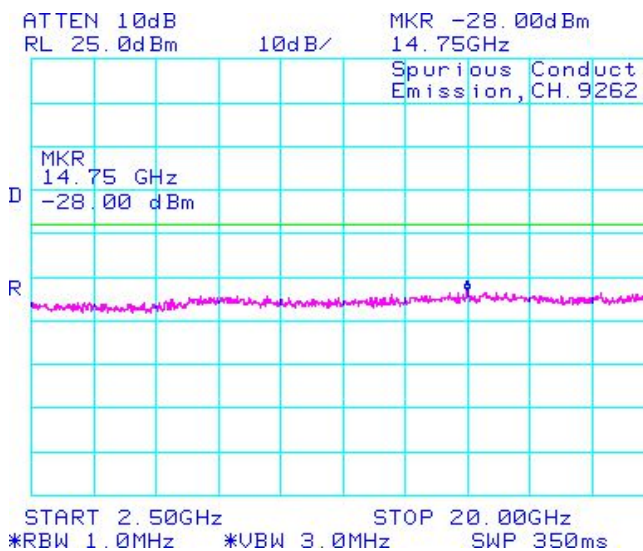

**Test Report No.**  
 RTS-5385-1108-52A\_rev1

**Dates of Test**  
 July 26 to September 19 and  
 November 11, 2011

FCC ID: L6AREC70UW IC ID: 2503A-REC70UW  
 FCC ID: L6ARED70UW IC ID: 2503A-RED70UW

UMTS Conducted RF Emission Test Data cont'd

**Figure 1-9c: BAND 2, Spurious Conducted Emissions, Middle Channel**

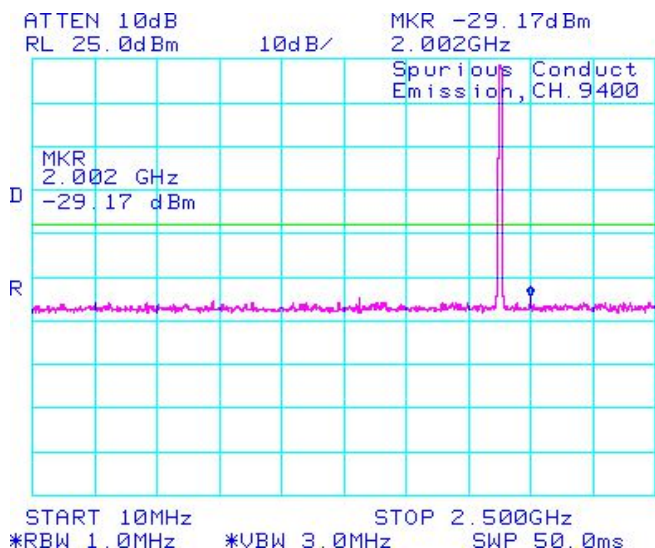

**Figure 1-10c: BAND 2, Spurious Conducted Emissions, Middle Channel**

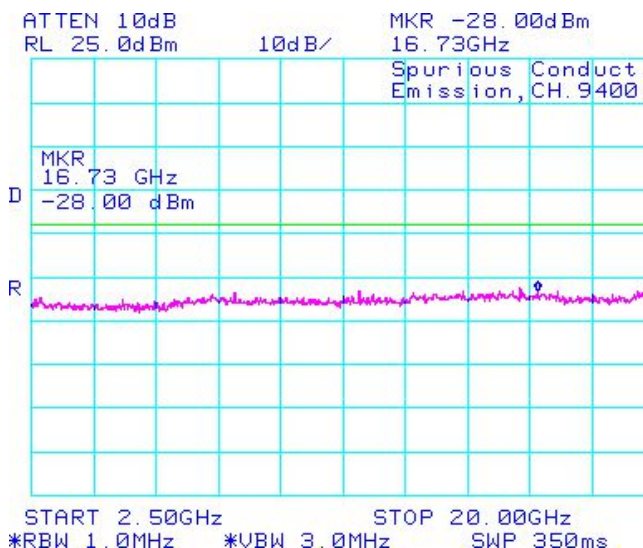

**Figure 1-11c: BAND 2, Spurious Conducted Emissions, High Channel**

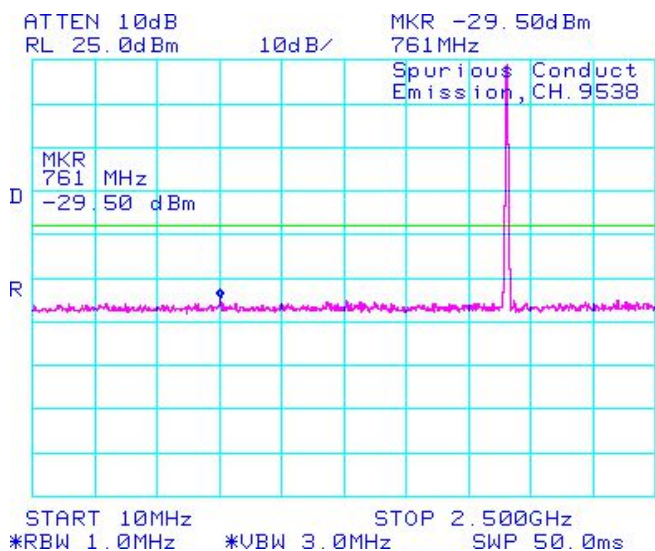

**Figure 1-12c: BAND 2, Spurious Conducted Emissions, High Channel**

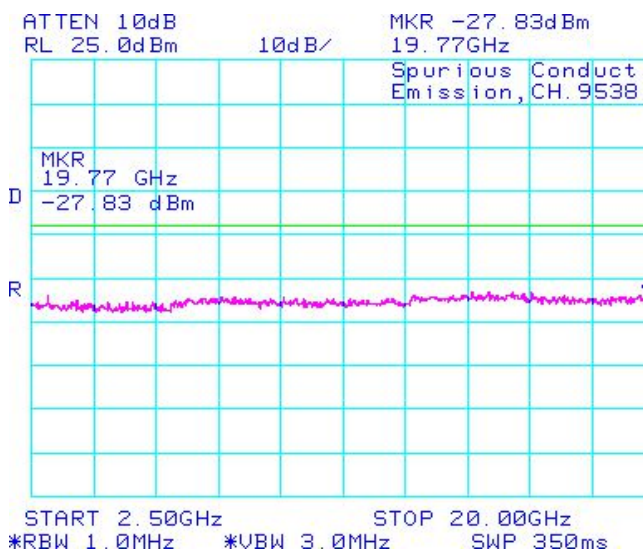

**Test Report No.**  
 RTS-5385-1108-52A\_rev1

**Dates of Test**  
 July 26 to September 19 and  
 November 11, 2011

FCC ID: L6AREC70UW IC ID: 2503A-REC70UW  
 FCC ID: L6ARED70UW IC ID: 2503A-RED70UW

UMTS Conducted RF Emission Test Data cont'd

**Figure 1-13c: Occupied Bandwidth, Band 5 Low Channel**

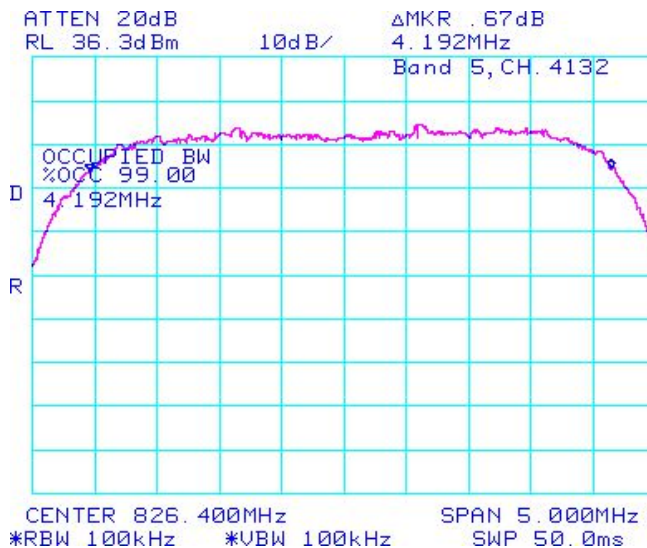

**Figure 1-14c: Occupied Bandwidth, Band 5 Middle Channel**

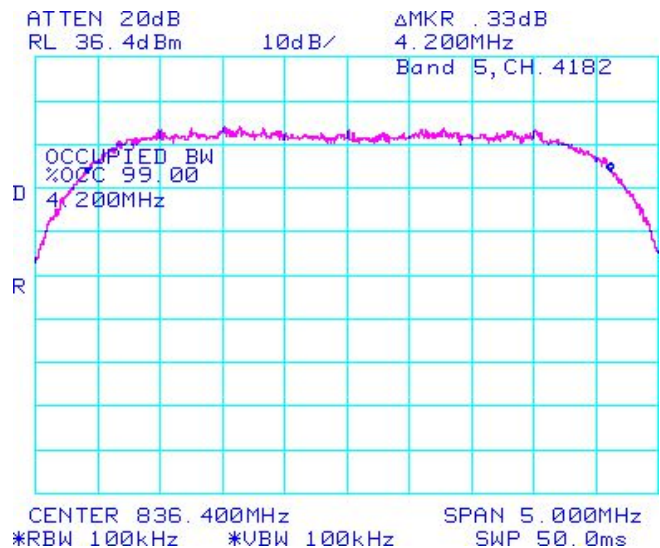

**Figure 1-15c: Occupied Bandwidth, Band 5 High Channel**

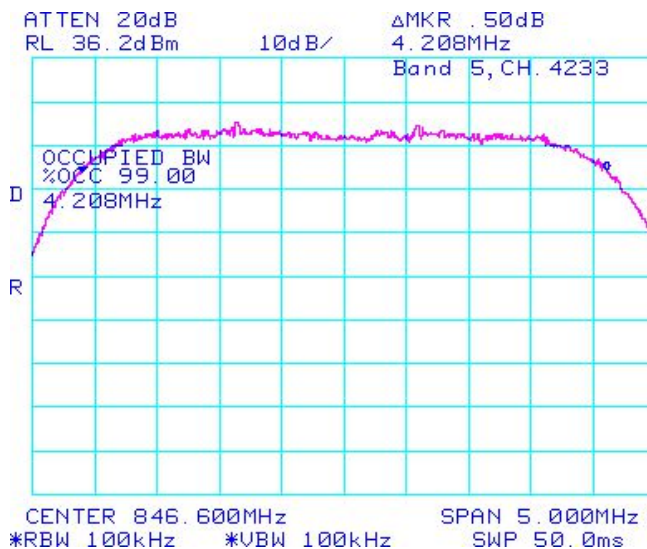

**Figure 1-16c: Occupied Bandwidth, BAND 2 Low Channel**

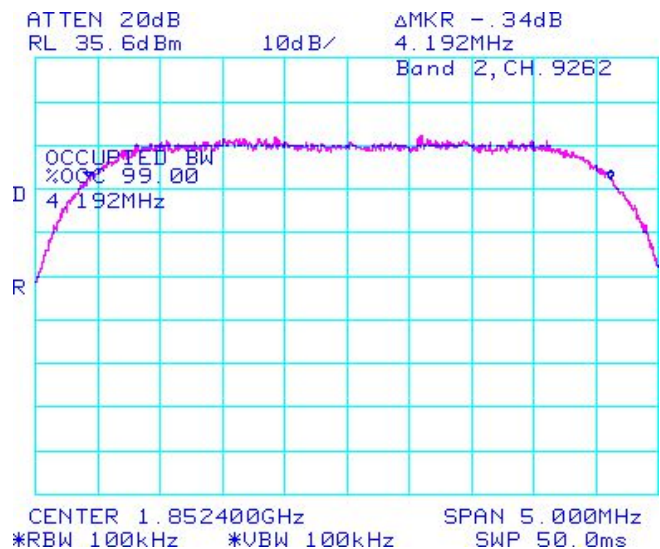

**Test Report No.**  
 RTS-5385-1108-52A\_rev1

**Dates of Test**  
 July 26 to September 19 and  
 November 11, 2011

FCC ID: L6AREC70UW IC ID: 2503A-REC70UW  
 FCC ID: L6ARED70UW IC ID: 2503A-RED70UW

UMTS Conducted RF Emission Test Data cont'd

**Figure 1-17c: Occupied Bandwidth, BAND 2 Middle Channel**

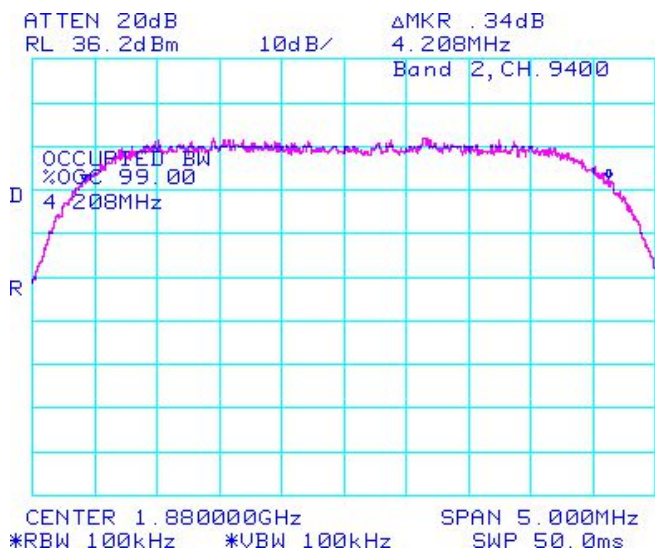

**Figure 1-18c: Occupied Bandwidth, BAND 2 High Channel**

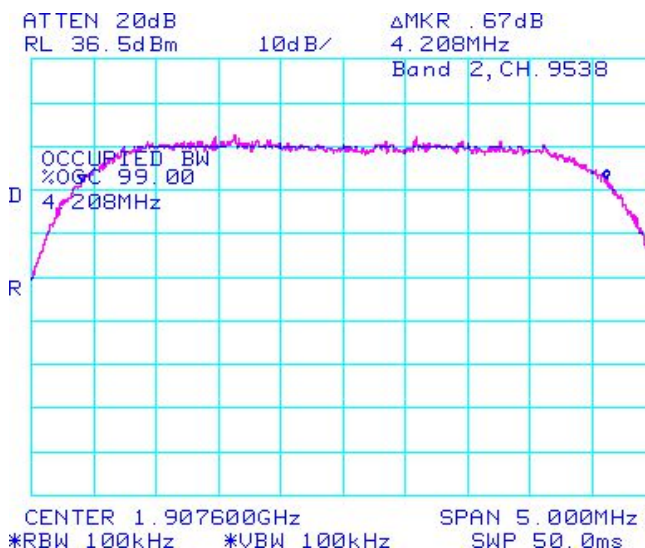

**Figure 1-19c: -26 dBc Bandwidth, Band 5 Low Channel**

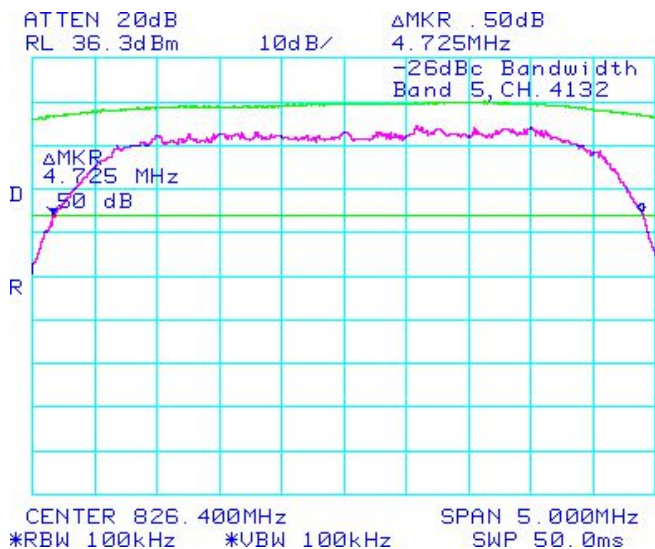

**Figure 1-20c: -26 dBc Bandwidth, Band 2 Low Channel**

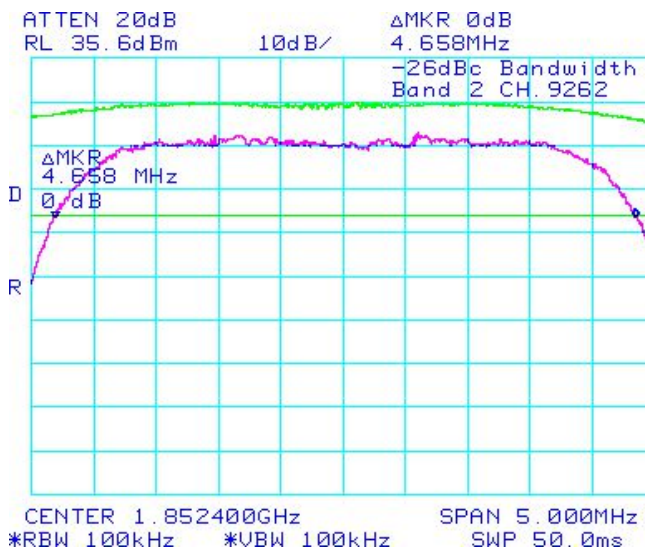

**Test Report No.**  
 RTS-5385-1108-52A\_rev1

**Dates of Test**  
 July 26 to September 19 and  
 November 11, 2011

FCC ID: L6AREC70UW IC ID: 2503A-REC70UW  
 FCC ID: L6ARED70UW IC ID: 2503A-RED70UW

UMTS Conducted RF Emission Test Data cont'd

**Figure 1-21c: -26 dBc Bandwidth, Band 5 Middle Channel**

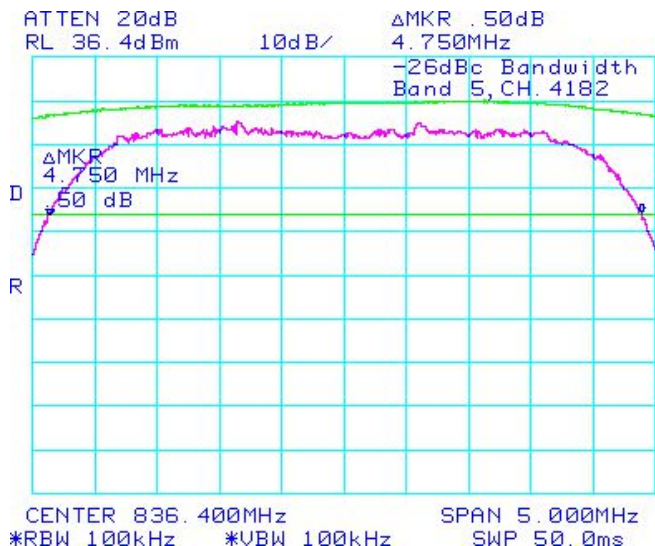

**Figure 1-22c: -26 dBc Bandwidth, Band 2 Middle Channel**

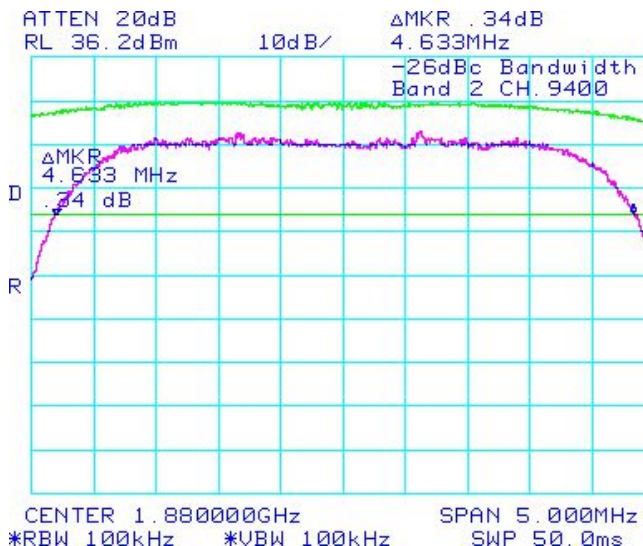

**Figure 1-23c: -26 dBc Bandwidth, Band 5 High Channel**

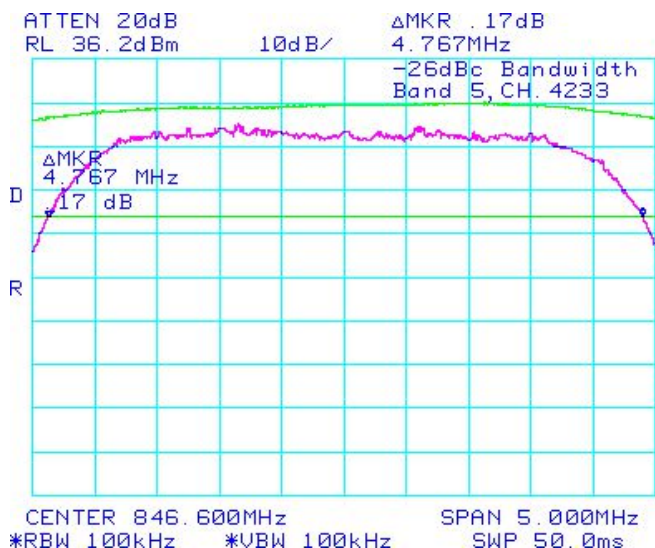

**Figure 1-24c: -26 dBc Bandwidth, Band 2 High Channel**

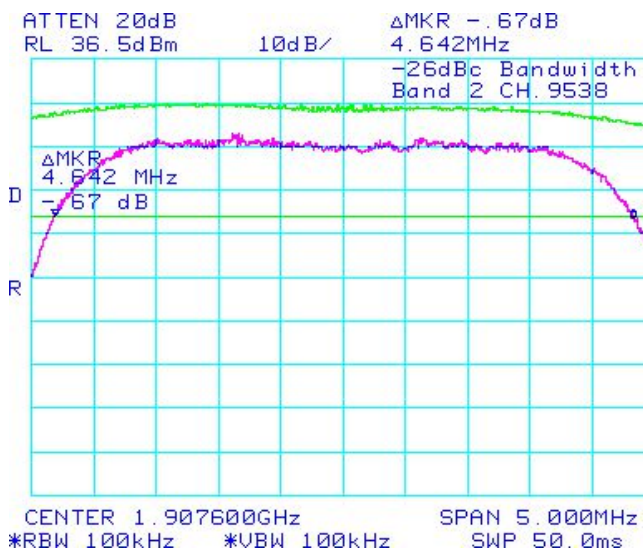

**Test Report No.**  
 RTS-5385-1108-52A\_rev1

**Dates of Test**  
 July 26 to September 19 and  
 November 11, 2011

FCC ID: L6AREC70UW IC ID: 2503A-REC70UW  
 FCC ID: L6ARED70UW IC ID: 2503A-RED70UW

UMTS Conducted RF Emission Test Data cont'd

**Figure 1-25c: Band 2 Low Channel Mask**

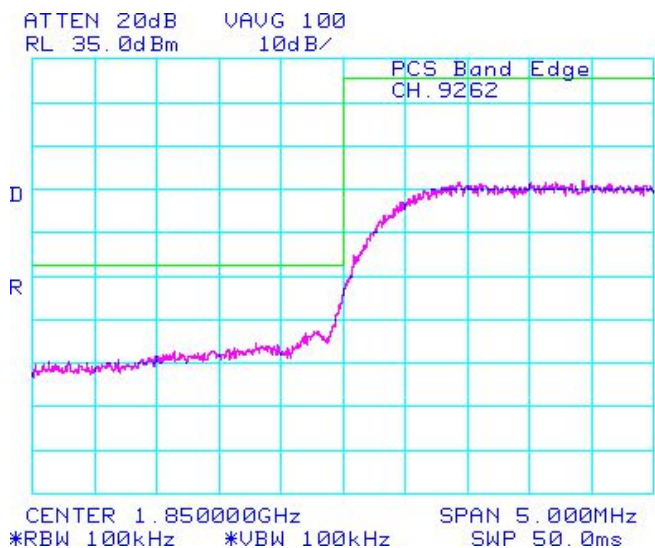

**Figure 1-26c: Band 2 High Channel Mask**

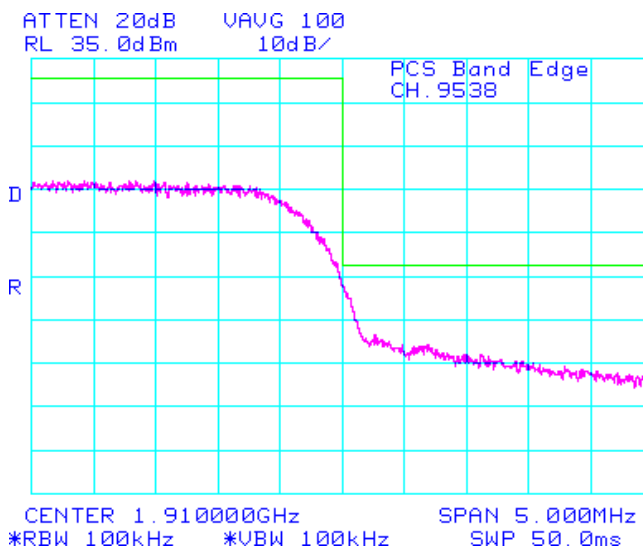

**Figure 1-27c: Band 5 Low Channel Mask**

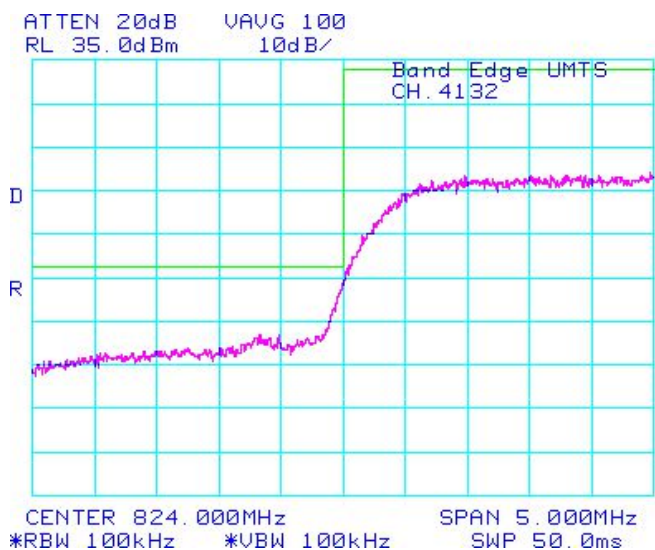

**Figure 1-28c: Band 5 High Channel Mask**

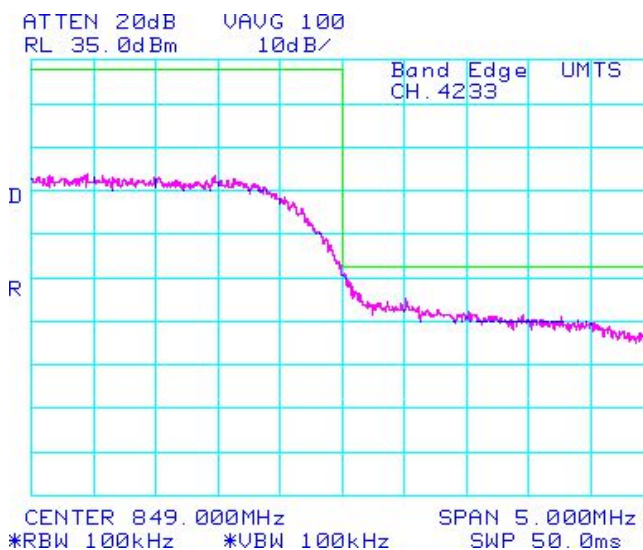



**Test Report No.**  
 RTS-5385-1108-52A\_rev1

**Dates of Test**  
 July 26 to September 19 and  
 November 11, 2011

FCC ID: L6AREC70UW IC ID: 2503A-REC70UW  
 FCC ID: L6ARED70UW IC ID: 2503A-RED70UW

UMTS Conducted RF Emission Test Data cont'd

**Figure 1-23b: Band 5 , Spurious Conducted Emissions, Low channel**

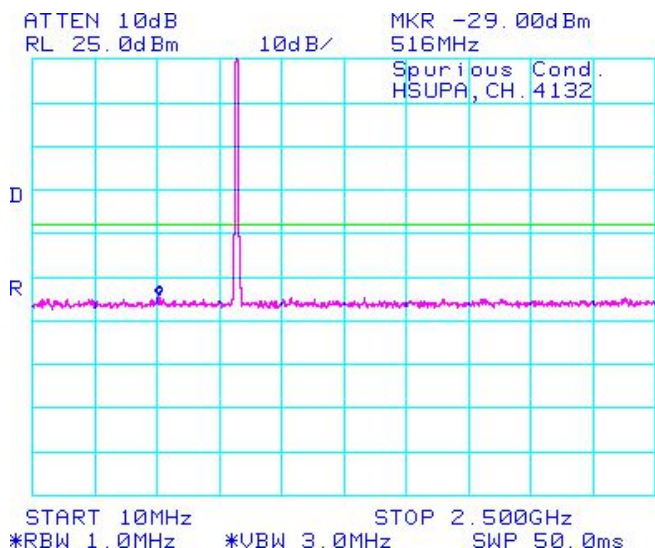

**Figure 1-24b: Band 5 , Spurious Conducted Emissions, Low channel**

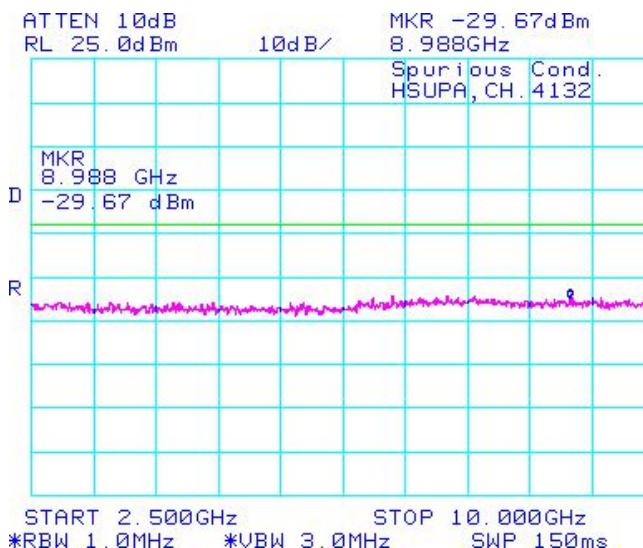

**Figure 1-25b: Band 5 , Spurious Conducted Emissions, Middle channel**

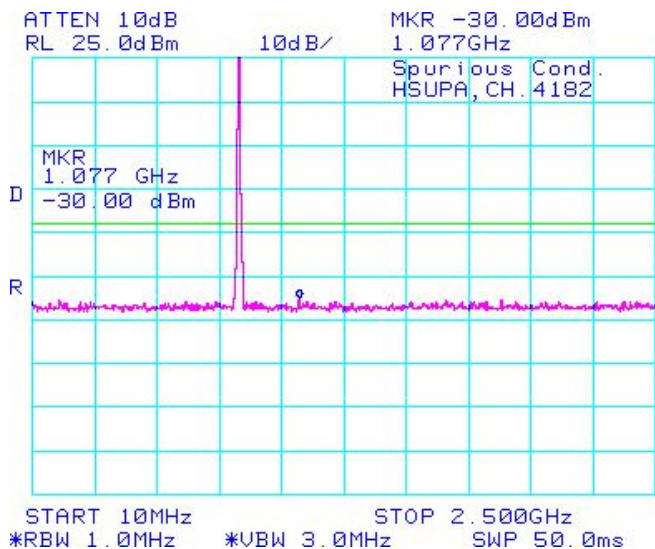

**Figure 1-26b: Band 5 , Spurious Conducted Emissions, Middle channel**

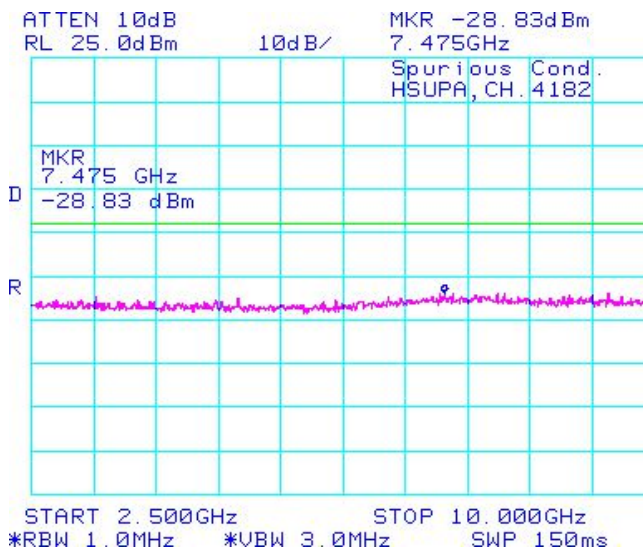



**Test Report No.**  
 RTS-5385-1108-52A\_rev1

**Dates of Test**  
 July 26 to September 19 and  
 November 11, 2011

FCC ID: L6AREC70UW IC ID: 2503A-REC70UW  
 FCC ID: L6ARED70UW IC ID: 2503A-RED70UW

UMTS Conducted RF Emission Test Data cont'd

**Figure 1-27b: Band 5, Spurious Conducted Emissions, High Channel**

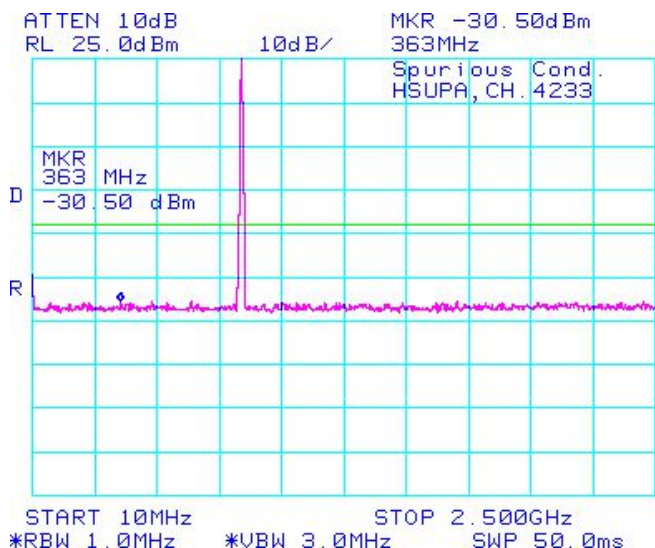

**Figure 1-28b: Band 5, Spurious Conducted Emissions, High Channel**

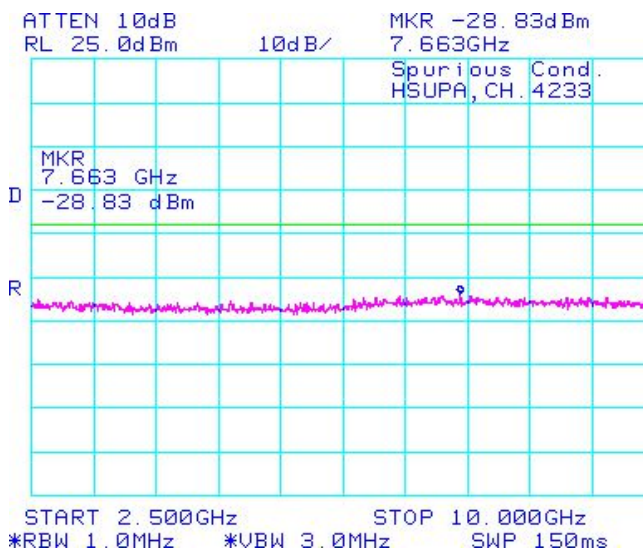

**Figure 1-29b: Band 2, Spurious Conducted Emissions, Low Channel**

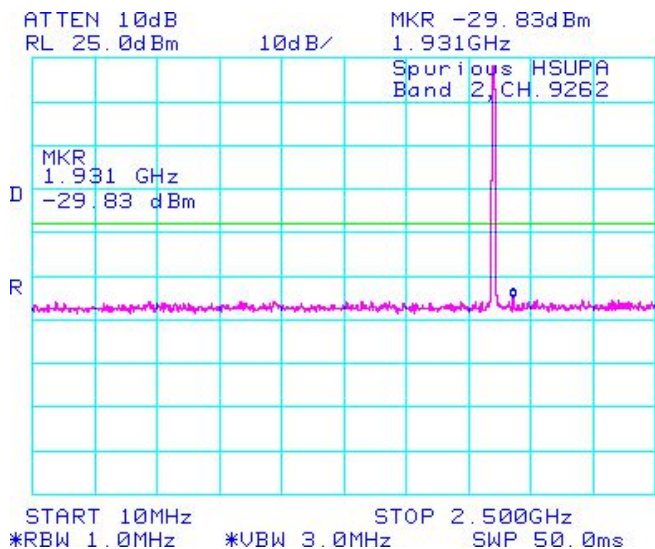

**Figure 1-30b: Band 2, Spurious Conducted Emissions, Low Channel**

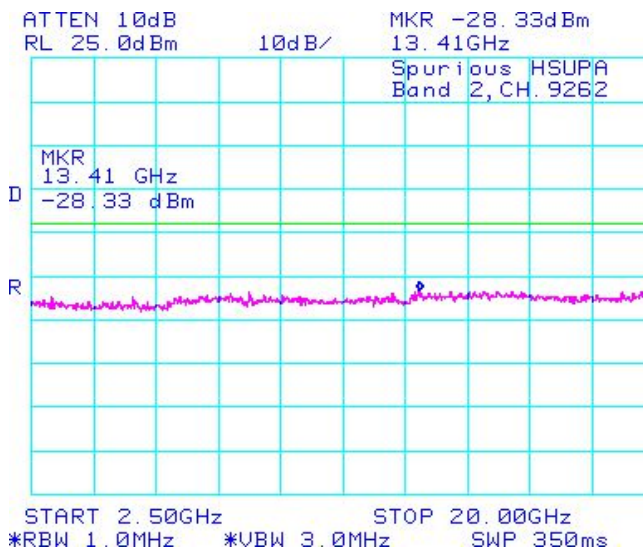

**Test Report No.**  
 RTS-5385-1108-52A\_rev1

**Dates of Test**  
 July 26 to September 19 and  
 November 11, 2011

FCC ID: L6AREC70UW IC ID: 2503A-REC70UW  
 FCC ID: L6ARED70UW IC ID: 2503A-RED70UW

UMTS Conducted RF Emission Test Data cont'd

**Figure 1-31b: Band 2, Spurious Conducted Emissions, Middle Channel**

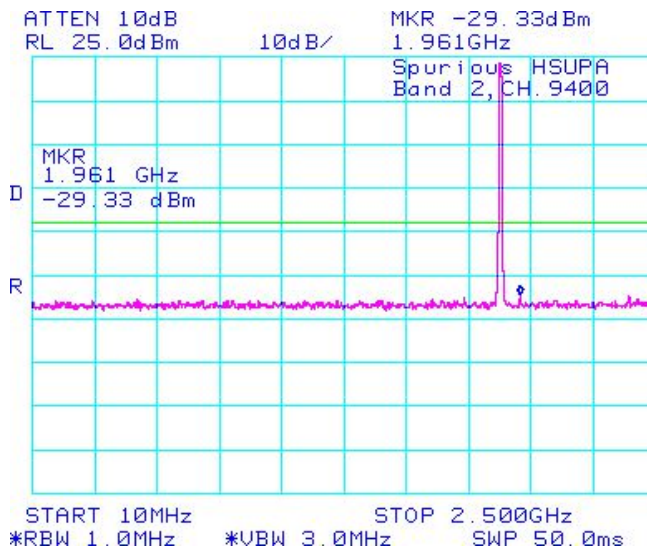

**Figure 1-32b: Band 2, Spurious Conducted Emissions, Middle Channel**

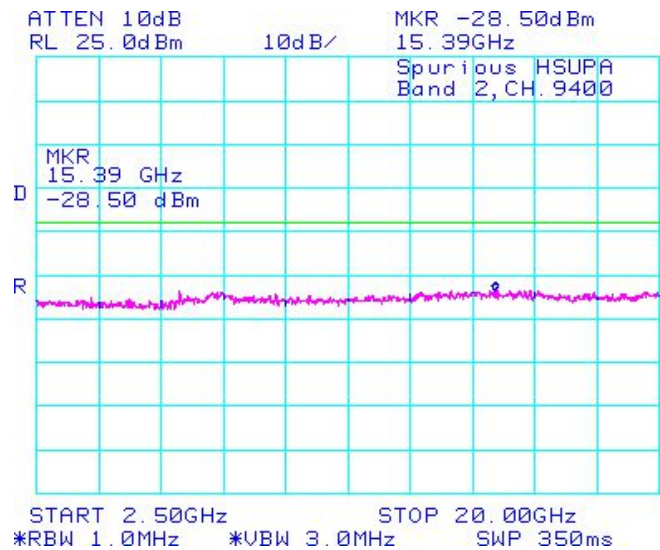

**Figure 1-33b: Band 2, Spurious Conducted Emissions, High Channel**

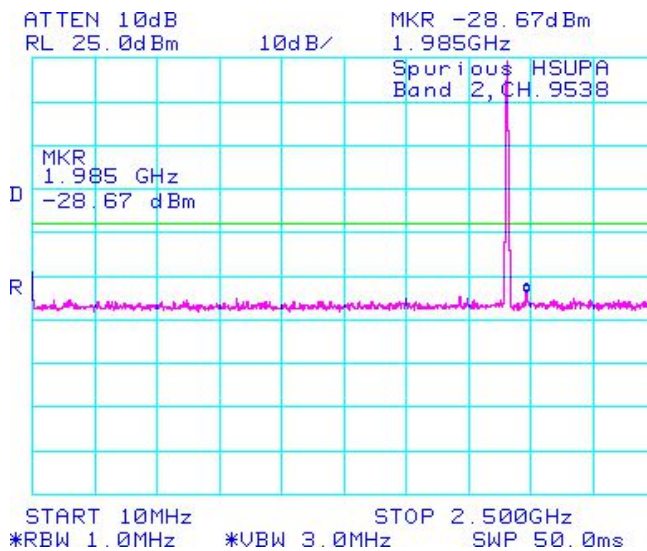

**Figure 1-34b: Band 2, Spurious Conducted Emissions, High Channel**

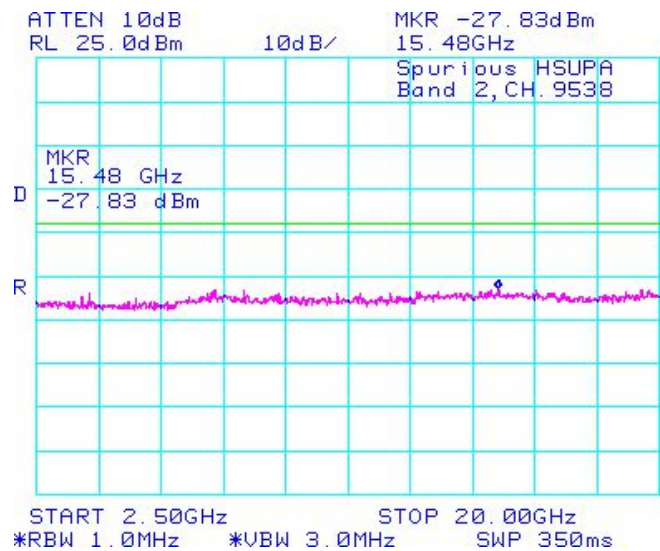

**Test Report No.**  
 RTS-5385-1108-52A\_rev1

**Dates of Test**  
 July 26 to September 19 and  
 November 11, 2011

FCC ID: L6AREC70UW IC ID: 2503A-REC70UW  
 FCC ID: L6ARED70UW IC ID: 2503A-RED70UW

UMTS Conducted RF Emission Test Data cont'd

**Figure 1-35b: Occupied Bandwidth, Band 5 Low Channel**

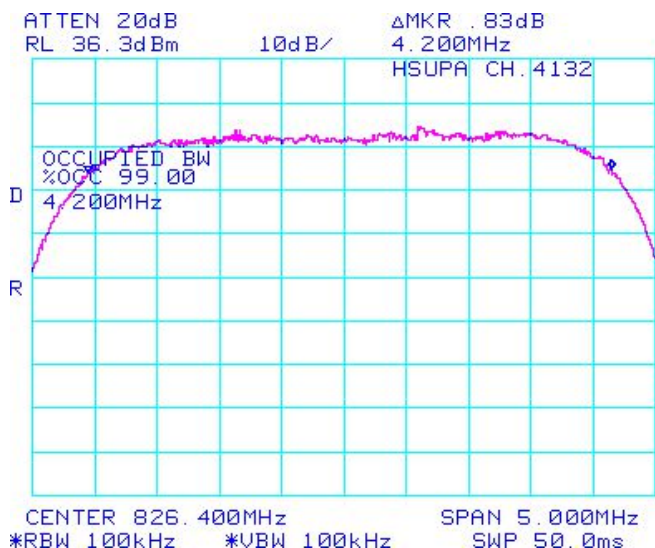

**Figure 1-36b: Occupied Bandwidth, Band 5 Middle Channel**

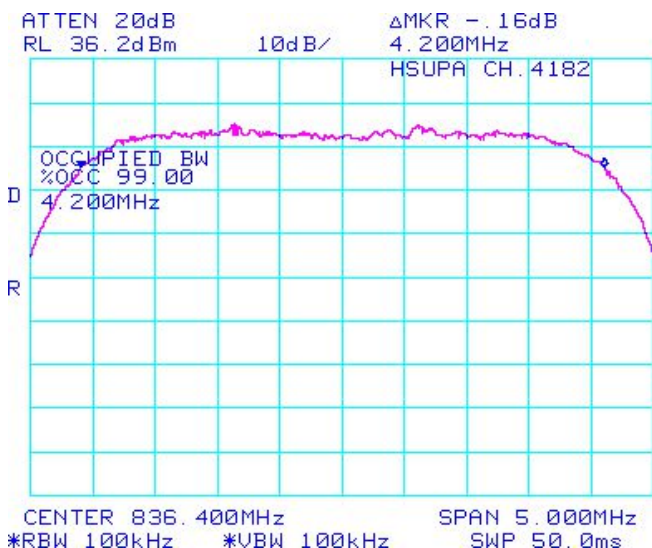

**Figure 1-37b: Occupied Bandwidth, Band 5 High Channel**

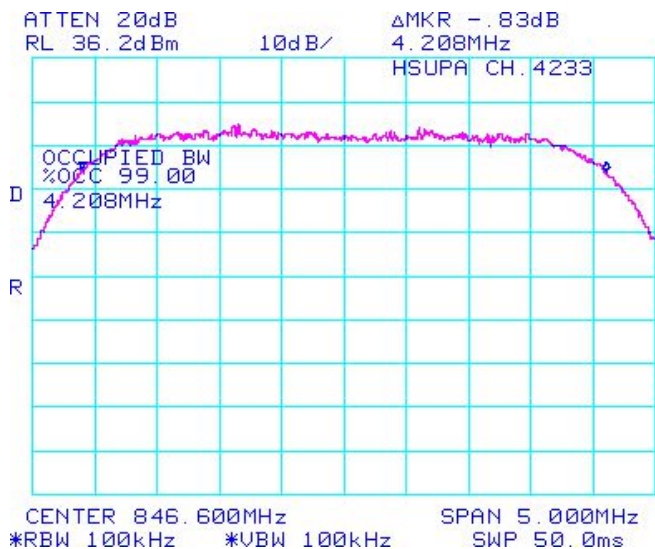

**Figure 1-38b: Occupied Bandwidth, BAND 2 Low Channel**

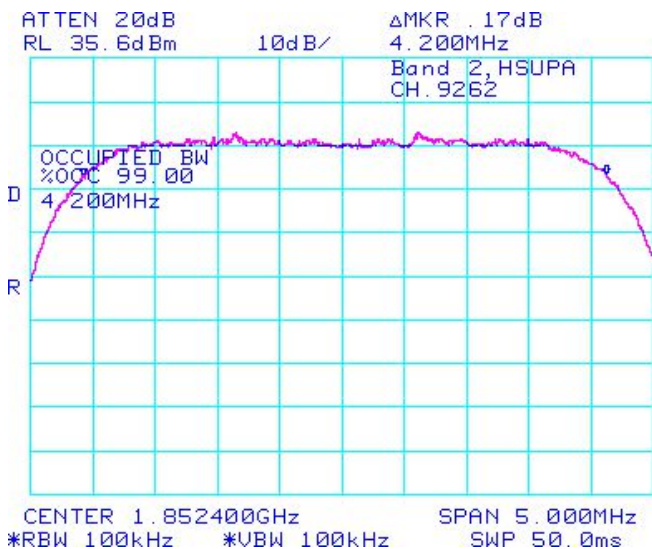

**Test Report No.**  
 RTS-5385-1108-52A\_rev1

**Dates of Test**  
 July 26 to September 19 and  
 November 11, 2011

FCC ID: L6AREC70UW IC ID: 2503A-REC70UW  
 FCC ID: L6ARED70UW IC ID: 2503A-RED70UW

UMTS Conducted RF Emission Test Data cont'd

**Figure 1-38b: Occupied Bandwidth, BAND 2 Middle Channel**

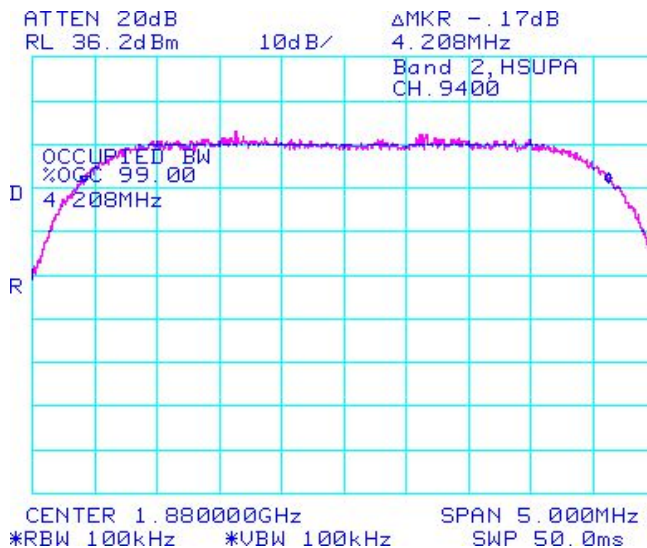

**Figure 1-39b: Occupied Bandwidth, BAND 2 High Channel**

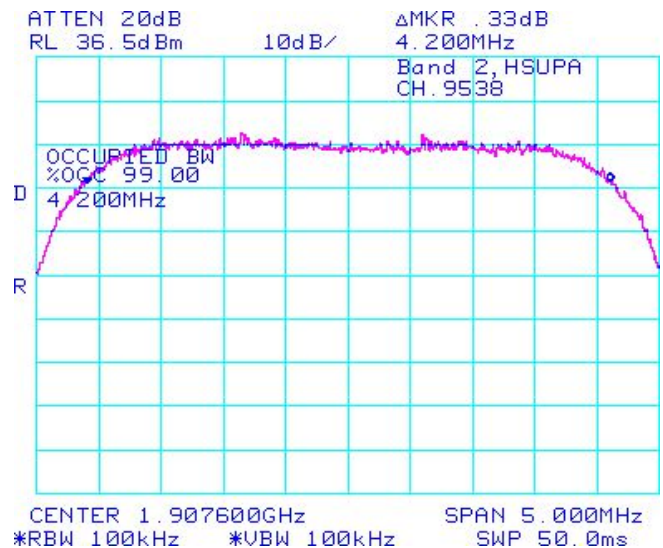

**Figure 1-40b: Band 5, Low Channel Mask**

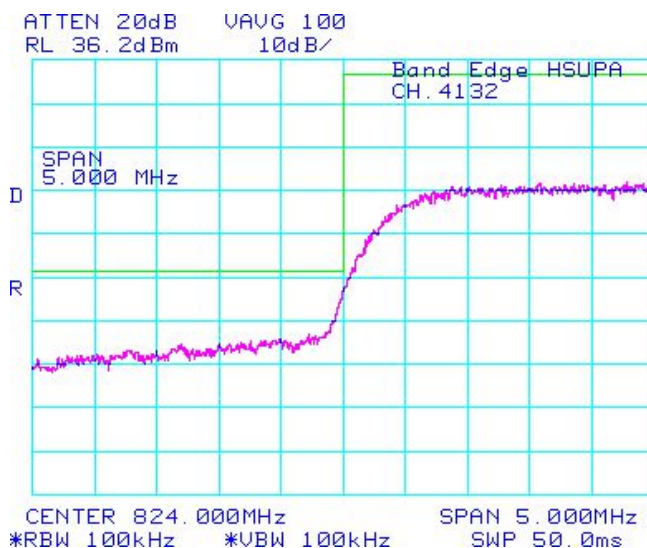

**Figure 1-41b: Band 5, High Channel Mask**

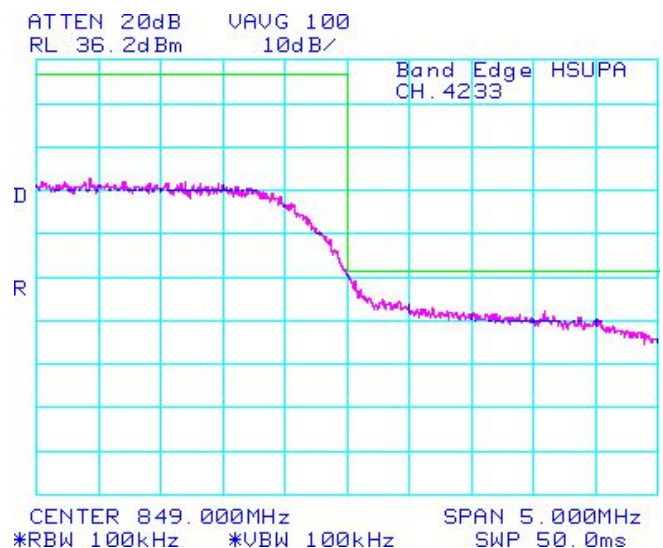

**Test Report No.**  
 RTS-5385-1108-52A\_rev1

**Dates of Test**  
 July 26 to September 19 and  
 November 11, 2011

FCC ID: L6AREC70UW IC ID: 2503A-REC70UW  
 FCC ID: L6ARED70UW IC ID: 2503A-RED70UW

UMTS Conducted RF Emission Test Data cont'd

**Figure 1-42b: Band 2, Low Channel Mask**

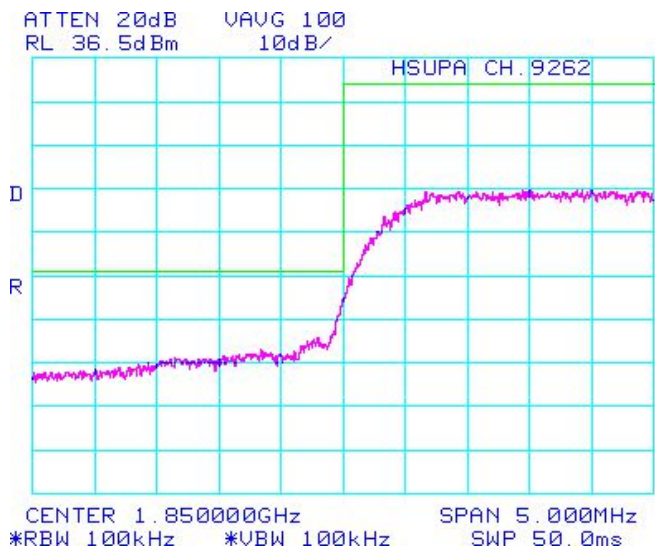

**Figure 1-43b: Band 2, High Channel Mask**

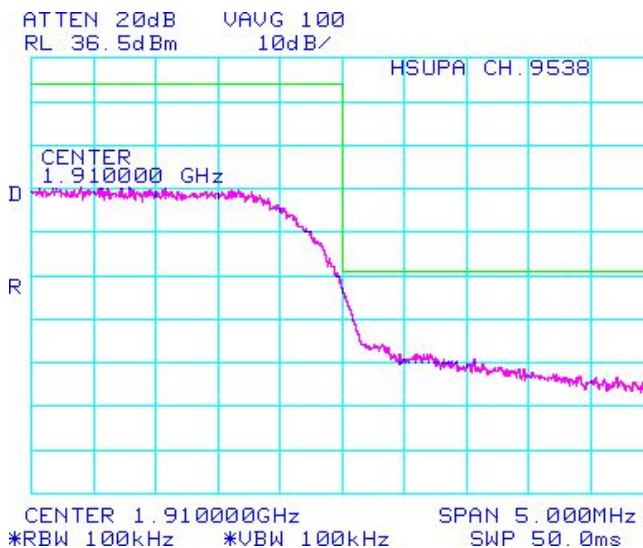

## APPENDIX 1C – UMTS Band 4 CONDUCTED RF EMISSIONS TEST DATA/PLOTS



	EMI Test Report for the BlackBerry® smartphone Model REC71UW, RED71UW <b>APPENDIX 2A</b>	
	<b>Test Report No.</b> RTS-5385-1108-52A_rev1	<b>Dates of Test</b> July 26 to September 19 and November 11, 2011

UMTS Conducted RF Emission Test Data cont'd

**The conducted spurious emissions** – As per 47 CFR 2.202, CFR 27.53, RSS-139 and RSS - GEN were measured from 10 MHz to 20 GHz.  
See figures 1-1c to 1-11c for the plots of the conducted spurious emissions.

Date of Test: September 14 and November 11, 2011

The power of any emission outside a licensee's frequency block shall be attenuated below the transmitter power (P) by at least  $43 + 10 \log_{10}(P)$  dB. Compliance with this provision is based on the use of measurement instrumentation employing a resolution bandwidth of 1 megahertz or greater. However, in the 1 megahertz bands immediately outside and adjacent to the licensee's frequency block, a resolution bandwidth of at least one percent of the emission bandwidth of the fundamental emission of the transmitter may be employed. The emission bandwidth is defined as the width of the signal between two points, one below the carrier center frequency and one above the carrier center frequency, outside of which all emissions are attenuated at least 26 dB below the transmitter power.

Since 1% RBW (which is 47 kHz) of the Emission Bandwidth is not available in the test instrument, therefore the lower available RBW (which is 30 kHz) was used for these measurements.

An additional correctional factor of  $10\log(RBW1/RBW2)$  to the  $43+10\log(P)$  limit was added, resulting in a lower limit.

**Test Data UMTS Band 4 selected Frequencies in Call mode**

UMTS band 4 Frequency (MHz)	26dBc Occupied Bandwidth (MHz)	99% Occupied Bandwidth (MHz)
1712.400	4.692	4.192
1732.600	4.675	4.183
1752.600	4.683	4.192

Channel Mask						
Channel	Spurious Frequency (MHz)	Maximum Value (dBm)	Limit (dBm)	Margin to Limit (dBm)	Result	Remarks
Low	1710.000	-24.67+2.21 =-22.46	-13	9.46	Passed	Band-Edge Compliance Correction Factor $10\log(50\text{kHz}/30\text{kHz})$ to be used equals 2.21
High	1755.000	-25.67+2.21 =-23.46	-13	10.46	Passed	

This report shall **NOT** be reproduced except in full without the written consent of RIM Testing Services  
- A division of Research in Motion Limited.



	EMI Test Report for the BlackBerry® smartphone Model REC71UW, RED71UW <b>APPENDIX 2A</b>	
<b>Test Report No.</b> RTS-5385-1108-52A_rev1	<b>Dates of Test</b> July 26 to September 19 and November 11, 2011	FCC ID: L6AREC70UW IC ID: 2503A-REC70UW FCC ID: L6ARED70UW IC ID: 2503A-RED70UW

***Test Data for UMTS band 4 selected Frequencies in Call mode***

Refer to the following measurement plots for more detail.

See Figures 1-1c to 1-6c for the plots of the conducted spurious emissions.

See Figures 1-7c to 1-12c for the plots of 99% Occupied Bandwidth and -26 dBc Bandwidth.

See Figures 1-13c to 1-14c for the plots of the Channel mask.

The RF power output was at maximum for all the recorded measurements shown below.

**Test Report No.**  
 RTS-5385-1108-52A\_rev1

**Dates of Test**  
 July 26 to September 19 and  
 November 11, 2011

FCC ID: L6AREC70UW IC ID: 2503A-REC70UW  
 FCC ID: L6ARED70UW IC ID: 2503A-RED70UW

UMTS Conducted RF Emission Test Data cont'd

**Figure 1-1c: Band 4, Spurious Conducted Emissions, Low channel**

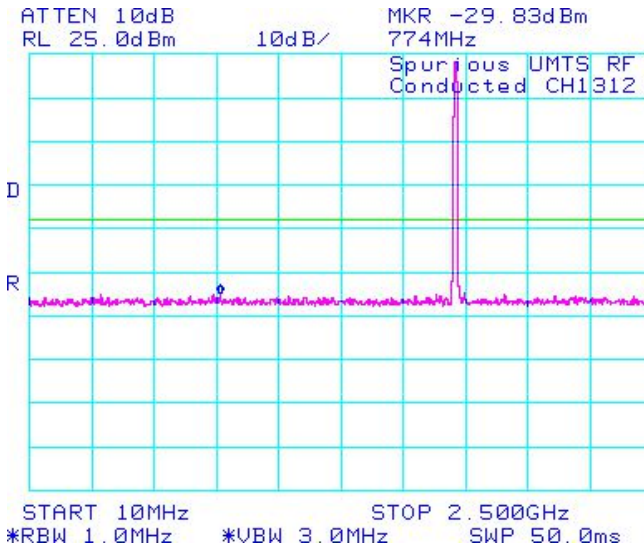

**Figure 1-2c: Band 4, Spurious Conducted Emissions, Low channel**

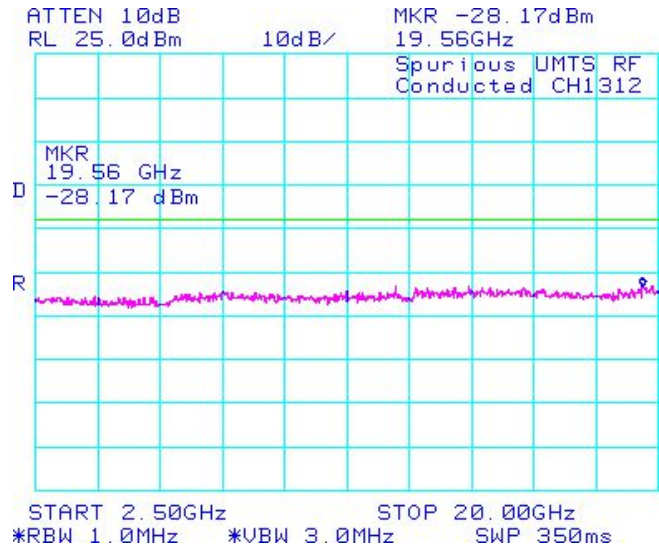

**Figure 1-3c: Band 4, Spurious Conducted Emissions, Middle channel**

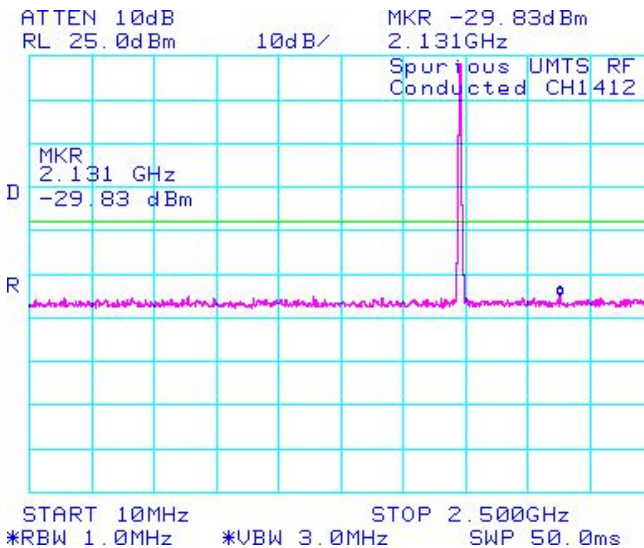

**Figure 1-4c: Band 4, Spurious Conducted Emissions, Middle channel**

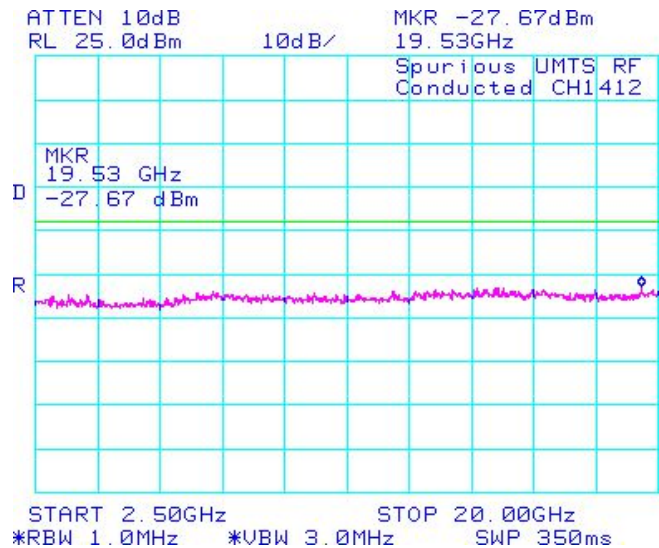

<b>Test Report No.</b> RTS-5385-1108-52A_rev1	<b>Dates of Test</b> July 26 to September 19 and November 11, 2011	FCC ID: L6AREC70UW IC ID: 2503A-REC70UW FCC ID: L6ARED70UW IC ID: 2503A-RED70UW
--	--	--

UMTS Conducted RF Emission Test Data cont'd

**Figure 1-5c: Band 4, Spurious Conducted Emissions, High channel**

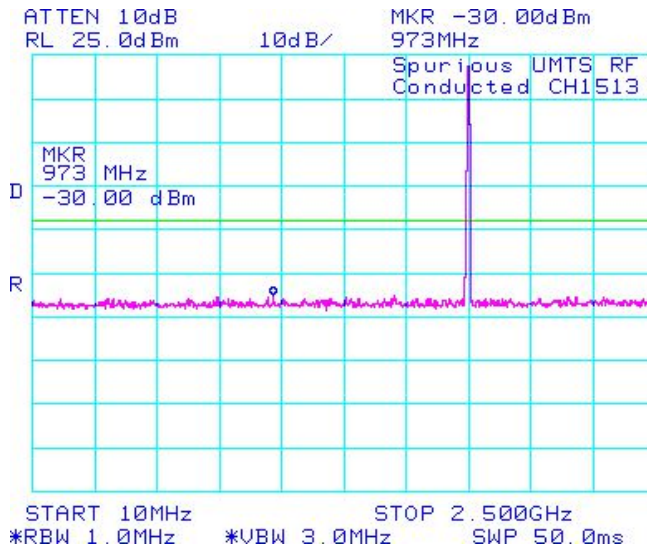

**Figure 1-6c: Band 4, Spurious Conducted Emissions, High channel**

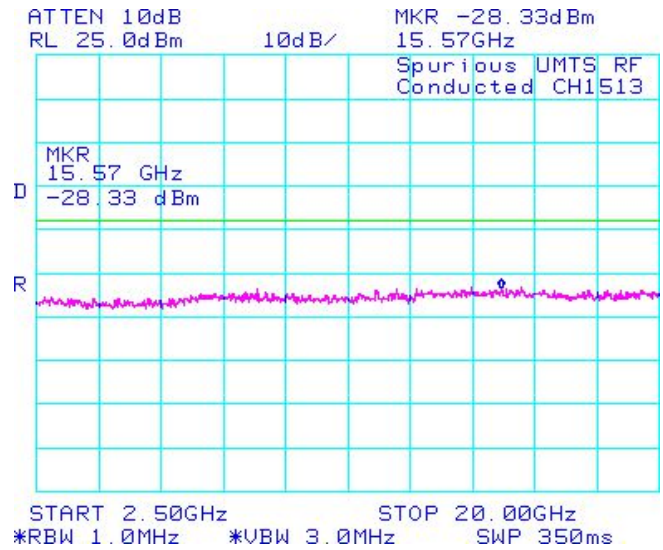

**Figure 1-7c: Occupied Bandwidth, Band 4 Low Channel**

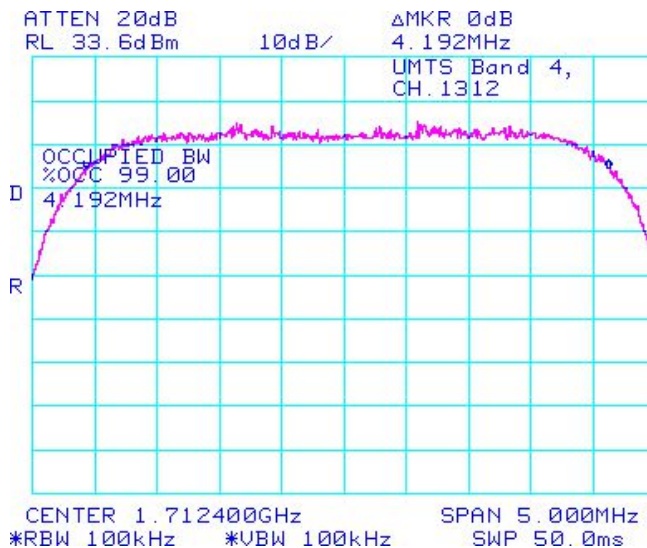

**Figure 1-8c: Occupied Bandwidth, Band 4 Middle Channel**

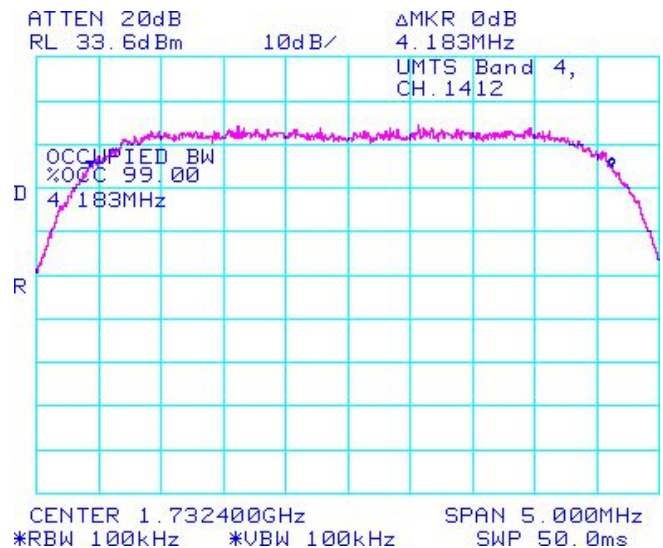

**Test Report No.**  
 RTS-5385-1108-52A\_rev1

**Dates of Test**  
 July 26 to September 19 and  
 November 11, 2011

FCC ID: L6AREC70UW IC ID: 2503A-REC70UW  
 FCC ID: L6ARED70UW IC ID: 2503A-RED70UW

UMTS Conducted RF Emission Test Data cont'd

**Figure 1-9c: Occupied Bandwidth, Band 4 High Channel**

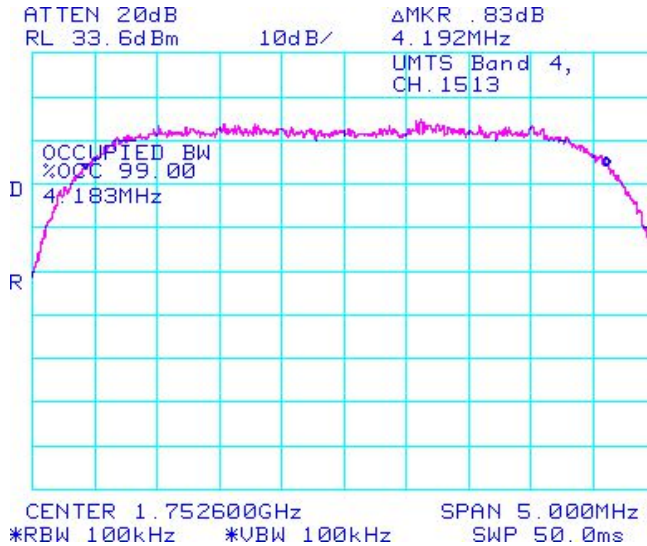

**Figure 1-10c: -26 dBc Bandwidth, Band 4 Low Channel**

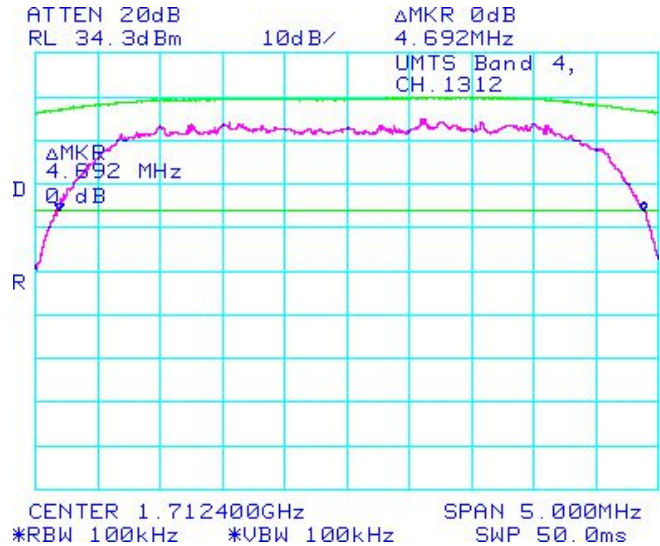

**Figure 1-11c: -26 dBc Bandwidth, Band 4 Middle Channel**

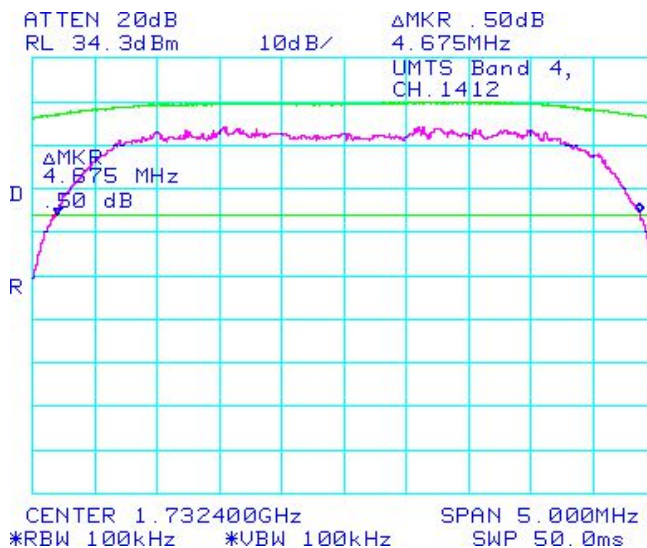

**Figure 1-12c: -26 dBc Bandwidth, Band 4 High Channel**

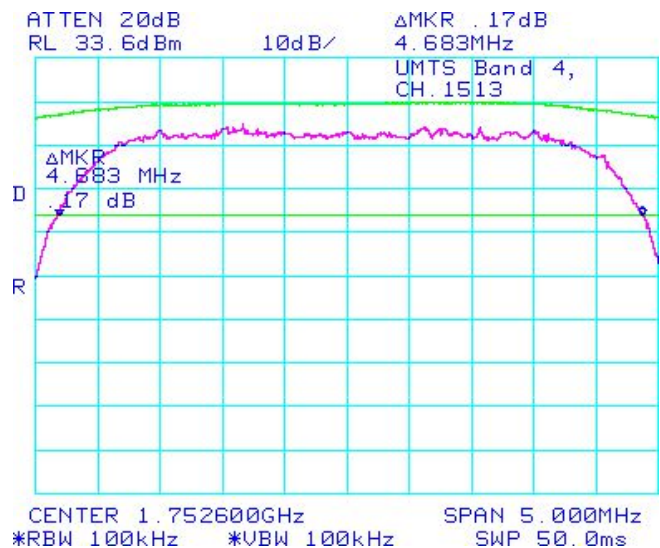



<b>Test Report No.</b> RTS-5385-1108-52A_rev1	<b>Dates of Test</b> July 26 to September 19 and November 11, 2011	FCC ID: L6AREC70UW IC ID: 2503A-REC70UW FCC ID: L6ARED70UW IC ID: 2503A-RED70UW
--	--	--

UMTS Conducted RF Emission Test Data cont'd

**Figure 1-13c: Channel Mask, Low Channel Band 4**

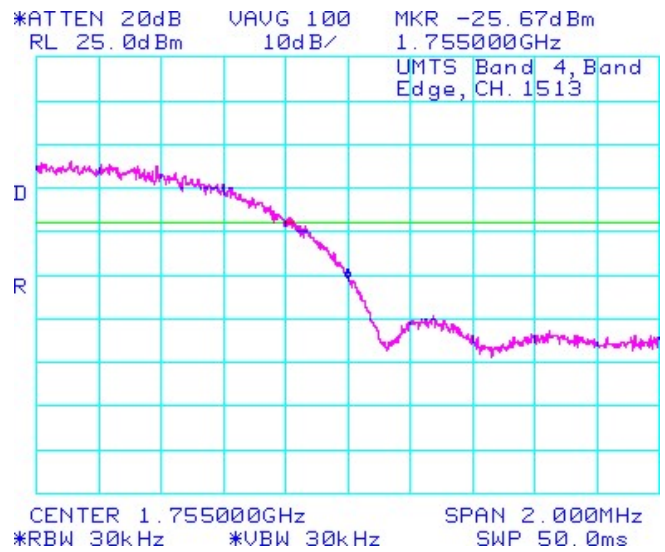
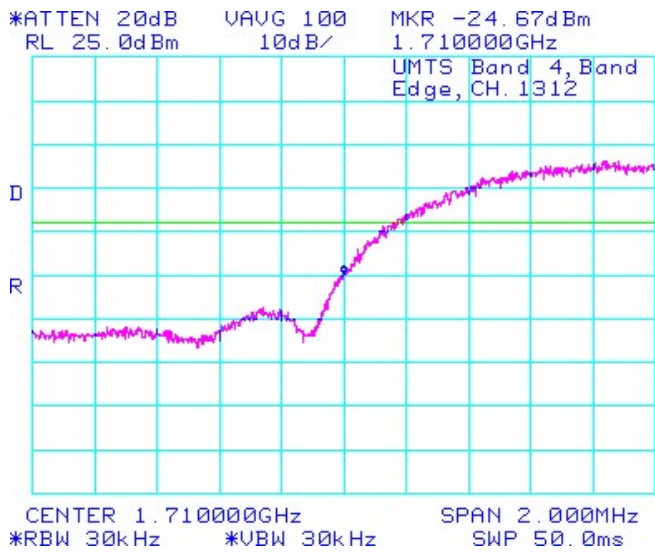
**Figure 1-14c: Channel Mask, High Channel Band 4**



	EMI Test Report for the BlackBerry® smartphone Model REC71UW, RED71UW <b>APPENDIX 2A</b>	
<b>Test Report No.</b> RTS-5385-1108-52A_rev1	<b>Dates of Test</b> July 26 to September 19 and November 11, 2011	FCC ID: L6AREC70UW IC ID: 2503A-REC70UW FCC ID: L6ARED70UW IC ID: 2503A-RED70UW

APPENDIX 2A – GSM CONDUCTED RF OUTPUT POWER TEST DATA



APPENDIX 2B – UMTS Band 2/5 CONDUCTED RF OUTPUT POWER TEST DATA





## APPENDIX 2C – UMTS Band 4 CONDUCTED RF OUTPUT POWER TEST DATA



## APPENDIX 3A – GSM FREQUENCY STABILITY TEST DATA

	EMI Test Report for the BlackBerry® smartphone Model REC71UW, RED71UW <b>APPENDIX 3A</b>	
<b>Test Report No.</b> RTS-5385-1108-52A_rev1	<b>Dates of Test</b> July 26 to September 19 and November 11, 2011	FCC ID: L6AREC70UW IC ID: 2503A-REC70UW FCC ID: L6ARED70UW IC ID: 2503A-RED70UW

### GSM Frequency Stability Test Data

The following test configurations were measured for model REC71UW:

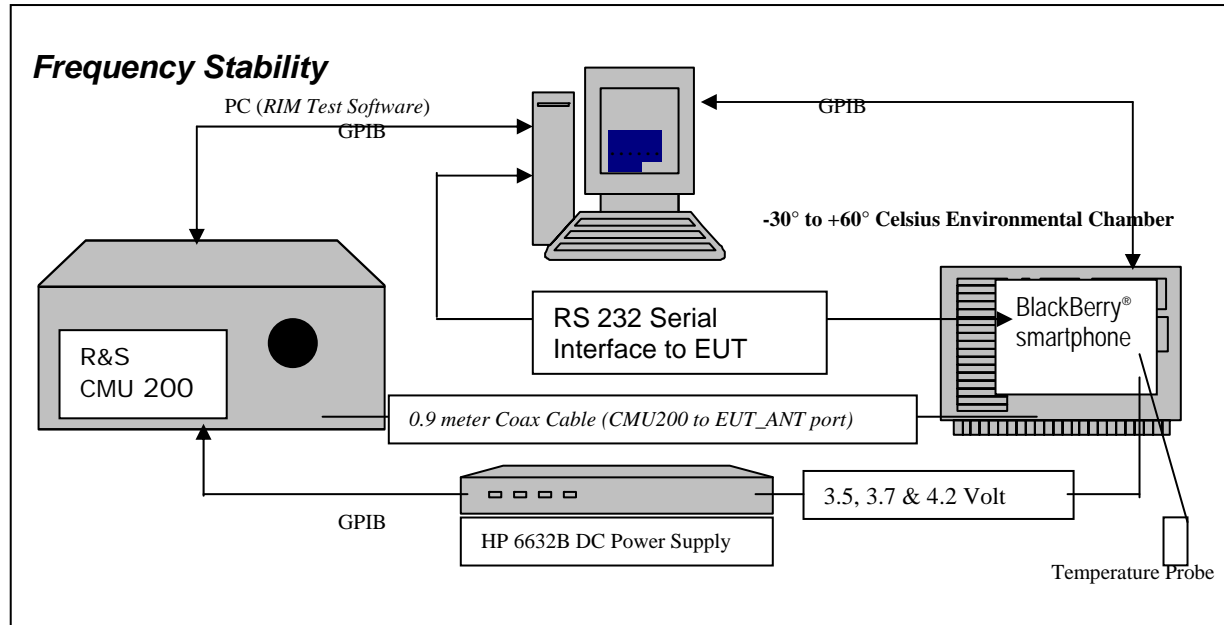

The measurements were performed by Kevin Guo.

CFR 47 Chapter 1 - Federal Communications Commission Rules

Part 2 Required Measurements

2.995 Frequency Stability - Procedures

(a,b) Frequency Stability - Temperature Variation

(d) Frequency Stability - Voltage Variation

#### **24.235/22.917** Frequency Stability.

*The frequency stability shall be sufficient to ensure that the fundamental emission stays within the authorized frequency block.*

*The EUT meets the requirements as stated in CFR 47 chapter 1, Section 24.235, CFR 47 chapter 1, Section 22.917 RSS-132, 4.3 Frequency Stability, and RSS-133, 6.3 Frequency Stability.*

Frequency Stability measurement devices were configured as presented in the block diagram recording frequency, power, data, temperatures, and stepped voltages controlled via a GPIB interface linked to the Environmental chamber, a DC power supply, and the Communications Test Set. A 0.9-metre coax cable was calibrated to characterize the insertion loss for the transmitted frequencies between the RF input/output of the CMU 200 and the EUT antenna port.

	EMI Test Report for the BlackBerry® smartphone Model REC71UW, RED71UW <b>APPENDIX 3A</b>	
<b>Test Report No.</b> RTS-5385-1108-52A_rev1	<b>Dates of Test</b> July 26 to September 19 and November 11, 2011	FCC ID: L6AREC70UW IC ID: 2503A-REC70UW FCC ID: L6ARED70UW IC ID: 2503A-RED70UW

Calibration for the Cable Loss was performed in the RF Laboratory using the Agilent power meter and Agilent Signal Generator.

**Procedure:**

The EUT was placed in the Temperature chamber and connected to CMU 200 outside as shown in the figure above. Dry air was pumped inside the temperature chamber to maintain a backpressure during the test. The EUT was kept in the off condition at all times except when the measurements were to be made.

The chamber was switched on and the temperature was set to -30°C. After the chamber stabilized at -30 °C there was a soak period of one hour to alleviate moisture in the chamber, the EUT voltage was enabled. The system software recorded the frequency, power, and associated measurements.

A Computer system controlled the automated software. This application was given the command of activating all machines intrinsic to the temperature and voltage tests controlling the CMU 200 via the GPIB Bus. The Environmental Chamber was instructed through an RS-232 serial line. The EUT dialogue was passed through a serial connection.

The EUT repetitively transmitted 100 bursts for each set of programmed parameters recording temperature, voltage settings, and systematically selected frequencies. The power supply was cycled from minimum voltage 3.6 volts, to 3.7 volts to 4.2 volts maximum voltage. The frequency error was measured at a maximum output power and recorded by the automated system test software.

The EUT output power and frequency was measured at 3.6 volts, 3.7 volts and 4.2 volts. The transmit frequency was varied in 3 steps consisting of 824.2, 836.4, and 848.8 MHz for the GSM850 band, 1850.2, 1880.0 and 1909.8 MHz for the PCS1900 band. This frequency was recorded in MHz and deviation from nominal, in Parts Per Million. After the initial one-hour soak at the beginning of the tests, a period of thirty minutes soak was initialized between each ascending temperature step, before proceeding to the next measurement test cycle.

	EMI Test Report for the BlackBerry® smartphone Model REC71UW, RED71UW <b>APPENDIX 3A</b>	
<b>Test Report No.</b> RTS-5385-1108-52A_rev1	<b>Dates of Test</b> July 26 to September 19 and November 11, 2011	FCC ID: L6AREC70UW IC ID: 2503A-REC70UW FCC ID: L6ARED70UW IC ID: 2503A-RED70UW

**PROCEDURE:**

The test system software for commencing the Frequency Stability Tests carried through the following cycle.

1. Switch on the HP 6632B power supply; CMU 200 Communications test Set, and Environmental Chamber.
2. Start test program
3. Set the Temperature to –30°C and maintain a period of one- hour soak time, with the EUT supply voltage disabled.
4. Set power supply voltage to 3.6 volts.
5. Set up CMU 200 Radio Communication Tester.
6. Command the CMU 200 to switch to the low channel.
7. Enable the voltage to the EUT, and connect a link to the CMU 200 test set.
8. EUT is commanded to Transmit 100 Bursts.
9. Software logs the following data from the CMU 200, power supply and temperature chamber: Traffic Channel Number, Traffic Channel Frequency, Power Level, Chamber Temperature, Supply Voltage, Power and Frequency Error.
10. The CMU 200 commands the EUT to change frequency to the middle channel and high channel and repeats steps 7 to 9.
11. Repeat steps 5 to 10 changing the supply voltage to 3.7 Volts
12. Increase temperature by 10°C and soak for 1/2 hour.
13. Repeat steps 4 - 12 for temperatures –30°C to 60°C.
14. Repeat steps 5 to 10 changing the supply voltage to 4.2 volts

Procedure 5 to 10 was repeated at room temperature (20°C) with the power supply voltage set to 3.6, 3.7 and 4.2 volts.

The maximum frequency error in the GSM850 band measured was **-0.0271 PPM**.

The maximum frequency error in the PCS1900 band measured was **-0.0503 PPM**.



<b>Test Report No.</b> RTS-5385-1108-52A_rev1	<b>Dates of Test</b> July 26 to September 19 and November 11, 2011	FCC ID: L6AREC70UW IC ID: 2503A-REC70UW FCC ID: L6ARED70UW IC ID: 2503A-RED70UW
--	--	--

GSM850 Channel results: channels 128, 189 and 251 @ 20°C maximum transmitted power

Traffic Channel Number	GSM850 Frequency (MHz)	Voltage (Volts)	Temperature (Celsius)	Frequency Error (Hz)	PPM
128	824.20	3.6	20	-11	-0.0133
189	836.40	3.6	20	13	0.0155
251	848.60	3.6	20	12	0.0141

Traffic Channel Number	GSM850 Frequency (MHz)	Voltage (Volts)	Temperature (Celsius)	Frequency Error (Hz)	PPM
128	824.20	3.7	20	10	0.0121
189	836.40	3.7	20	7	0.0084
251	848.60	3.7	20	8	0.0094

Traffic Channel Number	GSM850 Frequency (MHz)	Voltage (Volts)	Temperature (Celsius)	Frequency Error (Hz)	PPM
128	824.20	4.2	20	9	0.0109
189	836.40	4.2	20	11	0.0132
251	848.60	4.2	20	8	0.0094





**Test Report No.**  
 RTS-5385-1108-52A\_rev1

**Dates of Test**  
 July 26 to September 19 and  
 November 11, 2011

FCC ID: L6AREC70UW IC ID: 2503A-REC70UW  
 FCC ID: L6ARED70UW IC ID: 2503A-RED70UW

**GSM850 Results: channel 128 @ maximum transmitted power**

Traffic Channel Number	Frequency (MHz)	Voltage (Volts)	Temperature (Celsius)	Frequency Error (Hz)	PPM
128	824.20	3.6	-30	-11	-0.0133
128	824.20	3.6	-20	10	0.0121
128	824.20	3.6	-10	-10	-0.0121
128	824.20	3.6	0	10	0.0121
128	824.20	3.6	10	9	0.0109
128	824.20	3.6	20	-11	-0.0133
128	824.20	3.6	30	9	0.0109
128	824.20	3.6	40	-10	-0.0121
128	824.20	3.6	50	-4	-0.0049
128	824.20	3.6	60	4	0.0049

Traffic Channel Number	Frequency (MHz)	Voltage (Volts)	Temperature (Celsius)	Frequency Error (Hz)	PPM
128	824.20	3.7	-30	-12	-0.0146
128	824.20	3.7	-20	-6	-0.0073
128	824.20	3.7	-10	10	0.0121
128	824.20	3.7	0	11	0.0133
128	824.20	3.7	10	12	0.0146
128	824.20	3.7	20	10	0.0121
128	824.20	3.7	30	6	0.0073
128	824.20	3.7	40	8	0.0097
128	824.20	3.7	50	-7	-0.0091
128	824.20	3.7	60	5	0.0061

Traffic Channel Number	Frequency (MHz)	Voltage (Volts)	Temperature (Celsius)	Frequency Error (Hz)	PPM
128	824.20	4.2	-30	-20	-0.0243
128	824.20	4.2	-20	-7	-0.0085
128	824.20	4.2	-10	20	0.0243
128	824.20	4.2	0	5	0.0061
128	824.20	4.2	10	11	0.0133
128	824.20	4.2	20	9	0.0109
128	824.20	4.2	30	-7	-0.0085
128	824.20	4.2	40	8	0.0097
128	824.20	4.2	50	9	0.0109
128	824.20	4.2	60	5	0.0061



<b>Test Report No.</b> RTS-5385-1108-52A_rev1	<b>Dates of Test</b> July 26 to September 19 and November 11, 2011	FCC ID: L6AREC70UW IC ID: 2503A-REC70UW FCC ID: L6ARED70UW IC ID: 2503A-RED70UW
--	--	--

GSM850 Results: channel 189 @ maximum transmitted power

Traffic Channel Number	Frequency (MHz)	Voltage (Volts)	Temperature (Celsius)	Frequency Error (Hz)	PPM
189	836.40	3.6	-30	-6	-0.0072
189	836.40	3.6	-20	9	0.0108
189	836.40	3.6	-10	7	0.0084
189	836.40	3.6	0	7	0.0084
189	836.40	3.6	10	9	0.0108
189	836.40	3.6	20	13	0.0155
189	836.40	3.6	30	-11	-0.0132
189	836.40	3.6	40	7	0.0084
189	836.40	3.6	50	4	0.0048
189	836.40	3.6	60	6	0.0072

Traffic Channel Number	Frequency (MHz)	Voltage (Volts)	Temperature (Celsius)	Frequency Error (Hz)	PPM
189	836.40	3.7	-30	-5	-0.0060
189	836.40	3.7	-20	11	0.0132
189	836.40	3.7	-10	8	0.0096
189	836.40	3.7	0	13	0.0155
189	836.40	3.7	10	11	0.0132
189	836.40	3.7	20	7	0.0084
189	836.40	3.7	30	-10	-0.0120
189	836.40	3.7	40	9	0.0108
189	836.40	3.7	50	-7	-0.0084
189	836.40	3.7	60	7	0.0084

Traffic Channel Number	Frequency (MHz)	Voltage (Volts)	Temperature (Celsius)	Frequency Error (Hz)	PPM
189	836.40	4.2	-30	-16	-0.0191
189	836.40	4.2	-20	6	0.0072
189	836.40	4.2	-10	12	0.0143
189	836.40	4.2	0	15	0.0179
189	836.40	4.2	10	12	0.0143
189	836.40	4.2	20	11	0.0132
189	836.40	4.2	30	-8	-0.0096
189	836.40	4.2	40	8	0.0096
189	836.40	4.2	50	8	0.0096
189	836.40	4.2	60	-7	-0.0084



<b>Test Report No.</b> RTS-5385-1108-52A_rev1	<b>Dates of Test</b> July 26 to September 19 and November 11, 2011	FCC ID: L6AREC70UW IC ID: 2503A-REC70UW FCC ID: L6ARED70UW IC ID: 2503A-RED70UW
--	--	--

GSM850 Results: channel 251 @ maximum transmitted power

Traffic Channel Number	Frequency (MHz)	Voltage (Volts)	Temperature (Celsius)	Frequency Error (Hz)	PPM
251	848.8	3.6	-30	-11	-0.0130
251	848.8	3.6	-20	10	0.0118
251	848.8	3.6	-10	15	0.0177
251	848.8	3.6	0	10	0.0118
251	848.8	3.6	10	7	0.0082
251	848.8	3.6	20	12	0.0141
251	848.8	3.6	30	-7	-0.0082
251	848.8	3.6	40	12	0.0141
251	848.8	3.6	50	9	0.0106
251	848.8	3.6	60	5	0.0059

Traffic Channel Number	Frequency (MHz)	Voltage (Volts)	Temperature (Celsius)	Frequency Error (Hz)	PPM
251	848.8	3.7	-30	-10	-0.0118
251	848.8	3.7	-20	6	0.0071
251	848.8	3.7	-10	14	0.0165
251	848.8	3.7	0	12	0.0141
251	848.8	3.7	10	8	0.0100
251	848.8	3.7	20	8	0.0094
251	848.8	3.7	30	-7	-0.0082
251	848.8	3.7	40	10	0.0118
251	848.8	3.7	50	4	0.0047
251	848.8	3.7	60	4	0.0047

Traffic Channel Number	Frequency (MHz)	Voltage (Volts)	Temperature (Celsius)	Frequency Error (Hz)	PPM
251	848.8	4.2	-30	-23	<b>-0.0271</b>
251	848.8	4.2	-20	10	0.0118
251	848.8	4.2	-10	11	0.0130
251	848.8	4.2	0	10	0.0118
251	848.8	4.2	10	10	0.0118
251	848.8	4.2	20	8	0.0094
251	848.8	4.2	30	-11	-0.0130
251	848.8	4.2	40	-11	-0.0130
251	848.8	4.2	50	5	0.0059
251	848.8	4.2	60	3	0.0035



**Test Report No.**  
RTS-5385-1108-52A\_rev1

**Dates of Test**  
July 26 to September 19 and  
November 11, 2011

FCC ID: L6AREC70UW IC ID: 2503A-REC70UW  
FCC ID: L6ARED70UW IC ID: 2503A-RED70UW

PCS Channel results: channels 512, 661, & 810 @ 20°C maximum transmitted power

Traffic Channel Number	PCS Frequency (MHz)	Voltage (Volts)	Temperature (Celsius)	Frequency Error (Hz)	PPM
512	1850.20	3.6	20	20	0.0108
661	1880.00	3.6	20	23	0.0122
810	1909.80	3.6	20	22	0.0115

Traffic Channel Number	PCS Frequency (MHz)	Voltage (Volts)	Temperature (Celsius)	Frequency Error (Hz)	PPM
512	1850.20	3.7	20	28	0.0151
661	1880.00	3.7	20	27	0.0144
810	1909.80	3.7	20	21	0.0110

Traffic Channel Number	PCS Frequency (MHz)	Voltage (Volts)	Temperature (Celsius)	Frequency Error (Hz)	PPM
512	1850.20	4.2	20	21	0.0114
661	1880.00	4.2	20	29	0.0154
810	1909.80	4.2	20	19	0.0099



<b>Test Report No.</b> RTS-5385-1108-52A_rev1	<b>Dates of Test</b> July 26 to September 19 and November 11, 2011	FCC ID: L6AREC70UW IC ID: 2503A-REC70UW FCC ID: L6ARED70UW IC ID: 2503A-RED70UW
--	--	--

PCS1900 Results: channel 512 @ maximum transmitted power

Traffic Channel Number	Frequency (MHz)	Voltage (Volts)	Temperature (Celsius)	Frequency Error (Hz)	PPM
512	1850.20	3.6	-30	17	0.0092
512	1850.20	3.6	-20	-18	-0.0097
512	1850.20	3.6	-10	26	0.0141
512	1850.20	3.6	0	22	0.0119
512	1850.20	3.6	10	31	0.0168
512	1850.20	3.6	20	20	0.0108
512	1850.20	3.6	30	18	0.0097
512	1850.20	3.6	40	-27	-0.0146
512	1850.20	3.6	50	-44	-0.0238
512	1850.20	3.6	60	-79	-0.0427

Traffic Channel Number	Frequency (MHz)	Voltage (Volts)	Temperature (Celsius)	Frequency Error (Hz)	PPM
512	1850.20	3.7	-30	10	0.0054
512	1850.20	3.7	-20	-27	-0.0146
512	1850.20	3.7	-10	21	0.0114
512	1850.20	3.7	0	20	0.0108
512	1850.20	3.7	10	29	0.0157
512	1850.20	3.7	20	28	0.0151
512	1850.20	3.7	30	23	0.0124
512	1850.20	3.7	40	38	0.0205
512	1850.20	3.7	50	-49	-0.0265
512	1850.20	3.7	60	-81	-0.0438

Traffic Channel Number	Frequency (MHz)	Voltage (Volts)	Temperature (Celsius)	Frequency Error (Hz)	PPM
512	1850.20	4.2	-30	16	0.0086
512	1850.20	4.2	-20	-21	-0.0114
512	1850.20	4.2	-10	25	0.0135
512	1850.20	4.2	0	21	0.0114
512	1850.20	4.2	10	37	0.0200
512	1850.20	4.2	20	21	0.0114
512	1850.20	4.2	30	27	0.0146
512	1850.20	4.2	40	33	0.0178
512	1850.20	4.2	50	-50	-0.0270
512	1850.20	4.2	60	-93	<b>-0.0503</b>



<b>Test Report No.</b> RTS-5385-1108-52A_rev1	<b>Dates of Test</b> July 26 to September 19 and November 11, 2011	FCC ID: L6AREC70UW IC ID: 2503A-REC70UW FCC ID: L6ARED70UW IC ID: 2503A-RED70UW
--	--	--

PCS1900 Results: channel 661 @ maximum transmitted power

Traffic Channel Number	Frequency (MHz)	Voltage (Volts)	Temperature (Celsius)	Frequency Error (Hz)	PPM
661	1880.00	3.6	-30	19	0.0101
661	1880.00	3.6	-20	-26	-0.0138
661	1880.00	3.6	-10	27	0.0144
661	1880.00	3.6	0	28	0.0149
661	1880.00	3.6	10	20	0.0106
661	1880.00	3.6	20	23	0.0122
661	1880.00	3.6	30	28	0.0149
661	1880.00	3.6	40	31	0.0165
661	1880.00	3.6	50	-60	-0.0319
661	1880.00	3.6	60	-81	-0.0431

Traffic Channel Number	Frequency (MHz)	Voltage (Volts)	Temperature (Celsius)	Frequency Error (Hz)	PPM
661	1880.00	3.7	-30	26	0.0138
661	1880.00	3.7	-20	-21	-0.0112
661	1880.00	3.7	-10	20	0.0106
661	1880.00	3.7	0	29	0.0154
661	1880.00	3.7	10	24	0.0128
661	1880.00	3.7	20	27	0.0144
661	1880.00	3.7	30	21	0.0112
661	1880.00	3.7	40	24	0.0128
661	1880.00	3.7	50	-78	-0.0415
661	1880.00	3.7	60	-82	-0.0436

Traffic Channel Number	Frequency (MHz)	Voltage (Volts)	Temperature (Celsius)	Frequency Error (Hz)	PPM
661	1880.00	4.2	-30	-16	-0.0085
661	1880.00	4.2	-20	20	0.0106
661	1880.00	4.2	-10	31	0.0165
661	1880.00	4.2	0	22	0.0117
661	1880.00	4.2	10	27	0.0144
661	1880.00	4.2	20	29	0.0154
661	1880.00	4.2	30	22	0.0117
661	1880.00	4.2	40	25	0.0133
661	1880.00	4.2	50	-62	-0.0330
661	1880.00	4.2	60	-91	-0.0484



<b>Test Report No.</b> RTS-5385-1108-52A_rev1	<b>Dates of Test</b> July 26 to September 19 and November 11, 2011	FCC ID: L6AREC70UW IC ID: 2503A-REC70UW FCC ID: L6ARED70UW IC ID: 2503A-RED70UW
--	--	--

PCS1900 Results: channel 810 @ maximum transmitted power

Traffic Channel Number	Frequency (MHz)	Voltage (Volts)	Temperature (Celsius)	Frequency Error (Hz)	20BPPM
810	1909.80	3.6	-30	20	0.0105
810	1909.80	3.6	-20	18	0.0094
810	1909.80	3.6	-10	24	0.0126
810	1909.80	3.6	0	27	0.0141
810	1909.80	3.6	10	26	0.0136
810	1909.80	3.6	20	22	0.0115
810	1909.80	3.6	30	25	0.0131
810	1909.80	3.6	40	30	0.0157
810	1909.80	3.6	50	-49	-0.0257
810	1909.80	3.6	60	-93	-0.0487

Traffic Channel Number	Frequency (MHz)	Voltage (Volts)	Temperature (Celsius)	Frequency Error (Hz)	PPM
810	1909.80	3.7	-30	-13	-0.0068
810	1909.80	3.7	-20	23	0.0120
810	1909.80	3.7	-10	23	0.0120
810	1909.80	3.7	0	20	0.0105
810	1909.80	3.7	10	25	0.0131
810	1909.80	3.7	20	21	0.0110
810	1909.80	3.7	30	26	0.0136
810	1909.80	3.7	40	28	0.0147
810	1909.80	3.7	50	-72	-0.0377
810	1909.80	3.7	60	-67	-0.0351

Traffic Channel Number	Frequency (MHz)	Voltage (Volts)	Temperature (Celsius)	Frequency Error (Hz)	PPM
810	1909.80	4.2	-30	-17	-0.0089
810	1909.80	4.2	-20	19	0.0099
810	1909.80	4.2	-10	20	0.0105
810	1909.80	4.2	0	28	0.0147
810	1909.80	4.2	10	27	0.0141
810	1909.80	4.2	20	19	0.0099
810	1909.80	4.2	30	24	0.0126
810	1909.80	4.2	40	-29	-0.0152
810	1909.80	4.2	50	-51	-0.0267
810	1909.80	4.2	60	-82	-0.0429

## APPENDIX 3B – UMTS Band 2/5 FREQUENCY STABILITY TEST DATA



	EMI Test Report for the BlackBerry® smartphone Model REC71UW, RED71UW <b>APPENDIX 3B</b>	
<b>Test Report No.</b> RTS-5385-1108-52A_rev1	<b>Dates of Test</b> July 26 to September 19 and November 11, 2011	FCC ID: L6AREC70UW IC ID: 2503A-REC70UW FCC ID: L6ARED70UW IC ID: 2503A-RED70UW

### UMTS Frequency Stability Test Data

The following test configurations were measured for model REC71UW:

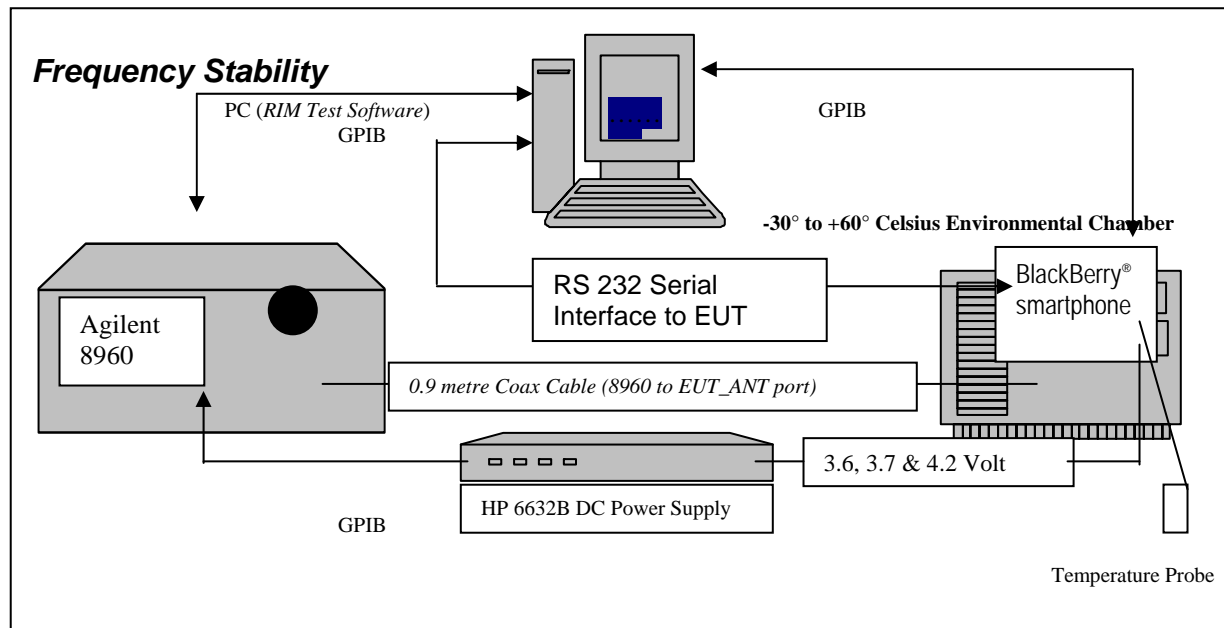

The following measurements were performed by Kevin Guo.

CFR 47 Chapter 1 - Federal Communications Commission Rules

Part 2 Required Measurements

- 2.1055** Frequency Stability - Procedures
- (a,b) Frequency Stability - Temperature Variation
- (d) Frequency Stability - Voltage Variation

**24.235** *Frequency Stability.*

*The frequency stability shall be sufficient to ensure that the fundamental emission stays within the authorized frequency block.*

*The EUT meets the requirements as stated in CFR 47 chapter 1, Section 27.54, CFR 47 and RSS-139, 6.3 Frequency Stability.*

Frequency Stability measurement devices were configured as presented in the block diagram recording frequency, power, data, temperatures, and stepped voltages controlled via a GPIB interface linked to the Environmental chamber, a DC power supply, and the Communications Test Set. A 0.9-metre coax cable was calibrated to characterize the insertion loss for the transmitted frequencies between the RF input/output of the CMU 200 and the EUT antenna port.

	EMI Test Report for the BlackBerry® smartphone Model REC71UW, RED71UW <b>APPENDIX 3B</b>	
<b>Test Report No.</b> RTS-5385-1108-52A_rev1	<b>Dates of Test</b> July 26 to September 19 and November 11, 2011	FCC ID: L6AREC70UW IC ID: 2503A-REC70UW FCC ID: L6ARED70UW IC ID: 2503A-RED70UW

**Procedure:**

The EUT was placed in the Temperature chamber and connected to CMU 200 outside as shown in the figure above. Dry air was pumped inside the temperature chamber to maintain a backpressure during the test. The EUT was kept in the off condition at all times except when the following measurements were to be made.

The chamber was switched on and the temperature was set to -30°C. After the chamber stabilized at -30 °C there was a soak period of one hour to alleviate moisture in the chamber, the EUT voltage was enabled. The system software recorded the frequency, power, and associated measurements.

A Computer system controlled the automated software. This application was given the command of activating all machines intrinsic to the temperature and voltage tests controlling the CMU 200 via the GPIB Bus. The Environmental Chamber was instructed through an RS-232 serial line. The EUT dialogue was passed through a serial connection.

The EUT repetitively transmitted 100 bursts for each set of programmed parameters recording temperature, voltage settings, and systematically selected frequencies. The power supply was cycled from minimum voltage 3.6 volts, to 3.7 volts to 4.2 volts maximum voltage. The frequency error was measured at a maximum output power and recorded by the automated system test software.

The EUT output power and frequency was measured at 3.6 volts, 3.7 volts and 4.2 volts. The transmit frequency was varied in 3 steps consisting of 1852.4, 1880.0 and 1907.6 MHz for the UMTS band 2. This frequency was recorded in MHz and deviation from nominal, in Parts Per Million.

After the initial one-hour soak at the beginning of the tests, a period of thirty minutes soak was initialized between each ascending temperature step, before proceeding to the next measurement test cycle.

	EMI Test Report for the BlackBerry® smartphone Model REC71UW, RED71UW <b>APPENDIX 3B</b>	
<b>Test Report No.</b> RTS-5385-1108-52A_rev1	<b>Dates of Test</b> July 26 to September 19 and November 11, 2011	FCC ID: L6AREC70UW IC ID: 2503A-REC70UW FCC ID: L6ARED70UW IC ID: 2503A-RED70UW

**PROCEDURE:**

The test system software for commencing the Frequency Stability Tests carried through the following cycle.

1. Switch on the HP 6632B power supply; CMU 200 Communications test Set, and Environmental Chamber.
2. Start test program
3. Set the Temperature to –30°C and maintain a period of one- hour soak time, with the EUT supply voltage disabled.
4. Set power supply voltage to 3.6 volts.
5. Set up CMU 200 Radio Communication Tester.
6. Command the CMU 200 to switch to the low channel.
7. Enable the voltage to the EUT, and connect a link to the CMU 200 test set.
8. EUT is commanded to Transmit 100 Bursts.
9. Software logs the following data from the CMU 200, power supply and temperature chamber: Traffic Channel Number, Traffic Channel Frequency, Power Level, Chamber Temperature, Supply Voltage, Power and Frequency Error.
10. The CMU 200 commands the EUT to change frequency to the middle channel and high channel and repeats steps 7 to 9.
11. Repeat steps 5 to 10 changing the supply voltage to 3.7 Volts
12. Increase temperature by 10°C and soak for 1/2 hour.
13. Repeat steps 4 - 12 for temperatures –30°C to 60°C.
14. Repeat steps 5 to 10 changing the supply voltage to 4.2 volts

Procedure 5 to 10 was repeated at room temperature (20°C) with the power supply voltage set to 3.6, 3.7 and 4.2 volts

The maximum frequency error in the UMTS band 5 measured was **-0.0424 PPM**.  
The maximum frequency error in the UMTS band 2 measured was **-0.0183 PPM**.

**Test Report No.**  
 RTS-5385-1108-52A\_rev1

**Dates of Test**  
 July 26 to September 19 and  
 November 11, 2011

FCC ID: L6AREC70UW IC ID: 2503A-REC70UW  
 FCC ID: L6ARED70UW IC ID: 2503A-RED70UW

UMTS Band 5 Channel results: channels 4132, 4182 and 4233 @ 20°C maximum transmitted power

Traffic Channel Number	UMTS band 5 Frequency (MHz)	Voltage (Volts)	Temperature (Celsius)	Frequency Error (Hz)	PPM
4132	826.4	3.6	20	15	0.0182
4182	836.4	3.6	20	19	0.0227
4233	846.6	3.6	20	27	0.0319

Traffic Channel Number	UMTS band 5 Frequency (MHz)	Voltage (Volts)	Temperature (Celsius)	Frequency Error (Hz)	PPM
4132	826.4	3.7	20	-24	-0.0290
4182	836.4	3.7	20	-16	-0.0191
4233	846.6	3.7	20	-27	-0.0319

Traffic Channel Number	UMTS band 5 Frequency (MHz)	Voltage (Volts)	Temperature (Celsius)	Frequency Error (Hz)	PPM
4132	826.4	4.2	20	26	0.0315
4182	836.4	4.2	20	12	0.0143
4233	846.6	4.2	20	-17	-0.0201



**Test Report No.**  
 RTS-5385-1108-52A\_rev1

**Dates of Test**  
 July 26 to September 19 and  
 November 11, 2011

FCC ID: L6AREC70UW IC ID: 2503A-REC70UW  
 FCC ID: L6ARED70UW IC ID: 2503A-RED70UW

UMTS band 5 Results: channel 4132 @ maximum transmitted power

Traffic Channel Number	Frequency (MHz)	Voltage (Volts)	Temperature (Celsius)	Frequency Error (Hz)	PPM
4132	826.4	3.6	-30	18	0.0218
4132	826.4	3.6	-20	-15	-0.0182
4132	826.4	3.6	-10	-24	-0.0290
4132	826.4	3.6	0	-23	-0.0278
4132	826.4	3.6	10	-19	-0.0230
4132	826.4	3.6	20	15	0.0182
4132	826.4	3.6	30	19	0.0230
4132	826.4	3.6	40	-15	-0.0182
4132	826.4	3.6	50	18	0.0218
4132	826.4	3.6	60	-26	-0.0315

Traffic Channel Number	Frequency (MHz)	Voltage (Volts)	Temperature (Celsius)	Frequency Error (Hz)	PPM
4132	826.4	3.7	-30	10	0.0121
4132	826.4	3.7	-20	-12	-0.0145
4132	826.4	3.7	-10	-34	-0.0411
4132	826.4	3.7	0	-21	-0.0254
4132	826.4	3.7	10	21	0.0254
4132	826.4	3.7	20	-24	-0.0290
4132	826.4	3.7	30	-13	-0.0157
4132	826.4	3.7	40	18	0.0218
4132	826.4	3.7	50	-24	-0.0290
4132	826.4	3.7	60	-35	<b>-0.0424</b>

Traffic Channel Number	Frequency (MHz)	Voltage (Volts)	Temperature (Celsius)	Frequency Error (Hz)	PPM
4132	826.4	4.2	-30	11	0.0133
4132	826.4	4.2	-20	19	0.0230
4132	826.4	4.2	-10	29	0.0351
4132	826.4	4.2	0	13	0.0157
4132	826.4	4.2	10	17	0.0206
4132	826.4	4.2	20	26	0.0315
4132	826.4	4.2	30	-16	-0.0194
4132	826.4	4.2	40	-13	-0.0157
4132	826.4	4.2	50	11	0.0133
4132	826.4	4.2	60	16	0.0194



**Test Report No.**  
 RTS-5385-1108-52A\_rev1

**Dates of Test**  
 July 26 to September 19 and  
 November 11, 2011

FCC ID: L6AREC70UW IC ID: 2503A-REC70UW  
 FCC ID: L6ARED70UW IC ID: 2503A-RED70UW

UMTS band 5 Results: channel 4182 @ maximum transmitted power

Traffic Channel Number	Frequency (MHz)	Voltage (Volts)	Temperature (Celsius)	Frequency Error (Hz)	PPM
4182	836.4	3.6	-30	12	0.0143
4182	836.4	3.6	-20	19	0.0227
4182	836.4	3.6	-10	15	0.0179
4182	836.4	3.6	0	-14	-0.0167
4182	836.4	3.6	10	17	0.0203
4182	836.4	3.6	20	19	0.0227
4182	836.4	3.6	30	25	0.0299
4182	836.4	3.6	40	17	0.0203
4182	836.4	3.6	50	16	0.0191
4182	836.4	3.6	60	-24	-0.0287

Traffic Channel Number	Frequency (MHz)	Voltage (Volts)	Temperature (Celsius)	Frequency Error (Hz)	PPM
4182	836.4	3.7	-30	15	0.0179
4182	836.4	3.7	-20	-12	-0.0143
4182	836.4	3.7	-10	-25	-0.0299
4182	836.4	3.7	0	29	0.0347
4182	836.4	3.7	10	24	0.0287
4182	836.4	3.7	20	-16	-0.0191
4182	836.4	3.7	30	32	0.0383
4182	836.4	3.7	40	24	0.0287
4182	836.4	3.7	50	-24	-0.0287
4182	836.4	3.7	60	15	0.0179

Traffic Channel Number	Frequency (MHz)	Voltage (Volts)	Temperature (Celsius)	Frequency Error (Hz)	PPM
4182	836.4	4.2	-30	13	0.0155
4182	836.4	4.2	-20	16	0.0191
4182	836.4	4.2	-10	13	0.0155
4182	836.4	4.2	0	29	0.0347
4182	836.4	4.2	10	-11	-0.0132
4182	836.4	4.2	20	12	0.0143
4182	836.4	4.2	30	9	0.0108
4182	836.4	4.2	40	-12	-0.0143
4182	836.4	4.2	50	-14	-0.0167
4182	836.4	4.2	60	15	0.0179



**Test Report No.**  
RTS-5385-1108-52A\_rev1

**Dates of Test**  
July 26 to September 19 and  
November 11, 2011

FCC ID: L6AREC70UW IC ID: 2503A-REC70UW  
FCC ID: L6ARED70UW IC ID: 2503A-RED70UW

UMTS band 5 Results: channel 4233 @ maximum transmitted power

Traffic Channel Number	Frequency (MHz)	Voltage (Volts)	Temperature (Celsius)	Frequency Error (Hz)	PPM
4233	846.6	3.6	-30	13	0.0154
4233	846.6	3.6	-20	13	0.0154
4233	846.6	3.6	-10	20	0.0236
4233	846.6	3.6	0	16	0.0189
4233	846.6	3.6	10	23	0.0272
4233	846.6	3.6	20	27	0.0319
4233	846.6	3.6	30	-16	-0.0189
4233	846.6	3.6	40	-18	-0.0213
4233	846.6	3.6	50	31	0.0366
4233	846.6	3.6	60	5	0.0059

Traffic Channel Number	Frequency (MHz)	Voltage (Volts)	Temperature (Celsius)	Frequency Error (Hz)	PPM
4233	846.6	3.7	-30	10	0.0118
4233	846.6	3.7	-20	17	0.0201
4233	846.6	3.7	-10	18	0.0213
4233	846.6	3.7	0	29	0.0343
4233	846.6	3.7	10	19	0.0224
4233	846.6	3.7	20	-27	-0.0319
4233	846.6	3.7	30	26	0.0307
4233	846.6	3.7	40	-25	-0.0295
4233	846.6	3.7	50	-13	-0.0154
4233	846.6	3.7	60	-14	-0.0165

Traffic Channel Number	Frequency (MHz)	Voltage (Volts)	Temperature (Celsius)	Frequency Error (Hz)	PPM
4233	846.6	4.2	-30	10	0.0118
4233	846.6	4.2	-20	18	0.0213
4233	846.6	4.2	-10	23	0.0272
4233	846.6	4.2	0	24	0.0283
4233	846.6	4.2	10	-15	-0.0177
4233	846.6	4.2	20	-17	-0.0201
4233	846.6	4.2	30	7	0.0083
4233	846.6	4.2	40	-17	-0.0201
4233	846.6	4.2	50	-15	-0.0177
4233	846.6	4.2	60	18	0.0213

**Test Report No.**  
 RTS-5385-1108-52A\_rev1

**Dates of Test**  
 July 26 to September 19 and  
 November 11, 2011

FCC ID: L6AREC70UW IC ID: 2503A-REC70UW  
 FCC ID: L6ARED70UW IC ID: 2503A-RED70UW

UMTS band 2 Channel results: channels 9262, 9400, & 9538 @ 20°C maximum transmitted power

Traffic Channel Number	UMTS1900 Frequency (MHz)	Voltage (Volts)	Temperature (Celsius)	Frequency Error (Hz)	PPM
9262	1852.40	3.6	20	23	0.0124
9400	1880.00	3.6	20	27	0.0144
9538	1907.60	3.6	20	18	0.0094

Traffic Channel Number	UMTS1900 Frequency (MHz)	Voltage (Volts)	Temperature (Celsius)	Frequency Error (Hz)	PPM
9262	1852.40	3.7	20	-15	-0.0081
9400	1880.00	3.7	20	-19	-0.0101
9538	1907.60	3.7	20	-35	-0.0183

Traffic Channel Number	UMTS1900 Frequency (MHz)	Voltage (Volts)	Temperature (Celsius)	Frequency Error (Hz)	PPM
9262	1852.40	4.2	20	-15	-0.0081
9400	1880.00	4.2	20	-27	-0.0144
9538	1907.60	4.2	20	-31	-0.0163





**Test Report No.**  
 RTS-5385-1108-52A\_rev1

**Dates of Test**  
 July 26 to September 19 and  
 November 11, 2011

FCC ID: L6AREC70UW IC ID: 2503A-REC70UW  
 FCC ID: L6ARED70UW IC ID: 2503A-RED70UW

UMTS band 2 Results: channel 9262 @ maximum transmitted power

Traffic Channel Number	Frequency (MHz)	Voltage (Volts)	Temperature (Celsius)	Frequency Error (Hz)	PPM
9262	1852.40	3.6	-30	-18	-0.0097
9262	1852.40	3.6	-20	-21	-0.0113
9262	1852.40	3.6	-10	-20	-0.0108
9262	1852.40	3.6	0	-28	-0.0151
9262	1852.40	3.6	10	-15	-0.0081
9262	1852.40	3.6	20	23	0.0124
9262	1852.40	3.6	30	-29	-0.0157
9262	1852.40	3.6	40	13	0.0070
9262	1852.40	3.6	50	11	0.0059
9262	1852.40	3.6	60	-20	-0.0108

Traffic Channel Number	Frequency (MHz)	Voltage (Volts)	Temperature (Celsius)	Frequency Error (Hz)	PPM
9262	1852.40	3.7	-30	-13	-0.0070
9262	1852.40	3.7	-20	17	0.0092
9262	1852.40	3.7	-10	22	0.0119
9262	1852.40	3.7	0	-26	-0.0140
9262	1852.40	3.7	10	24	0.0130
9262	1852.40	3.7	20	-15	-0.0081
9262	1852.40	3.7	30	-28	-0.0151
9262	1852.40	3.7	40	-26	-0.0140
9262	1852.40	3.7	50	14	0.0076
9262	1852.40	3.7	60	-9	-0.0049

Traffic Channel Number	Frequency (MHz)	Voltage (Volts)	Temperature (Celsius)	Frequency Error (Hz)	PPM
9262	1852.40	4.2	-30	-20	-0.0108
9262	1852.40	4.2	-20	11	0.0059
9262	1852.40	4.2	-10	27	0.0146
9262	1852.40	4.2	0	-13	-0.0070
9262	1852.40	4.2	10	-17	-0.0092
9262	1852.40	4.2	20	-15	-0.0081
9262	1852.40	4.2	30	-27	-0.0146
9262	1852.40	4.2	40	-19	-0.0103
9262	1852.40	4.2	50	-29	-0.0157
9262	1852.40	4.2	60	-21	-0.0113



**Test Report No.**  
 RTS-5385-1108-52A\_rev1

**Dates of Test**  
 July 26 to September 19 and  
 November 11, 2011

FCC ID: L6AREC70UW IC ID: 2503A-REC70UW  
 FCC ID: L6ARED70UW IC ID: 2503A-RED70UW

UMTS band 2 Results: channel 9400 @ maximum transmitted power

Traffic Channel Number	Frequency (MHz)	Voltage (Volts)	Temperature (Celsius)	Frequency Error (Hz)	PPM
9400	1880.00	3.6	-30	16	0.0085
9400	1880.00	3.6	-20	-27	-0.0144
9400	1880.00	3.6	-10	-14	-0.0074
9400	1880.00	3.6	0	-22	-0.0117
9400	1880.00	3.6	10	-25	-0.0133
9400	1880.00	3.6	20	27	0.0144
9400	1880.00	3.6	30	-11	-0.0059
9400	1880.00	3.6	40	-15	-0.0080
9400	1880.00	3.6	50	-25	-0.0133
9400	1880.00	3.6	60	-13	-0.0069

Traffic Channel Number	Frequency (MHz)	Voltage (Volts)	Temperature (Celsius)	Frequency Error (Hz)	PPM
9400	1880.00	3.7	-30	-16	-0.0085
9400	1880.00	3.7	-20	-26	-0.0138
9400	1880.00	3.7	-10	27	0.0144
9400	1880.00	3.7	0	-18	-0.0096
9400	1880.00	3.7	10	-18	-0.0096
9400	1880.00	3.7	20	-19	-0.0101
9400	1880.00	3.7	30	-24	-0.0128
9400	1880.00	3.7	40	-8	-0.0043
9400	1880.00	3.7	50	-25	-0.0133
9400	1880.00	3.7	60	-29	-0.0154

Traffic Channel Number	Frequency (MHz)	Voltage (Volts)	Temperature (Celsius)	Frequency Error (Hz)	PPM
9400	1880.00	4.2	-30	-27	-0.0144
9400	1880.00	4.2	-20	-28	-0.0149
9400	1880.00	4.2	-10	26	0.0138
9400	1880.00	4.2	0	-17	-0.0090
9400	1880.00	4.2	10	-24	-0.0128
9400	1880.00	4.2	20	-27	-0.0144
9400	1880.00	4.2	30	-18	-0.0096
9400	1880.00	4.2	40	-17	-0.0090
9400	1880.00	4.2	50	-26	-0.0138
9400	1880.00	4.2	60	-20	-0.0106



**Test Report No.**  
 RTS-5385-1108-52A\_rev1

**Dates of Test**  
 July 26 to September 19 and  
 November 11, 2011

FCC ID: L6AREC70UW IC ID: 2503A-REC70UW  
 FCC ID: L6ARED70UW IC ID: 2503A-RED70UW

UMTS band 2 Results: channel 9538 @ maximum transmitted power

Traffic Channel Number	Frequency (MHz)	Voltage (Volts)	Temperature (Celsius)	Frequency Error (Hz)	PPM
9538	1907.60	3.6	-30	21	0.0110
9538	1907.60	3.6	-20	-29	-0.0152
9538	1907.60	3.6	-10	-16	-0.0084
9538	1907.60	3.6	0	-27	-0.0142
9538	1907.60	3.6	10	-29	-0.0152
9538	1907.60	3.6	20	18	0.0094
9538	1907.60	3.6	30	-30	-0.0157
9538	1907.60	3.6	40	-24	-0.0126
9538	1907.60	3.6	50	-22	-0.0115
9538	1907.60	3.6	60	14	0.0073

Traffic Channel Number	Frequency (MHz)	Voltage (Volts)	Temperature (Celsius)	Frequency Error (Hz)	PPM
9538	1907.60	3.7	-30	-27	-0.0142
9538	1907.60	3.7	-20	16	0.0084
9538	1907.60	3.7	-10	18	0.0094
9538	1907.60	3.7	0	-17	-0.0089
9538	1907.60	3.7	10	12	0.0063
9538	1907.60	3.7	20	-35	<b>-0.0183</b>
9538	1907.60	3.7	30	-22	-0.0115
9538	1907.60	3.7	40	-22	-0.0115
9538	1907.60	3.7	50	-22	-0.0115
9538	1907.60	3.7	60	-10	-0.0052

Traffic Channel Number	Frequency (MHz)	Voltage (Volts)	Temperature (Celsius)	Frequency Error (Hz)	PPM
9538	1907.60	4.2	-30	-14	-0.0073
9538	1907.60	4.2	-20	-29	-0.0152
9538	1907.60	4.2	-10	24	0.0126
9538	1907.60	4.2	0	-16	-0.0084
9538	1907.60	4.2	10	10	0.0052
9538	1907.60	4.2	20	-31	-0.0163
9538	1907.60	4.2	30	-30	-0.0157
9538	1907.60	4.2	40	-23	-0.0121
9538	1907.60	4.2	50	-22	-0.0115
9538	1907.60	4.2	60	-26	-0.0136

APPENDIX 3C – UMTS Band 4 FREQUENCY STABILITY TEST DATA

	EMI Test Report for the BlackBerry® smartphone Model REC71UW, RED71UW <b>APPENDIX 3B</b>	
	<b>Test Report No.</b> RTS-5385-1108-52A_rev1	<b>Dates of Test</b> July 26 to September 19 and November 11, 2011

UMTS Band 4 Frequency Stability Test Data

The following test configurations were measured for model RED71UW:

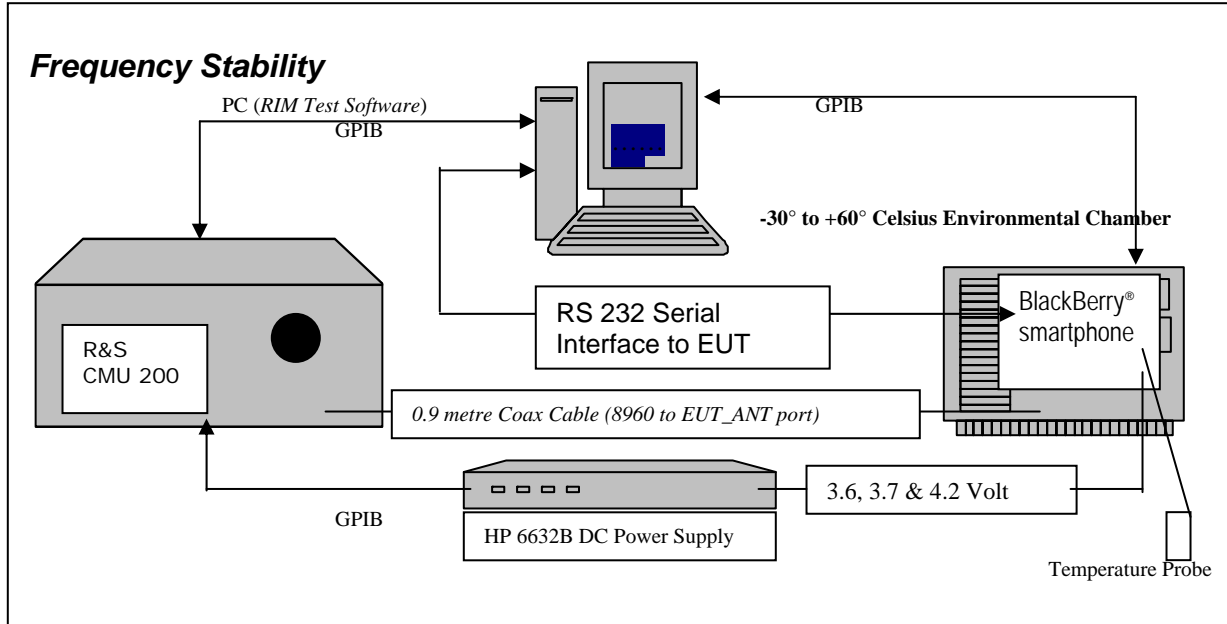

The following measurements were performed by Kevin Guo.

CFR 47 Chapter 1 - Federal Communications Commission Rules

Part 2 Required Measurements

**2.1055** Frequency Stability - Procedures

(a,b) Frequency Stability - Temperature Variation

(d) Frequency Stability - Voltage Variation

**24.236** *Frequency Stability.*

*The frequency stability shall be sufficient to ensure that the fundamental emission stays within the authorized frequency block.*

*The EUT meets the requirements as stated in CFR 47 chapter 1, Section 27.54, CFR 47 and RSS-139, 6.3 Frequency Stability.*

Frequency Stability measurement devices were configured as presented in the block diagram recording frequency, power, data, temperatures, and stepped voltages controlled via a GPIB interface linked to the Environmental chamber, a DC power supply, and the Communications Test Set. A 0.9-metre coax cable was calibrated to characterize the insertion loss for the transmitted frequencies between the RF input/output of the CMU 200 and the EUT antenna port.

	EMI Test Report for the BlackBerry® smartphone Model REC71UW, RED71UW <b>APPENDIX 3B</b>	
<b>Test Report No.</b> RTS-5385-1108-52A_rev1	<b>Dates of Test</b> July 26 to September 19 and November 11, 2011	FCC ID: L6AREC70UW IC ID: 2503A-REC70UW FCC ID: L6ARED70UW IC ID: 2503A-RED70UW

**Procedure:**

The EUT was placed in the Temperature chamber and connected to CMU 200 outside as shown in the figure above. Dry air was pumped inside the temperature chamber to maintain a backpressure during the test. The EUT was kept in the off condition at all times except when the following measurements were to be made.

The chamber was switched on and the temperature was set to -30°C. After the chamber stabilized at -30 °C there was a soak period of one hour to alleviate moisture in the chamber, the EUT voltage was enabled. The system software recorded the frequency, power, and associated measurements.

A Computer system controlled the automated software. This application was given the command of activating all machines intrinsic to the temperature and voltage tests controlling the CMU 200 via the GPIB Bus. The Environmental Chamber was instructed through an RS-232 serial line. The EUT dialogue was passed through a serial connection.

The EUT repetitively transmitted 100 bursts for each set of programmed parameters recording temperature, voltage settings, and systematically selected frequencies. The power supply was cycled from minimum voltage 3.6 volts, to 3.7 volts to 4.2 volts maximum voltage. The frequency error was measured at a maximum output power and recorded by the automated system test software.

The EUT output power and frequency was measured at 3.6 volts, 3.7 volts and 4.2 volts. The transmit frequency was varied in 3 steps consisting of 1852.4, 1880.0 and 1907.6 MHz for the UMTS band 2. This frequency was recorded in MHz and deviation from nominal, in Parts Per Million.

After the initial one-hour soak at the beginning of the tests, a period of thirty minutes soak was initialized between each ascending temperature step, before proceeding to the next measurement test cycle.

	EMI Test Report for the BlackBerry® smartphone Model REC71UW, RED71UW <b>APPENDIX 3B</b>	
<b>Test Report No.</b> RTS-5385-1108-52A_rev1	<b>Dates of Test</b> July 26 to September 19 and November 11, 2011	FCC ID: L6AREC70UW IC ID: 2503A-REC70UW FCC ID: L6ARED70UW IC ID: 2503A-RED70UW

**PROCEDURE:**

The test system software for commencing the Frequency Stability Tests carried through the following cycle.

15. Switch on the HP 6632B power supply; CMU 200 Communications test Set, and Environmental Chamber.
16. Start test program
17. Set the Temperature to –30°C and maintain a period of one- hour soak time, with the EUT supply voltage disabled.
18. Set power supply voltage to 3.6 volts.
19. Set up CMU 200 Radio Communication Tester.
20. Command the CMU 200 to switch to the low channel.
21. Enable the voltage to the EUT, and connect a link to the CMU 200 test set.
22. EUT is commanded to Transmit 100 Bursts.
23. Software logs the following data from the CMU 200, power supply and temperature chamber: Traffic Channel Number, Traffic Channel Frequency, Power Level, Chamber Temperature, Supply Voltage, Power and Frequency Error.
24. The CMU 200 commands the EUT to change frequency to the middle channel and high channel and repeats steps 7 to 9.
25. Repeat steps 5 to 10 changing the supply voltage to 3.7 Volts
26. Increase temperature by 10°C and soak for 1/2 hour.
27. Repeat steps 4 - 12 for temperatures –30°C to 60°C.
28. Repeat steps 5 to 10 changing the supply voltage to 4.2 volts

Procedure 5 to 10 was repeated at room temperature (20°C) with the power supply voltage set to 3.6, 3.7 and 4.2 volts

The maximum frequency error in the UMTS band 4 measured was **0.0217 PPM**.



**Test Report No.**  
RTS-5385-1108-52A\_rev1

**Dates of Test**  
July 26 to September 19 and  
November 11, 2011

FCC ID: L6AREC70UW IC ID: 2503A-REC70UW  
FCC ID: L6ARED70UW IC ID: 2503A-RED70UW

UMTS Band 4 Channel results: channels 1312, 1412 and 1513 @ 20°C maximum transmitted power

Traffic Channel Number	UMTS band 4 Frequency (MHz)	Voltage (Volts)	Temperature (Celsius)	Frequency Error (Hz)	PPM
1312	1712.4	3.6	20	-12	-0.0070
1412	1732.4	3.6	20	16	0.0092
1513	1752.6	3.6	20	26	0.0148

Traffic Channel Number	UMTS band 4 Frequency (MHz)	Voltage (Volts)	Temperature (Celsius)	Frequency Error (Hz)	PPM
1312	1712.4	3.7	20	14	0.0082
1412	1732.4	3.7	20	-21	-0.0121
1513	1752.6	3.7	20	19	0.0108

Traffic Channel Number	UMTS band 4 Frequency (MHz)	Voltage (Volts)	Temperature (Celsius)	Frequency Error (Hz)	PPM
1312	1712.4	4.2	20	22	0.0128
1412	1732.4	4.2	20	27	0.0156
1513	1752.6	4.2	20	27	0.0154





**Test Report No.**  
 RTS-5385-1108-52A\_rev1

**Dates of Test**  
 July 26 to September 19 and  
 November 11, 2011

FCC ID: L6AREC70UW IC ID: 2503A-REC70UW  
 FCC ID: L6ARED70UW IC ID: 2503A-RED70UW

UMTS band 4 Results: channel 1312 @ maximum transmitted power

Traffic Channel Number	Frequency (MHz)	Voltage (Volts)	Temperature (Celsius)	Frequency Error (Hz)	PPM
1312	1712.4	3.6	-30	9	0.0053
1312	1712.4	3.6	-20	-27	-0.0158
1312	1712.4	3.6	-10	-36	-0.0210
1312	1712.4	3.6	0	-28	-0.0164
1312	1712.4	3.6	10	-11	-0.0064
1312	1712.4	3.6	20	-12	-0.0070
1312	1712.4	3.6	30	15	0.0088
1312	1712.4	3.6	40	18	0.0105
1312	1712.4	3.6	50	17	0.0099
1312	1712.4	3.6	60	24	0.0140

Traffic Channel Number	Frequency (MHz)	Voltage (Volts)	Temperature (Celsius)	Frequency Error (Hz)	PPM
1312	1712.4	3.7	-30	13	0.0076
1312	1712.4	3.7	-20	-35	-0.0204
1312	1712.4	3.7	-10	-21	-0.0123
1312	1712.4	3.7	0	-29	-0.0169
1312	1712.4	3.7	10	-17	-0.0099
1312	1712.4	3.7	20	14	0.0082
1312	1712.4	3.7	30	11	0.0064
1312	1712.4	3.7	40	22	0.0128
1312	1712.4	3.7	50	21	0.0123
1312	1712.4	3.7	60	31	0.0181

Traffic Channel Number	Frequency (MHz)	Voltage (Volts)	Temperature (Celsius)	Frequency Error (Hz)	PPM
1312	1712.4	4.2	-30	17	0.0099
1312	1712.4	4.2	-20	-34	-0.0199
1312	1712.4	4.2	-10	-29	-0.0169
1312	1712.4	4.2	0	24	0.0140
1312	1712.4	4.2	10	-26	-0.0152
1312	1712.4	4.2	20	22	0.0128
1312	1712.4	4.2	30	-19	-0.0111
1312	1712.4	4.2	40	19	0.0111
1312	1712.4	4.2	50	19	0.0111
1312	1712.4	4.2	60	25	0.0146



**Test Report No.**  
 RTS-5385-1108-52A\_rev1

**Dates of Test**  
 July 26 to September 19 and  
 November 11, 2011

FCC ID: L6AREC70UW IC ID: 2503A-REC70UW  
 FCC ID: L6ARED70UW IC ID: 2503A-RED70UW

UMTS band 4 Results: channel 1412 @ maximum transmitted power

Traffic Channel Number	Frequency (MHz)	Voltage (Volts)	Temperature (Celsius)	Frequency Error (Hz)	PPM
1412	1732.4	3.6	-30	-11	-0.0063
1412	1732.4	3.6	-20	-33	-0.0190
1412	1732.4	3.6	-10	28	0.0162
1412	1732.4	3.6	0	-22	-0.0127
1412	1732.4	3.6	10	-16	-0.0092
1412	1732.4	3.6	20	16	0.0092
1412	1732.4	3.6	30	21	0.0121
1412	1732.4	3.6	40	-20	-0.0115
1412	1732.4	3.6	50	15	0.0087
1412	1732.4	3.6	60	-23	-0.0133

Traffic Channel Number	Frequency (MHz)	Voltage (Volts)	Temperature (Celsius)	Frequency Error (Hz)	PPM
1412	1732.4	3.7	-30	19	0.0110
1412	1732.4	3.7	-20	25	0.0144
1412	1732.4	3.7	-10	26	0.0150
1412	1732.4	3.7	0	17	0.0098
1412	1732.4	3.7	10	-19	-0.0110
1412	1732.4	3.7	20	-21	-0.0121
1412	1732.4	3.7	30	18	0.0104
1412	1732.4	3.7	40	-23	-0.0133
1412	1732.4	3.7	50	-23	-0.0133
1412	1732.4	3.7	60	32	0.0185

Traffic Channel Number	Frequency (MHz)	Voltage (Volts)	Temperature (Celsius)	Frequency Error (Hz)	PPM
1412	1732.4	4.2	-30	-23	-0.0133
1412	1732.4	4.2	-20	-21	-0.0121
1412	1732.4	4.2	-10	-31	-0.0179
1412	1732.4	4.2	0	-19	-0.0110
1412	1732.4	4.2	10	-19	-0.0110
1412	1732.4	4.2	20	27	0.0156
1412	1732.4	4.2	30	-19	-0.0110
1412	1732.4	4.2	40	21	0.0121
1412	1732.4	4.2	50	-28	-0.0162
1412	1732.4	4.2	60	-34	-0.0196

**Test Report No.**  
 RTS-5385-1108-52A\_rev1

**Dates of Test**  
 July 26 to September 19 and  
 November 11, 2011

 FCC ID: L6AREC70UW IC ID: 2503A-REC70UW  
 FCC ID: L6ARED70UW IC ID: 2503A-RED70UW

## UMTS band 4 Results: channel 1513 @ maximum transmitted power

Traffic Channel Number	Frequency (MHz)	Voltage (Volts)	Temperature (Celsius)	Frequency Error (Hz)	PPM
1513	1752.6	3.6	-30	-17	-0.0097
1513	1752.6	3.6	-20	35	0.0200
1513	1752.6	3.6	-10	32	0.0183
1513	1752.6	3.6	0	-23	-0.0131
1513	1752.6	3.6	10	-22	-0.0126
1513	1752.6	3.6	20	26	0.0148
1513	1752.6	3.6	30	19	0.0108
1513	1752.6	3.6	40	-26	-0.0148
1513	1752.6	3.6	50	-22	-0.0126
1513	1752.6	3.6	60	29	0.0165

Traffic Channel Number	Frequency (MHz)	Voltage (Volts)	Temperature (Celsius)	Frequency Error (Hz)	PPM
1513	1752.6	3.7	-30	22	0.0126
1513	1752.6	3.7	-20	38	<b>0.0217</b>
1513	1752.6	3.7	-10	31	0.0177
1513	1752.6	3.7	0	28	0.0160
1513	1752.6	3.7	10	-11	-0.0063
1513	1752.6	3.7	20	19	0.0108
1513	1752.6	3.7	30	21	0.0120
1513	1752.6	3.7	40	-30	-0.0171
1513	1752.6	3.7	50	-23	-0.0131
1513	1752.6	3.7	60	-32	-0.0183

Traffic Channel Number	Frequency (MHz)	Voltage (Volts)	Temperature (Celsius)	Frequency Error (Hz)	PPM
1513	1752.6	4.2	-30	-24	-0.0137
1513	1752.6	4.2	-20	35	0.0200
1513	1752.6	4.2	-10	34	0.0194
1513	1752.6	4.2	0	22	0.0126
1513	1752.6	4.2	10	23	0.0131
1513	1752.6	4.2	20	27	0.0154
1513	1752.6	4.2	30	-23	-0.0131
1513	1752.6	4.2	40	-23	-0.0131
1513	1752.6	4.2	50	-31	-0.0177
1513	1752.6	4.2	60	-23	-0.0131

## APPENDIX 4A – GSM RADIATED EMISSIONS TEST DATA

**Test Report No.**  
 RTS-5385-1108-52A\_rev1

**Dates of Test**  
 July 26 to September 19 and  
 November 11, 2011

FCC ID: L6AREC70UW IC ID: 2503A-REC70UW  
 FCC ID: L6ARED70UW IC ID: 2503A-RED70UW

### Radiated Power Test Data Results

The following test configurations were measured for model REC71UW:

Date of test: July 27, 2011

The following measurements were performed by Nielven Olis.

The environmental tests conditions were: Temperature: 23.0 °C  
 Relative Humidity: 45.8 %

The BlackBerry® smartphone was in standalone, horizontal position.  
 Test distance was 3.0 metres.

### GSM850 Band Call Mode

EUT				Rx Antenna		Spectrum Analyzer		Substitution Method				Limit (dBm)	Diff. To Limit (dB)
Type	Ch	Frequency (MHz)	Band	Type	Pol.	Reading (dBuV)	Max (V,H) (dBuV)	Pol. Tx-Rx	Reading (dBm)	Corrected Reading (relative to Dipole)			
											(dBm)	(W)	
F0	128	824.20	850	Dipole	V	75.50	84.34	V-V	12.88	<b>31.16</b>	<b>1.31</b>	38.50	<b>-7.34</b>
F0	128	824.20	850	Dipole	H	84.34		H-H	9.34				
F0	190	836.60	850	Dipole	V	76.93	83.66	V-V	11.02	29.00	0.79	38.50	-9.50
F0	190	836.60	850	Dipole	H	83.66		H-H	9.84				
F0	251	848.80	850	Dipole	V	75.97	84.3	V-V	11.73	29.75	0.94	38.50	-8.75
F0	251	848.80	850	Dipole	H	84.30		H-H	10.80				

### GSM850 Band EDGE Mode

EUT				Rx Antenna		Spectrum Analyzer		Substitution Method				Limit (dBm)	Diff. To Limit (dB)
Type	Ch	Frequency (MHz)	Band	Type	Pol.	Reading (dBuV)	Max (V,H) (dBuV)	Pol. Tx-Rx	Reading (dBm)	Corrected Reading (relative to Dipole)			
											(dBm)	(W)	
F0	128	824.20	850	Dipole	V	74.24	82.56	V-V	11.04	<b>29.32</b>	<b>0.86</b>	38.50	<b>-9.18</b>
F0	128	824.20	850	Dipole	H	82.56		H-H	7.52				
F0	190	836.60	850	Dipole	V	73.49	82.09	V-V	9.46	27.44	0.56	38.50	-11.06
F0	190	836.60	850	Dipole	H	82.09		H-H	8.26				
F0	251	848.80	850	Dipole	V	74.44	82.67	V-V	10.11	28.13	0.65	38.50	-10.37
F0	251	848.80	850	Dipole	H	82.67		H-H	9.19				

**Test Report No.**  
RTS-5385-1108-52A\_rev1

**Dates of Test**  
July 26 to September 19 and  
November 11, 2011

FCC ID: L6AREC70UW IC ID: 2503A-REC70UW  
FCC ID: L6ARED70UW IC ID: 2503A-RED70UW

Radiated Power Test Data Results cont'd

Date of test: September 13, 2011

The following measurements were performed by Shuo Wang.

The environmental tests conditions were: Temperature: 24.7 °C  
Relative Humidity: 42.7%

The BlackBerry® smartphone was in standalone, horizontal face down position.  
Test distance is 3.0 metres.

**PCS1900 Band Call Mode**

EUT								Receive Antenna		Spectrum Analyzer		Substitution Method			
EUT								Receive Antenna		Spectrum Analyzer		Tracking Generator			
Type	Ch	Frequency (MHz)	Band	Type	Pol.	Reading (dBuV)	Max (V,H) dBuV	Pol. Tx-Rx	Reading (dBm)	Corrected Reading (relative to Isotropic Radiator)		Limit (dBm)	Diff to Limit (dB)		
										(dBm)	(W)				
F0	512	1850.20	1900	Horn	V	82.14	90.67	V-V	-2.51	32.30	1.66	33.00	-0.70		
F0	512	1850.20	1900	Horn	H	90.67		H-H	-2.77						
F0	661	1880.00	1900	Horn	V	81.69	90.64	V-V	-2.45	<b>32.53</b>	<b>1.79</b>	33.00	<b>-0.47</b>		
F0	661	1880.00	1900	Horn	H	90.64		H-H	-2.37						
F0	810	1909.80	1900	Horn	V	83.13	90.39	V-V	-1.77	32.18	1.65	33.00	-0.82		
F0	810	1909.80	1900	Horn	H	90.39		H-H	-1.82						

**PCS1900 Band EDGE Mode**

EUT								Receive Antenna		Spectrum Analyzer		Substitution Method			
EUT								Receive Antenna		Spectrum Analyzer		Tracking Generator			
Type	Ch	Frequency (MHz)	Band	Type	Pol.	Reading (dBuV)	Max (V,H) dBuV	Pol. Tx-Rx	Reading (dBm)	Corrected Reading (relative to Isotropic Radiator)		Limit (dBm)	Diff to Limit (dB)		
										(dBm)	(W)				
F0	512	1850.20	1900	Horn	V	75.67	86.71	V-V	-6.47	28.34	0.68	33.00	-4.66		
F0	512	1850.20	1900	Horn	H	86.71		H-H	-6.73						
F0	661	1880.00	1900	Horn	V	74.45	86.73	V-V	-6.36	<b>28.62</b>	<b>0.73</b>	33.00	<b>-4.38</b>		
F0	661	1880.00	1900	Horn	H	86.73		H-H	-6.28						
F0	810	1909.80	1900	Horn	V	75.62	86.67	V-V	-5.49	28.46	0.70	33.00	-4.54		
F0	810	1909.80	1900	Horn	H	86.67		H-H	-5.54						



	EMI Test Report for the BlackBerry® smartphone Model REC71UW, RED71UW <b>APPENDIX 4A</b>	
	<b>Test Report No.</b> RTS-5385-1108-52A_rev1	<b>Dates of Test</b> July 26 to September 19 and November 11, 2011

Radiated Emissions Test Data Results cont'd

**GSM850 EDGE Mode**

Date of Test: July 27, 2011

The following measurements were performed by Nielven Olis.

The environmental test conditions were: Temperature: 24.8 °C  
Relative Humidity: 40.0 %

Test Distance was 3.0 metres with a height of 1.0 metres, and a frequency range of 30 MHz to 1000 MHz.

The BlackBerry® smartphone was in standalone, horizontal position.

The measurements were performed in GSM850 EDGE Tx mode, channels 128, 190, 251.

All emissions had a test margin greater than 25.0 dB.

Date of Test: July 27, 2011

The following measurements were performed by Shuo Wang.

The environmental test conditions were: Temperature: 25.0 °C  
Relative Humidity: 41.0 %

Test Distance was 3.0 metres with a height of 1-4 metres, and a frequency range of 1 GHz to 9 GHz.

The BlackBerry® smartphone was in standalone, vertical position.

The measurements were performed in GSM850 EDGE Tx mode, channels 128, 190, 251.

All other emissions had a test margin greater than 25.0 dB



	EMI Test Report for the BlackBerry® smartphone Model REC71UW, RED71UW <b>APPENDIX 4A</b>	
<b>Test Report No.</b> RTS-5385-1108-52A_rev1	<b>Dates of Test</b> July 26 to September 19 and November 11, 2011	FCC ID: L6AREC70UW IC ID: 2503A-REC70UW FCC ID: L6ARED70UW IC ID: 2503A-RED70UW

Radiated Emissions Test Data Results cont'd

**PCS1900 GSM Mode**

Date of Test: July 27, 2011

The following measurements were performed by Nielven Olis.

The environmental test conditions were: Temperature: 25.6 °C  
Relative Humidity: 36.8 %

Test Distance was 3.0 metres with a height of 1-4 meters, and a frequency range of 30 MHz to 1000 MHz.

The BlackBerry® smartphone was in standalone, horizontal face down position.

The measurements were performed in PCS1900 Call Tx mode, channels 512, 661, 810.

All emissions had a test margin greater than 25.0 dB.

Date of Test: July 27, 2011

The following measurements were performed by Shuo Wang.

The environmental test conditions were: Temperature: 25.0 °C  
Relative Humidity: 41.0 %

Test Distance was 3.0 metres with a height of 1.0 metres, and a frequency range of 1 GHz to 20 GHz.

The BlackBerry® smartphone was in standalone, horizontal face down position.

The measurements were performed in PCS1900, channels 512, 661, 810.

All emissions had a test margin greater than 25.0 dB.

	EMI Test Report for the BlackBerry® smartphone Model REC71UW, RED71UW <b>APPENDIX 4A</b>	
<b>Test Report No.</b> RTS-5385-1108-52A_rev1	<b>Dates of Test</b> July 26 to September 19 and November 11, 2011	FCC ID: L6AREC70UW IC ID: 2503A-REC70UW FCC ID: L6ARED70UW IC ID: 2503A-RED70UW

Radiated Emissions Test Data Results cont'd

**PCS1900 EDGE Mode**

Date of Test: July 27, 2011

The following measurements were performed by Nielven Olis.

The environmental test conditions were: Temperature: 25.6 °C  
Relative Humidity: 36.8 %

Test Distance was 3.0 metres with a height of 1-4 meters, and a frequency range of 30 MHz to 1000 MHz.

The BlackBerry® smartphone was in standalone, horizontal face down position.

The measurements were performed in PCS1900 Edge Tx mode, channels 512, 661, 810.

All emissions had a test margin greater than 25.0 dB.

Date of Test: July 27, 2011

The following measurements were performed by Shuo Wang.

The environmental test conditions were: Temperature: 25.0 °C  
Relative Humidity: 41.0 %

Test Distance was 3.0 metres with a height of 1.0 metres, and a frequency range of 1 GHz to 20 GHz.

The BlackBerry® smartphone was in standalone, horizontal face down position.

The measurements were performed in PCS1900 Edge Tx mode, channels 512, 661, 810.

All emissions had a test margin greater than 25.0 dB.

**Test Report No.**  
RTS-5385-1108-52A\_rev1

**Dates of Test**  
July 26 to September 19 and  
November 11, 2011

FCC ID: L6AREC70UW IC ID: 2503A-REC70UW  
FCC ID: L6ARED70UW IC ID: 2503A-RED70UW

### Radiated Power Test Data Results

The following test configurations were measured for model RED71UW:

Date of test: August 18, 2011

The following measurements were performed by Nielven Olis.

The environmental tests conditions were: Temperature: 22.4 °C  
Relative Humidity: 48.0 %

The BlackBerry® smartphone was in standalone, horizontal position.  
Test distance was 3.0 metres.

### GSM850 Band Call Mode

EUT				Rx Antenna		Spectrum Analyzer		Substitution Method				Limit (dBm)	Diff. To Limit (dB)		
Type	Ch	Frequency (MHz)	Band	Type	Pol.	Reading (dBuV)	Max (V,H) (dBuV)	Pol. Tx-Rx	Reading (dBm)	Tracking Generator					
										Corrected Reading (relative to Dipole)					
										(dBm)	(W)				
F0	128	824.20	850	Dipole	V	75.48	84.03	V-V	10.82	29.10	0.81	38.50	-9.40		
F0	128	824.20	850	Dipole	H	84.03		H-H	8.80						
F0	190	836.60	850	Dipole	V	75.74	83.86	V-V	11.30	<b>29.28</b>	<b>0.85</b>	38.50	<b>-9.22</b>		
F0	190	836.60	850	Dipole	H	83.86		H-H	9.88						
F0	251	848.80	850	Dipole	V	75.59	83.23	V-V	11.20	29.22	0.84	38.50	-9.28		
F0	251	848.80	850	Dipole	H	83.23		H-H	10.01						

### GSM850 Band EDGE Mode

EUT				Rx Antenna		Spectrum Analyzer		Substitution Method				Limit (dBm)	Diff. To Limit (dB)		
Type	Ch	Frequency (MHz)	Band	Type	Pol.	Reading (dBuV)	Max (V,H) (dBuV)	Pol. Tx-Rx	Reading (dBm)	Tracking Generator					
										Corrected Reading (relative to Dipole)					
										(dBm)	(W)				
F0	128	824.20	850	Dipole	V	73.68	82.51	V-V	9.33	<b>27.61</b>	<b>0.58</b>	38.50	<b>-10.89</b>		
F0	128	824.20	850	Dipole	H	82.51		H-H	7.34						
F0	190	836.60	850	Dipole	V	73.16	81.47	V-V	8.86	26.84	0.48	38.50	-11.66		
F0	190	836.60	850	Dipole	H	81.47		H-H	7.46						
F0	251	848.80	850	Dipole	V	73.52	81.33	V-V	9.26	27.28	0.53	38.50	-11.22		
F0	251	848.80	850	Dipole	H	81.33		H-H	8.11						

**Test Report No.**  
 RTS-5385-1108-52A\_rev1

**Dates of Test**  
 July 26 to September 19 and  
 November 11, 2011

FCC ID: L6AREC70UW IC ID: 2503A-REC70UW  
 FCC ID: L6ARED70UW IC ID: 2503A-RED70UW

**Radiated Power Test Data Results cont'd**

Date of test: August 26, 2011

The following measurements were performed by Nielven Olis.

The environmental tests conditions were: Temperature: 25.7 °C  
 Relative Humidity: 36.1%

The BlackBerry® smartphone was in standalone, horizontal position.  
 Test distance is 3.0 metres.

**PCS1900 Band Call Mode**

EUT								Substitution Method					
EUT				Receive Antenna		Spectrum Analyzer		Tracking Generator					
Type	Ch	Frequency (MHz)	Band	Type	Pol.	Reading (dBuV)	Max (V,H) dBuV	Pol. Tx-Rx	Reading (dBm)	Corrected Reading (relative to Isotropic Radiator)		Limit (dBm)	Diff to Limit (dB)
										(dBm)	(W)		
F0	512	1850.20	1900	Horn	V	82.77	89.91	V-V	-8.99	28.52	0.71	33.00	-4.48
F0	512	1850.20	1900	Horn	H	89.91		H-H	-7.56				
F0	661	1880.00	1900	Horn	V	83.60	90.66	V-V	-7.12	30.23	1.05	33.00	-2.77
F0	661	1880.00	1900	Horn	H	90.66		H-H	-5.85				
F0	810	1909.80	1900	Horn	V	83.60	90.66	V-V	-6.86	<b>30.38</b>	<b>1.09</b>	33.00	<b>-2.62</b>
F0	810	1909.80	1900	Horn	H	90.66		H-H	-5.70				

**PCS1900 Band EDGE Mode**

EUT								Substitution Method					
EUT				Receive Antenna		Spectrum Analyzer		Tracking Generator					
Type	Ch	Frequency (MHz)	Band	Type	Pol.	Reading (dBuV)	Max (V,H) dBuV	Pol. Tx-Rx	Reading (dBm)	Corrected Reading (relative to Isotropic Radiator)		Limit (dBm)	Diff to Limit (dB)
										(dBm)	(W)		
F0	512	1850.20	1900	Horn	V	80.56	85.69	V-V	-13.12	24.35	0.27	33.00	-8.65
F0	512	1850.20	1900	Horn	H	85.69		H-H	-11.73				
F0	661	1880.00	1900	Horn	V	80.89	87.94	V-V	-9.87	27.46	0.56	33.00	-5.54
F0	661	1880.00	1900	Horn	H	87.94		H-H	-8.62				
F0	810	1909.80	1900	Horn	V	81.58	88.71	V-V	-8.85	<b>28.37</b>	<b>0.69</b>	33.00	<b>-4.63</b>
F0	810	1909.80	1900	Horn	H	88.71		H-H	-7.71				

## APPENDIX 4B – UMTS Band 2/5 RADIATED EMISSIONS TEST DATA

**Test Report No.**  
 RTS-5385-1108-52A\_rev1

**Dates of Test**  
 July 26 to September 19 and  
 November 11, 2011

FCC ID: L6AREC70UW IC ID: 2503A-REC70UW  
 FCC ID: L6ARED70UW IC ID: 2503A-RED70UW

**Radiated Power Test Data Results**

The following test configurations were measured for model REC71UW:

Date of Test: August 26, 2011

The following measurements were performed by Nielven Olis.

The environmental tests conditions were: Temperature: 25.7 °C  
 Relative Humidity: 36.1 %

The BlackBerry® smartphone - was in standalone, horizontal face down position.  
 Test distance is 3.0 metres

**UMTS band 5 Call Service Mode**

EUT				Rx Antenna		Spectrum Analyzer		Substitution Method				Limit (dBm)	Diff. To Limit (dB)
Type	Ch	Frequency (MHz)	Band	Type	Pol.	Reading (dBuV)	Max (V,H) (dBuV)	Tracking Generator		Corrected Reading (relative to Dipole)			
								Pol. Tx-Rx	Reading (dBm)	(dBm)	(W)		
F0	4132	826.40	5	Dipole	V	71.71	78.6	V-V	7.08	<b>25.39</b>	<b>0.35</b>	39	<b>-13.61</b>
F0	4132	826.40	5	Dipole	H	78.60		H-H	3.65				
F0	4182	836.40	5	Dipole	V	71.54	78.46	V-V	5.73	23.74	0.24	39	<b>-15.26</b>
F0	4182	836.40	5	Dipole	H	78.46		H-H	4.11				
F0	4233	846.60	5	Dipole	V	70.30	78.15	V-V	4.34	22.36	0.17	39	<b>-16.64</b>
F0	4233	846.60	5	Dipole	H	78.15		H-H	3.90				

**UMTS band 5 HSUPA Mode**

EUT				Rx Antenna		Spectrum Analyzer		Substitution Method				Limit (dBm)	Diff. To Limit (dB)
Type	Ch	Frequency (MHz)	Band	Type	Pol.	Reading (dBuV)	Max (V,H) (dBuV)	Tracking Generator		Corrected Reading (relative to Dipole)			
								Pol. Tx-Rx	Reading (dBm)	(dBm)	(W)		
F0	4132	826.40	5	Dipole	V	72.96	80.53	V-V	9.11	<b>27.42</b>	<b>0.55</b>	39	<b>-11.58</b>
F0	4132	826.40	5	Dipole	H	80.53		H-H	5.68				
F0	4182	836.40	5	Dipole	V	71.72	79.48	V-V	6.79	24.80	0.30	39	<b>-14.20</b>
F0	4182	836.40	5	Dipole	H	79.48		H-H	5.10				
F0	4233	846.60	5	Dipole	V	70.86	79.04	V-V	5.27	23.29	0.21	39	<b>-15.71</b>
F0	4233	846.60	5	Dipole	H	79.04		H-H	4.78				

**Test Report No.**  
RTS-5385-1108-52A\_rev1

**Dates of Test**  
July 26 to September 19 and  
November 11, 2011

FCC ID: L6AREC70UW IC ID: 2503A-REC70UW  
FCC ID: L6ARED70UW IC ID: 2503A-RED70UW

**Radiated Power Test Data Results cont'd**

Date of Test: September 13, 2011

The following measurements were performed by Savtej Sandhu

The environmental tests conditions were: Temperature: 25.5 °C  
Relative Humidity: 38.3 %

The BlackBerry® smartphone - was in standalone, volume up position.  
Test distance is 3.0 metres

**UMTS band 2 Call Service Mode**

											Substitution Method			
EUT				Receive Antenna		Spectrum Analyzer			Tracking Generator					
Type	Ch	Frequency (MHz)	Band	Type	Pol.	Reading (dBuV)	Max (V,H) (dBuV)	Pol. Tx-Rx	Reading (dBm)	(dBm)	(W)	Limit (dBm)	Diff to Limit (dB)	
F0	9262	1852.40	2	Horn	V	81.84	81.84	V-V	-16.99	20.31	0.11	33.00	-12.69	
F0	9262	1852.40	2	Horn	H	76.49		H-H	-15.77					
F0	9400	1880.00	2	Horn	V	81.61	81.61	V-V	-16.47	20.65	0.12	33.00	-12.35	
F0	9400	1880.00	2	Horn	H	75.15		H-H	-15.43					
F0	9538	1907.60	2	Horn	V	81.85	81.85	V-V	-15.87	21.04	0.13	33.00	-11.96	
F0	9538	1907.60	2	Horn	H	74.42		H-H	-15.04					

**UMTS band 2 HSUPA Mode**

											Substitution Method			
EUT				Receive Antenna		Spectrum Analyzer			Tracking Generator					
Type	Ch	Frequency (MHz)	Band	Type	Pol.	Reading (dBuV)	Max (V,H) (dBuV)	Pol. Tx-Rx	Reading (dBm)	(dBm)	(W)	Limit (dBm)	Diff to Limit (dB)	
F0	9262	1852.40	2	Horn	V	82.72	82.72	V-V	-16.09	21.23	0.13	33.00	-11.77	
F0	9262	1852.40	2	Horn	H	76.97		H-H	-14.85					
F0	9400	1880.00	2	Horn	V	82.76	82.76	V-V	-15.28	21.82	0.15	33.00	-11.18	
F0	9400	1880.00	2	Horn	H	75.44		H-H	-14.26					
F0	9538	1907.60	2	Horn	V	82.90	82.90	V-V	-14.75	22.16	0.16	33.00	-10.84	
F0	9538	1907.60	2	Horn	H	74.99		H-H	-13.92					

	EMI Test Report for the BlackBerry® smartphone Model REC71UW, RED71UW <b>APPENDIX 4B</b>	
	<b>Test Report No.</b> RTS-5385-1108-52A_rev1	<b>Dates of Test</b> July 26 to September 19 and November 11, 2011

Radiated Emissions Test Data Results cont'd  
**UMTS band 5 Call Service Mode**

The following test configurations were measured for model REC71UW:

Date of Test: August 10, 2011

The following measurements were performed by Nielven Olis.

The environmental test conditions were:   Temperature:   25.1 °C  
Relative Humidity: 37.3 %

Test Distance was 3.0 metres with a height of 1-4 metres, and a frequency range of 30 MHz to 1000 MHz.

The BlackBerry® smartphone was in standalone, horizontal position.

The following measurements were performed in UMTS band 5 Call mode on channels 4132, 4182, and 4233.

All emissions had a test margin greater than 25.0 dB.

Date of Test: August 4, 2011

The following measurements were performed by Shuo Wang

The environmental test conditions were:   Temperature:   25.0 °C  
Relative Humidity: 41.0%

Test Distance was 3.0 metres with a height of 1-4 meters, and a frequency range of 1GHz to 9 GHz.

The BlackBerry® smartphone was in standalone, horizontal face down position.

The following measurements were performed in UMTS band 5 Call mode on channels 4132, 4182, and 4233.

All emissions had a test margin greater than 25.0 dB.



	EMI Test Report for the BlackBerry® smartphone Model REC71UW, RED71UW <b>APPENDIX 4B</b>	
<b>Test Report No.</b> RTS-5385-1108-52A_rev1	<b>Dates of Test</b> July 26 to September 19 and November 11, 2011	FCC ID: L6AREC70UW IC ID: 2503A-REC70UW FCC ID: L6ARED70UW IC ID: 2503A-RED70UW

Radiated Emissions Test Data Results cont'd  
**UMTS 5 HSUPA Mode**

Date of Test: August 10, 2011

The following measurements were performed by Nielven Olis.

The environmental test conditions were: Temperature: 25.1 °C  
Relative Humidity: 36.7 %

Test Distance was 3.0 metres with a height of 1-4 metres, and a frequency range of 30 MHz to 1000 MHz.

The BlackBerry® smartphone was in standalone, horizontal position.

The following measurements were performed in UMTS band 5 HSUPA mode on channels 4132, 4182, and 4233.

All emissions had a test margin greater than 25.0 dB.

Date of Test: August 4, 2011

The following measurements were performed by Shuo Wang

The environmental test conditions were: Temperature: 25.0 °C  
Relative Humidity: 41.0%

Test Distance was 3.0 metres with a height of 1-4 meters, and a frequency range of 1GHz to 9 GHz.

The BlackBerry® smartphone was in standalone, horizontal face down position.

The following measurements were performed in UMTS band 5 HSUPA mode on channels 4132, 4182, and 4233.

All emissions had a test margin greater than 25.0 dB.

	EMI Test Report for the BlackBerry® smartphone Model REC71UW, RED71UW <b>APPENDIX 4B</b>	
	<b>Test Report No.</b> RTS-5385-1108-52A_rev1	<b>Dates of Test</b> July 26 to September 19 and November 11, 2011

Radiated Emissions Test Data Results cont'd

**UMTS band 2 Call Service mode**

Date of Test: September 12, 2011

The following measurements were performed by Nielven Olis.

The environmental test conditions were: Temperature: 25.0 °C  
Relative Humidity: 35.6 %

Test Distance was 3.0 metres with a height of 1-4 metres, and a frequency range of 30 MHz to 1000 MHz.

The BlackBerry® smartphone was in standalone, volume up position.

The following measurements were performed in UMTS band 2 Call mode on channels 9262, 9400, and 9538.

All emissions had a test margin greater than 25.0 dB.

Date of Test: September 13, 2011

The following measurements were performed by Shuo Wang

The environmental test conditions were: Temperature: 24.7°C  
Relative Humidity: 42.7 %

Test Distance was 3.0 metres with a height of 1-4 metres, and a frequency range of 1GHz to 20 GHz.

The BlackBerry® smartphone was in standalone, horizontal face down position.

The following measurements were performed in UMTS band 2 Call mode on channels 9262, 9400, 9538.

Frequency (MHz)	Channel Of Occurrence	Antenna		Test Angle (Deg.)	Detector (PK or QP)	Measured Level (dBm)	Correction Factor for preamp/antenna/ cables/ filter (dB)	Field Strength Level (reading+corr) (dBm)	Limit @ 3.0 m (dBm)	Test Margin (dB)
		Pol. (V/H)	Height (metres)							
3813.472	9538	H	2.82	171.00	PK	54.03	-79.70	-25.67	-13.00	<b>-12.67</b>

All emissions had a test margin greater than 25.0 dB.

	EMI Test Report for the BlackBerry® smartphone Model REC71UW, RED71UW <b>APPENDIX 4B</b>	
	<b>Test Report No.</b> RTS-5385-1108-52A_rev1	<b>Dates of Test</b> July 26 to September 19 and November 11, 2011

Radiated Emissions Test Data Results cont'd  
**UMTS band 2 HSUPA Mode**

Date of Test: September 12, 2011

The following measurements were performed by Nielven Olis.

The environmental test conditions were: Temperature: 25.0 °C  
Relative Humidity: 35.6 %

Test Distance was 3.0 metres with a height of 1-4 metres, and a frequency range of 30 MHz to 1000 MHz.

The BlackBerry® smartphone was in standalone, volume up position.

The following measurements were performed in UMTS band 2 HSUPA mode on channels 9262, 9400, and 9538.

All emissions had a test margin greater than 25.0 dB.

Date of Test: September 13, 2011

The following measurements were performed by Shuo Wang

The environmental test conditions were: Temperature: 24.7°C  
Relative Humidity: 42.7 %

Test Distance was 3.0 metres with a height of 1-4 metres, and a frequency range of 1GHz to 20 GHz.

The BlackBerry® smartphone was in standalone, horizontal down position.

The following measurements were performed in UMTS band 2 HSUPA mode on channels 9262, 9400, and 9538.

Frequency (MHz)	Channel Of Occurrence	Antenna		Test Angle (Deg.)	Detector (PK or QP)	Measured Level (dBm)	Correction Factor for preamp/antenna/ cables/ filter (dB)	Field Strength Level (reading+corr) (dBm)	Limit @ 3.0 m (dBm)	Test Margin (dB)
		Pol. (V/H)	Height (metres)							
3817.012	9538	H	2.81	182.00	PK	53.87	-79.67	-25.79	-13.00	<b>-12.79</b>

All emissions had a test margin greater than 25.0 dB.

## APPENDIX 4C – UMTS Band 4 RADIATED EMISSIONS TEST DATA

**Test Report No.**  
 RTS-5385-1108-52A\_rev1

**Dates of Test**  
 July 26 to September 19 and  
 November 11, 2011

FCC ID: L6AREC70UW IC ID: 2503A-REC70UW  
 FCC ID: L6ARED70UW IC ID: 2503A-RED70UW

**Radiated Power Test Data Results**

The following test configurations were measured for model RED71UW:

Date of Test: September 14, 2011

The following measurements were performed by Nielven Olis.

The environmental tests conditions were: Temperature: 24.9°C  
 Relative Humidity: 35.1%

The BlackBerry® smartphone - was in standalone, volume up position.  
 Test distance is 3.0 metres

**UMTS band 4 Call Service Mode**

EUT				Rx Antenna		Spectrum Analyzer		Substitution Method				Limit (dBm)	Diff. To Limit (dB)
Type	Ch	Frequency (MHz)	Band	Type	Pol.	Reading (dBuV)	Max (V,H) (dBuV)	Pol. Tx-Rx	Reading (dBm)	Corrected Reading (relative to Dipole)			
											(dBm)	(W)	
F0	1312	1712.40	4	Horn	V	85.53	85.53	V-V	-15.47	25.31	0.34	30	-4.69
F0	1312	1712.40	4	Horn	H	82.64		H-H	-14.55				
F0	1413	1732.60	4	Horn	V	85.97	85.97	V-V	-14.64	<b>26.44</b>	<b>0.44</b>	30	<b>-3.56</b>
F0	1413	1732.60	4	Horn	H	82.43		H-H	-13.72				
F0	1513	1752.60	4	Horn	V	85.33	85.33	V-V	-15.04	26.25	0.42	30	-3.75
F0	1513	1752.60	4	Horn	H	81.86		H-H	-13.65				

**UMTS band 4 HSUPA Mode**

EUT				Rx Antenna		Spectrum Analyzer		Substitution Method				Limit (dBm)	Diff. To Limit (dB)
Type	Ch	Frequency (MHz)	Band	Type	Pol.	Reading (dBuV)	Max (V,H) (dBuV)	Pol. Tx-Rx	Reading (dBm)	Corrected Reading (relative to Dipole)			
											(dBm)	(W)	
F0	1312	1712.40	4	Horn	V	86.54	86.54	V-V	-14.46	26.30	0.43	30	-3.70
F0	1312	1712.40	4	Horn	H	83.62		H-H	-13.56				
F0	1413	1732.60	4	Horn	V	87.05	87.05	V-V	-13.59	<b>27.52</b>	<b>0.56</b>	30	<b>-2.48</b>
F0	1413	1732.60	4	Horn	H	83.7		H-H	-12.64				
F0	1513	1752.60	4	Horn	V	86.63	86.63	V-V	-13.78	27.50	0.56	30	-2.50
F0	1513	1752.60	4	Horn	H	82.98		H-H	-12.40				

	EMI Test Report for the BlackBerry® smartphone Model REC71UW, RED71UW <b>APPENDIX 4C</b>	
	<b>Test Report No.</b> RTS-5385-1108-52A_rev1	<b>Dates of Test</b> July 26 to September 19 and November 11, 2011

Radiated Emissions Test Data Results cont'd  
**UMTS band 4 Call Service Mode**

The following test configurations were measured for model RED71UW:

Date of Test: September 14 2011

The following measurements were performed by Nielven Ollis

The environmental test conditions were: Temperature: 24.9 °C  
Relative Humidity: 35.6 %

Test Distance was 3.0 metres with a height of 1-4 metres, and a frequency range of 30MHz to 1000MHz.

The BlackBerry® smartphone was in standalone, volume up position.

The following measurements were performed in UMTS band 4 Call mode on channels 1312, 1413, 1513.

All emissions had a test margin greater than 25.0 dB.

Date of Test: September 14, 2011

The following measurements were performed by Shuo Wang

The environmental test conditions were: Temperature: 24.9 °C  
Relative Humidity: 36.4%

Test Distance was 3.0 metres with a height of 1-4 meters, and a frequency range of 1GHz to 20GHz.

The BlackBerry® smartphone was in standalone, horizontal face down position.

The following measurements were performed in UMTS band 4 Call mode on channels 1312, 1413, 1513.

All emissions had a test margin greater than 25.0 dB.

	EMI Test Report for the BlackBerry® smartphone Model REC71UW, RED71UW <b>APPENDIX 4C</b>	
	<b>Test Report No.</b> RTS-5385-1108-52A_rev1	<b>Dates of Test</b> July 26 to September 19 and November 11, 2011

**Radiated Emissions Test Data Results cont'd**  
**UMTS 4 HSUPA Mode**

Date of Test: September 14 2011

The following measurements were performed by Nielven Olis

The environmental test conditions were: Temperature: 24.9 °C  
Relative Humidity: 35.6 %

Test Distance was 3.0 metres with a height of 1-4 metres, and a frequency range of 30MHz to 1000MHz.

The BlackBerry® smartphone was in standalone, volume up position.

The following measurements were performed in UMTS band 4 HSUPA mode on channels 1312, 1413, 1513.

All emissions had a test margin greater than 25.0 dB.

Date of Test: September 14, 2011

The following measurements were performed by Shuo Wang

The environmental test conditions were: Temperature: 24.9 °C  
Relative Humidity: 36.4%

Test Distance was 3.0 metres with a height of 1-4 meters, and a frequency range of 1GHz to 20GHz.

The BlackBerry® smartphone was in standalone, horizontal face down position.

The following measurements were performed in UMTS band 4 HSUPA mode on channels 1312, 1413, 1513.

All emissions had a test margin greater than 25.0 dB.