

PARTIAL TEST REPORT
No.: 2-0023-11-1-7a

According to:
FCC Regulations
 Part 15.107&15.111, Part 15.109 Class B
IC-Regulations
 RSS-132 Issue 2 & RSS-133 Issue 5
 RSS-Gen, Issue 3

for
Research In Motion Limited

 smartphone REA71UW

 smartphone REB71UW







Laboratory Accreditation and Listings			
 DAkks Deutsche Akkreditierungsstelle D-PL-12047-01-01	 FEDERAL COMMUNICATIONS COMMISSION USA Reg. No.: 736496 MRA US-EU 0003	 Industry Canada Reg. No.: 3462D-1 Reg. No.: 3462D-2 Reg. No.: 3462D-3	 Voluntary Controls for Electromagnetic Emissions Reg. No.: R-2665, R-2666 C-2914, T-1967, G-301
 WiFi ALLIANCE AUTHORIZED RF LABORATORY	 CTIA Authorized Test Lab LAB CODE 20011130-00		
accredited according to DIN EN ISO/IEC 17025			
<p align="center"> CETECOM GmbH Laboratory Radio Communications & Electromagnetic Compatibility Im Teelbruch 116 • 45219 Essen • Germany Registered in Essen, Germany, Reg. No.: HRB Essen 8984 Tel.: + 49 (0) 20 54 / 95 19-954 • Fax: + 49 (0) 20 54 / 95 19-964 E-mail: info@cetecom.com • Internet: www.cetecom.com </p>			

Table of contents

1. SUMMARY OF TEST RESULTS.....	3
1.1. RX Mode TESTS OVERVIEW FCC Part 15 and Canada IC Standards (RSS).....	3
2. ADMINISTRATIVE DATA	4
2.1. Identification of the testing laboratory.....	4
2.2. Test location	4
2.3. Organizational items	4
2.4. Applicant’s details	4
2.5. Manufacturer’s details	4
3. EQUIPMENT UNDER TEST (EUT).....	5
3.1. Additional declaration and description of main EUT	5
3.2. EUT: Type, S/N etc. and short descriptions used in this test report	7
3.3. Auxiliary Equipment (AE): Type, S/N etc. and short descriptions.....	7
3.4. EUT set-ups	8
3.5. EUT operating modes	9
3.6. Parameter Settings on mobile phone and base station CMU200	10
4. DESCRIPTION OF TEST SET-UP’S.....	12
4.1. Mode Test Set-up for conducted measurements	12
4.2. Test set-up for radiated measurements	13
5. MEASUREMENTS	14
5.1. Conducted emissions on AC-Power lines.....	14
5.2. Radiated field strength emissions, 30 MHz - 1 GHz	16
5.3. Radiated emissions, above 1GHz	21
5.4. Conducted emissions on antenna port (RX-Mode).....	24
5.5. Measurement uncertainties	27
6. ACCREDITATION DETAILS OF CETECOM’S LABORATORIES AND TEST SITES	27
7. INSTRUMENTS AND ANCILLARY.....	28
7.1. Used equipment “CTC”	28

Table of annex

Total pages

SEPARATE DOCUMENT TR2-0023-11-1-7A_A1.PDF: DIAGRAMS OF TESTING

40

1. Summary of test results

The test results apply exclusively to the test samples as presented in chapter 3.1. The CETECOM GmbH does not assume responsibility for any conclusions and generalizations taken in conjunction with other specimens or samples of the type of the item presented to tests.

The presented Smartphone includes GSM/(E)GPRS 850/1900 and W-CDMA Band II and V respective W-CDMA Band IV technology. This test report shows tests results performed in IDLE Mode only. Following tests have been performed to show compliance with applicable FCC Part 15.107 class B, 15.109 class B and 15.207 (10-1-10 Edition) and RSS-Gen standards.

1.1. RX Mode TESTS OVERVIEW FCC Part 15 and Canada IC Standards (RSS)

TEST CASES	PORT	REFERENCES & LIMITS			EUT set-up	EUT op-mode	Result
		FCC Standard	RSS Section	TEST LIMIT			
AC-Power Lines Conducted Emissions	AC-Power lines	§15.107 §15.207	RSS-Gen, Issue 3: Chapter 7.2.4	FCC §15.107 class B limits §15.207 limits IC: Table 4, Chapter 7.2.4	1 + 2 + 3 + 4 + 5 + 6	1 + 2 + 3 + 5 + 6	Passed
RECEIVER Radiated emissions	Cabinet + Interconnecting cables (radiated)	§15.109 §15.33 §15.35	RSS-132, Issue 2: 4.6 RSS-Gen, Issue 3: 6.1 RSS-133, Issue 5: 6.6	FCC 15.109 class B limits IC-limits: Table 1, Chapter 6	1 + 2 + 3 + 4 + 5 + 6	1 + 2 + 3 + 5 + 6	Passed
RECEIVER Conducted emissions	Antenna terminal (conducted)	§2.1051 §15.111	RSS-Gen: 6.2 RSS-132: 4.6 RSS-133: 6.7(b) RSS-139: 6.6	43+10log(P) dBc IC: < 2 nW/4kHz (30<F<1000MHz) < 5nW/4kHz (F > 1GHz)	7 + 8	1 + 2 + 3 + 4 + 5	Passed

Remark: --

ATTESTATION:

I declare that all measurements were performed by me or under my supervision and that all measurements have been performed and are correct to my best knowledge and belief to Industry Canada standards. All requirements as shown in above table are met in accordance with enumerated standards.

.....
Dipl.-Ing. W. Richter
Responsible for test section

GmbH
Im Teelbruch 116
45219 Essen
Tel.: + 49 (0) 20 54 / 95 19 - 0
Fax: + 49 (0) 20 54 / 95 19 - 997

.....
Dipl.-Ing. B. Taslica
Responsible for test report

2. Administrative Data

2.1. Identification of the testing laboratory

Company name:	CETECOM GmbH
Address:	Im Teelbruch 116 45219 Essen - Kettwig Germany
Responsible for testing laboratory:	Dipl.-Ing. W. Richter
Deputy:	Dipl.-Ing. J. Schmitt
Laboratory accreditations/Listings:	DAkkS-Registration No. D-PL-12047-01-01 FCC-Registration No.: 736496, MRA US-EU 0003 IC-Registration No. 3462D-1, 3462D-2, 3462D-3 VCCI Reg. No. R-2665, R-2666, C-2914, T-1967, G-301

2.2. Test location

2.2.1. Test laboratory “CTC”

Company name:	see chapter 2.1. Identification of the testing laboratory
---------------	---

2.3. Organizational items

Order No.:	2-0023-11-1
Responsible for test report and project leader:	Dipl.-Ing. B. Taslica
Receipt of EUT:	2011-08-15
Date(s) of test:	2011-08-16 - 2011-09-29
Date of report:	2011-10-07

Version of template:	11.05 _All.Dotm

2.4. Applicant’s details

Applicant’s name:	Research In Motion Limited
Address:	440 Phillip Street N2L 5R9 Waterloo ON CANADA
Contact person:	Mr. Masud Attayi

2.5. Manufacturer’s details

Manufacturer’s name:	Research In Motion Limited
Address:	295 Phillip Street N2L 3W8 Waterloo ON CANADA

3. Equipment under test (EUT)

3.1. Additional declaration and description of main EUT

Main function	Smartphone		
Type	REA71UW		
TX-frequency range	GSM 850: 824 – 849MHz (Uplink), 869-894MHz (Downlink) GSM1900: 1850-1910MHz (Uplink), 1930-1990MHz (Downlink) FDD Band 2: 1852.4–1907.6 MHz (Uplink), 1930-1990MHz (Downlink) FDD Band 5: 826.4-846.6 MHz (Uplink), 869-894MHz (Downlink)		
Type of modulation	GSM-mode: GMSK GPRS-Mode: 8-PSK FDD-Mode Release99: QPSK FDD Mode Release 5+6: 16QAM additionally		
Number of channels	GSM 850: 128 – 251, 125 channels GSM1900: 512 – 810, 300 channels FDD Band 2: UARFCN range 9262 – 9400 – 9538 FDD Band 5: UARFCN range 4132 – 4183 – 4233		
EMISSION DESIGNATOR(S)	246KGXW (GSM850) 248KGXW (EDGE850) 243KG7W (GSM1900) 246KG7W (EDGE 1900)		
Antenna Type	<input checked="" type="checkbox"/> Integrated <input type="checkbox"/> External, no RF- connector <input type="checkbox"/> External, separate RF-connector		
FCC-ID	L6AREA70UW		
IC	2503A-REA70UW		
Installed option	<input checked="" type="checkbox"/> GSM900 and GSM1800 Bands (not usable in USA/Canada) <input checked="" type="checkbox"/> W-LAN, Bluetooth® <input checked="" type="checkbox"/> battery charging option <input checked="" type="checkbox"/> GPS (not tested within this test report)		
Power supply			
Special EMI components	--		
EUT sample type	<input type="checkbox"/> Production	<input checked="" type="checkbox"/> Pre-Production	<input type="checkbox"/> Engineering

Main function	Smartphone		
Type	REB71UW		
TX-frequency range	GSM 850: 824 – 849MHz (Uplink), 869-894MHz (Downlink) GSM1900: 1850-1910MHz (Uplink), 1930-1990MHz (Downlink) FDD Band 4: 1712.4–1752.6 MHz (Uplink), 2110-2155MHZ (Downlink)		
Type of modulation	GSM-mode: GMSK GPRS-Mode: 8-PSK FDD-Mode Release99: QPSK FDD Mode Release 5+6: 16QAM additionally		
Number of channels	GSM 850: 128 – 251, 125 channels GSM1900: 512 – 810, 300 channels FDD Band 4: UARFCN range 1312 – 1450 – 1513		
EMISSION DESIGNATOR(S)	246KGXW (GSM850) 248KGXW (EDGE850) 243KG7W (GSM1900) 246KG7W (EDGE 1900)		
Antenna Type	<input checked="" type="checkbox"/> Integrated <input type="checkbox"/> External, no RF- connector <input type="checkbox"/> External, separate RF-connector		
FCC-ID	L6AREB70UW		
IC	2503A-REB70UW		
Installed option	<input checked="" type="checkbox"/> GSM900 and GSM1800 Bands (not usable in USA/Canada) <input checked="" type="checkbox"/> W-LAN, Bluetooth® <input checked="" type="checkbox"/> battery charging option <input checked="" type="checkbox"/> GPS (not tested within this test report)		
Power supply			
Special EMI components	--		
EUT sample type	<input type="checkbox"/> Production	<input checked="" type="checkbox"/> Pre-Production	<input type="checkbox"/> Engineering

3.2. EUT: Type, S/N etc. and short descriptions used in this test report

Short description*)	EUT	Type	S/N serial number	HW hardware status	SW software status
EUT A	smartphone	REA71UW	Sample 27	Rev1	v7.0.0.368 PL: 9.32.0.13 Bundle: 1755
EUT B	smartphone	REA71UW	0044011384593 14	Rev2	v7.0.0.368 PL: 9.32.0.13 Bundle: 1755
EUT C	smartphone	REB71UW	004401138460 353	Rev2	v7.0.0.378 PL: 9.32.0.13 Bundle: 1755

*) EUT short description is used to simplify the identification of the EUT in this test report.

3.3. Auxiliary Equipment (AE): Type, S/N etc. and short descriptions

AE short description *)	Auxiliary Equipment	Type	S/N serial number	HW hardware status	SW software status
SHS1	Premium Stereo Headset	HDW-15766-005	N/A	N/A	N/A
SHS2	2nd gen Standard Stereo Headset (Hoisdén)	HDW-24529-001	N/A	N/A	N/A
SHS3	2nd gen Standard Stereo Headset (AAC)	HDW-24529-001	N/A	N/A	N/A
SHS4	Bluetooth Headset	HDW-25937-001	N/A	N/A	N/A
CH1	Cobra Fixed Blade (Flextronics) Rev1 (1.2m USB)	HDW-24481-001	N/A	N/A	N/A
CH2	Cobra Fixed Blade (Flextronics) Rev2	HDW-24481-001	N/A	N/A	N/A
CH3	Cobra Fixed Blade (Phihong)	HDW-24481-001	N/A	N/A	N/A
CH4	NA Folding Blade (1.8 Amp)	HDW-34724-001	N/A	N/A	N/A
CH5	NA Folding Blade - LC	HDW-44303-001	N/A	N/A	N/A
CH6	Worldwide Captive Cable Charger - 750mA	HDW-17957-003	N/A	N/A	N/A
CH7	Cobra EU Charger	HDW-29713-001	N/A	N/A	N/A
CH8	Cobra UK Charger	HDW-29714-001	N/A	N/A	N/A
CH9	Fixed Blade EU Charger	HDW-44303-002	N/A	N/A	N/A

N/A: not announced

AE short description *)	Auxiliary Equipment	Type	S/N serial number	HW hardware status	SW software status
USB_1	1.2m USB Cable	HDW-28109-003	N/A	N/A	N/A
USB_2	0.3m USB Cable	HDW-28109-001	N/A	N/A	N/A
USB_3	USB Y-Cable	HDW-19137-002	N/A	N/A	N/A
EBC	External Battery Charger	HDW-24478-001	N/A	N/A	N/A

*) AE short description is used to simplify the identification of the auxiliary equipment in this test report.
N/A: not announced

3.4. EUT set-ups

EUT set-up no. *)	Combination of EUT and AE	Remarks
Set. 1	EUT A + SHS_1 + CHR_6 + USB_1	
Set. 2	EUT A + SHS_2 + CHR_2 + USB_2	
Set. 3	EUT A + SHS_3 + CHR_3 + USB_2	
Set. 4	EUT A + SHS_4 + CHR_6 + USB_3 + EBC	
Set. 5	EUT A + SHS_1 + CHR_4 + USB_1	
Set. 6	EUT A + SHS_2 + CHR_5 + USB_2	
Set. 7	EUT B + Dummy battery	
Set. 8	EUT C + Dummy battery	

*) EUT set-up no. is used to simplify the identification of the EUT set-up in this test report.

3.5. EUT operating modes

EUT operating mode no. *)	Description of operating modes	Additional information
op. 1	GSM 850 Idle mode BCCH 50	The mobile station is synchronized to the Broadcast Control Channel (BCCH) and listening to the Common Control Channel (CCCH). Periodic location update is disabled.
op. 2	GSM 1900 Idle mode BCCH 651	The mobile station is synchronized to the Broadcast Control Channel (BCCH) and listening to the Common Control Channel (CCCH).
op. 3	UMTS UTRA/ FDD 2 IDLE-MODE	The mobile is synchronized to the UMTS base station.
op. 4	UMTS UTRA/ FDD 4 IDLE-MODE	The mobile is synchronized to the UMTS base station.
op. 5	UMTS UTRA/ FDD 5 IDLE-MODE	The mobile is synchronized to the UMTS base station.
op. 6	Charging battery	Charging standard battery. This operating mode is combined with other op. modes.

*) EUT operating mode no. is used to simplify the test report.

3.6. Parameter Settings on mobile phone and base station CMU200

Following settings apply to the MS during the measurements in **GSM/(E)GPRS-Mode** only:

Parameter	Traffic Mode	Idle Mode
Traffic Channels mobile station (EUT)	GSM 850 TCH _{MS} = 128/ 192 /251 GSM 1900 TCH _{MS} = 512 / 681 / 810	--
maximum power level (PCL)	GSM 850: PCL = 5 (2 Watt) GSM 1900: PCL = 0 (1 Watt)	--
Modulation	GSM: GMSK-Modulation Scheme EDGE: 8-PSK Modulation Scheme	--
DTX	off	--
Bitstream	PRBS 2E9-1 (pseudo-random-sequence) – CCITT 0.153	
Timeslot	3	
Hopping	off	
Timeslot (slot mode)	GSM-Mode: single GPRS-Mode: maximum allowed uplink slots no. according MS class	
Maximum data transmission rate, single time slot	GSM: 17,6 kBit/s Slot EDGE: 59,2 kBit/s Slot	
Speech transcoding (Traffic Mode)	Full rate Version 1	
Mode	BCCH and TCH	
BCCH – base station (CMU,CMD)		GSM 850: 182 GSM 1900: 651
TCH – base station (CMD, CMU)	auto	
Power level TCH – base station (used timeslot level)	- 70 dBm	
Power level BCCH – base station (control channel level)	- 80 dBm	
External attenuation RF/AF-Input/Output	Accord. calibration prior to measurements	
Mobile Country Code	310	310
BS_AG_BLK_RES	Not applicable	0
Paging reorganisation		Off (0)
Signalling channel		SDCCH
Location Update		Auto
Cell access		Disabled (barred)

Following settings apply to the UE (EUT) during the measurements in **FDD-Mode** only:

Parameter	Traffic Mode	Idle Mode
UARFCN UE Uplink (EUT) (according TS34.108)	FDD 2 = 9262/ 9400/ 9538 FDD4 FDD 5 = 4132/ 4183/ 4233	--
UARFCN Node B (downlink) (according TS34.108)	FDD 2 = 9663/ 9800/ 9937 FDD 5 = 4358/ 4040/ 4457 FDD 4 = 1538/ 1675/ 1737	
UE power class	Class 3 (+24dBm), Class 4 (+21dBm) nominal	
HSDPA UE category/ HSUPA category		
Maximum power	FDD 2/4/5 12.2kbps RMC -> all TPC bits up ("1") HSDPA-mode = accord. Subtests 1,2,3,4 defined in 3GPP TS34.121 HSUPA mode = accord. Subtests 1,2,3,4,5 defined in 3GPP TS34.121	--
Modulation	12.2kbps RMC-mode: QPSK-Modulation Scheme HSDPA/HSUPA = QPSK and 16 QAM Modulation Scheme is applicable	--
Compression mode	Off	--
Bitstream	PRBS 2E9-1 (pseudo-random-sequence) – CCITT 0.153	
Maximum data transmission rate:	GSM: 17,6 kBit/s Slot EDGE: 59,2 kBit/s Slot FDD: according defined UE category	
Node B Downlink physical channels settings	According Table E.5.1/E.5.1A in 3GPP TS34.121	
External attenuation RF/AF-Input/Output	Accord. Set-up calibration prior to measurements	

Settings for CMU (general)

Repetition	Continuous	
Stop condition	None	
Display mode	Max./Min	
Statistic Count	1000 Bursts	
Decoder	Standard	

Additional settings on the base stations CMU200 for frequency stability measurements

4. DESCRIPTION OF TEST SET-UP'S

4.1. Mode Test Set-up for conducted measurements

The EUT's RF-signal is coupled out by a suitable antenna coupling connector (1). The signal is first 10 dB attenuated (2) before it is 0° divided by a power divider (3). One of the signal path is connected to the communication base station (4), other branch is connected to the spectrum – analyzer (5). The specific attenuation losses for both signal paths/branches are determined prior to the measurement within a set-up calibration. These are then taken into account by correcting the measurement readings on the spectrum-analyzer.

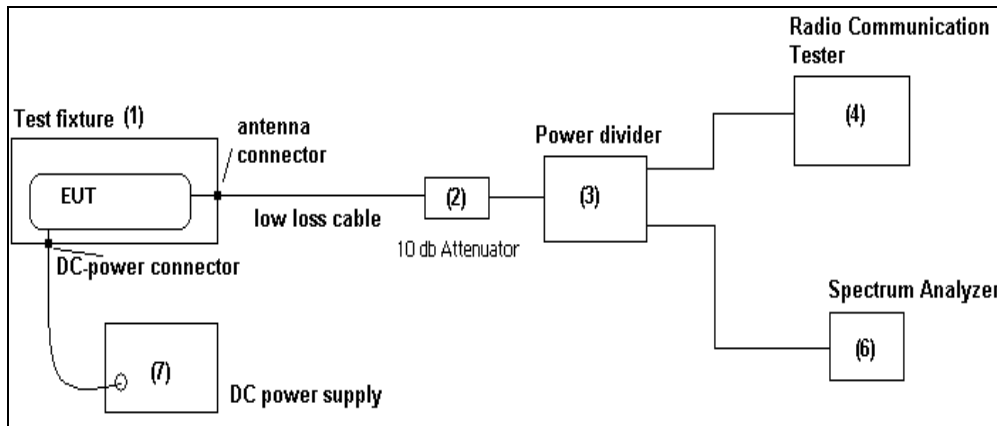

Schematic: Test set-up conducted

Following modified test set-up schematic apply for tests performed inside the climatic chamber: (Frequency stability)

4.2. Test set-up for radiated measurements

Please see below description and schematic for radiated measurements used set-up.

MEASUREMENT METHOD (30 MHz <math>f < 1 \text{ GHz}</math>):

A EMI analyzer together with a broadband antenna was used in order to identify the emissions from the EUT by positioning the antenna close to the EUT surfaces. The interconnecting cables and equipment position were varied in

order to maximize the emissions. Then most critical frequencies are recorded for further investigations. Based on the exploratory measurements, the most critical frequencies are re-measured by maintaining the EUT's operating mode, cable position, etc. The EUT was placed on a non-conductive support of 0.8 m height. By rotating the turntable angle in

the range 0 to 360 degree, the EUT itself either over 3-orthogonal axis (not defined usage position) or 2-orthogonal axis (defined usage position) and the measurement antenna height from 1 meter to 4 meters, the maximized emissions are recorded. The measurements are performed for both polarizations of the measuring antenna: horizontal and vertical.

MEASUREMENT METHOD (1 GHz <math>f < 26.5 \text{ GHz}</math>):

The EUT and accessories are placed on a non-conducting tipping table of 0.8 meter height (semi-anechoic chamber) or 1.55m height (fully-anechoic chamber) which is situated in the middle of the turntable. The turntable can rotate the device under test 360 degree, the tipping table can rotate the device from laid to standing position. This way the device under test can be rotated in all three orthogonal planes in order to maximize the detected emissions. The turn- and tipping table are controlled by a controller unit. All positions manipulations are software controlled from a operator PC.

The measurements are performed for both receiving antenna polarisations: vertical and horizontal.

Up to 18 GHz a measurement distance of 3 meters is used, above 18 GHz the distance is 1 meter. A biconical-logarithmic antenna up to 1 GHz and a logarithmic-periodic antenna for frequencies above 1 GHz up to 26.5 GHz is used. For frequencies above 26.5 GHz a horn antenna is used, pls. compare the equipment list for more details.

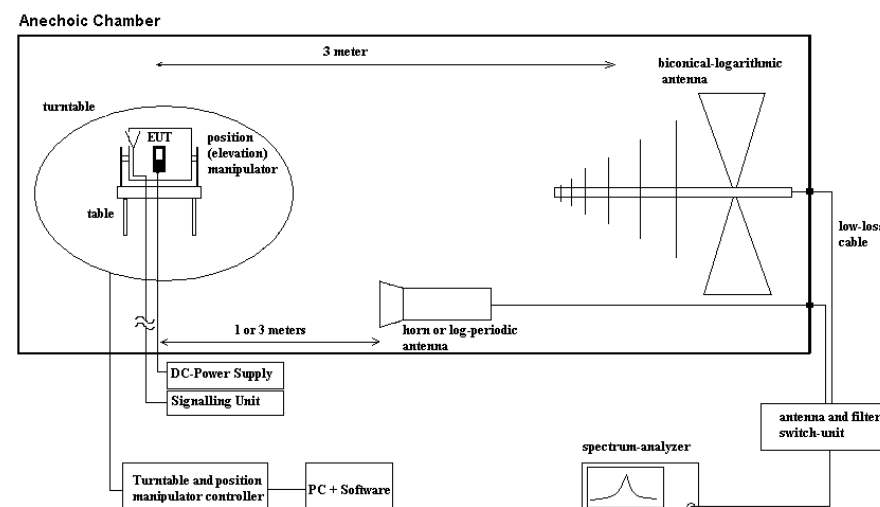

The EUT is powered either by a external DC-supply with nominal voltage or a AC/DC power supply as accessory. The communication signalling (if necessary for operation) is performed from outside the chamber with a communication test simulator (CMU200 from Rohde&Schwarz) and a signalling antenna place near the EUT.

Schematic: radiated measurements test set-up

5. Measurements

5.1. Conducted emissions on AC-Power lines

TEST LOCATION AND EQUIPMENT (for reference numbers please see chapter 'List of test equipment')

test location	<input checked="" type="checkbox"/> CETECOM Essen (Chapter 2.2.1)	<input type="checkbox"/> Please see Chapter 2.2.2	<input type="checkbox"/> Please see Chapter 2.2.3
test site	<input type="checkbox"/> 333 EMI field	<input checked="" type="checkbox"/> 348 EMI cond.	
receiver	<input type="checkbox"/> 001 ESS	<input checked="" type="checkbox"/> 377 ESCS 30	
LISN	<input checked="" type="checkbox"/> 005 ESH2-Z5	<input type="checkbox"/> 007 ESH3-Z6	<input type="checkbox"/> 300 ESH3-Z5 & 50Ω used for AE <input type="checkbox"/> no LISN for AE
signaling	<input type="checkbox"/> 392 MT8820A	<input checked="" type="checkbox"/> 436 CMU	<input type="checkbox"/> 547 CMU
line voltage	<input type="checkbox"/> 230 V 50 Hz via public mains	<input checked="" type="checkbox"/> 060 110 V 60 Hz via PAS 5000	

STANDARDS AND LIMITS: PART 15, SUBPART B, §15.107, §15.207, CANADA: RSS-Gen, ANSI C63.4:2009

Frequency [MHz]	Conducted limit Class B [dBμV]	
	QUASI-Peak	AVERAGE
0.15 – 0.5	66 to 56*	56 to 46*
0.5 – 5	56	46
5 – 30	60	50

Remark: * decreases with the logarithm of the frequency

TEST CONDITION AND MEASUREMENT PROCEDURES TEST SET-UP

link to test system (if used):	<input checked="" type="checkbox"/> air link	<input type="checkbox"/> cable connection	<input type="checkbox"/>
EUT-grounding	<input checked="" type="checkbox"/> none	<input type="checkbox"/> with power supply	<input type="checkbox"/> additional connection
Equipment set up	<input checked="" type="checkbox"/> table top (40 cm distance to reference ground plane (wall))	<input type="checkbox"/> floor standing EUT stands isolated on reference ground plane (floor)	
Climatic conditions	Temperature: (22±3°C)	Rel. humidity: (40±20)%	
EMI-Receiver (Analyzer) Settings	Span/Range: 150 kHz to 30 MHz RBW: 9 kHz Detector/Mode: Max PEAK-hold, repetitive scan for preliminary testing Quasi-Peak Detector and Average-Detector for final measurement according ANSI 63.4, CISPR 16		

Devices which can be connected to the public AC-power network, should be tested against the radio frequency voltage conducted back into the AC-power line in the frequency range 150kHz to 30 MHz. Compliance should be tested by measuring the radio frequency voltage between each power line and ground at the power terminals in the stated frequency range.

A 500hm/50μH line impedance stabilization network (LISN) is used therefore. The EUT power input leads are connected through the LISN to the AC-power source. The LISN enclosure is electrically connected to the GND-plane. The measuring instrument is connected to the coaxial output of the LISN.

Tabletop devices were set-up on a 80 cm height over reference ground plane, floor standing equipment 10 cm raised above ground plane.

Measurements have been performed on each phase line and neutral line of the devices AC-power lines. The EUT was power supplied with 110 V/60Hz.

The EUT was tested in the defined operating mode and installed (connected) to accessory equipment according the general description of use given by the applicant.

Preliminary testing as a first step, determines the worst-case phase line (neutral or phase) as well as the most critical amplitude by changing the operating mode. A complete frequency-sweep is performed with PK-Detector.

Final testing for power phases and critical frequencies (Margin to AV- or QP limit lower than 3dB) as a second step includes measurements either on discrete frequency components with receivers detector set to Quasi-Peak and Average per frequency component or a complete frequency sweep with corresponding detector.

MEASUREMENT RESULTS

EUT Type and S/N or EUT set-up no.		EUT set-up: see below			
EUT operating mode		EUT operating mode: see below			
Diagram No.	Command or EUT operating mode or operating mode no.	Detector (Peak, CISPR AV, CISPR QP)	Power line (L1, L2, L3, N)	Additional (scan-) information (e.g. Pre-test Fast scan, Maxhold, Final measurement)	Result (passed / failed /final measurem. necessary)
1.1	EUT set-up 1 EUT op. mode 1 + 6	Peak, CISPR AV, CISPR QP	L1, N	Pre-test Fast scan, Maxhold Final measurement (please see diagram)	passed
1.2	EUT set-up 2 EUT op. mode 2 + 6	Peak, CISPR AV, CISPR QP	L1, N	Pre-test Fast scan, Maxhold Final measurement (please see diagram)	passed
1.3	EUT set-up 3 EUT op. mode 3 + 6	Peak, CISPR AV, CISPR QP	L1, N	Pre-test Fast scan, Maxhold Final measurement (please see diagram)	passed
1.4	EUT set-up 4 EUT op. mode 4 + 6	Peak, CISPR AV, CISPR QP	L1, N	Pre-test Fast scan, Maxhold Final measurement (please see diagram)	passed
1.5	EUT set-up 5 EUT op. mode 1 + 6	Peak, CISPR AV, CISPR QP	L1, N	Pre-test Fast scan, Maxhold Final measurement (please see diagram)	passed
1.6	EUT set-up 6 EUT op. mode 2 + 6	Peak, CISPR AV, CISPR QP	L1, N	Pre-test Fast scan, Maxhold Final measurement (please see diagram)	passed

Remarks: The diagram contains the maximum values from L 1 + N

Margin to Limit for verdict: $M = L_T - R_R + C_{Loss}$

Abbreviations used:

- R_R : Receiver readings in dB μ V
- C_{Loss} : cable loss
- L_T : Limit in dB μ V

VERDICT

Summary of measurement results for conducted emissions on AC-Power lines: Passed

5.2. Radiated field strength emissions, 30 MHz - 1 GHz

TEST LOCATION AND EQUIPMENT (for reference numbers please see chapter 'List of test equipment')

test location	<input checked="" type="checkbox"/> CETECOM Essen (Chapter. 2.2.1)	<input type="checkbox"/> Please see Chapter. 2.2.2	<input type="checkbox"/> Please see Chapter. 2.2.3
test site	<input checked="" type="checkbox"/> 441 EMI SAR	<input type="checkbox"/> 487 SAR NSA	
receiver	<input checked="" type="checkbox"/> 377 ESCS30	<input checked="" type="checkbox"/> 001 ESS	<input type="checkbox"/>
spectr. analys.	<input type="checkbox"/> 584 FSU	<input type="checkbox"/> 120 FSEM	<input type="checkbox"/> 264 FSEK
antenna	<input type="checkbox"/> 574 BTA-L	<input type="checkbox"/> 133 EMCO3115	<input type="checkbox"/> 302 BBHA9170 <input type="checkbox"/> 289 CBL 6141 <input type="checkbox"/> 030 HFH-Z2 <input type="checkbox"/> 477 GPS
signaling	<input type="checkbox"/> 392 MT8820A	<input type="checkbox"/> 436 CMU	<input type="checkbox"/> 547 CMU
otherwise	<input type="checkbox"/> 400 FTC40x15E	<input type="checkbox"/> 401 FTC40x15E	<input type="checkbox"/> 110 USB LWL <input checked="" type="checkbox"/> 482 Filter Matrix
DC power	<input type="checkbox"/> 456 EA 3013A	<input type="checkbox"/> 457 EA 3013A	<input type="checkbox"/> 459 EA 2032-50 <input type="checkbox"/> 268 EA- 3050 <input type="checkbox"/> 494 AG6632A <input type="checkbox"/> 498 NGPE
line voltage	<input type="checkbox"/> 230 V 50 Hz via public mains	<input checked="" type="checkbox"/> 060 110 V 60 Hz via PAS 5000	

STANDARDS AND LIMITS: CFR 47, PART 15B, §15.109, RSS-Gen, ANSI 63.4:2009

Frequency [MHz]	Radiated emission limits, Class B, 3 meters	
	QUASI-Peak [microvolts/meter]	QUASI-Peak [dBµV/m]
30-88	100	40
88-216	150	43,5
216-960	200	46,0
above 960	500	54,0

TEST CONDITION AND MEASUREMENT TEST SET-UP

link to test system (if used):	<input checked="" type="checkbox"/> air link	<input type="checkbox"/> cable connection	<input type="checkbox"/>
EUT-grounding	<input checked="" type="checkbox"/> none	<input type="checkbox"/> with power supply	<input type="checkbox"/> additional connection
Equipment set up	<input checked="" type="checkbox"/> table top 0.8m height	<input type="checkbox"/> floor standing	
Climatic conditions	Temperature: (22±3°C)		Rel. humidity: (40±20)%
EMI-Receiver (Analyzer) Settings	Span/Range: 30 MHz to 1 GHz RBW/VBW: 120 kHz / (auto) Detector/ Mode: PEAK, TRACE max-hold mode, repetitive scan Quasi-Peak, for final measurement for critical measurements		

GENERAL MEASUREMENT PROCEDURES:

The measurement test set-up and test procedure are in accordance with the provisions described in ANSI 63.4: 2009

The *Equipment under Test* (EUT) set-up to defined operating mode and installed (connected) to accessory equipment according the general description of use given by the applicant.

MEASUREMENT RESULTS

EUT Type and S/N EUT set-up no.		EUT set-up 1		
Diagram No.	Test parameter: Frequency range 30 MHz – 1000 MHz IF Bandwidth at 6 dB: 120 kHz,	Op. mode	Result	
2.01	Pre-measurement, variation of turntable positions Searching critical frequencies for determined critical operating mode with peak detector, repetitive scan and max-hold mode. The antenna heights are 1.0 m + 1.82 m (both heights for all measured turntable positions).		Op. mode 1 + 6	Final measurement carried out
	Polarisation of antenna:	<input type="checkbox"/> horizontal <input type="checkbox"/> vertical <input checked="" type="checkbox"/> horizontal and vertical		
	Receiving antenna directed to EUT side: (Turntable position during pre-measurement)	<input checked="" type="checkbox"/> front (0°) <input checked="" type="checkbox"/> right (90°) <input checked="" type="checkbox"/> rear (180°) <input checked="" type="checkbox"/> left (270°)	<input checked="" type="checkbox"/> EUT tipping device in vertical position (= 0°) used	
		<input checked="" type="checkbox"/> under (0°) <input checked="" type="checkbox"/> top (180°)	<input checked="" type="checkbox"/> EUT tipping device in horiz. position (= 90°) used	
	Critical frequencies found:	<input type="checkbox"/> no, margin to limit > 6 dB with PK detector <input checked="" type="checkbox"/> yes, final measurement with QP detector carried out		
	Step 3: Final measurement at critical frequencies (to find the worst case with Peak and CISPR QP detector)			
	Antenna height:	<input checked="" type="checkbox"/> moved from 1.0 m to 4.0 m continuously		passed
Turntable:	<input checked="" type="checkbox"/> turned from 0° to 360° continuously			
EUT Tipping device:	Please see Step 2			

Remarks:

- Mounting position / usual operating position is defined => under and top side of EUT are not measured
- Signals over limit are due to wanted GSM 850 MHz signals and will be ignored.

EUT Type and S/N EUT set-up no.		EUT set-up 2		
Diagram No.	Test parameter: Frequency range 30 MHz – 1000 MHz IF Bandwidth at 6 dB: 120 kHz,	Op. mode	Result	
2.02	Pre-measurement, variation of turntable positions Searching critical frequencies for determined critical operating mode with peak detector, repetitive scan and max-hold mode. The antenna heights are 1.0 m + 1.82 m (both heights for all measured turntable positions).		Op. mode 2 + 6	Final measurement carried out
	Polarisation of antenna:	<input type="checkbox"/> horizontal <input type="checkbox"/> vertical <input checked="" type="checkbox"/> horizontal and vertical		
	Receiving antenna directed to EUT side: (Turntable position during pre-measurement)	<input checked="" type="checkbox"/> front (0°) <input checked="" type="checkbox"/> right (90°) <input checked="" type="checkbox"/> rear (180°) <input checked="" type="checkbox"/> left (270°)	<input checked="" type="checkbox"/> EUT tipping device in vertical position (= 0°) used	
		<input checked="" type="checkbox"/> under (0°) <input checked="" type="checkbox"/> top (180°)	<input checked="" type="checkbox"/> EUT tipping device in horiz. position (= 90°) used	
	Critical frequencies found:	<input type="checkbox"/> no, margin to limit > 6 dB with PK detector <input checked="" type="checkbox"/> yes, final measurement with QP detector carried out		
	Step 3: Final measurement at critical frequencies (to find the worst case with Peak and CISPR QP detector)			
	Antenna height:	<input checked="" type="checkbox"/> moved from 1.0 m to 4.0 m continuously		passed
Turntable:	<input checked="" type="checkbox"/> turned from 0° to 360° continuously			
EUT Tipping device:	Please see Step 2			

Remarks:

- Mounting position / usual operating position is defined => under and top side of EUT are not measured
- Signals over limit are due to wanted GSM 900 MHz signals and will be ignored.

EUT Type and S/N EUT set-up no.		EUT set-up 3			
Diagram No.	Test parameter: Frequency range 30 MHz – 1000 MHz IF Bandwidth at 6 dB: 120 kHz,	Op. mode	Result		
2.03	Pre-measurement, variation of turntable positions Searching critical frequencies for determined critical operating mode with peak detector, repetitive scan and max-hold mode. The antenna heights are 1.0 m + 1.82 m (both heights for all measured turntable positions).		Op. mode 3 + 6	Final measurement carried out	
	Polarisation of antenna:	<input type="checkbox"/> horizontal <input type="checkbox"/> vertical <input checked="" type="checkbox"/> horizontal and vertical			
	Receiving antenna directed to EUT side: (Turntable position during pre-measurement)	<input checked="" type="checkbox"/> front (0°) <input checked="" type="checkbox"/> right (90°) <input checked="" type="checkbox"/> rear (180°) <input checked="" type="checkbox"/> left (270°)	<input checked="" type="checkbox"/> EUT tipping device in vertical position (= 0°) used		
		<input checked="" type="checkbox"/> under (0°) <input checked="" type="checkbox"/> top (180°)	<input checked="" type="checkbox"/> EUT tipping device in horiz. position (= 90°) used		
	Critical frequencies found:	<input type="checkbox"/> no, margin to limit > 6 dB with PK detector <input checked="" type="checkbox"/> yes, final measurement with QP detector carried out			
	Step 3: Final measurement at critical frequencies (to find the worst case with Peak and CISPR QP detector)				
	Antenna height:	<input checked="" type="checkbox"/> moved from 1.0 m to 4.0 m continuously		passed	
Turntable:	<input checked="" type="checkbox"/> turned from 0° to 360° continuously				
EUT Tipping device:	Please see Step 2				

Remarks:

- Mounting position / usual operating position is defined => under and top side of EUT are not measured
- Signals over limit are due to wanted GSM 850 MHz signals and will be ignored.

EUT Type and S/N EUT set-up no.		EUT set-up 4			
Diagram No.	Test parameter: Frequency range 30 MHz – 1000 MHz IF Bandwidth at 6 dB: 120 kHz,	Op. mode	Result		
2.04	Pre-measurement, variation of turntable positions Searching critical frequencies for determined critical operating mode with peak detector, repetitive scan and max-hold mode. The antenna heights are 1.0 m + 1.82 m (both heights for all measured turntable positions).		Op. mode 4 + 6	Final measurement carried out	
	Polarisation of antenna:	<input type="checkbox"/> horizontal <input type="checkbox"/> vertical <input checked="" type="checkbox"/> horizontal and vertical			
	Receiving antenna directed to EUT side: (Turntable position during pre-measurement)	<input checked="" type="checkbox"/> front (0°) <input checked="" type="checkbox"/> right (90°) <input checked="" type="checkbox"/> rear (180°) <input checked="" type="checkbox"/> left (270°)	<input checked="" type="checkbox"/> EUT tipping device in vertical position (= 0°) used		
		<input checked="" type="checkbox"/> under (0°) <input checked="" type="checkbox"/> top (180°)	<input checked="" type="checkbox"/> EUT tipping device in horiz. position (= 90°) used		
	Critical frequencies found:	<input type="checkbox"/> no, margin to limit > 6 dB with PK detector <input checked="" type="checkbox"/> yes, final measurement with QP detector carried out			
	Step 3: Final measurement at critical frequencies (to find the worst case with Peak and CISPR QP detector)				
	Antenna height:	<input checked="" type="checkbox"/> moved from 1.0 m to 4.0 m continuously		passed	
Turntable:	<input checked="" type="checkbox"/> turned from 0° to 360° continuously				
EUT Tipping device:	Please see Step 2				

Remarks:

- Mounting position / usual operating position is defined => under and top side of EUT are not measured
- Signals over limit are due to wanted GSM 900 MHz signals and will be ignored.

EUT Type and S/N EUT set-up no.		EUT set-up 5		
Diagram No.	Test parameter: Frequency range 30 MHz – 1000 MHz IF Bandwidth at 6 dB: 120 kHz,	Op. mode	Result	
2.05	Pre-measurement, variation of turntable positions Searching critical frequencies for determined critical operating mode with peak detector, repetitive scan and max-hold mode. The antenna heights are 1.0 m + 1.82 m (both heights for all measured turntable positions).		Op. mode 1 + 6	Final measurement carried out
	Polarisation of antenna:	<input type="checkbox"/> horizontal <input type="checkbox"/> vertical <input checked="" type="checkbox"/> horizontal and vertical		
	Receiving antenna directed to EUT side: (Turntable position during pre-measurement)	<input checked="" type="checkbox"/> front (0°) <input checked="" type="checkbox"/> right (90°) <input checked="" type="checkbox"/> rear (180°) <input checked="" type="checkbox"/> left (270°)	<input checked="" type="checkbox"/> EUT tipping device in vertical position (= 0°) used	
		<input checked="" type="checkbox"/> under (0°) <input checked="" type="checkbox"/> top (180°)	<input checked="" type="checkbox"/> EUT tipping device in horiz. position (= 90°) used	
	Critical frequencies found:	<input type="checkbox"/> no, margin to limit > 6 dB with PK detector <input checked="" type="checkbox"/> yes, final measurement with QP detector carried out		
	Step 3: Final measurement at critical frequencies (to find the worst case with Peak and CISPR QP detector)			
	Antenna height:	<input checked="" type="checkbox"/> moved from 1.0 m to 4.0 m continuously		passed
Turntable:	<input checked="" type="checkbox"/> turned from 0° to 360° continuously			
EUT Tipping device:	Please see Step 2			

Remarks:

- Mounting position / usual operating position is defined => under and top side of EUT are not measured
- Signals over limit are due to wanted GSM 850 MHz signals and will be ignored.

EUT Type and S/N EUT set-up no.		EUT set-up 6		
Diagram No.	Test parameter: Frequency range 30 MHz – 1000 MHz IF Bandwidth at 6 dB: 120 kHz,	Op. mode	Result	
2.06	Pre-measurement, variation of turntable positions Searching critical frequencies for determined critical operating mode with peak detector, repetitive scan and max-hold mode. The antenna heights are 1.0 m + 1.82 m (both heights for all measured turntable positions).		Op. mode 2 + 6	Final measurement carried out
	Polarisation of antenna:	<input type="checkbox"/> horizontal <input type="checkbox"/> vertical <input checked="" type="checkbox"/> horizontal and vertical		
	Receiving antenna directed to EUT side: (Turntable position during pre-measurement)	<input checked="" type="checkbox"/> front (0°) <input checked="" type="checkbox"/> right (90°) <input checked="" type="checkbox"/> rear (180°) <input checked="" type="checkbox"/> left (270°)	<input checked="" type="checkbox"/> EUT tipping device in vertical position (= 0°) used	
		<input checked="" type="checkbox"/> under (0°) <input checked="" type="checkbox"/> top (180°)	<input checked="" type="checkbox"/> EUT tipping device in horiz. position (= 90°) used	
	Critical frequencies found:	<input type="checkbox"/> no, margin to limit > 6 dB with PK detector <input checked="" type="checkbox"/> yes, final measurement with QP detector carried out		
	Step 3: Final measurement at critical frequencies (to find the worst case with Peak and CISPR QP detector)			
	Antenna height:	<input checked="" type="checkbox"/> moved from 1.0 m to 4.0 m continuously		passed
Turntable:	<input checked="" type="checkbox"/> turned from 0° to 360° continuously			
EUT Tipping device:	Please see Step 2			

Remarks:

- Mounting position / usual operating position is defined => under and top side of EUT are not measured
- Signals over limit are due to wanted GSM 900 MHz signals and will be ignored.

<p>Margin to Limit:</p> $M = L_T - R_R + C_F + D_F$ $= L_T - R_R + (AF_{ANTENNA} + Cable_{LOSS}) + D_F$ <p>Remark: positive margin means passed result</p>	<p>Abbreviations used:</p> <ul style="list-style-type: none"> • R_R : Receiver readings in dBμV/m • CF: Transducer in dB = AF (antenna factor) + CL (cable loss) • D_F: distance correction factor (if different measurement distance used than specified in the standard) • L_T : Limit in dBμV/m
---	--

VERDICT

Summary of measurement results for radiated emissions above 30 MHz and below 1 GHz : Passed

5.3. Radiated emissions, above 1GHz

TEST LOCATION AND EQUIPMENT (for reference numbers please see chapter 'List of test equipment')

test site	<input type="checkbox"/> 441 EMI SAR	<input type="checkbox"/> 348 EMI cond.	<input checked="" type="checkbox"/> 443 EMI FAR	<input type="checkbox"/> 347 Radio.lab.	<input type="checkbox"/> 337 OATS	<input type="checkbox"/>
equipment	<input type="checkbox"/> 331 HC 4055	<input type="checkbox"/>	<input type="checkbox"/>	<input type="checkbox"/>	<input type="checkbox"/>	<input type="checkbox"/>
spectr. analys.	<input type="checkbox"/> 584 FSU	<input type="checkbox"/> 120 FSEM	<input type="checkbox"/> 264 FSEK	<input checked="" type="checkbox"/> 489 ESU	<input type="checkbox"/>	<input type="checkbox"/>
antenna meas	<input type="checkbox"/> 574 BTA-L	<input type="checkbox"/> 289 CBL 6141	<input checked="" type="checkbox"/> 608 HL 562	<input checked="" type="checkbox"/> 549 HL025	<input type="checkbox"/> 302 BBHA9170	<input type="checkbox"/> 477 GPS
antenna meas	<input type="checkbox"/> 123 HUF-Z2	<input type="checkbox"/> 132 HUF-Z3	<input type="checkbox"/> 030 HFH-Z2	<input type="checkbox"/>	<input type="checkbox"/>	<input type="checkbox"/>
antenna subst	<input type="checkbox"/> 071 HUF-Z2	<input type="checkbox"/> 020 EMCO3115	<input type="checkbox"/> 063 LP 3146	<input type="checkbox"/> 303 BBHA9170	<input type="checkbox"/>	<input type="checkbox"/>
power meter	<input type="checkbox"/> 009 NRV	<input type="checkbox"/> 010 URV5-Z2	<input type="checkbox"/> 011 URV5-Z2	<input type="checkbox"/>	<input type="checkbox"/>	<input type="checkbox"/>
signalgener.	<input type="checkbox"/> 008 SMG	<input type="checkbox"/> 140 SMHU	<input type="checkbox"/> 263 SMP04	<input type="checkbox"/>	<input type="checkbox"/>	<input type="checkbox"/>
power meter	<input type="checkbox"/> 262 NRV-S	<input type="checkbox"/> 266 NRV-Z31	<input type="checkbox"/> 265 NRV-Z33	<input type="checkbox"/> 261 NRV-Z55	<input type="checkbox"/> 356 NRV-Z1	<input type="checkbox"/>
multimeter	<input type="checkbox"/> 341 Fluke 112	<input type="checkbox"/>	<input type="checkbox"/>	<input type="checkbox"/>	<input type="checkbox"/>	<input type="checkbox"/>
signaling	<input type="checkbox"/> 392 MT8820A	<input checked="" type="checkbox"/> 436 CMU	<input type="checkbox"/> 547 CMU			
DCpower	<input type="checkbox"/> 086 LNG50-10	<input type="checkbox"/> 087 EA3013	<input type="checkbox"/> 354 NGPE 40	<input type="checkbox"/> 349 car battery	<input type="checkbox"/> 350 Car battery	<input type="checkbox"/>
line voltage	<input type="checkbox"/> 230 V 50 Hz via public mains		<input checked="" type="checkbox"/> 060 110 V 60 Hz via PAS 5000			

STANDARDS AND LIMITS: CFR 47, §15.109 (CLASS B), RSS-Gen, ANSI C63.4:2009

Frequency [MHz]	Radiated emission limits, 3 meters measurement distance			
	AV [microvolts/meter]	AV [dBµV/m]	Peak [microvolts/meter]	Peak [dBµV/m]
above 1GHz	500	54.0	5000	74.0

TEST CONDITION AND MEASUREMENT TEST SET-UP

link to test system (if used):	<input checked="" type="checkbox"/> air link	<input type="checkbox"/> cable connection	<input type="checkbox"/>
EUT-grounding	<input checked="" type="checkbox"/> none	<input type="checkbox"/> with power supply	<input type="checkbox"/> additional connection
Equipment set up	<input checked="" type="checkbox"/> table top 1.5m height		<input type="checkbox"/> floor standing
Climatic conditions	Temperature: (22±3°C)		Rel. humidity: (40±20)%
Spectrum-Analyzer settings	Span/Frequency range : GSM850: 1..12.75 GHz +single frequencies determined in step 1 GSM1900: 1..18GHz+single frequencies determined in step 1 RBW/VBW: 1 MHz / 3 MHz Detector/ Mode: Peak, MAX-hold, repetitive scan for exploratory measurement PEAK/ AVERAGE, for final measurement for critical frequencies Antenna Polarisation Horizontal / Vertical		

GENERAL MEASUREMENT PROCEDURES:

The measurement test set-up and test procedure are in accordance with the provisions described in ANSI 63.4: 2009 (RX)

The *Equipment under Test* (EUT) was placed on a non-conductive positioning table of 0.8 or 1.5 meter height depending from the frequency range. The measuring distance was set to 3 meter for frequencies up to 18GHz and 1 meter above 18GHz.

The EUT was set-up to defined operating mode and installed (connected) to accessory equipment according the general description of use given by the applicant.

For the upper frequency measurement range, it was assumed that the highest frequency generated in the device is same as the highest operable TX-frequency in GSM850 or GSM1900 Mode (848.8MHz or 1909.8 MHz). For practical reasons the upper frequency limit was set to 12.75 or respective 18GHz.

1. Step exploratory measurement: see above description as in the frequency range lower 1GHz.

2. Step Final Measurement(1 GHz<f <18 GHz): On the Worst-Case EUT configuration, frequency components with a margin lower than 6 dB to the limits, will be re-measured by maintaining the EUT's operating mode, cable position, etc.. For find the worst-case emission, the turntable was changed in the range 0 to 360 degree and the EUT itself either over 3-orthogonal axis (not defined usage position) or 2-orthogonal axis (defined usage position). The measurements are performed for both polarizations of the measuring antenna: horizontal and vertical.

Set-up No.:			EUT set-up 1								
Operating Mode:			Op. mode 1 + 6								
Diagram no.	Start-Frequency (MHz)	Stop-Frequency (MHz)	MaxPeak (dB μ V/m)	Meas. Time (ms)	Bandwidth (kHz)	Antenna height (cm)	Polarity	Turntable position (deg)	Corr. (dB) (C _F)	Margin (dB) (M)	Limit (dB μ V/m) (L _T)
2.07	1000	2800	Please see diagram								Passed
2.08	1000	5000	Please see diagram								Passed

Remarks:

Set-up No.:			EUT set-up 2								
Operating Mode:			Op. mode 2 + 6								
Diagram no.	Start-Frequency (MHz)	Stop-Frequency (MHz)	MaxPeak (dB μ V/m)	Meas. Time (ms)	Bandwidth (kHz)	Antenna height (cm)	Polarity	Turntable position (deg)	Corr. (dB) (C _F)	Margin (dB) (M)	Limit (dB μ V/m) (L _T)
2.09	1000	2800	Please see diagram								Passed
2.10	1000	10000	Please see diagram								Passed

Remarks:

Set-up No.:			EUT set-up 3								
Operating Mode:			Op. mode 3 + 6								
Diagram no.	Start-Frequency (MHz)	Stop-Frequency (MHz)	MaxPeak (dB μ V/m)	Meas. Time (ms)	Bandwidth (kHz)	Antenna height (cm)	Polarity	Turntable position (deg)	Corr. (dB) (C _F)	Margin (dB) (M)	Limit (dB μ V/m) (L _T)
2.11	1000	2800	Please see diagram								Passed
2.12	1000	10000	Please see diagram								Passed

Remarks:

Set-up No.:			EUT set-up 4								
Operating Mode:			Op. mode 4 + 6								
Diagram no.	Start-Frequency (MHz)	Stop-Frequency (MHz)	MaxPeak (dBμV/m)	Meas. Time (ms)	Bandwidth (kHz)	Antenna height (cm)	Polarity	Turntable position (deg)	Corr. (dB) (C _F)	Margin (dB) (M)	Limit (dBμV/m) (L _T)
2.13	1000	2800	Please see diagram								Passed
2.14	1000	5000	Please see diagram								Passed

Remarks:

Set-up No.:			EUT set-up 5								
Operating Mode:			Op. mode 1 + 6								
Diagram no.	Start-Frequency (MHz)	Stop-Frequency (MHz)	MaxPeak (dBμV/m)	Meas. Time (ms)	Bandwidth (kHz)	Antenna height (cm)	Polarity	Turntable position (deg)	Corr. (dB) (C _F)	Margin (dB) (M)	Limit (dBμV/m) (L _T)
2.15	1000	2800	Please see diagram								Passed
2.16	1000	5000	Please see diagram								Passed

Remarks:

Set-up No.:			EUT set-up 6								
Operating Mode:			Op. mode 2 + 6								
Diagram no.	Start-Frequency (MHz)	Stop-Frequency (MHz)	MaxPeak (dBμV/m)	Meas. Time (ms)	Bandwidth (kHz)	Antenna height (cm)	Polarity	Turntable position (deg)	Corr. (dB) (C _F)	Margin (dB) (M)	Limit (dBμV/m) (L _T)
2.17	1000	2800	Please see diagram								Passed
2.18	1000	10000	Please see diagram								Passed

Remarks:

<p>Margin to Limit:</p> $M = L_T - R_R + C_F + D_F$ $= L_T - R_R + (AF_{ANTENNA} + Cable_{LOSS}) + D_F$ <p>Remark: positive margin means passed result</p>	<p>Abbreviations used:</p> <ul style="list-style-type: none"> • R_R : Receiver readings in dBμV/m • C_F: Transducer in dB = AF (antenna factor) + CL (cable loss) • D_F : distance correction factor (if different measurement distance used than specified in the standard) • L_T : Limit in dBμV/m
---	---

VERDICT

Summary of measurement results for radiated emissions above 1 GHz : Passed

5.4. Conducted emissions on antenna port (RX-Mode)

Test location and equipment (for reference numbers please see chapter 'List of test equipment')

test location	<input checked="" type="checkbox"/> CETECOM Essen (Chapter. 2.2.1)	<input type="checkbox"/> Please see Chapter. 2.2.2	<input type="checkbox"/> Please see Chapter. 2.2.3
test site	<input type="checkbox"/> 441 EMI SAR	<input type="checkbox"/> 487 SAR NSA	<input type="checkbox"/> 337 OATS <input checked="" type="checkbox"/> 347 Radio.lab.
receiver	<input type="checkbox"/> 377 ESCS30	<input type="checkbox"/> 001 ESS	<input checked="" type="checkbox"/> ESU
spectr. analys.	<input type="checkbox"/> 574 FSU	<input type="checkbox"/> 120 FSEM	<input type="checkbox"/> 264 FSEK
signaling	<input type="checkbox"/> 392 MT8820A	<input type="checkbox"/> 436 CMU	<input type="checkbox"/> 547 CMU
power supply	<input type="checkbox"/> 456 EA 3013A	<input type="checkbox"/> 457 EA 3013A	<input type="checkbox"/> 459 EA 2032-50 <input type="checkbox"/> 268 EA- 3050 <input type="checkbox"/> 494 AG6632A <input checked="" type="checkbox"/> 498 NGPE 40
otherwise	<input type="checkbox"/> 400 FTC40x15E	<input type="checkbox"/> 401 FTC40x15E	<input type="checkbox"/> 110 USB LWL <input checked="" type="checkbox"/> 482 Filter Matrix
line voltage	<input type="checkbox"/> 230 V 50 Hz via public mains <input checked="" type="checkbox"/> 060 110 V 60 Hz via PAS 5000		

Standards and Limits: CFR 47, §15.111(a), RSS-132, RSS-133, RSS-Gen

Standard	conducted emission limits on antenna port	
	Value / [nW]	Value / [dBm]
FCC: §15.111(a)	2 nW for all frequencies	-57 dBm
RSS-Gen	2 nW below 1GHz	-57 dBm
RSS-132	5 nW about 1GHz	-53 dBm
RSS-133		

Test condition and measurement test set-up

link to test system (if used):	<input type="checkbox"/> Air-link	<input checked="" type="checkbox"/> cable connection
Climatic conditions	Temperature: (22±3°C)	Rel. humidity: (40±20)%
EMI-Receiver (Analyzer) Settings	Please see diagram	

GENERAL MEASUREMENT PROCEDURES:

The measurement test set-up and test procedure are in accordance with the provisions described in ANSI C63.4: 2009

The *Equipment under Test* (EUT) set-up to defined operating mode and installed (connected) to accessory equipment according the general description of use given by the applicant.

The test set-up 7 + 8 for conducted measurements was used

5.4.1. Conducted emissions on antenna port, §15.111(a) and Canada requirements, RSS-132, Issue 2, §4.6

5.4.1.1. IDLE GSM850

BCCH channel = 182 (Downlink)								
Sweep frequency range: [MHz]	Diagram number	Frequency of emission [MHz]	Transducer factor [dB]	Correction factor for Canada only (RBW:3kHz->4kHz)	Result FCC [dBm]	Result Canada [dBm]	Limit [dBm]	Verdict
Sweep 1 150kHz.. 1000MHz	Please see chapter 1.4.1 in annex A1	--	--	+ 1.25 dB	<-70.0	<-68.75	-57	Passed ^{2.)}
Sweep 2 1 .. 10 GHz		--	--		<-63.44	<-64.69	-53	Passed
Sweep 3 10 to 26,5GHz		15.654 GHz	--		-54.66	-55.91	-53	Passed ^{3.)}

Remark: Please see diagrams in Annex A1 for more details

2.) Peak from measurement set-up, BCCH carrier of base station

3.) internal spurious component from measurement set-up

5.4.1.2. IDLE W-CDMA Band V

BCCH channel = at 880MHz								
Sweep frequency range: [MHz]	Diagram number	Frequency of emission [MHz]	Transducer factor [dB]	Correction factor for Canada only (RBW:3kHz->4kHz)	Result FCC [dBm]	Result Canada [dBm]	Limit [dBm]	Verdict
Sweep 1 150kHz.. 1000MHz	Please see chapter 1.4.3 in annex A1	--	--	+ 1.25 dB	<-70.0	<-68.75	-57	Passed ^{2.)}
Sweep 2 1 .. 10 GHz		6.6227	--		<-62.15	<-63.4	-53	Passed
Sweep 3 10 to 26,5GHz		15.654 GHz	--		-55.04	-56.29	-53	Passed

Remark: Please see diagrams in separated Annex A1 for more details

- 2.) Peak from measurement set-up, BCCH carrier of base station
- 3.) internal spurious component from measurement set-up

5.4.2. Conducted emissions on antenna port, Canada requirements, RSS-133, Issue 5, §6.6

5.4.2.1. IDLE GSM 1900

BCCH channel = 651 (downlink)								
Sweep frequency range: [MHz]	Diagram number	Frequency of emission [MHz]	Transducer factor [dB]	Correction factor for Canada only (RBW:3kHz->4kHz)	Result FCC [dBm]	Result Canada [dBm]	Limit [dBm]	Verdict
Sweep 1 150kHz.. 1000MHz	Please see chapter 1.4.2 in annex A1	--	--	+ 1.25 dB	<-70.57	<-69.32	-57	Passed
Sweep 2 1 .. 10 GHz		--	--		<-63.44	<-64.68	-53	Passed ^{2.)}
Sweep 3 10 to 26,5GHz		15.654 GHz	--		-54.95	-56.2	-53	Passed ^{3.)}

Remark: Please see diagrams in separated Annex A1 for more details

- 2.) Peak from measurement set-up, BCCH carrier of base station
- 3.) internal spurious component from measurement set-up

5.4.2.2. IDLE W-CDMA Band IV

BCCH channel = at 2118MHz								
Sweep frequency range: [MHz]	Diagram number	Frequency of emission [MHz]	Transducer factor [dB]	Correction factor for Canada only (RBW:3kHz->4kHz)	Result FCC [dBm]	Result Canada [dBm]	Limit [dBm]	Verdict
Sweep 1 150kHz.. 1000MHz	Please see chapter 1.4.4 in annex A1	--	--	+ 1.25 dB	<-70.17	<-68.92	-57	Passed
Sweep 2 1 .. 10 GHz		--	--		<-63.0	<-64.25	-53	Passed ^{2.)}
Sweep 3 10 to 26,5GHz		15.654 GHz	--		-55.71	-55.96	-53	Passed

Remark: Please see diagrams in separated Annex A1 for more details

- 2.) Peak from measurement set-up, BCCH carrier of base station
- 3.) internal spurious component from measurement set-up

5.4.2.3. IDLE W-CDMA Band II

BCCH channel = at 1955MHz								
Sweep frequency range: [MHz]	Diagram number	Frequency of emission [MHz]	Transducer factor [dB]	Correction factor for Canada only (RBW:3kHz->4kHz)	Result FCC [dBm]	Result Canada [dBm]	Limit [dBm]	Verdict
Sweep 1 150kHz.. 1000MHz	Please see chapter 1.4.5 in annex A1	759.55	--	+ 1.25 dB	<-70.02	<-68.77	-57	Passed
Sweep 2 1 .. 10 GHz		6.6227	--		<-63	<-64.25	-53	Passed ^{2.)}
Sweep 3 10 to 26,5GHz		15.654 GHz	--		-55.12	-56.37	-53	Passed

Remark: Please see diagrams in separated Annex A1 for more details

- 2.) Peak from measurement set-up, BCCH carrier of base station
- 3.) internal spurious component from measurement set-up

Verdict

Summary of conducted measurement on antenna port: passed

5.5. Measurement uncertainties

The reported uncertainties are calculated based on the standard uncertainty multiplied with the appropriate coverage factor **k**, such that a confidence level of approximately 95% is achieved.

For uncertainty determination, each component used in the concrete measurement set-up was taken in account and it's contribution to the overall uncertainty according it's statistical distribution calculated.

Following table shows expectable uncertainties for each measurement type performed.

Measurement	Frequency range	Calculated uncertainty based on a confidence level of 95%	Remarks:
RF-Power Output conducted	9 kHz .. 20 GHz	1.0 dB	--
RF-Power Output radiated	30 MHz .. 4 GHz	3.17 dB	Substitution method
Conducted RF-emissions on antenna ports	9 kHz .. 20 GHz	1.0 dB	--
Radiated RF-emissions enclosure	150 kHz .. 30 MHz	5.0 dB	Magnetic field
	30 MHz .. 1 GHz	4.2 dB	E-Field
	1 GHz .. 18GHz	4.8 dB	E-Field
	1 GHz .. 20 GHz	3.17 dB	Substitution method
Occupied bandwidth	9 kHz .. 4 GHz	0.1272 ppm (Delta Marker method)	Frequency error
		1 dB	Power
Emission bandwidth	9 kHz .. 4 GHz	0.1272 ppm (Delta Marker method)	Frequency error
		1 dB	Power
Frequency stability	9 kHz .. 20 GHz	0.0636 ppm	--
Conducted emissions on AC-mains port (U _{CISPR})	9 kHz .. 150 kHz	4.0 dB	--
	150 kHz .. 30 MHz	3.6 dB	--

Table : measurement uncertainties, valid for conducted/radiated measurements

6. Accreditation details of CETECOM's laboratories and test sites

Ref.-No.	Accreditation Certificate	Valid for laboratory area or test site	Accreditation Body
-	D-PL-12047-01-01	All laboratories and test sites of CETECOM GmbH, Essen	DAKKS, Deutsche Akkreditierungsstelle GmbH
337 487 558	736496	Radiated Measurements 30 MHz to 1 GHz, 3m+10m OATS	FCC, Federal Communications Commission Laboratory Division, USA (MRA US-EU 0003)
348 348		Radiated Measurements 30 MHz to 1 GHz, 3m SAR Radiated Measurements above 1 GHz, 3 m Fully Anechoic Chamber Mains Ports Conducted Interference Measurements Telecommunication Ports Conducted Interference Measurements	
337 487 550 558	3462D-1 3462D-2 3462D-2 3462D-3	Radiated Measurements 30 MHz to 1 GHz, 3m + 10m OATS Radiated Measurements 30 MHz to 1 GHz, 3m SAR Radiated Measurements 1 GHz to 6 GHz, 3m SAR Radiated Measurements above 1 GHz ,3 m Fully Anechoic Chamber	IC, Industry Canada Certification and Engineering Bureau
337 487 550 348 348	R-2665 R-2666 G-301 C-2914 T-1967	Radiated Measurements 30 MHz to 1 GHz, 3m+10m OATS Radiated Measurements 30 MHz to 1GHz, 3m SAR Radiated Measurements 1GHz to 6 GHz, 3m SAR Mains Ports Conducted Interference Measurements Telecommunication Ports Conducted Interference Measurements	VCCI, Voluntary Control Council for Interference by Information Technology Equipment, Japan

7. Instruments and Ancillary

7.1. Used equipment “CTC”

The “Ref.-No” in the left column of the following tables allows the clear identification of the laboratory equipment.

7.1.1. Test software and firmware of equipment

Ref.-No.	Equipment	Type	Serial-No.	Version of Firmware or Software during the test
001	Emi Test Receiver	ESS	825132/017	Firm.= 1.21 , OTP=2.0, GRA=2.0
012	Signal Generator (EMS-cond.)	SMY 01	839069/027	Firm.= V 2.02
013	Power Meter (EMS cond.)	NRVD	839111/003	Firm.= V 1.51
017	Digital Radiocommunication Tester	CMD 60 M	844365/014	Firmware = V 3.52 .22.01.99, DECT = D2.87 13.01.99
053	Audio Analyzer	UPA3	860612/022	Firm. V 4,3
119	RT Harmonics Analyzer dig. Flickermeter	B10	G60547	Firm.= V 3.1DHG
140	Signal Generator	SMHU	831314/006	Firm.= 3.21
261	Thermal Power Sensor	NRV-Z55	825083/0008	EPROM-Datum 02.12.04, SE EE 1 B
262	Power Meter	NRV-S	825770/0010	Firm.= 2.6
263	Signal Generator	SMP 04	826190/0007	Firm.=3.21
264	Spectrum Analyzer	FSEK 30	826939/005	Bios=2.1, Analyzer= 3.20
295	Racal Digital Radio Test Set	6103	1572	UNIT Firmware= 4.04, SW-Main=4.04, SW-BBP=1.04, SW-DSP=1.02, Hardboot=1.02, Softboot=2.02
298	Univ. Radio Communication Tester	CMU 200	832221/091	R&S Test Firmware =3.53 /3.54 (current Testsoftw. f. all band used
323	Digital Radiocommunication Tester	CMD 55	825878/0034	Firm.= 3.52 .22.01.99
331	Climatic Test Chamber -40/+80 Grad	HC 4055	43146	TSI 1.53
335	System-CTC-EMS-Conducted	System EMS Conducted	-	EMC 32 V 8.40
340	Digital Radiocommunication Tester	CMD 55	849709/037	Firm.= 3.52 .22.01.99
355	Power Meter	URV 5	891310/027	Firm.= 1.31
365	10V Insertion Unit 50 Ohm	URV5-Z2	100880	Eprom Data = 31.03.08
366	Ultra Compact Simulator	UCS 500 M4	V0531100594	Firm. UCS 500=001925/3.06a02, rc=ISMIEC 4.10
371	Bluetooth Tester	CBT32	100153	CBT V5.30+ SW-Option K55
377	Emi Test Receiver	ESCS 30	100160	Firm.= 2.30, OTP= 02.01, GRA= 02.36
378	Broadband RF Field Monitor	RadiSense III	03D00013SNO-08	Firm.= V.03D13
383	Signal Generator	SME 03	842 828 /034	Firm.= 4.61
389	Digital Multimeter	Keithley 2000	0583926	Firm. = A13 (Mainboard) A02 (Display)
392	Radio Communication Tester	MT8820A	6K00000788	Firm.= 4.50 #005, IPL=4.01#001,OS=4.02#001, GSM=4.41#013, W-CDMA= 4.54#004, scenario= 4.52#002
436	Univ. Radio Communication Tester	CMU 200	103083	R&S Test Firmware Base=5.14, Mess-Software= GSM:5.14 WCDMA:5.14 (current Testsoftw. F. all band to be used ,
441	CTC-SAR-EMI Cable Loss	System EMI field (SAR) Cable	-	EMC 32 Version 8.40
442	CTC-SAR-EMS	System EMS field (SAR)	-	EMC 32 Version 8.40
443	CTC-FAR-EMI-RSE	System CTC-FAR-EMI-RSE	-	Spuri 7.2.5 or EMC 32 Ver. 8.40
444	CTC-FAR-EMS field	System-EMS-Field (FAR)	-	EMC 32 Version 8.40
460	Univ. Radio Communication Tester	CMU 200	108901	R&S Test Firmware Base=5.14, GSM=5.14 WCDMA=5.14 (current Testsoftw.,f. all band to be used,
489	Emi Test Receiver	ESU40	1000-30	Firmware=4.43 SP3, Bios=V5.1-16-3, Spec. =01.00
491	ESD Simulator dito	ESD dito	dito307022	V 2.30
524	Voltage Drop Simulator	VDS 200	0196-16	Software Nr. 000037 Version V4.20a01
526	Burst Generator	EFT 200 A	0496-06	Software Nr. 000034 Version V2.32
527	Micro Pulse Generator	MPG 200 B	0496-05	Software-Nr. 000030 Version V2.43
528	Load Dump Simulator	LD 200B	0496-06	Software-Nr. 000031 Version V2.35a01
546	Univ. Radio Communication Tester	CMU 200	106436	R&S Test Firmware Base=5.14, GSM=5.14 WCDMA=5.14 (current Testsoftw.,f. all band to be used
547	Univ. Radio Communication Tester	CMU 200	835390/014	R&S Test Firmware Base=V5.1403 (current Testsoftw., f. all band used, GSM = 5.14 WCDMA: = 5.14
584	Spectrum Analyzer	FSU 8	100248	2.82_SP3
594	Univ. Radio Communication Tester	CMW500	101757	Firmware Base=2.0.20.9, LTE=2.0.20.8. CDMA= 2.0.10
597	Univ. Radio Communication Tester	CMU 200	100347	R&S Test Firmware Base=5.01, GSM=5.02 WCDMA= not installed, Mainboard= µP1=V.850
598	Spectrum Analyzer	FSEM 30 (Reserve)	831259/013	Firmware Bios 3.40 , Analyzer 3.40 Sp 2

7.1.2. Single instruments and test systems

Ref.-No.	Equipment	Type	Serial-No.	Manufacturer	Interval of calibration	Remark	Cal due
001	Emi Test Receiver	ESS	825132/017	Rohde & Schwarz	12 M	-	31.03.2012
005	AC - LISN (50 Ohm/50µH, test site 1)	ESH2-Z5	861741/005	Rohde & Schwarz	24/12 M	-	31.03.2012
007	DC - LISN (50 Ohm/5µH)	ESH3-Z6	892563/002	Rohde & Schwarz	24/12 M	-	31.03.2012
009	Power Meter (EMS-radiated)	NRV	863056/017	Rohde & Schwarz	24 M	-	31.03.2013
016	Line Impedance Simulating Network	Op. 24-D	B6366	Spitzenberger+Spies	36 M	-	31.03.2013
020	Horn Antenna 18 GHz (Subst 1)	3115	9107-3699	EMCO	36/12 M	-	31.03.2013
021	Loop Antenna (H-Field)	6502	9206-2770	EMCO	36 M	-	31.03.2013
030	Loop Antenna (H-field)	HFH-Z2	879604/026	Rohde & Schwarz	36 M	-	31.03.2012
033	RF-current probe (100kHz-30MHz)	ESH2-Z1	879581/18	Rohde & Schwarz	24 M	-	31.03.2013
057	relay-switch-unit (EMS system)	RSU	494440/002	Rohde & Schwarz	pre-m	1a	
060	power amplifier (DC-2kHz)	PAS 5000	B6363	Spitzenberger+Spies	-	3	
066	notch filter (WCDMA; FDD1)	WRCT 1900/2200-5/40-10EEK	5	Wainwright GmbH	12 M	1c	30.06.2012
086	DC - power supply, 0 -10 A	LNG 50-10	-	Heinzinger Electronic	pre-m	2	
087	DC - power supply, 0 -5 A	EA-3013 S	-	Elektro Automatik	pre-m	2	
090	Helmholtz coil: 2x10 coils in series	-	-	RWTÜV	-	4	
091	USB-LWL-Converter	OLS-1	007/2006	Ing. Büro Scheiba	-	4	
099	passive voltage probe	ESH2-Z3	299.7810.52	Rohde & Schwarz	36 M	-	31.03.2012
100	passive voltage probe	Probe TK 9416	without	Schwarzbeck	36 M	-	31.03.2012
110	USB-LWL-Converter	OLS-1	-	Ing. Büro Scheiba	-	4	
119	RT Harmonics Analyzer dig. Flickermeter	B10	G60547	BOCONSULT	36 M	-	31.03.2013
134	horn antenna 18 GHz (Subst 2)	3115	9005-3414	EMCO	12 M	-	31.03.2012
136	adjustable dipole antenna (Dipole 1)	3121C-DB4	9105-0697	EMCO	12 M	-	31.03.2012
140	Signal Generator	SMHU	831314/006	Rohde & Schwarz	24 M	-	31.03.2012
248	attenuator	SMA 6dB 2W	-	Radiall	pre-m	2	
249	attenuator	SMA 10dB 10W	-	Radiall	pre-m	2	
252	attenuator	N 6dB 12W	-	Radiall	pre-m	2	
256	attenuator	SMA 3dB 2W	-	Radiall	pre-m	2	
257	hybrid	4031C	04491	Narda	pre-m	2	
260	hybrid coupler	4032C	11342	Narda	pre-m	2	
261	Thermal Power Sensor	NRV-Z55	825083/0008	Rohde & Schwarz	24/12 M	-	31.03.2012
262	Power Meter	NRV-S	825770/0010	Rohde & Schwarz	24 M	-	31.03.2012
263	Signal Generator	SMP 04	826190/0007	Rohde & Schwarz	36 M	-	31.03.2013
264	Spectrum Analyzer	FSEK 30	826939/005	Rohde & Schwarz	12 M	-	31.03.2014
265	peak power sensor	NRV-Z33, Model 04	840414/009	Rohde & Schwarz	24 M	-	31.03.2012
266	peak power sensor	NRV-Z31, Model 04	843383/016	Rohde & Schwarz	24 M	-	31.03.2012
267	notch filter GSM 850	WRCA 800/960-6EEK	9	Wainwright GmbH	pre-m	2	
268	AC/DC power supply	EA 3050-A	9823636	Elektro Automatik	pre-m	2	
270	termination	1418 N	BB6935	Weinschel	pre-m	2	
271	termination	1418 N	BE6384	Weinschel	pre-m	2	
272	attenuator (20 dB) 50 W	Model 47	BF6239	Weinschel	pre-m	2	
273	attenuator (10 dB) 100 W	Model 48	BF9229	Weinschel	pre-m	2	
274	attenuator (10 dB) 50 W	Model 47 (10 dB) 50 W	BG0321	Weinschel	pre-m	2	
275	DC-Block	Model 7003 (N)	C5129	Weinschel	pre-m	2	
276	DC-Block	Model 7006 (SMA)	C7061	Weinschel	pre-m	2	
279	power divider	1515 (SMA)	LH855	Weinschel	pre-m	2	
287	pre-amplifier 25MHz - 4GHz	AMF-2D-100M4G-35-10P	379418	Miteq	12 M	1c	30.06.2012
291	high pass filter GSM 850/900	WHJ 2200-4EE	14	Wainwright GmbH	12 M	1c	30.06.2012
298	Univ. Radio Communication Tester	CMU 200	832221/091	Rohde & Schwarz	pre-m	3	
300	AC LISN (50 Ohm/50µH, 1-phase)	ESH3-Z5	892 239/020	Rohde & Schwarz	24/12 M	-	31.03.2012
301	attenuator (20 dB) 50W, 18GHz	47-20-33	AW0272	Lucas Weinschel	pre-m	2	
302	horn antenna 40 GHz (Meas 1)	BBHA9170	155	Schwarzbeck	36 M	-	31.03.2014
303	horn antenna 40 GHz (Subst 1)	BBHA9170	156	Schwarzbeck	36 M	-	31.03.2014
331	Climatic Test Chamber -40/+80 Grad	HC 4055	43146	Heraeus Vötsch	24 M	-	30.11.2012
341	Digital Multimeter	Fluke 112	81650455	Fluke	24 M	-	31.03.2012
342	Digital Multimeter	Voltcraft M-4660A	IB 255466	Voltcraft	24 M	-	31.03.2013
347	laboratory site	radio lab.	-	-	-	5	
348	laboratory site	EMI conducted	-	-	-	5	
354	DC - Power Supply 40A	NGPE 40/40	448	Rohde & Schwarz	pre-m	2	
355	Power Meter	URV 5	891310/027	Rohde & Schwarz	24 M	-	31.03.2012
356	power sensor	NRV-Z1	882322/014	Rohde & Schwarz	24 M	-	31.03.2013
357	power sensor	NRV-Z1	861761/002	Rohde & Schwarz	24 M	-	31.03.2013
373	V-Network 5µH/50 Ohm	ESH3-Z6	100535	Rohde & Schwarz	24/12 M	-	31.03.2012
376	Horn Antenna 6 GHz	BBHA9120 E	BBHA 9120 E 179	Schwarzbeck	12 M	-	31.03.2012
377	Emi Test Receiver	ESCS 30	100160	Rohde & Schwarz	12 M	-	31.03.2012
389	Digital Multimeter	Keithley 2000	0583926	Keithley	24 M	-	31.03.2013
392	Radio Communication Tester	MT8820A	6K00000788	Anritsu	12 M	-	31.03.2012
431	Model 7405	Near-Field Probe Set	9305-2457	EMCO	-	4	
436	Univ. Radio Communication Tester	CMU 200	103083	Rohde & Schwarz	12 M	-	31.03.2012
441	CTC-SAR-EMI Cable Loss	System EMI field (SAR)	-	CETECOM	12 M	5	31.08.2012

Ref.-No.	Equipment	Type	Serial-No.	Manufacturer	Interval of calibration	Remark	Cal due
		Cable					
443	CTC-FAR-EMI-RSE	System CTC-FAR-EMI-RSE	-	ETS-Lindgren/CETECOM	12 M	5	30.06.2012
448	notch filter WCDMA_FDD II	WRCT 1850.0/2170.0-5/40-10SSK	5	Wainwright Instruments GmbH	12 M	1c	30.06.2012
449	notch filter WCDMA FDD V	WRCT 824.0/894.0-5/40-8SSK	1	Wainwright	12 M	1c	30.06.2012
454	Oscilloscope	HM 205-3	9210 P 29661	Hameg	-	4	
456	DC-Power supply 0-5 A	EA 3013 S	207810	Elektro Automatik	pre-m	2	
459	DC -Power supply 0-5 A , 0-32 V	EA-PS 2032-50	910722	Elektro Automatik	pre-m	2	
460	Univ. Radio Communication Tester	CMU 200	108901	Rohde & Schwarz	12 M	-	31.03.2012
463	Universal source	HP3245A	2831A03472	Agilent	-	4	
466	Digital Multimeter	Fluke 112	89210157	Fluke USA	24 M	-	31.03.2012
467	Digital Multimeter	Fluke 112	89680306	Fluke USA	24 M	-	31.03.2012
468	Digital Multimeter	Fluke 112	90090455	Fluke USA	24 M	-	31.03.2012
477	ReRadiating GPS-System	AS-47	-	Automotive Cons. Fink	-	3	
480	power meter (Fula)	NRVS	838392/031	Rohde & Schwarz	24 M	-	31.03.2013
482	filter matrix	Filter matrix SAR 1	-	CETECOM (Brl)	-	1d	
484	pre-amplifier 2,5 - 18 GHz	AMF-5D-02501800-25-10P	1244554	Miteq	12 M	-	30.07.2012
487	System CTC NSA-Verification SAR-EMI	System EMI field (SAR) NSA	-	ETS Lindgren/CETECOM	12 M	-	30.09.2012
489	Emi Test Receiver	ESU40	1000-30	Rohde & Schwarz	12 M	-	31.03.2012
502	band reject filter	WRCG 1709/1786-1699/1796-	SN 9	Wainwright	pre-m	2	
503	band reject filter	WRCG 824/849-814/859-60/10SS	SN 5	Wainwright	pre-m	2	
512	notch filter GSM 850	WRCA 800/960-02/40-6EEK	SN 24	Wainwright	12 M	1c	30.06.2012
517	relais switch matrix	HF Relais Box Keithley System	SE 04	Keithley	pre-m	2	
523	Digital Multimeter	L4411A	MY46000154	Agilent	24 M	-	31.03.2013
529	6 dB Broadband resistive power divider	Model 1515	LH 855	Weinschel	pre-m	2	
530	10 dB Broadband resistive power divider	R 416110000	LOT 9828	-	pre-m	2	
546	Univ. Radio Communication Tester	CMU 200	106436	R&S	12 M	-	31.03.2012
547	Univ. Radio Communication Tester	CMU 200	835390/014	Rohde & Schwarz	12 M	-	31.03.2012
548	Digital-Barometer	GBP 2300	without	Greisinger GmbH	36/12 M	-	31.03.2012
549	Log-Per-Antenna	HL025	1000060	Rohde & Schwarz	36/12 M	-	31.03.2012
552	high pass filter 2,8-18GHz	WHKX 2.8/18G-10SS	4	Wainwright	12 M	1c	30.07.2012
558	System CTC FAR S-VSWR	System CTC FAR S-VSWR	-	CTC	24 M	-	31.07.2013
574	Biconilog Hybrid Antenna	BTA-L	980026L	Frankonia	36/12 M	-	30.03.2013
584	Spectrum Analyzer	FSU 8	100248	Rohde & Schwarz	12 M	-	31.03.2012
594	Univ. Radio Communication Tester	CMW500	101757	Rohde & Schwarz	24 M	-	31.03.2012
597	Univ. Radio Communication Tester	CMU 200	100347	Rohde & Schwarz	12 M	-	31.03.2012
598	Spectrum Analyzer	FSEM 30 (Reserve)	831259/013	Rohde & Schwarz	24 M	-	13.01.2013
600	power meter	NRVD (Reserve)	834501/018	Rohde & Schwarz	24 M	-	31.03.2013
601	medium-sensitivity diode sensor	NRV-Z5 (Reserve)	8435323/003	Rohde & Schwarz	24 M	-	12.01.2013
602	peak power sensor	NRV-Z32 (Reserve)	835080	Rohde & Schwarz	24 M	-	12.01.2013
608	UltraLog-Antenna	HL 562	830547/009	Rohde & Schwarz	36/12 M	-	31.03.2014
611	DC power supply	E3632A	KR 75305854	Agilent	pre-m	2	
612	DC power supply	E3632A	MY 40001321	Agilent	pre-m	2	
613	Attenuator	R416120000 20dB 10W	Lot. 9828	Radiall	pre-m	2	

7.1.3. Legend

Note / remarks		Calibrated during system calibration:
	1a	System CTC-SAR-EMS (Ref.-No. 442)
	1b	System-CTC-EMS-Conducted (Ref.-No. 335)
	1c	System CTC-FAR-EMI-RSE (Ref.-No . 443)
	1d	System CTC-SAR-EMI (Ref.-No . 441)
	1e	System CTC-OATS (EMI radiated) (Ref.-No. 337)
	1 f	System CTC-CTIA-OTA (Ref.-No . 420)
	1 g	System CTC-FAR-EMS (Ref.-No . 444)
	2	Calibration or equipment check immediately before measurement
	3	Regulatory maintained equipment for functional check or support purpose
	4	Ancillary equipment without calibration e.g. mechanical equipment or monitoring equipment
	5	Test System

Interval of calibration	12 M	12 month
-------------------------	------	----------

	24 M	24 month
	36 M	36 month
	24/12 M	Calibration every 24 months, between this every 12 months internal validation
	36/12 M	Calibration every 36 months, between this every 12 months internal validation
	Pre-m	Check before starting the measurement
	-	Without calibration