

|   |  |                                      |                             |
|---|--|--------------------------------------|-----------------------------|
|  | Document   |                                      | Page                        |
|   | <b>Hearing Aid Compatibility RF Emissions Test Report for the BlackBerry® Smartphone model REA71UW</b> |                                      | 1(20)                       |
| Author Data<br><b>Daoud Attayi</b>  | Dates of Test<br><b>Feb 28, Mar. 22-23, Apr. 05, Aug. 09-31, 2011</b>                                  | Report No<br><b>RTS-5316-1109-55</b> | FCC ID<br><b>L6AREA70UW</b> |

# Hearing Aid Compatibility RF Emissions Test Report

|                     |   |                   |  |
|---------------------|---|-------------------|--|
| <b>Testing Lab:</b> | RIM Testing Services<br>440 Phillip Street<br>Waterloo, Ontario<br>Canada N2L 5R9<br>Phone: 519-888-7465<br>Fax: 519-746-0189 | <b>Applicant:</b> | Research In Motion Limited<br>295 Phillip Street<br>Waterloo, Ontario<br>Canada N2L 3W8<br>Phone: 519-888-7465<br>Fax: 519-888-6906<br>Web site: www.rim.com |
|---------------------|---|-------------------|--|

**Statement of Compliance:** RIM Testing Services (RTS) declares that the product was tested in accordance with the appropriate measurement standards, guidelines and recommended practices.

This Blackberry® Smartphone is a wireless portable device and has been shown to be in compliance with FCC 20.19 (10-1-07 Edition), Hearing Aid-Compatible Mobile Handsets, FCC Public Notice DA 06-1215 (June 6, 2006) and FCC Report and Order, FCC 08-68 (Feb. 28, 2008).

## Signatures:

## Date:

### Tested and prepared by:

Daoud Attayi  
Team Lead: Safety, SAR/HAC  
Compliance



24-Sep-2011

### Reviewed by :

Andrew Becker  
SAR & HAC  
Compliance Specialist

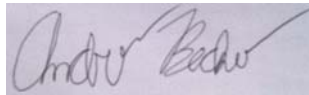

26-Sep-2011

### Approved by:

Masud S. Attayi  
Manager, Regulatory Compliance



28-Sep-2011

|   |  |                         |                   |
|---|--|-------------------------|-------------------|
|  | Document   |                         | Page              |
|   | <b>Hearing Aid Compatibility RF Emissions Test Report for the BlackBerry® Smartphone model REA71UW</b> |                         | 2(20)             |
| Author Data   | Dates of Test  | Report No               | FCC ID            |
| <b>Daoud Attayi</b>   | <b>Feb 28, Mar. 22-23, Apr. 05, Aug. 09-31, 2011</b>   | <b>RTS-5316-1109-55</b> | <b>L6AREA70UW</b> |

**CONTENTS**

1.0 Introduction ..... 3

2.0 Applicable references ..... 4

    3.1 Picture of device ..... 5

    3.2 Device description..... 5

    3.3 Battery ..... 7

    3.4 Antenna description ..... 7

4.0 List of test equipment ..... 7

5.2 Near-Field RF Emission ..... 13

6.0 Summary of results..... 16

    6.1 Conclusion ..... 18

7.0 Measurement uncertainty ..... 19

    7.1 Site-Specific Uncertainty..... 20

Annex A: Measurement plots and data

- A.1 Spectrum analyser plots: CW, 80% AM and GSM/WDMA signals
- A.2 Dipole validation and probe modulation factor plots
- A.3 RF emission field plots

Annex B: Probe and dipole descriptions and calibration certificates

- B.1 Probe and measurement chain description and specifications
- B.2 Probe and dipole calibration certificates

Annex C: Test set up photos

|   |  |                         |                   |
|---|--|-------------------------|-------------------|
|  | Document   |                         | Page              |
|   | <b>Hearing Aid Compatibility RF Emissions Test Report for the BlackBerry® Smartphone model REA71UW</b> |                         | 3(20)             |
| Author Data   | Dates of Test  | Report No               | FCC ID            |
| <b>Daoud Attayi</b>   | <b>Feb 28, Mar. 22-23, Apr. 05, Aug. 09-31, 2011</b>   | <b>RTS-5316-1109-55</b> | <b>L6AREA70UW</b> |

## 1.0 Introduction

This test report documents the measurement of the near electric and magnetic fields generated by a wireless communication device in the region where a hearing aid would be used. The measurement procedures of ANSI C63.19-2007 were followed along with the guidance provided by the FCC.

The electric and magnetic fields from a wireless device are scanned using a SPEAG DASY5 automated system with HAC extension and free-space probes (ER3DVx and H3DVx) in a 5cm x 5cm area, 15mm above the wireless device's acoustic output and the centre point of the probe element. The area is divided into 9 sub-grids and the maximum values of the electrical and a magnetic field scans are evaluated automatically according to the rules defined in the standard and the device is assigned a certain category. Should the wireless device's maximum T-Coil output occur in a location other than the centre of acoustic output, then the RF field scans are repeated with the measurement area centered on the maximum T-Coil output location.

The DASY5 HAC Extension consists of the following parts: the Test Arch phantom, three validation dipoles, dipole and DUT holders, magnetic and electric field probes and DASY5 software. The field probes and measurement electronics are described in Annex B.1.

The specially designed Test Arch allows high precision positioning of both the device and any of the validation dipoles. The broadband dipoles are calibrated at a single frequency and are used for system performance checks.

In order to correlate the usability of a hearing aid with a wireless device (WD), the WD's radio frequency (RF) and audio band emissions are measured. ANSI C63.19 requires:

- Radio frequency (RF) measurements of the near-field electric and magnetic fields emitted by a WD in the vicinity of the audio output to categorize these emissions for correlation with the RF immunity of the microphone mode of operation of a hearing aid.
- Audio frequency magnetic field measurements of a WD emitted in the vicinity of the audio output to categorize these emissions for correlation with the T-Coil mode of operation of a hearing aid.

Hence, the following measurements are made for the WDs:

1. RF E-Field emissions.
2. RF H-Field emissions.
3. T-Coil mode, magnetic signal strength in the audio band.
4. T-Coil mode, magnetic signal and noise articulation index.
5. T-Coil mode, magnetic signal frequency response through the audio band.
6. RF T-Coil environment: The worst case M rating from E or H field 5x5 cm scan centered at the axial T-coil highest peak location.

|   |  |                         |                   |
|---|--|-------------------------|-------------------|
|  | Document   |                         | Page              |
|   | <b>Hearing Aid Compatibility RF Emissions Test Report for the BlackBerry® Smartphone model REA71UW</b> |                         | 4(20)             |
| Author Data   | Dates of Test  | Report No               | FCC ID            |
| <b>Daoud Attayi</b>   | <b>Feb 28, Mar. 22-23, Apr. 05, Aug. 09-31, 2011</b>   | <b>RTS-5316-1109-55</b> | <b>L6AREA70UW</b> |

## 2.0 Applicable references

[1] ANSI C63.19-2007, American National Standard for Methods of Measurement of Compatibility between Wireless Communication Devices and Hearing Aids

[2] FCC 47CFR § 20.19 (10-1-07 Edition), Hearing Aid-Compatible Mobile Handsets

[3] FCC Public Notice DA 06-1215, June 2006

[4] SPEAG DASY5 user manual, June 2006

[5] FCC Equipment Authorization Guidance on Hearing Aid Compatibility, Sep/Oct 2008

[6] FCC Report and Order, FCC 08-68, Feb 2008

|   |  |                                      |                             |
|---|--|--------------------------------------|-----------------------------|
|  | Document   |                                      | Page                        |
|   | <b>Hearing Aid Compatibility RF Emissions Test Report for the BlackBerry® Smartphone model REA71UW</b> |                                      | 5(20)                       |
| Author Data<br><b>Daoud Attayi</b>  | Dates of Test<br><b>Feb 28, Mar. 22-23, Apr. 05, Aug. 09-31, 2011</b>                                  | Report No<br><b>RTS-5316-1109-55</b> | FCC ID<br><b>L6AREA70UW</b> |

### 3.0 Equipment unit tested

#### 3.1 Picture of device

Please refer to Annex C.

**Figure 1. BlackBerry® smartphone**

#### 3.2 Device description

|  |                                  |                                  |                             |
|--|----------------------------------|----------------------------------|-----------------------------|
| <b>Device Model</b>                                      | REA71UW                          |                                  |                             |
| <b>FCC ID</b>  | L6AREA70UW                       |                                  |                             |
| <b>PIN</b>   | 27EB7923, 28302141               |                                  |                             |
| <b>Hardware Rev</b>                                      | Rev 1, Rev 2                     |                                  |                             |
| <b>Software Version</b>                                  | 7.0.0.1482, 7.0.0. 1725          |                                  |                             |
| <b>Prototype or Production Unit</b>                      | Production                       |                                  |                             |
| <b>Mode(s) of Operation</b>                              | 1-slot<br>GSM 850<br>GSM 1900    | 2-slots<br>EDGE/GPRS<br>850/1900 | WCDMA / UMTS<br>FDD V (850) |
| <b>Nominal Maximum conducted RF Output Power (dBm)</b>   | 33.0<br>29.0                     | 31.0<br>28.0                     | 24.0                        |
| <b>Tolerance in Power Setting on centre channel (dB)</b> | ± 0.50                           | ± 0.50                           | ± 0.50                      |
| <b>Duty Cycle</b>  | 1:8                              | 2:8                              | 1:1                         |
| <b>Transmitting Frequency Range (MHz)</b>                | 824.2 – 848.8<br>1850.2 – 1909.8 | 824.2 – 848.8<br>1850.2 – 1909.8 | 824.6 – 846.6               |
| <b>Mode(s) of Operation</b>                              | WCDMA / UMTS<br>FDD II (1900)    | Bluetooth                        | NFC                         |
| <b>Nominal Maximum conducted RF Output Power (dBm)</b>   | 22.0                             | 8.5                              | N/A                         |
| <b>Tolerance in Power Setting on centre channel (dB)</b> | ± 0.50                           | N/A                              | N/A                         |
| <b>Duty Cycle</b>  | 1:1                              | N/A                              | N/A                         |
| <b>Transmitting Frequency Range (MHz)</b>                | 1852.4 – 1907.6                  | 2402-2483                        | 13.56                       |
| <b>Mode(s) of Operation</b>                              | 802.11b                          | 802.11g                          | 802.11n                     |
| <b>Nominal Maximum conducted RF Output Power (dBm)</b>   | 16.5                             | 15.5                             | 15.5                        |
| <b>Tolerance in Power Setting on centre channel (dB)</b> | ± 0.5                            | ± 0.5                            | ± 0.5                       |
| <b>Duty Cycle</b>  | 1:1                              | 1:1                              | 1:1                         |
| <b>Transmitting Frequency Range (MHz)</b>                | 2412-2462                        | 2412-2462                        | 2412-2462                   |

**Table 3.1. Test device characterization**

|   |  |                                      |                             |
|---|--|--------------------------------------|-----------------------------|
|  | Document<br><b>Hearing Aid Compatibility RF Emissions Test Report for the BlackBerry® Smartphone model REA71UW</b> |                                      | Page<br>6(20)               |
| Author Data<br><b>Daoud Attayi</b>  | Dates of Test<br><b>Feb 28, Mar. 22-23, Apr. 05, Aug. 09-31, 2011</b>  | Report No<br><b>RTS-5316-1109-55</b> | FCC ID<br><b>L6AREA70UW</b> |

**Note 1:** BT and NFC are not activated during test because it is not held-to-ear service.

**Note 2:** Wi-Fi is not activated during test because ANSI C63.19-2007 standard does not cover this technology.

|   |  |   |                                      |
|---|--|---|--------------------------------------|
|  | Document<br><b>Hearing Aid Compatibility RF Emissions Test Report for the BlackBerry® Smartphone model REA71UW</b> |   | Page<br>7(20)                        |
|   | Author Data<br><b>Daoud Attayi</b>   | Dates of Test<br><b>Feb 28, Mar. 22-23, Apr. 05, Aug. 09-31, 2011</b> | Report No<br><b>RTS-5316-1109-55</b> |

### 3.3 Battery

- 1) BAT-30615-006

### 3.4 Antenna description

|                      |  |
|----------------------|--|
| <b>Type</b>          | Internal fixed antenna                         |
| <b>Location</b>      | Bottom back centre (main licensed transmitter) |
| <b>Configuration</b> | Internal fixed antenna                         |

**Table 3.2. Antenna description**

### 4.0 List of test equipment

| <b>Manufacturer</b>             | <b>Test Equipment</b>                      | <b>Model Number</b> | <b>Serial Number</b> | <b>Calibration Due Date (MM/DD/YY)</b> |
|---------------------------------|--|---------------------|----------------------|--|
| SCHMID & Partner Engineering AG | Data Acquisition Electronics               | DAE4                | 881                  | 04/19/2011                             |
| SCHMID & Partner Engineering AG | Data Acquisition Electronics               | DAE3 V1             | 473                  | 01/21/2012                             |
| SCHMID & Partner Engineering AG | Data Acquisition Electronics (DAE3)        | DAE3 V2             | 472                  | 03/07/2012                             |
| SCHMID & Partner Engineering AG | 3-Dimensional E-Field Probe for Near-Field | ER3DV6              | 2286                 | 01/14/2012                             |
| SCHMID & Partner Engineering AG | 3-Dimensional H-Field Probe for Near-Field | H3DV6               | 6105                 | 11/18/2011                             |
| Rohde & Schwarz                 | Base Station Simulator                     | CMU200              | 109747               | 12/07/2011                             |
| Rohde & Schwarz                 | Spectrum Analyzer                          | ESP 30              | 100884               | 07/14/2011                             |
| Agilent Technologies            | Signal generator                           | 8648C               | 4037U03155           | 09/24/2011                             |
| Agilent Technologies            | Power meter                                | E4419B              | GB40202821           | 09/15/2011                             |
| Agilent Technologies            | Power sensor                               | 8481A               | MY41095417           | 09/23/2011                             |
| Amplifier Research              | Amplifier                                  | 5S1G4M3             | 300986               | CNR                                    |
| SCHMID & Partner Engineering AG | Validation Dipole                          | CD835V3             | 1011                 | 11/18/2011                             |
| SCHMID & Partner Engineering AG | Validation Dipole                          | CD1880V3            | 1008                 | 11/18/2011                             |

**Table 4.1. List of test equipment**

|   |  |                                      |                             |
|---|--|--------------------------------------|-----------------------------|
|  | Document   |                                      | Page                        |
|   | <b>Hearing Aid Compatibility RF Emissions Test Report for the BlackBerry® Smartphone model REA71UW</b> |                                      | 8(20)                       |
| Author Data<br><b>Daoud Attayi</b>  | Dates of Test<br><b>Feb 28, Mar. 22-23, Apr. 05, Aug. 09-31, 2011</b>                                  | Report No<br><b>RTS-5316-1109-55</b> | FCC ID<br><b>L6AREA70UW</b> |

## 5.0 Measurement procedures

### 5.1 System Validation

The test setup should be validated when first configured and verified periodically thereafter to ensure proper function. The procedure consists of two parts: dipole validation and determination of probe modulation factor.

#### 5.1.1 Dipole Validation

The HAC validation dipole antenna serves as a known source for an electrical and magnetic RF output.

1. The dipole antenna was placed in the position normally occupied by the WD.
2. The dipole was energized with a 20 dBm un-modulated continuous-wave signal.
3. The center point of the probe element(s) are 10 mm from the closest surface of the dipole elements.
4. The length of the dipole was scanned with both E-field and H-field probes and the maximum value for each scan was recorded.
5. The readings were compared with the values provided by the probe manufacturer and were found to agree within tolerance of +/- 10%. Please refer to Annex A.2 for Dipole Validation Plots.

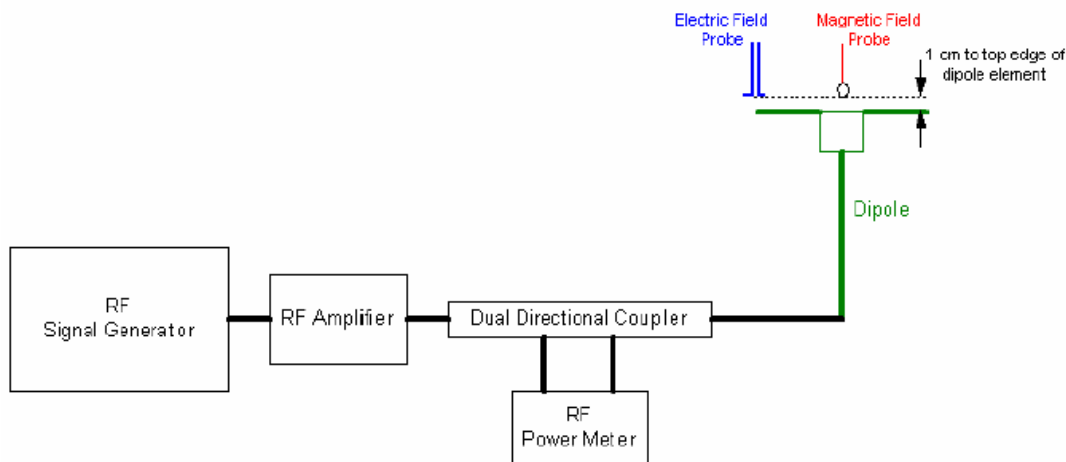

**Figure 5.1: Dipole validation procedure**



|   |  |   |                                      |
|---|--|---|--------------------------------------|
|  | Document<br><b>Hearing Aid Compatibility RF Emissions Test Report for the BlackBerry® Smartphone model REA71UW</b> |   | Page<br>9(20)                        |
|   | Author Data<br><b>Daoud Attayi</b>   | Dates of Test<br><b>Feb 28, Mar. 22-23, Apr. 05, Aug. 09-31, 2011</b> | Report No<br><b>RTS-5316-1109-55</b> |

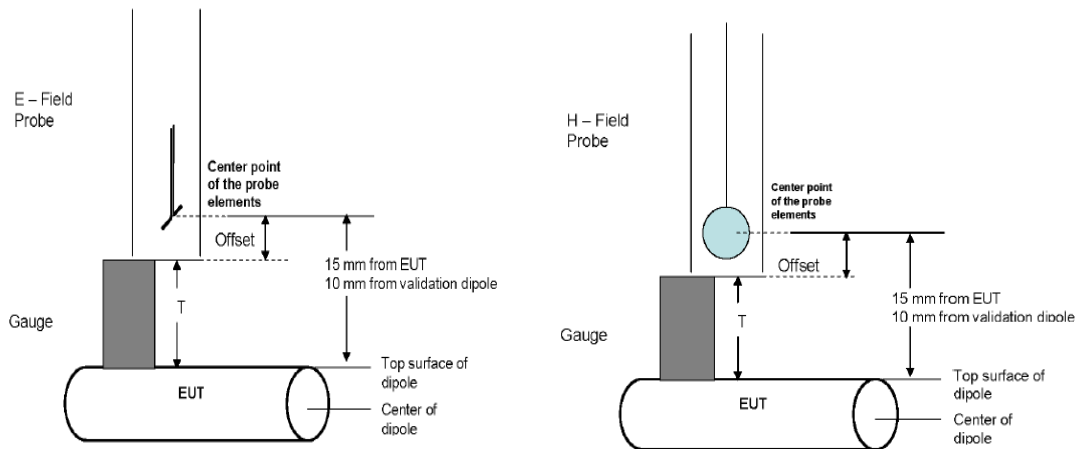

**Figure 5.2: Gauge Block with E-Field & H-Field probes**

### 5.1.2 RF Field Probe Modulation Factor

The Probe Modulation Factor (PMF) characterizes the responses of the E-field and H-field probes and their instrumentation chain to a modulated signal. The PMF is the ratio of the responses to fields produced by CW and modulated signals having equal peak amplitude.

Three test cases are recommended. The real or emulated WD (Wireless device) modulated signal, an unmodulated (CW) and an 80% AM RF signal shall be used for each relevant frequency band. Each of the test cases below shall be measured with both E\_ and H\_Field probe.

#### a) Measurement of real and emulated signal

- Set a WD or emulated signal source to apply full power into the reference dipole.
- Measure both the peak and average input power applied to the antenna and record the values using the following test instructions for measuring the RF interference of a modulated signal.

Spectrum analyzer set up:

RBW  $\geq$  emission bandwidth

Video Bandwidth  $\geq$  20 KHz

Span: Zero

Center Frequency: Nominal center of frequency channel

Amplitude: Linear (logarithmic scale may be used)

Detection: Peak detection

Trigger: Video or IF trigger

|   |  |                                      |                             |
|---|--|--------------------------------------|-----------------------------|
|  | Document   |                                      | Page                        |
|   | <b>Hearing Aid Compatibility RF Emissions Test Report for the BlackBerry® Smartphone model REA71UW</b> |                                      | 10(20)                      |
| Author Data<br><b>Daoud Attayi</b>  | Dates of Test<br><b>Feb 28, Mar. 22-23, Apr. 05, Aug. 09-31, 2011</b>                                  | Report No<br><b>RTS-5316-1109-55</b> | FCC ID<br><b>L6AREA70UW</b> |

Sweep rate: sufficiently rapid to permit the complete pulse to be resolved accurately.

- Using near-field measurement system, scan the antenna over the appropriately sized area and record the greatest average power reading observed.

**b) Measurement of CW and AM**

- Set the RF signal generator for CW or 80 % AM and set the output power so the peak power applied to the antenna is equal to that recorded for the real or emulated signal using the WD modulation format.
- Measure both the peak and average input power applied to the antenna and record these values. Calculate the peak to average power ratio (PAR). The PAR for the CW signal should be 0.0 dB and 3.9 dB for the AM signal with 80% modulation depth from each other and the peak should be that amount above the target values.

The PMF was calculated for the following signals: 80% AM and the modulated signal produced by the WD. The PMF measurement was performed with the field probe and instrumentation that will be used together during RF emissions measurements. Once calculated, the PMF was entered into the DASY5 software and applied to the measured modulated fields of the specified type.

ANSI C63.19 outlines the following alternate procedure as one method for determining probe modulation factor:

1. Fix the field probe in a set location relative to a field generating device, such as the reference dipole antenna.
2. Illuminate the probe using the wireless device connected to the reference dipole with a test signal at the intended measurement frequency, Ensure there is sufficient field coupling between the probe and the antenna so the resulting reading is greater than 10 dB above the probe system noise floor but within the systems operating range.
3. Record the amplitude applied to the antenna during transmission and the field strength measured by the E-field probe located near the tip of the dipole antenna.
4. Replace the wireless device with an RF signal generator producing an unmodulated CW signal and set to the wireless device operating frequency.
5. Set the amplitude of the unmodulated signal to equal that recorded from the wireless device.
6. Record the reading of the probe measurement system of the unmodulated signal.
7. The ratio, in linear units, of the probe reading in step 6 to the reading in step 3 is the E-field modulation factor.
- 8 Repeat the above using the H-field probe, except locate the probe at the center of the dipole.

Please refer to Annex A.1 for 0 Hz-span spectrum analyzer plots. The signal generator was used to generate the CW and AM signals. The WD was used to generate the modulated signal.

Please refer to Annex A.2 for probe modulation factor measurement plots.

|   |  |                                      |                             |
|---|--|--------------------------------------|-----------------------------|
|  | Document   |                                      | Page                        |
|   | <b>Hearing Aid Compatibility RF Emissions Test Report for the BlackBerry® Smartphone model REA71UW</b> |                                      | 11(20)                      |
| Author Data<br><b>Daoud Attayi</b>  | Dates of Test<br><b>Feb 28, Mar. 22-23, Apr. 05, Aug. 09-31, 2011</b>                                  | Report No<br><b>RTS-5316-1109-55</b> | FCC ID<br><b>L6AREA70UW</b> |

| f (MHz) | Signal Type            | Peak Power (dBm) | Measured E-Field (V/m) | Target E-Field (V/m) | Delta (%) | PMF         |
|---------|------------------------|------------------|------------------------|----------------------|-----------|-------------|
| 835     | CW (Validation)        | 20.00            | <b>157.2</b>           | 163.0                | -3.56     |             |
| 835     | CW (Validation)        | 20.00            | <b>164.3</b>           | 163.0                | 0.80      |             |
| 835     | <b>GSM 850</b>         | 20.15            | 54.14                  |                      |           | <b>2.94</b> |
| 835     | CW                     | 20.14            | 159.3                  |                      |           |             |
| 835     | 80 % AM                | 20.16            | 99.82                  |                      |           |             |
| 1880    | CW (Validation)        | 20.00            | <b>132.7</b>           | 134.2                | -1.1      |             |
| 1880    | CW (Validation)        | 20.00            | <b>129.3</b>           | 134.2                | -3.65     |             |
| 1880    | <b>GSM 1900</b>        | 16.34            | 27.66                  |                      |           | <b>2.97</b> |
| 1880    | CW                     | 16.32            | 82.22                  |                      |           |             |
| 1880    | 80% AM                 | 16.27            | 53.34                  |                      |           |             |
| f (MHz) | Signal Type            | Peak Power (dBm) | Measured H-Field (A/m) | Target H-Field (A/m) | Delta (%) | PMF         |
| 835     | CW (Validation)        | 20.00            | <b>0.474</b>           | 0.464                | +2.2      |             |
| 835     | CW (Validation)        | 20.00            | <b>0.486</b>           | 0.464                | +4.7      |             |
| 835     | <b>GSM 850</b>         | 20.15            | 0.168                  |                      |           | <b>2.87</b> |
| 835     | CW                     | 20.14            | 0.482                  |                      |           |             |
| 835     | 80 % AM                | 20.16            | 0.302                  |                      |           |             |
| 1880    | <b>CW (Validation)</b> | 20.00            | <b>0.471</b>           | 0.471                | 0         |             |
| 1880    | <b>CW (Validation)</b> | 20.00            | <b>0.461</b>           | 0.471                | -2.1      |             |
| 1880    | <b>GSM 1900</b>        | 16.34            | 0.099                  |                      |           | <b>2.87</b> |
| 1880    | CW                     | 16.32            | 0.284                  |                      |           |             |
| 1880    | 80% AM                 | 16.27            | 0.184                  |                      |           |             |

**Table 5.1: Dipole Validation and Modulation Factors**

|   |  |                                      |                             |
|---|--|--------------------------------------|-----------------------------|
|  | Document   |                                      | Page                        |
|   | <b>Hearing Aid Compatibility RF Emissions Test Report for the BlackBerry® Smartphone model REA71UW</b> |                                      | 12(20)                      |
| Author Data<br><b>Daoud Attayi</b>  | Dates of Test<br><b>Feb 28, Mar. 22-23, Apr. 05, Aug. 09-31, 2011</b>                                  | Report No<br><b>RTS-5316-1109-55</b> | FCC ID<br><b>L6AREA70UW</b> |

| f (MHz) | Signal Type         | Peak Power (dBm) | Measured E-Field (V/m) | Target E-Field (V/m) | Delta (%) | PMF         |
|---------|---------------------|------------------|------------------------|----------------------|-----------|-------------|
| 835     | <b>UMTS band V</b>  | 10.91            | 56.94                  |                      |           | <b>1.01</b> |
| 835     | CW                  | 10.91            | 57.61                  |                      |           |             |
| 835     | 80% AM              | 10.94            | 37.11                  |                      |           |             |
| 1880    | <b>UMTS band II</b> | 10.57            | 38.48                  |                      |           | <b>1.12</b> |
| 1880    | CW                  | 10.57            | 43.02                  |                      |           |             |
| 1880    | 80% AM              | 10.58            | 27.54                  |                      |           |             |
| f (MHz) | Signal Type         | Peak Power (dBm) | Measured H-Field (A/m) | Target H-Field (A/m) | Delta (%) | PMF         |
| 835     | <b>UMTS band V</b>  | 10.91            | 0.168                  |                      |           | <b>0.99</b> |
| 835     | CW                  | 10.91            | 0.166                  |                      |           |             |
| 835     | 80% AM              | 10.94            | 0.106                  |                      |           |             |
| 1880    | <b>UMTS band II</b> | 10.57            | 0.138                  |                      |           | <b>1.12</b> |
| 1880    | CW                  | 10.57            | 0.155                  |                      |           |             |
| 1880    | 80% AM              | 10.58            | 0.099                  |                      |           |             |

**Table 5.2: Dipole Validation and Modulation Factors**

Probe Modulation Factor = Measured E or H-Field (CW)/Measured E or H-Field (Modulated)

|   |  |                         |                   |
|---|--|-------------------------|-------------------|
|  | Document   |                         | Page              |
|   | <b>Hearing Aid Compatibility RF Emissions Test Report for the BlackBerry® Smartphone model REA71UW</b> |                         | 13(20)            |
| Author Data   | Dates of Test  | Report No               | FCC ID            |
| <b>Daoud Attayi</b>   | <b>Feb 28, Mar. 22-23, Apr. 05, Aug. 09-31, 2011</b>   | <b>RTS-5316-1109-55</b> | <b>L6AREA70UW</b> |

## 5.2 Near-Field RF Emission

The following procedure was used to measure RF near E-field and H-field emissions:

1. Proper operation of the field probe, probe measurement system, other instrumentation, and the positioning system was confirmed.
2. The WD was oriented in its intended test position with the reference plane in the horizontal plane and was secured in the device holder to maintain position accuracy.
3. A CMU 200 Base Station Simulator was used to place a normal voice call to the WD on the desired channel and to transmit at maximum power.
4. The DASY5 system measures power drift as part of each scan. If the power during a scan drifted by more than 0.20 dB, the scan was repeated. Power drift measurements for the worst-case scans are included in Annex A.3. A fully charged battery was used for each test.
5. The 5cm x 5cm measurement grid was centered on the center of the acoustic output or the T-Coil output, as appropriate. The field probe was located at the initial position at the center of the measurement grid.
6. A surface verification was performed before each setup change to ensure repeatable spacing and proper maintenance of the measurement plane.
7. The electric field probe, and separately the magnetic field probe, was used to measure the highest field strength in the 5cm x 5cm reference plane. The center point of the probe measurement element(s) shall be held 15 mm from the WD reference plane.
8. The entire 5cm x 5cm region was scanned with a 5mm step size. The reading was recorded at each measurement location. Justification of the step size and interpolation used is provided at the end of Annex A.2.
9. Around the center sub-grid, five contiguous sub-grids were identified with the lowest maximum field strength readings. Please note that a maximum of five sub-grids can be excluded for both E- and H-field measurements.
10. The highest field reading was identified within the non-excluded sub-grids
11. The highest field reading was converted from average to peak V/m or A/m, as appropriate. This conversion was done by the DASY5 SEMCAD processor after entering correct PMF.
12. Once the worst-case configuration was determined, the WD was tested with second source battery.
13. The highest peak reading was compared to the categories defined in C63.19 using the appropriate AWF.

- If a WD has more than one antenna position, it is necessary to test the WD only in the condition of maximum antenna efficiency, i.e. antenna extended.
- The WD's backlight shuts off automatically a short time after a call is established.

|   |  |                                      |                             |
|---|--|--------------------------------------|-----------------------------|
|  | Document   |                                      | Page                        |
|   | <b>Hearing Aid Compatibility RF Emissions Test Report for the BlackBerry® Smartphone model REA71UW</b> |                                      | 14(20)                      |
| Author Data<br><b>Daoud Attayi</b>  | Dates of Test<br><b>Feb 28, Mar. 22-23, Apr. 05, Aug. 09-31, 2011</b>                                  | Report No<br><b>RTS-5316-1109-55</b> | FCC ID<br><b>L6AREA70UW</b> |

| Category       | Telephone RF Parameters < 960 MHz |                 |                   |              |                   |
|----------------|-----------------------------------|-----------------|-------------------|--------------|-------------------|
|                | Near Field                        | AWF             | E-Field Emissions |              | H-Field Emissions |
| Category M1/T1 | 0                                 | 631.0 to 1122.0 | V/m               | 1.91 to 3.39 | A/m               |
|                | -5                                | 473.2 to 841.4  | V/m               | 1.43 to 2.54 | A/m               |
| Category M2/T2 | 0                                 | 354.8 to 631.0  | V/m               | 1.07 to 1.91 | A/m               |
|                | -5                                | 266.1 to 473.2  | V/m               | 0.80 to 1.43 | A/m               |
| Category M3/T3 | 0                                 | 199.5 to 354.8  | V/m               | 0.60 to 1.07 | A/m               |
|                | -5                                | 149.6 to 266.1  | V/m               | 0.45 to 0.80 | A/m               |
| Category M4/T4 | 0                                 | < 199.5         | V/m               | < 0.60       | A/m               |
|                | -5                                | < 149.6         | V/m               | < 0.45       | A/m               |

| Category       | Telephone RF Parameters > 960 MHz |                |                   |              |                   |
|----------------|-----------------------------------|----------------|-------------------|--------------|-------------------|
|                | Near Field                        | AWF            | E-Field Emissions |              | H-Field Emissions |
| Category M1/T1 | 0                                 | 199.5 to 354.8 | V/m               | 0.60 to 1.07 | A/m               |
|                | -5                                | 149.6 to 266.1 | V/m               | 0.45 to 0.80 | A/m               |
| Category M2/T2 | 0                                 | 112.2 to 199.5 | V/m               | 0.34 to 0.60 | A/m               |
|                | -5                                | 84.1 to 149.6  | V/m               | 0.25 to 0.45 | A/m               |
| Category M3/T3 | 0                                 | 63.1 to 112.2  | V/m               | 0.19 to 0.34 | A/m               |
|                | -5                                | 47.3 to 84.1   | V/m               | 0.14 to 0.25 | A/m               |
| Category M4/T4 | 0                                 | <63.1          | V/m               | <0.19        | A/m               |
|                | -5                                | <47.3          | V/m               | <0.14        | A/m               |

Table 5.3: Wireless Device near-field categories

| Standard        | Technology          | AWF (dB) |
|-----------------|---------------------|----------|
| TIA/EIA/IS-2000 | CDMA                | 0        |
| TIA/EIA-136     | TDMA (50 Hz)        | 0        |
| J-STD-007       | GSM (217)           | -5       |
| T1/T1P1/3GPP    | UMTS (WCDMA)        | 0        |
| iDEN™           | TDMA (22 and 11 Hz) | 0        |

Table 5.4: Articulation Weighting Factor (AWF)

|   |  |   |                                      |
|---|--|---|--------------------------------------|
|  | Document<br><b>Hearing Aid Compatibility RF Emissions Test Report for the BlackBerry® Smartphone model REA71UW</b> |   | Page<br>15(20)                       |
|   | Author Data<br><b>Daoud Attayi</b>   | Dates of Test<br><b>Feb 28, Mar. 22-23, Apr. 05, Aug. 09-31, 2011</b> | Report No<br><b>RTS-5316-1109-55</b> |

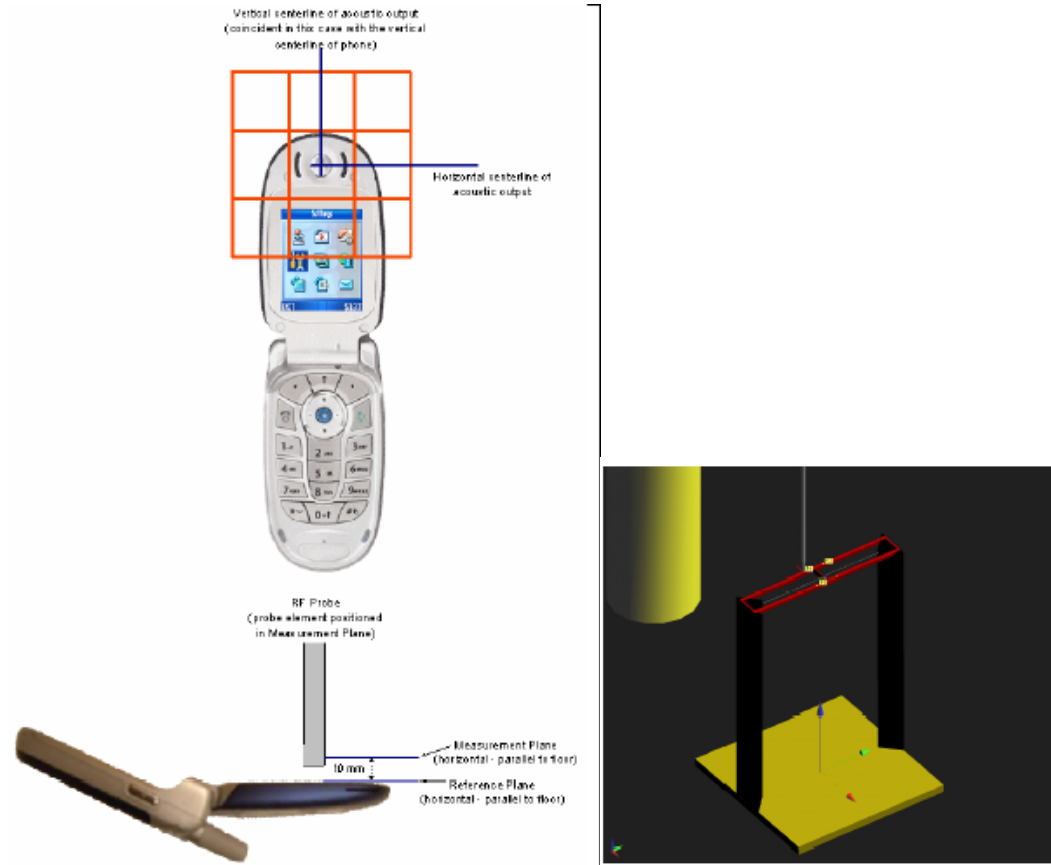

**Figure 5.3: WD reference plane for RF emission measurements    Figure 5.4: HAC Phantom/Test Arch**

|   |  |                                      |                             |
|---|--|--------------------------------------|-----------------------------|
|  | Document   |                                      | Page                        |
|   | <b>Hearing Aid Compatibility RF Emissions Test Report for the BlackBerry® Smartphone model REA71UW</b> |                                      | 16(20)                      |
| Author Data<br><b>Daoud Attayi</b>  | Dates of Test<br><b>Feb 28, Mar. 22-23, Apr. 05, Aug. 09-31, 2011</b>                                  | Report No<br><b>RTS-5316-1109-55</b> | FCC ID<br><b>L6AREA70UW</b> |

## 6.0 Summary of results

| RF Emissions Test        |         |                  |                     |                               |          |
|--------------------------|---------|------------------|---------------------|-------------------------------|----------|
| Mode                     | f (MHz) | Cond. Pwr. (dBm) | Peak E- Field (A/m) | Center of Speaker or Telecoil | M-Rating |
| GSM 850                  | 824.2   | 33.4             | 177.90              | Speaker                       | 3        |
|                          | 836.8   | 33.3             | 203.80              | Speaker                       | 3        |
|                          | 848.8   | 33.3             | 197.20              | Speaker                       | 3        |
| GSM 1900                 | 1850.2  | 28.8             | 77.49               | Speaker                       | 3        |
|                          | 1880.0  | 29.0             | 73.44               | Speaker                       | 3        |
|                          | 1909.8  | 29.0             | 76.03               | Speaker                       | 3        |
| WCDMA band V 850         | 826.4   | 24.1             | 61.62               | Speaker                       | 4        |
|                          | 836.4   | 24.1             | 71.93               | Speaker                       | 4        |
|                          | 846.6   | 24.1             | 78.87               | Speaker                       | 4        |
| WCDMA band II 1900       | 1852.4  | 21.6             | 44.40               | Speaker                       | 4        |
|                          | 1880.0  | 21.7             | 41.62               | Speaker                       | 4        |
|                          | 1907.6  | 21.7             | 42.77               | Speaker                       | 4        |
| <b>Overall M-Rating:</b> |         |                  |                     |                               | 3        |

**Table 6.1–E-Field Data Summary**



|   |  |                                      |                             |
|---|--|--------------------------------------|-----------------------------|
|  | Document   |                                      | Page                        |
|   | <b>Hearing Aid Compatibility RF Emissions Test Report for the BlackBerry® Smartphone model REA71UW</b> |                                      | 17(20)                      |
| Author Data<br><b>Daoud Attayi</b>  | Dates of Test<br><b>Feb 28, Mar. 22-23, Apr. 05, Aug. 09-31, 2011</b>                                  | Report No<br><b>RTS-5316-1109-55</b> | FCC ID<br><b>L6AREA70UW</b> |

| RF Emissions Test        |         |                  |                    |                               |          |
|--------------------------|---------|------------------|--------------------|-------------------------------|----------|
| Mode                     | f (MHz) | Cond. Pwr. (dBm) | Peak H-Field (A/m) | Center of Speaker or Telecoil | M-Rating |
| GSM 850                  | 824.2   | 33.4             | 0.429              | Speaker                       | 4        |
|                          | 836.8   | 33.3             | 0.458              | Speaker                       | 3        |
|                          | 848.8   | 33.3             | 0.526              | Speaker                       | 3        |
| GSM 1900                 | 1850.2  | 28.8             | 0.235              | Speaker                       | 3        |
|                          | 1880.0  | 29.0             | 0.234              | Speaker                       | 3        |
|                          | 1909.8  | 29.0             | 0.229              | Speaker                       | 3        |
| WCDMA band V 850         | 826.4   | 24.1             | 0.145              | Speaker                       | 4        |
|                          | 836.4   | 24.1             | 0.164              | Speaker                       | 4        |
|                          | 846.6   | 24.1             | 0.192              | Speaker                       | 4        |
| WCDMA band II 1900       | 1852.4  | 21.6             | 0.124              | Speaker                       | 4        |
|                          | 1880.0  | 21.7             | 0.120              | Speaker                       | 4        |
|                          | 1907.6  | 21.7             | 0.127              | Speaker                       | 4        |
| <b>Overall M-Rating:</b> |         |                  |                    |                               | <b>3</b> |

**Table 6.2– H--Field Data Summary**

|   |  |                         |                   |
|---|--|-------------------------|-------------------|
|  | Document   |                         | Page              |
|   | <b>Hearing Aid Compatibility RF Emissions Test Report for the BlackBerry® Smartphone model REA71UW</b> |                         | 18(20)            |
| Author Data   | Dates of Test  | Report No               | FCC ID            |
| <b>Daoud Attayi</b>   | <b>Feb 28, Mar. 22-23, Apr. 05, Aug. 09-31, 2011</b>   | <b>RTS-5316-1109-55</b> | <b>L6AREA70UW</b> |

## 6.1 Conclusion

The BlackBerry® Smartphone Model: REA71UW is categorized to be **M3** based on HAC RF Emission performance in accordance with ANSI C63.19-2007: American National Standard for Methods of Measurement of Compatibility between Wireless Communication Devices and Hearing Aids.

Therefore, the device is found to be in compliance with the requirements of FCC 20.19 (10-1-07 Edition) Hearing Aid-Compatible Mobile Handsets as modified by FCC Public Notice DA 06-1215 (Released: June 6, 2006) and FCC Report and Order, FCC 08-68 (Feb 28, 2008).

|   |  |   |                                      |
|---|--|---|--------------------------------------|
|  | Document<br><b>Hearing Aid Compatibility RF Emissions Test Report for the BlackBerry® Smartphone model REA71UW</b> |   | Page<br>19(20)                       |
|   | Author Data<br><b>Daoud Attayi</b>   | Dates of Test<br><b>Feb 28, Mar. 22-23, Apr. 05, Aug. 09-31, 2011</b> | Report No<br><b>RTS-5316-1109-55</b> |
|   |  | FCC ID<br><b>L6AREA70UW</b>   |                                      |

## 7.0 Measurement uncertainty

| <b>HAC Uncertainty Budget</b><br>According to ANSI C63.19 [1] |                   |             |            |                     |                     |             |             |
|---|-------------------|-------------|------------|---------------------|---------------------|-------------|-------------|
| Error Description   | Uncertainty value | Prob. Dist. | Div.       | (c <sub>1</sub> ) E | (c <sub>1</sub> ) H | Std. Unc. E | Std. Unc. H |
| Measurement System  |                   |             |            |                     |                     |             |             |
| Probe Calibration   | ±5.1 %            | N           | 1          | 1                   | 1                   | ±5.1 %      | ±5.1 %      |
| Axial Isotropy  | ±4.7 %            | R           | $\sqrt{3}$ | 1                   | 1                   | ±2.7 %      | ±2.7 %      |
| Sensor Displacement   | ±16.5 %           | R           | $\sqrt{3}$ | 1                   | 0.145               | ±9.5 %      | ±1.4 %      |
| Boundary Effects  | ±2.4 %            | R           | $\sqrt{3}$ | 1                   | 1                   | ±1.4 %      | ±1.4 %      |
| Linearity   | ±4.7 %            | R           | $\sqrt{3}$ | 1                   | 1                   | ±2.7 %      | ±2.7 %      |
| Scaling to Peak Envelope Power                                | ±2.0 %            | R           | $\sqrt{3}$ | 1                   | 1                   | ±1.2 %      | ±1.2 %      |
| System Detection Limit  | ±1.0 %            | R           | $\sqrt{3}$ | 1                   | 1                   | ±0.6 %      | ±0.6 %      |
| Readout Electronics   | ±0.3 %            | N           | 1          | 1                   | 1                   | ±0.3 %      | ±0.3 %      |
| Response Time   | ±0.8 %            | R           | $\sqrt{3}$ | 1                   | 1                   | ±0.5 %      | ±0.5 %      |
| Integration Time  | ±2.6 %            | R           | $\sqrt{3}$ | 1                   | 1                   | ±1.5 %      | ±1.5 %      |
| RF Ambient Conditions   | ±3.0 %            | R           | $\sqrt{3}$ | 1                   | 1                   | ±1.7 %      | ±1.7 %      |
| RF Reflections  | ±12.0 %           | R           | $\sqrt{3}$ | 1                   | 1                   | ±6.9 %      | ±6.9 %      |
| Probe Positioner  | ±1.2 %            | R           | $\sqrt{3}$ | 1                   | 0.67                | ±0.7 %      | ±0.5 %      |
| Probe Positioning   | ±4.7 %            | R           | $\sqrt{3}$ | 1                   | 0.67                | ±2.7 %      | ±1.8 %      |
| Extrap. and Interpolation                                     | ±1.0 %            | R           | $\sqrt{3}$ | 1                   | 1                   | ±0.6 %      | ±0.6 %      |
| <b>Test Sample Related</b>                                    |                   |             |            |                     |                     |             |             |
| Device Positioning Vertical                                   | ±4.7 %            | R           | $\sqrt{3}$ | 1                   | 0.67                | ±2.7 %      | ±1.8 %      |
| Device Positioning Lateral                                    | ±1.0 %            | R           | $\sqrt{3}$ | 1                   | 1                   | ±0.6 %      | ±0.6 %      |
| Device Holder and Phantom                                     | ±2.4 %            | R           | $\sqrt{3}$ | 1                   | 1                   | ±1.4 %      | ±1.4 %      |
| Power Drift   | ±5.0 %            | R           | $\sqrt{3}$ | 1                   | 1                   | ±2.9 %      | ±2.9 %      |
| <b>Phantom and Setup Related</b>                              |                   |             |            |                     |                     |             |             |
| Phantom Thickness   | ±2.4 %            | R           | $\sqrt{3}$ | 1                   | 0.67                | ±1.4 %      | ±0.9 %      |
| Combined Std. Uncertainty                                     |                   |             |            |                     |                     | ±14.7 %     | ±10.9 %     |
| Expanded Std. Uncertainty on Power                            |                   |             |            |                     |                     | ±29.4 %     | ±21.8 %     |
| Expanded Std. Uncertainty on Field                            |                   |             |            |                     |                     | ±14.7 %     | ±10.9 %     |

**Table 7.1. Worst-Case uncertainty budget for HAC free field assessment according to ANSI C63.19.**

[1] The budget is valid for the frequency range 800 MHz - 3 GHz and represents a worst-case analysis.

|   |  |                         |                   |
|---|--|-------------------------|-------------------|
|  | Document   |                         | Page              |
|   | <b>Hearing Aid Compatibility RF Emissions Test Report for the BlackBerry® Smartphone model REA71UW</b> |                         | 20(20)            |
| Author Data   | Dates of Test  | Report No               | FCC ID            |
| <b>Daoud Attayi</b>   | <b>Feb 28, Mar. 22-23, Apr. 05, Aug. 09-31, 2011</b>   | <b>RTS-5316-1109-55</b> | <b>L6AREA70UW</b> |

## 7.1 Site-Specific Uncertainty

### RF Reflections

Section 4.2 of ANSI C63.19 requires that any RF reflecting objects are a minimum distance of 2 wavelengths away from the WD under test. For this WD, the longest wavelength occurs when the WD is transmitting at 824.7MHz. The wavelength is:

$$\lambda = \frac{c}{f} = \frac{3 \cdot 10^8 \text{ m/s}}{824.7 \text{ MHz}} = 0.364 \text{ m}$$

Therefore, 2 wavelengths result in a distance of 0.73m. Tests are performed in an RF shielded chamber. The distance to the nearest wall is > 1m and the distance to the robot's safety guardrail is ~1.0m, both satisfying the requirement. In addition, RF absorbing cones are placed at the base of the robot to further reduce reflections. The HAC phantom arch is made of low dielectric constant plastic and should not be a source of reflections.

### Environmental Conditions

During measurements, the temperature of the test lab was kept between 21°C and 25°C and relative humidity was maintained between 20% and 55%.

### Ambient Noise

ANSI C63.19 standard requires RF ambient noise to be at least 20dB below the measurement level. Scans of RF ambient noise fields were previously performed for verification and was determined to be < 20 dB than the measured WD RF field levels.