

EMI Test Report

Tested in accordance with
Federal Communications Commission (FCC)
Personal Communications Services
CFR 47, Part 15 Subpart C
&
Industry Canada (IC) RSS-210, RSS-GEN



A division of Research In Motion Limited

REPORT NO.: RTS-2604-1106-132B

PRODUCT MODEL NO.: RDR61CW, RDZ21CW
TYPE NAME: BlackBerry® smartphone
FCC ID: L6ARDR60CW, L6ARDZ20CW
IC: 2503A-RDR60CW, 2503A-RDZ20CW

DATE: July 26, 2011

		EMI Test Report for the BlackBerry® smartphone Model RDR61CW, RDZ21CW
Test Report No. RTS-2604-1106-132B	Dates of Test May 04 to 05, June 08 to July 07, 2011	FCC ID: L6ARDR60CW IC: 2503A-RDR60CW FCC ID: L6ARDZ20CW IC: 2503A-RDZ20CW

Statement of Performance:

The BlackBerry® smartphone, model RDR61CW, part number CER-41454-001 Rev4, and its accessories perform within the requirements of the test standards when configured and operated under RIM’s operation instructions.

The BlackBerry® smartphone, model RDZ21CW, part number CER-39236-001 Rev. 1, and its accessories perform within the requirements of the test standards when configured and operated under RIM’s operation instructions.

Declaration:

We hereby certify that:

The test data reported herein is an accurate record of the performance of the sample(s) tested.

The test results are valid for the tested unit (s) only.

The test equipment used was suitable for the tests performed and within manufacturer’s published specifications and operating parameters.

The test methods were consistent with the methods described in the relevant standards.

Documented by:

Reviewed by:



Savtej S. Sandhu
Regulatory Compliance Specialist
Date: July 26, 2011

Heng Lin
Regulatory Compliance Specialist
Date: July 26, 2011

Reviewed and Approved by:



Masud S. Attayi, P.Eng.
Manager, Regulatory Compliance
Date: July 28, 2011



	EMI Test Report for the BlackBerry® smartphone Model RDR61CW, RDZ21CW	
Test Report No. RTS-2604-1106-132B	Dates of Test May 04 to 05, June 08 to July 07, 2011	FCC ID: L6ARDR60CW IC: 2503A-RDR60CW FCC ID: L6ARDZ20CW IC: 2503A-RDZ20CW

Table of Contents

A.	Scope.....	4
B.	Associated Documents	4
C.	Product Identification.....	4
D.	Support Equipment Used for the Testing of the EUT	6
E.	Test Results Chart	7
F.	Summary of Results.....	8
G.	Compliance Test Equipment Used.....	14
	APPENDIX 1 – AC CONDUCTED EMISSIONS TEST DATA/PLOTS.....	15
	APPENDIX 2 – BLUETOOTH AND 802.11b/g/n RADIATED EMISSIONS TEST DATA	22
	APPENDIX 3 – BLUETOOTH CONDUCTED EMISSIONS TEST DATA/PLOTS	36
	APPENDIX 4 – 802.11b/g/n CONDUCTED EMISSIONS TEST DATA/PLOTS	60
	APPENDIX 5 – NEAR FIELD COMMUNICATIONS TEST DATA/PLOTS	84

		EMI Test Report for the BlackBerry® smartphone Model RDR61CW, RDZ21CW
Test Report No. RTS-2604-1106-132B	Dates of Test May 04 to 05, June 08 to July 07, 2011	FCC ID: L6ARDR60CW IC: 2503A-RDR60CW FCC ID: L6ARDZ20CW IC: 2503A-RDZ20CW

A. Scope

This report details the results of compliance tests which were performed in accordance to the requirements of:

- o FCC CFR 47 Part 15, Subpart C, October, 2010
- o Industry Canada, RSS-210, Issue 8, December 2010, Licence-exempt Radio Apparatus
- o Industry Canada, RSS-GEN, Issue 3, December 2010, General Requirements and Information for the Certification of Radio Apparatus

B. Associated Documents

1. RDR61CW_HW_Declaration_CER-41454-001_Rev2
2. RDR61CW_HW_Declaration_CER-41454-001_Rev3
3. RDR61CW_HW_Declaration_CER-41454-001_Rev4
4. MultiSourceDeclaration_RDR61CW_b848
5. BlackBerrySystemSimilarity_RDR61CW_RDZ21CW

C. Product Identification

Manufactured by Research In Motion Limited whose headquarters is located at:
295 Phillip Street
Waterloo, Ontario
Canada, N2L 3W8
Phone: 519 888 7465
Fax: 519 888 6906

The equipment under test (EUT) was tested at the following locations:

RIM Testing Services EMI test facilities	
305 Phillip Street	440 Phillip Street
Waterloo, Ontario	Waterloo, Ontario
Canada, N2L 3W8	Canada, N2L 5R9
Phone: 519 888 7465	Phone: 519 888 7465
Fax: 519 888 6906	Fax: 519 888 6906

The testing was performed on May 04 to 05, June 08 to July 07, 2011.

		EMI Test Report for the BlackBerry® smartphone Model RDR61CW, RDZ21CW
Test Report No. RTS-2604-1106-132B	Dates of Test May 04 to 05, June 08 to July 07, 2011	FCC ID: L6ARDR60CW IC: 2503A-RDR60CW FCC ID: L6ARDZ20CW IC: 2503A-RDZ20CW

The sample EUT included:

SAMPLE	MODEL	CER NUMBER	PIN	SOFTWARE
1	RDR61CW	CER-41454-001 Rev1	32E4DED4	MFI Bundle
2	RDR61CW	CER-41454-001 Rev1	32E4E1CE	V6.1.0.60 (Platform:5.0.0.173) Bundle 580
3	RDR61CW	CER-41454-001 Rev3	32EAF912	V7.0.0.100 (Platform:5.0.0.267) Bundle 848
4	RDR61CW	CER-41454-001 Rev4	32EFD941	V7.0.0.100 (Platform:5.0.0.267) Bundle 848
5	RDR61CW	CER-41454-001 Rev4	32EFD957	V7.0.0.100 (Platform:5.0.0.267) Bundle 848

AC Line Conducted Emissions testing was performed on sample 5.
Radiated Emissions testing was performed on samples 2, 3, 4 and 5.
Conducted Emissions testing was performed on sample 1.
Near Field Communications testing was performed on samples 1 and 4.

Only the characteristics that may have been affected by the changes from model RDR61CW Rev 1 to RDR61CW Rev 4 were re-tested. For more information, see RDR61CW_HW_Declaration_CER-41454-001_Rev2, RDR61CW_HW_Declaration_CER-41454-001_Rev3 and RDR61CW_HW_Declaration_CER-41454-001_Rev4.

To view the differences between software bundles 580 and 848, see documents MultiSourceDeclaration_RDR61CW_b848.

Only the characteristics that may have been affected by the changes from model RDR61CW to RDZ21CW were re-tested. For more information, see BlackBerrySystemSimilarity_RDR61CW_RDZ21CW.

BlackBerry® smartphone Accessories Tested

- 1) Alt. Fixed Blade Charger, part number HDW-24481-001 (model number PSM04A-050QRIM) with an output voltage of 5.0 volts dc.
- 2) Captive Cable Charger, part number HDW-17957-003, with an output voltage of 5.0 volts DC, 750 mA.
- 3) Straight Jack Stereo Headset, part number HDW-24529-004, with a lead length of 1.1 metres
- 4) Premium Stereo Headset, part number HDW-15766-005, with a lead length of 1.1 metres
- 5) USB Data Cable, part number HDW-06610-009, 1.0 metre long.

	EMI Test Report for the BlackBerry® smartphone Model RDR61CW, RDZ21CW	
Test Report No. RTS-2604-1106-132B	Dates of Test May 04 to 05, June 08 to July 07, 2011	FCC ID: L6ARDR60CW IC: 2503A-RDR60CW FCC ID: L6ARDZ20CW IC: 2503A-RDZ20CW

D. Support Equipment Used for the Testing of the EUT

No support equipment used. See section *G. Compliance Test Equipment Used.*

**Test Report No.**
RTS-2604-1106-132B**Dates of Test**
May 04 to 05, June 08 to July 07, 2011**FCC ID:** L6ARDR60CW **IC:** 2503A-RDR60CW
FCC ID: L6ARDZ20CW **IC:** 2503A-RDZ20CW**E. Test Results Chart**

SPECIFICATION		TEST TYPE	Meets Requirements	TEST DATA
FCC CFR 47	IC			APPENDIX
Part 15.207	RSS-210 RSS-GEN	Conducted AC Line Emission	Pass	1
Part 15.209 Part 15.247	RSS-210 RSS-GEN	BT Radiated Spurious Emissions	Pass	2
Part 15.209 Part 15.247	RSS-210 RSS-GEN	BT Radiated Band Edge Compliance	Pass	2
Part 15.209 Part 15.247	RSS-210 RSS-GEN	802.11b/g/n Radiated Spurious Emissions	Pass	2
Part 15.209 Part 15.247	RSS-210 RSS-GEN	802.11b/g/n Radiated Band Edge Compliance	Pass	2
Part 15.247(a)	RSS-210	BT, 20 dB Bandwidth	Pass	3
Part 15.247(a)	RSS-210	BT, Carrier Frequency Separation	Pass	3
Part 15.247(a)	RSS-210	BT, Number of Hopping Frequencies	Pass	3
Part 15.247(a)	RSS-210	BT, Time of Occupancy (Dwell Time)	Pass	3
Part 15.247(b)	RSS-210	BT, Maximum Peak Conducted Output Power	Pass	3
Part 15.247(c)	RSS-210	BT, Band-Edge Compliance of RF Conducted Emissions	Pass	3
Part 15.247(c)	RSS-210	BT, Spurious RF Conducted Emissions	Pass	3
Part 15.247(b)	RSS-210	802.11b/g/n, 6 dB Bandwidth	Pass	4
Part 15.247(b)	RSS-210	802.11b/g/n, Maximum Conducted Output Power	Pass	4
Part 15.247(b)	RSS-210	802.11b/g/n, Band-Edge	Pass	4
Part 15.247(b)	RSS-210	802.11b/g/n, Peak Power Spectral Density	Pass	4
Part 15.247(b)	RSS-210	802.11b/g/n, Spurious RF Conducted Emissions	Pass	4
Part 15.209 Part 15.225(a)	RSS-210 RSS-GEN	Near Field Communications, Radiated Emissions	Pass	5
Part 15.225(e)	RSS-210	Near Field Communications, Occupied Bandwidth	Pass	5
Part 15.225(e)	RSS-210	Near Field Communications, Frequency Stability	Pass	5

		EMI Test Report for the BlackBerry® smartphone Model RDR61CW, RDZ21CW
Test Report No. RTS-2604-1106-132B	Dates of Test May 04 to 05, June 08 to July 07, 2011	FCC ID: L6ARDR60CW IC: 2503A-RDR60CW FCC ID: L6ARDZ20CW IC: 2503A-RDZ20CW

F. Summary of Results

1) AC LINE CONDUCTED EMISSIONS

The conducted emissions were measured using the test procedure outlined in CISPR Recommendation 22 through a 50 Ohm Line Impedance Stabilization Network (LISN), which was inserted in the power line to the equipment to provide the specified impedance for measurements. The EUT was placed on a nonconductive wooden table, 80 cm high that was positioned 40 cm from a vertical ground plane. The RF output of the network was connected to an EMI receiver system with characteristics that duplicate those of the receiver specified in CISPR Publication 16. BlackBerry® smartphone was in battery charging mode. The input voltage was 120 V, 60 Hz.

The following test configurations were measured for model RDR61CW:

Test Configuration	Operating Mode(s)	Charger + Accessories
1	Bluetooth Tx + Audio Playing	Alt. Fixed Blade Charger + Straight Jack Stereo Headset + USB Cable 1.0m
2	802.11b Tx + Video Playing	Captive Cable Charger + Premium Stereo Headset

The sample EUT's conducted emissions were compared with respect to the FCC CFR 47 Part 15, Subpart C and IC RSS-210 limits. The sample EUT had a worst case test margin of 9.07 dB below the QP limit at 0.182 MHz using the QP detector in Test Configuration 2.

See APPENDIX 1 for the test data.

Measurement Uncertainty ±3.0 dB

		EMI Test Report for the BlackBerry® smartphone Model RDR61CW, RDZ21CW
Test Report No. RTS-2604-1106-132B	Dates of Test May 04 to 05, June 08 to July 07, 2011	FCC ID: L6ARDR60CW IC: 2503A-RDR60CW FCC ID: L6ARDZ20CW IC: 2503A-RDZ20CW

2) RADIATED EMISSIONS

The EUT was placed on a nonconductive styrofoam table, 80 cm high that was positioned on a remotely controlled turntable. The test distance used between the EUT and the receiving antenna was three metres. The turntable was rotated to determine the azimuth of the peak emissions. Then the emissions were maximized by elevating the antenna in the range of 1 to 4 metres. The maximum emission level was recorded. The frequency range measured was from 30 MHz to 25.0 GHz. Both the horizontal and vertical polarizations of the emissions were measured.

The measurements were done in a semi-anechoic chamber (SAC) below 1 GHz and a semi-anechoic chamber (SAC) with floor absorbers above 1 GHz. The SAC's FCC registration number is **778487** and the Industry Canada (IC) file number is **2503B-1**. The SAC with floor absorber's FCC registration number is **959115** and the IC file number is **2503C-1**.

The EUT was configured and operated to produce the maximum radiated emissions while still keeping within RIM's specifications.

The following test configurations were measured for model RDR61CW:

a) Radiated Spurious and Harmonic Emissions

The BlackBerry® smartphone was measured in standalone configuration with Bluetooth transmitting in single frequency mode at low channel (0), middle channel (39) and high channel (78) for packet type "DH5", "2-DH5" and "3-DH5". The system's radiated emission levels were compared with respect to the FCC CFR 47 Part 15, Subpart C, 15.247 and RSS-210.

The BlackBerry® smartphone was measured in standalone configuration transmitting on channels 1, 6 & 11 at 1 Mbps for 802.11b mode, at 6 Mbps for 802.11g mode, and at MCS 0 for 802.11n mode. The system's radiated emission levels were compared with respect to the FCC CFR 47 Part 15 Subpart C, 15.247 and RSS-210.

The Bluetooth harmonics were investigated up to the 10th harmonic. The sample EUT emissions were in the noise floor (NF).

The 802.11b/g/n harmonics were investigated up to the 10th harmonic. The sample EUT emissions were in the noise floor (NF).

See APPENDIX 2 for the test data.

		EMI Test Report for the BlackBerry® smartphone Model RDR61CW, RDZ21CW
Test Report No. RTS-2604-1106-132B	Dates of Test May 04 to 05, June 08 to July 07, 2011	FCC ID: L6ARDR60CW IC: 2503A-RDR60CW FCC ID: L6ARDZ20CW IC: 2503A-RDZ20CW

b) Band-Edge Compliance of RF Radiated Emissions

The BlackBerry® smartphone met the requirements for band-edge compliance of RF radiated emissions for Bluetooth and 802.11b/g/n as per the requirements of 15.247, 15.209, and RSS-210/RSS-GEN.

Measurement Uncertainty ±4.6 dB

See APPENDIX 2 for the test data

3) BLUETOOTH RF CONDUCTED EMISSIONS

The Bluetooth conducted RF emissions from the BlackBerry® smartphone were measured using the methods outlined in FCC CFR 47 Part 15, Subpart C.

The following test configurations were measured for model RDR61CW:

a) 20 dB Bandwidth

The BlackBerry® smartphone met the requirements of the 20 dB bandwidth as per 47 CFR 15.247(a) and RSS-210. Low channel (0), middle channel (39) and high channel (78) were measured. The result includes both normal data rate and EDR. The worst case 20 dB Bandwidth was 0.927 MHz for channel 39 in normal data rate mode and 1.313 MHz for channel 78 in EDR mode.

See APPENDIX 3 for the test data.

b) Carrier Frequency Separation

The BlackBerry® smartphone met the requirements of the carrier frequency separation as per 47 CFR 15.247(a) and RSS-210. Channel 38 to 39 was measured. The result includes both normal data rate and EDR.

See APPENDIX 3 for the test data.

c) Number of Hopping Frequencies

The BlackBerry® smartphone met the requirements of the number of hopping frequencies as per 47 CFR 15.247(a) and RSS-210. The number of hopping channels measured was 79.

See APPENDIX 3 for the test data.

d) Time of Occupancy (Dwell Time)

The EUT met the requirements of the dwell time as per 47 CFR 15.247(a) and RSS-210. Low channel (0), middle channel (39) and high channel (78) were measured in DH1, DH3 and DH5 modes. Bluetooth was operating in frequency hopping (Euro/US) mode during the measurements.

See APPENDIX 3 for the test data.

		EMI Test Report for the BlackBerry® smartphone Model RDR61CW, RDZ21CW
Test Report No. RTS-2604-1106-132B	Dates of Test May 04 to 05, June 08 to July 07, 2011	FCC ID: L6ARDR60CW IC: 2503A-RDR60CW FCC ID: L6ARDZ20CW IC: 2503A-RDZ20CW

e) Maximum Peak Conducted Output Power

The BlackBerry® smartphone met the requirements of the maximum peak conducted output power as per 47 CFR 15.247(b) and RSS-210. Low channel (0), middle channel (39) and high channel (78) were measured. The result includes both normal data rate and EDR. The worst case Conducted Output Power level was 8.17 dBm (0.00656 W) for Channel 39 in normal data rate mode and 8.00 dBm (0.00631 W) for channels 0 and 39 in EDR mode.

See APPENDIX 3 for the test data.

f) Band-Edge Compliance of RF Conducted Emissions

The BlackBerry® smartphone met the requirements of the band-edge compliance of RF conducted emissions as per 47 CFR 15.247(c) and RSS-210. Channels 0 and 78 were measured in frequency hopping (Euro/US) mode and single frequency mode. The result includes both normal data rate and EDR.

See APPENDIX 3 for the test data.

g) Spurious RF Conducted Emissions

The BlackBerry® smartphone met the requirements of the spurious RF conducted emissions as per 47 CFR 15.247(c) and RSS-210. The frequency range measured was 10 MHz to 26 GHz. Low channel (0), middle channel (39) and high channel (78) were measured in single frequency mode and frequency hopping (Euro/US) mode. The result includes both normal data rate and EDR.

See APPENDIX 3 for the test data.

4) 802.11b/g/n RF CONDUCTED EMISSIONS

The 802.11b/g/n conducted RF emissions from the BlackBerry® smartphone were measured using the methods outlined in FCC CFR 47 Part 15, Subpart C.

The following test configurations were measured for model RDR61CW:

a) 6dB Bandwidth

The EUT met the requirements of the 6 dB bandwidth as per 47 CFR 15.247(b) and RSS-210. Low channel (1), middle channel (6) and high channel (11) were measured. The worst case 6 dB Bandwidth was 11.33 MHz for channel 11 in 802.11b mode, 16.67 MHz for channel 6 in 802.11g mode, and 17.80 MHz for channel 1 and 6 in 802.11n mode.

See APPENDIX 4 for the test data.

	EMI Test Report for the BlackBerry® smartphone Model RDR61CW, RDZ21CW	
Test Report No. RTS-2604-1106-132B	Dates of Test May 04 to 05, June 08 to July 07, 2011	FCC ID: L6ARDR60CW IC: 2503A-RDR60CW FCC ID: L6ARDZ20CW IC: 2503A-RDZ20CW

b) Maximum Conducted Output Power

The EUT met the requirements of the maximum conducted output power as per 47 CFR 15.247(b) and RSS-210. Low channel (1), middle channel (6) and high channel (11) were measured. The worst case Conducted Output Power level was 19.62 dBm (91.62 mW) for channel 11 in 802.11b mode, 17.41 dBm (55.08 mW) for channel 6 in 802.11g mode, and 17.33 dBm (54.08 mW) for channel 6 in 802.11n mode.

See APPENDIX 4 for the test data

c) Band-Edge Compliance of RF Conducted Emissions

The EUT met the requirements of band-edge compliance of RF conducted emissions as per 47 CFR 15.247(b) and RSS-210. Low channel (1) and high channel (11) were measured.

See APPENDIX 4 for the test data.

d) Peak Power Spectral Density

The EUT met the requirements of peak power spectral density as per 47 CFR 15.247(b) and RSS-210. Low channel (1), middle channel (6) and high channel (11) were measured.

See APPENDIX 4 for the test data.

e) Spurious RF Conducted Emissions

The EUT met the requirements of the spurious RF conducted emissions as per 47 CFR 15.247(c) and RSS-210. The frequency range measured was 30 MHz to 26 GHz. Low channel (1), middle channel (6) and high channel (11) were measured.

See APPENDIX 4 for the test data.

5) Near Field Communications (NFC)

The Near Field Communications emissions from the BlackBerry® smartphone were measured using the methods outlined in FCC CFR 47 Part 15, Subpart C.

The following test configurations were measured for model RDR61CW:

a) Radiated Emissions

The BlackBerry® smartphone was measured in standalone configuration transmitting at 13.56 MHz. The system's radiated emission levels were compared with respect to the FCC CFR 47 Part 15 Subpart C, 15.209, 15.225(a) and RSS-210/RSS-GEN.

	EMI Test Report for the BlackBerry® smartphone Model RDR61CW, RDZ21CW	
Test Report No. RTS-2604-1106-132B	Dates of Test May 04 to 05, June 08 to July 07, 2011	FCC ID: L6ARDR60CW IC: 2503A-RDR60CW FCC ID: L6ARDZ20CW IC: 2503A-RDZ20CW

The NFC emissions were investigated up to 1 GHz. The sample EUT has a field strength measurement of 50.78 dBuV/m.
See APPENDIX 5 for the test data.

b) Occupied Bandwidth

The EUT met the requirements of the Occupied bandwidth as per 47 CFR 15 C and RSS-210. The EUT was measured in test mode with modulation on and transmitting at 13.56 MHz.
See APPENDIX 5 for the test data.

c) Frequency Stability

The EUT met the requirements of the Frequency Stability as per 47 CFR 15.225(e) and RSS-210. The EUT was measured in test mode with modulation on and transmitting at 13.56 MHz.
See APPENDIX 5 for the test data.

		EMI Test Report for the BlackBerry® smartphone Model RDR61CW, RDZ21CW
Test Report No. RTS-2604-1106-132B	Dates of Test May 04 to 05, June 08 to July 07, 2011	FCC ID: L6ARDR60CW IC: 2503A-RDR60CW FCC ID: L6ARDZ20CW IC: 2503A-RDZ20CW

G. Compliance Test Equipment Used

<u>UNIT</u>	<u>MANUFACTURER</u>	<u>MODEL</u>	<u>SERIAL NUMBER</u>	<u>CAL DUE DATE</u> (YY MM DD)	<u>USE</u>
EMI Test Receiver	Rohde & Schwarz	ESIB 40	100255	11-11-28	Conducted/Radiated Emissions
EMI Test Receiver	Rohde & Schwarz	ESU 40	100162	11-11-29	Conducted/Radiated Emissions
Hybrid Log Antenna	EMC Automation	HLP-3003C	017401	12-01-13	Radiated Emissions
Horn Antenna	CMT	LHA 0180	R52734-001	12-01-21	Radiated Emissions
Horn Antenna	ETS-Lindgren	3117	47563	11-07-15	Radiated Emissions
Preamplifier	Rohde & Schwarz	TS-ANA4-SP	001	11-12-01	Radiated Emissions
Preamplifier	Sonoma	310N/11909A	185831	11-11-14	Radiated Emissions
Preamplifier	Rohde & Schwarz	TS-ANA-SP	001	11-12-01	Radiated Emissions
L.I.S.N.	Rohde & Schwarz	ENV216	100060	11-12-10	Conducted Emissions
Environment Monitor	Omega	iTHX-SD	0380561	11-10-13	Radiated Emissions
EMC Analyzer	Agilent	E7405A	US40240226	11-12-10	Radiated Emissions
Spectrum Analyzer	HP	8563E	3745A08112	11-09-30	RF Conducted Emissions
DC Power Supply	HP	6632B	US37472178	11-08-30	RF Conducted Emissions
Environment Monitor	Omega	iTHX-SD	0340060	11-10-13	RF Conducted Emissions
Temperature Probe	Control Company	23609-234	21352860	11-09-14	Frequency Stability
Environmental Chamber	Test Equity	107	0900246	N/R	Frequency Stability
Bluetooth Tester	Rohde & Schwarz	CBT	119549	11-12-08	RF Conducted Emissions
Bluetooth Tester	Rohde & Schwarz	CBT35	100368	11-11-27	Radiated Emissions
Bluetooth Tester	Rohde & Schwarz	CBT35	100370	11-11-29	Radiated Emissions
Power Meter	Agilent	N1911A	MY45100951	11-08-12	RF Conducted / Frequency Stability
Power Sensor	Agilent	N1921A	MY45241383	11-09-01	RF Conducted / Frequency Stability
Digital Multimeter	Hewlett Packard	34401A	US36042324	11-10-28	Conducted/Radiated Emissions
Environment Monitor	Omega	iTHX-SD	0380567	11-10-13	Radiated Emissions
Active Loop Antenna	ETS-Lindgren	6507	00126538	12-06-09	Radiated Emissions

	EMI Test Report for the BlackBerry® smartphone Model RDR61CW, RDZ21CW APPENDIX 1	
Test Report No. RTS-2604-1106-132B	Dates of Test May 04 to 05, June 08 to July 07, 2011	FCC ID: L6ARDR60CW IC: 2503A-RDR60CW FCC ID: L6ARDZ20CW IC: 2503A-RDZ20CW

APPENDIX 1 – AC CONDUCTED EMISSIONS TEST DATA/PLOTS

APPENDIX 1
Test Report No.
 RTS-2604-1106-132B

Dates of Test
 May 04 to 05, June 08 to July 07, 2011

FCC ID: L6ARDR60CW **IC:** 2503A-RDR60CW
FCC ID: L6ARDZ20CW **IC:** 2503A-RDZ20CW

AC Conducted Emission Test Results

The following test configurations were measured for model RDR61CW:

The following tests were performed by Savtej Sandhu.

Test Configuration 1

The BlackBerry® smartphone was tested on June 17, 2011.

 The environmental test conditions were: Temperature: 25 °C
 Relative Humidity: 41 %

Frequency (MHz)	Line	Reading (QP) (dBµV)	Correction Factor (dB)	Corrected Reading (QP) (dB)	Limit (QP) (dBµV)	Limit (AVE) (dBµV)	Margin (QP) Limits (dB)
0.150	L1	33.97	11.20	45.17	66.00	56.00	-20.83
0.348	L1	31.33	10.09	41.42	59.00	49.00	-17.58
0.407	N	26.15	10.01	36.16	57.70	47.70	-21.54
0.605	L1	27.45	9.85	37.31	56.00	46.00	-18.70
0.866	N	22.37	9.82	32.18	56.00	46.00	-23.82
0.906	L1	25.17	9.81	34.98	56.00	46.00	-21.02
2.112	N	22.78	9.83	32.61	56.00	46.00	-23.39
2.405	L1	23.98	9.84	33.83	56.00	46.00	-22.17
2.868	N	23.76	9.87	33.63	56.00	46.00	-22.37
3.741	N	28.85	9.90	38.75	56.00	46.00	-17.25
3.795	N	29.19	9.90	39.10	56.00	46.00	-16.91
3.813	L1	28.66	9.90	38.56	56.00	46.00	-17.44
3.845	N	24.82	9.90	34.72	56.00	46.00	-21.28
4.092	N	28.12	9.90	38.02	56.00	46.00	-17.98
4.151	L1	26.22	9.90	36.12	56.00	46.00	-19.88
4.205	L1	25.21	9.90	35.11	56.00	46.00	-20.89
4.254	N	26.96	9.91	36.87	56.00	46.00	-19.13
4.304	N	25.69	9.91	35.60	56.00	46.00	-20.40
4.497	N	23.16	9.91	33.07	56.00	46.00	-22.93
4.547	L1	28.15	9.90	38.06	56.00	46.00	-17.94

APPENDIX 1
Test Report No.
 RTS-2604-1106-132B

Dates of Test
 May 04 to 05, June 08 to July 07, 2011

FCC ID: L6ARDR60CW **IC:** 2503A-RDR60CW
FCC ID: L6ARDZ20CW **IC:** 2503A-RDZ20CW

AC Conducted Emissions Test Results cont'd
Test Configuration 1

Frequency (MHz)	Line	Reading (QP) (dB μ V)	Correction Factor (dB)	Corrected Reading (QP) (dB)	Limit (QP) (dB μ V)	Limit (AVE) (dB μ V)	Margin (QP) Limits (dB)
4.551	N	25.60	9.91	35.51	56.00	46.00	-20.49
4.596	L1	26.07	9.90	35.98	56.00	46.00	-20.02
4.650	L1	27.34	9.90	37.24	56.00	46.00	-18.76
4.659	N	25.67	9.91	35.58	56.00	46.00	-20.42
4.704	L1	29.37	9.90	39.27	56.00	46.00	-16.73
4.808	L1	25.87	9.90	35.77	56.00	46.00	-20.23

All other emission levels had a test margin of greater than 25 dB.

Measurements were done with the quasi-peak detector.

See figure 1-1 and figure 1-2 for the measurement plot of the L1 and N lines of AC power line conducted emissions.

APPENDIX 1
Test Report No.
 RTS-2604-1106-132B

Dates of Test
 May 04 to 05, June 08 to July 07, 2011

FCC ID: L6ARDR60CW **IC:** 2503A-RDR60CW
FCC ID: L6ARDZ20CW **IC:** 2503A-RDZ20CW

AC Conducted Emissions Test Graphs

Test Configuration 1

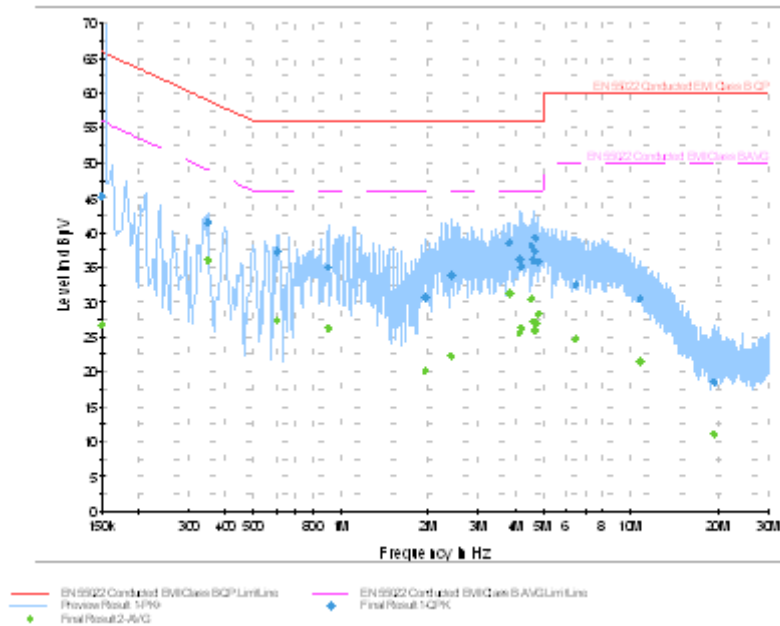
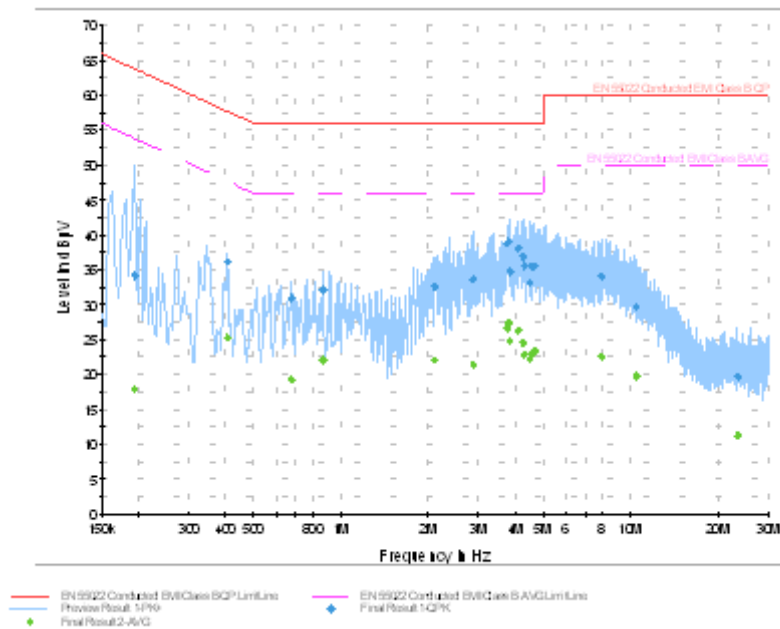
Figure 1-1: L1 lines

Figure 1-2: N Lines

APPENDIX 1
Test Report No.
 RTS-2604-1106-132B

Dates of Test
 May 04 to 05, June 08 to July 07, 2011

FCC ID: L6ARDR60CW **IC:** 2503A-RDR60CW
FCC ID: L6ARDZ20CW **IC:** 2503A-RDZ20CW

AC Conducted Emission Test Results cont'd
Test Configuration 2

The BlackBerry® smartphone was tested on June 17, 2011.

 The environmental test conditions were: Temperature: 25 °C
 Relative Humidity: 41 %

Frequency (MHz)	Line	Reading (QP) (dBµV)	Correction Factor (dB)	Corrected Reading (QP) (dB)	Limit (QP) (dBµV)	Margin (QP) Limits (dB)
0.150	L1	32.80	11.20	44.00	66.00	-22.00
0.164	N	41.60	11.14	52.74	65.30	-12.56
0.177	N	31.75	11.05	42.80	64.60	-21.80
0.182	L1	44.34	10.99	55.33	64.40	-9.07
0.236	L1	39.29	10.61	49.90	62.30	-12.40
0.299	L1	33.32	10.17	43.49	60.30	-16.81
0.704	L1	33.01	9.83	42.84	56.00	-13.16
0.776	L1	31.82	9.82	41.65	56.00	-14.35
0.825	L1	34.09	9.82	43.91	56.00	-12.09
0.897	L1	32.68	9.81	42.49	56.00	-13.51
0.911	N	25.02	9.81	34.83	56.00	-21.17
0.933	L1	29.35	9.81	39.16	56.00	-16.85
1.001	L1	33.19	9.80	43.00	56.00	-13.00
1.851	L1	29.50	9.82	39.32	56.00	-16.68
2.612	L1	29.15	9.86	39.01	56.00	-16.99
3.732	L1	26.18	9.89	36.08	56.00	-19.92

APPENDIX 1
Test Report No.
 RTS-2604-1106-132B

Dates of Test
 May 04 to 05, June 08 to July 07, 2011

FCC ID: L6ARDR60CW **IC:** 2503A-RDR60CW
FCC ID: L6ARDZ20CW **IC:** 2503A-RDZ20CW

AC Conducted Emission Test Results cont'd
Test Configuration 2

Frequency (MHz)	Line	Reading (AVE) (dBµV)	Correction Factor (dB)	Corrected Reading (AVE) (dB)	Limit (AVE) (dBµV)	Margin (AVE) Limits (dB)
0.182	L1	23.76	10.99	34.74	44.40	-19.66
0.236	L1	21.17	10.61	31.78	42.30	-20.53
0.299	L1	19.79	10.17	29.96	40.30	-20.34
0.479	N	13.41	9.93	23.34	36.40	-23.07
0.704	L1	21.66	9.83	31.49	36.00	-14.51
0.776	L1	20.89	9.82	30.71	36.00	-15.29
0.825	L1	21.42	9.82	31.23	36.00	-14.77
0.897	L1	20.14	9.81	29.95	36.00	-16.05
0.911	N	11.57	9.81	21.38	36.00	-24.62
0.933	L1	16.98	9.81	26.79	36.00	-19.21
1.001	L1	18.86	9.80	28.67	36.00	-17.34
1.059	L1	17.87	9.80	27.67	36.00	-18.33
1.851	L1	19.83	9.82	29.65	36.00	-16.35
2.009	N	11.19	9.83	21.02	36.00	-24.98
2.612	L1	19.25	9.86	29.10	36.00	-16.90

All other emission levels had a test margin of greater than 25 dB.
 Measurements were done with the quasi-peak and average detectors.
 See figure 1-3 and figure 1-4 for the measurement plot of the L1 and N lines of AC power line conducted emissions.

Test Report No.
 RTS-2604-1106-132B

Dates of Test
 May 04 to 05, June 08 to July 07, 2011

FCC ID: L6ARDR60CW **IC:** 2503A-RDR60CW
FCC ID: L6ARDZ20CW **IC:** 2503A-RDZ20CW

AC Conducted Emissions Test Graphs

Test Configuration 2

Figure 1-3: L1 lines

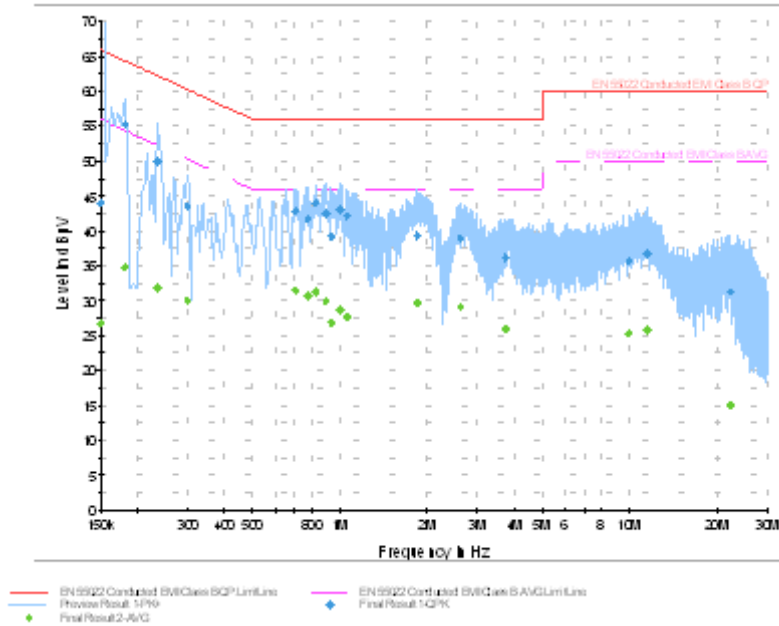
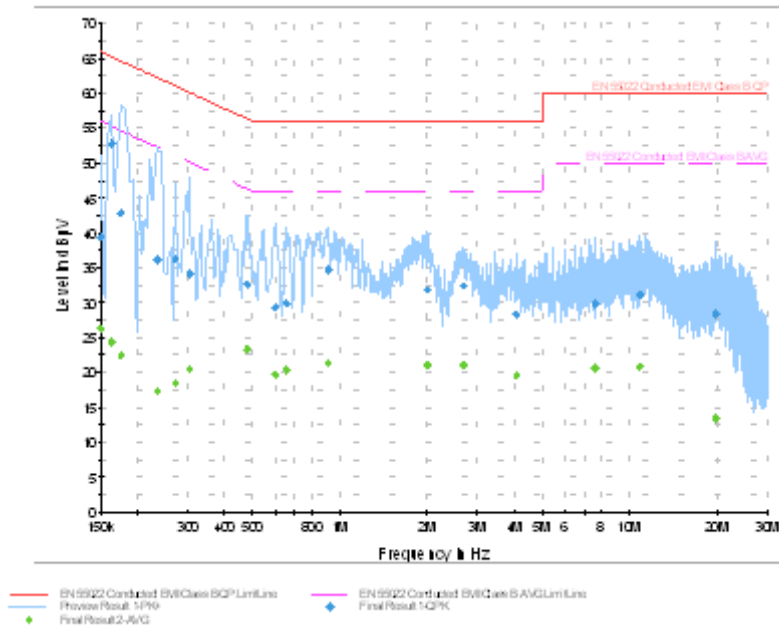



Figure 1-4: N Lines



	EMI Test Report for the BlackBerry® smartphone Model RDR61CW, RDZ21CW APPENDIX 2	
Test Report No. RTS-2604-1106-132B	Dates of Test May 04 to 05, June 08 to July 07, 2011	FCC ID: L6ARDR60CW IC: 2503A-RDR60CW FCC ID: L6ARDZ20CW IC: 2503A-RDZ20CW

APPENDIX 2 – BLUETOOTH AND 802.11b/g/n RADIATED EMISSIONS TEST DATA

	EMI Test Report for the BlackBerry® smartphone Model RDR61CW, RDZ21CW	
	APPENDIX 2	
Test Report No. RTS-2604-1106-132B	Dates of Test May 04 to 05, June 08 to July 07, 2011	FCC ID: L6ARDR60CW IC: 2503A-RDR60CW FCC ID: L6ARDZ20CW IC: 2503A-RDZ20CW

Radiated Emissions Test Results
Bluetooth Band

The following test configurations were measured for model RDR61CW:

Date of Test: June 14, 2011

Measurements were performed by Quan Ma.

The environmental test conditions were: Temperature: 23 °C
Relative Humidity: 30 %

The test distance was 3.0 metres with a EUT height of 0.8 metres, and sweep frequency of 30 MHz to 1 GHz.

The BlackBerry® smartphone in Bluetooth Tx mode was in USB down position.

The frequency sweep measurements were performed in single frequency mode on channels 0, 39 and 78 using packet types “DH5”, “2-DH5” and “3-DH5”.

All emissions had a test margin of greater than 25.0 dB.

Date of Test: May 04 and 05, 2011

Measurements were performed by Adam Rusinek.

The environmental test conditions were: Temperature: 25 °C
Relative Humidity: 40 %

The test distance was 3.0 metres with a EUT height of 0.8 metres, and sweep frequency of 1GHz to 25GHz.

The BlackBerry® smartphone in Bluetooth Tx mode was in USB down position.

The frequency sweep measurements were performed in single frequency mode on channels 0, 39 and 78 using packet types “DH5”, “2-DH5” and “3-DH5”.

All other emissions had a test margin of greater than 25.0 dB.

**APPENDIX 2****Test Report No.**
RTS-2604-1106-132B**Dates of Test**
May 04 to 05, June 08 to July 07, 2011**FCC ID:** L6ARDR60CW **IC:** 2503A-RDR60CW
FCC ID: L6ARDZ20CW **IC:** 2503A-RDZ20CWBand-Edge Compliance of RF Radiated Emissions Test Results
Bluetooth Band

Date of test: June 08, 2011

Measurements were performed by Quan Ma.

The environmental test conditions were: Temperature: 24 ° C
Relative Humidity: 40 %The BlackBerry® smartphone was in standalone, vertical position and pattern type “Static PBRs” in “DH5”, “2-DH5” and “3-DH5” modulation during the measurements.

The test distance was 3.0 metres.

Channel	Freq. (MHz)	Rx Antenna Type	POL.	Detector (PK, AVE.)	VBW (MHz)	Corrected Reading (dBuV/m)	Delta Marker (dB)	Corrected Band edge (dBuV/m)	Limit (dBuV/m)	Diff. To Limit (dB)
Low Channel, Packet Type DH5										
0	2402	Horn	V	PK	1 MHz	96.78	42.40	54.38	74.00	-19.62
0	2402	Horn	H	PK	1 MHz	101.50	42.99	58.51	74.00	-15.49
0	2402	Horn	V	AVE.	10 Hz	64.41	42.40	22.01	54.00	-31.99
0	2402	Horn	H	AVE.	10 Hz	67.58	42.99	24.59	54.00	-29.41
High Channel, Packet Type DH5										
78	2480	Horn	V	PK	1 MHz	91.66	50.45	41.21	74.00	-32.79
78	2480	Horn	H	PK	1 MHz	97.24	50.04	47.20	74.00	-26.80
78	2480	Horn	V	AVE.	10 Hz	61.90	50.45	11.45	54.00	-42.55
78	2480	Horn	H	AVE.	10 Hz	65.59	50.04	15.55	54.00	-38.45
Low Channel, Packet Type 2-DH5										
0	2402	Horn	V	PK	1 MHz	96.11	41.55	54.56	74.00	-19.44
0	2402	Horn	H	PK	1 MHz	100.90	42.73	58.17	74.00	-15.83
0	2402	Horn	V	AVE.	10 Hz	64.03	41.55	22.48	54.00	-31.52
0	2402	Horn	H	AVE.	10 Hz	58.52	42.73	15.79	54.00	-38.21
High Channel, Packet Type 2-DH5										
78	2480	Horn	V	PK	1 MHz	92.63	49.65	42.98	74.00	-31.02
78	2480	Horn	H	PK	1 MHz	94.89	50.40	44.49	74.00	-29.51
78	2480	Horn	V	AVE.	10 Hz	62.23	49.65	12.58	54.00	-41.42
78	2480	Horn	H	AVE.	10 Hz	63.38	50.40	12.98	54.00	-41.02

**APPENDIX 2****Test Report No.**
RTS-2604-1106-132B**Dates of Test**
May 04 to 05, June 08 to July 07, 2011**FCC ID:** L6ARDR60CW **IC:** 2503A-RDR60CW
FCC ID: L6ARDZ20CW **IC:** 2503A-RDZ20CWBand-Edge Compliance of RF Radiated Emissions Test Results cont'd
Bluetooth Band

Channel	Freq. (MHz)	Rx Antenna		Detector (PK, AVE.)	VBW (MHz)	Corrected Reading (dBuV/m)	Delta Marker (dB)	Corrected Band edge (dBuV/m)	Limit (dBuV/m)	Diff. To Limit (dB)
		Type	POL.							
Low Channel, Packet Type 3-DH5										
0	2402	Horn	V	PK	1 MHz	96.15	41.94	54.21	74.00	-19.79
0	2402	Horn	H	PK	1 MHz	100.66	42.89	57.77	74.00	-16.23
0	2402	Horn	V	AVE.	10 Hz	62.89	41.94	20.95	54.00	-33.05
0	2402	Horn	H	AVE.	10 Hz	64.41	42.89	21.52	54.00	-32.48
High Channel, Packet Type 3-DH5										
78	2480	Horn	V	PK	1 MHz	90.86	50.52	40.34	74.00	-33.66
78	2480	Horn	H	PK	1 MHz	96.41	50.12	46.29	74.00	-27.71
78	2480	Horn	V	AVE.	10 Hz	60.23	50.52	9.71	54.00	-44.29
78	2480	Horn	H	AVE.	10 Hz	63.16	50.12	13.04	54.00	-40.96

See figures 2-1 to 2-12 for the plots of the Bluetooth band-edge compliance.

Test Report No.
 RTS-2604-1106-132B

Dates of Test
 May 04 to 05, June 08 to July 07, 2011

FCC ID: L6ARDR60CW IC: 2503A-RDR60CW
FCC ID: L6ARDZ20CW IC: 2503A-RDZ20CW

Bluetooth Band-Edge Compliance of RF Radiated Emissions cont'd

Figure 2-1: Band-Edge Compliance of RF Rad. Emissions.
 Bluetooth, Single freq., Static PBRS,
 DH5, Channel 0, Pol: V, Detector: PK

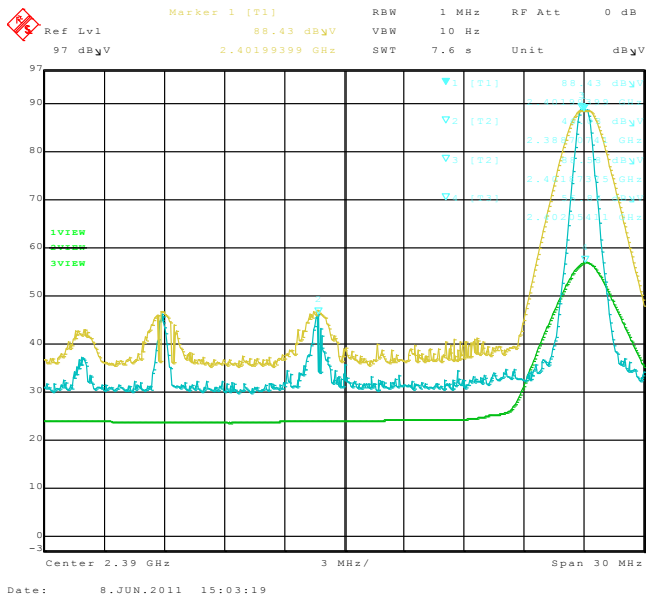

Figure 2-2: Band-Edge Compliance of RF Rad. Emissions.
 Bluetooth, Single freq., Static PBRS,
 DH5, Channel 0, Pol: H, Detector: PK

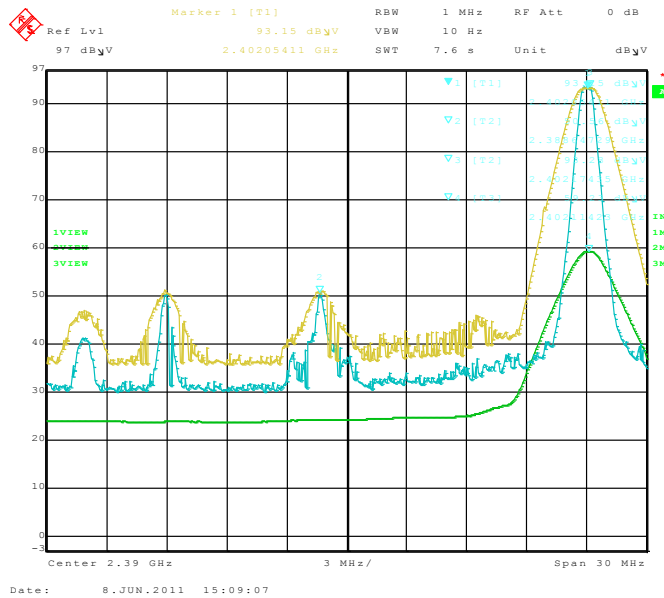

Figure 2-3: Band-Edge Compliance of RF Rad. Emissions.
 Bluetooth, Single freq., Static PBRS,
 DH5, Channel 78, Pol: V, Detector: PK

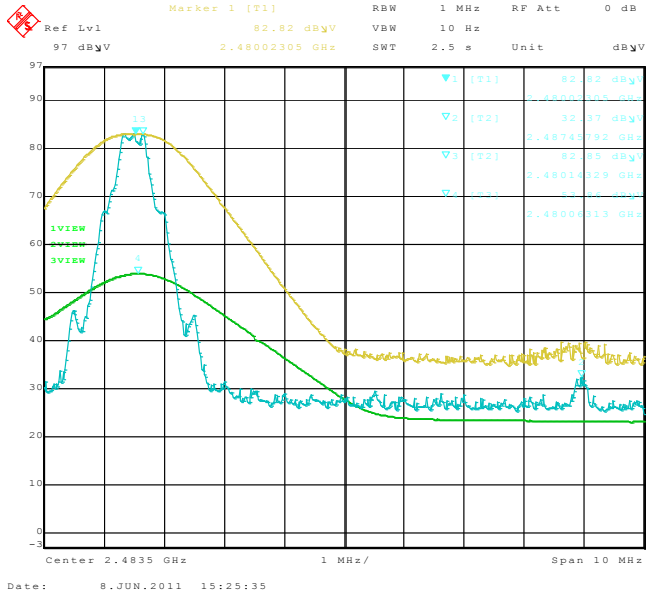
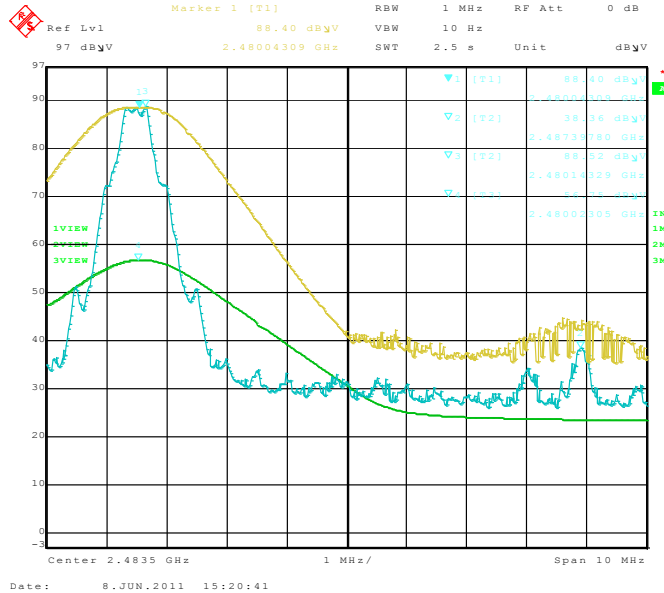

Figure 2-4: Band-Edge Compliance of RF Rad. Emissions.
 Bluetooth, Single freq., Static PBRS,
 DH5, Channel 78, Pol: H, Detector: PK



Test Report No.
 RTS-2604-1106-132B

Dates of Test
 May 04 to 05, June 08 to July 07, 2011

FCC ID: L6ARDR60CW IC: 2503A-RDR60CW
FCC ID: L6ARDZ20CW IC: 2503A-RDZ20CW

Bluetooth Band-Edge Compliance of RF Radiated Emissions cont'd

Figure 2-5: Band-Edge Compliance of RF Rad. Emissions.
 Bluetooth, Single freq., Static PBRS,
 2-DH5, Channel 0, Pol: V, Detector: PK

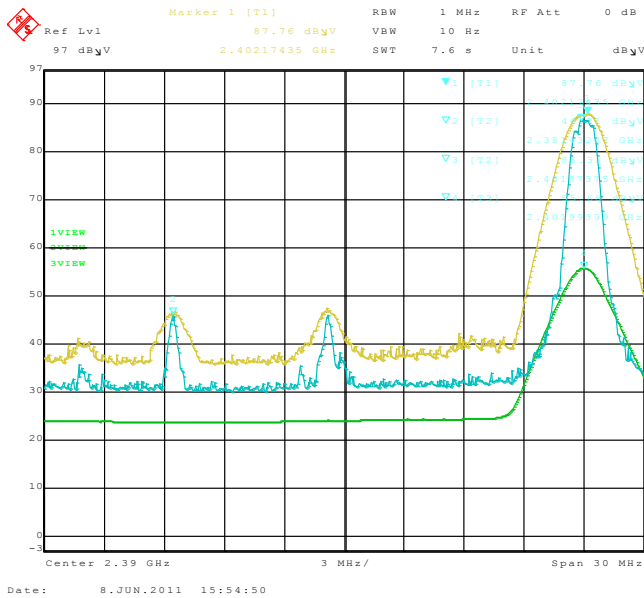

Figure 2-6: Band-Edge Compliance of RF Rad. Emissions.
 Bluetooth, Single freq., Static PBRS,
 2-DH5, Channel 0, Pol: H, Detector: PK

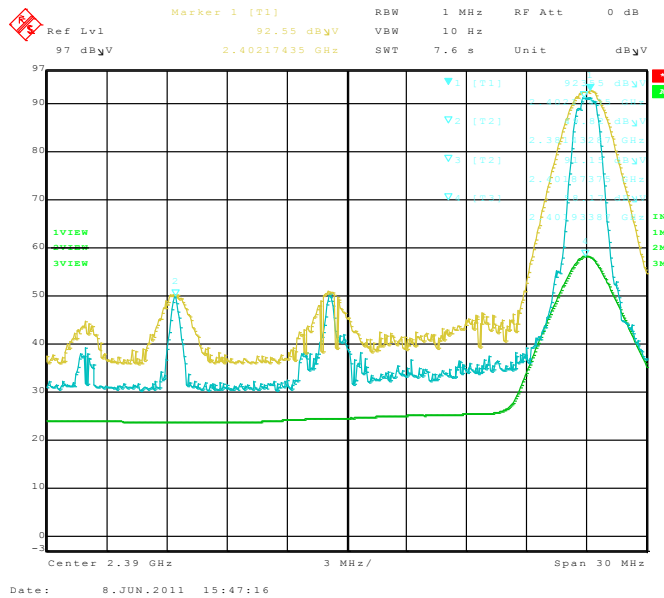

Figure 2-7: Band-Edge Compliance of RF Rad. Emissions.
 Bluetooth, Single freq., Static PBRS,
 2-DH5, Channel 78, Pol: V, Detector: PK

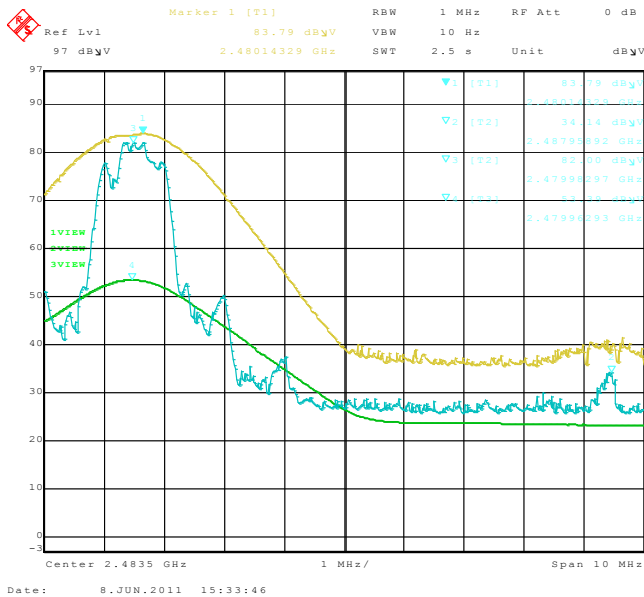
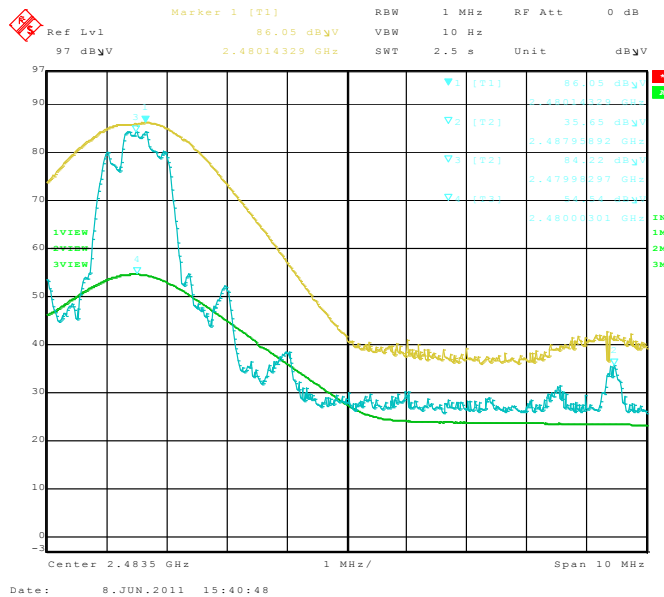

Figure 2-8: Band-Edge Compliance of RF Rad. Emissions.
 Bluetooth, Single freq., Static PBRS,
 2-DH5, Channel 78, Pol: H, Detector: PK



Test Report No.
 RTS-2604-1106-132B

Dates of Test
 May 04 to 05, June 08 to July 07, 2011

FCC ID: L6ARDR60CW IC: 2503A-RDR60CW
FCC ID: L6ARDZ20CW IC: 2503A-RDZ20CW

Bluetooth Band-Edge Compliance of RF Radiated Emissions cont'd

Figure 2-9: Band-Edge Compliance of RF Rad. Emissions.
 Bluetooth, Single freq., Static PBRS,
 3-DH5, Channel 0, Pol: V, Detector: PK

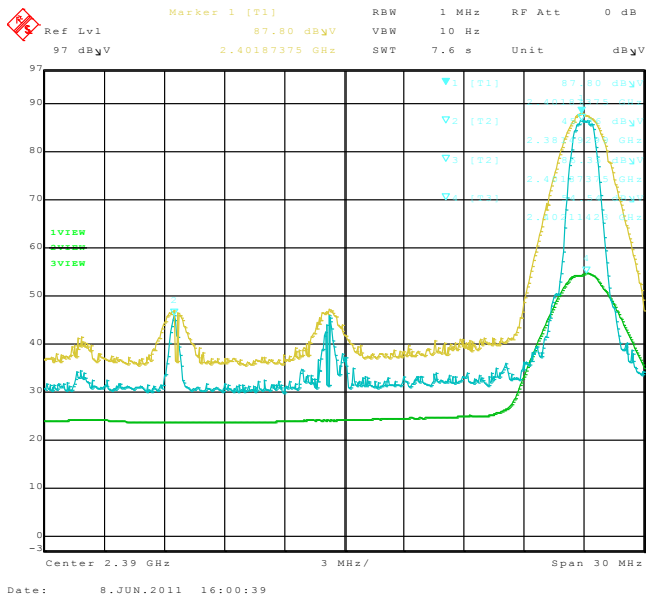

Figure 2-10: Band-Edge Compliance of RF Rad. Emissions.
 Bluetooth, Single freq., Static PBRS,
 3-DH5, Channel 0, Pol: H, Detector: PK

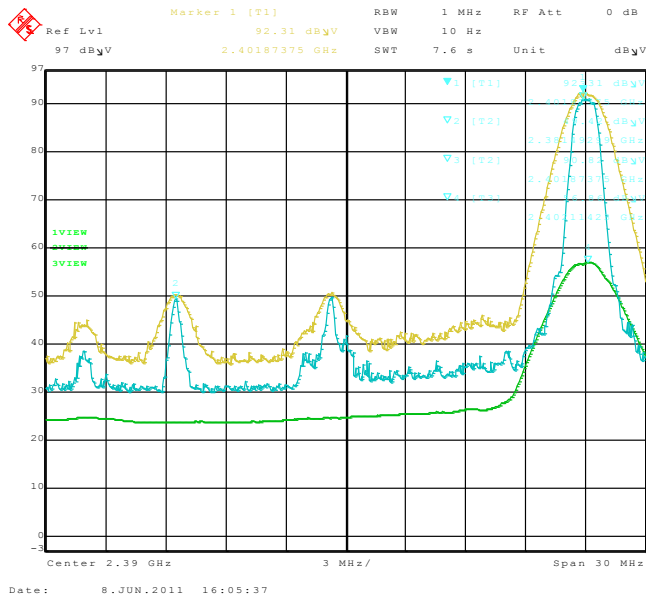

Figure 2-11: Band-Edge Compliance of RF Rad. Emissions.
 Bluetooth, Single freq., Static PBRS,
 3-DH5, Channel 78, Pol: V, Detector: PK

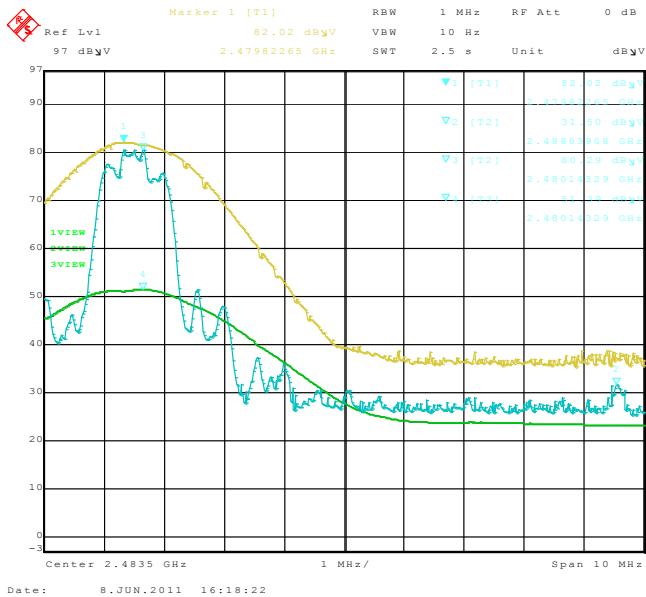
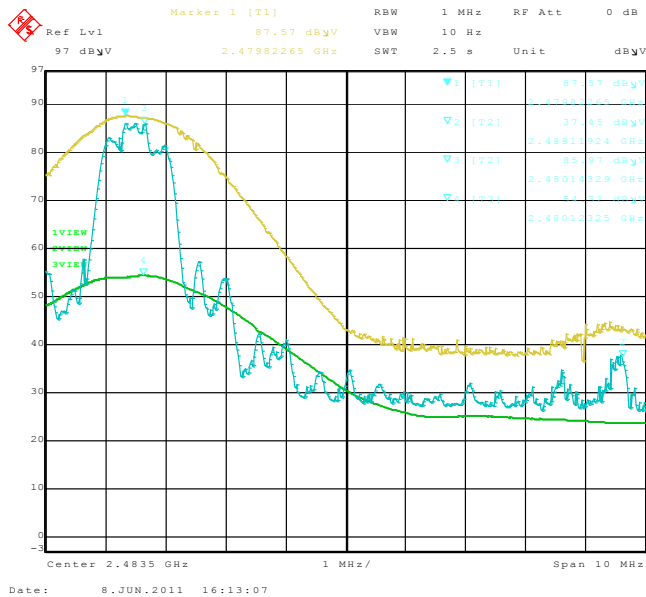



Figure 2-12: Band-Edge Compliance of RF Rad. Emissions.
 Bluetooth, Single freq., Static PBRS,
 3-DH5, Channel 78, Pol: H, Detector: PK



	EMI Test Report for the BlackBerry® smartphone Model RDR61CW, RDZ21CW	
	APPENDIX 2	
Test Report No. RTS-2604-1106-132B	Dates of Test May 04 to 05, June 08 to July 07, 2011	FCC ID: L6ARDR60CW IC: 2503A-RDR60CW FCC ID: L6ARDZ20CW IC: 2503A-RDZ20CW

Radiated Emissions Test Results cont'd
802.11b/g/n Band

Date of Test: June 15, 2011

Measurements were performed by Quan Ma.

The environmental test conditions were: Temperature: 25 °C
Relative Humidity: 30 %

The test distance was 3.0 metres with a EUT height of 0.8 metres, and sweep frequency of 30 MHz to 1 GHz.

The BlackBerry® smartphone was in USB up position.

The frequency sweep measurements were performed in 802.11b Tx mode at 1 Mbps on channels 1, 6 and 11, in 802.11g Tx mode at 6 Mbps on channel 1, 6 and 11, and in 802.11n Tx mode at MCS 0 on channels 1, 6 and 11.

All emissions had a test margin of greater than 25.0 dB.

Date of Test: June 15 and 22, 2011

Measurements were performed by Shuo Wang.

The environmental test conditions were: Temperature: 25 °C
Relative Humidity: 41 %

The test distance was 3.0 metres with a EUT height of 0.8 metres, and sweep frequency of 1GHz to 25GHz.

The BlackBerry® smartphone was in USB up position.

The frequency sweep measurements were performed in 802.11b Tx mode at 1 Mbps on channels 1, 6 and 11, in 802.11g Tx mode at 6 Mbps on channel 1, 6 and 11, and in 802.11n Tx mode at MCS 0 on channels 1, 6 and 11.

All emissions had a test margin of greater than 25.0 dB.

APPENDIX 2

Test Report No. RTS-2604-1106-132B	Dates of Test May 04 to 05, June 08 to July 07, 2011	FCC ID: L6ARDR60CW IC: 2503A-RDR60CW FCC ID: L6ARDZ20CW IC: 2503A-RDZ20CW
--	--	--

802.11b/g/n Band-Edge Compliance of RF Radiated Emissions

Date of Tests: June 08, 2011

Measurements performed by Quan Ma.

The environmental test conditions were: Temperature: 24 °C
Relative Humidity: 40 %

802.11b Band

The measurements were performed on BlackBerry® smartphone in standalone, vertical configuration on channels 1 and 11 for 802.11b mode at 1 Mbps.

The test distance was 3 metres.

Channel	Freq. (MHz)	Rx Antenna		Detector (MHz)	VBW For Peak (dBuV/m)	Peak Corrected Reading (dBuV/m)	Delta Marker (dB)	Corrected Band edge (dBuV/m)	Limit (dBuV/m)	Diff. To Limit (dB)
		Type	POL.							
1	2412.00	Horn	V	PK	1 MHz	102.39	49.42	52.97	74.00	-21.03
1	2412.00	Horn	H	PK	1 MHz	107.32	50.80	56.52	74.00	-17.48
1	2412.00	Horn	V	AV	10 Hz	94.36	49.42	44.94	54.00	-9.06
1	2412.00	Horn	H	AV	10 Hz	99.17	50.80	48.37	54.00	-5.63

Channel	Freq. (MHz)	Rx Antenna		Detector (MHz)	VBW For Peak (dBuV/m)	Peak Corrected Reading (dBuV/m)	Delta Marker (dB)	Corrected Band edge (dBuV/m)	Limit (dBuV/m)	Diff. To Limit (dB)
		Type	POL.							
11	2480.00	Horn	V	PK	1 MHz	100.39	50.82	49.57	74.00	-24.43
11	2480.00	Horn	H	PK	1 MHz	105.37	53.17	52.20	74.00	-21.80
11	2480.00	Horn	V	AV	10 Hz	92.76	50.82	41.94	54.00	-12.06
11	2480.00	Horn	H	AV	10 Hz	97.59	53.17	44.42	54.00	-9.58

**APPENDIX 2****Test Report No.**
RTS-2604-1106-132B**Dates of Test**
May 04 to 05, June 08 to July 07, 2011**FCC ID:** L6ARDR60CW **IC:** 2503A-RDR60CW
FCC ID: L6ARDZ20CW **IC:** 2503A-RDZ20CW802.11g Band

The measurements were performed on the BlackBerry® smartphone in standalone, vertical configuration on channels 1 and 11 for 802.11g mode at 6 Mbps.

The test distance was 3 metres.

Channel	Freq. (MHz)	Rx Antenna		Detector (MHz)	VBW For Peak (dBuV/m)	Peak Corrected Reading (dBuV/m)	Delta Marker (dB)	Corrected Band edge (dBuV/m)	Limit (dBuV/m)	Diff. To Limit (dB)
		Type	POL.							
1	2412.00	Horn	V	PK	1 MHz	106.68	42.6	64.08	74.00	-9.92
1	2412.00	Horn	H	PK	1 MHz	112.32	43.84	68.48	74.00	-5.52
1	2412.00	Horn	V	AV	10 Hz	77.99	42.6	35.39	54.00	-18.61
1	2412.00	Horn	H	AV	10 Hz	81.37	43.84	37.53	54.00	-16.47

Channel	Freq. (MHz)	Rx Antenna		Detector (MHz)	VBW For Peak (dBuV/m)	Peak Corrected Reading (dBuV/m)	Delta Marker (dB)	Corrected Band edge (dBuV/m)	Limit (dBuV/m)	Diff. To Limit (dB)
		Type	POL.							
11	2480.00	Horn	V	PK	1 MHz	107.03	44.97	62.06	74.00	-11.94
11	2480.00	Horn	H	PK	1 MHz	109.59	45.61	63.98	74.00	-10.02
11	2480.00	Horn	V	AV	10 Hz	78.06	44.97	33.09	54.00	-20.91
11	2480.00	Horn	H	AV	10 Hz	80.22	45.61	34.61	54.00	-19.39

	EMI Test Report for the BlackBerry® smartphone Model RDR61CW, RDZ21CW	
	APPENDIX 2	
Test Report No. RTS-2604-1106-132B	Dates of Test May 04 to 05, June 08 to July 07, 2011	FCC ID: L6ARDR60CW IC: 2503A-RDR60CW FCC ID: L6ARDZ20CW IC: 2503A-RDZ20CW

802.11n Band

The measurements were performed on the BlackBerry® smartphone in standalone, vertical configuration on channels 1 and 11 for 802.11n mode at MCS 0.

The test distance was 3 metres.

Channel	Freq. (MHz)	Rx Antenna		Detector (MHz)	VBW For Peak (dBuV/m)	Peak Corrected Reading (dBuV/m)	Delta Marker (dB)	Corrected Band edge (dBuV/m)	Limit (dBuV/m)	Diff. To Limit (dB)
		Type	POL.							
1	2412.00	Horn	V	PK	1 MHz	106.82	42.65	64.17	74.00	-9.83
1	2412.00	Horn	H	PK	1 MHz	112.57	43.62	68.95	74.00	-5.05
1	2412.00	Horn	V	AV	10 Hz	76.87	42.65	34.22	54.00	-19.78
1	2412.00	Horn	H	AV	10 Hz	80.80	43.62	37.18	54.00	-16.82

Channel	Freq. (MHz)	Rx Antenna		Detector (MHz)	VBW For Peak (dBuV/m)	Peak Corrected Reading (dBuV/m)	Delta Marker (dB)	Corrected Band edge (dBuV/m)	Limit (dBuV/m)	Diff. To Limit (dB)
		Type	POL.							
11	2480.00	Horn	V	PK	1 MHz	106.96	42.64	64.32	74.00	-9.68
11	2480.00	Horn	H	PK	1 MHz	109.82	43.41	66.41	74.00	-7.59
11	2480.00	Horn	V	AV	10 Hz	77.77	42.64	35.13	54.00	-18.87
11	2480.00	Horn	H	AV	10 Hz	79.84	43.41	36.43	54.00	-17.57

See figures 2-13 to 2-16 for the plots of the 802.11b band-edge compliance.
 See figures 2-17 to 2-20 for the plots of the 802.11g band-edge compliance.
 See figures 2-21 to 2-24 for the plots of the 802.11n band-edge compliance.

Test Report No.
 RTS-2604-1106-132B

Dates of Test
 May 04 to 05, June 08 to July 07, 2011

FCC ID: L6ARDR60CW **IC:** 2503A-RDR60CW
FCC ID: L6ARDZ20CW **IC:** 2503A-RDZ20CW

802.11b/g/n Band-Edge Compliance of RF Radiated Emissions cont'd

Figure 2-13: Band-Edge Compliance of RF Radiated Emission 802.11b, Channel 1, 2412 MHz, Max Pol: V, Detector: PK

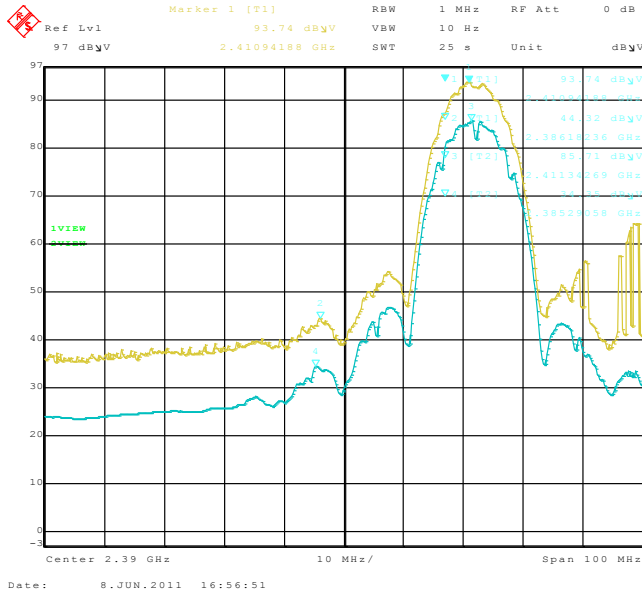

Figure 2-14: Band-Edge Compliance of RF Radiated Emission 802.11b, Channel 1, 2412 MHz, Max Pol: H, Detector: PK

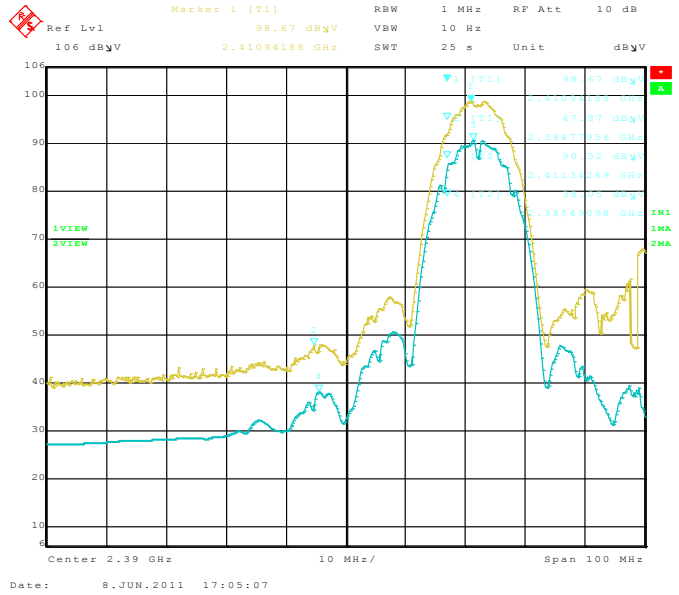

Figure 2-15: Band-Edge Compliance of RF Radiated Emission 802.11b, Channel 11, 2462 MHz, Max Pol: V, Detector: PK

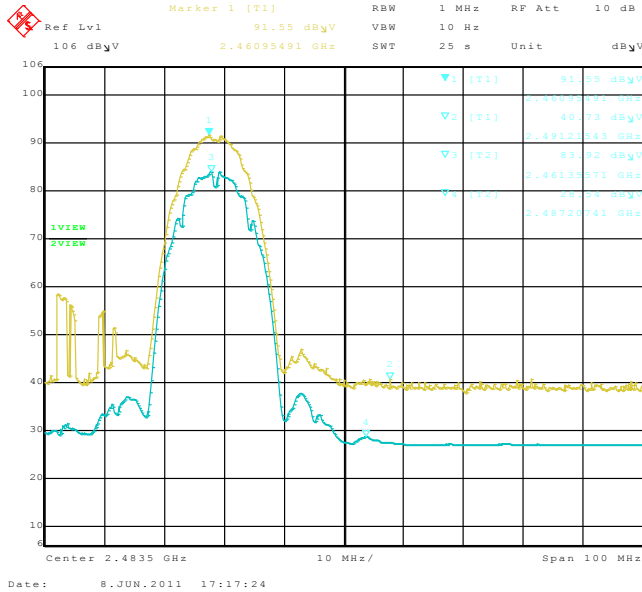
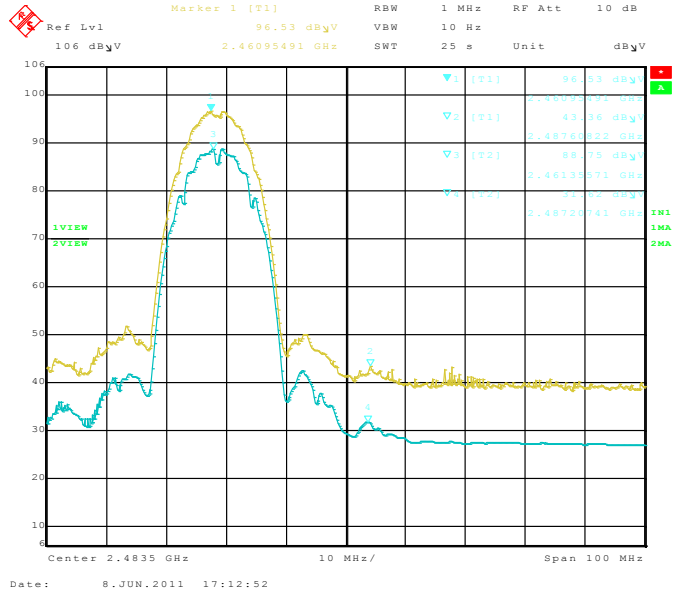

Figure 2-16: Band-Edge Compliance of RF Radiated Emission 802.11b, Channel 11, 2462 MHz, Max Pol: H, Detector: PK



Test Report No.
 RTS-2604-1106-132B

Dates of Test
 May 04 to 05, June 08 to July 07, 2011

FCC ID: L6ARDR60CW IC: 2503A-RDR60CW
FCC ID: L6ARDZ20CW IC: 2503A-RDZ20CW

Figure 2-17: Band-Edge Compliance of RF Radiated Emission
 802.11g, Channel 1, 2412 MHz, Max Pol: V,
 Detector: PK

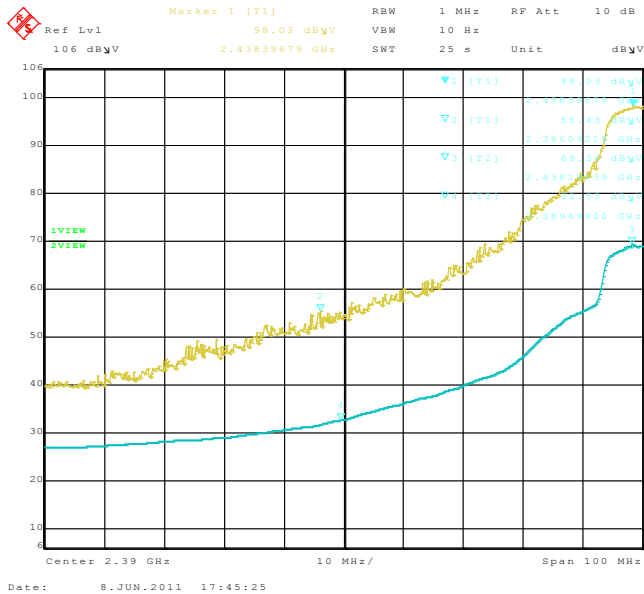

Figure 2-18: Band-Edge Compliance of RF Radiated Emission
 802.11g, Channel 1, 2412 MHz, Max Pol: H,
 Detector: PK

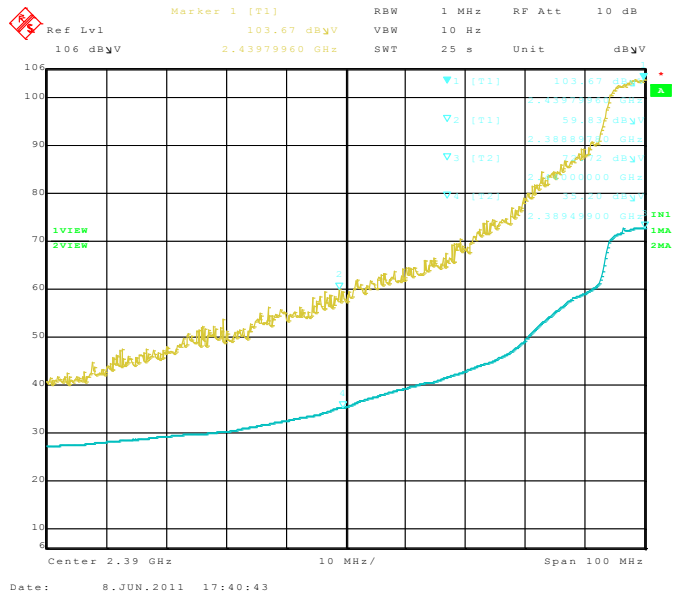

Figure 2-19: Band-Edge Compliance of RF Radiated Emission
 802.11g, Channel 11, 2462 MHz, Max Pol: V,
 Detector: PK

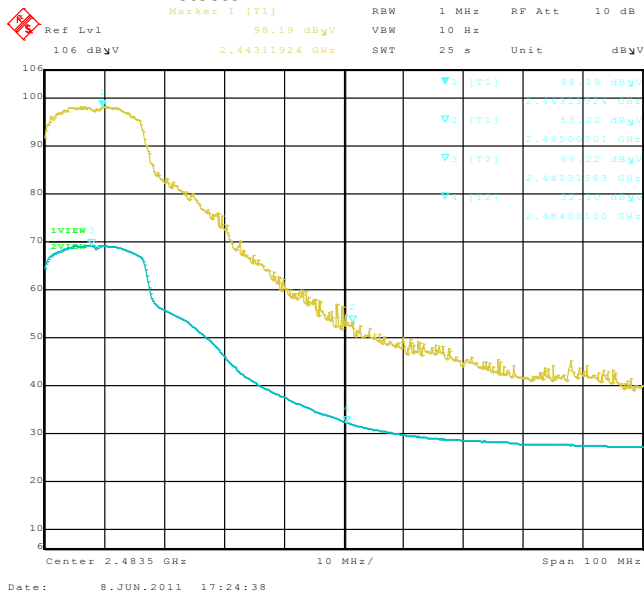
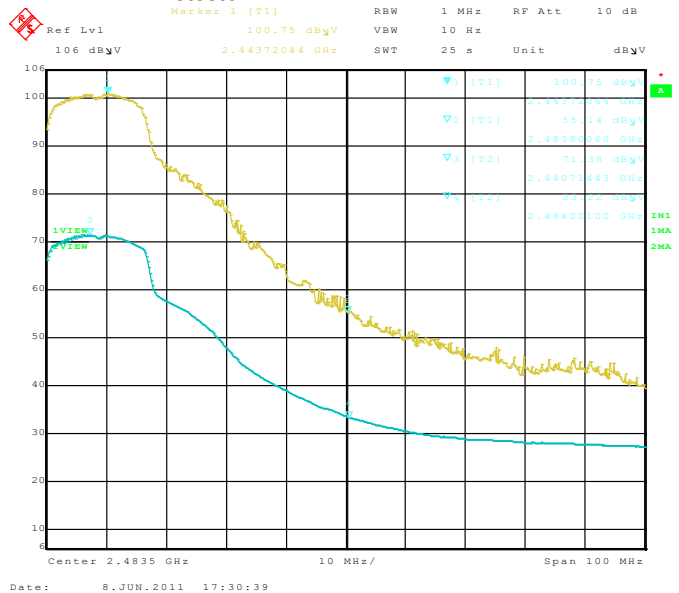

Figure 2-20: Band-Edge Compliance of RF Radiated Emission
 802.11g, Channel 11, 2462 MHz, Max Pol: H,
 Detector: PK



Test Report No.
 RTS-2604-1106-132B

Dates of Test
 May 04 to 05, June 08 to July 07, 2011

FCC ID: L6ARDR60CW IC: 2503A-RDR60CW
FCC ID: L6ARDZ20CW IC: 2503A-RDZ20CW

Figure 2-21: Band-Edge Compliance of RF Radiated Emission
 802.11n, Channel 1, 2412 MHz, Max Pol: V,
 Detector: PK

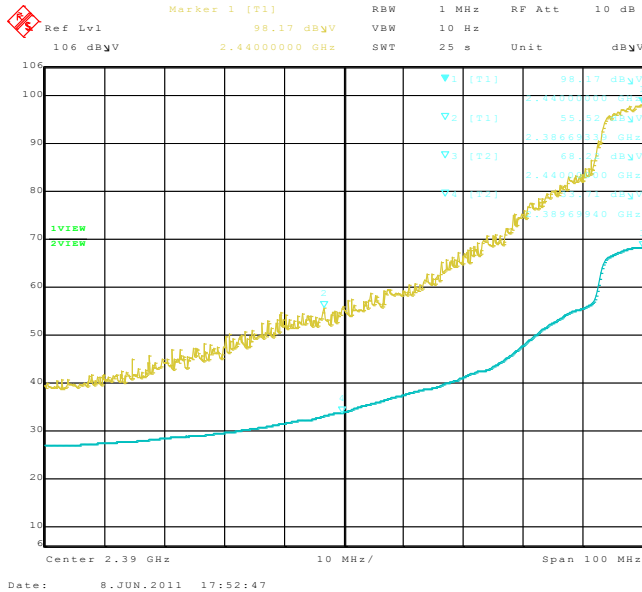

Figure 2-22: Band-Edge Compliance of RF Radiated Emission
 802.11n, Channel 1, 2412 MHz, Max Pol: H,
 Detector: PK

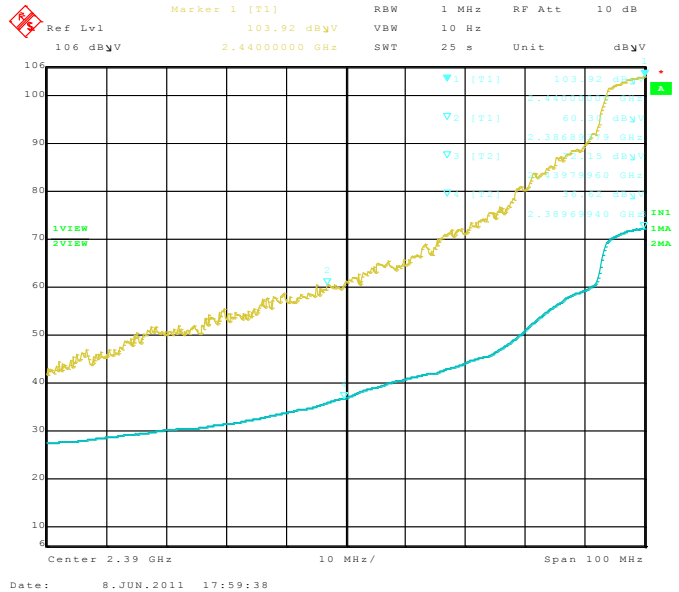

Figure 2-23: Band-Edge Compliance of RF Radiated Emission
 802.11n, Channel 11, 2462 MHz, Max Pol: V,
 Detector: PK

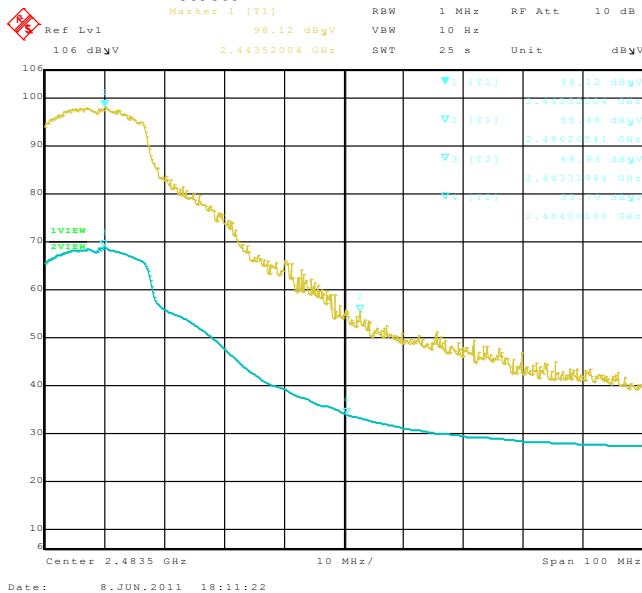
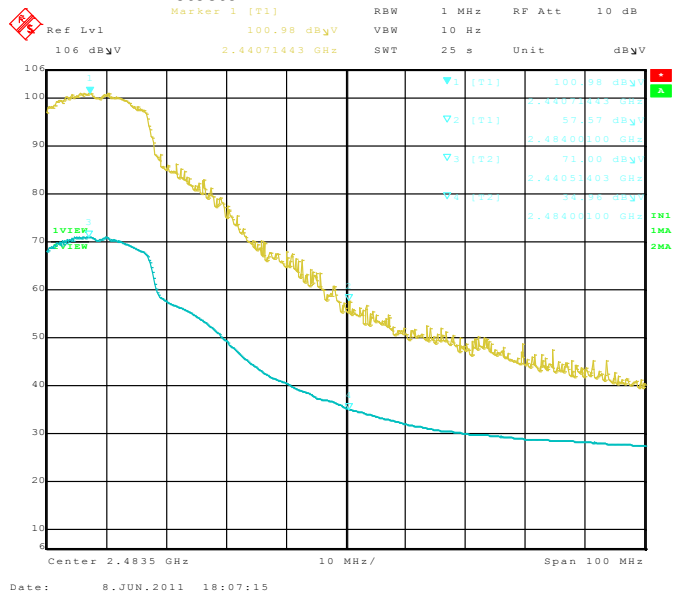



Figure 2-24: Band-Edge Compliance of RF Radiated Emission
 802.11n, Channel 11, 2462 MHz, Max Pol: H,
 Detector: PK



	EMI Test Report for the BlackBerry® smartphone Model RDR61CW, RDZ21CW APPENDIX 3	
Test Report No. RTS-2604-1106-132B	Dates of Test May 04 to 05, June 08 to July 07, 2011	FCC ID: L6ARDR60CW IC: 2503A-RDR60CW FCC ID: L6ARDZ20CW IC: 2503A-RDZ20CW

APPENDIX 3 – BLUETOOTH CONDUCTED EMISSIONS TEST DATA/PLOTS

	EMI Test Report for the BlackBerry® smartphone Model RDR61CW, RDZ21CW	
	APPENDIX 3	
Test Report No. RTS-2604-1106-132B	Dates of Test May 04 to 05, June 08 to July 07, 2011	FCC ID: L6ARDR60CW IC: 2503A-RDR60CW FCC ID: L6ARDZ20CW IC: 2503A-RDZ20CW

Bluetooth RF Conducted Emission Test Results

The following test configurations were measured for model RDR61CW:

Bluetooth power output from BlackBerry® smartphone was at maximum for all the recorded measurements shown below.

The measurements were performed by Maurice Battler.

Date of test: June 22, 2011

Test Setup Diagram

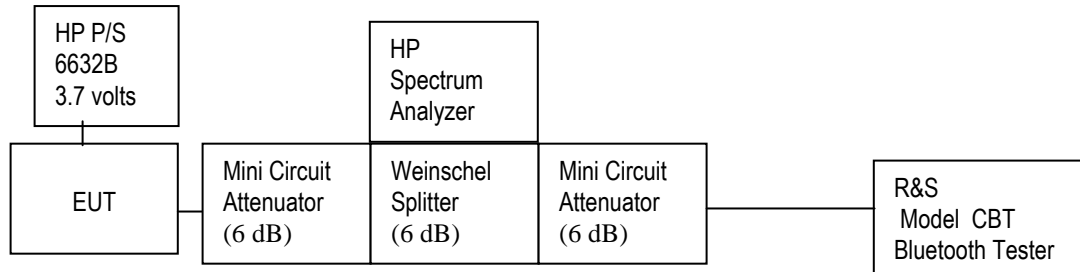

A reference offset of 12.4 dB was applied to the spectrum analyzer reference level for the attenuators and coaxial cable loss in the test circuit.

The environmental test conditions were: Temperature: 24 °C
Relative Humidity: 25 %

	EMI Test Report for the BlackBerry® smartphone Model RDR61CW, RDZ21CW APPENDIX 3	
	Test Report No. RTS-2604-1106-132B	Dates of Test May 04 to 05, June 08 to July 07, 2011

Bluetooth RF Conducted Emission Test Results cont'd

20 dB Bandwidth

The EUT met the requirements of the 20 dB bandwidth as per 47 CFR 15.247(a) and RSS-210. Low channel (0), middle channel (39) and high channel (78) were measured. Bluetooth was operating in single frequency mode.

Using pattern type "Static PBRs" and packet type "DH5" during the measurements.

Bluetooth Channel	Limit (MHz)	Measured Level (MHz)
0	≤1.0	0.923
39	≤1.0	0.927
78	≤1.0	0.920

See figures 3-1 to 3-3 for the plots of the 20 dB bandwidth measurements.

Figure 3-1: 20 dB Bandwidth

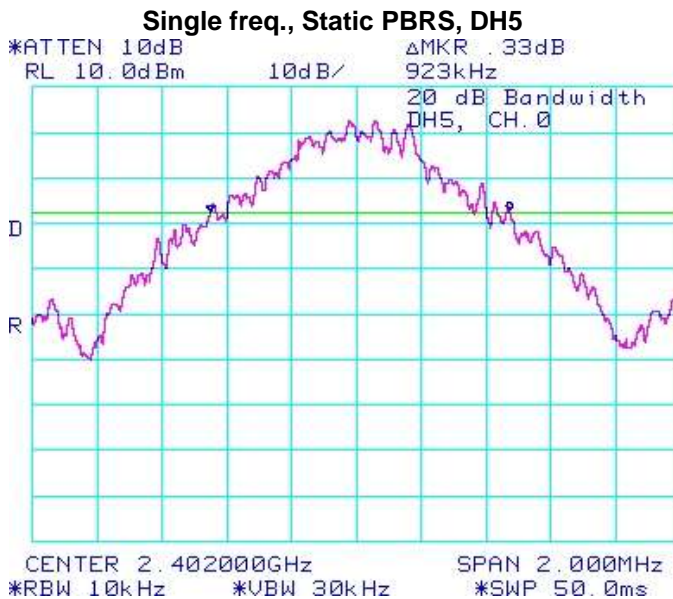
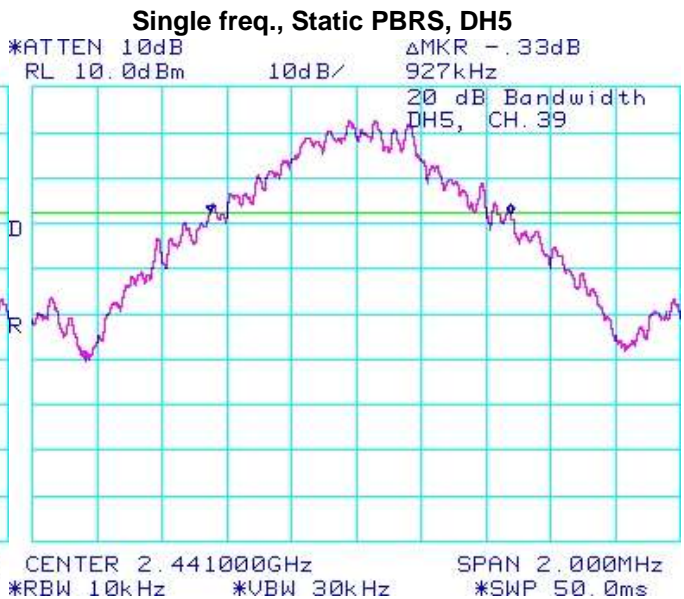

Figure 3-2: 20 dB Bandwidth



Test Report No. RTS-2604-1106-132B	Dates of Test May 04 to 05, June 08 to July 07, 2011	FCC ID: L6ARDR60CW IC: 2503A-RDR60CW FCC ID: L6ARDZ20CW IC: 2503A-RDZ20CW
--	--	--

Bluetooth RF Conducted Emission Test Results cont'd

Figure 3-3: 20 dB Bandwidth

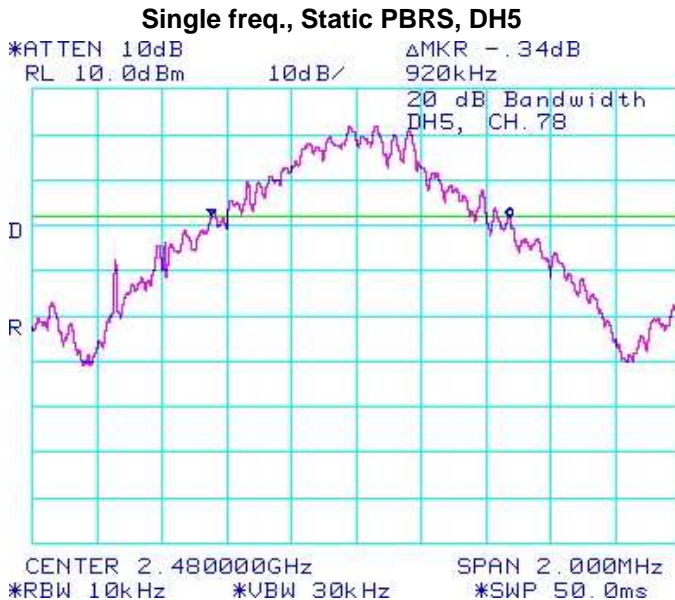

Using Pattern type “Static PBRS” and packet type “3-DH5” during the measurements.

Bluetooth Channel	Limit (MHz)	Measured Level (MHz)
0	≤1.5	1.310
39	≤1.5	1.307
78	≤1.5	1.313

See figures 3-4 to 3-6 for the plots of the 20 dB bandwidth measurements.

Test Report No.
 RTS-2604-1106-132B

Dates of Test
 May 04 to 05, June 08 to July 07, 2011

FCC ID: L6ARDR60CW **IC:** 2503A-RDR60CW
FCC ID: L6ARDZ20CW **IC:** 2503A-RDZ20CW

Bluetooth RF Conducted Emission Test Results cont'd

Figure 3-4: 20 dB Bandwidth

Single freq., Static PBRs, 3-DH5

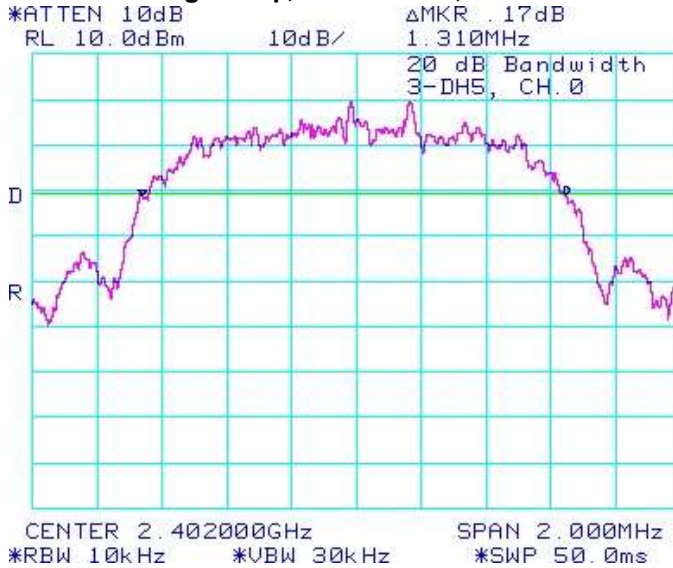

Figure 3-5: 20 dB Bandwidth

Single freq., Static PBRs, 3-DH5

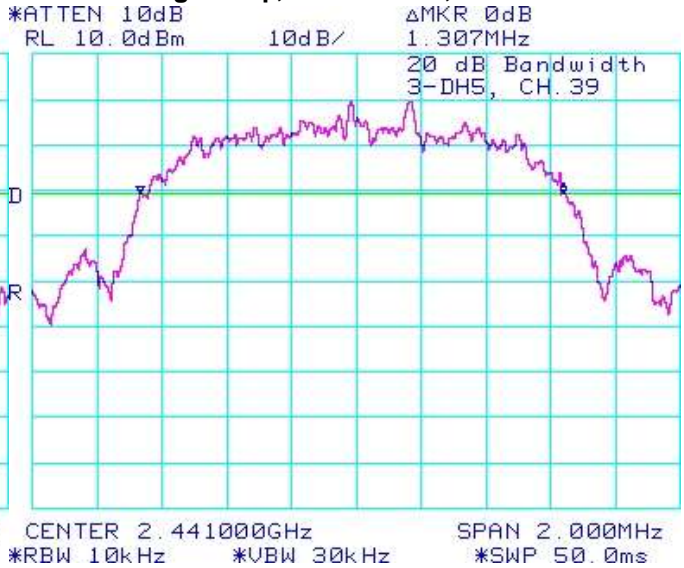
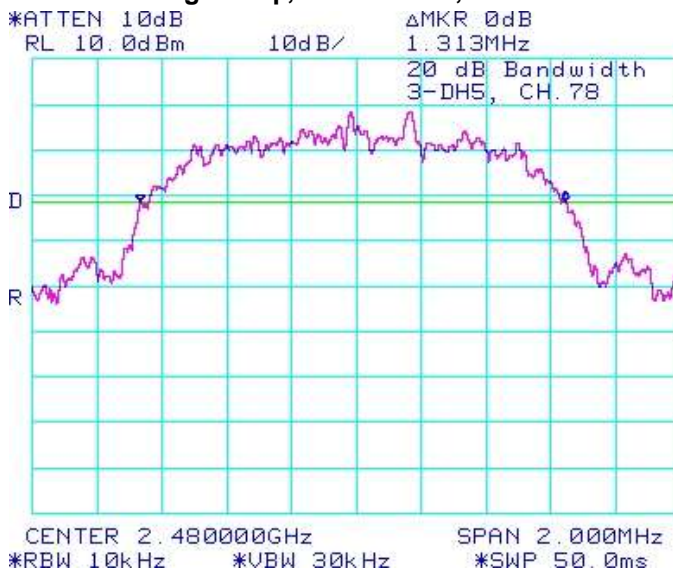



Figure 3-6: 20 dB Bandwidth

Single freq., Static PBRs, 3-DH5



	EMI Test Report for the BlackBerry® smartphone Model RDR61CW, RDZ21CW	
	APPENDIX 3	
Test Report No. RTS-2604-1106-132B	Dates of Test May 04 to 05, June 08 to July 07, 2011	FCC ID: L6ARDR60CW IC: 2503A-RDR60CW FCC ID: L6ARDZ20CW IC: 2503A-RDZ20CW

Bluetooth RF Conducted Emission Test Results cont'd

Carrier Frequency Separation

The EUT met the requirements of the Carrier Frequency Separation as per 47 CFR 15.247(a) and RSS-210. Channel 38 to 39 was measured. Bluetooth was operating in frequency hopping (Euro/US) mode.

Using pattern type “Static PBRS” and packet type “DH5” during the measurements.

Bluetooth Channels	Limit (MHz)	Measured Level (MHz)
38 to 39	≥ 0.025 or 20 dB bandwidth	1.000

See figure 3-7 for the plot of the Carrier Frequency Separation measurement.

Figure 3-7: Carrier Frequency Separation, Freq. Hopping, Static PBRS, DH5, Channels 38 to 39

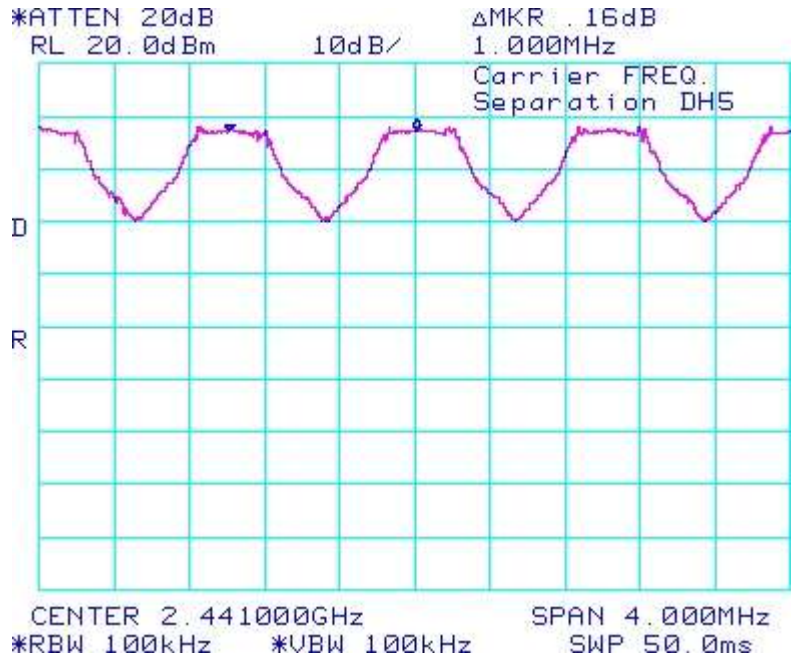

	EMI Test Report for the BlackBerry® smartphone Model RDR61CW, RDZ21CW APPENDIX 3	
	Test Report No. RTS-2604-1106-132B	Dates of Test May 04 to 05, June 08 to July 07, 2011

Bluetooth RF Conducted Emission Test Results cont'd

Using Pattern type "Static PBRs" and packet type "3-DH5" during the measurements.

Bluetooth Channels	Limit (MHz)	Measured Level (MHz)
38 to 39	≥ 0.025 or 20 dB bandwidth	1.000

See figure 3-8 for the plot of the Carrier Frequency Separation measurement.

Figure 3-8: Carrier Frequency Separation, Freq. Hopping, Static PBRs, 3-DH5, Channels 38 to 39

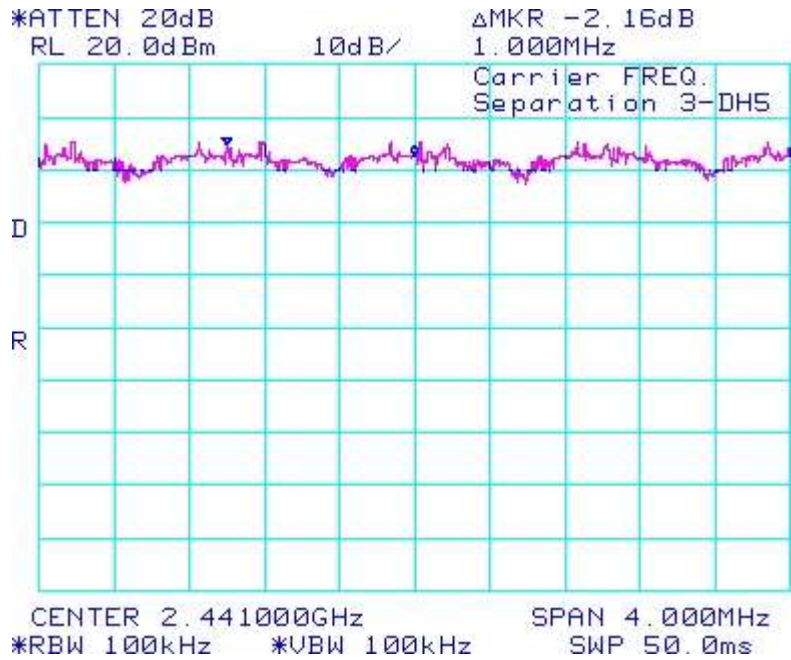

Test Report No. RTS-2604-1106-132B	Dates of Test May 04 to 05, June 08 to July 07, 2011	FCC ID: L6ARDR60CW IC: 2503A-RDR60CW FCC ID: L6ARDZ20CW IC: 2503A-RDZ20CW
--	--	--

Bluetooth RF Conducted Emission Test Results cont'd

Number of Hopping Frequencies

The EUT met the requirements of the number of hopping frequencies as per 47 CFR 15.247(a) and RSS-210. Bluetooth was operating in frequency hopping (Euro/US) mode.

Using pattern type “Static PBRS” and packet type “DH5” during the measurements.

Limit (CH)	Number of Hopping Frequencies (CH)
≥75	79

See figures 3-9 to 3-12 for the plots of the number of hopping frequencies.

Figure 3-9: Number of Hopping Frequencies Static PBRS, DH5

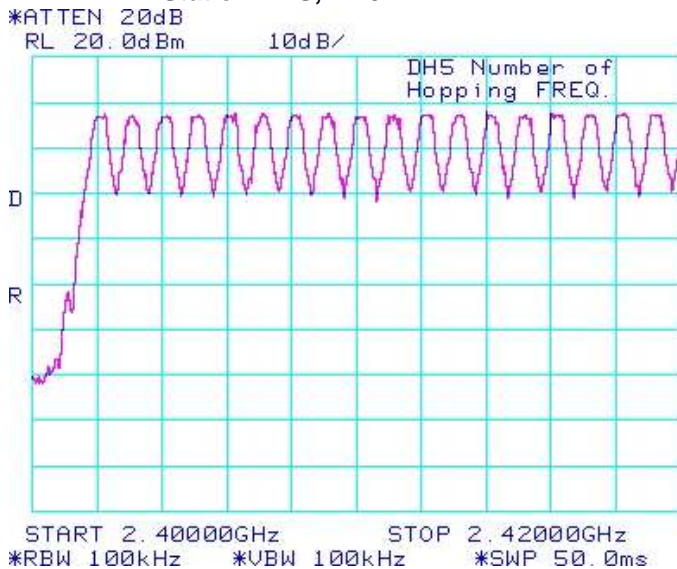
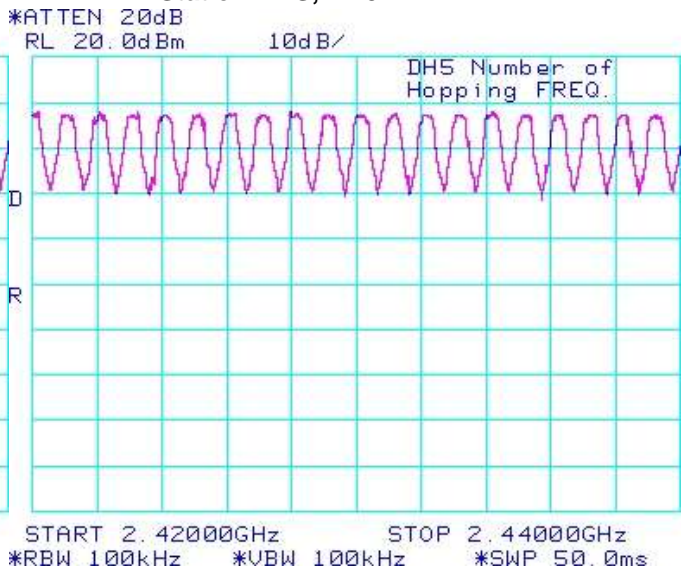



Figure 3-10: Number of Hopping Frequencies Static PBRS, DH5



	EMI Test Report for the BlackBerry® smartphone Model RDR61CW, RDZ21CW	
	APPENDIX 3	
Test Report No. RTS-2604-1106-132B	Dates of Test May 04 to 05, June 08 to July 07, 2011	FCC ID: L6ARDR60CW IC: 2503A-RDR60CW FCC ID: L6ARDZ20CW IC: 2503A-RDZ20CW

Bluetooth RF Conducted Emission Test Results cont'd

Figure 3-11: Number of Hopping Frequencies

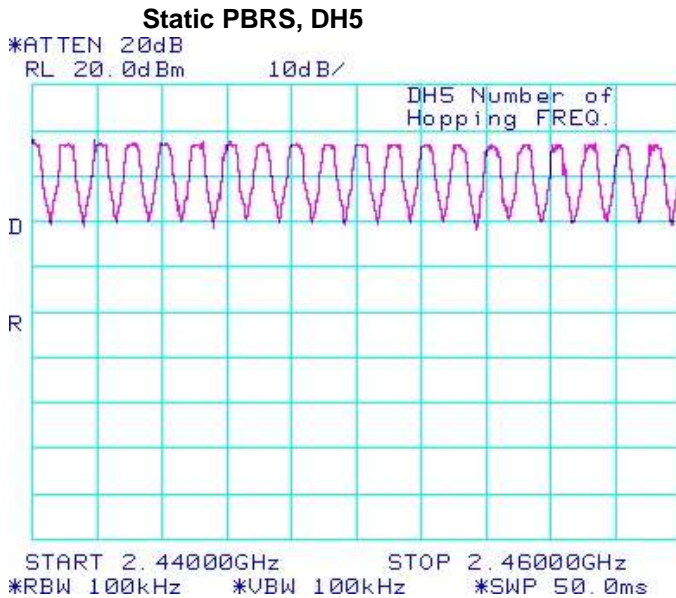
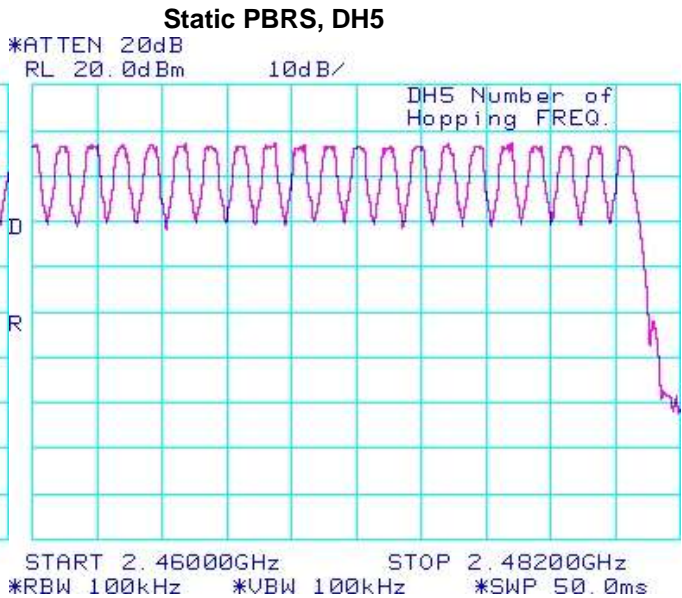

Figure 3-12: Number of Hopping Frequencies



Time of Occupancy (Dwell Time)

The EUT met the requirements of the time of occupancy (dwell time) as per 47 CFR 15.247(a) and RSS-210. Low channel (0), middle channel (39) and high channel (78) were measured in packet types DH1, DH3 and DH5. Bluetooth was operating in frequency hopping (Euro/US) mode during the measurements. The frequency hopping is 1600 hops per second for a dwell time of 625 µsec for 79 channels.

A DH1 packet needs one time slot for transmitting and one time slot for receiving. The frequency hopping is 800 hops per second with 79 channels which is 10.127 times per second. As per 15.247(a) (iii) “The average time of occupancy on any channel shall not be greater than 0.4 seconds within a period of 0.4 seconds multiplied by the number of hopping channels employed”. Therefore for 31.6 seconds (79x0.4) there are 320.0 times of appearance.

A DH3 packet needs one time slot for transmitting and one time slot for receiving. The frequency hopping is 400 hops per second with 79 channels which is 5.06 times per second. Therefore for 31.6 seconds there are 159.9 times of appearance.

A DH5 packet needs one time slot for transmitting and one time slot for receiving. The frequency hopping is 266.7 hops per second with 79 channels which is 3.38 times per second. Therefore for 31.6 seconds there are 106.8 times of appearance.

Test Report No.
 RTS-2604-1106-132B

Dates of Test
 May 04 to 05, June 08 to July 07, 2011

FCC ID: L6ARDR60CW IC: 2503A-RDR60CW
FCC ID: L6ARDZ20CW IC: 2503A-RDZ20CW

Bluetooth RF Conducted Emission Test Results cont'd

Bluetooth Channel	Mode	Tx Time (ms)	Dwell Time/31.6 sec. (msec.)	Limit (msec.)	Margin (msec.)
0	DH1	0.4203	0.4203 x 320.0 = 134.50	400	265.50
39	DH1	0.4160	0.4160 x 320.0 = 133.12	400	266.88
78	DH1	0.4160	0.4160 x 320.0 = 133.12	400	266.88
0	DH3	1.6750	1.6750 x 159.9 = 267.83	400	132.17
39	DH3	1.6750	1.6750 x 159.9 = 267.83	400	132.17
78	DH3	1.6800	1.6800 x 159.9 = 268.63	400	131.37
0	DH5	2.9200	2.9200 x 106.8 = 311.86	400	88.14
39	DH5	2.9300	2.9300 x 106.8 = 312.92	400	87.08
78	DH5	2.9300	2.9300 x 106.8 = 312.92	400	87.08

See figures 3-13 to 3-21 for the plots of the dwell time.

Bluetooth RF Conducted Emission Test Results cont'd

Figure 3-13: Time of Occupancy (Dwell Time)
Freq. Hopping, Static PBRs, DH1

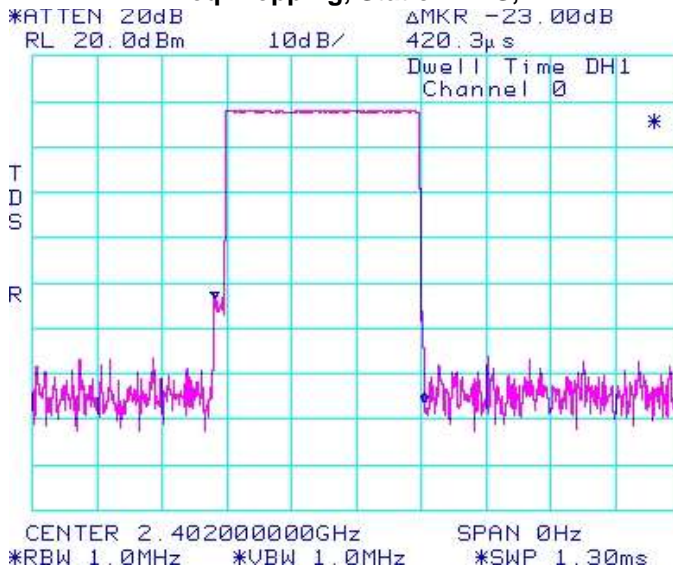
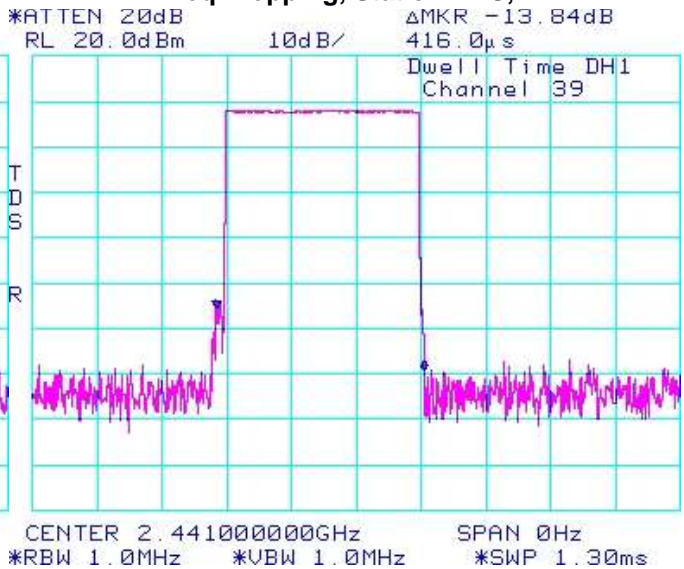

Figure 3-14: Time of Occupancy (Dwell Time)
Freq. Hopping, Static PBRs, DH1



Test Report No.
 RTS-2604-1106-132B

Dates of Test
 May 04 to 05, June 08 to July 07, 2011

FCC ID: L6ARDR60CW **IC:** 2503A-RDR60CW
FCC ID: L6ARDZ20CW **IC:** 2503A-RDZ20CW

Bluetooth RF Conducted Emission Test Results cont'd

Figure 3-15: Time of Occupancy (Dwell Time)
Freq. Hopping, Static PBRs, DH1

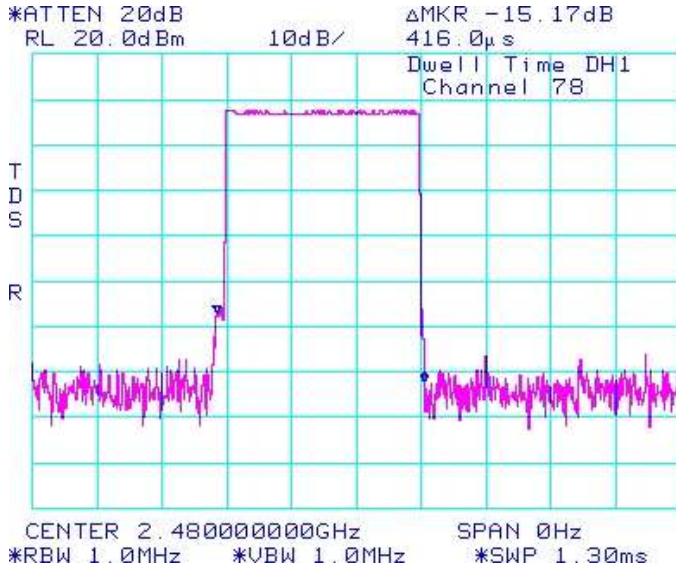

Figure 3-16: Time of Occupancy (Dwell Time)
Freq. Hopping, Static PBRs, DH3

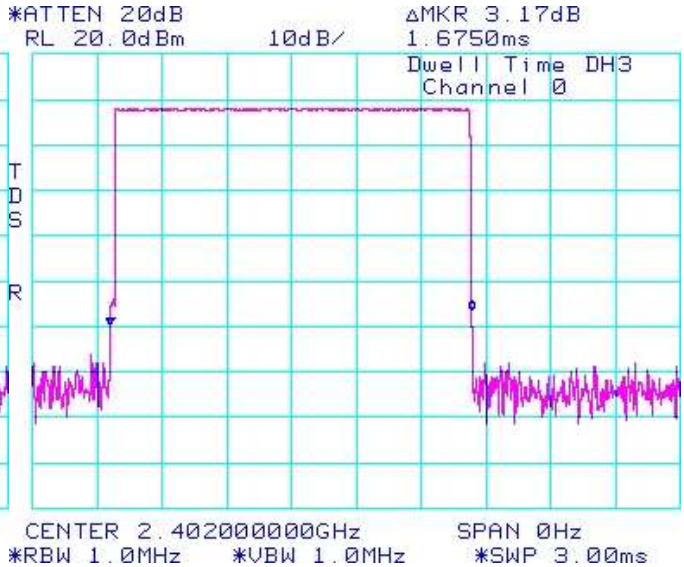

Figure 3-17: Time of Occupancy (Dwell Time)
Freq. Hopping, Static PBRs, DH3

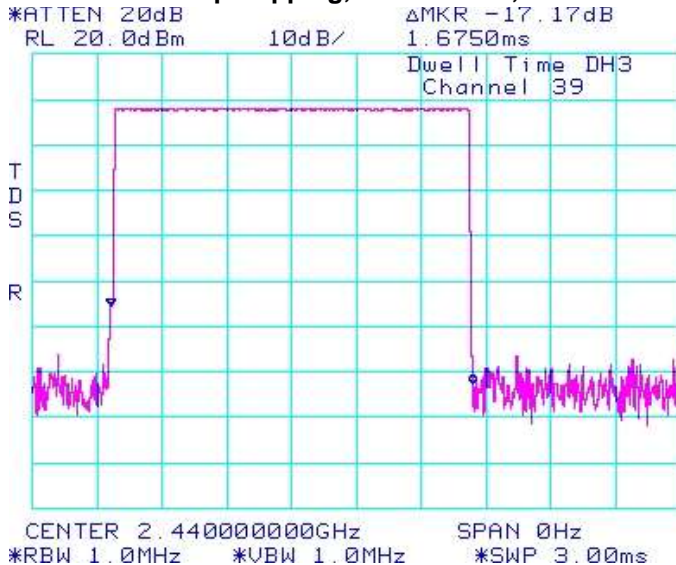
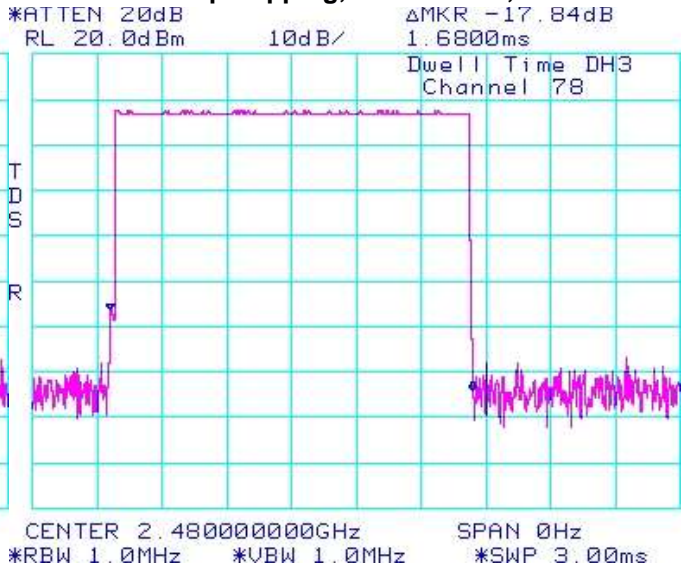

Figure 3-18 : Time of Occupancy (Dwell Time)
Freq. Hopping, Static PBRs, DH3



Test Report No.
 RTS-2604-1106-132B

Dates of Test
 May 04 to 05, June 08 to July 07, 2011

FCC ID: L6ARDR60CW **IC:** 2503A-RDR60CW
FCC ID: L6ARDZ20CW **IC:** 2503A-RDZ20CW

Bluetooth RF Conducted Emission Test Results cont'd

Figure 3-19: Time of Occupancy (Dwell Time)

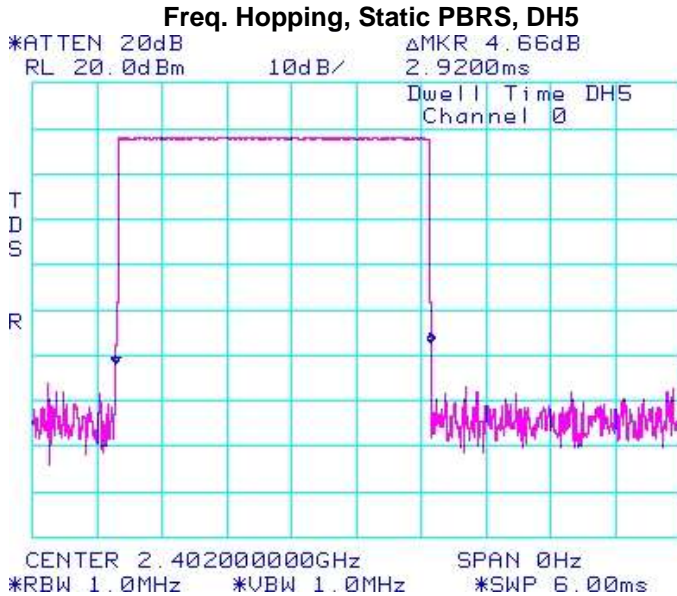

Figure 3-20: Time of Occupancy (Dwell Time)

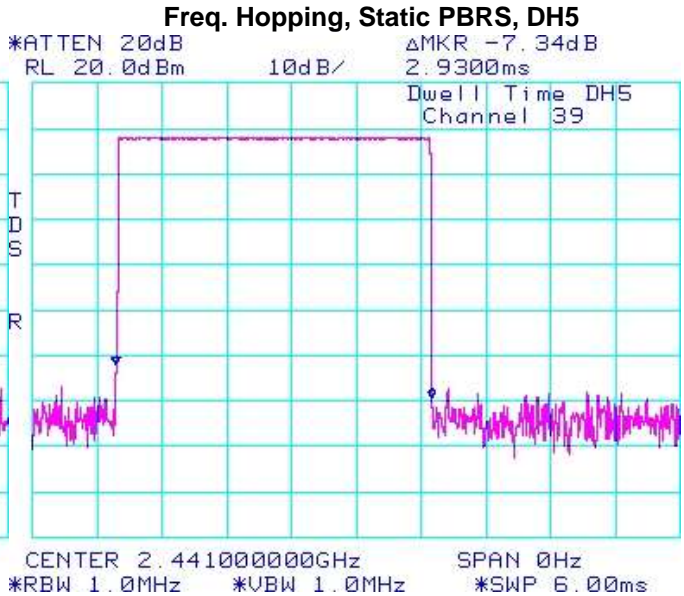
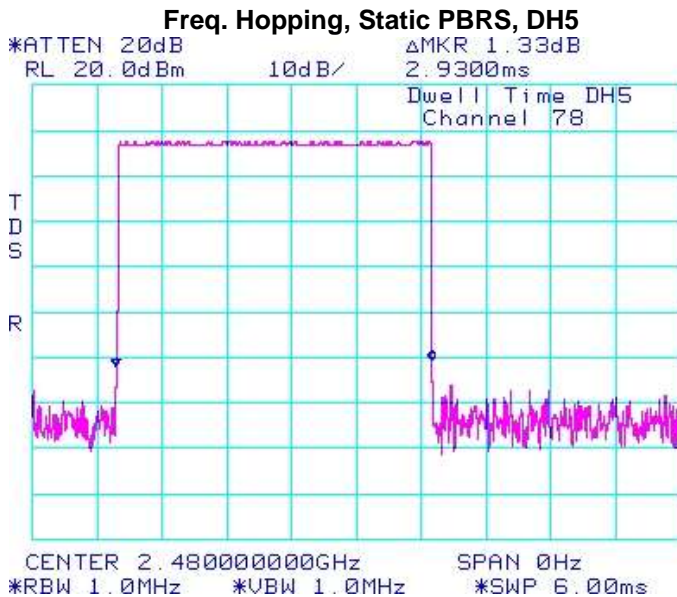



Figure 3-21: Time of Occupancy (Dwell Time)



	EMI Test Report for the BlackBerry® smartphone Model RDR61CW, RDZ21CW	
	APPENDIX 3	
Test Report No. RTS-2604-1106-132B	Dates of Test May 04 to 05, June 08 to July 07, 2011	FCC ID: L6ARDR60CW IC: 2503A-RDR60CW FCC ID: L6ARDZ20CW IC: 2503A-RDZ20CW

Bluetooth RF Conducted Emission Test Results cont'd

Maximum Peak Conducted Output Power

The EUT met the requirements of the maximum peak conducted output power of class 1 as per 47 CFR 15.247(b) and RSS-210. Low channel (0), middle channel (39) and high channel (78) were measured. Bluetooth was operating in single frequency mode during the measurements. A reference offset of 12.4 dB was applied to the spectrum analyzer reference level for the coaxial cable loss and attenuators in the test circuit.

Using pattern type "Static PBRs" and packet type "DH5" during the measurements.

Bluetooth Channel	Measured Level (dBm)	Measured Level (W)	Class 1 Limit (dBm)
0	8.00	0.00631	0.0 to 20.0
39	8.17	0.00656	0.0 to 20.0
78	7.50	0.00562	0.0 to 20.0

See figures 3-22 to 3-24 for the plots of the maximum peak conducted output power.

Figure 3-22: Max. Peak Conducted Output Power
Single Freq., Static PBRs, DH5

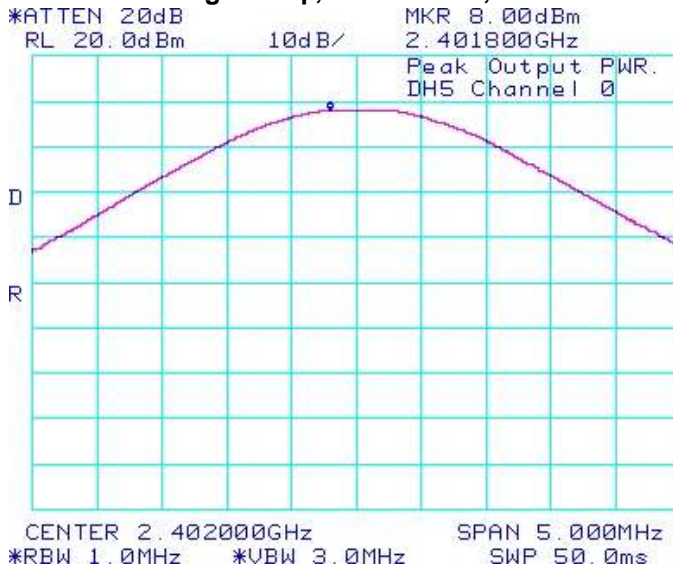
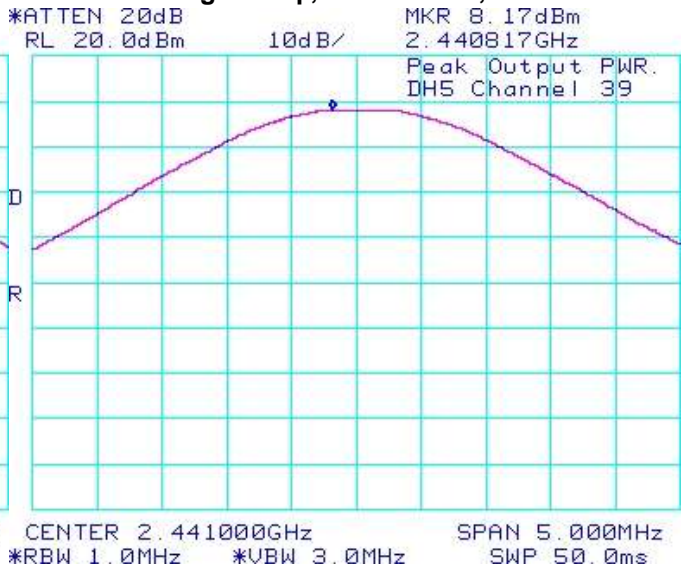



Figure 3-23: Max. Peak Conducted Output Power
Single Freq., Static PBRs, DH5



	EMI Test Report for the BlackBerry® smartphone Model RDR61CW, RDZ21CW	
	APPENDIX 3	
Test Report No. RTS-2604-1106-132B	Dates of Test May 04 to 05, June 08 to July 07, 2011	FCC ID: L6ARDR60CW IC: 2503A-RDR60CW FCC ID: L6ARDZ20CW IC: 2503A-RDZ20CW

Bluetooth RF Conducted Emission Test Results cont'd

Figure 3-24: Max. Peak Conducted Output Power

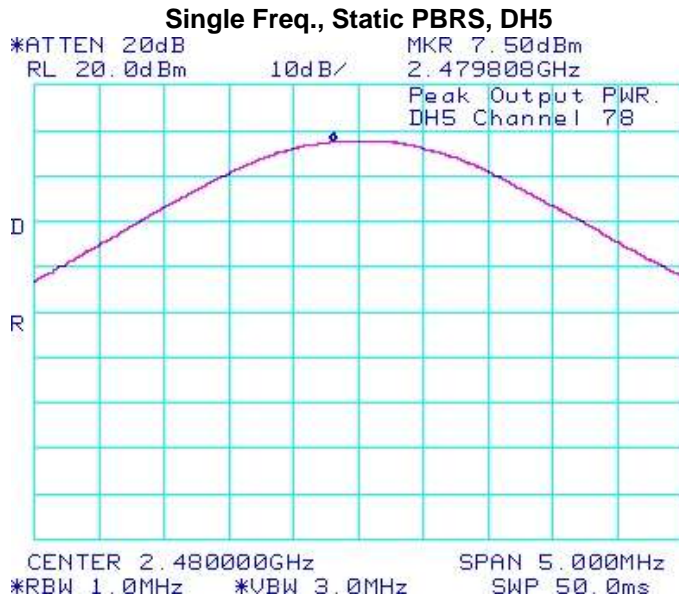

Using Pattern type “Static PBRs” and packet type “3-DH5” during the measurements.

Bluetooth Channel	Measured Level (dBm)	Measured Level (W)	Class 1 Limit (dBm)
0	8.00	0.00631	0.0 to 20.0
39	8.00	0.00631	0.0 to 20.0
78	7.33	0.00541	0.0 to 20.0

See figures 3-25 to 3-27 for the plots of the maximum peak conducted output power.

Test Report No.
 RTS-2604-1106-132B

Dates of Test
 May 04 to 05, June 08 to July 07, 2011

FCC ID: L6ARDR60CW **IC:** 2503A-RDR60CW
FCC ID: L6ARDZ20CW **IC:** 2503A-RDZ20CW

Bluetooth RF Conducted Emission Test Results cont'd

Figure 3-25: Max. Peak Conducted Output Power

Single Freq., Static PBRs, 3-DH5

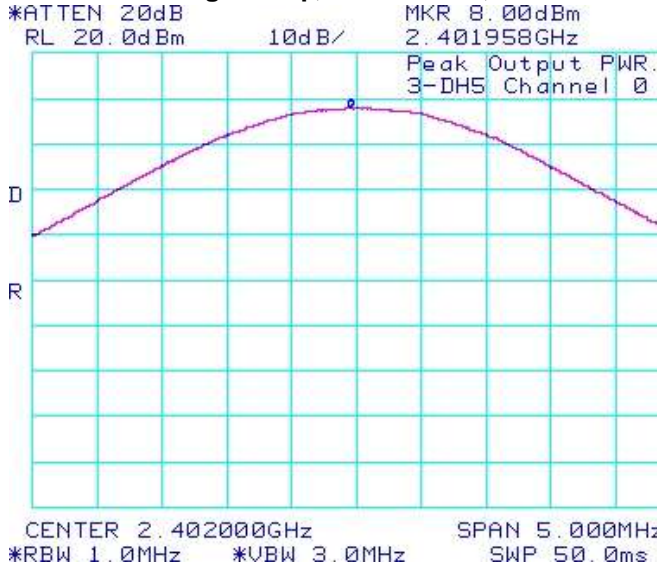

Figure 3-26: Max. Peak Conducted Output Power

Single Freq., Static PBRs, 3-DH5

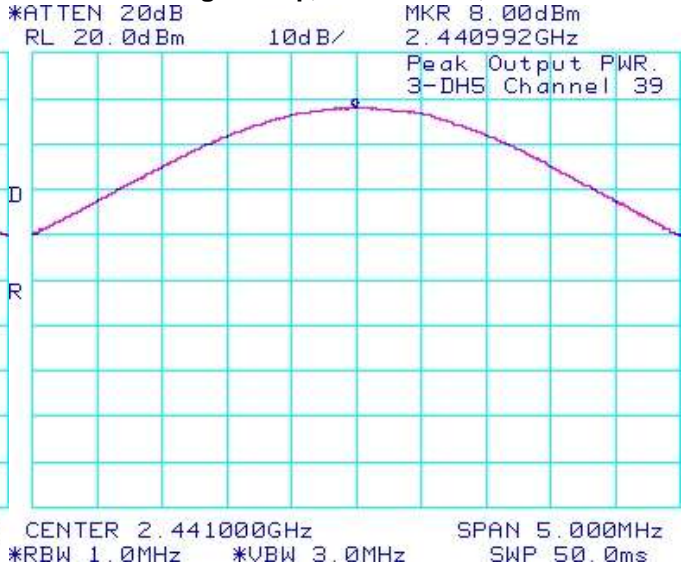
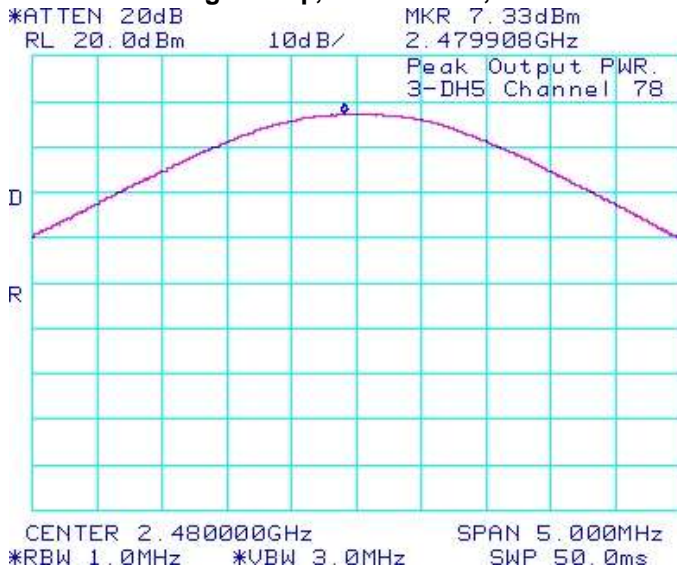

Figure 3-27: Max. Peak Conducted Output Power

Single Freq., Static PBRs, 3-DH5



Test Report No. RTS-2604-1106-132B	Dates of Test May 04 to 05, June 08 to July 07, 2011	FCC ID: L6ARDR60CW IC: 2503A-RDR60CW FCC ID: L6ARDZ20CW IC: 2503A-RDZ20CW
--	--	--

Bluetooth RF Conducted Emission Test Results cont'd

Band Edge Compliance

The EUT met the requirements of the band edge compliance as per 47 CFR 15.247(c) and RSS-210. Low channel (0) and high channel (78) were measured. Bluetooth was operating in single frequency and hopping mode.

Using pattern type “Static PBRS” and packet type “DH5” during the measurements.

Bluetooth Channel	Operating Mode	Measured Level (dBc)	Limit (dBc)	Margin (dB)
0	Single Frequency	-39.50	-20	-19.50
78	Single Frequency	-39.17	-20	-19.17
0	Hopping	-40.50	-20	-20.50
78	Hopping	-39.33	-20	-19.33

See figures 3-28 to 3-31 for the plots of the band edge compliance measurements.

Figure 3-28: Band Edge Compliance

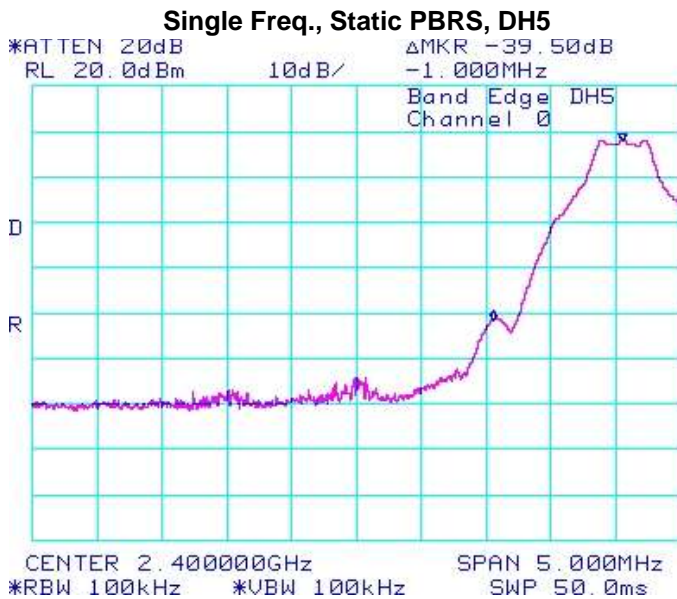
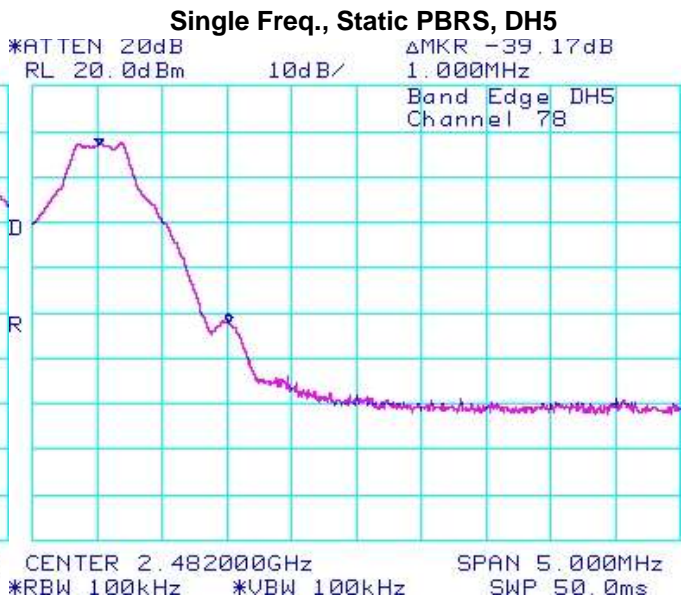

Figure 3-29: Band Edge Compliance



Test Report No.
RTS-2604-1106-132B

Dates of Test
May 04 to 05, June 08 to July 07, 2011

FCC ID: L6ARDR60CW **IC:** 2503A-RDR60CW
FCC ID: L6ARDZ20CW **IC:** 2503A-RDZ20CW

Bluetooth RF Conducted Emission Test Results cont'd

Figure 3-30: Band Edge Compliance

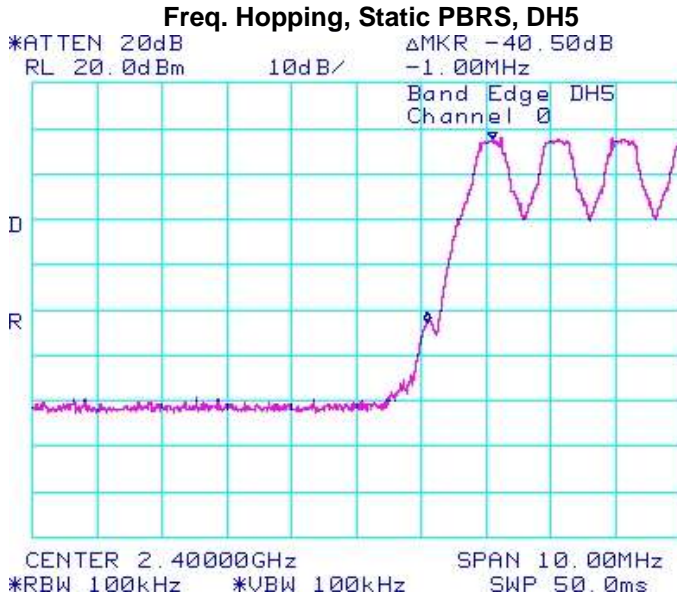
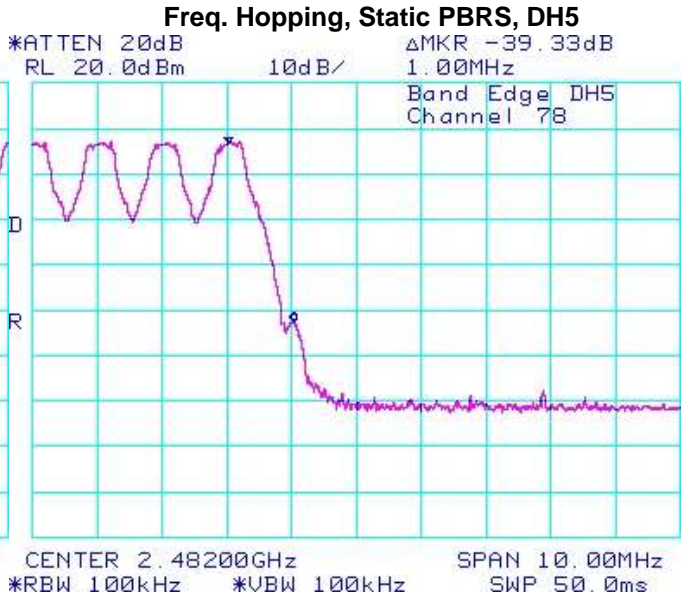

Figure 3-31: Band Edge Compliance



Using pattern type “Static PBRS” and packet type “3-DH5” during the measurements.

Bluetooth Channel	Operating Mode	Measured Level (dBc)	Limit (dBc)	Margin (dB)
0	Single Frequency	-39.67	-20	-19.67
78	Single Frequency	-31.16	-20	-11.16
0	Hopping	-35.50	-20	-15.50
78	Hopping	-31.83	-20	-11.83

See figures 3-32 to 3-35 for the plots of the band edge compliance measurements.

Test Report No.
 RTS-2604-1106-132B

Dates of Test
 May 04 to 05, June 08 to July 07, 2011

FCC ID: L6ARDR60CW **IC:** 2503A-RDR60CW
FCC ID: L6ARDZ20CW **IC:** 2503A-RDZ20CW

Bluetooth RF Conducted Emission Test Results cont'd

Figure 3-32: Band Edge Compliance

Single Freq., Static PBRS, 3-DH5

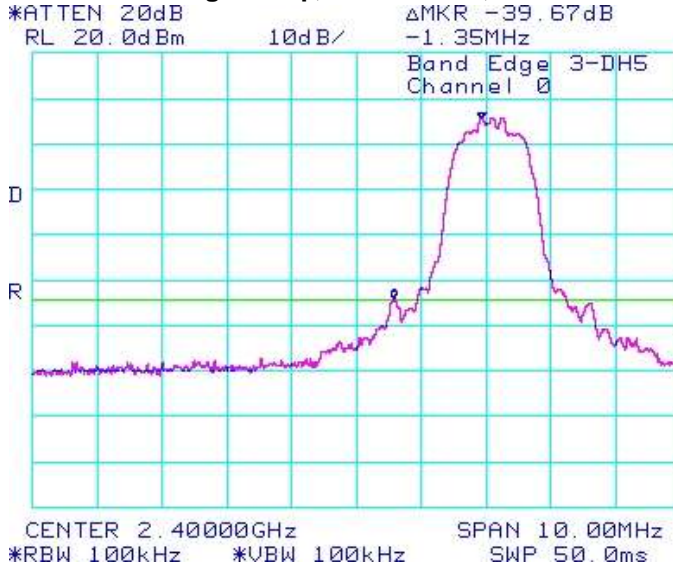

Figure 3-33: Band Edge Compliance

Single Freq., Static PBRS, 3-DH5

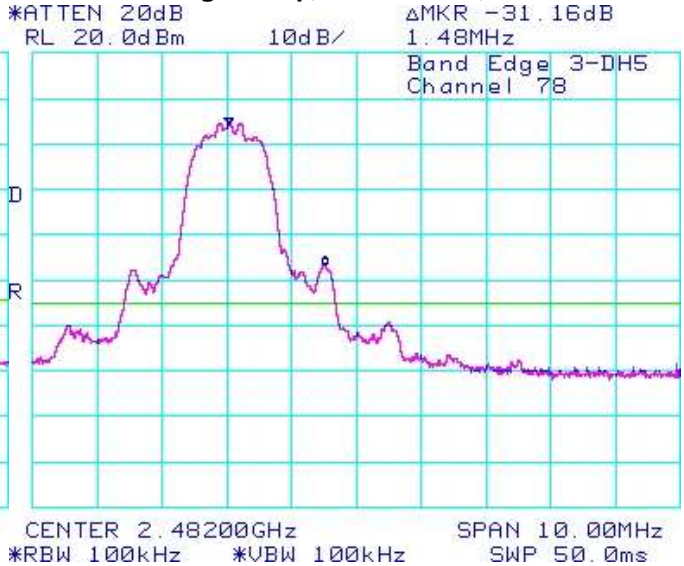

Figure 3-34: Band Edge Compliance

Freq. Hopping, Static PBRS, 3-DH5

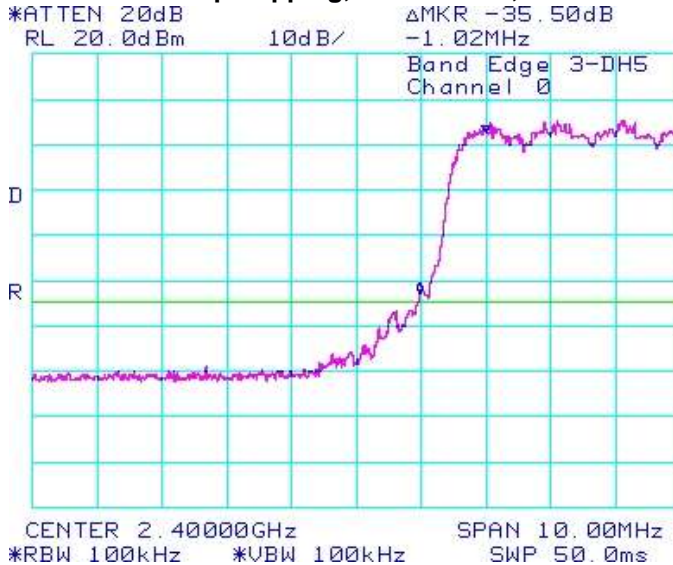



Figure 3-35: Band Edge Compliance

Freq. Hopping, Static PBRS, 3-DH5



	EMI Test Report for the BlackBerry® smartphone Model RDR61CW, RDZ21CW	
	APPENDIX 3	
Test Report No. RTS-2604-1106-132B	Dates of Test May 04 to 05, June 08 to July 07, 2011	FCC ID: L6ARDR60CW IC: 2503A-RDR60CW FCC ID: L6ARDZ20CW IC: 2503A-RDZ20CW

Bluetooth RF Conducted Emission Test Results cont'd

Spurious RF Conducted Emissions

The EUT met the requirements of the spurious RF conducted emissions as per 47 CFR 15.247(c) and RSS-210. Low channel (0), mid channel (39) and high channel (78) were measured. Bluetooth was operating in single frequency and hopping mode. A reference offset of 12.4 dB was applied to the spectrum analyzer reference level for the attenuators and coaxial cable loss in the test circuit.

Using pattern type “Static PBRS” and packet type “DH5” during the measurements.

Bluetooth Channel	Channel Power (dBm)	Max. Measured Level (dBm)	Max. Measured Level from carrier (dBc)	Limit (dBc)
0	8.00	-48.50	-56.50	-20
39	8.17	-49.83	-58.00	-20
78	7.50	-51.83	-59.33	-20
Hopping mode	7.50	-50.33	-57.83	-20

See figures 3-36 to 3-39 for the plots of the spurious RF conducted emissions.

Test Report No.
 RTS-2604-1106-132B

Dates of Test
 May 04 to 05, June 08 to July 07, 2011

FCC ID: L6ARDR60CW IC: 2503A-RDR60CW
FCC ID: L6ARDZ20CW IC: 2503A-RDZ20CW

Bluetooth RF Conducted Emission Test Results cont'd

Figure 3-36: Spurious RF Conducted Emissions

Single Freq., Static PBRs, DH5,

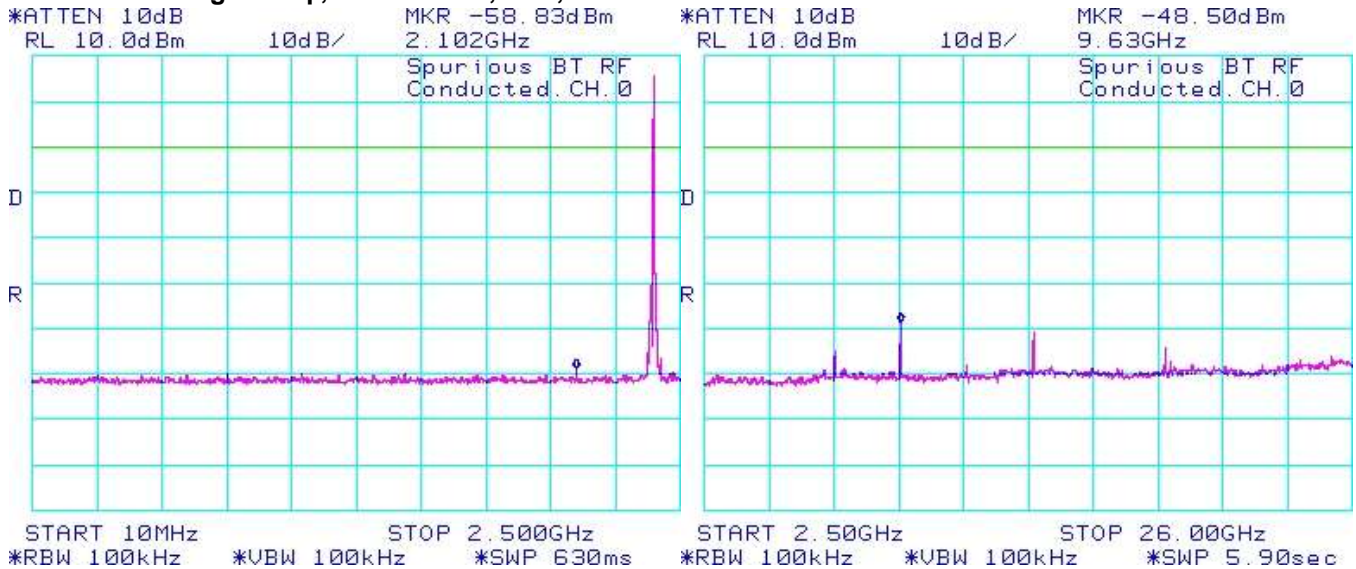
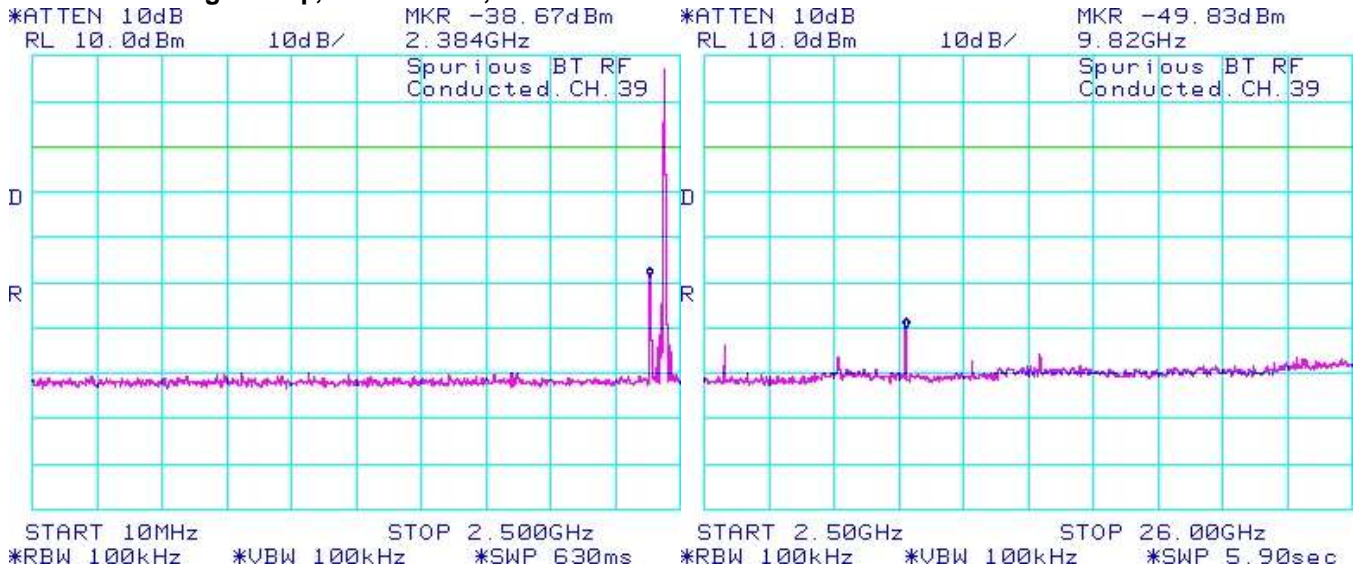

Figure 3-37: Spurious RF Conducted Emissions

Single Freq., Static PBRs, DH5



Test Report No.
 RTS-2604-1106-132B

Dates of Test
 May 04 to 05, June 08 to July 07, 2011

FCC ID: L6ARDR60CW **IC:** 2503A-RDR60CW
FCC ID: L6ARDZ20CW **IC:** 2503A-RDZ20CW

Bluetooth RF Conducted Emission Test Results cont'd

Figure 3-38: Spurious RF Conducted Emissions

Single Freq., Static PBRs, DH5

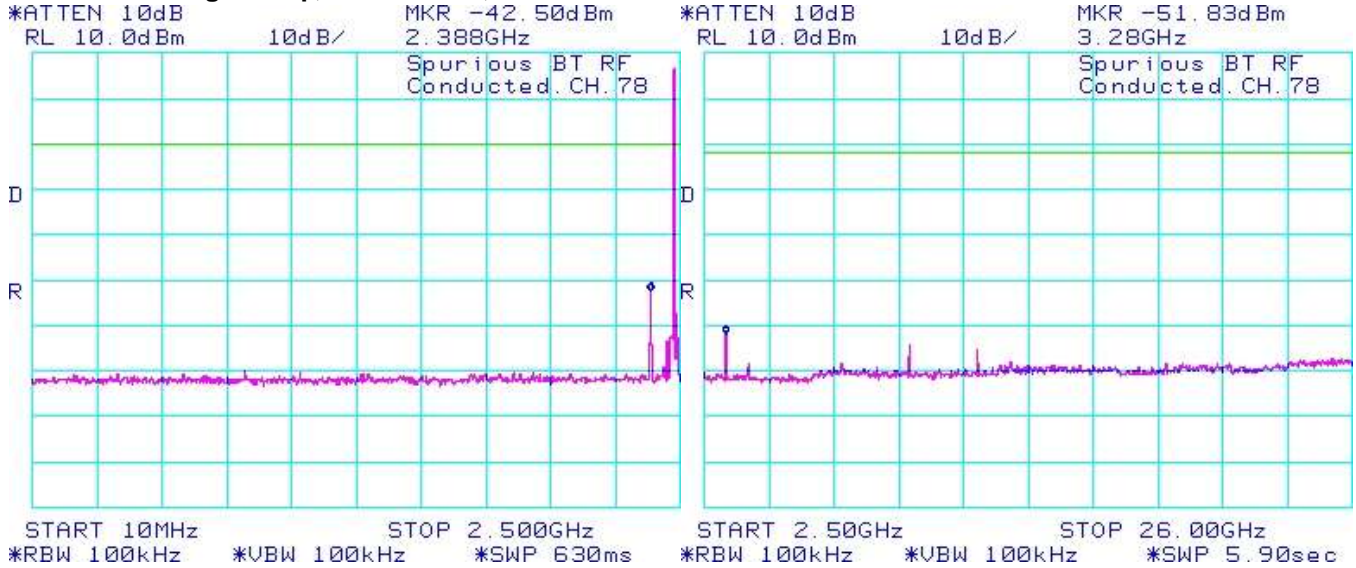
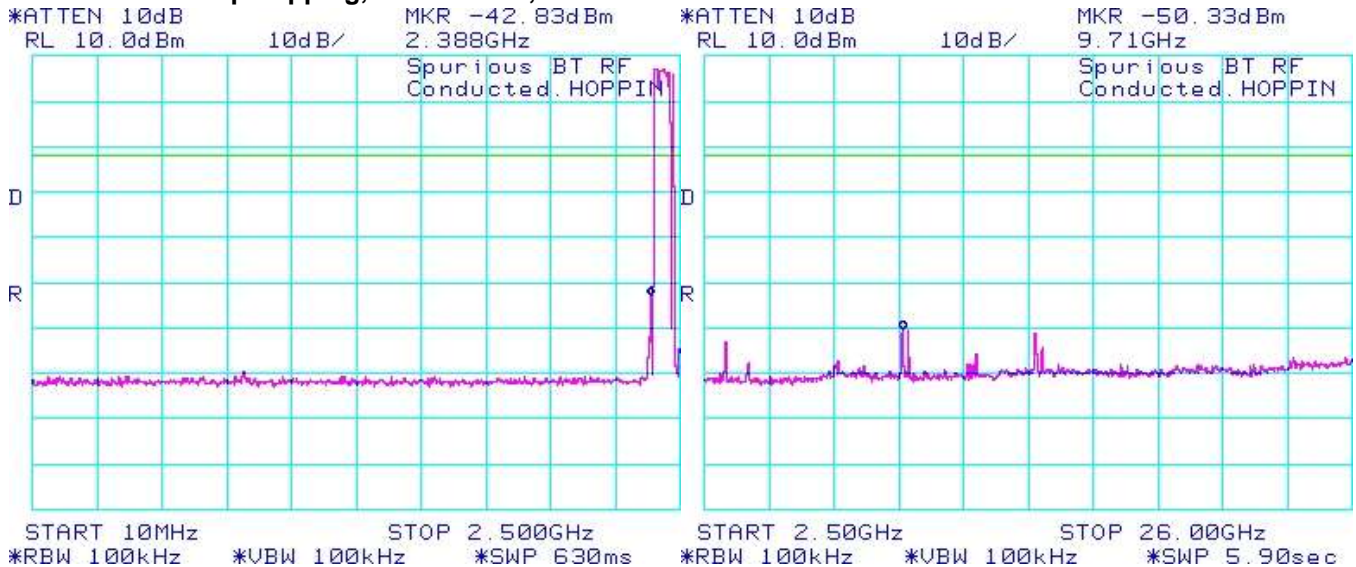



Figure 3-39: Spurious RF Conducted Emissions

Freq. Hopping, Static PBRs, DH5



	EMI Test Report for the BlackBerry® smartphone Model RDR61CW, RDZ21CW	
	APPENDIX 3	
Test Report No. RTS-2604-1106-132B	Dates of Test May 04 to 05, June 08 to July 07, 2011	FCC ID: L6ARDR60CW IC: 2503A-RDR60CW FCC ID: L6ARDZ20CW IC: 2503A-RDZ20CW

Bluetooth RF Conducted Emission Test Results cont'd

Using pattern type "Static PBRs" and packet type "3-DH5" during the measurements.

Bluetooth Channel	Channel Power (dBm)	Max. Measured Level (dBm)	Max. Measured Level from carrier (dBc)	Limit (dBc)
0	8.00	-50.33	-58.33	-20
39	8.00	-53.67	-61.67	-20
78	7.33	-54.83	-62.16	-20
Hopping mode	7.33	-53.67	-61.00	-20

See figures 3-40 to 3-43 for the plots of the spurious RF conducted emissions.

Test Report No.
 RTS-2604-1106-132B

Dates of Test
 May 04 to 05, June 08 to July 07, 2011

FCC ID: L6ARDR60CW IC: 2503A-RDR60CW
FCC ID: L6ARDZ20CW IC: 2503A-RDZ20CW

Bluetooth RF Conducted Emission Test Results cont'd

Figure 3-40 : Spurious RF Conducted Emissions

Single Freq., Static PBRs, 3-DH5

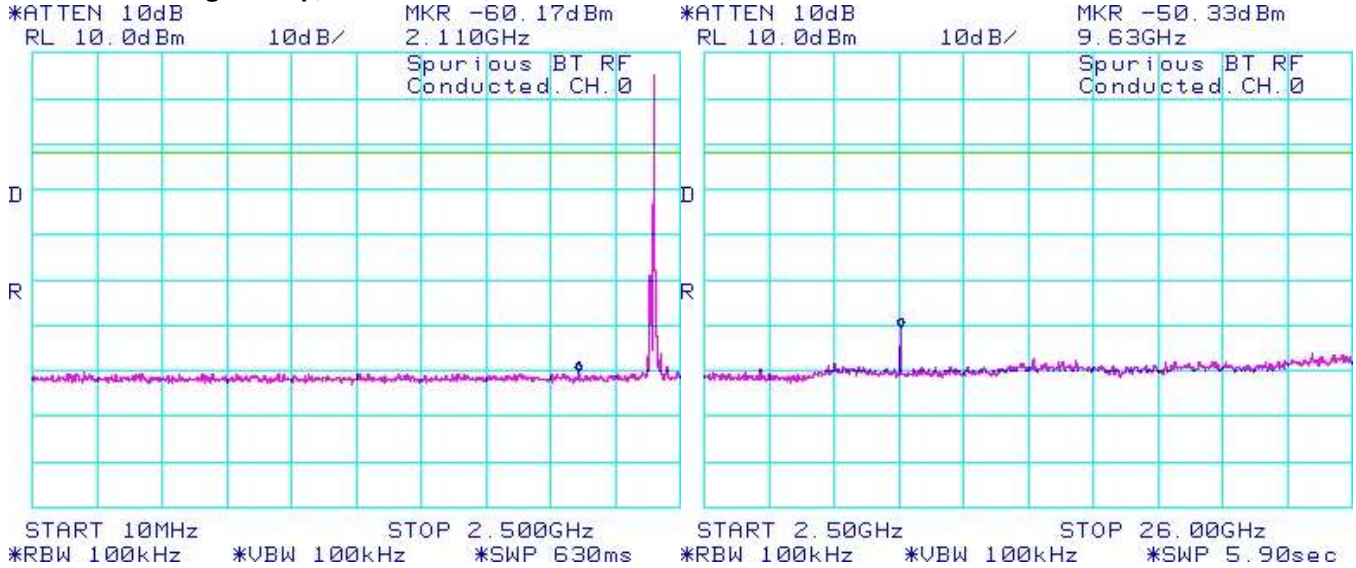
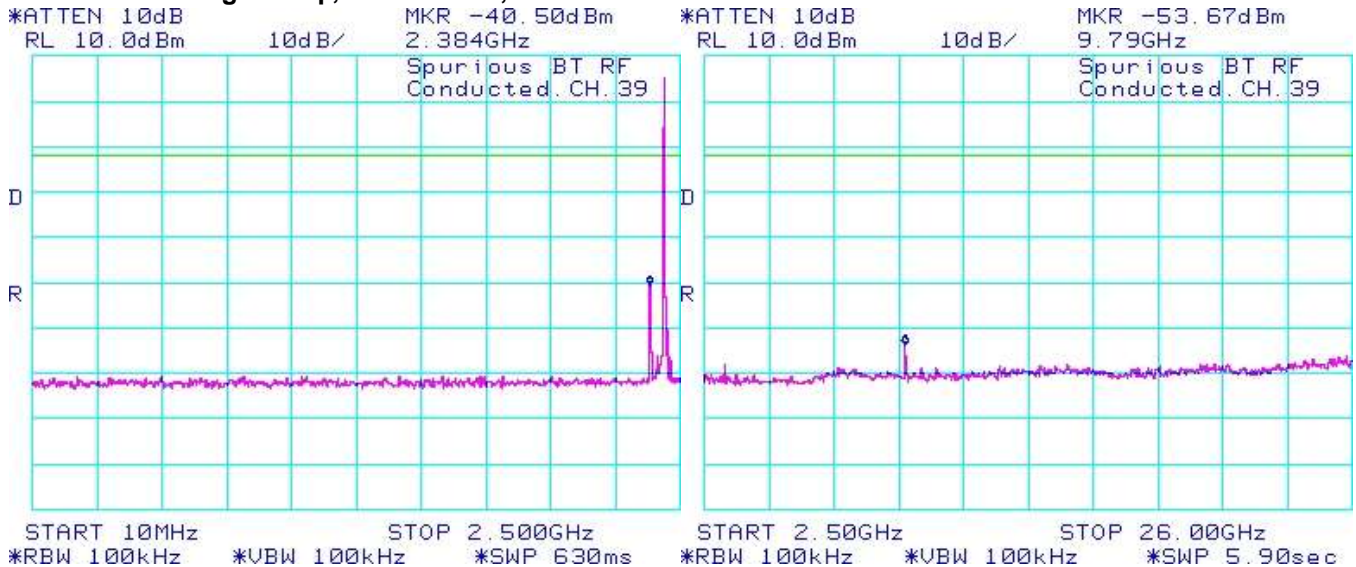

Figure 3-41: Spurious RF Conducted Emissions

Single Freq., Static PBRs, 3-DH5



Test Report No.
 RTS-2604-1106-132B

Dates of Test
 May 04 to 05, June 08 to July 07, 2011

FCC ID: L6ARDR60CW **IC:** 2503A-RDR60CW
FCC ID: L6ARDZ20CW **IC:** 2503A-RDZ20CW

Bluetooth RF Conducted Emission Test Results cont'd

Figure 3-42: Spurious RF Conducted Emissions

Single Freq., Static PBRs, 3-DH5

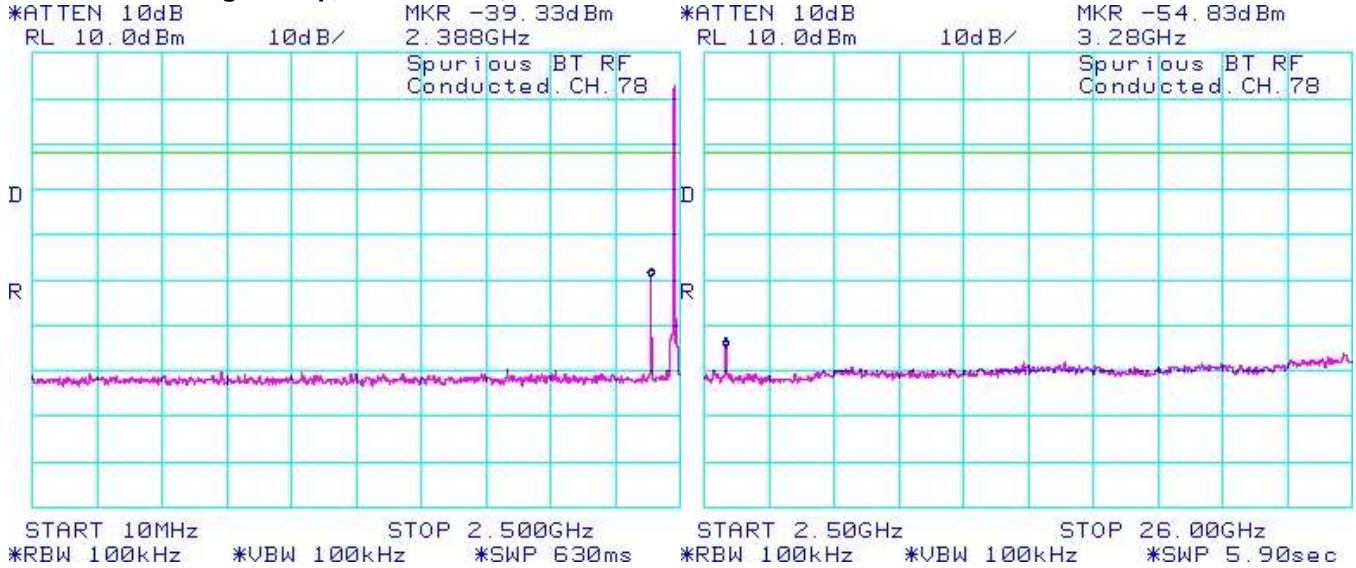
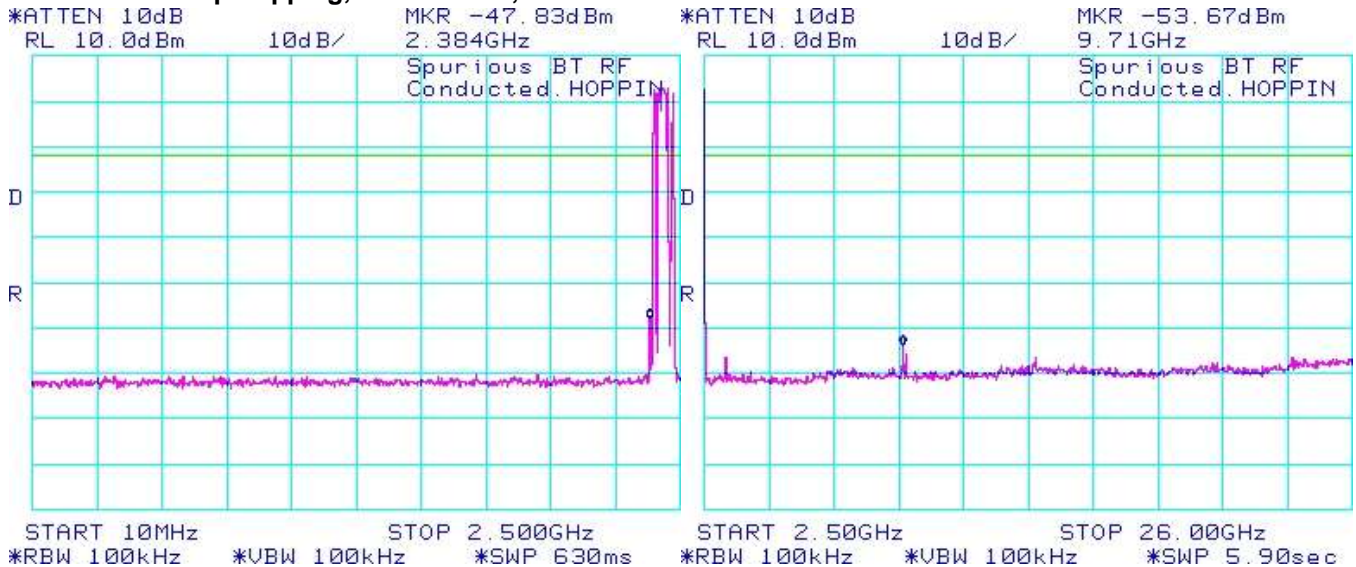



Figure 3-43 : Spurious RF Conducted Emissions

Freq. Hopping, Static PBRs, 3-DH5



	EMI Test Report for the BlackBerry® smartphone Model RDR61CW, RDZ21CW APPENDIX 4	
Test Report No. RTS-2604-1106-132B	Dates of Test May 04 to 05, June 08 to July 07, 2011	FCC ID: L6ARDR60CW IC: 2503A-RDR60CW FCC ID: L6ARDZ20CW IC: 2503A-RDZ20CW

APPENDIX 4 – 802.11b/g/n CONDUCTED EMISSIONS TEST DATA/PLOTS

RIM Testing Services	EMI Test Report for the BlackBerry® smartphone Model RDR61CW, RDZ21CW	
	APPENDIX 4	
Test Report No. RTS-2604-1106-132B	Dates of Test May 04 to 05, June 08 to July 07, 2011	FCC ID: L6ARDR60CW IC: 2503A-RDR60CW FCC ID: L6ARDZ20CW IC: 2503A-RDZ20CW

802.11b/g/n RF Conducted Emission Test Results

The following test configurations were measured for model RDR61CW:

Test Setup Diagram

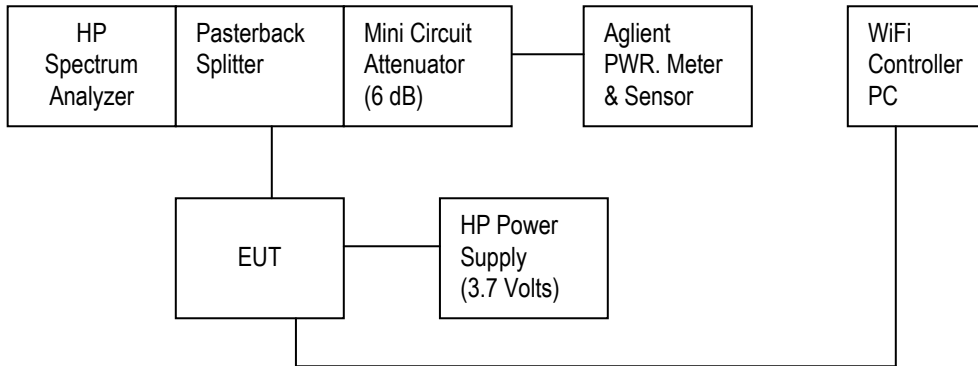

A reference offset of 20.4 dB was applied to the spectrum analyzer and 6.6 dB was applied to the Power Meter reference level for the attenuators and coaxial cable loss in the test circuit.

Date of test: June 30, 2011

The measurements on the BlackBerry® smartphone were performed by Maurice Battler.

The environmental test conditions were:

Temperature:	24 °C
Relative Humidity:	48 %

APPENDIX 4
Test Report No.
 RTS-2604-1106-132B

Dates of Test
 May 04 to 05, June 08 to July 07, 2011

FCC ID: L6ARDR60CW **IC:** 2503A-RDR60CW
FCC ID: L6ARDZ20CW **IC:** 2503A-RDZ20CW

802.11b/g/n RF Conducted Emission Test Results cont'd
6 dB Bandwidth

The EUT met the requirements of the 6 dB bandwidth as per 47 CFR 15.247(a) (2) and RSS-210. Channels 1, 6 and 11 were measured at 1 Mbps, 5.5 Mbps, and 11Mbps each for 802.11b mode, 6 Mbps, 24 Mbps, and 54 Mbps each for 802.11g mode, and MCS 0, 4, and 7 for 802.11n mode.

Channel	Data Rate	Limit (kHz)	Measured Level (MHz)
1	1 Mbps	≥ 500	10.13
	5.5 Mbps	≥ 500	11.10
	11 Mbps	≥ 500	11.20
	6 Mbps	≥ 500	16.47
	24 Mbps	≥ 500	16.53
	54 Mbps	≥ 500	16.60
	MCS 0	≥ 500	17.27
	MCS 4	≥ 500	17.80
	MCS 7	≥ 500	17.77
6	1 Mbps	≥ 500	10.13
	5.5 Mbps	≥ 500	11.30
	11 Mbps	≥ 500	11.13
	6 Mbps	≥ 500	16.40
	24 Mbps	≥ 500	16.60
	54 Mbps	≥ 500	16.67
	MCS 0	≥ 500	16.70
	MCS 4	≥ 500	17.67
	MCS 7	≥ 500	17.80



EMI Test Report for the BlackBerry® smartphone Model RDR61CW, RDZ21CW

APPENDIX 4

Test Report No.
RTS-2604-1106-132B

Dates of Test
May 04 to 05, June 08 to July 07, 2011

FCC ID: L6ARDR60CW **IC:** 2503A-RDR60CW
FCC ID: L6ARDZ20CW **IC:** 2503A-RDZ20CW

802.11b/g/n RF Conducted Emission Test Results cont'd

Channel	Data Rate	Limit (kHz)	Measured Level (MHz)
11	1 Mbps	≥ 500	10.10
	5.5 Mbps	≥ 500	10.67
	11 Mbps	≥ 500	11.33
	6 Mbps	≥ 500	16.40
	24 Mbps	≥ 500	16.60
	54 Mbps	≥ 500	16.63
	MCS 0	≥ 500	17.77
	MCS 4	≥ 500	17.77
	MCS 7	≥ 500	17.77

Test Report No. RTS-2604-1106-132B	Dates of Test May 04 to 05, June 08 to July 07, 2011	FCC ID: L6ARDR60CW IC: 2503A-RDR60CW FCC ID: L6ARDZ20CW IC: 2503A-RDZ20CW
--	--	--

802.11b/g/n RF Conducted Emission Test Results cont'd

See figures 4-1 to 4-9 for the plots of the 6 dB bandwidth measurements for Channels 1, 6, and 11, at 1 Mbps each for 802.11b mode, 6 Mbps each for 802.11g mode, and MCS 0 each for 802.11n mode.

Figure 4-1: 6 dB Bandwidth

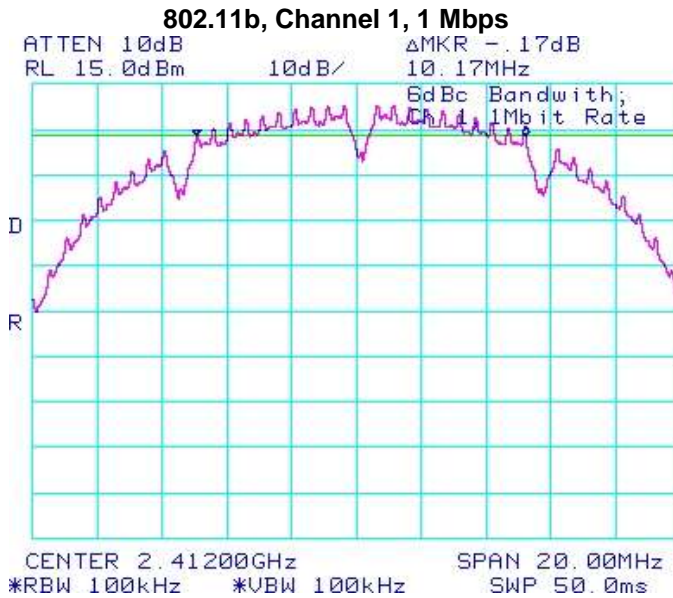

Figure 4-2: 6 dB Bandwidth

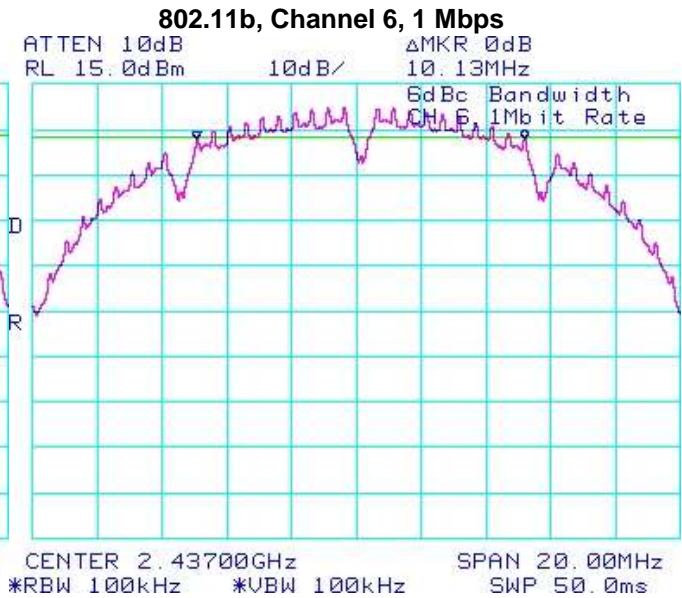

Figure 4-3: 6 dB Bandwidth

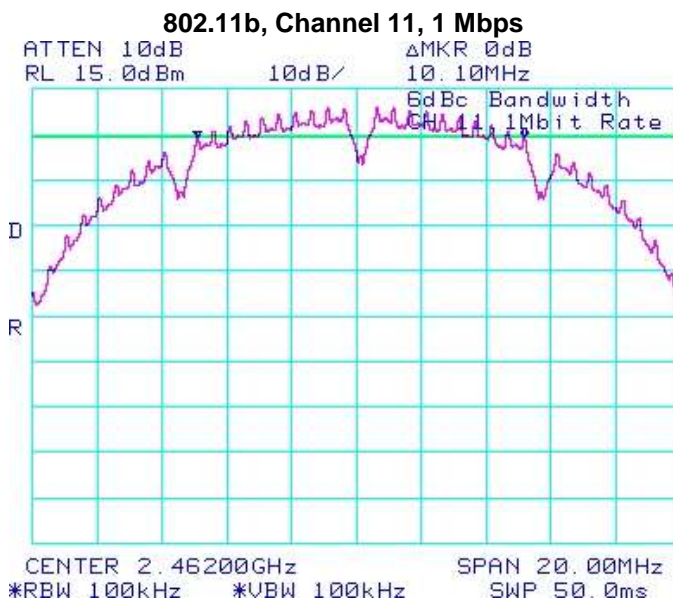
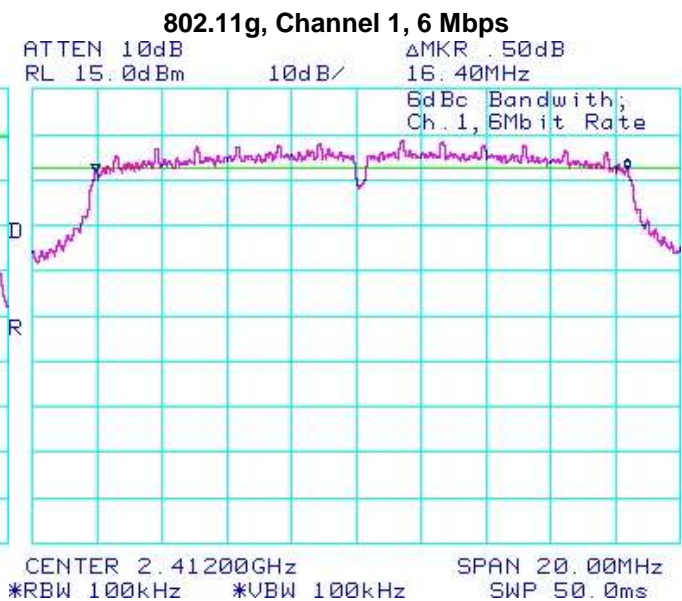

Figure 4-4: 6 dB Bandwidth



Test Report No. RTS-2604-1106-132B	Dates of Test May 04 to 05, June 08 to July 07, 2011	FCC ID: L6ARDR60CW IC: 2503A-RDR60CW FCC ID: L6ARDZ20CW IC: 2503A-RDZ20CW
--	--	--

802.11b/g/n RF Conducted Emission Test Results cont'd

Figure 4-5: 6 dB Bandwidth

802.11g, Channel 6, 6 Mbps

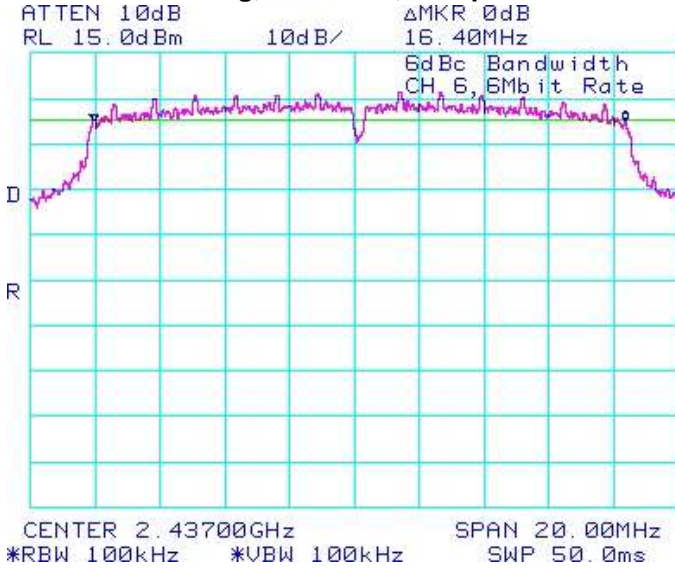

Figure 4-6: 6 dB Bandwidth

802.11g, Channel 11, 6 Mbps

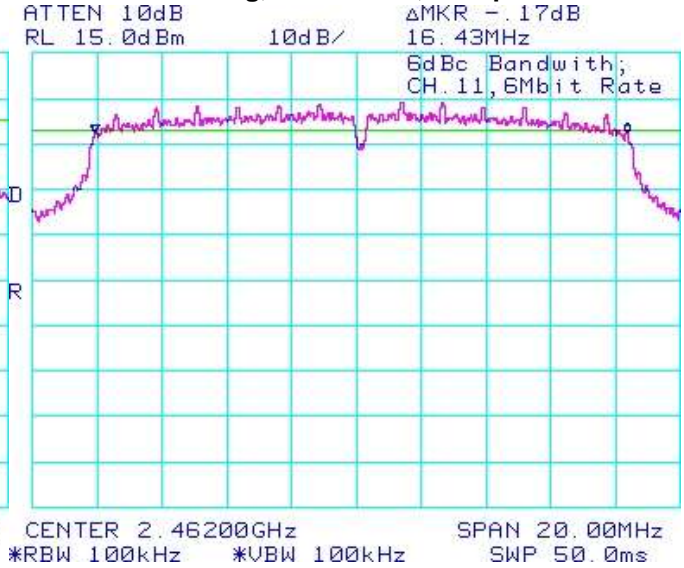

Figure 4-7: 6 dB Bandwidth

802.11n, Channel 1, MCS 0

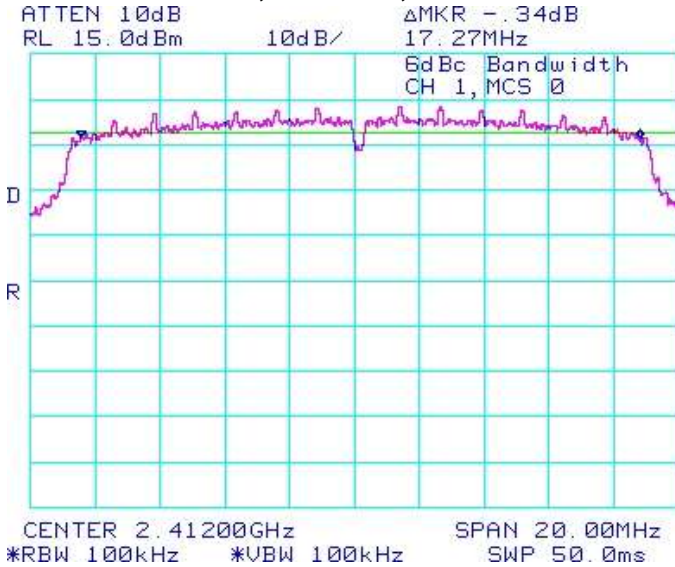

Figure 4-8: 6 dB Bandwidth

802.11n, Channel 6, MCS 0



APPENDIX 4
Test Report No.
 RTS-2604-1106-132B

Dates of Test
 May 04 to 05, June 08 to July 07, 2011

FCC ID: L6ARDR60CW **IC:** 2503A-RDR60CW
FCC ID: L6ARDZ20CW **IC:** 2503A-RDZ20CW

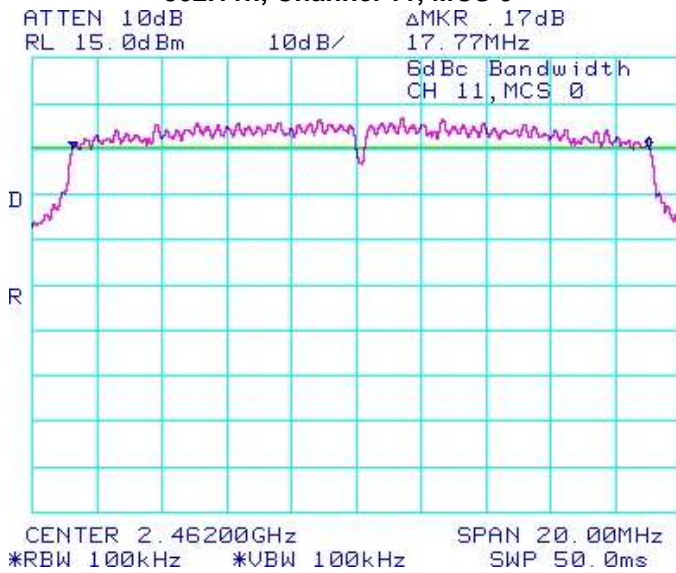
Figure 4-9: 6 dB Bandwidth
802.11n, Channel 11, MCS 0

APPENDIX 4
Test Report No.
 RTS-2604-1106-132B

Dates of Test
 May 04 to 05, June 08 to July 07, 2011

FCC ID: L6ARDR60CW **IC:** 2503A-RDR60CW
FCC ID: L6ARDZ20CW **IC:** 2503A-RDZ20CW

802.11b/g/n RF Conducted Emission Test Results cont'd
Maximum Conducted Output Power

The EUT met the requirements of the maximum conducted output power of class 2 as per 47 CFR 15.247(b) (3) and RSS-210. Channels 1, 6 and 11 were measured at 1 Mbps, 5.5 Mbps, and 11 Mbps each for 802.11b mode, 6 Mbps, 24 Mbps, and 54 Mbps each for 802.11g mode, and MCS 0, 4 and 7 for 802.11n mode using an Agilent power meter, model N1911A with model N1921A power sensor. A reference offset of 18.4 dB was applied to the power meter reference level for the coaxial cable loss and attenuators in the test circuit.

Channel	Data Rate	Class 2 Limit (W)	Measured Level (dBm)	Measured Level (mW)
1	1 Mbps	< 1.00	18.62	72.78
	5.5 Mbps	< 1.00	18.60	72.44
	11 Mbps	< 1.00	18.61	72.61
	6 Mbps	< 1.00	14.47	27.99
	24 Mbps	< 1.00	14.42	27.67
	54 Mbps	< 1.00	12.90	19.50
	MCS 0	< 1.00	14.32	27.04
	MCS 4	< 1.00	14.43	27.73
	MCS 7	< 1.00	11.73	14.89
6	1 Mbps	< 1.00	18.30	67.61
	5.5 Mbps	< 1.00	18.20	66.07
	11 Mbps	< 1.00	18.25	66.83
	6 Mbps	< 1.00	17.41	55.08
	24 Mbps	< 1.00	15.05	31.99
	54 Mbps	< 1.00	13.50	22.39
	MCS 0	< 1.00	17.33	54.08
	MCS 4	< 1.00	14.96	31.33
	MCS 7	< 1.00	12.20	16.60

**APPENDIX 4****Test Report No.**
RTS-2604-1106-132B**Dates of Test**
May 04 to 05, June 08 to July 07, 2011**FCC ID:** L6ARDR60CW **IC:** 2503A-RDR60CW
FCC ID: L6ARDZ20CW **IC:** 2503A-RDZ20CW802.11b/g/n RF Conducted Emission Test Results cont'd

Channel	Data Rate	Class 2 Limit (W)	Measured Level (dBm)	Measured Level (mW)
11	1 Mbps	< 1.00	19.62	91.62
	5.5 Mbps	< 1.00	19.61	91.41
	11 Mbps	< 1.00	19.55	90.16
	6 Mbps	< 1.00	15.45	35.08
	24 Mbps	< 1.00	15.50	35.48
	54 Mbps	< 1.00	13.90	24.55
	MCS 0	< 1.00	15.35	34.28
	MCS 4	< 1.00	15.40	34.67
	MCS 7	< 1.00	12.62	18.28

APPENDIX 4
Test Report No.
 RTS-2604-1106-132B

Dates of Test
 May 04 to 05, June 08 to July 07, 2011

FCC ID: L6ARDR60CW **IC:** 2503A-RDR60CW
FCC ID: L6ARDZ20CW **IC:** 2503A-RDZ20CW

802.11b/g/n RF Conducted Emission Test Results cont'd
Band Edge Compliance

The EUT met the requirements of the band edge compliance as per 47 CFR 15.247(c) and RSS-210. Channels 1 and 11 were measured at 1 Mbps, 5.5 Mbps, and 11 Mbps each for 802.11b mode, 6 Mbps, 24 Mbps, and 54 Mbps each for 802.11g mode, and MCS 0, 4 and 7 for 802.11n mode.

Channel	Data Rate	Limit (dBc)	Measured Level (dBc)	Margin (dBc)
1	1 Mbps	< -20	-40.83	-20.83
	5.5 Mbps	< -20	-42.50	-22.50
	11 Mbps	< -20	-42.33	-22.33
	6 Mbps	< -20	-27.50	-7.50
	24 Mbps	< -20	-29.67	-9.67
	54 Mbps	< -20	-30.50	-10.50
	MCS 0	< -20	-26.16	-6.16
	MCS 4	< -20	-28.50	-8.50
	MCS 7	< -20	-28.50	-8.50
11	1 Mbps	< -20	-51.00	-31.00
	5.5 Mbps	< -20	-53.00	-33.00
	11 Mbps	< -20	-52.83	-32.83
	6 Mbps	< -20	-40.17	-20.17
	24 Mbps	< -20	-43.66	-23.66
	54 Mbps	< -20	-46.33	-26.33
	MCS 0	< -20	-37.33	-17.33
	MCS 4	< -20	-42.16	-22.16
	MCS 7	< -20	-49.00	-29.00

See figures 4-10 to 4-15 for the plots of the band edge compliance measurements for Channels 1 and 11, at 1 Mbps each for 802.11b mode, 6 Mbps each for 802.11g mode, and MCS 0 each for 802.11n mode.

Test Report No.
RTS-2604-1106-132B

Dates of Test
May 04 to 05, June 08 to July 07, 2011

FCC ID: L6ARDR60CW **IC:** 2503A-RDR60CW
FCC ID: L6ARDZ20CW **IC:** 2503A-RDZ20CW

802.11b/g/n RF Conducted Emission Test Results cont'd

Figure 4-10: Band Edge Compliance

802.11b, Channel 1, 1 Mbps

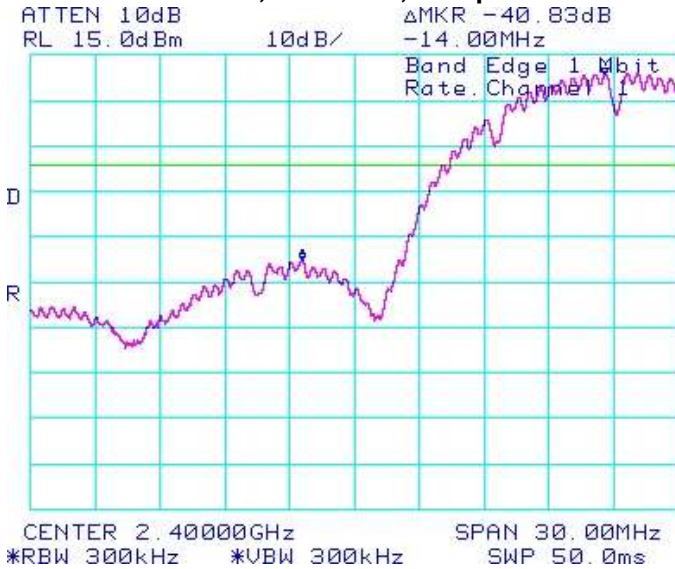

Figure 4-11: Band Edge Compliance

802.11b, Channel 11, 1 Mbps



Figure 4-12: Band Edge Compliance

802.11g, Channel 1, 6 Mbps

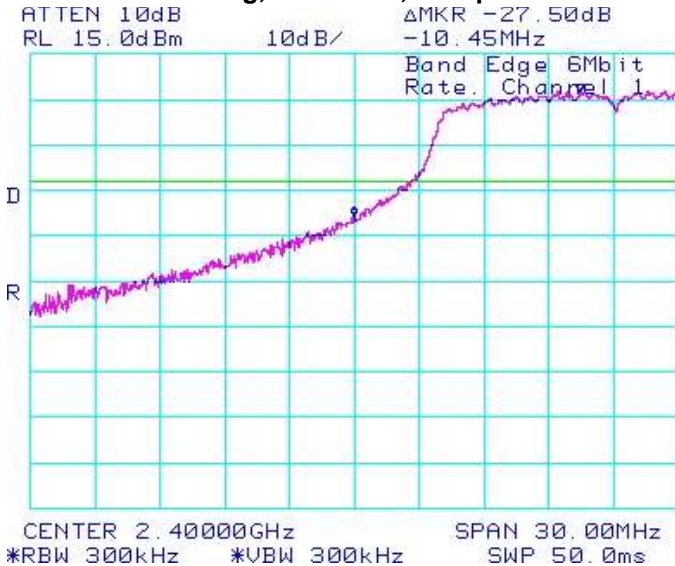

Figure 4-13: Band Edge Compliance

802.11g, Channel 11, 6 Mbps



APPENDIX 4
Test Report No.
 RTS-2604-1106-132B

Dates of Test
 May 04 to 05, June 08 to July 07, 2011

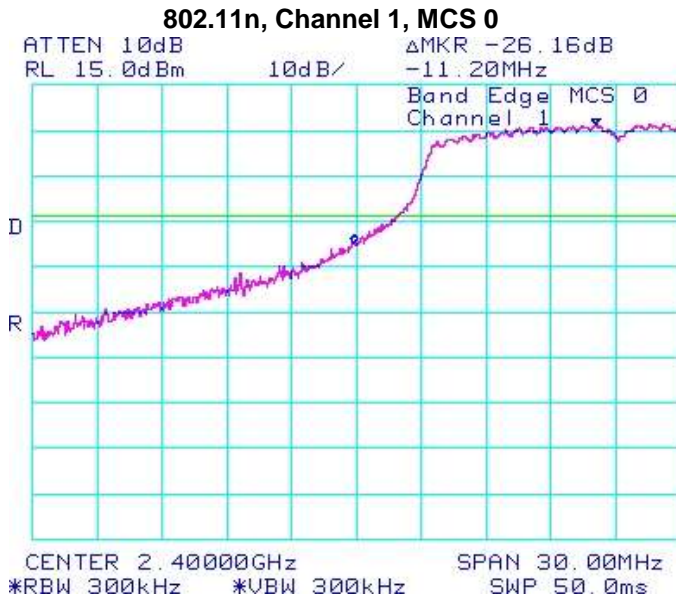
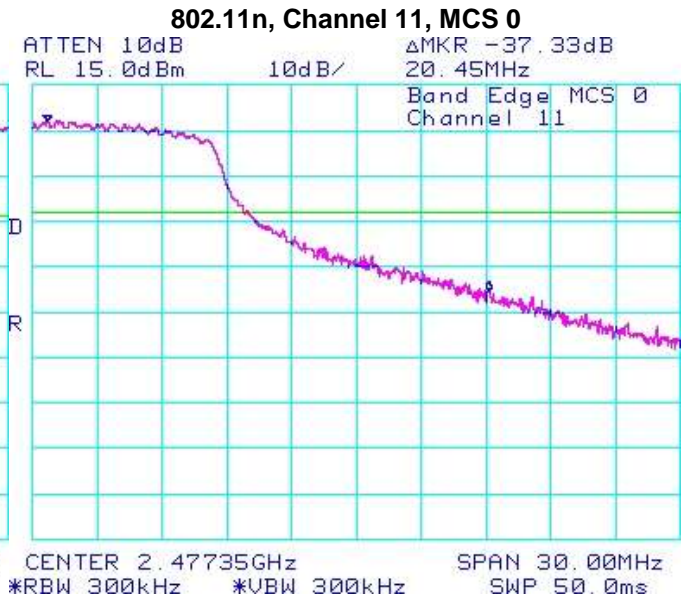
FCC ID: L6ARDR60CW IC: 2503A-RDR60CW
FCC ID: L6ARDZ20CW IC: 2503A-RDZ20CW
802.11b/g/n RF Conducted Emission Test Results cont'd
Figure 4-14: Band Edge Compliance

Figure 4-15: Band Edge Compliance

APPENDIX 4

Test Report No. RTS-2604-1106-132B	Dates of Test May 04 to 05, June 08 to July 07, 2011	FCC ID: L6ARDR60CW IC: 2503A-RDR60CW FCC ID: L6ARDZ20CW IC: 2503A-RDZ20CW
--	--	--

802.11b/g/n RF Conducted Emission Test Results cont'd
Peak Power Spectral Density

The EUT met the requirements of the peak power spectral density as per 47 CFR 15.247(d) and RSS-210. Channels 1, 6 and 11 were measured at 1 Mbps, 5.5 Mbps, and 11 Mbps each for 802.11b mode, 6 Mbps, 24 Mbps, and 54 Mbps each for 802.11g mode, and MCS 0, 4, and 7 for 802.11n mode.

Channel	Data Rate	Limit (dBm)	Measured Level (dBm)	Margin (dBm)
1	1 Mbps	< 8.00	-1.83	-9.83
	5.5 Mbps	< 8.00	-3.17	-11.17
	11 Mbps	< 8.00	-3.00	-11.00
	6 Mbps	< 8.00	-9.33	-17.33
	24 Mbps	< 8.00	-12.03	-20.03
	54 Mbps	< 8.00	-11.17	-19.17
	MCS 0	< 8.00	-9.00	-17.00
	MCS 4	< 8.00	-9.83	-17.83
	MCS 7	< 8.00	-12.33	-20.33
6	1 Mbps	< 8.00	-2.67	-10.67
	5.5 Mbps	< 8.00	-4.33	-12.33
	11 Mbps	< 8.00	-3.00	-11.00
	6 Mbps	< 8.00	-6.50	-14.50
	24 Mbps	< 8.00	-8.50	-16.50
	54 Mbps	< 8.00	-10.50	-18.50
	MCS 0	< 8.00	-7.33	-15.33
	MCS 4	< 8.00	-8.83	-16.83
	MCS 7	< 8.00	-11.33	-19.33

**APPENDIX 4****Test Report No.**
RTS-2604-1106-132B**Dates of Test**
May 04 to 05, June 08 to July 07, 2011**FCC ID:** L6ARDR60CW **IC:** 2503A-RDR60CW
FCC ID: L6ARDZ20CW **IC:** 2503A-RDZ20CW802.11b/g/n RF Conducted Emission Test Results cont'd

Channel	Data Rate	Limit (dBm)	Measured Level (dBm)	Margin (dBm)
11	1 Mbps	< 8.00	-1.17	-9.17
	5.5 Mbps	< 8.00	-2.83	-10.83
	11 Mbps	< 8.00	-2.17	-10.17
	6 Mbps	< 8.00	-8.33	-16.33
	24 Mbps	< 8.00	-9.33	-17.33
	54 Mbps	< 8.00	-10.00	-18.00
	MCS 0	< 8.00	-7.67	-15.67
	MCS 4	< 8.00	-8.67	-16.67
MCS 7	< 8.00	-11.17	-19.17	

	EMI Test Report for the BlackBerry® smartphone Model RDR61CW, RDZ21CW	
	APPENDIX 4	
Test Report No. RTS-2604-1106-132B	Dates of Test May 04 to 05, June 08 to July 07, 2011	FCC ID: L6ARDR60CW IC: 2503A-RDR60CW FCC ID: L6ARDZ20CW IC: 2503A-RDZ20CW

802.11b/g/n RF Conducted Emission Test Results cont'd

See figures 4-16 to 4-24 for the plots of the peak power spectral density for Channels 1, 6 and 11, at 1 Mbps each for 802.11b mode, 6 Mbps each for 802.11g mode, and MCS 0 for 802.11n mode.

Figure 4-16: Peak Power Spectral Density

802.11b, Channel 1, 1 Mbps

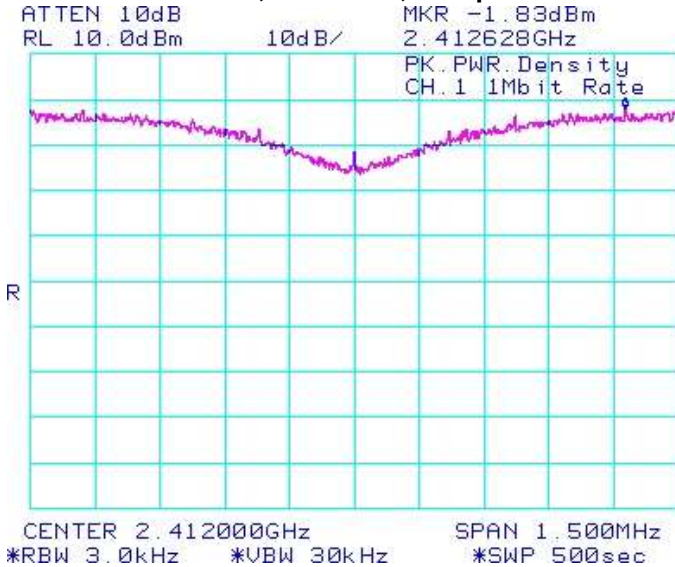

Figure 4-17: Peak Power Spectral Density

802.11b, Channel 6, 1 Mbps

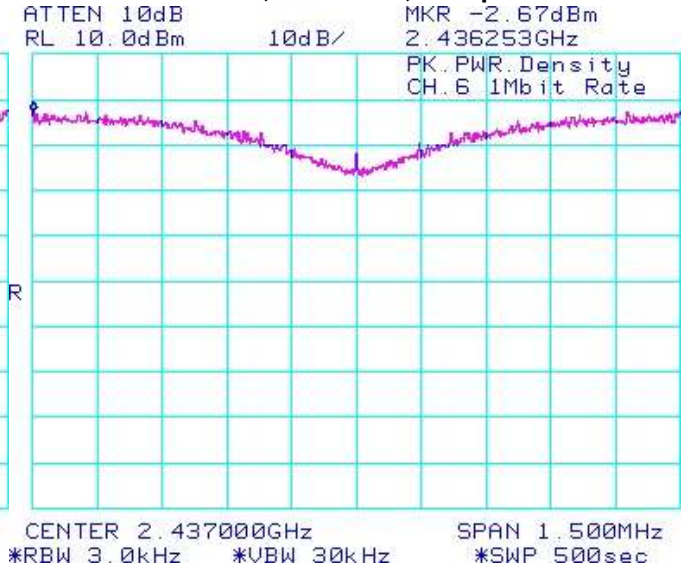
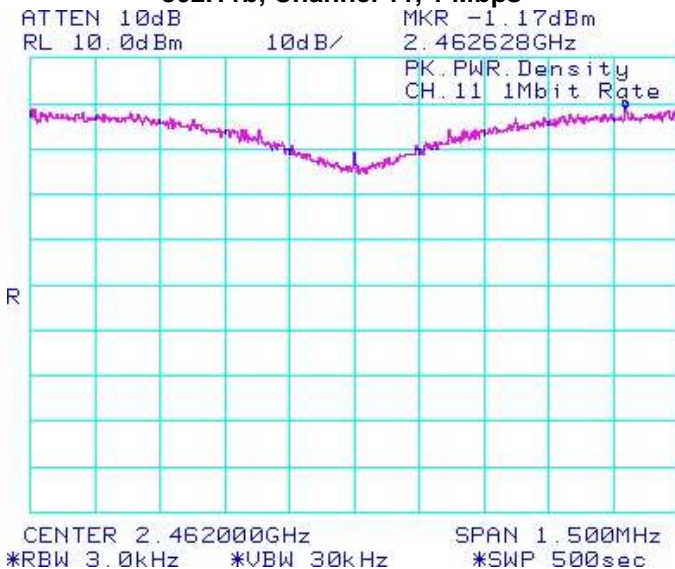

Figure 4-18: Peak Power Spectral Density

802.11b, Channel 11, 1 Mbps



Test Report No. RTS-2604-1106-132B	Dates of Test May 04 to 05, June 08 to July 07, 2011	FCC ID: L6ARDR60CW IC: 2503A-RDR60CW FCC ID: L6ARDZ20CW IC: 2503A-RDZ20CW
--	--	--

802.11b/g/n RF Conducted Emission Test Results cont'd

Figure 4-19: Peak Power Spectral Density

802.11g, Channel 1, 6 Mbps

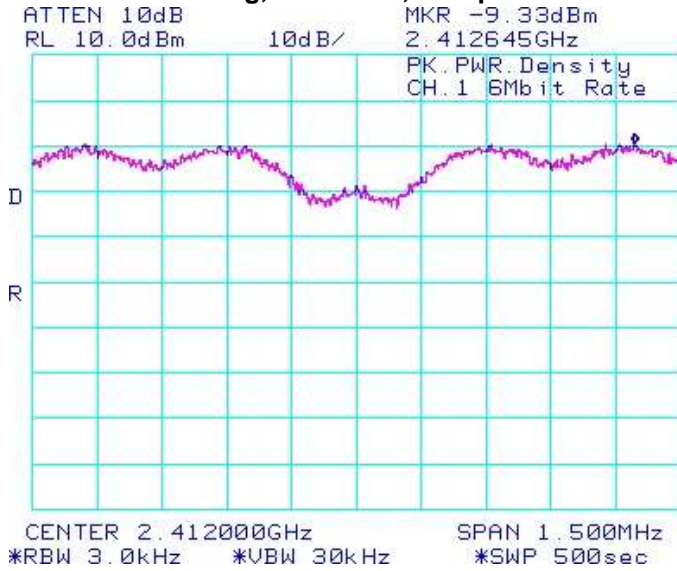

Figure 4-20: Peak Power Spectral Density

802.11g, Channel 6, 6 Mbps

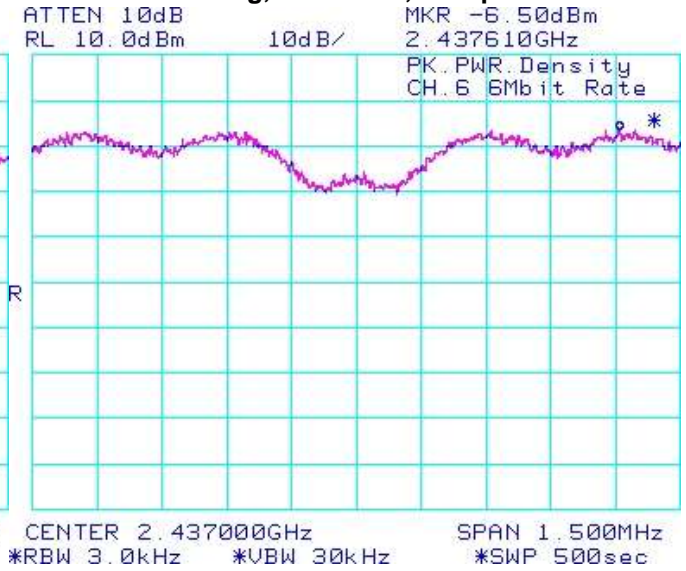
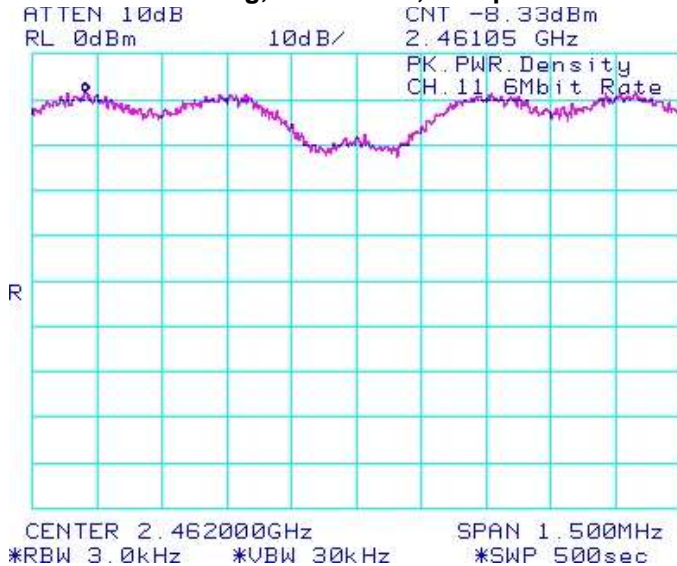

Figure 4-21: Peak Power Spectral Density

802.11g, Channel 11, 6 Mbps



Test Report No.
RTS-2604-1106-132B

Dates of Test
May 04 to 05, June 08 to July 07, 2011

FCC ID: L6ARDR60CW **IC:** 2503A-RDR60CW
FCC ID: L6ARDZ20CW **IC:** 2503A-RDZ20CW

802.11b/g/n RF Conducted Emission Test Results cont'd

Figure 4-22: Peak Power Spectral Density

802.11n, Channel 1, MCS 0

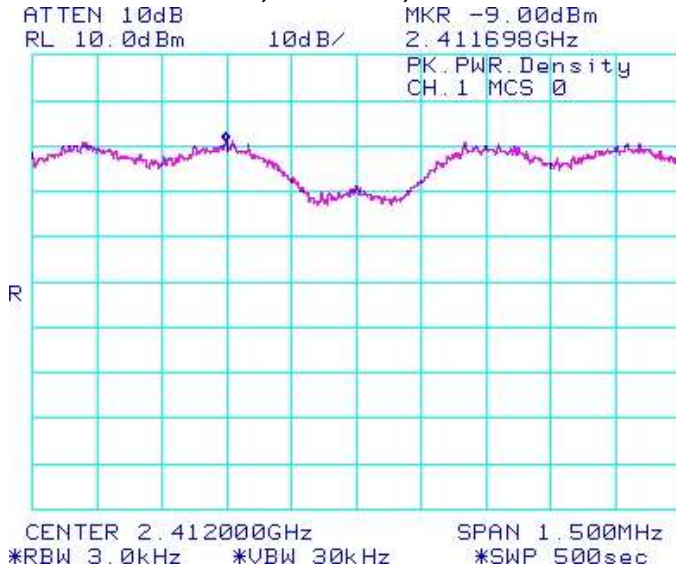

Figure 4-23: Peak Power Spectral Density

802.11n, Channel 6, MCS 0

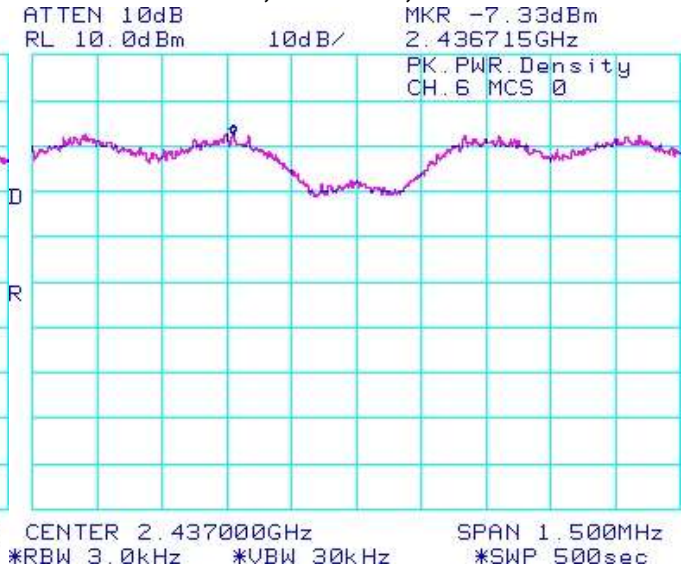
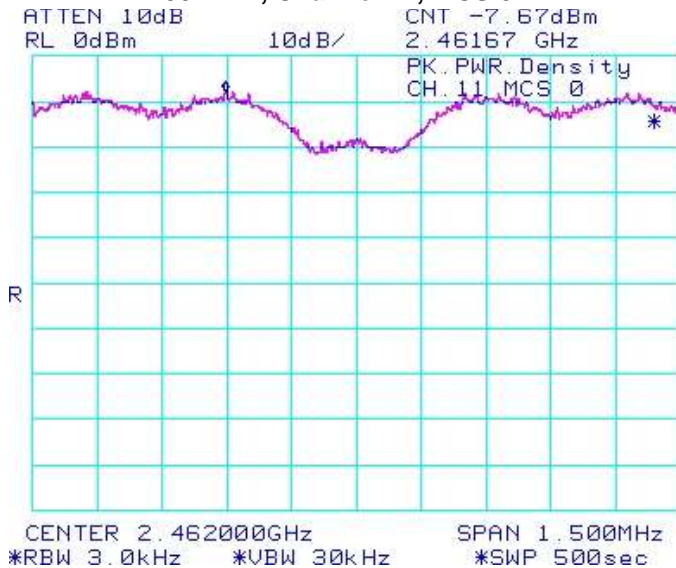

Figure 4-24: Peak Power Spectral Density

802.11n, Channel 11, MCS 0



APPENDIX 4
Test Report No.
 RTS-2604-1106-132B

Dates of Test
 May 04 to 05, June 08 to July 07, 2011

FCC ID: L6ARDR60CW **IC:** 2503A-RDR60CW
FCC ID: L6ARDZ20CW **IC:** 2503A-RDZ20CW

802.11b/g/n RF Conducted Emission Test Results cont'd
Spurious RF Conducted Emissions

The EUT met the requirements of the spurious RF conducted emissions as per 47 CFR 15.247(c) and RSS-210. Channels 1, 6 and 11 were measured at 1 Mbps, 5.5 Mbps, and 11 Mbps each for 802.11b mode, 6 Mbps, 24 Mbps, and 54 Mbps each for 802.11g mode, and MCS 0, 4, and 7 for 802.11n mode. Peak power was measured using an Agilent power meter, model N1911A with model N1921A power sensor. A reference offset of 18.4 dB was applied to the power meter reference level for the coaxial cable loss and attenuators in the test circuit.

Channel	Data Rate	Power (dBm)	Max. Measured Level (dBm)	Max. Measured Level from Carrier (dBc)	Limit (dBc)
1	1 Mbps	18.62	-49.50	-68.12	-20
	5.5 Mbps	18.60	-50.17	-68.77	-20
	11 Mbps	18.61	-50.50	-69.11	-20
	6 Mbps	14.47	-47.50	-61.97	-20
	24 Mbps	14.42	-43.50	-57.92	-20
	54 Mbps	12.90	-48.83	-61.73	-20
	MCS 0	14.32	-45.33	-59.65	-20
	MCS 4	14.43	-46.00	-60.43	-20
	MCS 7	11.73	-48.67	-60.40	-20
6	1 Mbps	18.30	-43.17	-61.47	-20
	5.5 Mbps	18.20	-44.83	-63.03	-20
	11 Mbps	18.25	-42.17	-60.42	-20
	6 Mbps	17.41	-45.38	-62.79	-20
	24 Mbps	15.05	-47.67	-62.72	-20
	54 Mbps	13.50	-45.00	-58.50	-20
	MCS 0	17.33	-45.67	-63.00	-20
	MCS 4	14.96	-44.00	-58.96	-20
	MCS 7	12.20	-47.50	-59.70	-20

**APPENDIX 4****Test Report No.**
RTS-2604-1106-132B**Dates of Test**
May 04 to 05, June 08 to July 07, 2011**FCC ID:** L6ARDR60CW **IC:** 2503A-RDR60CW
FCC ID: L6ARDZ20CW **IC:** 2503A-RDZ20CW802.11b/g/n RF Conducted Emission Test Results cont'd

Channel	Data Rate	Power (dBm)	Max. Measured Level (dBm)	Max. Measured Level from Carrier (dBc)	Limit (dBc)
11	1 Mbps	19.62	-42.17	-61.79	-20
	5.5 Mbps	19.61	-48.00	-67.61	-20
	11 Mbps	19.55	-44.50	-64.05	-20
	6 Mbps	15.45	-46.00	-61.45	-20
	24 Mbps	15.50	-43.83	-59.33	-20
	54 Mbps	13.90	-46.67	-60.57	-20
	MCS 0	15.35	-46.33	-61.68	-20
	MCS 4	15.40	-44.83	-60.23	-20
	MCS 7	12.62	-48.50	-61.12	-20

The emissions were in the noise floor.

See figures 4-25 to 4-33 for the plots of the spurious RF conducted emissions for Channels 1, 6 and 11, at 1 Mbps each for 802.11b mode, 6 Mbps each for 802.11g mode, and MCS 0 each for 802.11n mode.

APPENDIX 4

Test Report No. RTS-2604-1106-132B	Dates of Test May 04 to 05, June 08 to July 07, 2011	FCC ID: L6ARDR60CW IC: 2503A-RDR60CW FCC ID: L6ARDZ20CW IC: 2503A-RDZ20CW
--	--	--

802.11b/g/n RF Conducted Emission Test Results cont'd

Figure 4-25: Spurious Conducted RF Emissions

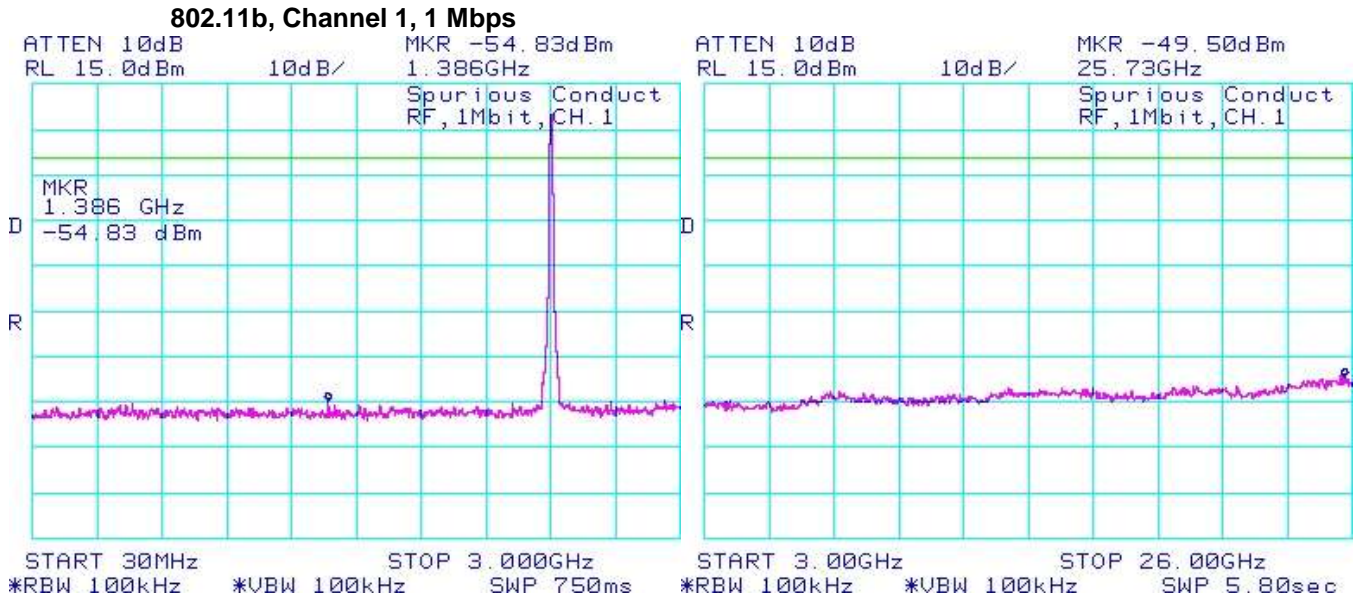
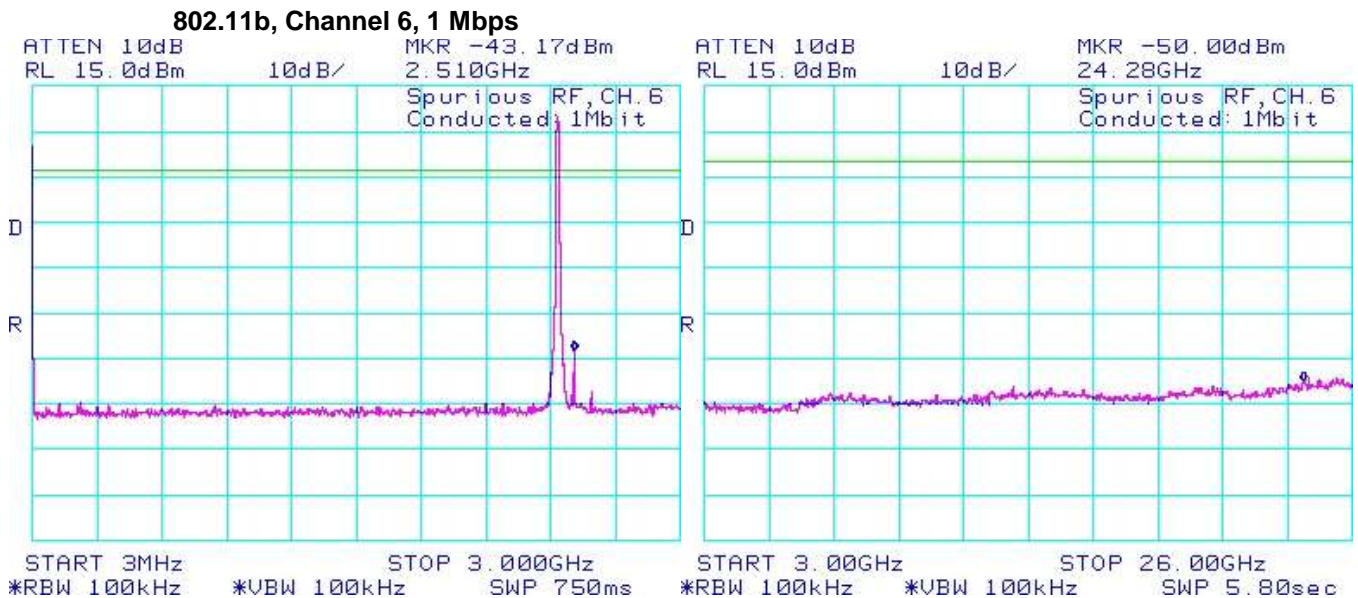

Figure 4-26 : Spurious Conducted RF Emissions



APPENDIX 4

Test Report No.
RTS-2604-1106-132B

Dates of Test
May 04 to 05, June 08 to July 07, 2011

FCC ID: L6ARDR60CW **IC:** 2503A-RDR60CW
FCC ID: L6ARDZ20CW **IC:** 2503A-RDZ20CW

802.11b/g/n RF Conducted Emission Test Results cont'd

Figure 4-27: Spurious Conducted RF Emissions

802.11b, Channel 11, 1 Mbps

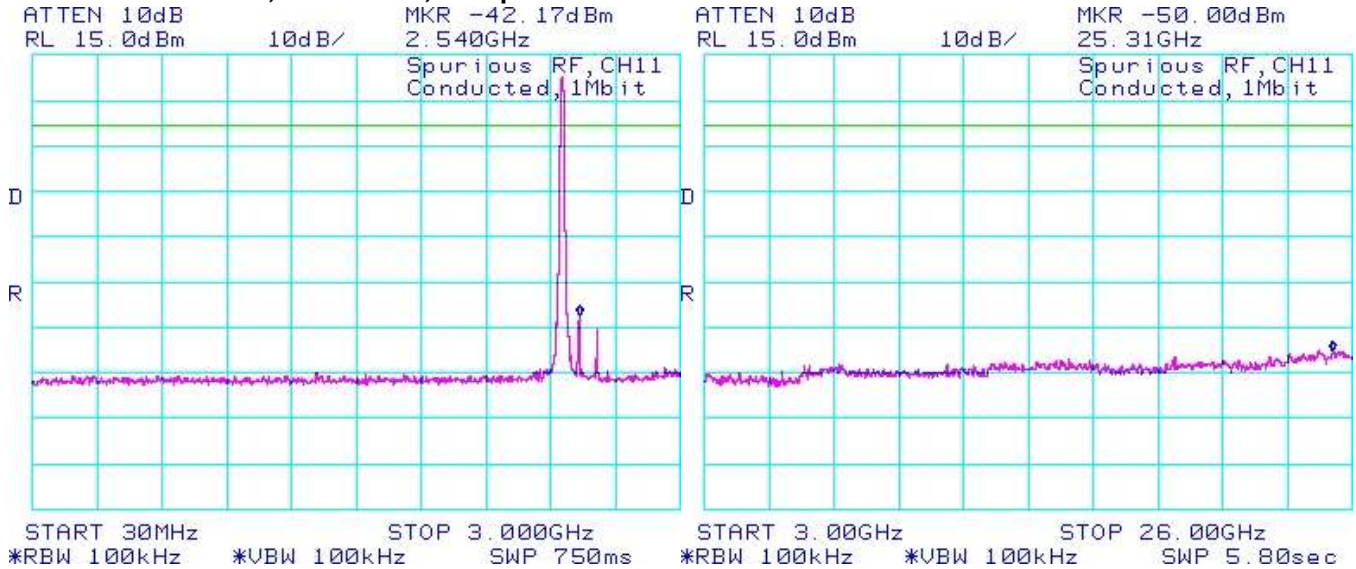
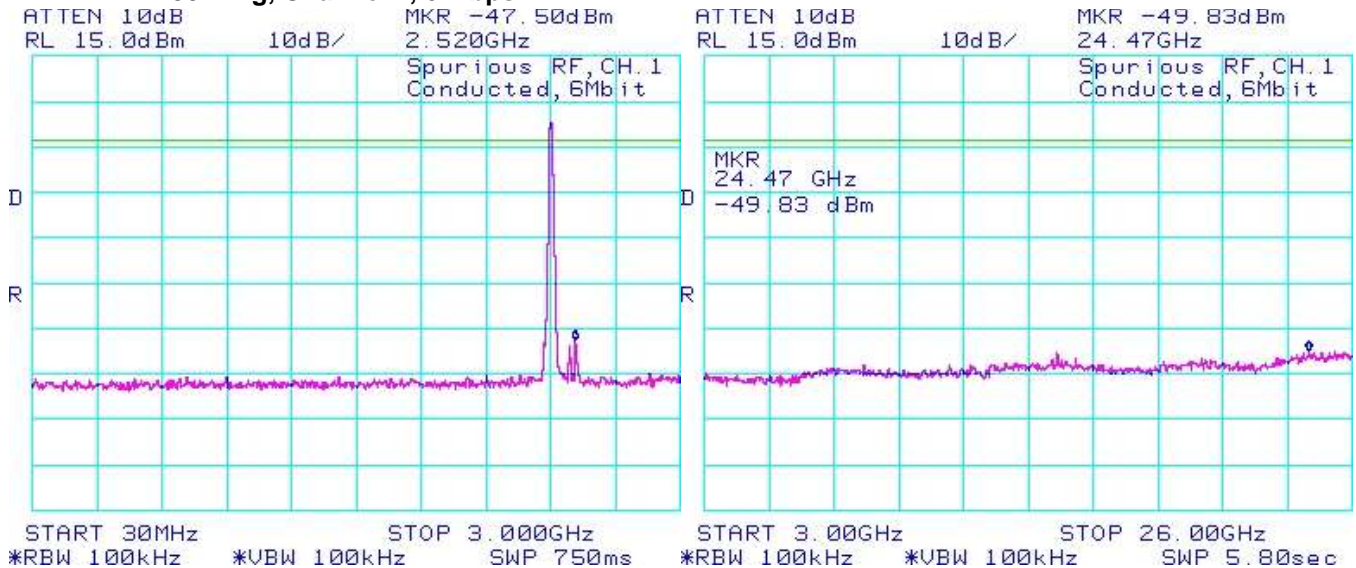

Figure 4-28: Spurious Conducted RF Emissions

802.11g, Channel 1, 6 Mbps



Test Report No. RTS-2604-1106-132B	Dates of Test May 04 to 05, June 08 to July 07, 2011	FCC ID: L6ARDR60CW IC: 2503A-RDR60CW FCC ID: L6ARDZ20CW IC: 2503A-RDZ20CW
--	--	--

802.11b/g/n RF Conducted Emission Test Results cont'd

**Figure 4-29: Spurious Conducted RF Emissions
802.11g, Channel 6, 6 Mbps**

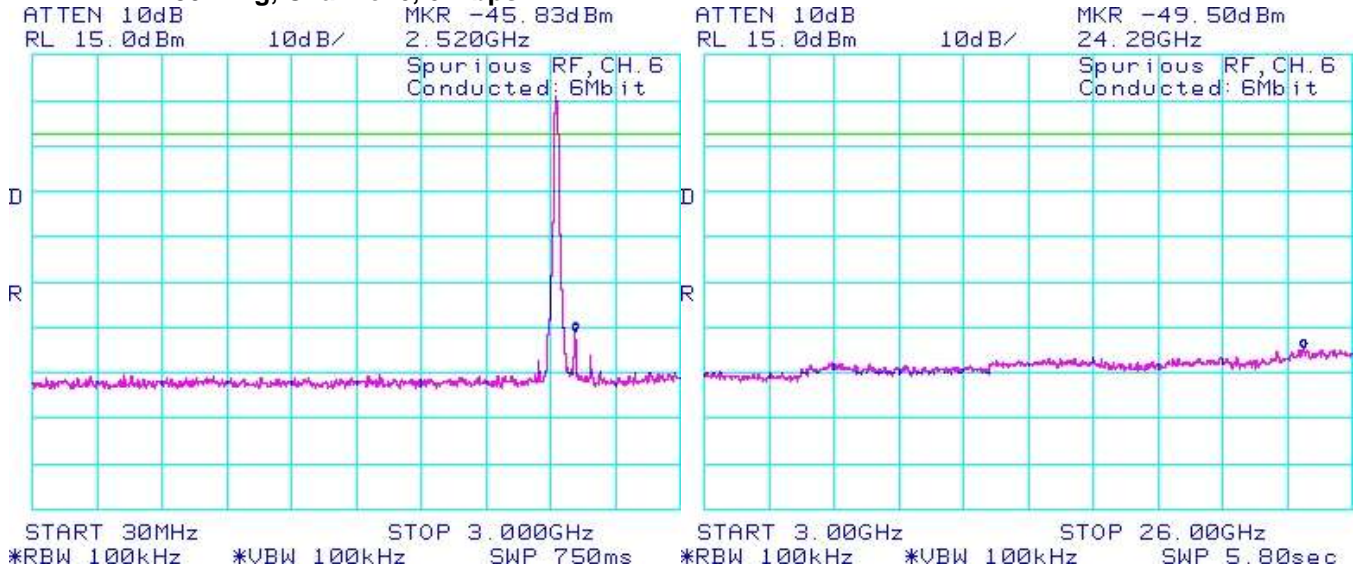

**Figure 4-30: Spurious Conducted RF Emissions
802.11g, Channel 11, 6 Mbps**

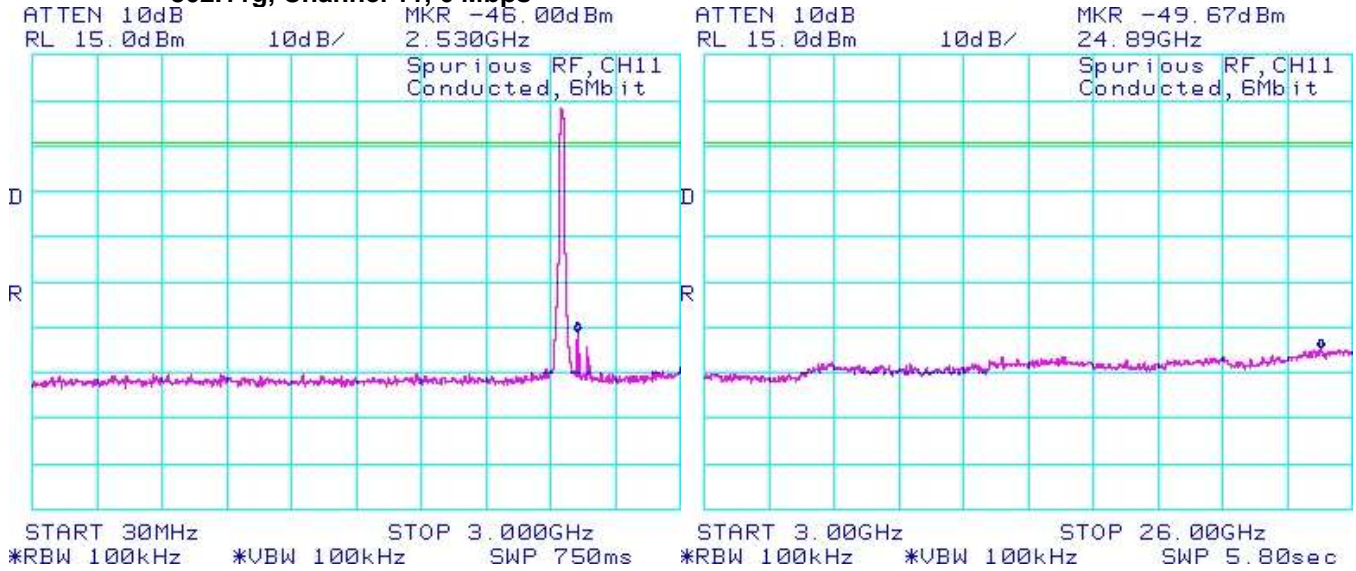

Test Report No. RTS-2604-1106-132B	Dates of Test May 04 to 05, June 08 to July 07, 2011	FCC ID: L6ARDR60CW IC: 2503A-RDR60CW FCC ID: L6ARDZ20CW IC: 2503A-RDZ20CW
--	--	--

802.11b/g/n RF Conducted Emission Test Results cont'd

**Figure 4-31: Spurious Conducted RF Emissions
802.11n, Channel 1, MCS 0**

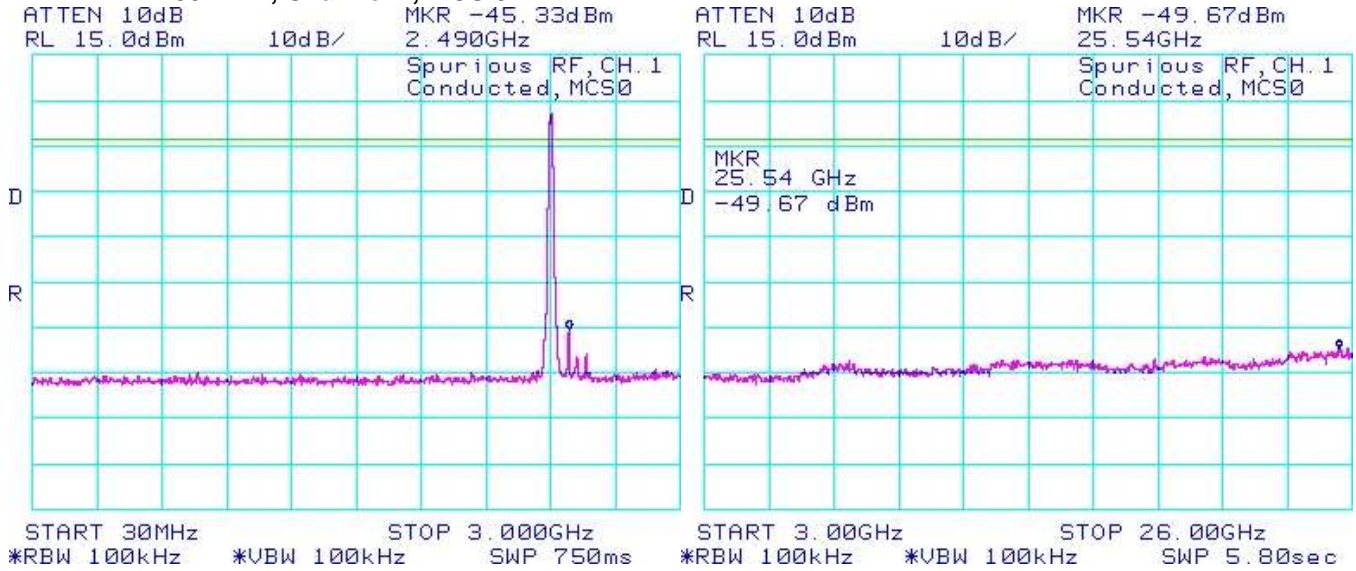

**Figure 4-32: Spurious Conducted RF Emissions
802.11n, Channel 6, MCS 0**

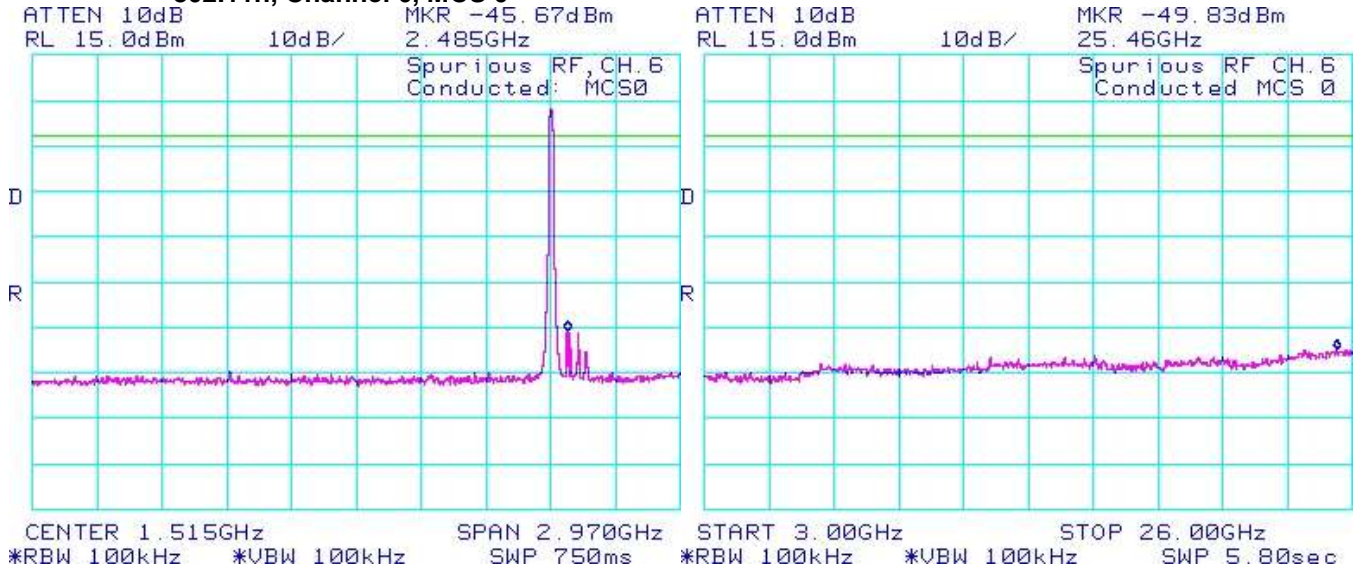

Test Report No. RTS-2604-1106-132B	Dates of Test May 04 to 05, June 08 to July 07, 2011	FCC ID: L6ARDR60CW IC: 2503A-RDR60CW FCC ID: L6ARDZ20CW IC: 2503A-RDZ20CW
--	--	--

802.11b/g/n RF Conducted Emission Test Results cont'd

**Figure 4-33: Spurious Conducted RF Emissions
 802.11n, Channel 11, MCS 0**

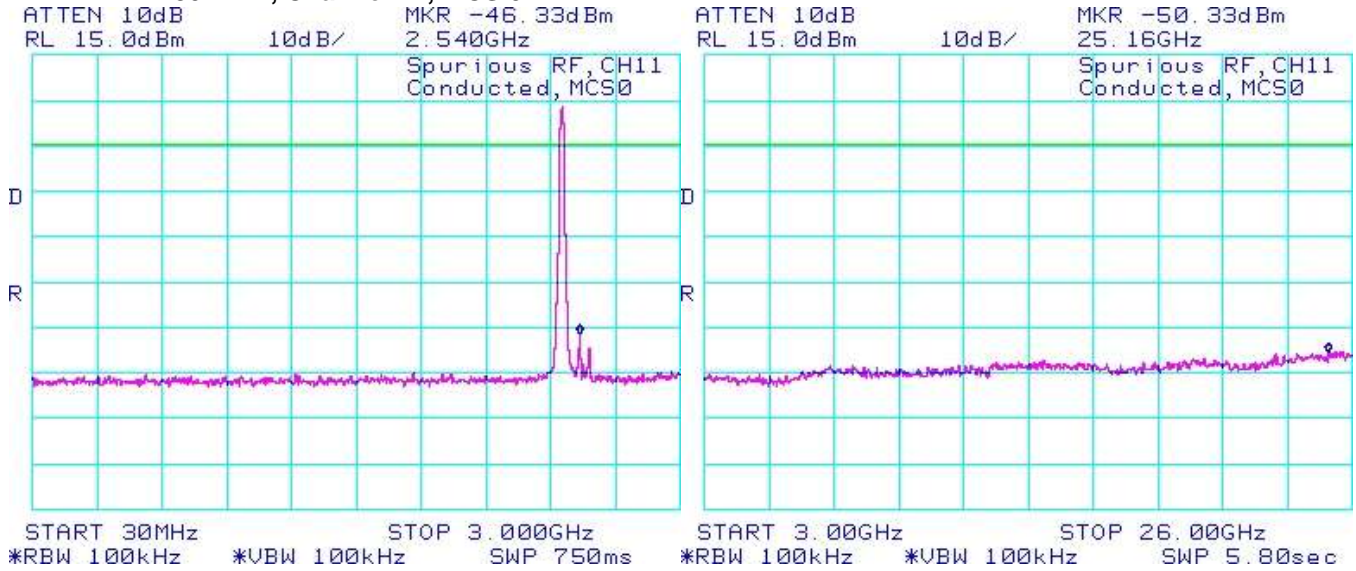

	EMI Test Report for the BlackBerry® smartphone Model RDR61CW, RDZ21CW APPENDIX 5	
Test Report No. RTS-2604-1106-132B	Dates of Test May 04 to 05, June 08 to July 07, 2011	FCC ID: L6ARDR60CW IC: 2503A-RDR60CW FCC ID: L6ARDZ20CW IC: 2503A-RDZ20CW

APPENDIX 5 – NEAR FIELD COMMUNICATIONS TEST DATA/PLOTS

	EMI Test Report for the BlackBerry® smartphone Model RDR61CW, RDZ21CW	
	APPENDIX 5	
Test Report No. RTS-2604-1106-132B	Dates of Test May 04 to 05, June 08 to July 07, 2011	FCC ID: L6ARDR60CW IC: 2503A-RDR60CW FCC ID: L6ARDZ20CW IC: 2503A-RDZ20CW

Near Field Communications (NFC) Test Results cont'd
Radiated Emissions

The following test configurations were measured for model RDR61CW:

Date of Test: July 04, 2011

Measurements were performed by Quan Ma.

The environmental test conditions were: Temperature: 24 °C
Relative Humidity: 33 %

The test distance was 3.0 metres with a EUT height of 0.8 metres, and sweep frequency of 10 kHz to 1 GHz.

The BlackBerry® smartphone was in vertical position.

The frequency sweep measurements were performed in Near Field Communications Tx mode at 13.56 MHz.

Frequency (MHz)	Reading (PK) (dBµV)	Correction Factor (dB)	Corrected Reading (PK) (dBµV/m)	Limit (dBµV/m)	Test Margin (dB)
13.56	28.54	22.24	50.78	124.00	-73.22

All other emissions had a test margin of greater than 25.0 dB.

**APPENDIX 5****Test Report No.**
RTS-2604-1106-132B**Dates of Test**
May 04 to 05, June 08 to July 07, 2011**FCC ID:** L6ARDR60CW **IC:** 2503A-RDR60CW
FCC ID: L6ARDZ20CW **IC:** 2503A-RDZ20CWNear Field Communications (NFC) Test Results cont'dFrequency Stability cont'd

Test Temperature (Celsius)	Nominal Freq. (MHz)	Measured Freq. (MHz)	Input Voltage (Volts)	Max Freq Error (Hz)	% Deviation (Limit .01%)	PPM
40	13.56	13.560542	3.6	542	0.00400	39.9705
40	13.56	13.560542	3.7	542	0.00400	39.9705
40	13.56	13.560542	4.2	542	0.00400	39.9705
50	13.56	13.560442	3.6	442	0.00326	32.5959
50	13.56	13.560442	3.7	442	0.00326	32.5959
50	13.56	13.560442	4.2	442	0.00326	32.5959
60	13.56	13.560108	3.6	108	0.00080	7.9646
60	13.56	13.560108	3.7	108	0.00080	7.9646
60	13.56	13.560108	4.2	108	0.00080	7.9646