

EMI Test Report

Tested in accordance with
Federal Communications Commission (FCC)
Personal Communications Services
CFR 47 Parts 2, 22, 24 and 90
&
Industry Canada (IC) RSS- Gen, 132 and 133



A division of Research In Motion Limited

REPORT NO: RTS-2604-1106-131A

PRODUCT MODEL NO:	RDR61CW, RDS41CW
TYPE NAME:	BlackBerry® smartphone
FCC ID:	L6ARDR60CW, L6ARDS40CW
IC:	2503A-RDR60CW, 2503A-RDS40CW
EMISSION DESIGNATOR (GSM):	247KGXW
EMISSION DESIGNATOR (EDGE):	247KG7W
EMISSION DESIGNATOR (CDMA):	1M29F9W

DATE: 29 June 2011

		EMI Test Report for the BlackBerry® smartphone Model RDR61CW,RDS41CW
Test Report No. RTS-2604-1106-131A	Dates of Test May 25, June 2 to June 28, 2011	FCC ID: L6ARDR60CW, L6ARDS40CW IC: 2503A-RDR60CW, 2503A-RDS40CW

Statement of Performance:

The BlackBerry® smartphone, model RDR61CW, part number CER-41454-001 Rev 5 and accessories performs within the requirements of the test standards when configured and operated per RIM’s instructions.

The BlackBerry® smartphone, model RDS41CW, part number CER-30958-001 Rev 2 and accessories performs within the requirements of the test standards when configured and operated per RIM’s instructions.

Declaration:

We hereby certify that:
The test data reported herein is an accurate record of the performance of the sample(s) tested. The test results are valid for the tested unit (s) only. The test equipment used was suitable for the tests performed and within manufacturer’s published specifications and operating parameters. The test methods were consistent with the methods described in the relevant standards.

Documented by:



Nielven Olis
Regulatory Compliance Associate
Date: June 29, 2011

Reviewed by:

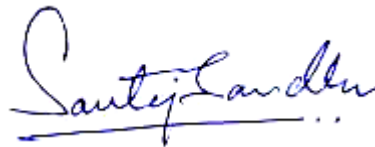

Savtej S. Sandhu
Regulatory Compliance Specialist
Date: July 14, 2011

Reviewed and Approved by:



Masud S. Attayi, P.Eng.
Manager, Regulatory Compliance
Date: July 14, 2011



Test Report No.
RTS-2604-1106-131A

Dates of Test
May 25, June 2 to June 28, 2011

FCC ID: L6ARDR60CW, L6ARDS40CW
IC: 2503A-RDR60CW, 2503A-RDS40CW

Table of Contents

A) Scope5

B) Associated Documents.....5

C) Product Identification5

D) Support Equipment Used for the Testing of the EUT7

E) Test Voltage7

F) Test Results Chart.....8

G) Summary of Results9

H) Compliance Test Equipment Used16

APPENDIX 1A – GSM CONDUCTED RF EMISSIONS TEST DATA/PLOTS.....18

APPENDIX 1B – CDMA CONDUCTED RF EMISSIONS TEST DATA/PLOTS35

APPENDIX 1C – CDMA BC10 CONDUCTED RF EMISSIONS TEST DATA/PLOTS51

APPENDIX 2A – GSM CONDUCTED RF OUTPUT POWER TEST DATA.....57



Test Report No.
RTS-2604-1106-131A

Dates of Test
May 25, June 2 to June 28, 2011

FCC ID: L6ARDR60CW, L6ARDS40CW
IC: 2503A-RDR60CW, 2503A-RDS40CW

APPENDIX 2B – CDMA CONDUCTED RF OUTPUT POWER TEST DATA.....59

APPENDIX 2C – CDMA BC10 CONDUCTED RF OUTPUT POWER TEST DATA61

APPENDIX 3A – GSM FREQUENCY STABILITY TEST DATA63

APPENDIX 3B – CDMA FREQUENCY STABILITY TEST DATA75

APPENDIX 3C – CDMA BC10 FREQUENCY STABILITY TEST DATA.....87

APPENDIX 4A – GSM RADIATED EMISSIONS TEST DATA.....95

APPENDIX 4B – CDMA RADIATED EMISSIONS TEST DATA102

APPENDIX 4C – CDMA BC10 RADIATED EMISSIONS TEST DATA111

		EMI Test Report for the BlackBerry® smartphone Model RDR61CW,RDS41CW
Test Report No. RTS-2604-1106-131A	Dates of Test May 25, June 2 to June 28, 2011	FCC ID: L6ARDR60CW, L6ARDS40CW IC: 2503A-RDR60CW, 2503A-RDS40CW

A) Scope

This report details the results of compliance tests which were performed in accordance to the requirements of:

- FCC CFR 47 Part 2, Oct, 2010
- FCC CFR 47 Part 22, Subpart H, Cellular Radiotelephone Services, Oct., 2010
- FCC CFR 47 Part 24 Subpart E, Broadband PCS, Oct., 2010
- FCC CFR 47 Part 90, Oct, 2010
- Industry Canada, RSS-132 Issue 2, September 2005, Cellular Telephones Employing New Technologies Operating in the Bands 824-849 MHz and 869-894 MHz.
- Industry Canada, RSS-133 Issue 5, February 2009, 2 GHz Personal Communications Services.
- Industry Canada, RSS-GEN Issue 3, December 2010, General Requirements and Information for the Certification of Radiocommunication Equipment

B) Associated Documents

1. RDR61CW_HW_Declaration_CER-41454-001_Rev4.docx
2. RDR61CW_HW_Declaration_CER-41454-001_Rev5.docx
3. RDS41CW_HW_Declaration CER-30958-001_ Rev2.docx
4. MultiSourceDeclaration_RDS41CW_b848.doc
5. BlackBerrySystemSimilarity_RDR61CW_RDS41CW.docx

C) Product Identification

Manufactured by Research In Motion Limited whose headquarters is located at:
295 Phillip Street
Waterloo, Ontario
Canada, N2L 3W8
Phone:519 888 7465
Fax: 519 888 6906

The equipment under test (EUT) was tested at the following locations:

RIM Testing Services EMI test facilities

305 Phillip Street
Waterloo, Ontario
Canada, N2L 3W8
Phone: 519 888 7465
Fax: 519 888 6906

440 Phillip Street
Waterloo, Ontario,
Canada , N2L 5R9
Phone: 519 888 7465
Fax: 519 888 6906

The testing was performed from May 25, June 2 to June 28, 2011.

Test Report No.
 RTS-2604-1106-131A

Dates of Test
 May 25, June 2 to June 28, 2011

FCC ID: L6ARDR60CW, L6ARDS40CW
IC: 2503A-RDR60CW, 2503A-RDS40CW

The sample EUT included:

Sample	Model	CER NUMBER	PIN	Software Information
1	RDR61CW	CER-41454-001 Rev3	32EAF912	V7.0.0.100 (Platorm 5.0.0267) Bundle 848
2	RDR61CW	CER-41454-001 Rev3	32EAFAD3	V7.0.0.100 (Platorm 5.0.0267) Bundle 848
3	RDR61CW	CER-41454-001 Rev4	32EFD957	V7.0.0.100 (Platorm 5.0.0267) Bundle 848
4	RDR61CW	CER-41454-001 Rev4	32EFD941	V7.0.0.100 (Platorm 5.0.0267) Bundle 848
5	RDR61CW	CER-41454-001 Rev4	32EFD945	V7.0.0.100 (Platorm 5.0.0267) Bundle 848
6	RDR61CW	CER-41454-001 Rev5	32F2900E	V7.0.0.100 (Platorm 5.0.0267) Bundle 848
7	RDS41CW	CER-30958-001 Rev2	32EFDB8A	V7.0.0.100 (Platorm 5.0.0267) Bundle 848
8	RDS41CW	CER-30958-001 Rev2	32EFD224	V7.0.0.100 (Platorm 5.0.0267) Bundle 848
9	RDS41CW	CER-30958-001 Rev2	32EFD22F	V7.0.0.100 (Platorm 5.0.0267) Bundle 848
10	RDS41CW	CER-30958-001 Rev1	32E4DC39	V6.1.0.53 (Platorm 5.0.0173) Bundle 522

RF Conducted Emissions testing was performed on sample 2, 4, 6, 9 and 10.
 RF Radiated Emissions testing was performed on samples 1, 3, 5, 7 and 8

Only the characteristics that have been affected by the changes from Model RDR61CW Rev 3 to RDR61CW Rev 5 were retested. For more information see documents:
 RDR61CW_HW_Declaration_CER-41454-001_Rev4.docx and
 RDR61CW_HW_Declaration_CER-41454-001_Rev5.docx

		EMI Test Report for the BlackBerry® smartphone Model RDR61CW,RDS41CW
Test Report No. RTS-2604-1106-131A	Dates of Test May 25, June 2 to June 28, 2011	FCC ID: L6ARDR60CW, L6ARDS40CW IC: 2503A-RDR60CW, 2503A-RDS40CW

Only the characteristics that have been affected by the changes from Model RDS41CW Rev1 and RDS41CW Rev2 were retested if necessary, see document:
RDS41CW_HW_Declaration CER-30958-001_ Rev2.docx

Only the characteristics that have been affected by the changes from Model RDR61CW to RDS41UW were retested. For more information see document:
BlackBerrySystemSimilarity_RDR61CW_RDS41CW.docx

To view the differences between Bundle 522 to 848, see document:
MultiSourceDeclaration_RDS41CW_b848.doc

D) Support Equipment Used for the Testing of the EUT

No support equipment required; for list of equipment refer to section H, Compliance Test Equipment Used.

E) Test Voltage

The ac input voltage was 120 volts, 60 Hz where applicable. This configuration was per RIM's specifications.

Test Report No.
 RTS-2604-1106-131A

Dates of Test
 May 25, June 2 to June 28, 2011

FCC ID: L6ARDR60CW, L6ARDS40CW
IC: 2503A-RDR60CW, 2503A-RDS40CW

F) Test Results Chart

SPECIFICATION		TEST TYPE	RESULT	TEST DATA APPENDIX
FCC CFR 47	IC			
Part 2.1051 Part 22.917 Part 22.901	RSS-GEN, 4.9	GSM 850 Conducted Spurious Emissions	Pass	1A
Part 2.1051 Part 24.238(a)	RSS-GEN, 4.9	PCS 1900 Conducted Spurious Emissions	Pass	1A
Part 2.202 Part 22.917	RSS-GEN, 4.6	GSM 850 Occupied Bandwidth and Channel Mask	Pass	1A
Part 2.202 Part 24.238	RSS-GEN, 4.6	PCS 1900 Occupied Bandwidth and Channel Mask	Pass	1A
Part 2.1046(a)	RSS-133, 6.4 RSS-132, 4.4	GSM Conducted RF Output Power	Pass	2A
Part 2.1055(a)(d) Part 22.917	RSS-132, 4.3	GSM 850 Frequency Stability vs. Temperature and Voltage	Pass	3A
Part 2.1055(a)(d) Part 24.235	RSS-132, 4.3	PCS 1900 Frequency Stability vs. Temperature and Voltage	Pass	3A
Part 22, Subpart H, Part 24, Subpart E	RSS-GEN, 4.9	GSM ERP, EIRP	Pass	4A
Part 22, Subpart H Part 24, Subpart E	RSS-GEN, 4.9	GSM Radiated Spurious/Harmonic Emissions	Pass	4A
Part 2.1051 Part 22.917 Part 22.901(d)	RSS-GEN, 4.9	CDMA Cell Conducted Spurious Emissions	Pass	1B
Part 2.1051 Part 24.238(a)	RSS-GEN, 4.9	CDMA PCS Conducted Spurious Emissions	Pass	1B
Part 2.202 Part 22.917	RSS-GEN, 4.6	CDMA Cell Occupied Bandwidth and Channel Mask	Pass	1B
Part 2.202 Part 24.238	RSS-GEN, 4.6	CDMA PCS Occupied Bandwidth and Channel Mask	Pass	1B
Part 2.1046(a)	RSS-133, 6.4 RSS-132, 4.4	CDMA Conducted RF Output Power	Pass	2B
Part 2.1055(a)(d) Part 22.917	RSS-132, 4.3	CDMA Cell Frequency Stability vs. Temperature and Voltage	Pass	3B

		EMI Test Report for the BlackBerry® smartphone Model RDR61CW,RDS41CW
Test Report No. RTS-2604-1106-131A	Dates of Test May 25, June 2 to June 28, 2011	FCC ID: L6ARDR60CW, L6ARDS40CW IC: 2503A-RDR60CW, 2503A-RDS40CW

Test Results Chart cont'd

Part 2.1055(a)(d) Part 24.235	RSS-GEN, 4.7	CDMA PCS Frequency Stability vs. Temperature and Voltage	Pass	3B
Part 22, Subpart H	RSS-GEN, 4.9	CDMA Cell Radiated Spurious/Harmonic Emissions, ERP	Pass	4B
Part 24, Subpart E	RSS-GEN, 4.9	CDMA PCS Radiated Spurious/Harmonic Emissions, EIRP	Pass	4B
Part 2.1051 Part 2.1049 Part 90.210 Part 90.691	-	CDMA BC10 Conducted Spurious Emissions	Pass	1C
Part 2.1046(a) Part 90.635	-	CDMA BC10 Conducted RF Output Power	Pass	2C
Part 2.1055(a)(d) Part 90.213	-	CDMA BC10 Frequency Stability vs. Temperature and Voltage	Pass	3C
Part 2.1046 Part 2.1053 Part 90.691	-	CDMA BC10 Radiated Spurious/Harmonic Emissions, EIRP	Pass	4C

G) Summary of Results

1) Conducted Emission Measurements

The following test configurations were measured for model RDR61CW:

a) The BlackBerry® smartphone met the requirements of the Tx Conducted Spurious Emissions requirements in the GSM850 as per 47 CFR 2.1051, CFR 22.917, CFR 22.901(d) and RSS-GEN, 4.9. The EUT was measured on the low, middle and high channels. The frequency range investigated was from 10 MHz to 10 GHz.

See APPENDIX 1A for test data.

The BlackBerry® smartphone met the requirements of the Tx Conducted Spurious Emissions requirements in the PCS1900 as per 47 CFR 2.1051, CFR 24.238(a) and RSS-GEN, 4.9. The EUT was on the low, middle and high channels. The frequency range investigated was from 10 MHz to 20 GHz.

See APPENDIX 1A for test data

b) The BlackBerry® smartphone met the requirements of the Occupied Bandwidth and channel mask requirements in the GSM850 as per 47 CFR 2.202, CFR 22.917 and RSS-GEN, 4.6. The EUT was measured in GSM and EDGE mode on the low,

		EMI Test Report for the BlackBerry® smartphone Model RDR61CW,RDS41CW
Test Report No. RTS-2604-1106-131A	Dates of Test May 25, June 2 to June 28, 2011	FCC ID: L6ARDR60CW, L6ARDS40CW IC: 2503A-RDR60CW, 2503A-RDS40CW

middle and high channels. The worst case occupied bandwidth was 246.7 kHz on middle channel in GSM mode, and 245 kHz on low and middle channel in EDGE mode.

See APPENDIX 1A for test data.

The BlackBerry® smartphone met the requirements of the Occupied Bandwidth and channel mask requirements in the PCS1900 as per 47 CFR 2.202, CFR 24.238 and RSS-GEN, 4.6. The EUT was measured in GSM and EDGE mode on the low, middle and high channels. The worst case occupied bandwidth was 243.3 kHz on low and high channel in GSM, and 246.7 kHz on low and high channel in EDGE mode.

See APPENDIX 1A for test data.

The BlackBerry® smartphone met the requirements of the Tx Conducted RF output Power requirements in the GSM850 as per 47 CFR 2.1046, and RSS-GEN, 4.4. The EUT was measured on the low, middle and high channels. The frequency range investigated was from 10 MHz to 10 GHz.

See APPENDIX 2A for test data.

The BlackBerry® smartphone met the requirements of the Tx Conducted RF output Power requirements in the PCS1900 as per 47 CFR 2.1046, and RSS-GEN, 6.4. The EUT was on the low, middle and high channels. The frequency range investigated was from 10 MHz to 20 GHz.

See APPENDIX 2A for test data

c) The BlackBerry® smartphone met the requirements of the Frequency Satbility requirements in the GSM850 as per 47 CFR 2.1055, CFR 22.917 and RSS-GEN, 4.3. The EUT was measured in GSM850 mode on the low, middle and high channels.

See APPENDIX 3A for test data.

The BlackBerry® smartphone met the requirements of the Frequency Satbility requirements in the PCS1900 as per 47 CFR 2.1055, CFR 24.235 and RSS-GEN, 4.7. The EUT was measured in PCS1900 mode on the low, middle and high channels.

See APPENDIX 3A for test data.

d) The EUT met the requirements of the Conducted Spurious Emissions in the Cellular band as per 47 CFR 22.917, CFR 22.901(d) and RSS-132. The EUT was measured in Loopback and 1xEVDO mode on the low, middle and high channels. The frequency range investigated was from 10 MHz to 10 GHz.

See APPENDIX 1B for the test data.

		EMI Test Report for the BlackBerry® smartphone Model RDR61CW,RDS41CW
Test Report No. RTS-2604-1106-131A	Dates of Test May 25, June 2 to June 28, 2011	FCC ID: L6ARDR60CW, L6ARDS40CW IC: 2503A-RDR60CW, 2503A-RDS40CW

The BlackBerry® smartphone met the requirements of the Conducted Spurious Emissions in the CDMA PCS band as per 47 CFR 2.1057, CFR 24.238 and RSS-133. The EUT was measured in Loopback and 1xEVDO mode on the low, middle and high channels. The frequency range investigated was from 10 MHz to 20 GHz See APPENDIX 1B for the test data.

e) The BlackBerry® smartphone met the requirements of the Occupied Bandwidth in the CDMA Cellular band as per 47 CFR 2.202, CFR 22.917 and RSS-132. The EUT was measured in Loopback and 1xEVDO mode on the low, middle and high channels. The worst case occupied bandwidth was 1.273 MHz on middle channel in Loopback mode and 1.280 MHz on middle and high channel in 1xEVDO mode. See APPENDIX 1B for the test data.

The BlackBerry® smartphone met the requirements of the Occupied Bandwidth and channel mask in the CDMA PCS band as per 47 CFR 2.202, CFR 24.238 and RSS-133. The EUT was measured in Loopback and 1xEVDO mode on the low, middle and high channels. The worst case occupied bandwidth was 1.280 MHz on low, middle and high channel in Loopback mode and 1.290 MHz on low and high channel in 1xEVDO mode. See APPENDIX 1B for the test data.

f) The BlackBerry® smartphone met the requirements of the Conducted RF Output Power for both the CDMA Cellular and PCS bands. The EUT was measured in Loopback and 1xEVDO mode on the low, middle and high channels See APPENDIX 2B for test data.

g) The BlackBerry® smartphone met the requirements of the Frequency Stability vs. Temperature and Voltage for CDMA Cellular band as per 22.917 and RSS-132. The EUT was measured in Cellular mode on the low, middle and high channels. See APPENDIX 3B for test data.

The BlackBerry® smartphone met the requirements of the Frequency Stability vs. Temperature and Voltage requirements for the PCS band as per 24.235 and RSS-133. The EUT was measured in CDMA PCS mode on the low, middle and high channels. See APPENDIX 3B for test data.

The following test configurations were measured for model RDS41CW:

a) The BlackBerry® smartphone met the requirements of the Conducted Spurious Emissions in the CDMA BC10 as per 47 CFR 2.1051, CFR 90 (J), 90.210, and 90.691. The EUT was measured in BC10 mode on the low, middle and high channels. The frequency range investigated was from 10 MHz to 10 GHz. See APPENDIX 1C for the test data.

	EMI Test Report for the BlackBerry® smartphone Model RDR61CW,RDS41CW	
Test Report No. RTS-2604-1106-131A	Dates of Test May 25, June 2 to June 28, 2011	FCC ID: L6ARDR60CW, L6ARDS40CW IC: 2503A-RDR60CW, 2503A-RDS40CW

b) The BlackBerry® smartphone met the requirements of the Occupied Bandwidth and channel mask in the CDMA BC10 as per 47 CFR 2.202, and CFR 90 (I). The channels were measured in BC10 mode on the low, middle and high channels. The worst case occupied bandwidth was 1.29 MHz on low and high channel in BC10 mode

See APPENDIX 1C for the test data.

c) The BlackBerry® smartphone met the requirements of the Tx Conducted RF output Power requirements in the CDMA BC10 as per 47 CFR 2.1046, and CFR 90.635. The EUT was measured on the low, middle and high channels.

See APPENDIX 2C for test data.

d) The BlackBerry® smartphone met the requirements of the Frequency Stability requirements in the CDMA BC10 as per 47 CFR 2.1055, and CFR 90.213. The EUT was measured in CDMA BC10 mode on the low, middle and high channels.

See APPENDIX 3C for test data.

		EMI Test Report for the BlackBerry® smartphone Model RDR61CW,RDS41CW
Test Report No. RTS-2604-1106-131A	Dates of Test May 25, June 2 to June 28, 2011	FCC ID: L6ARDR60CW, L6ARDS40CW IC: 2503A-RDR60CW, 2503A-RDS40CW

2) Radiated Emission Measurements

a) Radiated Spurious and Harmonic Emissions

The following test configurations were measured for model RDR61CW:

The radiated spurious emissions/harmonics and ERP/EIRP were measured for GSM 850, PCS 1900, CDMA Cellular and CDMA PCS. The results are within the limits. The BlackBerry® smartphone was placed on a nonconductive styrofoam table, 100 cm high that was positioned on a remotely controlled turntable. The test distance used between the BlackBerry® smartphone and the receiving antenna was three metres. Then the emissions were maximized by elevating the antenna in the range of 1 to 4 metres. The turntable was rotated to determine the azimuth of the peak emissions. Both the horizontal and vertical polarizations of the emissions were measured. The maximum emissions level was recorded. The BlackBerry® smartphone was then substituted with an antenna placed in the same location as the BlackBerry® smartphone. A Dipole antenna was used for the ERP measurements and a Horn antenna was used for EIRP measurements. The substitution antenna was connected into a signal generator that was set to the test frequency.

The emissions were maximized by elevating the antenna in the range of 1 to 4 metres. The signal generator output was then adjusted to match the BlackBerry® smartphone output reading. The signal generator output was recorded. Both the horizontal and vertical polarizations of the emissions were measured.

The following measurements were done in a semi-anechoic chamber (SAC) below 1 GHz and a Semi-anechoic Chamber ((SAC) with floor absorber) above 1 GHz. The SAC's FCC registration number is **778487** and the Industry Canada (IC) file number is **2503B-1**. The SAC with floor absorber's FCC registration number is **959115** and the IC file number is **2503C-1**. The BlackBerry® smartphone was measured on the low, middle and high channels.

The following test configurations were measured for model RDR61CW:

The highest ERP in the 850 band call mode measured was 32.11 dBm (1.63 W) at 824.20 MHz (channel 128).

The highest ERP in the 850 band EDGE mode measured was 30.42dBm (1.10 W) at 824.20 MHz (channel 128) and 836.60 MHz (channel 190).

The highest EIRP in the PCS band call mode measured was 32.35 dBm (1.72 W) at 1880.0 MHz (channel 661).

		EMI Test Report for the BlackBerry® smartphone Model RDR61CW,RDS41CW
Test Report No. RTS-2604-1106-131A	Dates of Test May 25, June 2 to June 28, 2011	FCC ID: L6ARDR60CW, L6ARDS40CW IC: 2503A-RDR60CW, 2503A-RDS40CW

The highest EIRP in the PCS band EDGE mode measured was 31.54 dBm (1.43 W) at 1880.0 MHz (channel 661).

The highest ERP measured in the Cellular band, Loopback Service mode, was 25.04 dBm (0.32 W) at 824.70 MHz (channel 1013).

The highest ERP measured in the Cellular band, 1xEVDO mode, was 26.18 dBm (0.42 W) at 836.52 MHz (channel 384).

The highest EIRP measured in the PCS band, Loopback Service mode, was 27.19 dBm (0.52 W) at 1880.00 MHz (channel 600).

The highest EIRP measured in the PCS band, 1xEVDO mode, was 27.39 dBm (0.55 W) at 1880.00 MHz (channel 600)

The radiated spurious emission and carrier harmonics were measured up to the 10th harmonic for low, middle, and high channels in the GSM850 and PCS 1900 bands. Each band was measured in GSM and EDGE mode, with both the horizontal and vertical polarizations.

The margins in the GSM 850 and EDGE for harmonic emissions were greater than 25 dB below the accepted limits for all test frequencies.

The margins in the PCS 1900 and EDGE for harmonic emissions were greater than 25 dB below the accepted limits for all test frequencies.

The radiated carrier harmonics were measured up to the 10th harmonic for low, middle and high channels in the CDMA Cellular and CDMA PCS. Each band was measured in Call, and EVDO modes, with both the horizontal and vertical polarizations.

The margins in the CDMA Cellular Call and EVDO for harmonic emissions were greater than 25 dB below the accepted limits for all test frequencies.

The margins in the CDMA PCS Call and EVDO for harmonic emissions were greater than 25 dB below the accepted limits for all test frequencies.

The following test configurations were measured for model RDS41CW:

The radiated carrier harmonics were measured up to the 10th harmonic for middle channel in the CDMA Cellular. The test performed in Call, and EVDO modes, with both the horizontal and vertical polarizations.

		EMI Test Report for the BlackBerry® smartphone Model RDR61CW,RDS41CW
Test Report No. RTS-2604-1106-131A	Dates of Test May 25, June 2 to June 28, 2011	FCC ID: L6ARDR60CW, L6ARDS40CW IC: 2503A-RDR60CW, 2503A-RDS40CW

The margins in the CDMA Cellular Call and EVDO for harmonic emissions were greater than 25 dB below the accepted limits for all test frequencies.

The highest ERP in the CDMA BC10, Call Service mode was 27.69 dBm (0.59 W) at 820.50 MHz (channel 580).

The highest ERP in the CDMA BC10, EVDO mode was 27.02 dBm (0.50 W) at 823.10 MHz (channel 684).

The radiated carrier harmonics were measured up to the 10th harmonic for low, middle and high channels in the CDMA BC10. Each band was measured in Call, and EVDO modes. Both the horizontal and vertical polarizations were measured.

The margins in the CDMA BC10 Call and EVDO for harmonic emissions were greater than 25 dB below the accepted limits for all test frequencies.

b) Co-Location Measurements

The following test configurations were measured for model RDR61CW:

The radiated emissions were measured up to 18 GHz for middle channels for simultaneous transmission in the following test configuration combinations: CDMA CELL/Bluetooth/802.11b, CDMA PCS/Bluetooth/802.11b, GSM 850/Bluetooth/802.11b and PCS 1900/Bluetooth/802.11b.

Both the horizontal and vertical polarizations were measured. The emissions due to different simultaneous transmission did not increase the amplitude of any emissions nor did it produce any new inter-modulation products as a result of mixing.

Sample Calculation:

Corrected Signal Level (CSL) is calculated as follows:

CSL (dBm) = Measured Level (dBμV) – Antenna Gain (dBi) + Free Space Loss (dB) – 107 (dB) + Cable Loss (dB) - Preamp (dB) + Filter Loss (dB) – 2.15 (dB)

To view the test data see APPENDIX 4A and 4B.

Measurement Uncertainty ±4.6 dB

		EMI Test Report for the BlackBerry® smartphone Model RDR61CW,RDS41CW	
Test Report No. RTS-2604-1106-131A	Dates of Test May 25, June 2 to June 28, 2011	FCC ID: L6ARDR60CW, L6ARDS40CW IC: 2503A-RDR60CW, 2503A-RDS40CW	

H) Compliance Test Equipment Used

<u>UNIT</u>	<u>MANUFACTURER</u>	<u>MODEL</u>	<u>SERIAL NUMBER</u>	<u>CAL DUE DATE</u> (YY MM DD)	<u>USE</u>
Preamplifier	Sonoma	310N/11909A	185831	11-11-24	Radiated Emissions
Preamplifier system	TDK RF Solutions	PA-02	080010	11-11-24	Radiated Emissions
Preamplifier	Rohde & Schwarz	TS-ANA4-SP	001	11-12-01	Radiated Emissions
Preamplifier	Rohde & Schwarz	TS-ANA-SP	001	11-12-01	Radiated Emissions
Hybrid Log Antenna	EMC Automation	HLP-3003C	017401	12-01-04	Radiated Emissions
Horn Antenna	EMC Automation	HRN-0118	030101	12-07-20	Radiated Emissions
Horn Antenna	EMC Automation	HRN-0118	030201	12-09-22	Radiated Emissions
Horn Antenna	Emco	3117	47563	11-07-15	Radiated Emissions
Horn Antenna	CMT	LHA 0180	R52734-001	12-01-21	Radiated Emissions
Dipole Antenna	Schwarzbeck	UHAP	973	12-02-21	Radiated Emissions
Dipole Antenna	Schwarzbeck	UHAP	974	13-02-21	Radiated Emissions
Universal Radio Communication Tester	Rohde & Schwarz	CMU 200	837493/073	11-10-01	Radiated Emissions
Universal Radio Communication Tester	Rohde & Schwarz	CMU 200	112394	11-10-01	Radiated Emissions
Universal Radio Communication Tester	Rohde & Schwarz	CMU 200	102204	11-11-30	RF Conducted Emissions
EMI Receiver	Rohde & Schwarz	ESIB-40	100255	11-11-28	Radiated Emissions
EMI Receiver	Rohde & Schwarz	ESU-40	100162	11-11-30	Radiated Emissions
Spectrum Analyzer	HP	8563E	3745A08112	11-09-30	RF Conducted Emissions
DC Power Supply	HP	6632B	US37472178	11-11-19	RF Conducted Emissions
Environment Monitor	Omega	iTHX-SD	0380561	11-10-13	Radiated Emissions

		EMI Test Report for the BlackBerry® smartphone Model RDR61CW,RDS41CW	
Test Report No. RTS-2604-1106-131A	Dates of Test May 25, June 2 to June 28, 2011	FCC ID: L6ARDR60CW, L6ARDS40CW IC: 2503A-RDR60CW, 2503A-RDS40CW	

Compliance Test Equipment Used cont'd

<u>UNIT</u>	<u>MANUFACTURER</u>	<u>MODEL</u>	<u>SERIAL NUMBER</u>	<u>CAL DUE DATE</u> (YY MM DD)	<u>USE</u>
Environment Monitor	Omega	iTHX-SD	0340060	11-10-13	RF Conducted Emissions
Environment Monitor	Omega	iTHX-SD	0380567	11-10-13	Radiated Emissions
Signal Generator	Agilent	E8257D	MY45140527	11-11-05	Radiated Emissions
Signal Generator	Agilent	83630B	3844A00927	12-10-28	Radiated Emissions

APPENDIX 1A – GSM CONDUCTED RF EMISSIONS TEST DATA/PLOTS

		EMI Test Report for the BlackBerry® smartphone Model RDR61CW,RDS41CW Appendix 1A	
Test Report No. RTS-2604-1106-131A	Dates of Test May 25, June 2 to June 28, 2011	FCC ID: L6ARDR60CW, L6ARDS40CW IC: 2503A-RDR60CW, 2503A-RDS40CW	

GSM Conducted RF Emission Test Data

This appendix contains measurement data pertaining to conducted spurious emissions, -26 dBc bandwidth, 99% power bandwidth and the channel mask on BlackBerry® smartphone.

Test Setup Diagram

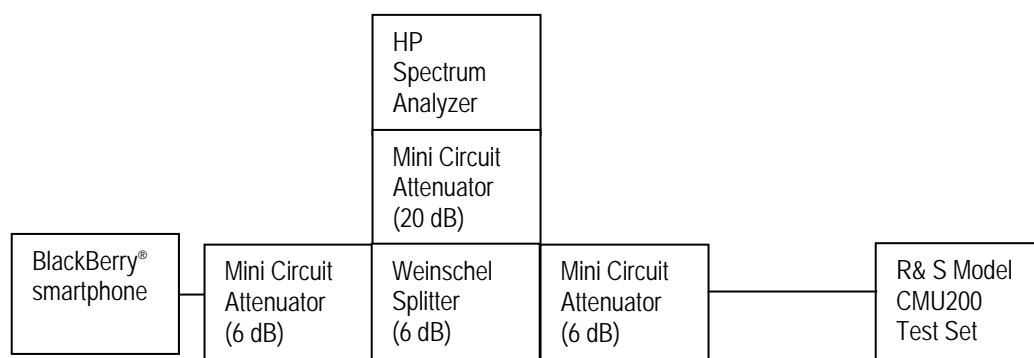

Date of Test: June 27, 2011

The environmental test conditions were:

Temperature: 24.0 °C

Relative Humidity: 47.0 %

The following measurements were performed by Maurice Battler.

Test Report No.
RTS-2604-1106-131A

Dates of Test
May 25, June 2 to June 28, 2011

FCC ID: L6ARDR60CW, L6ARDS40CW
IC: 2503A-RDR60CW, 2503A-RDS40CW

GSM Conducted RF Emission Test Data cont'd

The conducted spurious emissions – As per 47 CFR 2.1051, CFR 24.238(a), RSS-GEN, 4.9, CFR 22 Subpart H and RSS-132 were measured from 10 MHz to 20 GHz. The EUT emissions were in the noise floor.
See figures 1-1a to 1-12a for the plots of the conducted spurious emissions.

–26 dBc Bandwidth and Occupied Bandwidth (99%)

For each carrier frequency of low, middle and high, the modulation spectrum was measured by both methods of 99% power bandwidth and –26 dBc bandwidth.

The resolution bandwidth required for out-of-band emissions in the 1 MHz bands immediately outside and adjacent to the frequency block, was determined to be at least 1% of the emission bandwidth.

The worst case –26dBc bandwidth for the GSM850 band was measured to be 273 kHz, and for the PCS1900 band was measured to be 268 kHz as shown below. This results in a 3.0 kHz resolution bandwidth.

On any frequency outside the frequency block and outside the adjacent 1 MHz bands, a resolution bandwidth of at least 1 MHz was applied.

Test Data for 850 band and 1900 band selected Frequencies in GSM mode.

850 band Frequency (MHz)	-26dBc Bandwidth (kHz)	99% Occupied Bandwidth (kHz)
824.2	273	241.7
837.6	272	246.7
848.8	265	241.7

1900 band Frequency (MHz)	-26dBc Bandwidth (kHz)	99% Occupied Bandwidth (kHz)
1850.2	265	243.3
1880.0	265	241.7
1909.8	268	243.3

Measurement Plots for 850 and 1900 in GSM mode

Refer to the following measurement plots for more detail.

See Figures 1-13a to 1-24a for the plots of 26dBc/99% Occupied Bandwidth.

The RF power output was at maximum for all the recorded measurements shown below.

		EMI Test Report for the BlackBerry® smartphone Model RDR61CW,RDS41CW Appendix 1A
Test Report No. RTS-2604-1106-131A	Dates of Test May 25, June 2 to June 28, 2011	FCC ID: L6ARDR60CW, L6ARDS40CW IC: 2503A-RDR60CW, 2503A-RDS40CW

GSM Conducted RF Emission Test Data cont'd

Date of Test: June 27, 2011

Test Data for 850 and 1900 bands selected Frequencies in EDGE mode.

850 band Frequency (MHz)	99% Occupied Bandwidth (kHz)
824.2	245.0
837.6	245.0
848.8	243.3

1900 band Frequency (MHz)	99% Occupied Bandwidth (kHz)
1850.2	246.7
1880.0	245.0
1909.8	246.7

Measurement Plots for 850 and 1900 bands in EDGE mode

Refer to the following measurement plots for more detail.

- See Figures 1-1a to 1-12a for the plots of the conducted spurious emissions.
- See Figures 1-13a to 1-24a for the plots of 26dBc/99% Occupied Bandwidth.
- See Figures 1-25a to 1-28a for the plots of the Channel mask.
- See Figures 1-29a to 1-34a for the plots of the 99% Occupied Bandwidth EDGE results.
- See Figures 1-35a to 1-38a for the plots of channel mask EDGE results.
- See Figures 1-39a to 1-50a for the plots of the conducted spurious emissions EDGE results

The RF power output was at maximum for all the recorded measurements shown below.

Test Report No.
RTS-2604-1106-131A

Dates of Test
May 25, June 2 to June 28, 2011

FCC ID: L6ARDR60CW, L6ARDS40CW
IC: 2503A-RDR60CW, 2503A-RDS40CW

GSM Conducted RF Emission Test Data cont'd

Figure 1-1a: GSM850 band, Spurious Conducted Emissions, Low channel

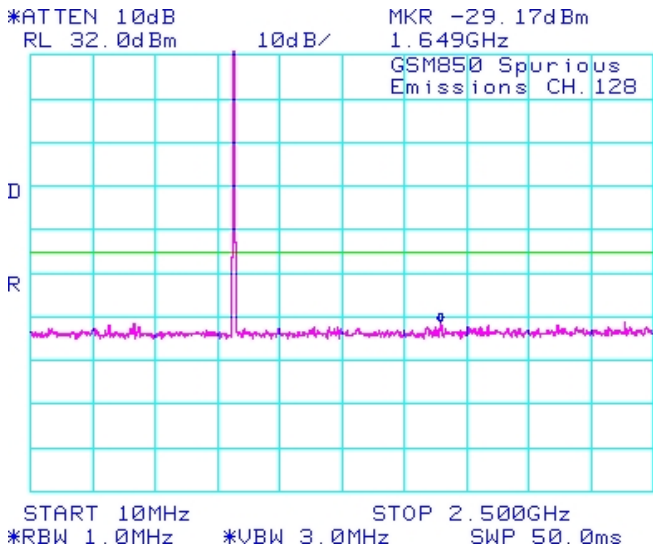

Figure 1-2a: GSM850 band, Spurious Conducted Emissions, Low channel

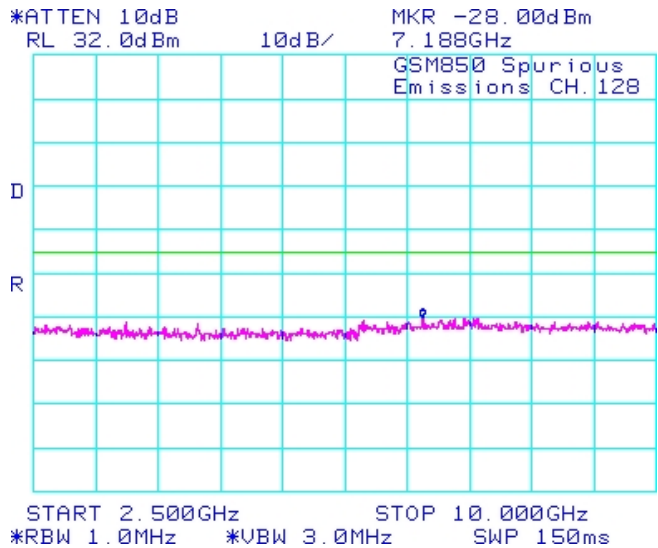

Figure 1-3a: GSM850 band, Spurious Conducted Emissions, Middle Channel

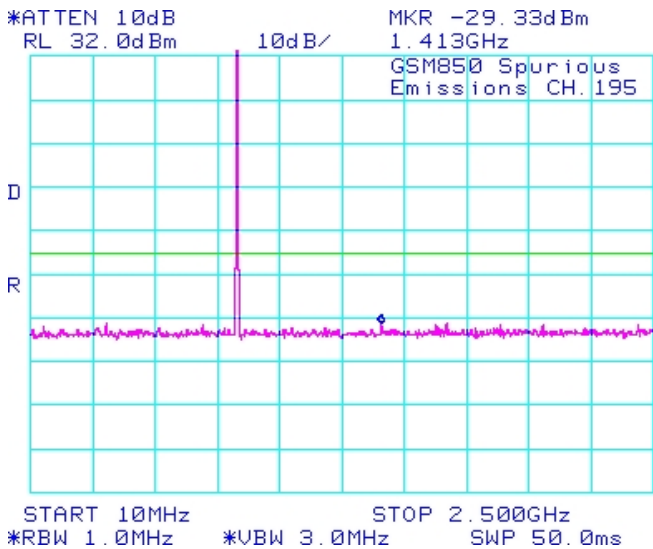
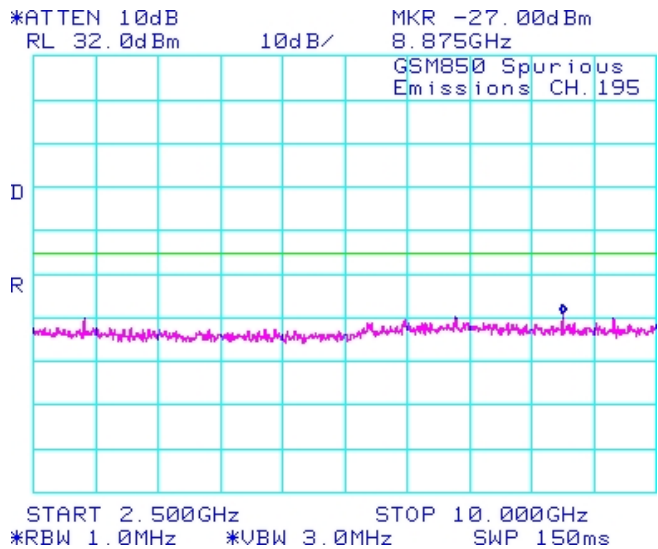

Figure 1-4a: GSM850 band, Spurious Conducted Emissions, Middle Channel



Test Report No.
RTS-2604-1106-131A

Dates of Test
May 25, June 2 to June 28, 2011

FCC ID: L6ARDR60CW, L6ARDS40CW
IC: 2503A-RDR60CW, 2503A-RDS40CW

GSM Conducted RF Emission Test Data cont'd

Figure 1-5a: GSM850 band, Spurious Conducted Emissions, High Channel

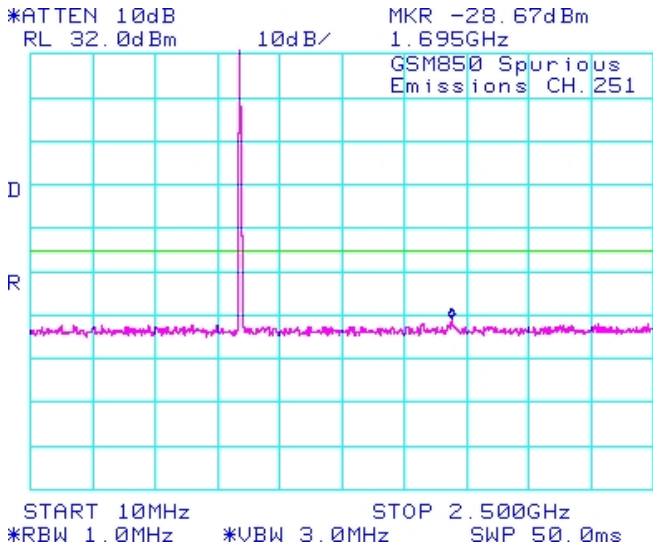

Figure 1-6a: GSM850 band, Spurious Conducted Emissions, High Channel

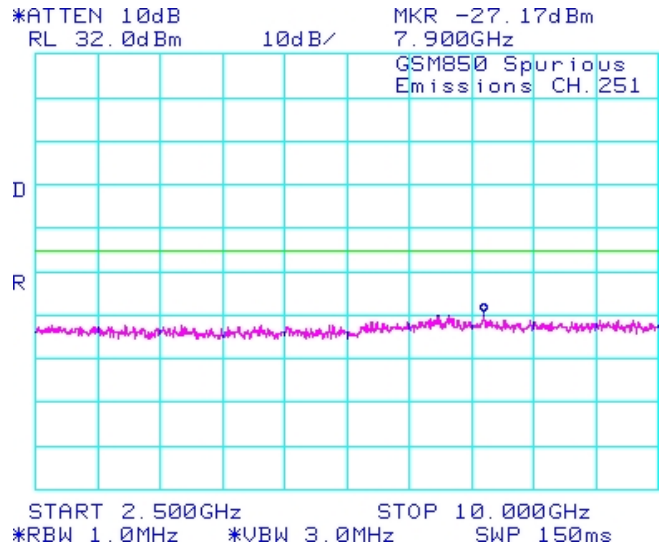

Figure 1-7a: PCS1900 band, Spurious Conducted Emissions, Low Channel

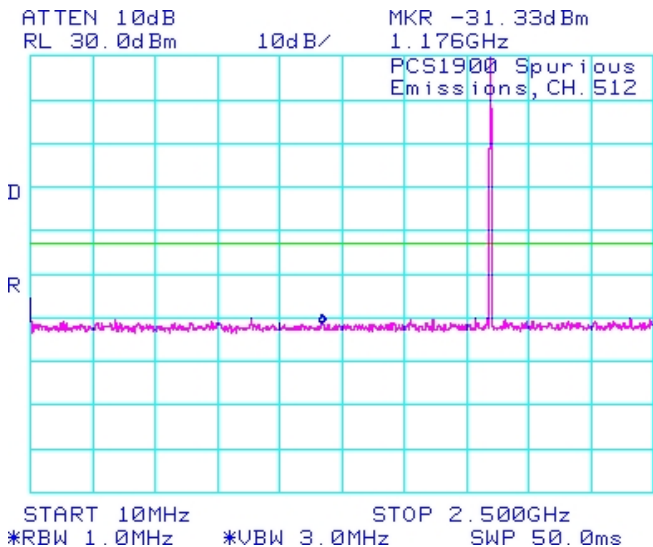
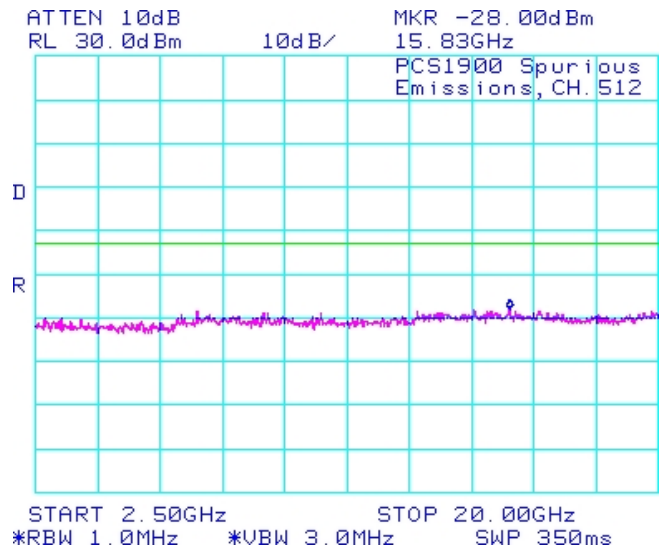

Figure 1-8a: PCS1900 band, Spurious Conducted Emissions, Low Channel



Test Report No.
RTS-2604-1106-131A

Dates of Test
May 25, June 2 to June 28, 2011

FCC ID: L6ARDR60CW, L6ARDS40CW
IC: 2503A-RDR60CW, 2503A-RDS40CW

GSM Conducted RF Emission Test Data cont'd

Figure 1-9a: PCS1900 band, Spurious Conducted Emissions, Middle Channel

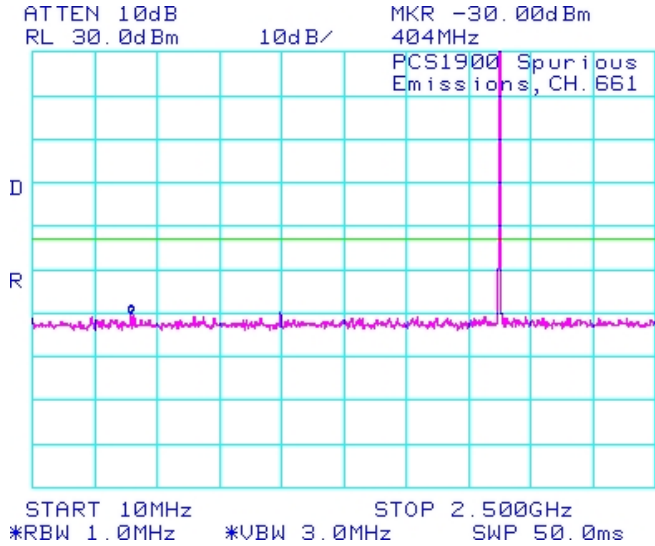

Figure 1-10a: PCS1900 band, Spurious Conducted Emissions, Middle Channel

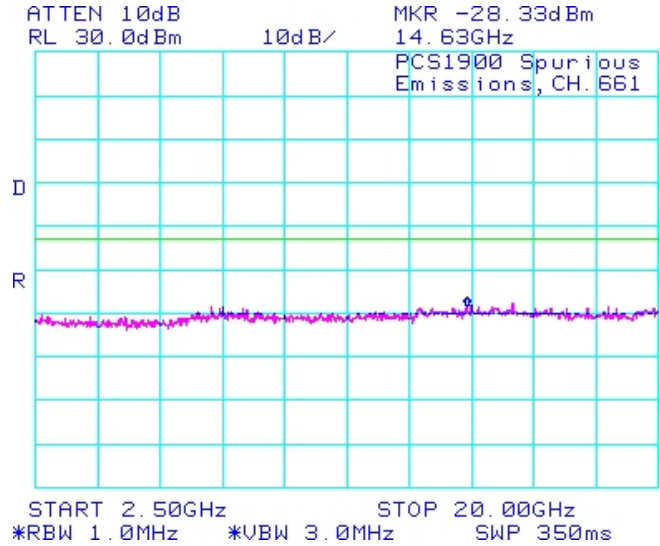

Figure 1-11a: PCS1900 band, Spurious Conducted Emissions, High Channel

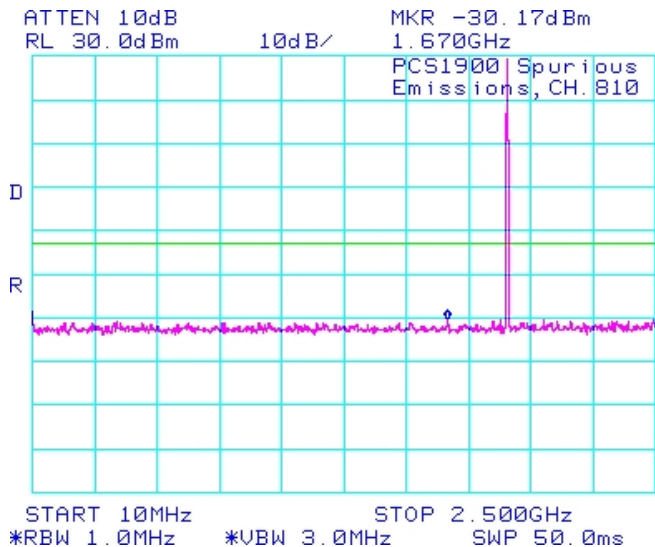
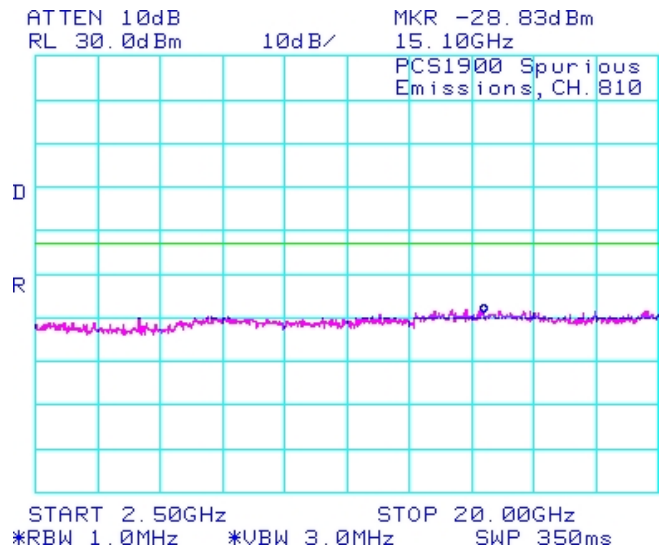

Figure 1-12a: PCS1900 band, Spurious Conducted Emissions, High Channel



Test Report No.
RTS-2604-1106-131A

Dates of Test
May 25, June 2 to June 28, 2011

FCC ID: L6ARDR60CW, L6ARDS40CW
IC: 2503A-RDR60CW, 2503A-RDS40CW

GSM Conducted RF Emission Test Data cont'd

**Figure 1-13a: -26dBc bandwidth, GSM850 band
Low Channel in GSM mode**

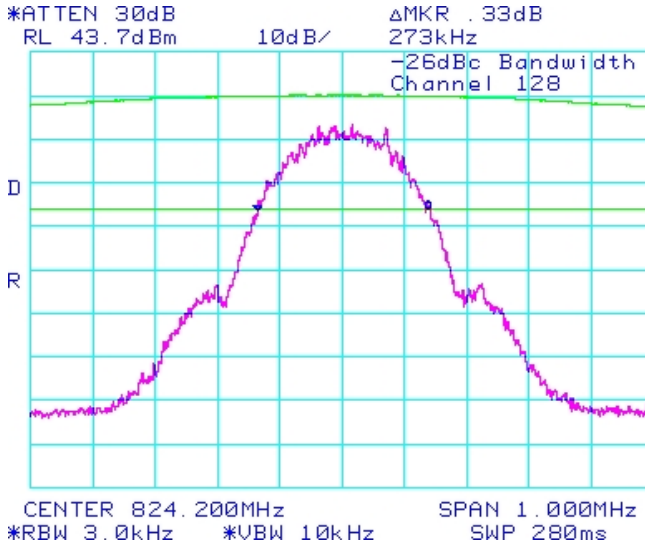

**Figure 1-14a: Occupied Bandwidth, GSM850 band
Low Channel in GSM mode**

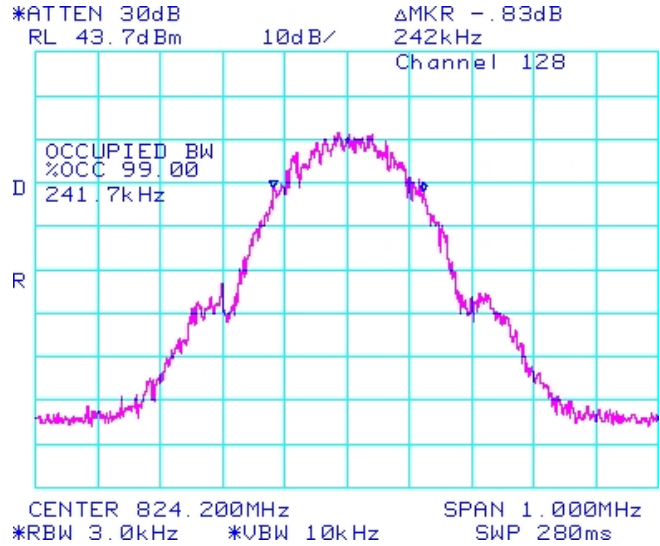

**Figure 1-15a: -26dBc bandwidth, GSM850 band
Middle Channel in GSM mode**

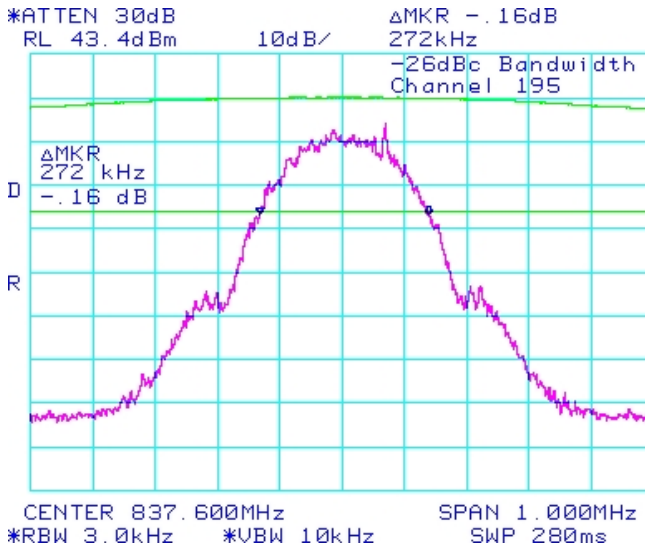

**Figure 1-16a: Occupied Bandwidth, GSM850 band
Middle Channel in GSM mode**

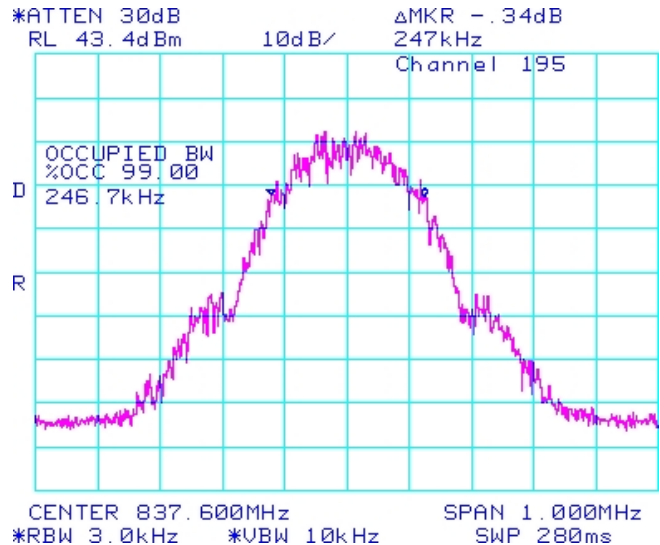

Test Report No.
RTS-2604-1106-131A

Dates of Test
May 25, June 2 to June 28, 2011

FCC ID: L6ARDR60CW, L6ARDS40CW
IC: 2503A-RDR60CW, 2503A-RDS40CW

GSM Conducted RF Emission Test Data cont'd

Figure 1-17a: -26dBc bandwidth, GSM850 band High Channel in GSM mode

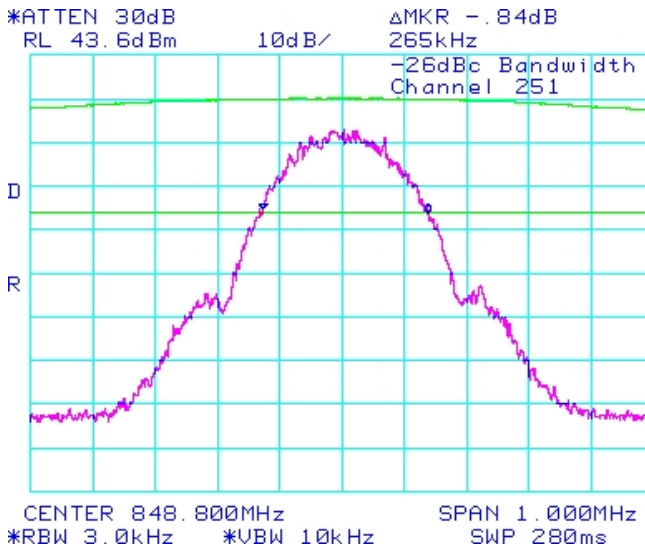

Figure 1-18a: Occupied Bandwidth, GSM850 band High Channel in GSM mode

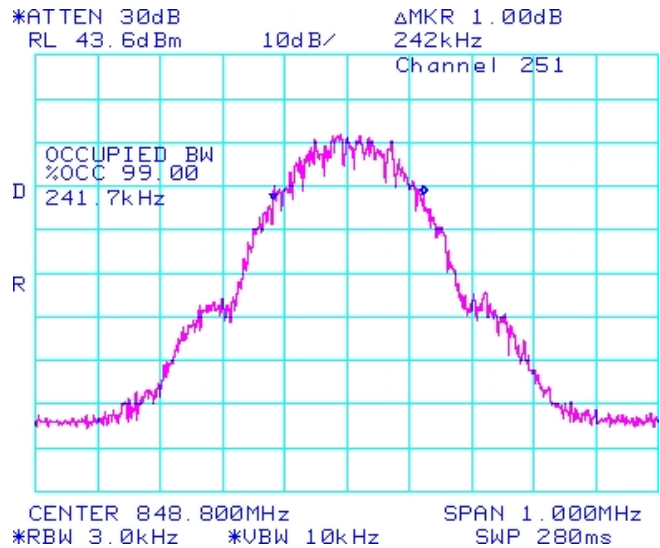

Figure 1-19a: -26dBc bandwidth, PCS1900 Low Channel in GSM mode

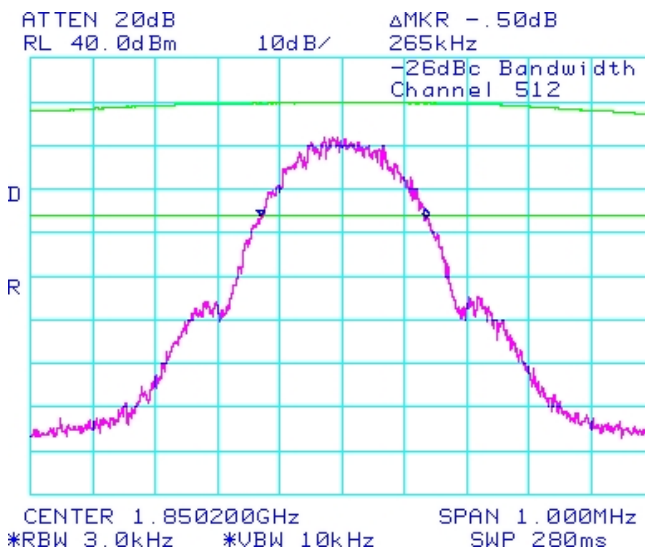
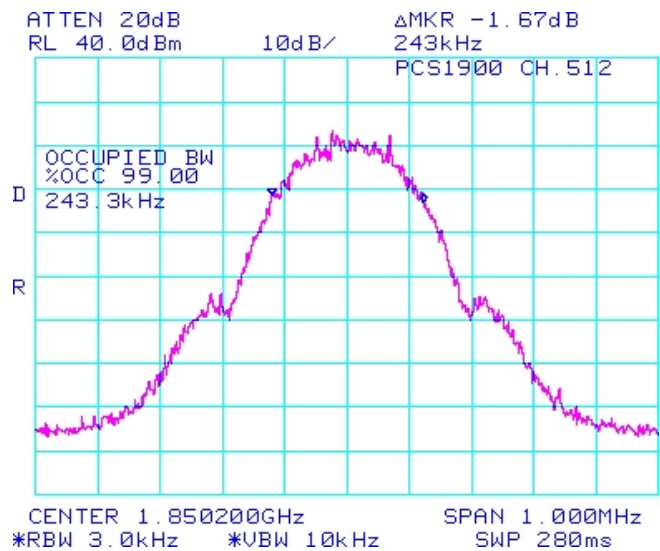

Figure 1-20a: Occupied Bandwidth, PCS1900 Low Channel in GSM mode



Test Report No.
RTS-2604-1106-131A

Dates of Test
May 25, June 2 to June 28, 2011

FCC ID: L6ARDR60CW, L6ARDS40CW
IC: 2503A-RDR60CW, 2503A-RDS40CW

GSM Conducted RF Emission Test Data cont'd

Figure 1-21a: -26dBc bandwidth, PCS1900 Middle Channel in GSM mode

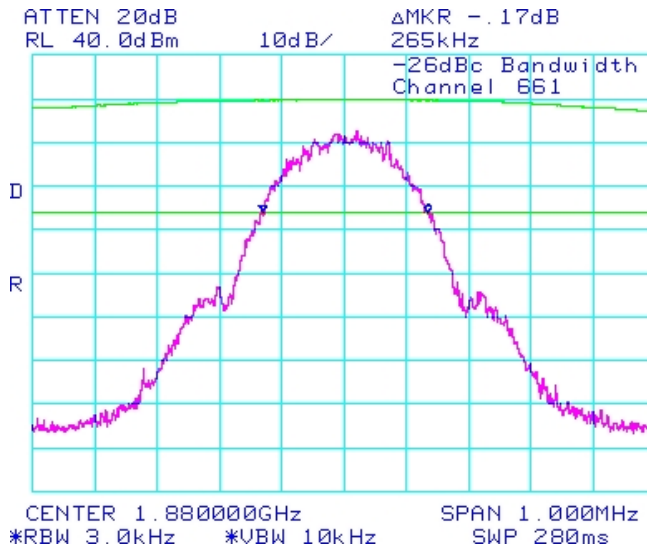

Figure 1-22a: Occupied Bandwidth, PCS1900 Middle Channel in GSM mode

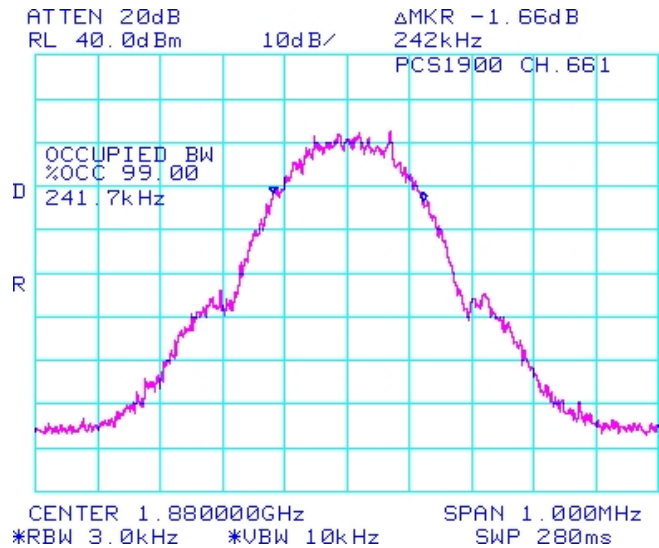

Figure 1-23a: -26dBc bandwidth, PCS1900 High Channel in GSM mode

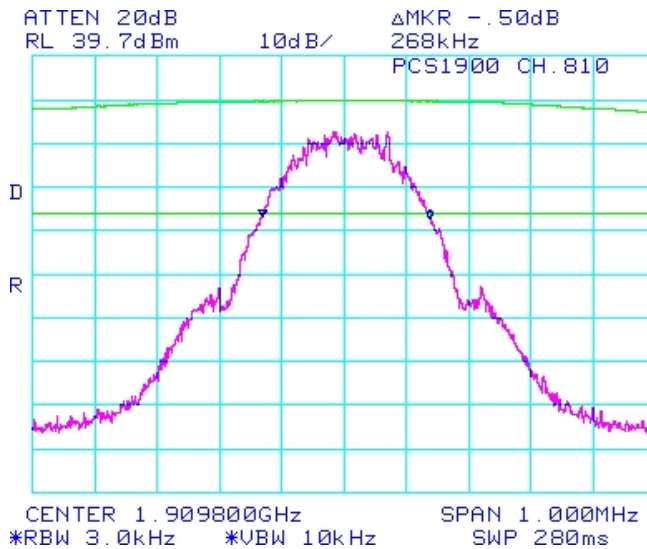
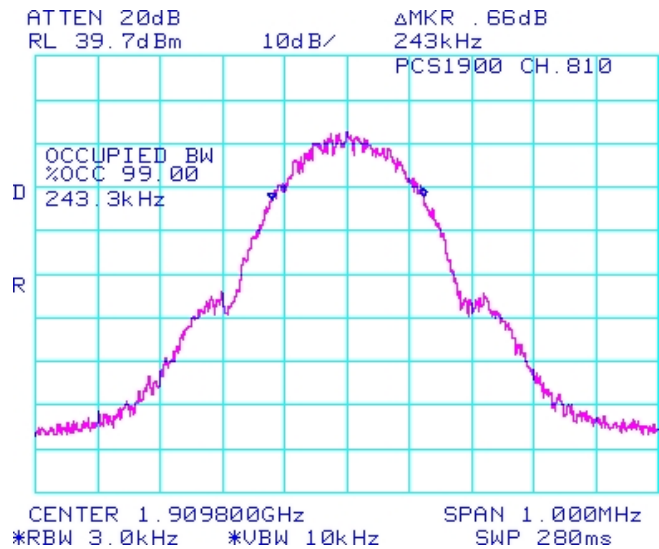

Figure 1-24a: Occupied Bandwidth, PCS1900 High Channel in GSM mode



Test Report No.
RTS-2604-1106-131A

Dates of Test
May 25, June 2 to June 28, 2011

FCC ID: L6ARDR60CW, L6ARDS40CW
IC: 2503A-RDR60CW, 2503A-RDS40CW

GSM Conducted RF Emission Test Data cont'd

Figure 1-25a: GSM850 band, Low Channel Mask in GSM mode

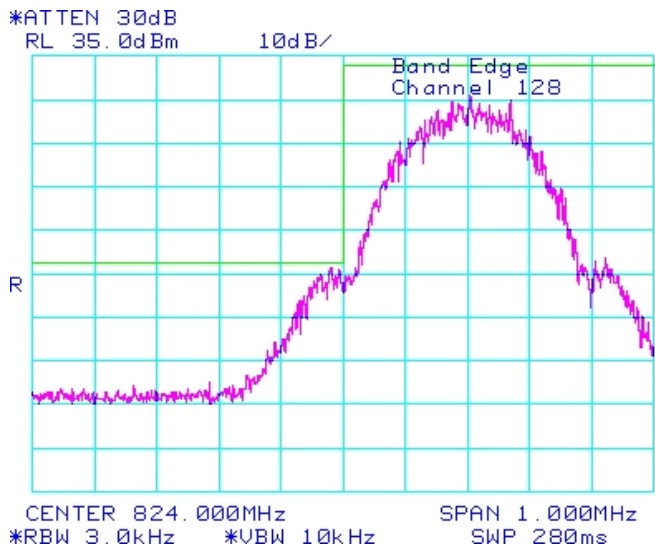

Figure 1-26a: GSM850 band High Channel Mask in GSM mode

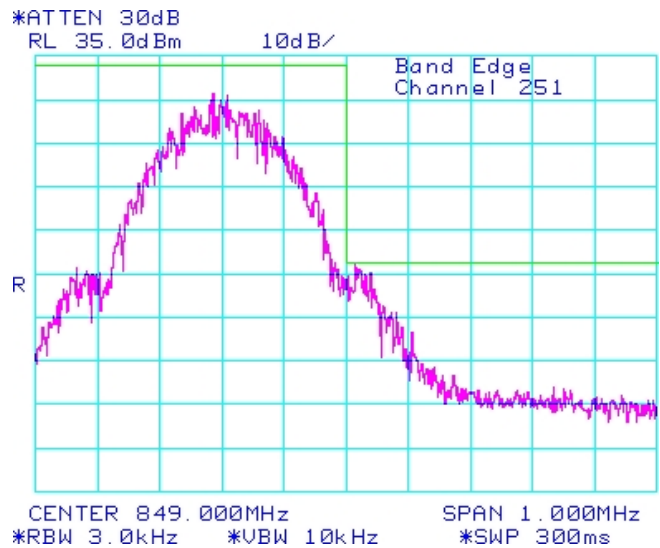

Figure 1-27a: PCS1900, Low Channel Mask in GSM mode

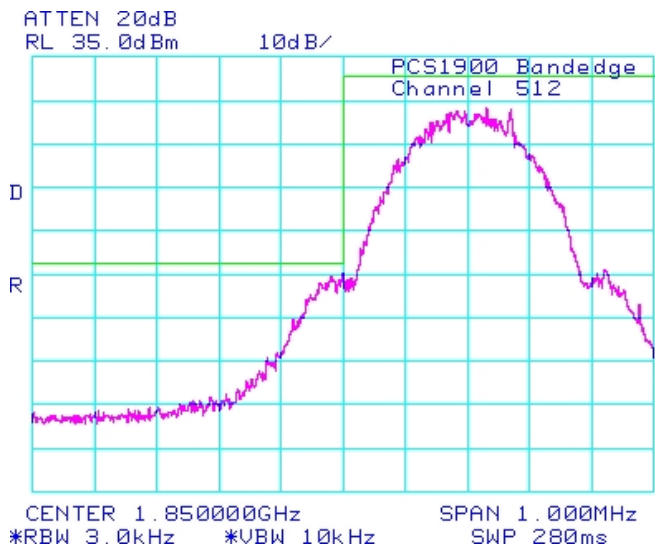
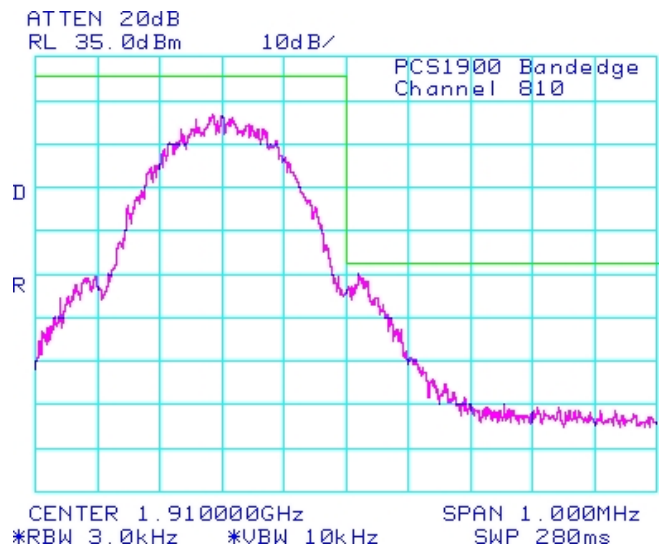

Figure 1-28a: PCS1900, High Channel Mask in GSM mode



Test Report No.
RTS-2604-1106-131A

Dates of Test
May 25, June 2 to June 28, 2011

FCC ID: L6ARDR60CW, L6ARDS40CW
IC: 2503A-RDR60CW, 2503A-RDS40CW

GSM Conducted RF Emission Test Data cont'd

Figure 1-29a: Occupied Bandwidth, GSM850 Band, Low Channel in EDGE mode

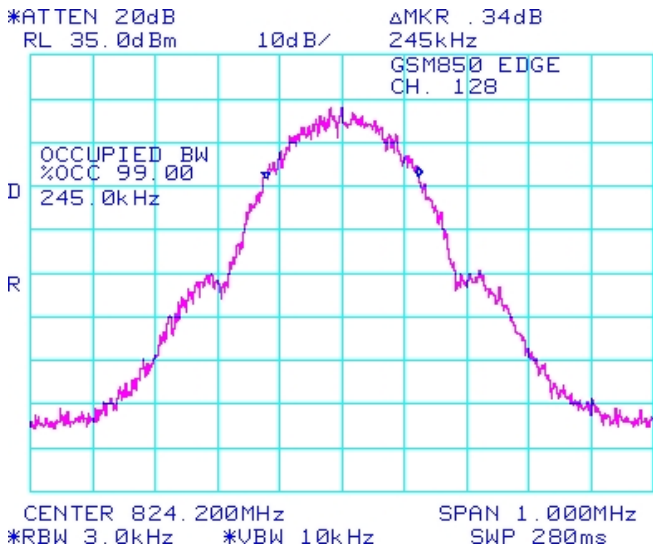

Figure 1-30a: Occupied Bandwidth, GSM850 Band, Middle Channel in EDGE mode

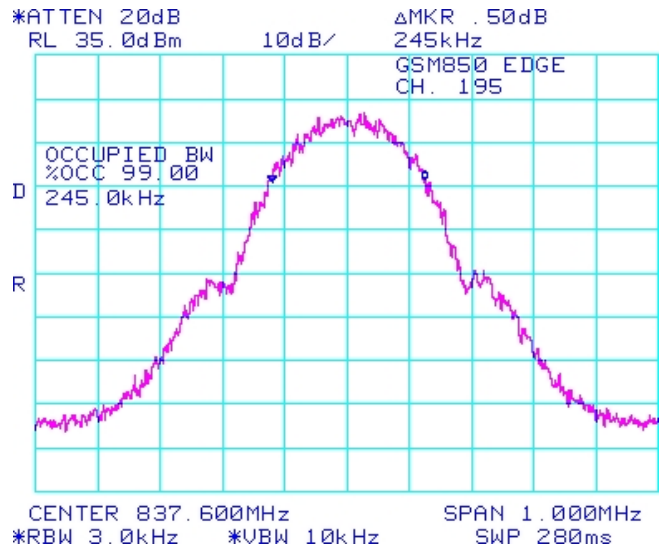

Figure 1-31a: Occupied Bandwidth, GSM850 band, High Channel in EDGE mode

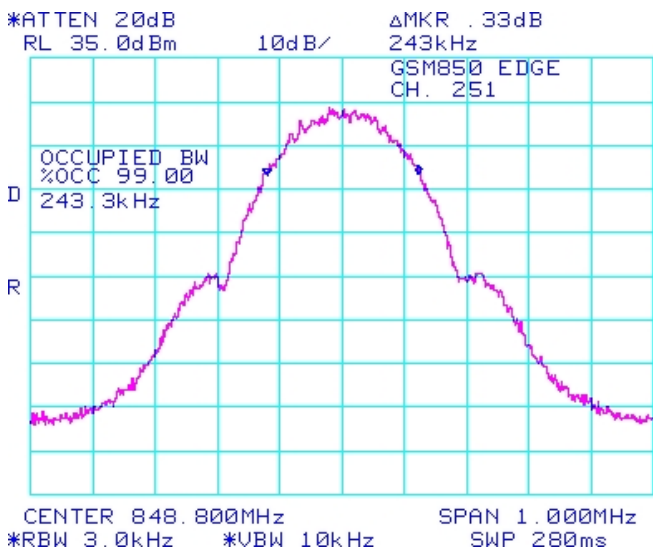
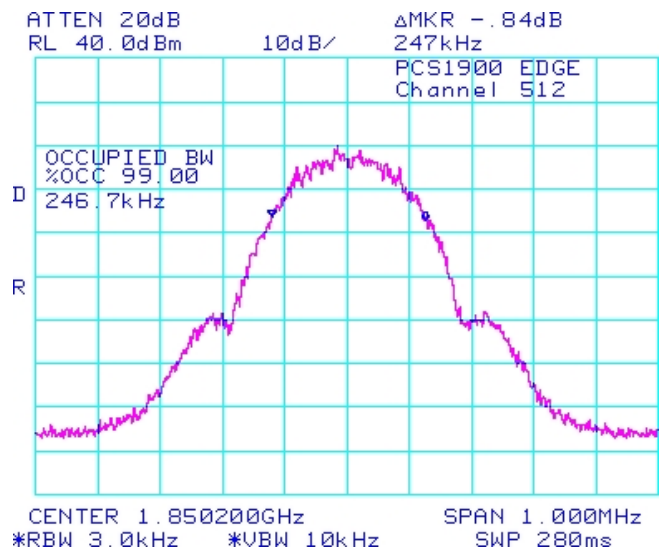

Figure 1-32a: Occupied Bandwidth, PCS1900 Band, Low Channel in EDGE mode



Test Report No.
RTS-2604-1106-131A

Dates of Test
May 25, June 2 to June 28, 2011

FCC ID: L6ARDR60CW, L6ARDS40CW
IC: 2503A-RDR60CW, 2503A-RDS40CW

GSM Conducted RF Emission Test Data cont'd

Figure 1-33a: Occupied Bandwidth, PCS1900 Band, Middle Channel in EDGE mode

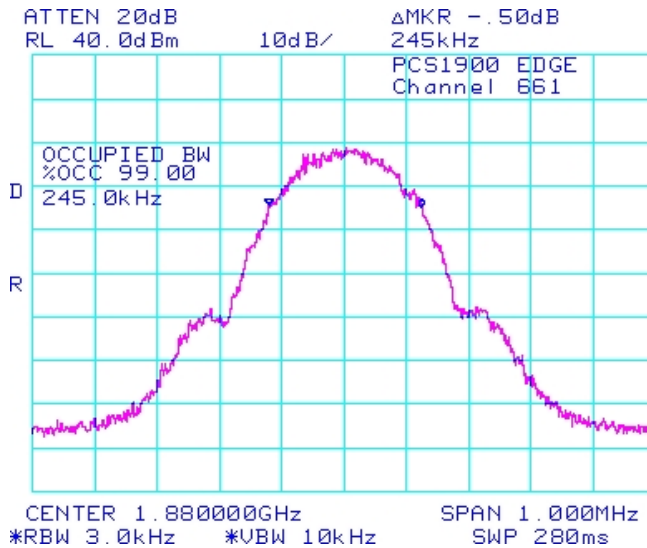

Figure 1-34a: Occupied Bandwidth, PCS1900 Band, High Channel in EDGE mode

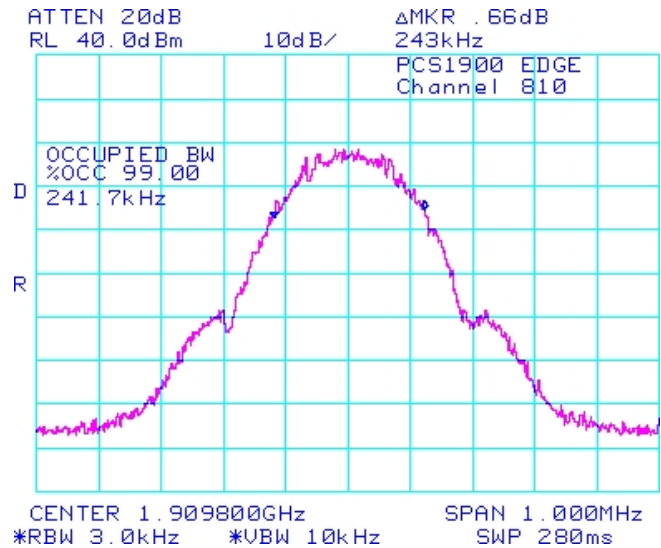

Figure 1-35a: GSM850 Band, Low Channel Mask in EDGE mode

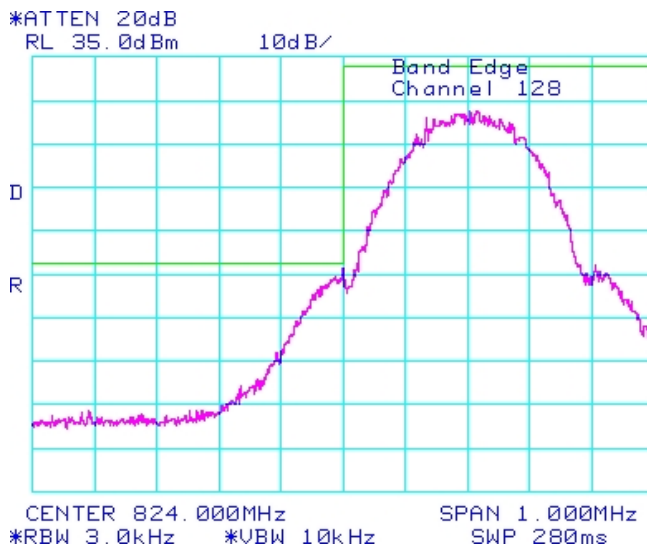
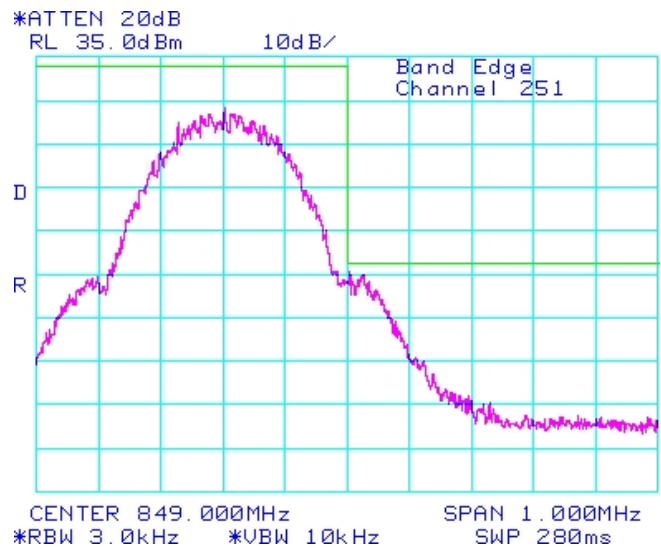

Figure 1-36a: GSM850 Band, High Channel Mask in EDGE mode



Test Report No.
RTS-2604-1106-131A

Dates of Test
May 25, June 2 to June 28, 2011

FCC ID: L6ARDR60CW, L6ARDS40CW
IC: 2503A-RDR60CW, 2503A-RDS40CW

GSM Conducted RF Emission Test Data cont'd

Figure 1-37a: PCS1900 Band, Low Channel Mask in EDGE mode

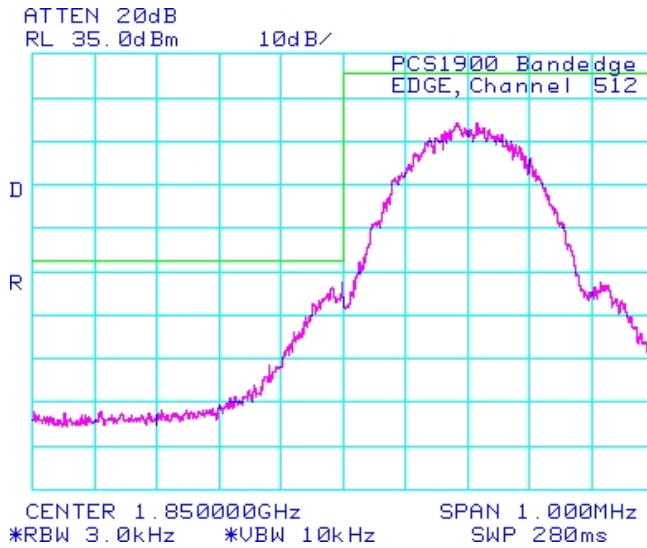
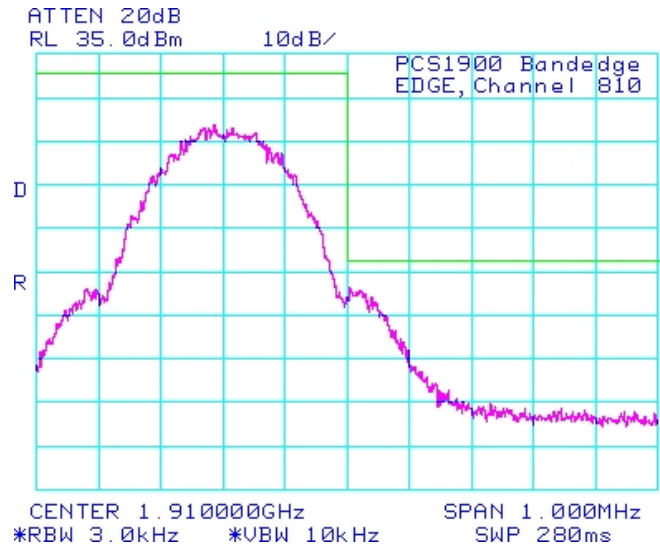

Figure 1-38a: PCS1900 Band, High Channel Mask in EDGE mode



Test Report No.
RTS-2604-1106-131A

Dates of Test
May 25, June 2 to June 28, 2011

FCC ID: L6ARDR60CW, L6ARDS40CW
IC: 2503A-RDR60CW, 2503A-RDS40CW

GSM Conducted RF Emission Test Data cont'd

Figure 1-39a: GSM850 band, Spurious Conducted Emissions, Low channel in Edge Mode

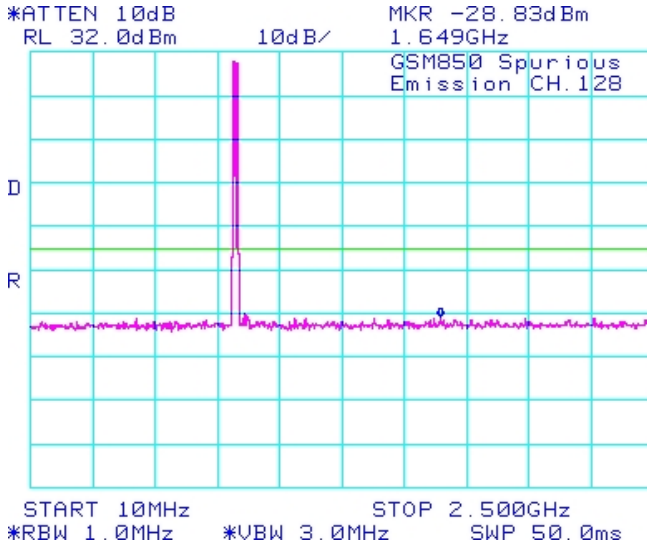

Figure 1-40a: GSM850 band, Spurious Conducted Emissions, Low channel in Edge Mode

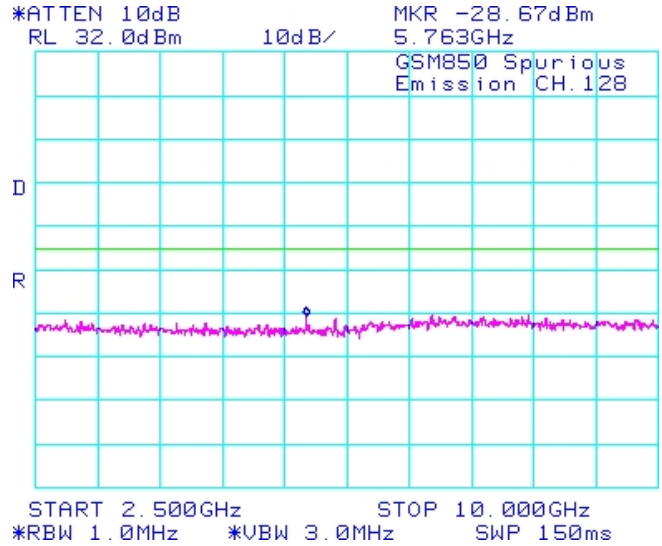

Figure 1-41a: GSM850 band, Spurious Conducted Emissions, Middle channel in Edge Mode

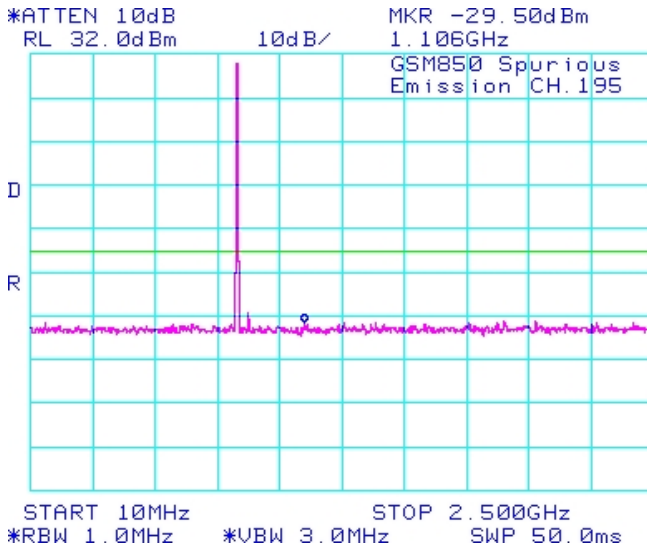
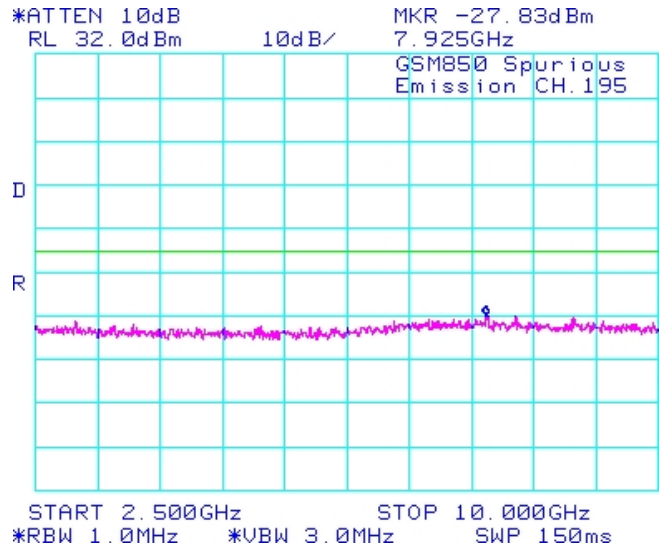

Figure 1-42a: GSM850 band, Spurious Conducted Emissions, Middle channel in Edge Mode



Test Report No.
RTS-2604-1106-131A

Dates of Test
May 25, June 2 to June 28, 2011

FCC ID: L6ARDR60CW, L6ARDS40CW
IC: 2503A-RDR60CW, 2503A-RDS40CW

GSM Conducted RF Emission Test Data cont'd

Figure 1-43a: GSM850 band, Spurious Conducted Emissions, High channel in Edge Mode

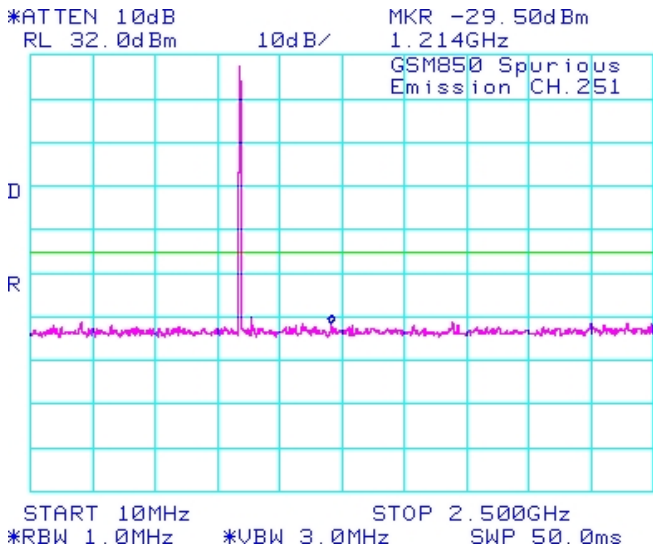

Figure 1-44a: GSM850 band, Spurious Conducted Emissions, High channel in Edge Mode

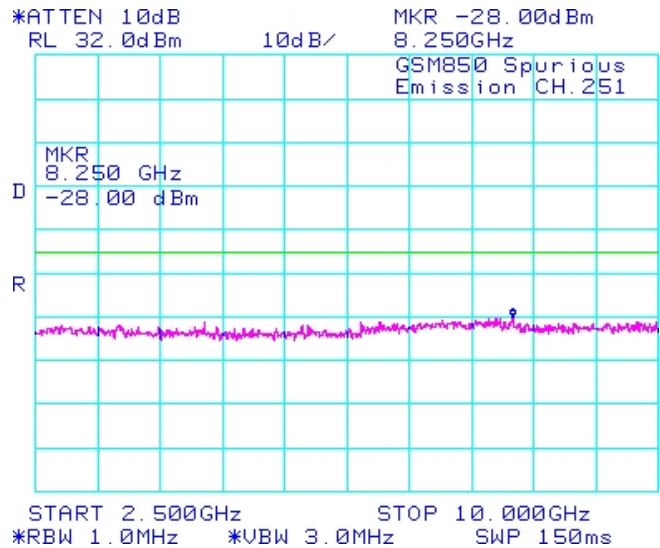

Figure 1-45a: PCS1900 band, Spurious Conducted Emissions, Low channel in Edge Mode

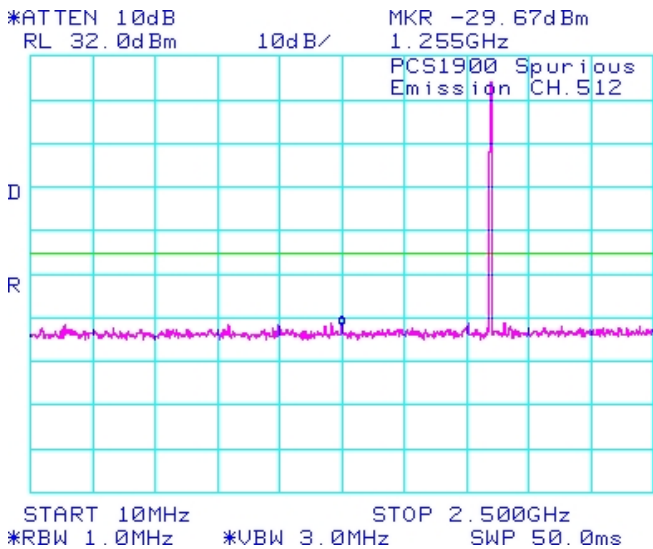
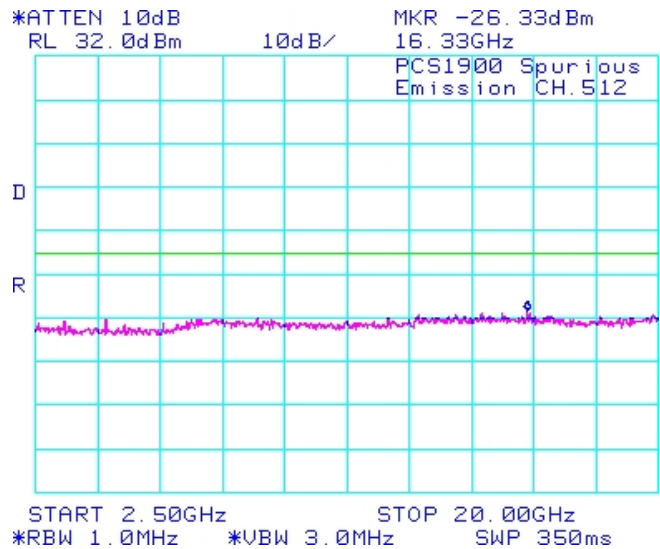

Figure 1-46a: PCS1900 band, Spurious Conducted Emissions, Low channel in Edge Mode



Test Report No.
RTS-2604-1106-131A

Dates of Test
May 25, June 2 to June 28, 2011

FCC ID: L6ARDR60CW, L6ARDS40CW
IC: 2503A-RDR60CW, 2503A-RDS40CW

GSM Conducted RF Emission Test Data cont'd

Figure 1-47a: PCS1900 band, Spurious Conducted Emissions, Low channel in Edge Mode

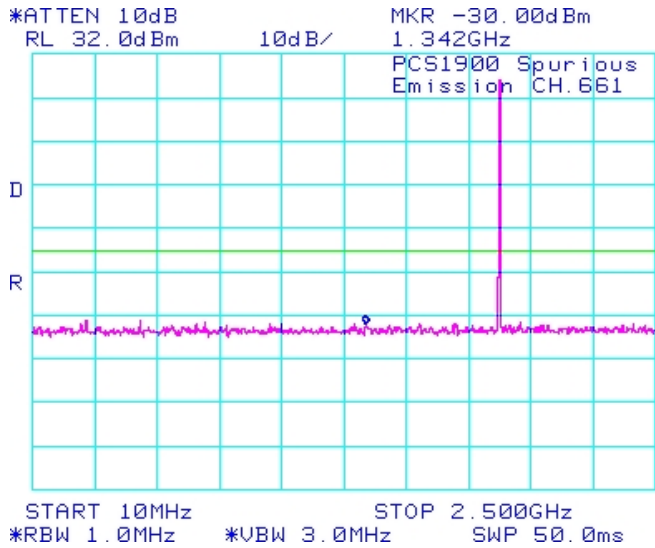

Figure 1-48a: PCS1900 band, Spurious Conducted Emissions, Low channel in Edge Mode

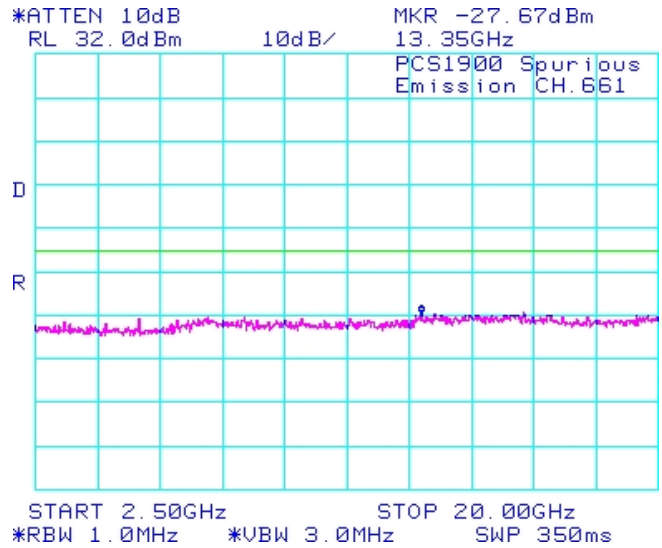

Figure 1-49a: PCS1900 band, Spurious Conducted Emissions, High channel in Edge Mode

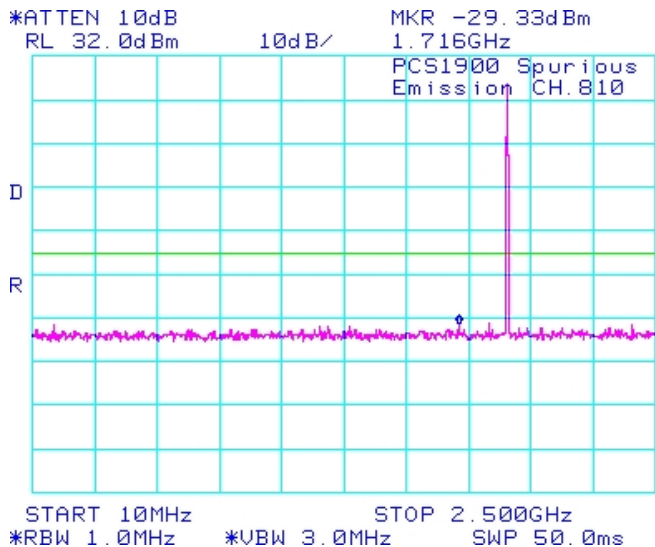
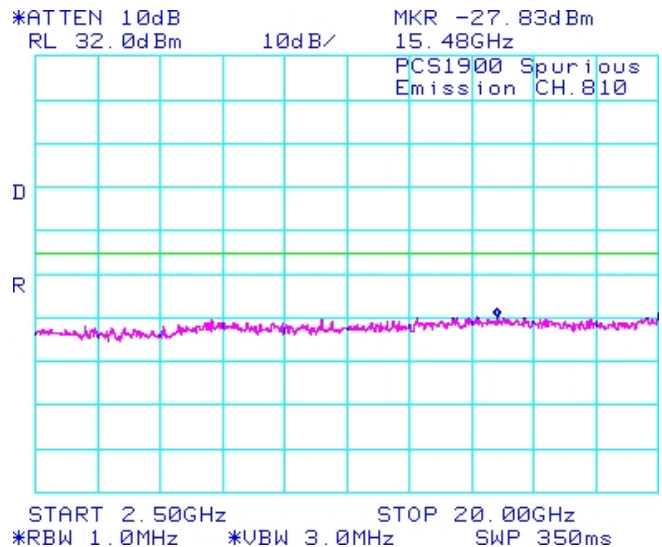



Figure 1-50a: PCS1900 band, Spurious Conducted Emissions, High channel in Edge Mode



APPENDIX 1B – CDMA CONDUCTED RF EMISSIONS TEST DATA/PLOTS

	EMI Test Report for the BlackBerry® smartphone Model RDR61CW,RDS41CW Appendix 1B	
Test Report No. RTS-2604-1106-131A	Dates of Test May 25, June 2 to June 28, 2011	FCC ID: L6ARDR60CW, L6ARDS40CW IC: 2503A-RDR60CW, 2503A-RDS40CW

CDMA Conducted RF Emission Test Data

This appendix contains measurement data pertaining to conducted spurious emissions, 99% power bandwidth and the channel mask.

Test Setup Diagram

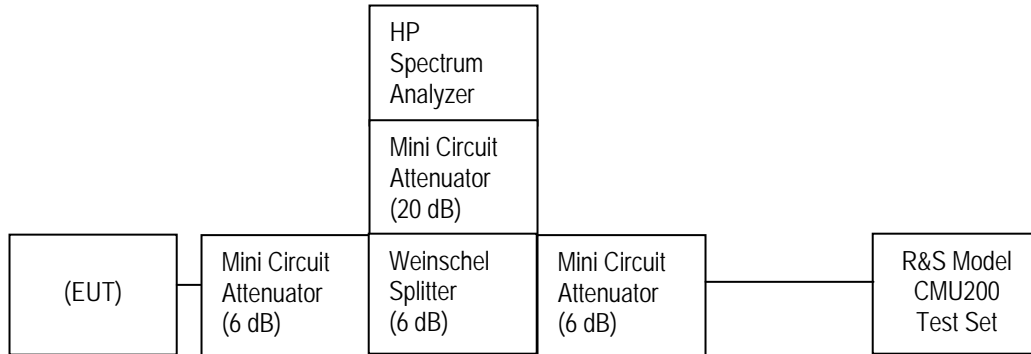

The environmental test conditions were: Temperature: 24.0 °C
 Relative Humidity: 47.0 %

	EMI Test Report for the BlackBerry® smartphone Model RDR61CW,RDS41CW Appendix 1B	
Test Report No. RTS-2604-1106-131A	Dates of Test May 25, June 2 to June 28, 2011	FCC ID: L6ARDR60CW, L6ARDS40CW IC: 2503A-RDR60CW, 2503A-RDS40CW

CDMA Conducted RF Emission Test Data cont'd

The conducted spurious emissions – As per 47 CFR 2.1051, CFR 24.238(a), CFR 4.202, CFR 22 Subpart H, RSS-132 and RSS - 133 were measured from 10 MHz to 20 GHz. See figures 1-1b to 1-12b for the plots of the conducted spurious emissions.

Date of Test: June 27, 2011

Test Data for Cellular and PCS selected Frequencies in Loopback mode

Cellular Frequency (MHz)	99% Occupied Bandwidth (MHz)
824.700	1.267
836.520	1.273
848.310	1.267

PCS Frequency (MHz)	99% Occupied Bandwidth (MHz)
1851.200	1.280
1880.000	1.280
1908.750	1.280

Test Data for Cellular and PCS selected Frequencies in Loopback mode

Refer to the following measurement plots for more detail.

See Figures 1-1b to 1-12b for the plots of the conducted spurious emissions.

See Figures 1-13b to 1-18b for the plots of 99% Occupied Bandwidth.

See Figures 1-19b to 1-24b for the plots of the Channel mask.

The RF power output was at maximum for all the recorded measurements shown below.

Test Report No.
RTS-2604-1106-131A

Dates of Test
May 25, June 2 to June 28, 2011

FCC ID: L6ARDR60CW, L6ARDS40CW
IC: 2503A-RDR60CW, 2503A-RDS40CW

CDMA Conducted RF Emission Test Data cont'd

Figure 1-1b: Cellular, Spurious Conducted Emissions, Low channel

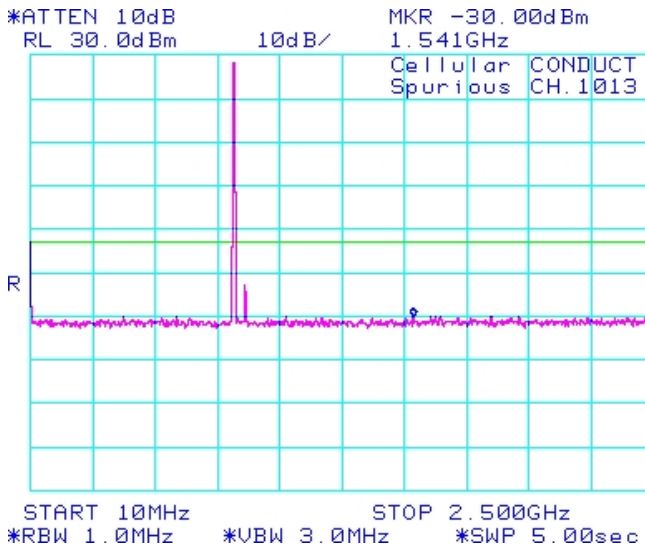

Figure 1-2b: Cellular, Spurious Conducted Emissions, Low channel

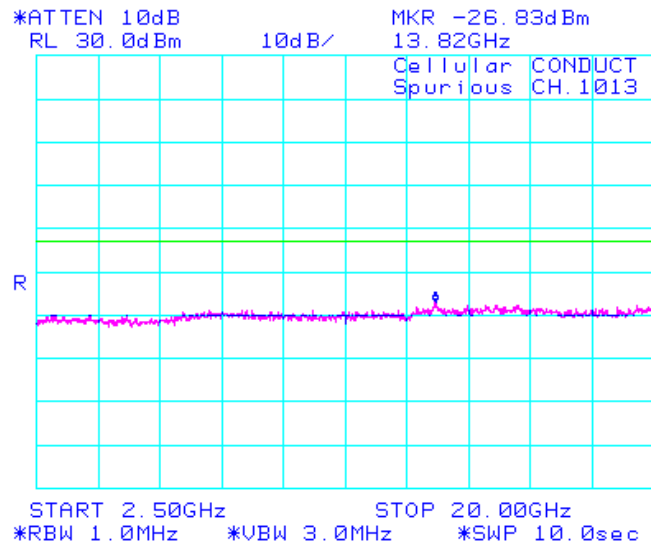

Figure 1-3b: Cellular, Spurious Conducted Emissions, Middle channel

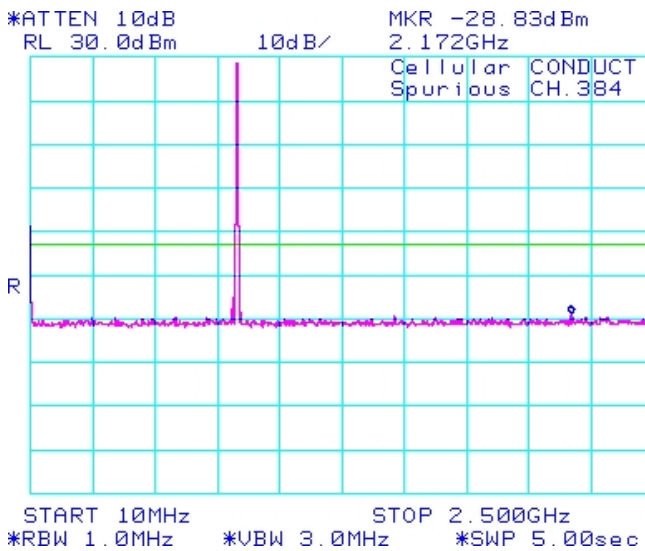
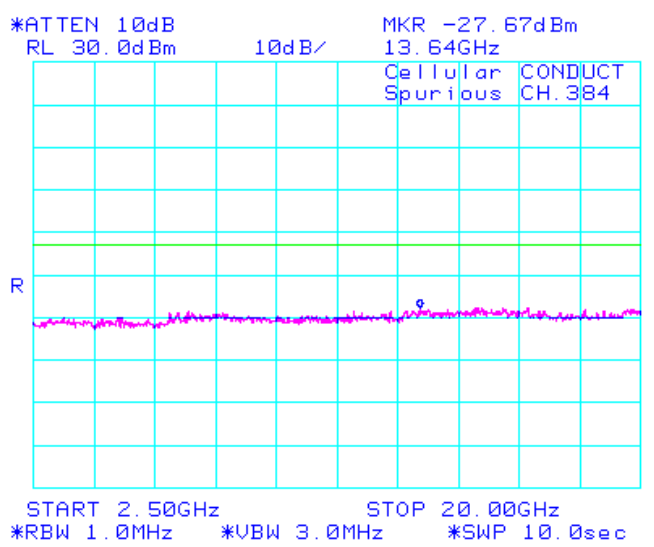

Figure 1-4b: Cellular, Spurious Conducted Emissions, Middle channel



Test Report No.
RTS-2604-1106-131A

Dates of Test
May 25, June 2 to June 28, 2011

FCC ID: L6ARDR60CW, L6ARDS40CW
IC: 2503A-RDR60CW, 2503A-RDS40CW

UMTS Conducted RF Emission Test Data cont'd

Figure 7-5b: Cellular, Spurious Conducted Emissions, High Channel

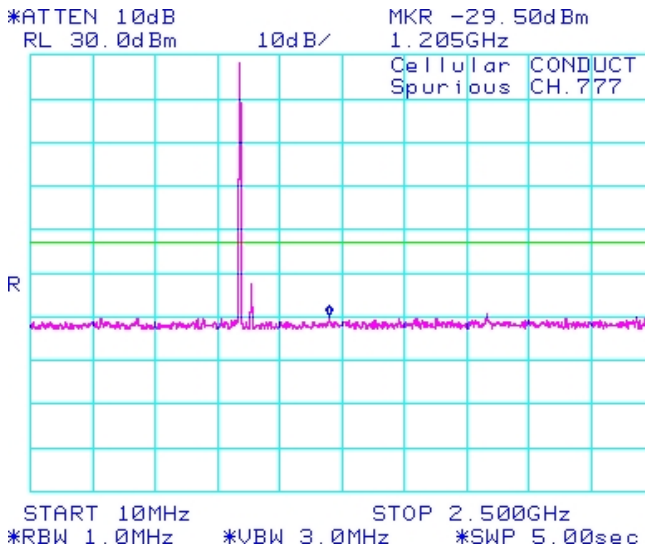

Figure 1-6b: Cellular, Spurious Conducted Emissions, High Channel

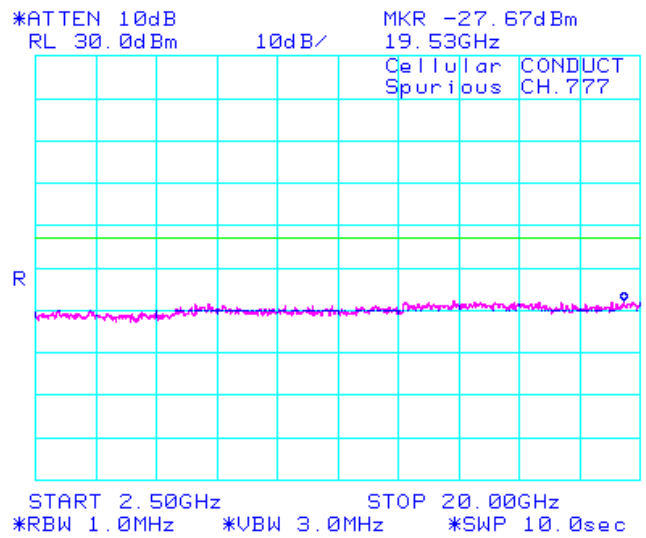

Figure 1-7b: PCS, Spurious Conducted Emissions, Low Channel

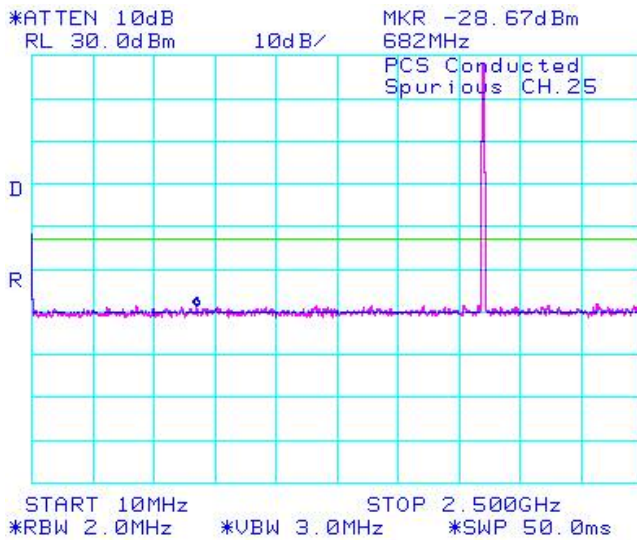
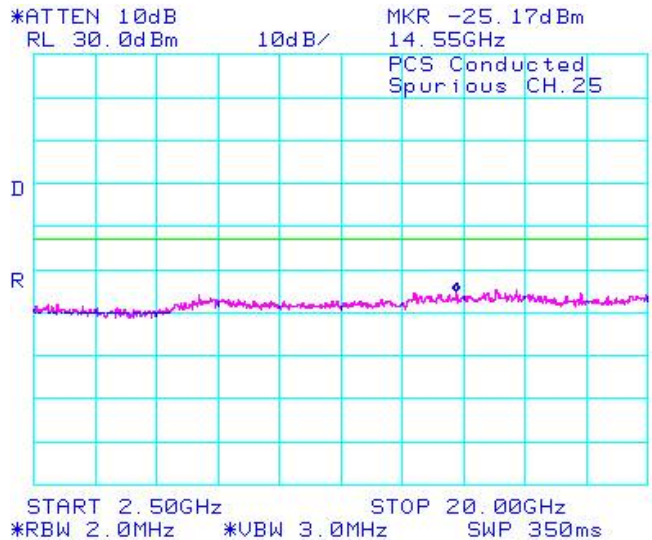

Figure 1-8b: PCS, Spurious Conducted Emissions, Low Channel



Test Report No.
RTS-2604-1106-131A

Dates of Test
May 25, June 2 to June 28, 2011

FCC ID: L6ARDR60CW, L6ARDS40CW
IC: 2503A-RDR60CW, 2503A-RDS40CW

CDMA Conducted RF Emission Test Data cont'd

Figure 1-9b: PCS, Spurious Conducted Emissions, Middle Channel

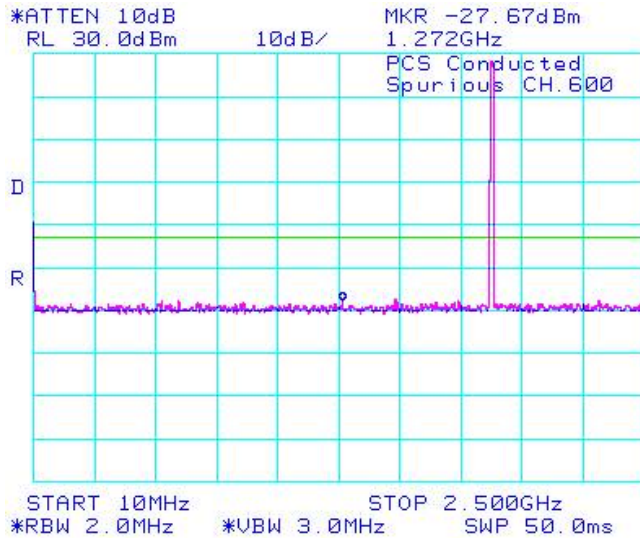

Figure 1-10b: PCS, Spurious Conducted Emissions, Middle Channel

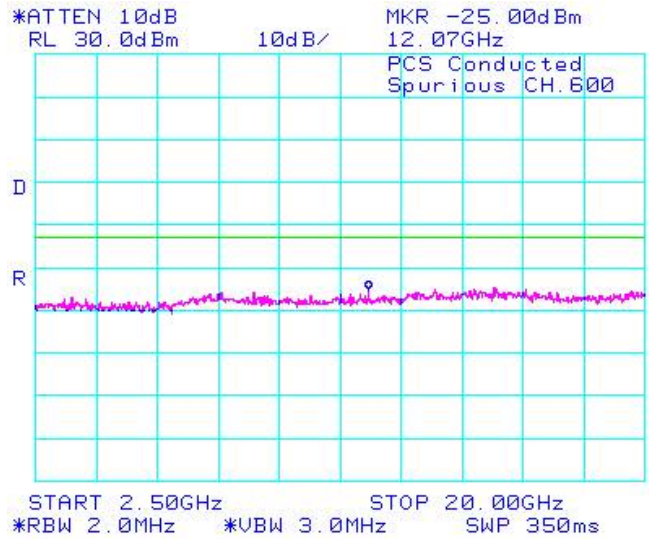

Figure 1-11b: PCS, Spurious Conducted Emissions, High Channel

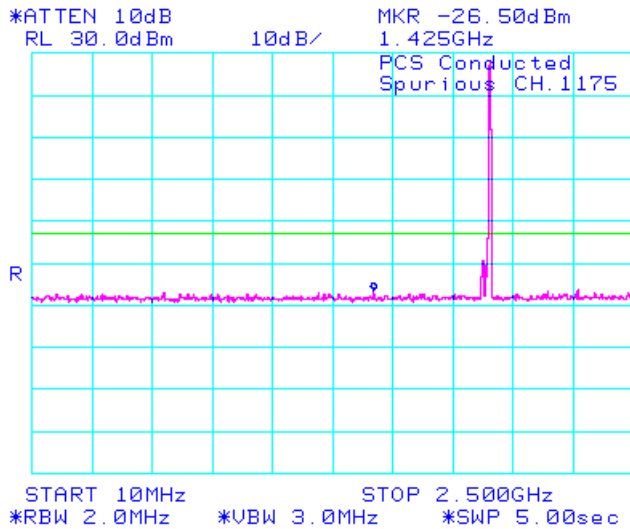
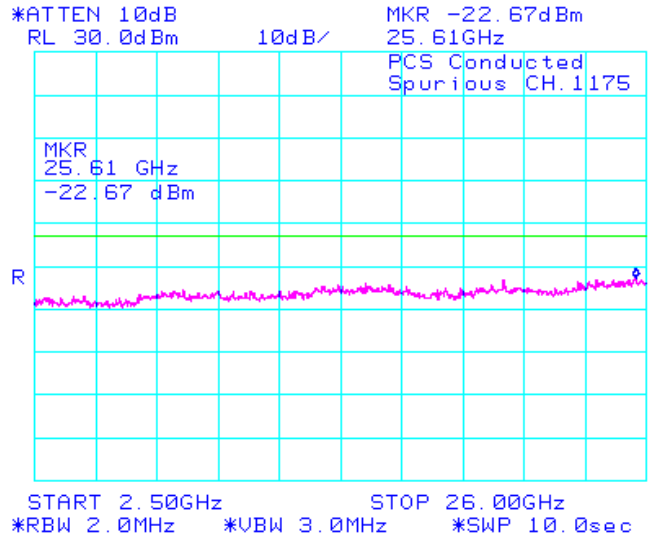

Figure 1-12b: PCS, Spurious Conducted Emissions, High Channel



Test Report No.
RTS-2604-1106-131A

Dates of Test
May 25, June 2 to June 28, 2011

FCC ID: L6ARDR60CW, L6ARDS40CW
IC: 2503A-RDR60CW, 2503A-RDS40CW

CDMA Conducted RF Emission Test Data cont'd

Figure 1-13b: Occupied Bandwidth, Cellular Low Channel

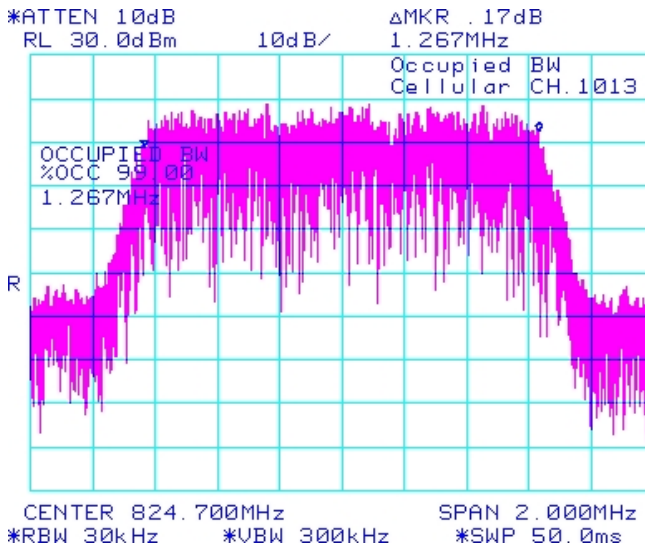

Figure 1-14b: Occupied Bandwidth, Cellular Middle Channel

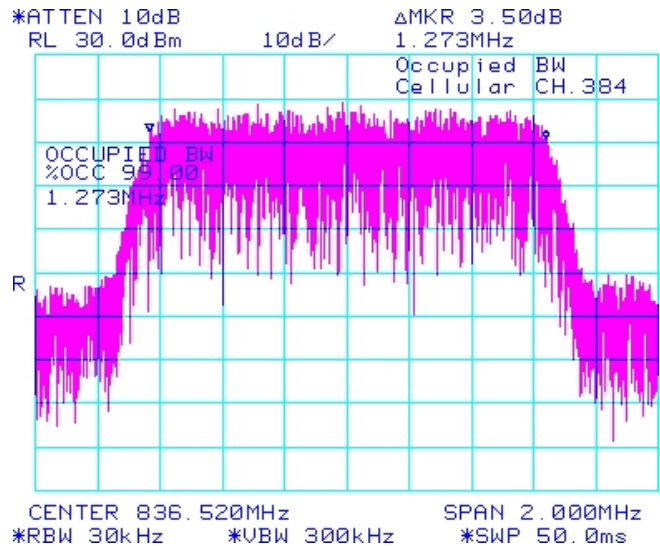

Figure 1-15b: Occupied Bandwidth, Cellular High Channel

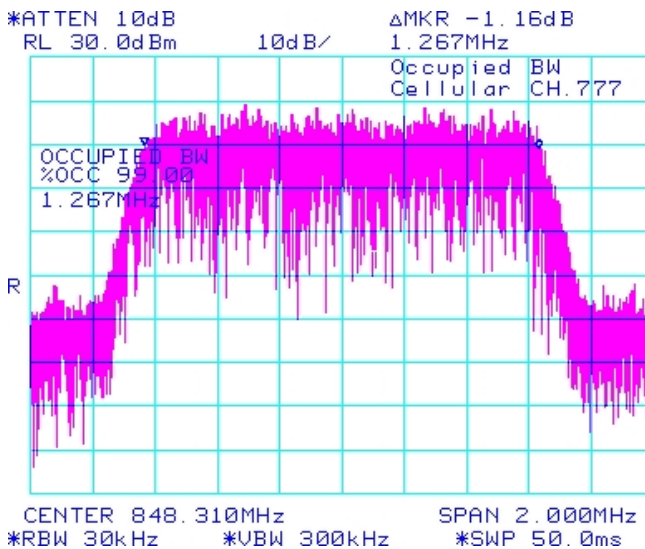
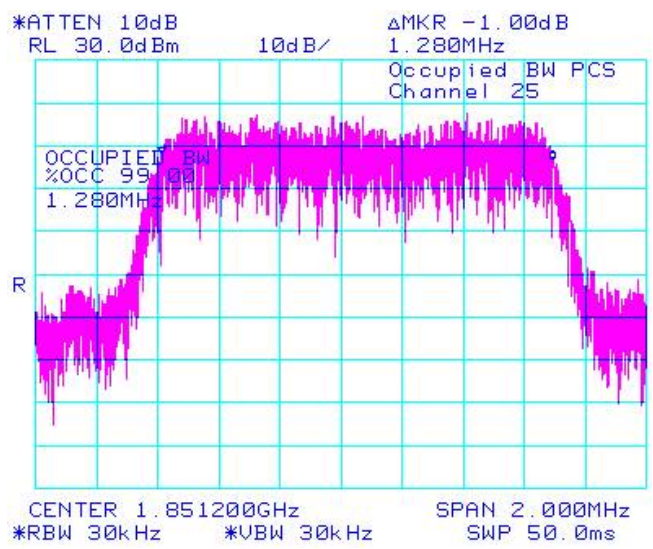

Figure 1-16b: Occupied Bandwidth, PCS Low Channel



Test Report No.
RTS-2604-1106-131A

Dates of Test
May 25, June 2 to June 28, 2011

FCC ID: L6ARDR60CW, L6ARDS40CW
IC: 2503A-RDR60CW, 2503A-RDS40CW

CDMA Conducted RF Emission Test Data cont'd

Figure 1-17b: Occupied Bandwidth, PCS Middle Channel

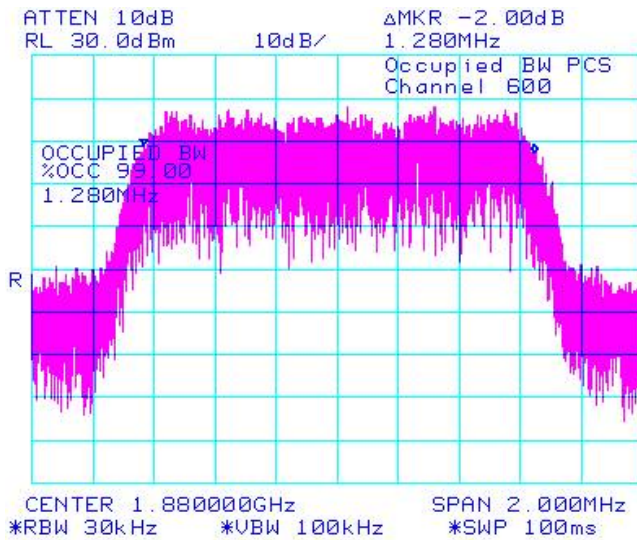

Figure 1-18b: Occupied Bandwidth, PCS High Channel

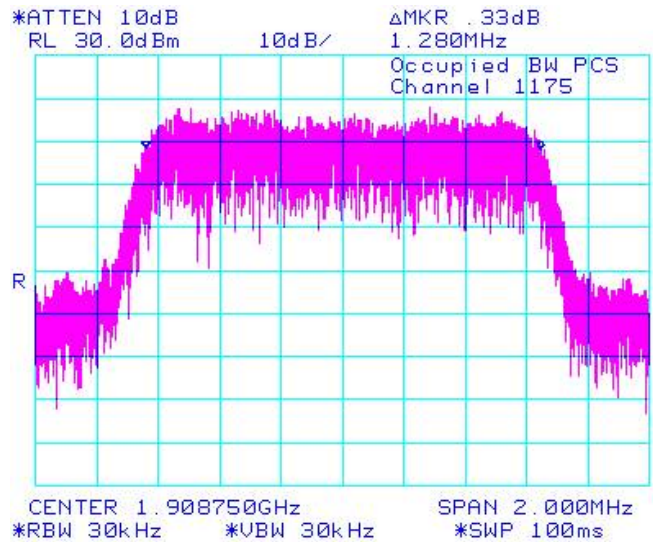

Figure 1-19b: Cellular Low Channel Mask

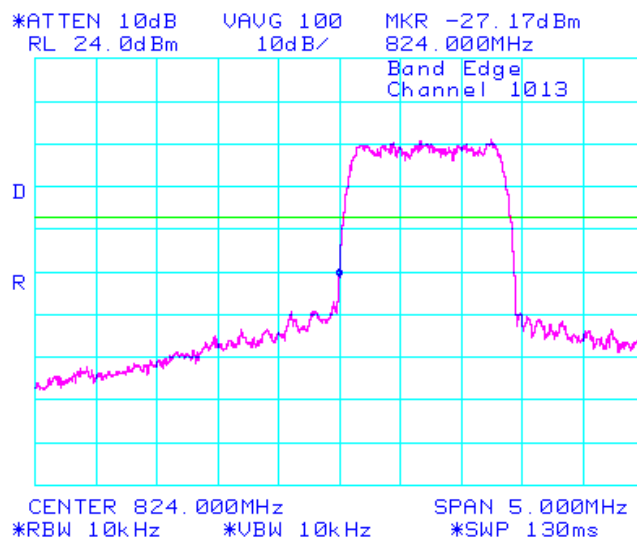
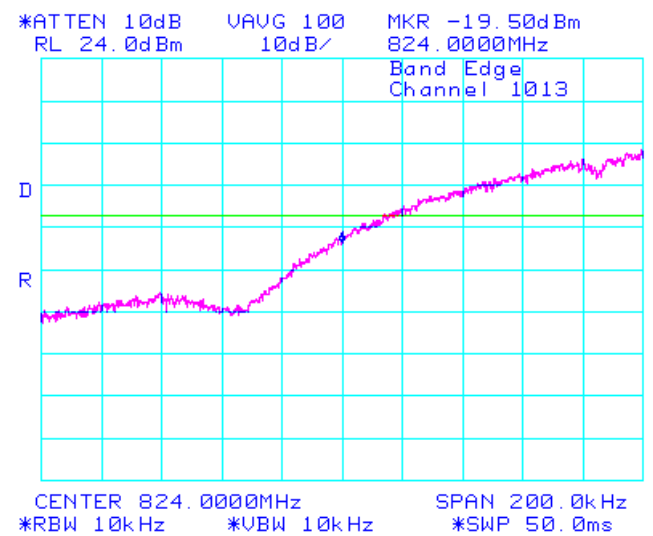

Figure 1-20b: Cellular Low Channel Mask



Test Report No.
RTS-2604-1106-131A

Dates of Test
May 25, June 2 to June 28, 2011

FCC ID: L6ARDR60CW, L6ARDS40CW
IC: 2503A-RDR60CW, 2503A-RDS40CW

CDMA Conducted RF Emission Test Data cont'd

Figure 1-21b: Cellular High Channel Mask

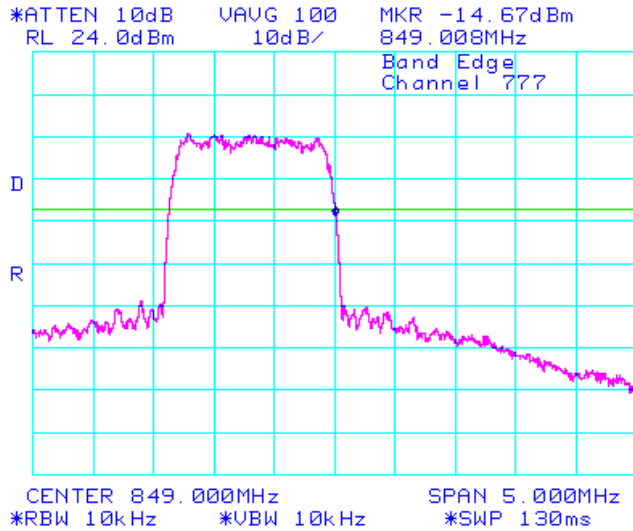

Figure 1-22b: Cellular High Channel Mask

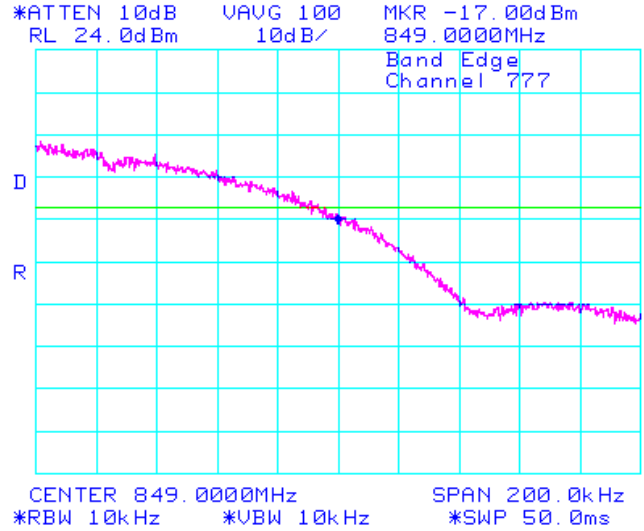

Figure 1-23b: PCS Low Channel Mask

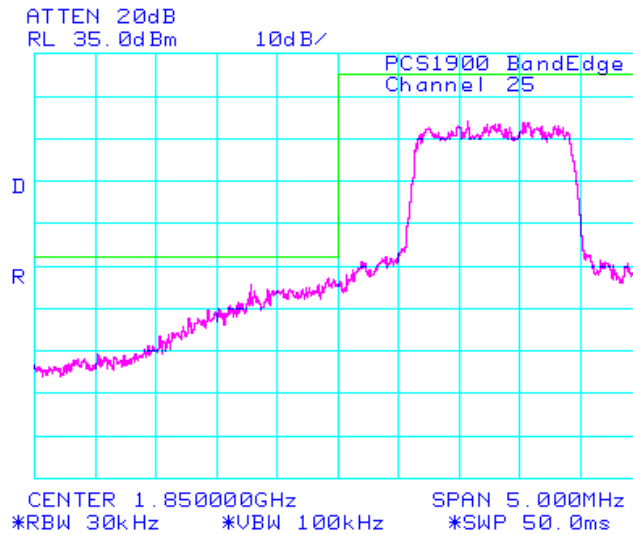
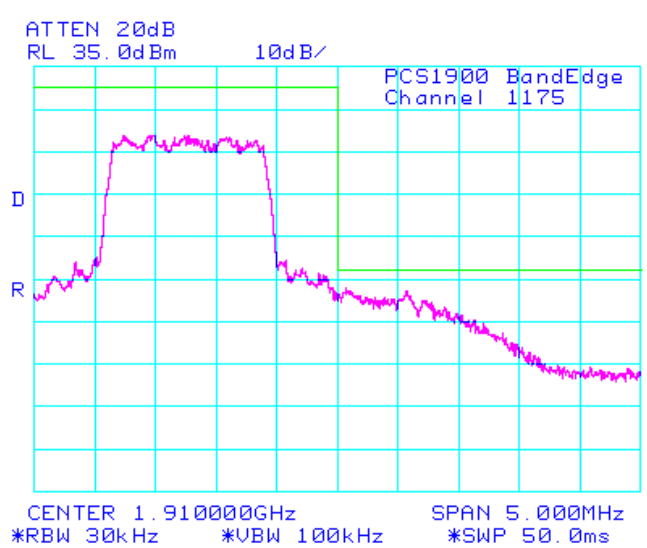



Figure 1-24b: PCS High Channel Mask



		EMI Test Report for the BlackBerry® smartphone Model RDR61CW,RDS41CW Appendix 1B
Test Report No. RTS-2604-1106-131A	Dates of Test May 25, June 2 to June 28, 2011	FCC ID: L6ARDR60CW, L6ARDS40CW IC: 2503A-RDR60CW, 2503A-RDS40CW

CDMA Conducted RF Emission Test Data cont'd

The conducted spurious emissions – As per 47 CFR 2.1051, CFR 24.238(a), CFR 22 Subpart H, RSS-132 and RSS - 133 were measured from 10 MHz to 20 GHz. See figures 1-29b to 1-40b for the plots of the conducted spurious emissions. Date of Test: June 28, 2011

The environmental test conditions were: Temperature: 24.0 °C
Relative Humidity: 49.0 %

Test Data for Cellular and PCS selected Frequencies in 1xEVDO mode

Cellular Frequency (MHz)	99% Occupied Bandwidth (MHz)
824.700	1.273
836.520	1.280
848.310	1.280

PCS Frequency (MHz)	99% Occupied Bandwidth (MHz)
1851.200	1.290
1880.000	1.280
1908.750	1.290

Measurement Plots for Cellular and PCS in 1xEVDO mode

Refer to the following measurement plots for more detail.

See Figures 1-23b to 1-34b for the plots of the conducted spurious emissions.
See Figures 1-35b to 1-39b for the plots of 99% Occupied Bandwidth.
See Figures 1-40b to 1-45b for the plots of the Channel mask.

The RF power output was at maximum for all the recorded measurements shown below.

Test Report No.
RTS-2604-1106-131A

Dates of Test
May 25, June 2 to June 28, 2011

FCC ID: L6ARDR60CW, L6ARDS40CW
IC: 2503A-RDR60CW, 2503A-RDS40CW

CDMA EVDO Conducted RF Emission Test Data cont'd

Figure 1-23b: Cellular , Spurious Conducted Emissions, Low channel

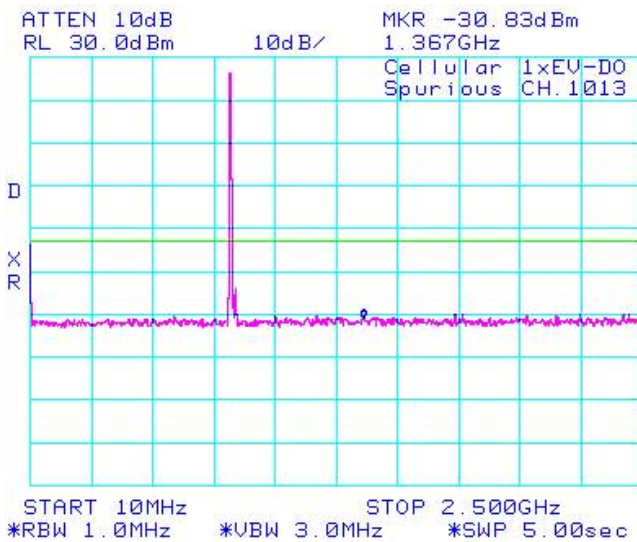

Figure 1-24b: Cellular , Spurious Conducted Emissions, Low channel

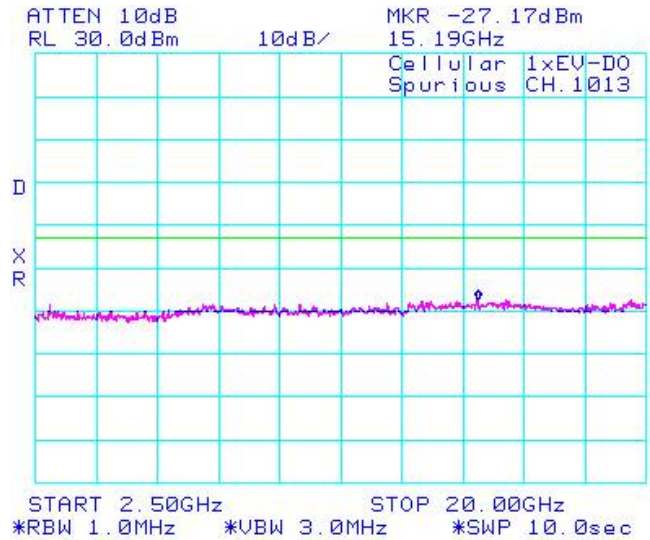

Figure 1-25b: Cellular , Spurious Conducted Emissions, Middle channel

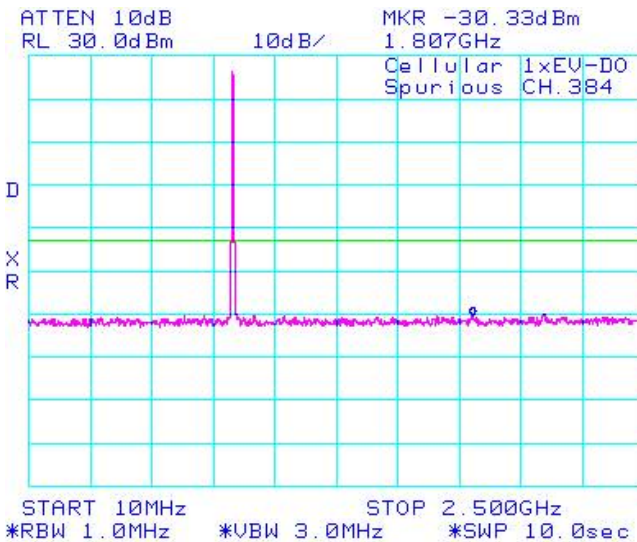
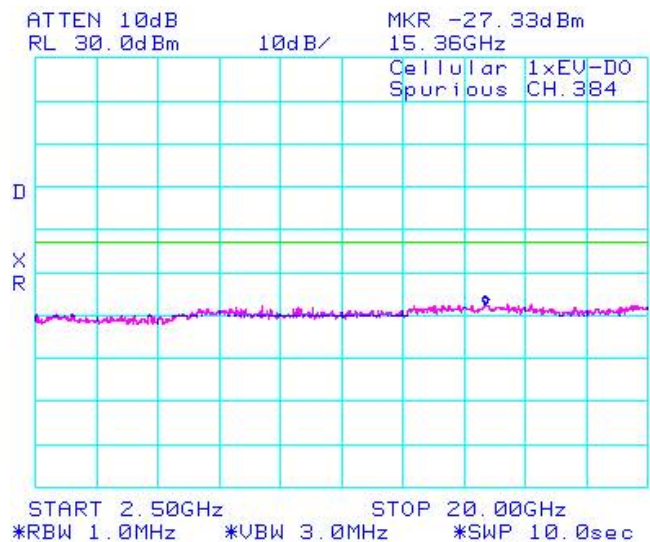

Figure 1-26b: Cellular , Spurious Conducted Emissions, Middle channel



Test Report No.
RTS-2604-1106-131A

Dates of Test
May 25, June 2 to June 28, 2011

FCC ID: L6ARDR60CW, L6ARDS40CW
IC: 2503A-RDR60CW, 2503A-RDS40CW

CDMA Conducted RF Emission Test Data cont'd

Figure 8-27b: Cellular , Spurious Conducted Emissions, High Channel

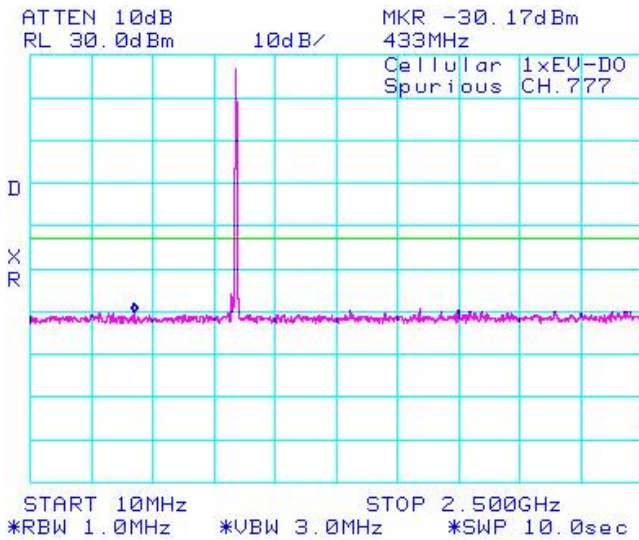

Figure 1-28b: Cellular , Spurious Conducted Emissions, High Channel

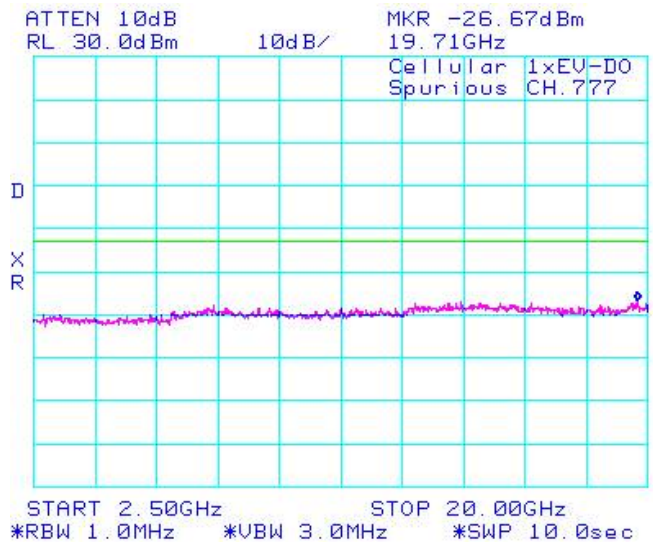

Figure 1-29b: CDMA PCS, Spurious Conducted Emissions, Low Channel

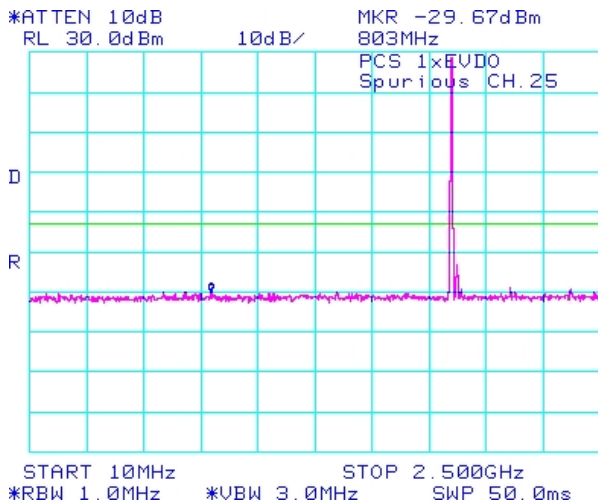
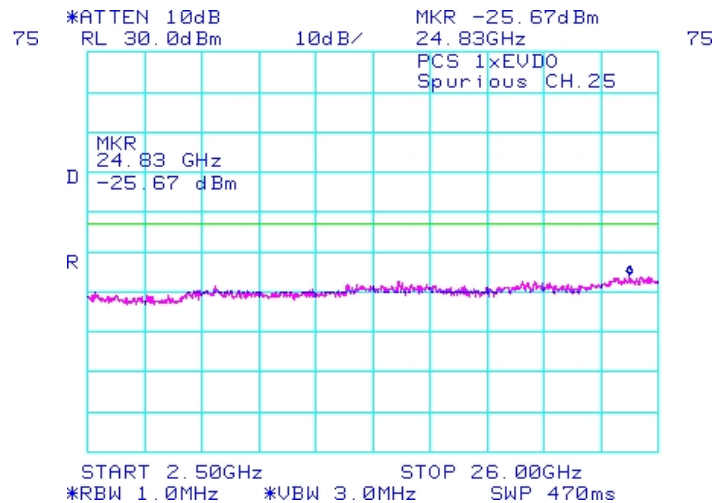

Figure 1-30b: CDMA PCS, Spurious Conducted Emissions, Low Channel



Test Report No.
RTS-2604-1106-131A

Dates of Test
May 25, June 2 to June 28, 2011

FCC ID: L6ARDR60CW, L6ARDS40CW
IC: 2503A-RDR60CW, 2503A-RDS40CW

CDMA Conducted RF Emission Test Data cont'd

Figure 1-31b: CDMA PCS, Spurious Conducted Emissions, Middle Channel

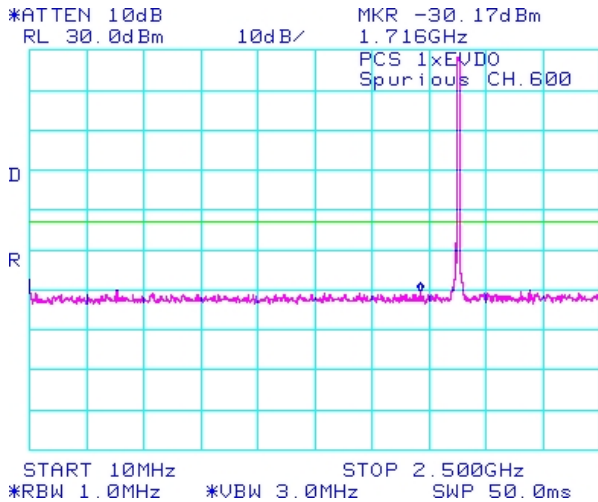

Figure 1-32b: CDMA PCS, Spurious Conducted Emissions, Middle Channel

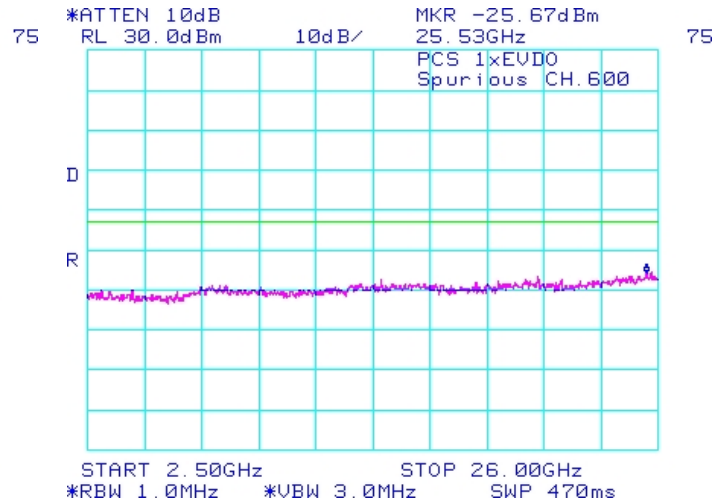

Figure 1-33b: CDMA PCS, Spurious Conducted Emissions, High Channel

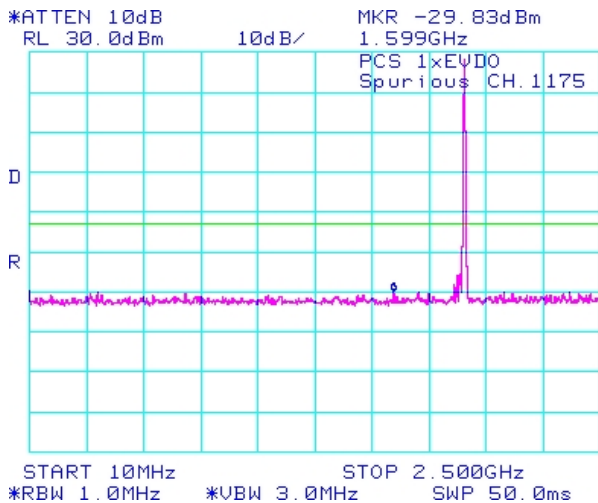
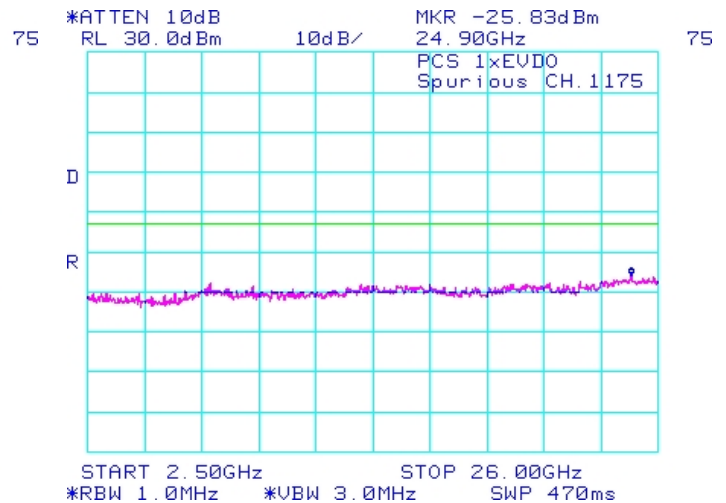

Figure 1-34b: CDMA PCS, Spurious Conducted Emissions, High Channel



Test Report No.
RTS-2604-1106-131A

Dates of Test
May 25, June 2 to June 28, 2011

FCC ID: L6ARDR60CW, L6ARDS40CW
IC: 2503A-RDR60CW, 2503A-RDS40CW

CDMA Conducted RF Emission Test Data cont'd

Figure 1-35b: Occupied Bandwidth, Cellular Low Channel

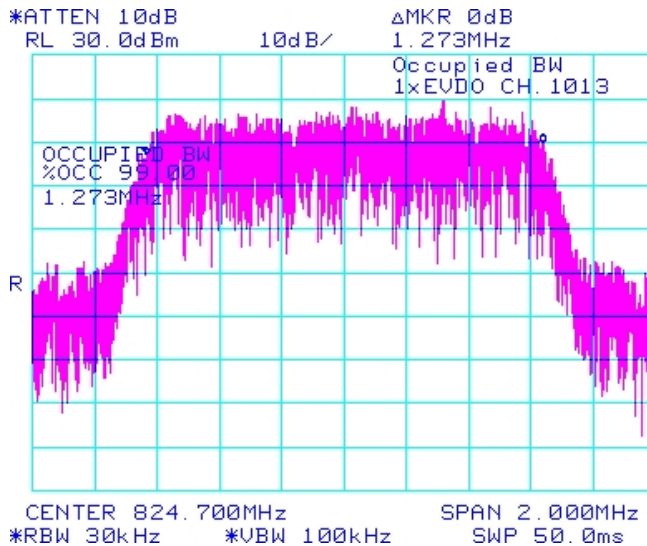

Figure 1-36b: Occupied Bandwidth, Cellular Middle Channel

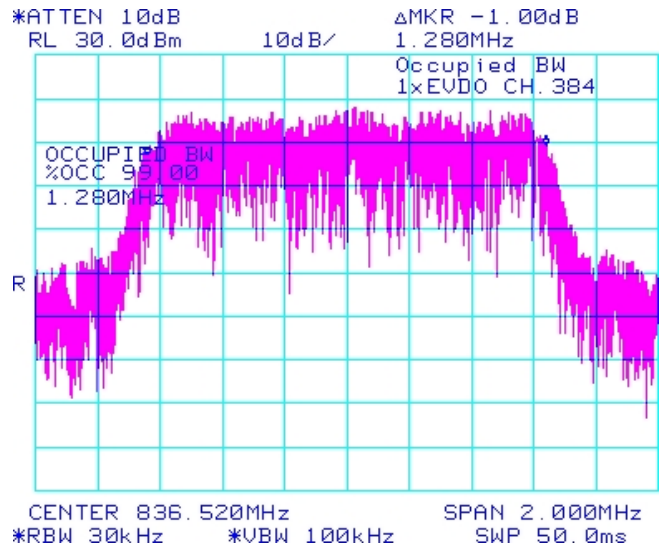

Figure 1-37b: Occupied Bandwidth, Cellular High Channel

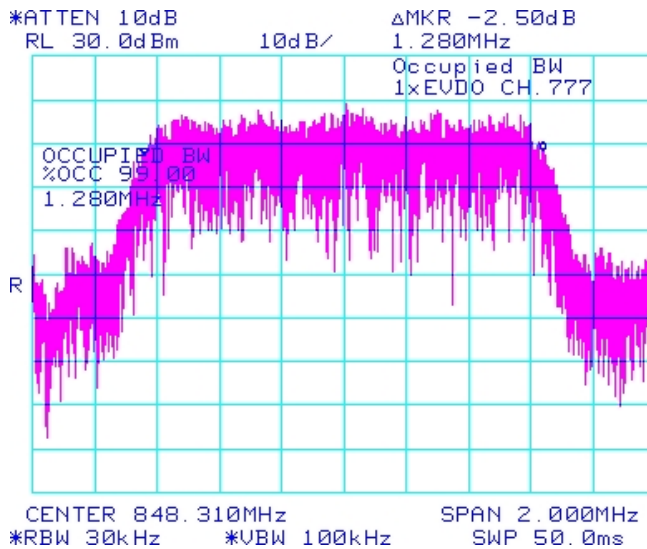
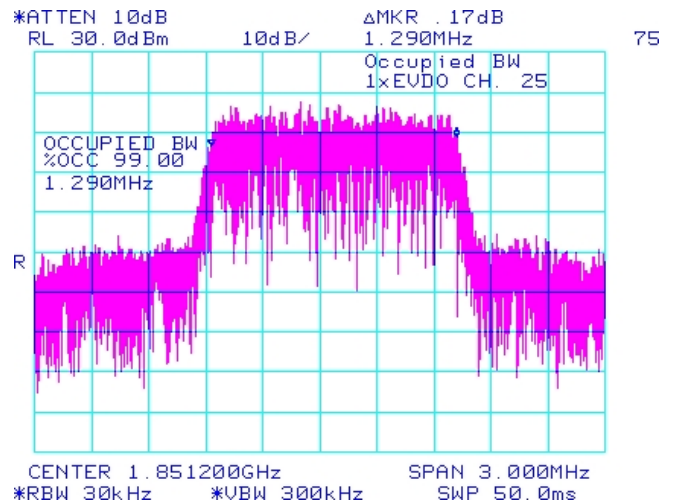

Figure 1-38b: Occupied Bandwidth, PCS Low Channel



Test Report No.
RTS-2604-1106-131A

Dates of Test
May 25, June 2 to June 28, 2011

FCC ID: L6ARDR60CW, L6ARDS40CW
IC: 2503A-RDR60CW, 2503A-RDS40CW

CDMA Conducted RF Emission Test Data cont'd

Figure 1-38b: Occupied Bandwidth, PCS Middle Channel

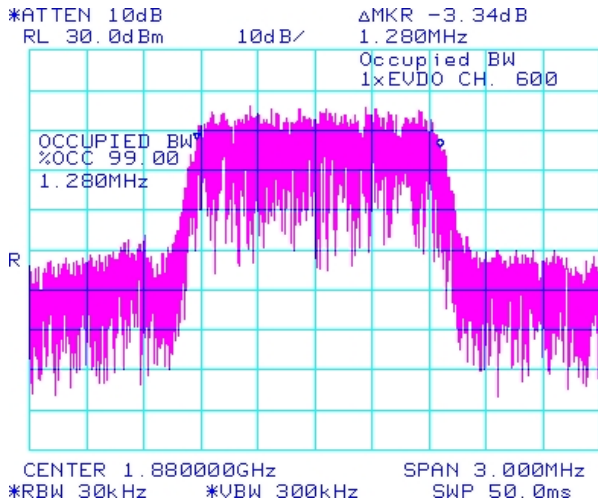

Figure 1-39b: Occupied Bandwidth, PCS High Channel

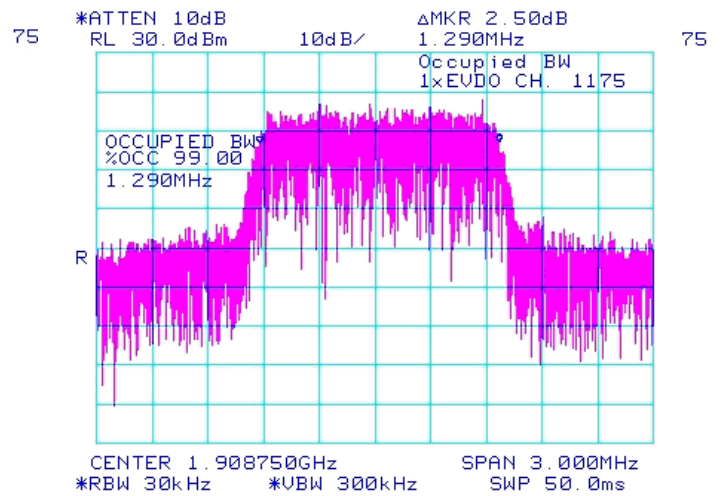

Figure 1-40b: Cellular , Low Channel Mask

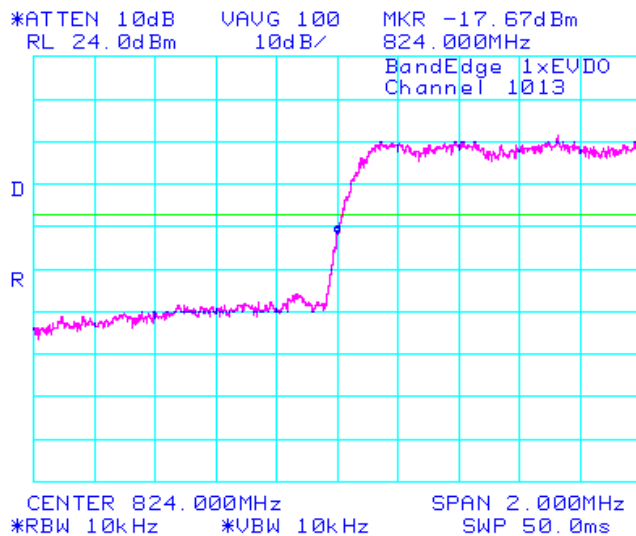
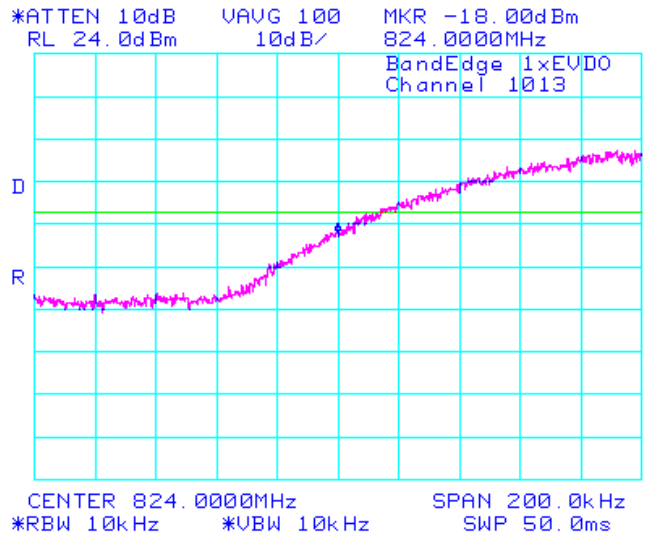

Figure 1-41b: Cellular , Low Channel Mask



Test Report No.
RTS-2604-1106-131A

Dates of Test
May 25, June 2 to June 28, 2011

FCC ID: L6ARDR60CW, L6ARDS40CW
IC: 2503A-RDR60CW, 2503A-RDS40CW

CDMA Conducted RF Emission Test Data cont'd

Figure 1-42b: Cellular , High Channel Mask

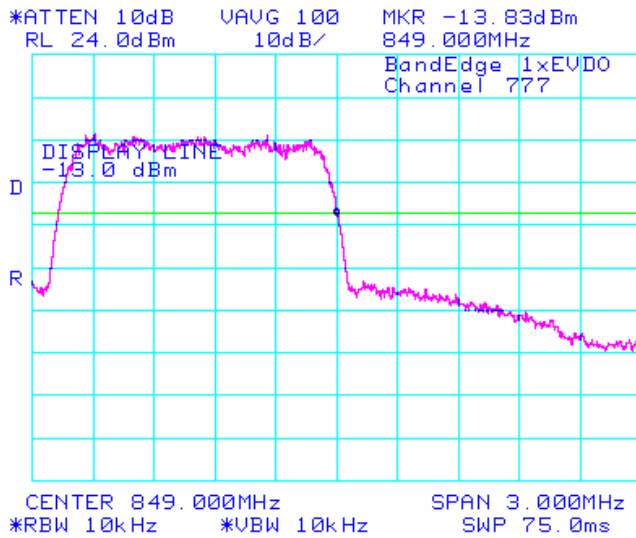

Figure 1-43b: Cellular , High Channel Mask

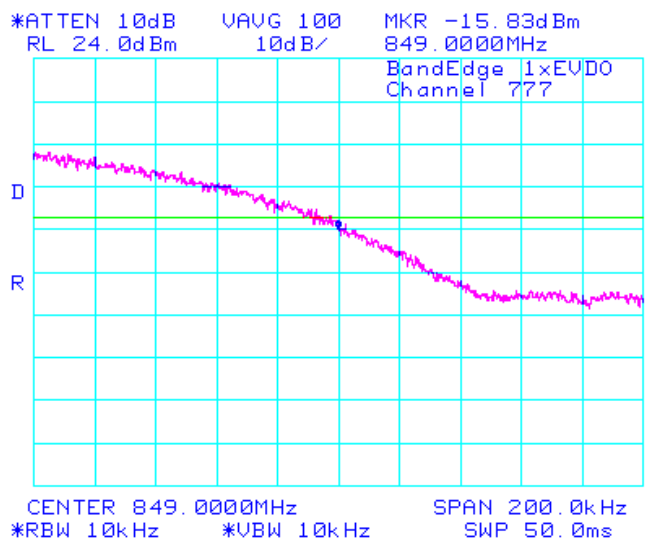

Figure 1-44b: PCS , Low Channel Mask

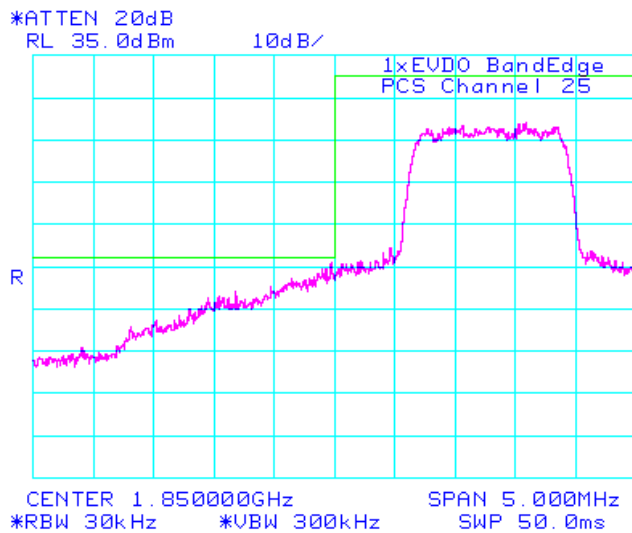
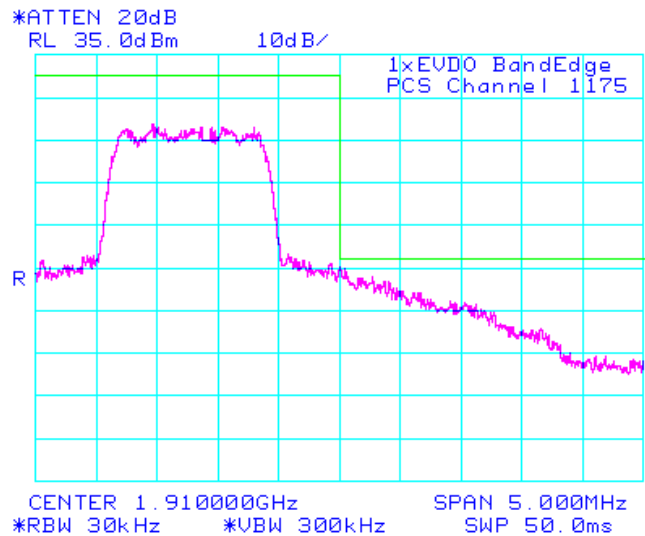



Figure 1-45b: PCS , High Channel Mask



APPENDIX 1C – CDMA BC10 CONDUCTED RF EMISSIONS TEST DATA/PLOTS

	EMI Test Report for the BlackBerry® smartphone Model RDR61CW,RDS41CW Appendix 1C	
Test Report No. RTS-2604-1106-131A	Dates of Test May 25, June 2 to June 28, 2011	FCC ID: L6ARDR60CW, L6ARDS40CW IC: 2503A-RDR60CW, 2503A-RDS40CW

CDMA Conducted RF Emission Test Data

This appendix contains measurement data pertaining to conducted spurious emissions, 99% power bandwidth and the channel mask on BlackBerry® smartphone.

Test Setup Diagram

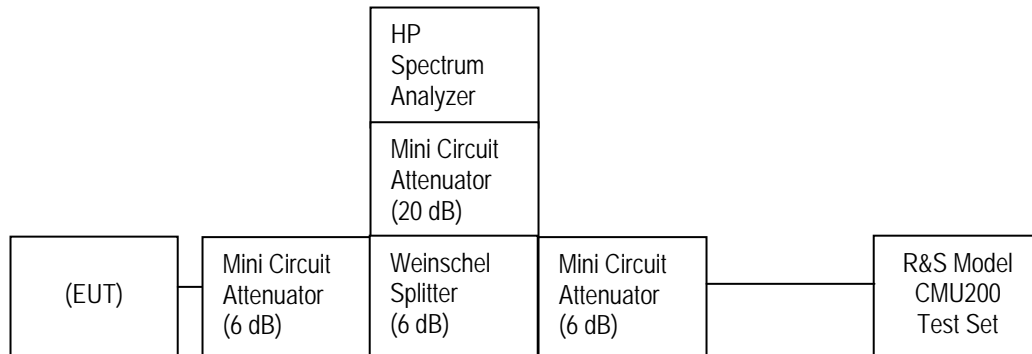

The environmental test conditions were: Temperature: 23.0 °C
Relative Humidity: 45.0 %

	EMI Test Report for the BlackBerry® smartphone Model RDR61CW,RDS41CW Appendix 1C	
Test Report No. RTS-2604-1106-131A	Dates of Test May 25, June 2 to June 28, 2011	FCC ID: L6ARDR60CW, L6ARDS40CW IC: 2503A-RDR60CW, 2503A-RDS40CW

CDMA Conducted RF Emission Test Data cont'd

The conducted spurious emissions – As per 47 CFR 2 Subpart J, CFR 90(I), CFR 90 (J), 90.210, and 90.691 were measured from 10 MHz to 10 GHz.
See figures 1-1b to 1-12b for the plots of the conducted spurious emissions.

Date of Test: May 25, 2011

Test Data for Cellular selected Frequencies in CDMA2000 BC10 mode

Cellular Frequency (MHz)	99% Occupied Bandwidth (MHz)
817.90	1.290
820.50	1.285
823.10	1.290

Test Data for Cellular selected Frequencies in CDMA2000 BC10 mode

Refer to the following measurement plots for more detail.

See Figures 1-1b to 1-6b for the plots of the conducted spurious emissions.
See Figures 1-7b to 1-9b for the plots of 99% Occupied Bandwidth.
See Figures 1-10b to 1-11b for the plots of the Channel mask.

The RF power output was at maximum for all the recorded measurements shown below.

Test Report No. RTS-2604-1106-131A	Dates of Test May 25, June 2 to June 28, 2011	FCC ID: L6ARDR60CW, L6ARDS40CW IC: 2503A-RDR60CW, 2503A-RDS40CW
--	---	--

CDMA Conducted RF Emission Test Data cont'd

Figure 1-1b: Cellular, Spurious Conducted Emissions, Low channel

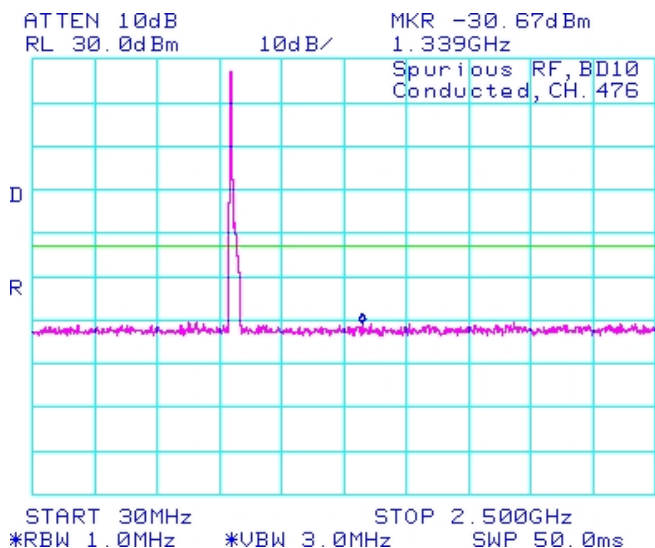

Figure 1-2b: Cellular, Spurious Conducted Emissions, Low channel

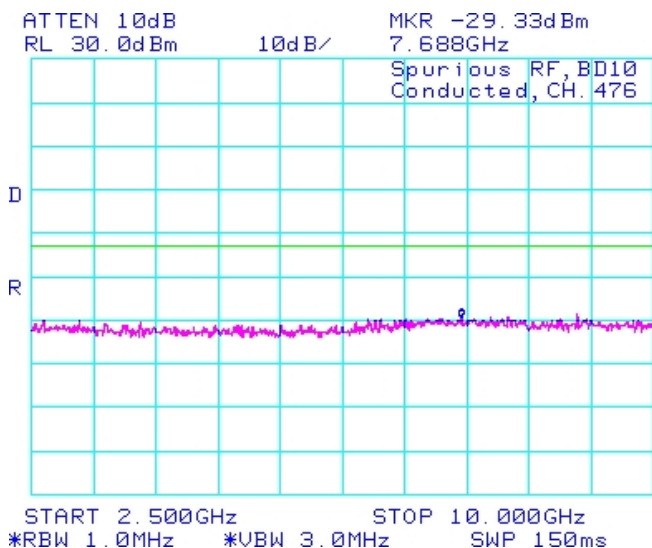

Figure 1-3b: Cellular, Spurious Conducted Emissions, Middle channel

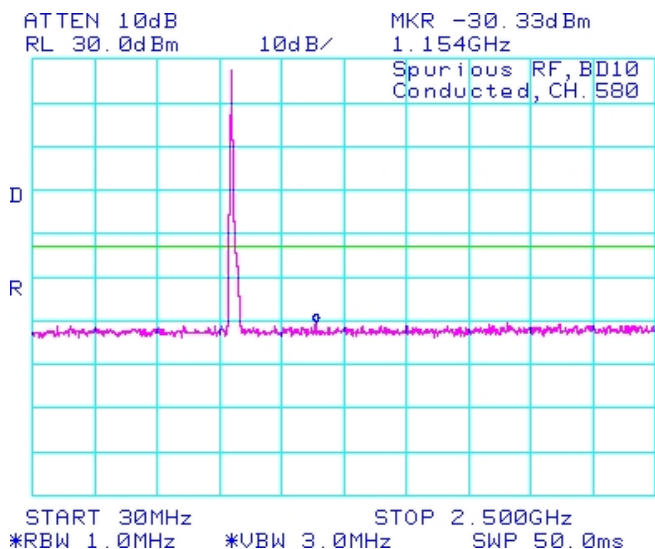
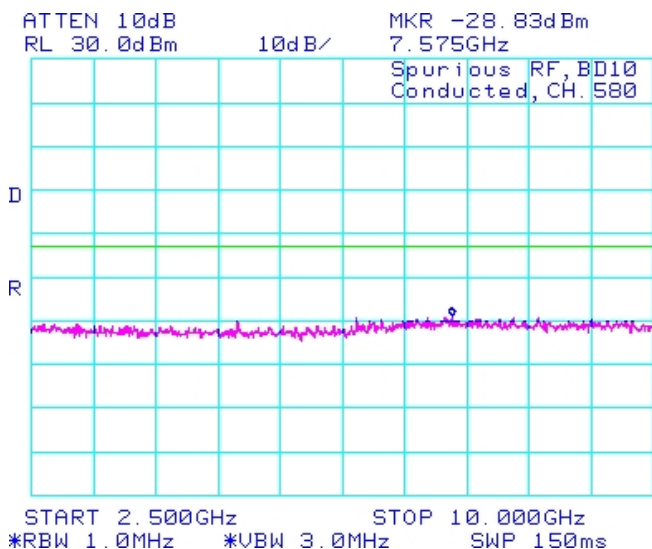



Figure 1-4b: Cellular, Spurious Conducted Emissions, Middle channel



	EMI Test Report for the BlackBerry® smartphone Model RDR61CW,RDS41CW Appendix 1C	
Test Report No. RTS-2604-1106-131A	Dates of Test May 25, June 2 to June 28, 2011	FCC ID: L6ARDR60CW, L6ARDS40CW IC: 2503A-RDR60CW, 2503A-RDS40CW

CDMA Conducted RF Emission Test Data cont'd

Figure 9-5b: Cellular, Spurious Conducted Emissions, High Channel

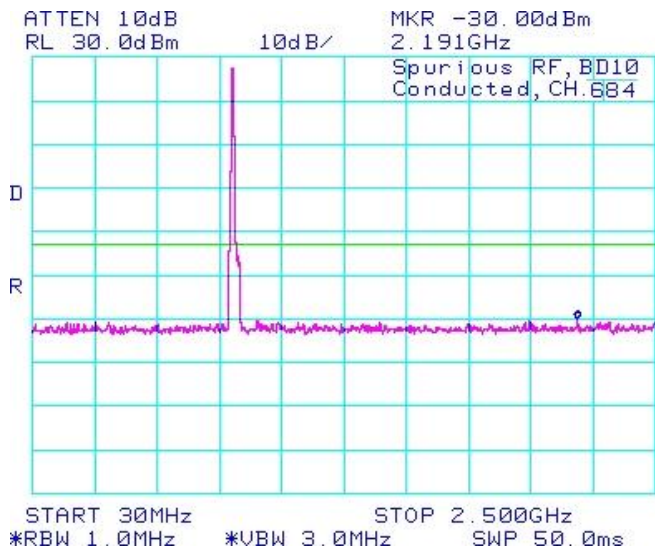

Figure 1-6b: Cellular, Spurious Conducted Emissions, High Channel

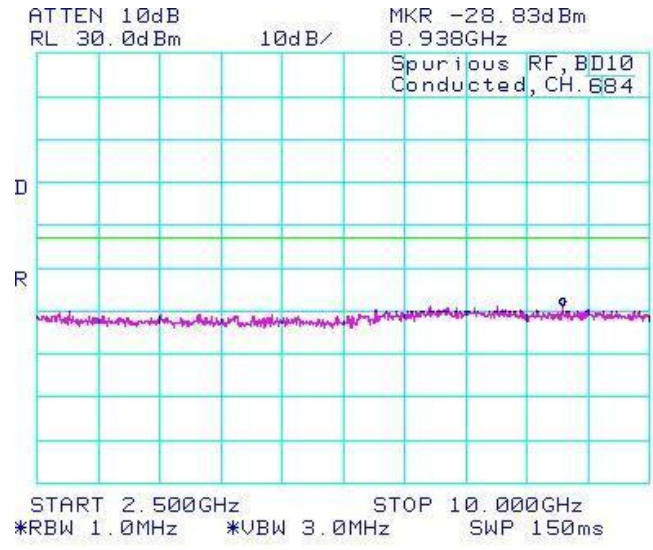

Figure 1-7b: Occupied Bandwidth, Cellular Low Channel

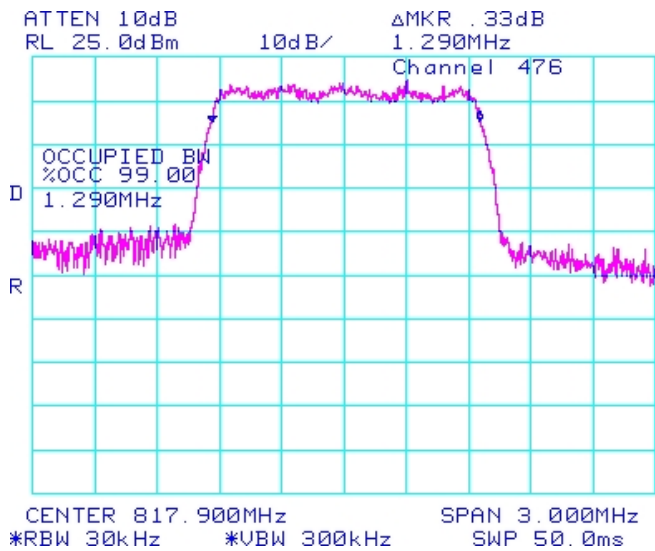
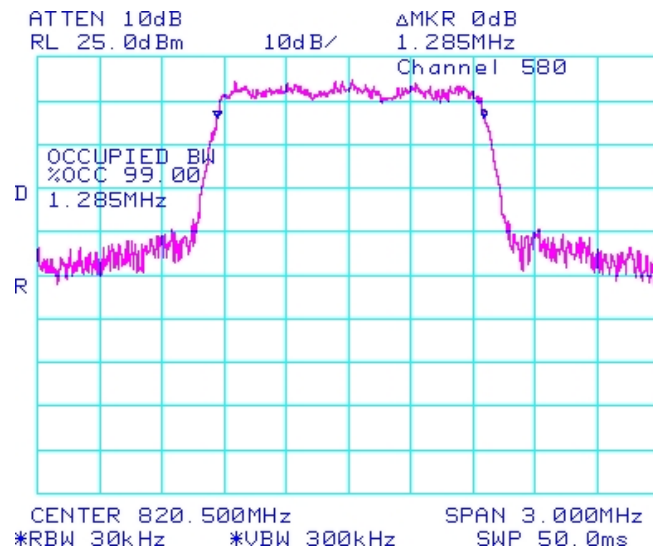



Figure 1-8b: Occupied Bandwidth, Cellular Middle Channel



	EMI Test Report for the BlackBerry® smartphone Model RDR61CW,RDS41CW Appendix 1C	
Test Report No. RTS-2604-1106-131A	Dates of Test May 25, June 2 to June 28, 2011	FCC ID: L6ARDR60CW, L6ARDS40CW IC: 2503A-RDR60CW, 2503A-RDS40CW

CDMA Conducted RF Emission Test Data cont'd

Figure 1-9b: Occupied Bandwidth, Cellular High Channel

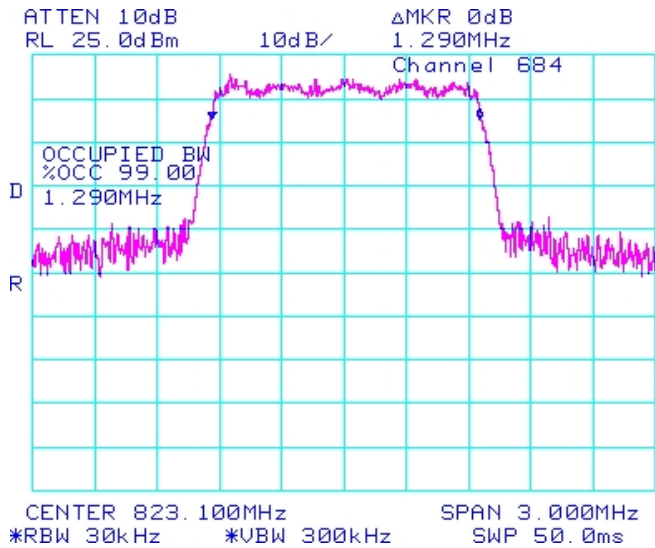

Since the Spectrum Analyzer's RBW cannot be set to 13 kHz, the measurement for channel masks was done at 10 kHz and the limit adjusted using the calculation $10\log(13\text{kHz}/10\text{kHz}) = 1.14\text{ dB}$. $-20\text{dBm} - 1.14\text{ dB} = -21.14\text{ dBm}$ adjusted limit.

Figure 1-10b: Cellular CDMA2000, Low Channel Mask

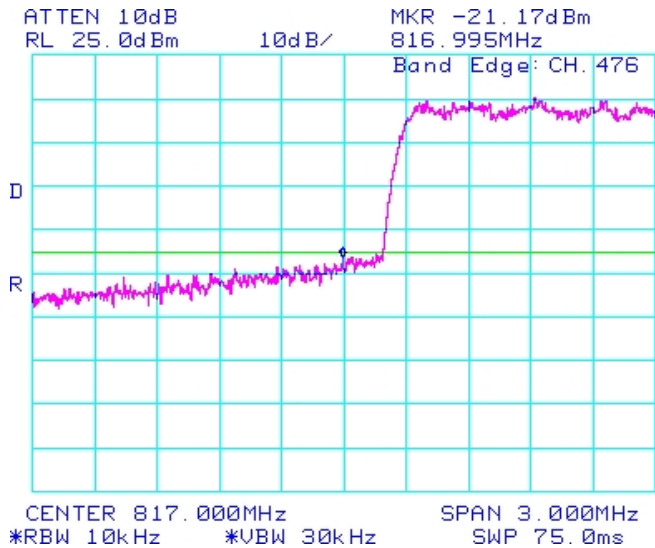
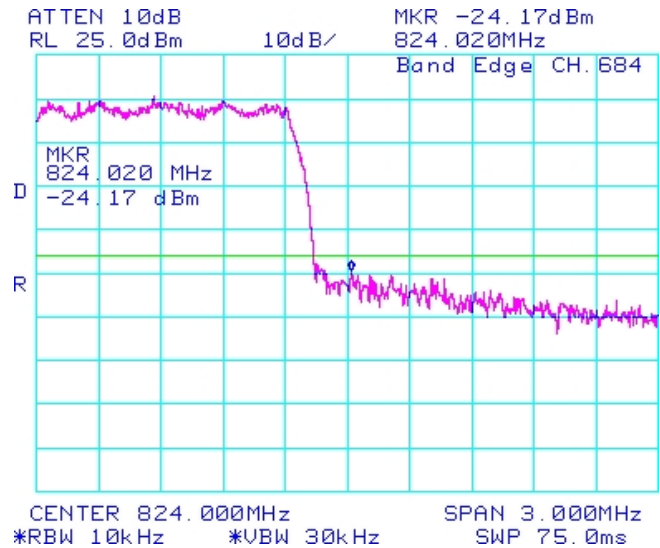

Figure 1-11b: Cellular CDMA2000, High Channel Mask



APPENDIX 2A – GSM CONDUCTED RF OUTPUT POWER TEST DATA



Test Report No. RTS-2604-1106-131A	Dates of Test May 25, June 2 to June 28, 2011	FCC ID: L6ARDR60CW, L6ARDS40CW IC: 2503A-RDR60CW, 2503A-RDS40CW
--	---	--

GSM Conducted RF Output Power Test Data

The conducted RF output power was measured on the BlackBerry® smartphone using the Communication Tester, Rohde & Schwarz, model CMU 200. The low, middle and high channels were measured at maximum output power. The insertion loss of the coaxial cable from the CMU 200 to the BlackBerry® smartphone was compensated for in the measurements.

Peak nominal output power is 32.5 dBm \pm 0.5 dB for GSM850 and 29.5 dBm \pm 0.5 dB for PCS.

Peak nominal output power is 30.5 dBm \pm 0.5 dB for GSM850 EDGE Mode (2-timeslot uplink) and 27.0 dBm \pm 0.5 dB for PCS EDGE Mode (2-timeslot uplink).

Date of Test: June 23, 2011

The environmental conditions were: Temperature: 24.2 °C
 Humidity: 44.8 %

The measurements were performed by Daoud Attayi

Channel	Frequency (MHz)	Maximum Output Power (dBm)	Maximum Output Power (Watts)	Channel	Frequency (MHz)	Maximum Output Power (dBm)	Maximum Output Power (Watts)
<u>GSM850</u>				<u>GSM850 Edge</u>			
128	824.20	32.5	1.78	128	824.20	30.7	1.18
189	837.60	32.6	1.82	189	837.60	30.8	1.20
251	848.80	32.5	1.78	251	848.80	30.8	1.20
<u>PCS</u>				<u>PCS Edge</u>			
512	1850.2	29.1	0.81	512	1850.2	27.5	0.56
661	1880.0	29.2	0.83	661	1880.0	27.5	0.56
810	1909.8	29.3	0.85	810	1909.8	27.4	0.55

APPENDIX 2B – CDMA CONDUCTED RF OUTPUT POWER TEST DATA

	EMI Test Report for the BlackBerry [®] smartphone Model RDR61CW,RDS41CW Appendix 2B	
	Test Report No. RTS-2604-1106-131A	Dates of Test May 25, June 2 to June 28, 2011

Conducted RF Output Power Test Data

The measurements were performed by Daoud Attayi.

The conducted RF output power was measured using the CDMA base station simulator. Low, middle and high channels were measured at maximum radio output power at different service options and modes.

Peak nominal output power is 24.50 dBm ±0.5 dB for Cellular and 23.00 dBm ±0.5 dB for PCS.

Date of Test: June 23, 2011

The environmental test conditions were: Temperature 24.2 °C
 Relative Humidity 44.8%

Test Results

Band	Channel	1x EvDO (153.6kbps)		CDMA2000 RC	SO2 Loopback		SO55 Loopback		TDSO SO32	
		(dBm)	(Watts)		(dBm)	(Watts)	(dBm)	(Watts)	(dBm)	(Watts)
CDMA 850	1013	23.9	0.25	RC1	23.9	0.25	23.8	0.24	N/A	-
				RC3	23.8	0.24	23.8	0.24	23.7	0.23
	384	24.1	0.26	RC1	24.1	0.26	24.0	0.25	N/A	-
				RC3	24.0	0.25	24.0	0.25	24.0	0.25
	777	23.9	0.25	RC1	23.8	0.24	23.8	0.24	N/A	-
				RC3	23.7	0.23	23.7	0.23	23.7	0.23

Band	Channel	1x EvDO (153.6kbps)		CDMA2000 RC	SO2 Loopback		SO55 Loopback		TDSO SO32	
		(dBm)	(Watts)		(dBm)	(Watts)	(dBm)	(Watts)	(dBm)	(Watts)
CDMA 1900	25	23.1	0.20	RC1	23.1	0.20	23.1	0.20	N/A	-
				RC3	23.1	0.20	22.9	0.20	23.1	0.20
	600	23.2	0.21	RC1	23.2	0.21	23.2	0.21	N/A	-
				RC3	23.1	0.20	23.0	0.20	23.1	0.20
	1175	23.0	0.20	RC1	23.1	0.20	23.0	0.20	N/A	-
				RC3	23.1	0.20	23.0	0.20	23.0	0.20

APPENDIX 2C – CDMA BC10 CONDUCTED RF OUTPUT POWER TEST DATA

		EMI Test Report for the BlackBerry® smartphone Model RDR61CW,RDS41CW Appendix 2C	
Test Report No. RTS-2604-1106-131A	Dates of Test May 25, June 2 to June 28, 2011	FCC ID: L6ARDR60CW, L6ARDS40CW IC: 2503A-RDR60CW, 2503A-RDS40CW	

Conducted RF Output Power Test Data

The measurements were performed by Daoud Attayi.

The conducted RF output power was measured using the CDMA base station simulator. Low, middle and high channels were measured at maximum radio output power at different service options and modes.

Peak nominal output power is 24.0 dBm ±0.5 dBm.

Date of Test: June 23, 2011

The environmental test conditions were: Temperature 24.2 °C
Relative Humidity 44.8%

Test Results

Band	Channel	1x EvDO (153.6kbps)		CDMA2000 RC	SO2 Loopback		SO55 Loopback		TDSO SO32	
		(dBm)	(Watts)		(dBm)	(Watts)	(dBm)	(Watts)	(dBm)	(Watts)
CDMA 800	476	24.2	0.26	RC1	23.9	0.25	24.0	0.25	N/A	-
				RC3	24.1	0.26	24.0	0.25	24.1	0.26
	580	24.3	0.27	RC1	24.1	0.26	24.2	0.26	N/A	-
				RC3	24.0	0.25	24.1	0.26	24.1	0.26
	684	24.2	0.26	RC1	24.1	0.26	24.0	0.25	N/A	-
				RC3	23.9	0.25	23.9	0.25	24.0	0.25

APPENDIX 3A – GSM FREQUENCY STABILITY TEST DATA

	EMI Test Report for the BlackBerry® smartphone Model RDR61CW,RDS41CW Appendix 3A	
Test Report No. RTS-2604-1106-131A	Dates of Test May 25, June 2 to June 28, 2011	FCC ID: L6ARDR60CW, L6ARDS40CW IC: 2503A-RDR60CW, 2503A-RDS40CW

GSM Frequency Stability Test Data

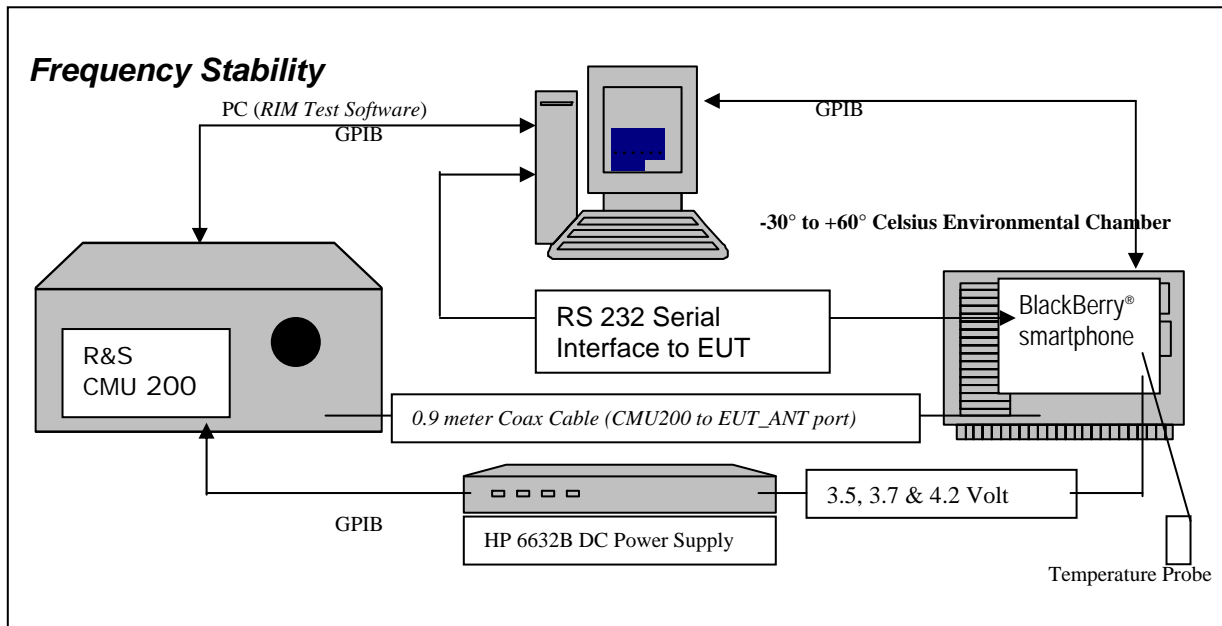

The measurements were performed by Maurice Battler.

CFR 47 Chapter 1 - Federal Communications Commission Rules

Part 2 Required Measurements

- 2.995 Frequency Stability - Procedures
- (a,b) Frequency Stability - Temperature Variation
- (d) Frequency Stability - Voltage Variation

24.235/22.917 Frequency Stability.

The frequency stability shall be sufficient to ensure that the fundamental emission stays within the authorized frequency block.

The EUT meets the requirements as stated in CFR 47 chapter 1, Section 24.235, CFR 47 chapter 1, Section 22.917 RSS-132, 4.3 Frequency Stability, and RSS-133, 6.3 Frequency Stability.

Frequency Stability measurement devices were configured as presented in the block diagram recording frequency, power, data, temperatures, and stepped voltages controlled via a GPIB interface linked to the Environmental chamber, a DC power supply, and the Communications Test Set. A 0.9-metre coax cable was calibrated to characterize the insertion loss for the transmitted frequencies between the RF input/output of the CMU 200 and the EUT antenna port.

Calibration for the Cable Loss was performed in the RF Laboratory using the Agilent power meter and Agilent Signal Generator.

	EMI Test Report for the BlackBerry® smartphone Model RDR61CW,RDS41CW Appendix 3A	
Test Report No. RTS-2604-1106-131A	Dates of Test May 25, June 2 to June 28, 2011	FCC ID: L6ARDR60CW, L6ARDS40CW IC: 2503A-RDR60CW, 2503A-RDS40CW

Procedure:

The EUT was placed in the Temperature chamber and connected to CMU 200 outside as shown in the figure above. Dry air was pumped inside the temperature chamber to maintain a backpressure during the test. The EUT was kept in the off condition at all times except when the measurements were to be made.

The chamber was switched on and the temperature was set to -30°C. After the chamber stabilized at -30 °C there was a soak period of one hour to alleviate moisture in the chamber, the EUT voltage was enabled. The system software recorded the frequency, power, and associated measurements.

A Computer system controlled the automated software. This application was given the command of activating all machines intrinsic to the temperature and voltage tests controlling the CMU 200 via the GPIB Bus. The Environmental Chamber was instructed through an RS-232 serial line. The EUT dialogue was passed through a serial connection.

The EUT repetitively transmitted 100 bursts for each set of programmed parameters recording temperature, voltage settings, and systematically selected frequencies. The power supply was cycled from minimum voltage 3.6 volts, to 3.7 volts to 4.2 volts maximum voltage. The frequency error was measured at a maximum output power and recorded by the automated system test software.

The EUT output power and frequency was measured at 3.6 volts, 3.7 volts and 4.2 volts. The transmit frequency was varied in 3 steps consisting of 824.2, 837.6, and 848.8 MHz for the GSM850 band, 1850.2, 1880.0 and 1909.8 MHz for the PCS1900 band. This frequency was recorded in MHz and deviation from nominal, in Parts Per Million. After the initial one-hour soak at the beginning of the tests, a period of thirty minutes soak was initialized between each ascending temperature step, before proceeding to the next measurement test cycle.

	EMI Test Report for the BlackBerry® smartphone Model RDR61CW,RDS41CW Appendix 3A	
Test Report No. RTS-2604-1106-131A	Dates of Test May 25, June 2 to June 28, 2011	FCC ID: L6ARDR60CW, L6ARDS40CW IC: 2503A-RDR60CW, 2503A-RDS40CW

PROCEDURE:

The test system software for commencing the Frequency Stability Tests carried through the following cycle.

1. Switch on the HP 6632B power supply; CMU 200 Communications test Set, and Environmental Chamber.
2. Start test program
3. Set the Temperature to -30°C and maintain a period of one- hour soak time, with the EUT supply voltage disabled.
4. Set power supply voltage to 3.6 volts.
5. Set up CMU 200 Radio Communication Tester.
6. Command the CMU 200 to switch to the low channel.
7. Enable the voltage to the EUT, and connect a link to the CMU 200 test set.
8. EUT is commanded to Transmit 100 Bursts.
9. Software logs the following data from the CMU 200, power supply and temperature chamber: Traffic Channel Number, Traffic Channel Frequency, Power Level, Chamber Temperature, Supply Voltage, Power and Frequency Error.
10. The CMU 200 commands the EUT to change frequency to the middle channel and high channel and repeats steps 7 to 9.
11. Repeat steps 5 to 10 changing the supply voltage to 3.7 Volts
12. Increase temperature by 10°C and soak for 1/2 hour.
13. Repeat steps 4 - 12 for temperatures -30°C to 60°C .
14. Repeat steps 5 to 10 changing the supply voltage to 4.2 volts

Procedure 5 to 10 was repeated at room temperature (20°C) with the power supply voltage set to 3.6, 3.7 and 4.2 volts.

The maximum frequency error in the GSM850 band measured was **0.0370 PPM**.
The maximum frequency error in the PCS1900 band measured was **0.0377 PPM**.

Test Report No.
RTS-2604-1106-131A

Dates of Test
May 25, June 2 to June 28, 2011

FCC ID: L6ARDR60CW, L6ARDS40CW
IC: 2503A-RDR60CW, 2503A-RDS40CW

GSM850 Channel results: channels 128, 195 and 251 @ 20°C maximum transmitted power

Traffic Channel Number	GSM850 Frequency (MHz)	Voltage (Volts)	Temperature (Celsius)	Frequency Error (Hz)	PPM
128	824.2	3.6	20	-8	-0.0097
195	837.6	3.6	20	-9	-0.0107
251	848.8	3.6	20	-6	-0.0071

Traffic Channel Number	GSM850 Frequency (MHz)	Voltage (Volts)	Temperature (Celsius)	Frequency Error (Hz)	PPM
128	824.2	3.7	20	-14	-0.0170
195	837.6	3.7	20	-8	-0.0096
251	848.8	3.7	20	10	0.0118

Traffic Channel Number	GSM850 Frequency (MHz)	Voltage (Volts)	Temperature (Celsius)	Frequency Error (Hz)	PPM
128	824.2	4.2	20	-13	-0.0158
195	837.6	4.2	20	-13	-0.0155
251	848.8	4.2	20	-12	-0.0141

Test Report No.
RTS-2604-1106-131A

Dates of Test
May 25, June 2 to June 28, 2011

FCC ID: L6ARDR60CW, L6ARDS40CW
IC: 2503A-RDR60CW, 2503A-RDS40CW

GSM850 Results: channel 128 @ maximum transmitted power

Traffic Channel Number	Frequency (MHz)	Voltage (Volts)	Temperature (Celsius)	Frequency Error (Hz)	PPM
128	824.2	3.6	-30	-14	-0.0170
128	824.2	3.6	-20	16	0.0194
128	824.2	3.6	-10	22	0.0267
128	824.2	3.6	0	28	-0.0218
128	824.2	3.6	10	16	0.0194
128	824.2	3.6	20	-8	-0.0097
128	824.2	3.6	30	8	0.0097
128	824.2	3.6	40	-13	-0.0158
128	824.2	3.6	50	-15	-0.0182
128	824.2	3.6	60	-18	-0.0218

Traffic Channel Number	Frequency (MHz)	Voltage (Volts)	Temperature (Celsius)	Frequency Error (Hz)	PPM
128	824.2	3.7	-30	-9	-0.0109
128	824.2	3.7	-20	11	0.0133
128	824.2	3.7	-10	25	0.0146
128	824.2	3.7	0	28	0.0340
128	824.2	3.7	10	12	0.0146
128	824.2	3.7	20	-14	-0.0170
128	824.2	3.7	30	-13	-0.0158
128	824.2	3.7	40	-11	-0.0133
128	824.2	3.7	50	-11	-0.0133
128	824.2	3.7	60	-16	-0.0194

Traffic Channel Number	Frequency (MHz)	Voltage (Volts)	Temperature (Celsius)	Frequency Error (Hz)	PPM
128	824.2	4.2	-30	18	0.0218
128	824.2	4.2	-20	17	0.0206
128	824.2	4.2	-10	26	0.0315
128	824.2	4.2	0	26	0.0315
128	824.2	4.2	10	10	0.0121
128	824.2	4.2	20	-13	-0.0158
128	824.2	4.2	30	-14	-0.0170
128	824.2	4.2	40	-14	-0.0170
128	824.2	4.2	50	-14	-0.0170
128	824.2	4.2	60	9	0.0109

Test Report No.
RTS-2604-1106-131A

Dates of Test
May 25, June 2 to June 28, 2011

FCC ID: L6ARDR60CW, L6ARDS40CW
IC: 2503A-RDR60CW, 2503A-RDS40CW

GSM850 Results: channel 195 @ maximum transmitted power

Traffic Channel Number	Frequency (MHz)	Voltage (Volts)	Temperature (Celsius)	Frequency Error (Hz)	PPM
195	837.6	3.6	-30	-13	-0.0155
195	837.6	3.6	-20	11	0.0131
195	837.6	3.6	-10	27	0.0322
195	837.6	3.6	0	28	-0.0143
195	837.6	3.6	10	9	0.0107
195	837.6	3.6	20	-9	-0.0107
195	837.6	3.6	30	7	0.0084
195	837.6	3.6	40	-8	-0.0096
195	837.6	3.6	50	-14	-0.0167
195	837.6	3.6	60	-12	-0.0143

Traffic Channel Number	Frequency (MHz)	Voltage (Volts)	Temperature (Celsius)	Frequency Error (Hz)	PPM
195	837.6	3.7	-30	10	0.0119
195	837.6	3.7	-20	16	0.0191
195	837.6	3.7	-10	26	0.0310
195	837.6	3.7	0	27	0.0322
195	837.6	3.7	10	9	0.0107
195	837.6	3.7	20	-8	-0.0096
195	837.6	3.7	30	9	0.0107
195	837.6	3.7	40	-11	-0.0131
195	837.6	3.7	50	-9	-0.0107
195	837.6	3.7	60	-12	-0.0143

Traffic Channel Number	Frequency (MHz)	Voltage (Volts)	Temperature (Celsius)	Frequency Error (Hz)	PPM
195	837.6	4.2	-30	11	0.0131
195	837.6	4.2	-20	20	0.0239
195	837.6	4.2	-10	31	0.0370
195	837.6	4.2	0	26	0.0310
195	837.6	4.2	10	12	0.0143
195	837.6	4.2	20	-13	-0.0155
195	837.6	4.2	30	11	0.0131
195	837.6	4.2	40	-13	-0.0155
195	837.6	4.2	50	-15	-0.0179
195	837.6	4.2	60	9	0.0107



EMI Test Report for the BlackBerry® smartphone Model RDR61CW,RDS41CW
Appendix 3A

Test Report No.
RTS-2604-1106-131A

Dates of Test
May 25, June 2 to June 28, 2011

FCC ID: L6ARDR60CW, L6ARDS40CW
IC: 2503A-RDR60CW, 2503A-RDS40CW

GSM850 Results: channel 251 @ maximum transmitted power

Traffic Channel Number	Frequency (MHz)	Voltage (Volts)	Temperature (Celsius)	Frequency Error (Hz)	PPM
251	848.8	3.6	-30	-14	-0.0165
251	848.8	3.6	-20	12	0.0141
251	848.8	3.6	-10	24	0.0283
251	848.8	3.6	0	28	-0.0094
251	848.8	3.6	10	11	0.0130
251	848.8	3.6	20	-6	-0.0071
251	848.8	3.6	30	-9	-0.0106
251	848.8	3.6	40	9	0.0106
251	848.8	3.6	50	8	0.0094
251	848.8	3.6	60	-8	-0.0094

Traffic Channel Number	Frequency (MHz)	Voltage (Volts)	Temperature (Celsius)	Frequency Error (Hz)	PPM
251	848.8	3.7	-30	-7	-0.0082
251	848.8	3.7	-20	14	0.0165
251	848.8	3.7	-10	27	0.0318
251	848.8	3.7	0	30	0.0353
251	848.8	3.7	10	15	0.0177
251	848.8	3.7	20	10	0.0118
251	848.8	3.7	30	-12	-0.0141
251	848.8	3.7	40	-8	-0.0094
251	848.8	3.7	50	-11	-0.0130
251	848.8	3.7	60	-9	-0.0106

Traffic Channel Number	Frequency (MHz)	Voltage (Volts)	Temperature (Celsius)	Frequency Error (Hz)	PPM
251	848.8	4.2	-30	17	0.0200
251	848.8	4.2	-20	17	0.0200
251	848.8	4.2	-10	27	0.0318
251	848.8	4.2	0	27	0.0318
251	848.8	4.2	10	14	0.0165
251	848.8	4.2	20	-12	-0.0141
251	848.8	4.2	30	-12	-0.0141
251	848.8	4.2	40	-14	-0.0165
251	848.8	4.2	50	-8	-0.0094
251	848.8	4.2	60	-13	-0.0153

Test Report No.
RTS-2604-1106-131A

Dates of Test
May 25, June 2 to June 28, 2011

FCC ID: L6ARDR60CW, L6ARDS40CW
IC: 2503A-RDR60CW, 2503A-RDS40CW

PCS Channel results: channels 512, 661, & 810 @ 20°C maximum transmitted power

Traffic Channel Number	PCS Frequency (MHz)	Voltage (Volts)	Temperature (Celsius)	Frequency Error (Hz)	PPM
512	1850.2	3.6	20	17	0.0092
661	1880.0	3.6	20	13	0.0069
810	1909.8	3.6	20	-11	-0.0058

Traffic Channel Number	PCS Frequency (MHz)	Voltage (Volts)	Temperature (Celsius)	Frequency Error (Hz)	PPM
512	1850.2	3.7	20	-10	-0.0054
661	1880.0	3.7	20	-14	-0.0074
810	1909.8	3.7	20	-12	-0.0063

Traffic Channel Number	PCS Frequency (MHz)	Voltage (Volts)	Temperature (Celsius)	Frequency Error (Hz)	PPM
512	1850.2	4.2	20	-13	-0.0070
661	1880.0	4.2	20	-17	-0.0090
810	1909.8	4.2	20	-21	-0.0110

Test Report No.
RTS-2604-1106-131A

Dates of Test
May 25, June 2 to June 28, 2011

FCC ID: L6ARDR60CW, L6ARDS40CW
IC: 2503A-RDR60CW, 2503A-RDS40CW

PCS1900 Results: channel 512 @ maximum transmitted power

Traffic Channel Number	Frequency (MHz)	Voltage (Volts)	Temperature (Celsius)	Frequency Error (Hz)	PPM
512	1850.2	3.6	-30	20	0.0108
512	1850.2	3.6	-20	26	0.0141
512	1850.2	3.6	-10	57	0.0308
512	1850.2	3.6	0	73	-0.0103
512	1850.2	3.6	10	42	0.0227
512	1850.2	3.6	20	17	0.0092
512	1850.2	3.6	30	13	0.0070
512	1850.2	3.6	40	15	0.0081
512	1850.2	3.6	50	-17	-0.0092
512	1850.2	3.6	60	-19	-0.0103

Traffic Channel Number	Frequency (MHz)	Voltage (Volts)	Temperature (Celsius)	Frequency Error (Hz)	PPM
512	1850.2	3.7	-30	12	0.0065
512	1850.2	3.7	-20	31	0.0168
512	1850.2	3.7	-10	53	0.0286
512	1850.2	3.7	0	67	0.0362
512	1850.2	3.7	10	37	0.0200
512	1850.2	3.7	20	-10	-0.0054
512	1850.2	3.7	30	19	0.0103
512	1850.2	3.7	40	15	0.0081
512	1850.2	3.7	50	-15	-0.0081
512	1850.2	3.7	60	-11	-0.0059

Traffic Channel Number	Frequency (MHz)	Voltage (Volts)	Temperature (Celsius)	Frequency Error (Hz)	PPM
512	1850.2	4.2	-30	29	0.0157
512	1850.2	4.2	-20	35	0.0189
512	1850.2	4.2	-10	60	0.0324
512	1850.2	4.2	0	62	0.0335
512	1850.2	4.2	10	34	0.0184
512	1850.2	4.2	20	-13	-0.0070
512	1850.2	4.2	30	18	0.0097
512	1850.2	4.2	40	-13	-0.0070
512	1850.2	4.2	50	-15	-0.0081
512	1850.2	4.2	60	-12	-0.0065

Test Report No.
RTS-2604-1106-131A

Dates of Test
May 25, June 2 to June 28, 2011

FCC ID: L6ARDR60CW, L6ARDS40CW
IC: 2503A-RDR60CW, 2503A-RDS40CW

PCS1900 Results: channel 661 @ maximum transmitted power

Traffic Channel Number	Frequency (MHz)	Voltage (Volts)	Temperature (Celsius)	Frequency Error (Hz)	PPM
661	1880.0	3.6	-30	16	0.0085
661	1880.0	3.6	-20	27	0.0144
661	1880.0	3.6	-10	59	0.0314
661	1880.0	3.6	0	67	-0.0085
661	1880.0	3.6	10	41	0.0218
661	1880.0	3.6	20	13	0.0069
661	1880.0	3.6	30	16	0.0085
661	1880.0	3.6	40	-11	-0.0059
661	1880.0	3.6	50	-11	-0.0059
661	1880.0	3.6	60	-16	-0.0085

Traffic Channel Number	Frequency (MHz)	Voltage (Volts)	Temperature (Celsius)	Frequency Error (Hz)	PPM
661	1880.0	3.7	-30	25	0.0133
661	1880.0	3.7	-20	23	0.0122
661	1880.0	3.7	-10	49	0.0261
661	1880.0	3.7	0	63	0.0335
661	1880.0	3.7	10	40	0.0213
661	1880.0	3.7	20	-14	-0.0074
661	1880.0	3.7	30	-13	-0.0069
661	1880.0	3.7	40	-12	-0.0064
661	1880.0	3.7	50	-13	-0.0069
661	1880.0	3.7	60	-14	-0.0074

Traffic Channel Number	Frequency (MHz)	Voltage (Volts)	Temperature (Celsius)	Frequency Error (Hz)	PPM
661	1880.0	4.2	-30	28	0.0149
661	1880.0	4.2	-20	40	0.0213
661	1880.0	4.2	-10	52	0.0277
661	1880.0	4.2	0	68	0.0362
661	1880.0	4.2	10	32	0.0170
661	1880.0	4.2	20	-17	-0.0090
661	1880.0	4.2	30	13	0.0069
661	1880.0	4.2	40	-17	-0.0090
661	1880.0	4.2	50	-11	-0.0059
661	1880.0	4.2	60	-9	-0.0048

Test Report No.
RTS-2604-1106-131A

Dates of Test
May 25, June 2 to June 28, 2011

FCC ID: L6ARDR60CW, L6ARDS40CW
IC: 2503A-RDR60CW, 2503A-RDS40CW

PCS1900 Results: channel 810 @ maximum transmitted power

Traffic Channel Number	Frequency (MHz)	Voltage (Volts)	Temperature (Celsius)	Frequency Error (Hz)	20BPPM
810	1909.8	3.6	-30	15	0.0079
810	1909.8	3.6	-20	19	0.0099
810	1909.8	3.6	-10	55	0.0288
810	1909.8	3.6	0	69	-0.0079
810	1909.8	3.6	10	39	0.0204
810	1909.8	3.6	20	-11	-0.0058
810	1909.8	3.6	30	-12	-0.0063
810	1909.8	3.6	40	13	0.0068
810	1909.8	3.6	50	-15	-0.0079
810	1909.8	3.6	60	-15	-0.0079

Traffic Channel Number	Frequency (MHz)	Voltage (Volts)	Temperature (Celsius)	Frequency Error (Hz)	PPM
810	1909.8	3.7	-30	14	0.0073
810	1909.8	3.7	-20	26	0.0136
810	1909.8	3.7	-10	49	0.0257
810	1909.8	3.7	0	72	0.0377
810	1909.8	3.7	10	34	0.0178
810	1909.8	3.7	20	-12	-0.0063
810	1909.8	3.7	30	18	0.0094
810	1909.8	3.7	40	10	0.0052
810	1909.8	3.7	50	-14	-0.0073
810	1909.8	3.7	60	-15	-0.0079

Traffic Channel Number	Frequency (MHz)	Voltage (Volts)	Temperature (Celsius)	Frequency Error (Hz)	PPM
810	1909.8	4.2	-30	29	0.0152
810	1909.8	4.2	-20	32	0.0168
810	1909.8	4.2	-10	57	0.0298
810	1909.8	4.2	0	68	0.0356
810	1909.8	4.2	10	36	0.0189
810	1909.8	4.2	20	-21	-0.0110
810	1909.8	4.2	30	-14	-0.0073
810	1909.8	4.2	40	-16	-0.0084
810	1909.8	4.2	50	-15	-0.0079
810	1909.8	4.2	60	-15	-0.0079

APPENDIX 3B – CDMA FREQUENCY STABILITY TEST DATA

Test Report No.
RTS-2604-1106-131A

Dates of Test
May 25, June 2 to June 28, 2011

FCC ID: L6ARDR60CW, L6ARDS40CW
IC: 2503A-RDR60CW, 2503A-RDS40CW

CDMA Frequency Stability Test Data

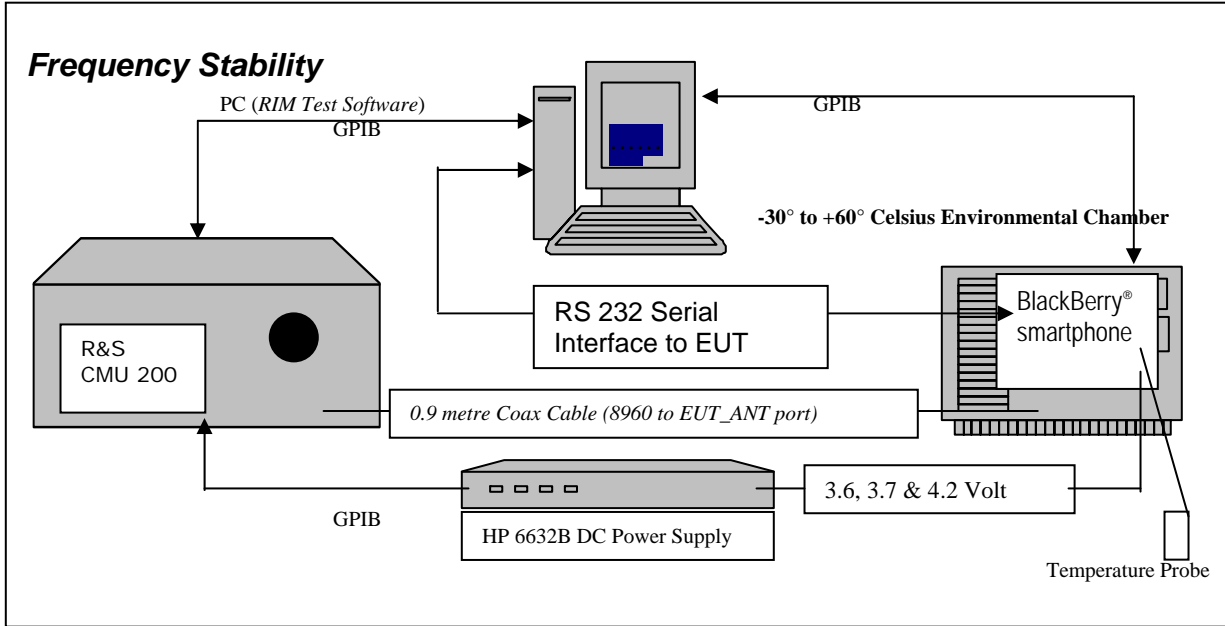

CFR 47 Chapter 1 - Federal Communications Commission Rules

Part 2 Required Measurements

- 2.1055** Frequency Stability - Procedures
- (a,b) Frequency Stability - Temperature Variation
- (d) Frequency Stability - Voltage Variation

22.917/24.235 Frequency Stability.

The frequency stability shall be sufficient to ensure that the fundamental emission stays within the authorized frequency block.

The RCU21CW BlackBerry® smartphone, (referred as EUT herein and after) transmitted frequencies are less than 0.1 ppm of the received frequency from the Agilent 8960 CDMA Base Station Simulator

The EUT meets the requirements as stated in CFR 47 chapter 1, Section 24.235, RSS-133, CFR 47 chapter 1, Section 22.917 and RSS-132 Frequency Stability.

Frequency Stability measurement devices were configured as presented in the block diagram recording frequency, power, data, temperatures, and stepped voltages controlled via a GPIB interface linked to the Environmental chamber, a DC power supply, and the Communications Test Set. A 0.9-metre coax cable was calibrated to characterize the insertion loss for the transmitted frequencies between the RF input/output of the base station simulator and the EUT antenna port; located inside the environmental chamber.

Calibration for the Cable Loss was performed in the RF Laboratory using the Giga-tronics power metre and Agilent Signal Generator.

		EMI Test Report for the BlackBerry® smartphone Model RDR61CW,RDS41CW Appendix 3B	
Test Report No. RTS-2604-1106-131A	Dates of Test May 25, June 2 to June 28, 2011	FCC ID: L6ARDR60CW, L6ARDS40CW IC: 2503A-RDR60CW, 2503A-RDS40CW	

The cable assembly from the RF input to the RF output was measured at the following Frequencies:

PCS Frequency (MHz)	Cable loss (dB)
1851.20	1.10
1880.00	1.10
1908.75	1.10

Cellular Frequency (MHz)	Cable loss (dB)
824.70	0.50
836.52	0.50
848.31	0.50

Procedure:

The EUT was placed in the Temperature chamber and connected to the Agilent 8960 outside as shown in the figure above. Dry air was pumped inside the temperature chamber to maintain a backpressure during the test. The EUT was kept in the off condition at all times except when the measurements were to be made.

The chamber was switched on and the temperature was set to -30°C. After the chamber stabilized at -30 °C there was a soak period of one hour to alleviate moisture in the chamber, the EUT voltage was enabled. The system software recorded the frequency, power, and associated measurements.

A Computer system controlled the automated software. This application was given the command of activating all machines intrinsic to the temperature and voltage tests controlling the base station simulator via the GPIB Bus. The Environmental Chamber was instructed through an RS-232 serial line. The EUT dialogue was passed through a serial connection.

The EUT repetitively transmitted 100 bursts for each set of programmed parameters recording temperature, voltage settings, and systematically selected frequencies. The power supply was cycled from minimum voltage 3.6 volts, to 3.7 volts nominal voltage to 4.2 volts maximum voltage. The frequency error was measured at a maximum output power and recorded by the automated system test software.

The EUT output power and frequency was measured at 3.6 volts, 3.7 volts and 4.2 volts. The transmit frequency was varied in 3 steps consisting of 824.70, 836.52, and 848.31 MHz for the cellular band and 1851.20, 1880.00 and 1908.75 MHz for the PCS band. This frequency was recorded in MHz and deviation from nominal, in Parts per Million. After the initial one-hour soak at the beginning of the tests, a period of thirty minutes soak was initialized between each ascending temperature step, before proceeding to the next measurement test cycle.

PROCEDURE:

	EMI Test Report for the BlackBerry® smartphone Model RDR61CW,RDS41CW Appendix 3B	
Test Report No. RTS-2604-1106-131A	Dates of Test May 25, June 2 to June 28, 2011	FCC ID: L6ARDR60CW, L6ARDS40CW IC: 2503A-RDR60CW, 2503A-RDS40CW

The test system software for commencing the Frequency Stability Tests carried through the following cycle.

1. Switch on the HP 6632B power supply; CMU 200 Communications test Set, and Environmental Chamber.
2. Start test program
3. Set the Temperature to -30°C and maintain a period of one- hour soak time, with the EUT supply voltage disabled.
4. Set power supply voltage to 3.6 volts.
5. Set up CMU 200 Radio Communication Tester.
6. Command the CMU 200 to switch to the low channel.
7. Enable the voltage to the EUT, and connect a link to the CMU 200 test set.
8. EUT is commanded to Transmit 100 Bursts.
9. Software logs the following data from the CMU 200, power supply and temperature chamber: Traffic Channel Number, Traffic Channel Frequency, Power Level, Chamber Temperature, Supply Voltage, Power and Frequency Error.
10. The CMU 200 commands the EUT to change frequency to the middle channel and high channel and repeats steps 7 to 9.
11. Repeat steps 5 to 10 changing the supply voltage to 3.7 Volts
12. Increase temperature by 10°C and soak for 1/2 hour.
13. Repeat steps 4 - 12 for temperatures -30°C to 60°C .
14. Repeat steps 5 to 10 changing the supply voltage to 4.2 volts

Procedure 5 to 10 was repeated at room temperature (20°C) with the power supply voltage set to 3.6, 3.7 and 4.2 volts

The maximum frequency error in the CDMA Cellular band measured was **0.0189 PPM**.
The maximum frequency error in the CDMA PCS band measured was **0.0135 PPM**.



EMI Test Report for the BlackBerry® smartphone Model RDR61CW,RDS41CW
Appendix 3B

Test Report No.
RTS-2604-1106-131A

Dates of Test
May 25, June 2 to June 28, 2011

FCC ID: L6ARDR60CW, L6ARDS40CW
IC: 2503A-RDR60CW, 2503A-RDS40CW

Cellular Channel results: channels 1013, 384 and 777 @ 20°C maximum transmitted power

Traffic Channel Number	Cellular Frequency (MHz)	Voltage (Volts)	Temperature (Celsius)	Frequency Error (Hz)	PPM
1013	824.70	3.6	20	12.00	0.0146
384	836.52	3.6	20	15.00	0.0179
777	848.31	3.6	20	11.00	0.0130

Traffic Channel Number	Cellular Frequency (MHz)	Voltage (Volts)	Temperature (Celsius)	Frequency Error (Hz)	PPM
1013	824.70	3.7	20	8.00	0.0097
384	836.52	3.7	20	-15.00	-0.0179
777	848.31	3.7	20	-13.00	-0.0153

Traffic Channel Number	Cellular Frequency (MHz)	Voltage (Volts)	Temperature (Celsius)	Frequency Error (Hz)	PPM
1013	824.70	4.2	20	-12.00	-0.0146
384	836.52	4.2	20	-12.00	-0.0143
777	848.31	4.2	20	-15.00	-0.0177



EMI Test Report for the BlackBerry® smartphone Model RDR61CW,RDS41CW
Appendix 3B

Test Report No.
RTS-2604-1106-131A

Dates of Test
May 25, June 2 to June 28, 2011

FCC ID: L6ARDR60CW, L6ARDS40CW
IC: 2503A-RDR60CW, 2503A-RDS40CW

Cellular Results: channel 1013 @ maximum transmitted power

Traffic Channel Number	Frequency (MHz)	Voltage (Volts)	Temperature (Celsius)	Frequency Error (Hz)	PPM
1013	824.70	3.6	-30	-10.00	-0.0121
1013	824.70	3.6	-20	11.00	0.0133
1013	824.70	3.6	-10	15.00	0.0182
1013	824.70	3.6	0	10.00	0.0121
1013	824.70	3.6	10	-7.00	-0.0085
1013	824.70	3.6	20	12.00	0.0146
1013	824.70	3.6	30	10.00	0.0121
1013	824.70	3.6	40	10.00	0.0121
1013	824.70	3.6	50	-7.00	-0.0085
1013	824.70	3.6	60	10.00	0.0121

Traffic Channel Number	Frequency (MHz)	Voltage (Volts)	Temperature (Celsius)	Frequency Error (Hz)	PPM
1013	824.70	3.7	-30	-12.00	-0.0146
1013	824.70	3.7	-20	12.00	0.0146
1013	824.70	3.7	-10	-12.00	-0.0146
1013	824.70	3.7	0	-9.00	-0.0109
1013	824.70	3.7	10	-9.00	-0.0109
1013	824.70	3.7	20	8.00	0.0097
1013	824.70	3.7	30	12.00	0.0146
1013	824.70	3.7	40	-7.00	-0.0085
1013	824.70	3.7	50	-13.00	-0.0158
1013	824.70	3.7	60	-13.00	-0.0158

Traffic Channel Number	Frequency (MHz)	Voltage (Volts)	Temperature (Celsius)	Frequency Error (Hz)	PPM
1013	824.70	4.2	-30	-10.00	-0.0121
1013	824.70	4.2	-20	-11.00	-0.0133
1013	824.70	4.2	-10	11.00	0.0133
1013	824.70	4.2	0	11.00	0.0133
1013	824.70	4.2	10	-5.00	-0.0061
1013	824.70	4.2	20	-12.00	-0.0146
1013	824.70	4.2	30	9.00	0.0109
1013	824.70	4.2	40	-13.00	-0.0158
1013	824.70	4.2	50	-11.00	-0.0133
1013	824.70	4.2	60	10.00	0.0121



EMI Test Report for the BlackBerry® smartphone Model RDR61CW,RDS41CW
Appendix 3B

Test Report No.
RTS-2604-1106-131A

Dates of Test
May 25, June 2 to June 28, 2011

FCC ID: L6ARDR60CW, L6ARDS40CW
IC: 2503A-RDR60CW, 2503A-RDS40CW

Cellular Results: channel 384 @ maximum transmitted power

Traffic Channel Number	Frequency (MHz)	Voltage (Volts)	Temperature (Celsius)	Frequency Error (Hz)	PPM
384	836.52	3.6	-30	-13.00	-0.0155
384	836.52	3.6	-20	-13.00	-0.0155
384	836.52	3.6	-10	-14.00	-0.0167
384	836.52	3.6	0	12.00	0.0120
384	836.52	3.6	10	-11.00	-0.0131
384	836.52	3.6	20	15.00	0.0179
384	836.52	3.6	30	11.00	0.0131
384	836.52	3.6	40	-11.00	-0.0131
384	836.52	3.6	50	11.00	0.0131
384	836.52	3.6	60	10.00	0.0120

Traffic Channel Number	Frequency (MHz)	Voltage (Volts)	Temperature (Celsius)	Frequency Error (Hz)	PPM
384	836.52	3.7	-30	-13.00	-0.0155
384	836.52	3.7	-20	9.00	0.0108
384	836.52	3.7	-10	13.00	0.0155
384	836.52	3.7	0	-10.00	-0.0120
384	836.52	3.7	10	-8.00	-0.0096
384	836.52	3.7	20	-15.00	-0.0179
384	836.52	3.7	30	-11.00	-0.0131
384	836.52	3.7	40	11.00	0.0131
384	836.52	3.7	50	9.00	0.0108
384	836.52	3.7	60	-13.00	-0.0155

Traffic Channel Number	Frequency (MHz)	Voltage (Volts)	Temperature (Celsius)	Frequency Error (Hz)	PPM
384	836.52	4.2	-30	12.00	0.0143
384	836.52	4.2	-20	-7.00	-0.0084
384	836.52	4.2	-10	-14.00	-0.0167
384	836.52	4.2	0	12.00	0.0143
384	836.52	4.2	10	11.00	0.0131
384	836.52	4.2	20	-12.00	-0.0143
384	836.52	4.2	30	12.00	0.0143
384	836.52	4.2	40	15.00	0.0179
384	836.52	4.2	50	9.00	0.0108
384	836.52	4.2	60	10.00	0.0120



EMI Test Report for the BlackBerry® smartphone Model RDR61CW,RDS41CW
Appendix 3B

Test Report No.
RTS-2604-1106-131A

Dates of Test
May 25, June 2 to June 28, 2011

FCC ID: L6ARDR60CW, L6ARDS40CW
IC: 2503A-RDR60CW, 2503A-RDS40CW

Cellular Results: channel 777 @ maximum transmitted power

Traffic Channel Number	Frequency (MHz)	Voltage (Volts)	Temperature (Celsius)	Frequency Error (Hz)	PPM
777	848.31	3.6	-30	-12.00	-0.0141
777	848.31	3.6	-20	11.00	0.0130
777	848.31	3.6	-10	12.00	0.0141
777	848.31	3.6	0	11.00	-0.0177
777	848.31	3.6	10	5.00	0.0059
777	848.31	3.6	20	11.00	0.0130
777	848.31	3.6	30	13.00	0.0153
777	848.31	3.6	40	15.00	0.0177
777	848.31	3.6	50	-11.00	-0.0130
777	848.31	3.6	60	-15.00	-0.0177

Traffic Channel Number	Frequency (MHz)	Voltage (Volts)	Temperature (Celsius)	Frequency Error (Hz)	PPM
777	848.31	3.7	-30	-11.00	-0.0130
777	848.31	3.7	-20	10.00	0.0118
777	848.31	3.7	-10	11.00	0.0130
777	848.31	3.7	0	-7.00	-0.0083
777	848.31	3.7	10	6.00	0.0071
777	848.31	3.7	20	-13.00	-0.0153
777	848.31	3.7	30	13.00	0.0153
777	848.31	3.7	40	13.00	0.0153
777	848.31	3.7	50	7.00	0.0083
777	848.31	3.7	60	14.00	0.0165

Traffic Channel Number	Frequency (MHz)	Voltage (Volts)	Temperature (Celsius)	Frequency Error (Hz)	PPM
777	848.31	4.2	-30	-11.00	-0.0130
777	848.31	4.2	-20	-11.00	-0.0130
777	848.31	4.2	-10	14.00	0.0165
777	848.31	4.2	0	11.00	0.0130
777	848.31	4.2	10	-9.00	-0.0106
777	848.31	4.2	20	-15.00	-0.0177
777	848.31	4.2	30	16.00	0.0189
777	848.31	4.2	40	-8.00	-0.0094
777	848.31	4.2	50	-7.00	-0.0083
777	848.31	4.2	60	-12.00	-0.0141

Test Report No.
RTS-2604-1106-131A

Dates of Test
May 25, June 2 to June 28, 2011

FCC ID: L6ARDR60CW, L6ARDS40CW
IC: 2503A-RDR60CW, 2503A-RDS40CW

PCS Channel results: channels 25, 600, & 1175 @ 20°C maximum transmitted power

Traffic Channel Number	PCS Frequency (MHz)	Voltage (Volts)	Temperature (Celsius)	Frequency Error (Hz)	PPM
25	1851.20	3.6	20	8.00	0.0043
600	1880.00	3.6	20	-9.00	-0.0048
1175	1908.75	3.6	20	15.00	0.0079

Traffic Channel Number	PCS Frequency (MHz)	Voltage (Volts)	Temperature (Celsius)	Frequency Error (Hz)	PPM
25	1851.20	3.7	20	12.00	0.0065
600	1880.00	3.7	20	-12.00	-0.0064
1175	1908.75	3.7	20	15.00	0.0079

Traffic Channel Number	PCS Frequency (MHz)	Voltage (Volts)	Temperature (Celsius)	Frequency Error (Hz)	PPM
25	1851.20	4.2	20	-9.00	-0.0049
600	1880.00	4.2	20	14.00	0.0074
1175	1908.75	4.2	20	-12.00	-0.0063



EMI Test Report for the BlackBerry® smartphone Model RDR61CW,RDS41CW
Appendix 3B

Test Report No.
RTS-2604-1106-131A

Dates of Test
May 25, June 2 to June 28, 2011

FCC ID: L6ARDR60CW, L6ARDS40CW
IC: 2503A-RDR60CW, 2503A-RDS40CW

PCS Results: channel 25 @ maximum transmitted power

Traffic Channel Number	Frequency (MHz)	Voltage (Volts)	Temperature (Celsius)	Frequency Error (Hz)	PPM
25	1851.20	3.6	-30	-11.00	-0.0059
25	1851.20	3.6	-20	-15.00	-0.0081
25	1851.20	3.6	-10	-19.00	-0.0103
25	1851.20	3.6	0	-15.00	0.0065
25	1851.20	3.6	10	-8.00	-0.0043
25	1851.20	3.6	20	8.00	0.0043
25	1851.20	3.6	30	19.00	0.0103
25	1851.20	3.6	40	11.00	0.0059
25	1851.20	3.6	50	10.00	0.0054
25	1851.20	3.6	-30	-11.00	-0.0059

Traffic Channel Number	Frequency (MHz)	Voltage (Volts)	Temperature (Celsius)	Frequency Error (Hz)	PPM
25	1851.20	3.7	-30	-10.00	-0.0054
25	1851.20	3.7	-20	-16.00	-0.0086
25	1851.20	3.7	-10	-14.00	-0.0076
25	1851.20	3.7	0	-19.00	-0.0103
25	1851.20	3.7	10	-19.00	-0.0103
25	1851.20	3.7	20	12.00	0.0065
25	1851.20	3.7	30	20.00	0.0108
25	1851.20	3.7	40	12.00	0.0065
25	1851.20	3.7	50	16.00	0.0086
25	1851.20	3.7	60	17.00	0.0092

Traffic Channel Number	Frequency (MHz)	Voltage (Volts)	Temperature (Celsius)	Frequency Error (Hz)	PPM
25	1851.20	4.2	-30	9.00	0.0049
25	1851.20	4.2	-20	-14.00	-0.0076
25	1851.20	4.2	-10	10.00	0.0054
25	1851.20	4.2	0	17.00	0.0092
25	1851.20	4.2	10	-12.00	-0.0065
25	1851.20	4.2	20	-9.00	-0.0049
25	1851.20	4.2	30	25.00	0.0135
25	1851.20	4.2	40	22.00	0.0119
25	1851.20	4.2	50	-9.00	-0.0049
25	1851.20	4.2	60	9.00	0.0049



EMI Test Report for the BlackBerry® smartphone Model RDR61CW,RDS41CW
Appendix 3B

Test Report No.
RTS-2604-1106-131A

Dates of Test
May 25, June 2 to June 28, 2011

FCC ID: L6ARDR60CW, L6ARDS40CW
IC: 2503A-RDR60CW, 2503A-RDS40CW

PCS Results: channel 600 @ maximum transmitted power

Traffic Channel Number	Frequency (MHz)	Voltage (Volts)	Temperature (Celsius)	Frequency Error (Hz)	PPM
600	1880.00	3.6	-30	12.00	0.0064
600	1880.00	3.6	-20	13.00	0.0069
600	1880.00	3.6	-10	17.00	0.0090
600	1880.00	3.6	0	17.00	0.0043
600	1880.00	3.6	10	13.00	0.0069
600	1880.00	3.6	20	-9.00	-0.0048
600	1880.00	3.6	30	-12.00	-0.0064
600	1880.00	3.6	40	15.00	0.0080
600	1880.00	3.6	50	-8.00	-0.0043
600	1880.00	3.6	60	8.00	0.0043

Traffic Channel Number	Frequency (MHz)	Voltage (Volts)	Temperature (Celsius)	Frequency Error (Hz)	PPM
600	1880.00	3.7	-30	12.00	0.0064
600	1880.00	3.7	-20	13.00	0.0069
600	1880.00	3.7	-10	15.00	0.0080
600	1880.00	3.7	0	11.00	0.0059
600	1880.00	3.7	10	-11.00	-0.0059
600	1880.00	3.7	20	-12.00	-0.0064
600	1880.00	3.7	30	-14.00	-0.0074
600	1880.00	3.7	40	-12.00	-0.0064
600	1880.00	3.7	50	12.00	0.0064
600	1880.00	3.7	60	-6.00	-0.0032

Traffic Channel Number	Frequency (MHz)	Voltage (Volts)	Temperature (Celsius)	Frequency Error (Hz)	PPM
600	1880.00	4.2	-30	12.00	0.0064
600	1880.00	4.2	-20	9.00	0.0048
600	1880.00	4.2	-10	9.00	0.0048
600	1880.00	4.2	0	19.00	0.0101
600	1880.00	4.2	10	10.00	0.0053
600	1880.00	4.2	20	14.00	0.0074
600	1880.00	4.2	30	-8.00	-0.0043
600	1880.00	4.2	40	-13.00	-0.0069
600	1880.00	4.2	50	10.00	0.0053
600	1880.00	4.2	60	-9.00	-0.0048



EMI Test Report for the BlackBerry® smartphone Model RDR61CW,RDS41CW
Appendix 3B

Test Report No.
RTS-2604-1106-131A

Dates of Test
May 25, June 2 to June 28, 2011

FCC ID: L6ARDR60CW, L6ARDS40CW
IC: 2503A-RDR60CW, 2503A-RDS40CW

PCS Results: channel 1175 @ maximum transmitted power

Traffic Channel Number	Frequency (MHz)	Voltage (Volts)	Temperature (Celsius)	Frequency Error (Hz)	PPM
1175	1908.75	3.6	-30	18.00	0.0094
1175	1908.75	3.6	-20	16.00	0.0084
1175	1908.75	3.6	-10	18.00	0.0094
1175	1908.75	3.6	0	16.00	-0.0047
1175	1908.75	3.6	10	16.00	0.0084
1175	1908.75	3.6	20	15.00	0.0079
1175	1908.75	3.6	30	-14.00	-0.0073
1175	1908.75	3.6	40	-15.00	-0.0079
1175	1908.75	3.6	50	-16.00	-0.0084
1175	1908.75	3.6	60	-9.00	-0.0047

Traffic Channel Number	Frequency (MHz)	Voltage (Volts)	Temperature (Celsius)	Frequency Error (Hz)	PPM
1175	1908.75	3.7	-30	11.00	0.0058
1175	1908.75	3.7	-20	15.00	0.0079
1175	1908.75	3.7	-10	16.00	0.0084
1175	1908.75	3.7	0	15.00	0.0079
1175	1908.75	3.7	10	17.00	0.0089
1175	1908.75	3.7	20	15.00	0.0079
1175	1908.75	3.7	30	-18.00	-0.0094
1175	1908.75	3.7	40	-17.00	-0.0089
1175	1908.75	3.7	50	-12.00	-0.0063
1175	1908.75	3.7	60	-20.00	-0.0105

Traffic Channel Number	Frequency (MHz)	Voltage (Volts)	Temperature (Celsius)	Frequency Error (Hz)	PPM
1175	1908.75	4.2	-30	12.00	0.0063
1175	1908.75	4.2	-20	19.00	0.0100
1175	1908.75	4.2	-10	13.00	0.0068
1175	1908.75	4.2	0	19.00	0.0100
1175	1908.75	4.2	10	12.00	0.0063
1175	1908.75	4.2	20	-12.00	-0.0063
1175	1908.75	4.2	30	-13.00	-0.0068
1175	1908.75	4.2	40	-14.00	-0.0073
1175	1908.75	4.2	50	-12.00	-0.0063
1175	1908.75	4.2	60	-13.00	-0.0068

This report shall NOT be reproduced except in full without the written consent of RIM Testing Services
- A division of Research in Motion Limited.

APPENDIX 3C – CDMA BC10 FREQUENCY STABILITY TEST DATA

Test Report No.
RTS-2604-1106-131A

Dates of Test
May 25, June 2 to June 28, 2011

FCC ID: L6ARDR60CW, L6ARDS40CW
IC: 2503A-RDR60CW, 2503A-RDS40CW

CDMA Frequency Stability Test Data

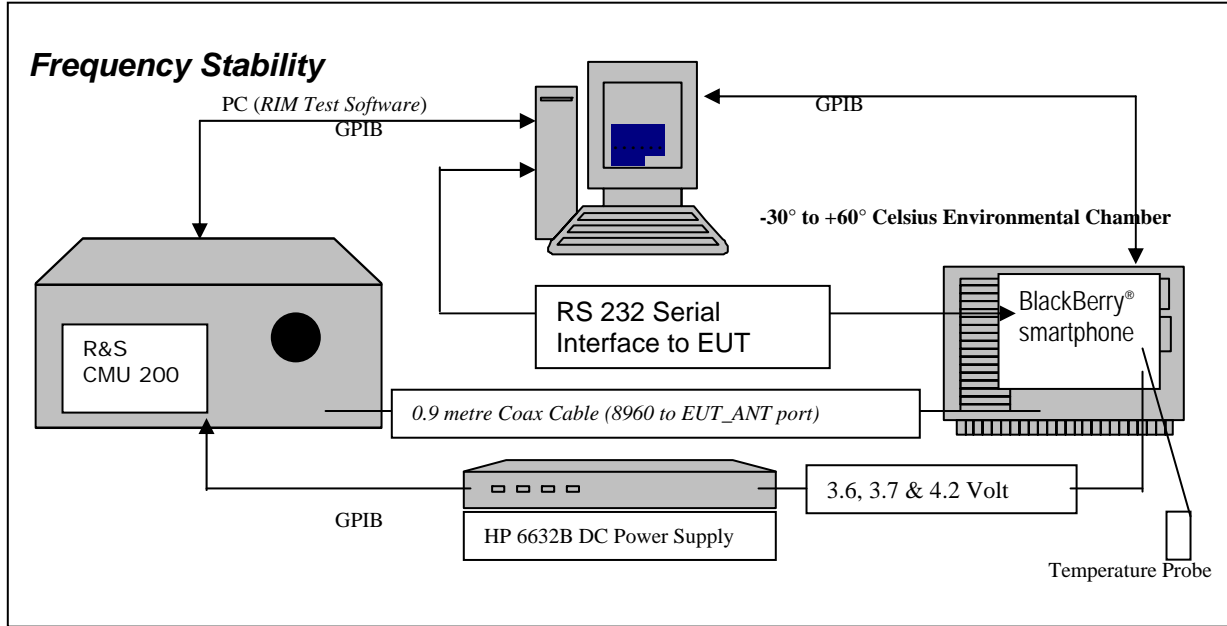

CFR 47 Chapter 1 - Federal Communications Commission Rules

Part 2 Required Measurements

- 2.1055** Frequency Stability - Procedures
- (a,b) Frequency Stability - Temperature Variation
- (d) Frequency Stability - Voltage Variation

22.917/24.235 Frequency Stability.

The frequency stability shall be sufficient to ensure that the fundamental emission stays within the authorized frequency block.

The RDS41CW BlackBerry® smartphone, (referred as EUT herein and after) transmitted frequencies are less than 0.1 ppm of the received frequency from the Agilent 8960 CDMA Base Station Simulator

The EUT meets the requirements as stated in CFR 47 chapter 1, Section 24.235, RSS-133, CFR 47 chapter 1, Section 22.917 and RSS-132 Frequency Stability.

Frequency Stability measurement devices were configured as presented in the block diagram recording frequency, power, data, temperatures, and stepped voltages controlled via a GPIB interface linked to the Environmental chamber, a DC power supply, and the Communications Test Set. A 0.9-metre coax cable was calibrated to characterize the insertion loss for the transmitted frequencies between the RF input/output of the base station simulator and the EUT antenna port; located inside the environmental chamber.

Calibration for the Cable Loss was performed in the RF Laboratory using the Giga-tronics power metre and Agilent Signal Generator.

		EMI Test Report for the BlackBerry® smartphone Model RDR61CW,RDS41CW Appendix 3C	
Test Report No. RTS-2604-1106-131A	Dates of Test May 25, June 2 to June 28, 2011	FCC ID: L6ARDR60CW, L6ARDS40CW IC: 2503A-RDR60CW, 2503A-RDS40CW	

The cable assembly from the RF input to the RF output was measured at the following Frequencies:

Cellular Frequency (MHz)	Cable loss (dB)
817.90	1.00
820.50	1.00
823.10	1.00

Procedure:

The EUT was placed in the Temperature chamber and connected to the Agilent 8960 outside as shown in the figure above. Dry air was pumped inside the temperature chamber to maintain a backpressure during the test. The EUT was kept in the off condition at all times except when the measurements were to be made.

The chamber was switched on and the temperature was set to -30°C. After the chamber stabilized at -30 °C there was a soak period of one hour to alleviate moisture in the chamber, the EUT voltage was enabled. The system software recorded the frequency, power, and associated measurements.

A Computer system controlled the automated software. This application was given the command of activating all machines intrinsic to the temperature and voltage tests controlling the base station simulator via the GPIB Bus. The Environmental Chamber was instructed through an RS-232 serial line. The EUT dialogue was passed through a serial connection.

The EUT repetitively transmitted 100 bursts for each set of programmed parameters recording temperature, voltage settings, and systematically selected frequencies. The power supply was cycled from minimum voltage 3.6 volts, to 3.7 volts nominal voltage to 4.2 volts maximum voltage. The frequency error was measured at a maximum output power and recorded by the automated system test software.

The EUT output power and frequency was measured at 3.6 volts, 3.7 volts and 4.2 volts. The transmit frequency was varied in 3 steps consisting of 824.70, 836.52, and 848.31 MHz for the cellular band and 1851.20, 1880.00 and 1908.75 MHz for the PCS band. This frequency was recorded in MHz and deviation from nominal, in Parts per Million. After the initial one-hour soak at the beginning of the tests, a period of thirty minutes soak was initialized between each ascending temperature step, before proceeding to the next measurement test cycle.

PROCEDURE:

	EMI Test Report for the BlackBerry® smartphone Model RDR61CW,RDS41CW Appendix 3C	
Test Report No. RTS-2604-1106-131A	Dates of Test May 25, June 2 to June 28, 2011	FCC ID: L6ARDR60CW, L6ARDS40CW IC: 2503A-RDR60CW, 2503A-RDS40CW

The test system software for commencing the Frequency Stability Tests carried through the following cycle.

15. Switch on the HP 6632B power supply; CMU 200 Communications test Set, and Environmental Chamber.
16. Start test program
17. Set the Temperature to -30°C and maintain a period of one- hour soak time, with the EUT supply voltage disabled.
18. Set power supply voltage to 3.6 volts.
19. Set up CMU 200 Radio Communication Tester.
20. Command the CMU 200 to switch to the low channel.
21. Enable the voltage to the EUT, and connect a link to the CMU 200 test set.
22. EUT is commanded to Transmit 100 Bursts.
23. Software logs the following data from the CMU 200, power supply and temperature chamber: Traffic Channel Number, Traffic Channel Frequency, Power Level, Chamber Temperature, Supply Voltage, Power and Frequency Error.
24. The CMU 200 commands the EUT to change frequency to the middle channel and high channel and repeats steps 7 to 9.
25. Repeat steps 5 to 10 changing the supply voltage to 3.7 Volts
26. Increase temperature by 10°C and soak for 1/2 hour.
27. Repeat steps 4 - 12 for temperatures -30°C to 60°C .
28. Repeat steps 5 to 10 changing the supply voltage to 4.2 volts

Procedure 5 to 10 was repeated at room temperature (20°C) with the power supply voltage set to 3.6, 3.7 and 4.2 volts

The maximum frequency error in the CDMA Cellular band measured was **-0.0293 PPM.**

Test Report No.
RTS-2604-1106-131A

Dates of Test
May 25, June 2 to June 28, 2011

FCC ID: L6ARDR60CW, L6ARDS40CW
IC: 2503A-RDR60CW, 2503A-RDS40CW

Cellular Channel results: channels 476, 580 and 684 @ 20°C maximum transmitted power

Traffic Channel Number	Cellular Frequency (MHz)	Voltage (Volts)	Temperature (Celsius)	Frequency Error (Hz)	PPM
476	817.900	3.6	20	-14	-0.0171
580	820.500	3.6	20	-9	-0.0110
684	823.100	3.6	20	-7	-0.0085

Traffic Channel Number	Cellular Frequency (MHz)	Voltage (Volts)	Temperature (Celsius)	Frequency Error (Hz)	PPM
476	817.900	3.7	20	-11	-0.0134
580	820.500	3.7	20	10	0.0122
684	823.100	3.7	20	-9	0.0121

Traffic Channel Number	Cellular Frequency (MHz)	Voltage (Volts)	Temperature (Celsius)	Frequency Error (Hz)	PPM
476	817.900	4.2	20	-11	-0.0134
580	820.500	4.2	20	10	0.0122
684	823.100	4.2	20	-9	0.0121

Test Report No.
RTS-2604-1106-131A

Dates of Test
May 25, June 2 to June 28, 2011

FCC ID: L6ARDR60CW, L6ARDS40CW
IC: 2503A-RDR60CW, 2503A-RDS40CW

Cellular Results: channel 476 @ maximum transmitted power

Traffic Channel Number	Frequency (MHz)	Voltage (Volts)	Temperature (Celsius)	Frequency Error (Hz)	PPM
476	817.900	3.6	-30	-10	-0.0122
476	817.900	3.6	-20	-16	-0.0196
476	817.900	3.6	-10	-21	-0.0257
476	817.900	3.6	0	-24	-0.0293
476	817.900	3.6	10	-17	-0.0208
476	817.900	3.6	20	-14	-0.0171
476	817.900	3.6	30	12	0.0147
476	817.900	3.6	40	18	0.0196
476	817.900	3.6	50	16	0.0196
476	817.900	3.6	60	29	0.0355

Traffic Channel Number	Frequency (MHz)	Voltage (Volts)	Temperature (Celsius)	Frequency Error (Hz)	PPM
476	817.900	3.7	-30	-13	-0.0159
476	817.900	3.7	-20	-15	-0.0183
476	817.900	3.7	-10	-18	-0.0220
476	817.900	3.7	0	-16	-0.0196
476	817.900	3.7	10	-19	-0.0232
476	817.900	3.7	20	-11	-0.0134
476	817.900	3.7	30	15	0.0245
476	817.900	3.7	40	20	0.0232
476	817.900	3.7	50	19	0.0232
476	817.900	3.7	60	15	0.0183

Traffic Channel Number	Frequency (MHz)	Voltage (Volts)	Temperature (Celsius)	Frequency Error (Hz)	PPM
476	817.900	4.2	-30	-10	-0.0122
476	817.900	4.2	-20	-19	-0.0232
476	817.900	4.2	-10	-18	-0.0220
476	817.900	4.2	0	-14	-0.0171
476	817.900	4.2	10	-19	-0.0232
476	817.900	4.2	20	-11	-0.0134
476	817.900	4.2	30	16	0.0196
476	817.900	4.2	40	21	0.0245
476	817.900	4.2	50	20	0.0245
476	817.900	4.2	60	22	0.0269

Test Report No.
RTS-2604-1106-131A

Dates of Test
May 25, June 2 to June 28, 2011

FCC ID: L6ARDR60CW, L6ARDS40CW
IC: 2503A-RDR60CW, 2503A-RDS40CW

Cellular Results: channel 580 @ maximum transmitted power

Traffic Channel Number	Frequency (MHz)	Voltage (Volts)	Temperature (Celsius)	Frequency Error (Hz)	PPM
580	820.500	3.6	-30	-11	-0.0134
580	820.500	3.6	-20	-17	-0.0207
580	820.500	3.6	-10	-21	-0.0256
580	820.500	3.6	0	-15	-0.0183
580	820.500	3.6	10	-16	-0.0195
580	820.500	3.6	20	-9	-0.0110
580	820.500	3.6	30	12	0.0146
580	820.500	3.6	40	17	0.0183
580	820.500	3.6	50	15	0.0183
580	820.500	3.6	60	15	0.0183

Traffic Channel Number	Frequency (MHz)	Voltage (Volts)	Temperature (Celsius)	Frequency Error (Hz)	PPM
580	820.500	3.7	-30	-10	-0.0122
580	820.500	3.7	-20	-16	-0.0195
580	820.500	3.7	-10	-17	-0.0207
580	820.500	3.7	0	-14	-0.0171
580	820.500	3.7	10	-11	-0.0134
580	820.500	3.7	20	10	0.0122
580	820.500	3.7	30	-11	0.0122
580	820.500	3.7	40	12	0.0171
580	820.500	3.7	50	14	0.0171
580	820.500	3.7	60	15	0.0183

Traffic Channel Number	Frequency (MHz)	Voltage (Volts)	Temperature (Celsius)	Frequency Error (Hz)	PPM
580	820.500	4.2	-30	-13	-0.0158
580	820.500	4.2	-20	-16	-0.0195
580	820.500	4.2	-10	-19	-0.0232
580	820.500	4.2	0	-15	-0.0183
580	820.500	4.2	10	-17	-0.0207
580	820.500	4.2	20	10	0.0122
580	820.500	4.2	30	7	0.0085
580	820.500	4.2	40	12	0.0219
580	820.500	4.2	50	18	0.0219
580	820.500	4.2	60	15	0.0183

Test Report No.
RTS-2604-1106-131A

Dates of Test
May 25, June 2 to June 28, 2011

FCC ID: L6ARDR60CW, L6ARDS40CW
IC: 2503A-RDR60CW, 2503A-RDS40CW

Cellular Results: channel 684 @ maximum transmitted power

Traffic Channel Number	Frequency (MHz)	Voltage (Volts)	Temperature (Celsius)	Frequency Error (Hz)	PPM
684	823.100	3.6	-30	-14	-0.0170
684	823.100	3.6	-20	-19	-0.0231
684	823.100	3.6	-10	-16	-0.0194
684	823.100	3.6	0	-14	-0.0170
684	823.100	3.6	10	-13	-0.0158
684	823.100	3.6	20	-7	-0.0085
684	823.100	3.6	30	10	0.0121
684	823.100	3.6	40	19	0.0231
684	823.100	3.6	50	20	0.0243
684	823.100	3.6	60	14	0.0170

Traffic Channel Number	Frequency (MHz)	Voltage (Volts)	Temperature (Celsius)	Frequency Error (Hz)	PPM
684	823.100	3.7	-30	-15	-0.0182
684	823.100	3.7	-20	-19	-0.0231
684	823.100	3.7	-10	-16	-0.0194
684	823.100	3.7	0	-16	-0.0194
684	823.100	3.7	10	-13	-0.0158
684	823.100	3.7	20	-9	-0.0158
684	823.100	3.7	30	15	0.0182
684	823.100	3.7	40	10	0.0121
684	823.100	3.7	50	14	0.0170
684	823.100	3.7	60	14	0.0170

Traffic Channel Number	Frequency (MHz)	Voltage (Volts)	Temperature (Celsius)	Frequency Error (Hz)	PPM
684	823.100	4.2	-30	-15	-0.0182
684	823.100	4.2	-20	-17	-0.0207
684	823.100	4.2	-10	-16	-0.0194
684	823.100	4.2	0	-14	-0.0170
684	823.100	4.2	10	-14	-0.0170
684	823.100	4.2	20	-9	-0.0170
684	823.100	4.2	30	7	0.0085
684	823.100	4.2	40	18	0.0219
684	823.100	4.2	50	15	0.0182
684	823.100	4.2	60	14	0.0170

APPENDIX 4A – GSM RADIATED EMISSIONS TEST DATA

Test Report No. RTS-2604-1106-131A	Dates of Test May 25, June 2 to June 28, 2011	FCC ID: L6ARDR60CW, L6ARDS40CW IC: 2503A-RDR60CW, 2503A-RDS40CW
--	---	--

Radiated Power Test Data Results

Date of test: June 2, 2011

The following measurements were performed by Quan (Jerry) Ma.

The environmental tests conditions were: Temperature: 23.4 °C
Relative Humidity: 34.1 %

The BlackBerry® smartphone was in standalone, horizontal down position.
Test distance was 3.0 metres.

GSM850 Band Call Mode

EUT				Rx Antenna		Spectrum Analyzer		Substitution Method				Limit (dBm)	Diff. To Limit (dB)
Type	Ch	Frequency (MHz)	Band	Type	Pol.	Reading (dBuV)	Max (V,H) (dBuV)	Tracking Generator		Corrected Reading (relative to Dipole)			
								Pol. Tx-Rx	Reading (dBm)	(dBm)	(W)		
F0	128	824.20	850	Dipole	V	79.76	87.62	V-V	13.83	32.11	1.63	38.50	-6.39
F0	128	824.20	850	Dipole	H	87.62		H-H	12.29				
F0	190	836.60	850	Dipole	V	76.24	86.63	V-V	14.00	31.98	1.58	38.50	-6.52
F0	190	836.60	850	Dipole	H	86.63		H-H	12.86				
F0	251	848.80	850	Dipole	V	74.25	84.85	V-V	13.25	31.27	1.34	38.50	-7.23
F0	251	848.80	850	Dipole	H	84.85		H-H	11.16				

GSM850 Band EDGE Mode

EUT				Rx Antenna		Spectrum Analyzer		Substitution Method				Limit (dBm)	Diff. To Limit (dB)
Type	Ch	Frequency (MHz)	Band	Type	Pol.	Reading (dBuV)	Max (V,H) (dBuV)	Tracking Generator		Corrected Reading (relative to Dipole)			
								Pol. Tx-Rx	Reading (dBm)	(dBm)	(W)		
F0	128	824.20	850	Dipole	V	77.73	85.95	V-V	12.14	30.42	1.10	38.50	-8.08
F0	128	824.20	850	Dipole	H	85.95		H-H	10.58				
F0	190	836.60	850	Dipole	V	77.97	85.08	V-V	12.44	30.42	1.10	38.50	-8.08
F0	190	836.60	850	Dipole	H	85.08		H-H	11.28				
F0	251	848.80	850	Dipole	V	72.46	83.54	V-V	11.93	29.95	0.99	38.50	-8.55
F0	251	848.80	850	Dipole	H	83.54		H-H	9.86				

Test Report No. RTS-2604-1106-131A	Dates of Test May 25, June 2 to June 28, 2011	FCC ID: L6ARDR60CW, L6ARDS40CW IC: 2503A-RDR60CW, 2503A-RDS40CW
--	---	--

Radiated Power Test Data Results cont'd

Date of test: June 02, 2011

The following measurements were performed by Adam Rusinek.

The environmental tests conditions were: Temperature: 25 °C
Relative Humidity: 41.4%

The BlackBerry® smartphone was in standalone, USB up position.
Test distance is 3.0 metres.

PCS1900 Band Call Mode

EUT								Substitution Method					
EUT				Receive Antenna		Spectrum Analyzer		Tracking Generator					
Type	Ch	Frequency (MHz)	Band	Type	Pol.	Reading (dBuV)	Max (V,H) dBuV	Pol. Tx-Rx	Reading (dBm)	Corrected Reading (relative to Isotropic Radiator)		Limit (dBm)	Diff to Limit (dB)
										(dBm)	(W)		
F0	512	1850.20	1900	Horn	V	90.12	90.12	V-V	-3.92	30.92	1.34	33.00	2.08
F0	512	1850.20	1900	Horn	H	85.13		H-H	-3.89				
F0	661	1880.00	1900	Horn	V	90.6	90.6	V-V	-3.08	32.35	1.72	33.00	0.65
F0	661	1880.00	1900	Horn	H	88.57		H-H	-2.55				
F0	810	1909.80	1900	Horn	V	90.66	90.66	V-V	-2.04	31.91	1.55	33.00	1.09
F0	810	1909.80	1900	Horn	H	88.87		H-H	-2.07				

PCS1900 Band EDGE Mode

EUT								Substitution Method					
EUT				Receive Antenna		Spectrum Analyzer		Tracking Generator					
Type	Ch	Frequency (MHz)	Band	Type	Pol.	Reading (dBuV)	Max (V,H) dBuV	Pol. Tx-Rx	Reading (dBm)	Corrected Reading (relative to Isotropic Radiator)		Limit (dBm)	Diff to Limit (dB)
										(dBm)	(W)		
F0	512	1850.20	1900	Horn	V	88.83	88.83	V-V	-5.21	30.17	1.04	33.00	2.83
F0	512	1850.20	1900	Horn	H	83.47		H-H	-4.64				
F0	661	1880.00	1900	Horn	V	89.02	89.02	V-V	-4.66	31.54	1.43	33.00	1.46
F0	661	1880.00	1900	Horn	H	86.88		H-H	-3.36				
F0	810	1909.80	1900	Horn	V	89.31	89.31	V-V	-3.39	30.84	1.21	33.00	2.16
F0	810	1909.80	1900	Horn	H	86.98		H-H	-3.11				

Test Report No.
RTS-2604-1106-131ADates of Test
May 25, June 2 to June 28, 2011FCC ID: L6ARDR60CW, L6ARDS40CW
IC: 2503A-RDR60CW, 2503A-RDS40CWRadiated Emissions Test Data Results cont'd**GSM850 Call Mode**

Date of Test: June 2, 2011

The following measurements were performed by Quan (Jerry) Ma

The environmental test conditions were: Temperature: 25.3 °C
Relative Humidity: 33.2%

Test Distance was 3.0 metres with a height of 1.0 metres, and a frequency range of 30 MHz to 1000 MHz.

The BlackBerry® smartphone was in standalone, vertical position.

The measurements were performed in GSM850 Call Tx mode, channels 128, 190, 251.

All emissions had a test margin greater than 25.0 dB.

Date of Test: June 7, 2011

The following measurements were performed by Adam Rusinek.

The environmental test conditions were: Temperature: 25.4 °C
Relative Humidity: 43.6 %

Test Distance was 3.0 metres with a height of 1metre, and a frequency range of 1 GHz to 9 GHz.

The BlackBerry® smartphone was in standalone, vertical position.

The measurements were performed in GSM850 Call Tx mode, channels 128, 190, 251.

All other emissions had a test margin greater than 25.0 dB

Test Report No.
RTS-2604-1106-131ADates of Test
May 25, June 2 to June 28, 2011FCC ID: L6ARDR60CW, L6ARDS40CW
IC: 2503A-RDR60CW, 2503A-RDS40CWRadiated Emissions Test Data Results cont'd**GSM850 EDGE Mode**

Date of Test: June 2, 2011

The environmental test conditions were: Temperature: 24.3 °C
Relative Humidity: 14.3 %

Test Distance was 3.0 metres with a height of 1.0 metres, and a frequency range of 30 MHz to 1000 MHz.

The BlackBerry® smartphone was in standalone, vertical position.

The measurements were performed in GSM850 EDGE Tx mode, channels 128, 190, 251.

All emissions had a test margin greater than 25.0 dB.

Date of Test: June 7, 2011

The environmental test conditions were: Temperature: 25.4 °C
Relative Humidity: 43.6 %

Test Distance was 3.0 metres with a height of 1-4 metres, and a frequency range of 1 GHz to 9 GHz.

The BlackBerry® smartphone was in standalone, vertical position.

The measurements were performed in GSM850 EDGE Tx mode, channels 128, 190, 251.

All other emissions had a test margin greater than 25.0 dB

Test Report No.
RTS-2604-1106-131ADates of Test
May 25, June 2 to June 28, 2011FCC ID: L6ARDR60CW, L6ARDS40CW
IC: 2503A-RDR60CW, 2503A-RDS40CWRadiated Emissions Test Data Results cont'dPCS1900 Call Mode

Date of Test: June 13, 2011

The following measurements were performed by Quan (Jerry) Ma.

The environmental test conditions were: Temperature: 25.4 °C
Relative Humidity: 33.2 %

Test Distance was 3.0 metres with a height of 1-4 meters, and a frequency range of 30MHz - 1000 MHz.

The BlackBerry® smartphone was in standalone, USB down position.

The measurements were performed in PCS1900 Call Tx mode, channels 512, 661, 810.

All emissions had a test margin greater than 25.0 dB.

Date of Test: June 8, 2011

The following measurements were performed by Adam Rusinek.

The environmental test conditions were: Temperature: 25.4 °C
Relative Humidity: 43.6 %

Test Distance was 3.0 metres with a height of 1.0 metres, and a frequency range of 1 GHz to 20 GHz.

The BlackBerry® smartphone was in standalone, horizontal position.

The measurements were performed in PCS1900 Call Tx, channels 512, 661, 810.

All emissions had a test margin greater than 25.0 dB.

Test Report No.
RTS-2604-1106-131ADates of Test
May 25, June 2 to June 28, 2011FCC ID: L6ARDR60CW, L6ARDS40CW
IC: 2503A-RDR60CW, 2503A-RDS40CWRadiated Emissions Test Data Results cont'd**PCS1900 EDGE Mode**

Date of Test: June 13, 2011

The environmental test conditions were: Temperature: 25.4 °C
Relative Humidity: 33.2 %

Test Distance was 3.0 metres with a height of 1metre, and a frequency range of 30MHz - 1000 MHz.

The BlackBerry® smartphone was in standalone, horizontal position.

The measurements were performed in PCS1900 Edge Tx mode, channels 512, 661, 810.

All emissions had a test margin greater than 25.0 dB.

Date of Test: June 13, 2011

The environmental test conditions were: Temperature: 25.8 °C
Relative Humidity: 37.5 %

Test Distance was 3.0 metres with a height of 1.0 metres, and a frequency range of 1 GHz to 20 GHz.

The BlackBerry® smartphone was in standalone, Horizontal position.

The measurements were performed in PCS1900 Edge Tx mode, channels 512, 661, 810.

All emissions had a test margin greater than 25.0 dB.

APPENDIX 4B – CDMA RADIATED EMISSIONS TEST DATA

Test Report No.
RTS-2604-1106-131A

Dates of Test
May 25, June 2 to June 28, 2011

FCC ID: L6ARDR60CW, L6ARDS40CW
IC: 2503A-RDR60CW, 2503A-RDS40CW

Radiated Power Test Data Results

The following test configurations were measured for model RDR61CW:

Date of Test: June 2, 2011

The following measurements were performed by Quan (Jerry) Ma
The environmental tests conditions were: Temperature: 25.4 °C
Relative Humidity: 31.2%

The BlackBerry® smartphone - was in standalone, USB up position.
Test distance is 3.0 metres

Cellular Loopback Service Mode

EUT				Rx Antenna		Spectrum Analyzer		Substitution Method Tracking Generator				Limit (dBm)	Diff. To Limit (dB)
Type	Ch	Frequency (MHz)	Band	Type	Pol.	Reading (dBuV)	Max (V,H) (dBuV)	Pol. Tx-Rx	Reading (dBm)	Corrected Reading (relative to Dipole)			
										(dBm)	(W)		
F0	1013	824.70	Cell	Dipole	V	73.75	82.71	V-V	9.90	25.04	0.32	39.0	-14.0
F0	1013	824.70	Cell	Dipole	H	82.71		H-H	7.90				
F0	384	836.52	Cell	Dipole	V	74.06	81.7	V-V	9.70	24.74	0.30	39.0	-14.3
F0	384	836.52	Cell	Dipole	H	81.7		H-H	8.00				
F0	777	848.32	Cell	Dipole	V	70.67	81.03	V-V	8.90	23.93	0.25	39.0	-15.1
F0	777	848.32	Cell	Dipole	H	81.03		H-H	6.80				

Cellular EVDO Mode

EUT				Rx Antenna		Spectrum Analyzer		Substitution Method Tracking Generator				Limit (dBm)	Diff. To Limit (dB)
Type	Ch	Frequency (MHz)	Band	Type	Pol.	Reading (dBuV)	Max (V,H) (dBuV)	Pol. Tx-Rx	Reading (dBm)	Corrected Reading (relative to Dipole)			
										(dBm)	(W)		
F0	1013	824.70	Cell	Dipole	V	74.78	83.06	V-V	10.79	25.93	0.39	39.0	-13.1
F0	1013	824.70	Cell	Dipole	H	83.06		H-H	8.78				
F0	384	836.52	Cell	Dipole	V	74.76	82.61	V-V	11.14	26.18	0.42	39.0	-12.8
F0	384	836.52	Cell	Dipole	H	82.61		H-H	9.47				
F0	777	848.32	Cell	Dipole	V	70.85	81.34	V-V	9.36	24.39	0.28	39.0	-14.6
F0	777	848.32	Cell	Dipole	H	81.34		H-H	7.20				

Test Report No.
RTS-2604-1106-131A

Dates of Test
May 25, June 2 to June 28, 2011

FCC ID: L6ARDR60CW, L6ARDS40CW
IC: 2503A-RDR60CW, 2503A-RDS40CW

Radiated Power Test Data Results cont'd

Date of Test: June 2, 2011

The following measurements were performed by Quan (Jerry) Ma.

The environmental tests conditions were: Temperature: 24 °C
Relative Humidity: 30%

The BlackBerry® smartphone - was in standalone, USB down position.
Test distance is 3.0 metres

PCS Loopback Service Mode

										Substitution Method			
EUT				Receive Antenna		Spectrum Analyzer		Tracking Generator					
Type	Ch	Frequency (MHz)	Band	Type	Pol.	Reading (dBuV)	Max (V,H) (dBuV)	Pol. Tx-Rx	Reading (dBm)	(dBm)	(W)	Limit (dBm)	Diff to Limit (dB)
F0	25	1851.25	PCS	Horn	V	84.83	87.15	VV	-12.17	26.08	0.41	33.00	-6.9
F0	25	1851.25	PCS	Horn	H	87.15		HH	-10.30				
F0	600	1880.00	PCS	Horn	V	79.00	88.25	VV	-10.47	27.19	0.52	33.00	-5.8
F0	600	1880.00	PCS	Horn	H	88.25		HH	-9.09				
F0	1175	1908.75	PCS	Horn	V	76.84	85.19	VV	-13.18	24.45	0.28	33.00	-8.6
F0	1175	1908.75	PCS	Horn	H	85.19		HH	-11.87				

PCS EVDO Mode

										Substitution Method			
EUT				Receive Antenna		Spectrum Analyzer		Tracking Generator					
Type	Ch	Frequency (MHz)	Band	Type	Pol.	Reading (dBuV)	Max (V,H) (dBuV)	Pol. Tx-Rx	Reading (dBm)	(dBm)	(W)	Limit (dBm)	Diff to Limit (dB)
F0	25	1851.25	PCS	Horn	V	85.07	87.5	VV	-11.81	26.45	0.44	33.00	-6.6
F0	25	1851.25	PCS	Horn	H	87.50		HH	-9.93				
F0	600	1880.00	PCS	Horn	V	78.09	88.39	VV	-10.28	27.39	0.55	33.00	-5.6
F0	600	1880.00	PCS	Horn	H	88.39		HH	-8.89				
F0	1175	1908.75	PCS	Horn	V	76.85	85.07	VV	-13.35	24.32	0.27	33.00	-8.7
F0	1175	1908.75	PCS	Horn	H	85.07		HH	-12.00				



Test Report No.
RTS-2604-1106-131A

Dates of Test
May 25, June 2 to June 28, 2011

FCC ID: L6ARDR60CW, L6ARDS40CW
IC: 2503A-RDR60CW, 2503A-RDS40CW

Radiated Emissions Test Data Results cont'd

Cellular Loopback Service Mode

Date of Test: June 2, 2011

The following measurements were performed by Quan (Jerry) Ma

The environmental test conditions were: Temperature: 25.4 °C
Relative Humidity: 31.2 %

Test Distance was 3.0 metres with a height of 1-4 metres, and a frequency range of 30 MHz to 1000 MHz.

The BlackBerry® smartphone was in standalone, horizontal down position.

The following measurements were performed in CDMA Cellular Loopback Tx mode on channels 1013, 384 and 777.

All emissions had a test margin greater than 25.0 dB.

Date of Test: June 3, 2011

The following measurements were performed by Adam Rusinek

The environmental test conditions were: Temperature: 24.6°C
Relative Humidity: 39.2 %

Test Distance was 3.0 metres with a height of 1-4 metres, and a frequency range of 1GHz-9 GHz.

The BlackBerry® smartphone was in standalone, horizontal down position.

The following measurements were performed in CDMA Cellular Loopback Tx mode on channels 1013, 384 and 777.

All emissions had a test margin greater than 25.0 dB.



Test Report No.
RTS-2604-1106-131A

Dates of Test
May 25, June 2 to June 28, 2011

FCC ID: L6ARDR60CW, L6ARDS40CW
IC: 2503A-RDR60CW, 2503A-RDS40CW

Radiated Emissions Test Data Results cont'd

Cellular 1xEVDO Mode

Date of Test: June 2, 2011

The environmental test conditions were: Temperature: 25.4 °C
Relative Humidity: 31.2 %

Test Distance was 3.0 metres with a height of 1-4 metres, and a frequency range of 30 MHz to 1000 MHz.

The BlackBerry® smartphone was in standalone, horizontal down position.

The following measurements were performed in CDMA Cellular EVDO Tx mode on channels 1013, 384 and 777.

All emissions had a test margin greater than 25.0 dB.

Date of Test: June 6, 2011

The environmental test conditions were: Temperature: 24.9°C
Relative Humidity: 42.8 %

Test Distance was 3.0 metres with a height of 1-4 metres, and a frequency range of 1GHz-9 GHz.

The BlackBerry® smartphone was in standalone, horizontal down position.

The following measurements were performed in CDMA Cellular EVDO Tx mode on channels 1013, 384 and 777.

All emissions had a test margin greater than 25.0 dB.

Test Report No.
RTS-2604-1106-131ADates of Test
May 25, June 2 to June 28, 2011FCC ID: L6ARDR60CW, L6ARDS40CW
IC: 2503A-RDR60CW, 2503A-RDS40CWRadiated Emissions Test Data Results cont'dPCS Loopback Service Mode

Date of Test: June 2, 2011

The following measurements were performed by Quan (Jerry) Ma

The environmental test conditions were: Temperature: 23.4 °C
Relative Humidity: 28.2 %

Test Distance was 3.0 metres with a height of 1-4 metres, and a frequency range of 30 MHz to 1000 MHz.

The BlackBerry® smartphone was in standalone, horizontal down position.

The following measurements were performed in PCS Tx mode on channels 25, 600 and 1175.

All emissions had a test margin greater than 25.0 dB.

Date of Test: June 6, 2011

The following measurements were performed by Adam Rusinek

The environmental test conditions were: Temperature: 24.6°C
Relative Humidity: 42.6 %

Test Distance was 3.0 metres with a height of 1-4 metres, and a frequency range of 1GHz-20GHz.

The BlackBerry® smartphone was in standalone, horizontal position.

The following measurements were performed in PCS Tx mode on channels 25, 600 and 1175.

All emissions had a test margin greater than 25.0 dB.

Test Report No.
RTS-2604-1106-131ADates of Test
May 25, June 2 to June 28, 2011FCC ID: L6ARDR60CW, L6ARDS40CW
IC: 2503A-RDR60CW, 2503A-RDS40CWRadiated Emissions Test Data Results cont'dPCS 1xEVDO Mode

Date of Test: June 2, 2011

The environmental test conditions were: Temperature: 23.4 °C
Relative Humidity: 28.2 %

Test Distance was 3.0 metres with a height of 1-4 metres, and a frequency range of 30 MHz to 1000 MHz.

The BlackBerry® smartphone was in standalone, horizontal down position.

The following measurements were performed in PCS Tx mode on channels 25, 600 and 1175.

All emissions had a test margin greater than 25.0 dB.

Date of Test: June 16, 2011

The environmental test conditions were: Temperature: 25 °C
Relative Humidity: 42.6%

Test Distance was 3.0 metres with a height of 1-4 metres, and a frequency range of 1-20GHz.

The BlackBerry® smartphone was in standalone, horizontal position.

The following measurements were performed in PCS Tx mode on channels 25, 600 and 1175.

All emissions had a test margin greater than 25.0 dB.

Test Report No.
RTS-2604-1106-131ADates of Test
May 25, June 2 to June 28, 2011FCC ID: L6ARDR60CW, L6ARDS40CW
IC: 2503A-RDR60CW, 2503A-RDS40CW

Radiated Power Test Data Results

The following test configurations were measured for model RDS41CW:

Cellular Loopback Service Mode

Date of Test: June 24, 2011

The following measurements were performed by Quan (Jerry) Ma

The environmental test conditions were: Temperature: 24.3 °C
Relative Humidity: 42.6 %

Test Distance was 3.0 metres with a height of 1-4 metres, and a frequency range of 30 MHz to 1000 MHz.

The BlackBerry® smartphone was in standalone, horizontal down position.

The following measurements were performed in CDMA Cellular Loopback Tx mode on channel 384.

All emissions had a test margin greater than 25.0 dB.

Date of Test: June 24, 2011

The following measurements were performed by Shuo Wang

The environmental test conditions were: Temperature: 25.0°C
Relative Humidity: 42.6 %

Test Distance was 3.0 metres with a height of 1-4 metres, and a frequency range of 1GHz-9 GHz.

The BlackBerry® smartphone was in standalone, horizontal down position.

The following measurements were performed in CDMA Cellular Loopback Tx mode on channel 384.

All emissions had a test margin greater than 25.0 dB.



Test Report No.
RTS-2604-1106-131A

Dates of Test
May 25, June 2 to June 28, 2011

FCC ID: L6ARDR60CW, L6ARDS40CW
IC: 2503A-RDR60CW, 2503A-RDS40CW

Radiated Emissions Test Data Results cont'd

Cellular 1xEVDO Mode

Date of Test: June 24, 2011

The environmental test conditions were: Temperature: 24.3 °C
Relative Humidity: 42.6 %

Test Distance was 3.0 metres with a height of 1-4 metres, and a frequency range of 30 MHz to 1000 MHz.

The BlackBerry® smartphone was in standalone, horizontal down position.

The following measurements were performed in CDMA Cellular EVDO Tx mode on channel 384.

All emissions had a test margin greater than 25.0 dB.

Date of Test: June 24, 2011

The environmental test conditions were: Temperature: 25.0°C
Relative Humidity: 42.6 %

Test Distance was 3.0 metres with a height of 1-4 metres, and a frequency range of 1GHz-9 GHz.

The BlackBerry® smartphone was in standalone, horizontal down position.

The following measurements were performed in CDMA Cellular EVDO Tx mode on channel 384.

All emissions had a test margin greater than 25.0 dB.

APPENDIX 4C – CDMA BC10 RADIATED EMISSIONS TEST DATA

Test Report No.
RTS-2604-1106-131A

Dates of Test
May 25, June 2 to June 28, 2011

FCC ID: L6ARDR60CW, L6ARDS40CW
IC: 2503A-RDR60CW, 2503A-RDS40CW

Radiated Power Test Data Results

Date of Test: June 24, 2011

The following measurements were performed by Quan (Jerry) Ma

The environmental tests conditions were: Temperature: 24.3 °C
Relative Humidity: 42.6%

The BlackBerry® smartphone - was in standalone, Horizontal position.
Test distance is 3.0 metres

CDMA BC10 Service Mode

EUT				Rx Antenna		Spectrum Analyzer		Substitution Method				Limit (dBm)	Diff. To Limit (dB)
Type	Ch	Frequency (MHz)	Band	Type	Pol.	Reading (dBuV)	Max (V,H) (dBuV)	Pol. Tx-Rx	Reading (dBm)	Tracking Generator Corrected Reading (relative to Dipole)			
											(dBm)	(W)	
F0	476	817.90	Cell	Dipole	V	72.06	83.13	V-V	10.6	27.60	0.58	38.50	-10.90
F0	476	817.90	Cell	Dipole	H	83.13		H-H	7.30				
F0	580	820.50	Cell	Dipole	V	72.52	83.36	V-V	10.60	27.69	0.59	38.50	-10.81
F0	580	820.50	Cell	Dipole	H	83.36		H-H	7.60				
F0	684	823.10	Cell	Dipole	V	72.9	83.24	V-V	10.50	27.63	0.58	38.50	-10.87
F0	684	823.10	Cell	Dipole	H	83.24		H-H	7.60				

CDMA BC10 EVDO Mode

EUT				Rx Antenna		Spectrum Analyzer		Substitution Method				Limit (dBm)	Diff. To Limit (dB)
Type	Ch	Frequency (MHz)	Band	Type	Pol.	Reading (dBuV)	Max (V,H) (dBuV)	Pol. Tx-Rx	Reading (dBm)	Tracking Generator Corrected Reading (relative to Dipole)			
											(dBm)	(W)	
F0	476	817.90	Cell	Dipole	V	71.69	82.77	V-V	9.27	26.27	0.42	38.50	-12.23
F0	476	817.90	Cell	Dipole	H	82.77		H-H	7.65				
F0	580	820.50	Cell	Dipole	V	72.59	83.23	V-V	9.78	26.87	0.49	38.50	-11.63
F0	580	820.50	Cell	Dipole	H	83.23		H-H	8.09				
F0	684	823.10	Cell	Dipole	V	71.94	83.25	V-V	9.89	27.02	0.50	38.50	-11.48
F0	684	823.10	Cell	Dipole	H	83.25		H-H	8.49				

	EMI Test Report for the BlackBerry® smartphone Model RDR61CW,RDS41CW Appendix 4C	
Test Report No. RTS-2604-1106-131A	Dates of Test May 25, June 2 to June 28, 2011	FCC ID: L6ARDR60CW, L6ARDS40CW IC: 2503A-RDR60CW, 2503A-RDS40CW

Radiated Emissions Test Data Results cont'd

CDMA BC10 Service Mode

Date of Test: June 24, 2011

The following measurements were performed by Quan (Jerry) Ma

The environmental test conditions were: Temperature: 24.3 °C
Relative Humidity: 42.6 %

Test Distance was 3.0 metres with a height of 1-4 metres, and a frequency range of 30 MHz to 1000 MHz.

The BlackBerry® smartphone was in standalone, horizontal down position.

The following measurements were performed in CDMA BC10 Tx mode on channels 476, 580 and 684.

All emissions had a test margin greater than 25.0 dB.

Date of Test: June 24, 2011

The following measurements were performed by Shuo Wang.

The environmental test conditions were: Temperature: 25.0°C
Relative Humidity: 42.6%

Test Distance was 3.0 metres with a height of 1-4 metres, and a frequency range of 1GHz-9 GHz.

The BlackBerry® smartphone was in standalone, horizontal down position.

The following measurements were performed in CDMA BC10 Tx mode on channels 476, 580 and 684.

All emissions had a test margin greater than 25.0 dB.

	EMI Test Report for the BlackBerry® smartphone Model RDR61CW,RDS41CW Appendix 4C	
Test Report No. RTS-2604-1106-131A	Dates of Test May 25, June 2 to June 28, 2011	FCC ID: L6ARDR60CW, L6ARDS40CW IC: 2503A-RDR60CW, 2503A-RDS40CW

Radiated Emissions Test Data Results cont'd

CDMA BC10 1xEVDO Mode

Date of Test: June 24, 2011

The following measurements were performed by Quan (Jerry) Ma

The environmental test conditions were: Temperature: 24.3 °C
Relative Humidity: 42.6 %

Test Distance was 3.0 metres with a height of 1-4 metres, and a frequency range of 30 MHz to 1000 MHz.

The BlackBerry® smartphone was in standalone, horizontal down position.

The following measurements were performed in CDMA EVDO Tx mode on channels 476, 580 and 684.

All emissions had a test margin greater than 25.0 dB.

Date of Test: June 24, 2011

The following measurements were performed by Shuo Wang.

The environmental test conditions were: Temperature: 25.0°C
Relative Humidity: 42.6 %

Test Distance was 3.0 metres with a height of 1-4 metres, and a frequency range of 1GHz-9 GHz.

The BlackBerry® smartphone was in standalone, horizontal down position.

The following measurements were performed in CDMA EVDO Tx mode on channels 476, 580 and 684.

All emissions had a test margin greater than 25.0 dB.