	Document		Page
	<b>Hearing Aid Compatibility RF Emissions Test Report for the BlackBerry® Smartphone model RDH71CW/RDP71UW</b>		1(21)
Author Data	Dates of Test	Report No	FCC ID
<b>Daoud Attayi</b>	<b>Jan. 12-19, Feb. 28-Mar. 01, June 09, 2011</b>	<b>RTS-2605-1102-02A</b>	<b>L6ARDH70CW L6ARDP70UW</b>

# Hearing Aid Compatibility RF Emissions Test Report

<b>Testing Lab:</b>	RIM Testing Services 440 Phillip Street Waterloo, Ontario Canada N2L 5R9 Phone: 519-888-7465 Fax: 519-746-0189	<b>Applicant:</b>	Research In Motion Limited 295 Phillip Street Waterloo, Ontario Canada N2L 3W8 Phone: 519-888-7465 Fax: 519-888-6906 Web site: www.rim.com
---------------------	---	-------------------	--

**Statement of Compliance:** RIM Testing Services (RTS) declares that the product was tested in accordance with the appropriate measurement standards, guidelines and recommended practices.

This Blackberry® Smartphone is a wireless portable device and has been shown to be in compliance with FCC 20.19 (10-1-07 Edition), Hearing Aid-Compatible Mobile Handsets, FCC Public Notice DA 06-1215 (June 6, 2006) and FCC Report and Order, FCC 08-68 (Feb. 28, 2008).

Tested and reviewed by:	Signatures	Date
Hang Wang Compliance Specialist		09-June-2011
<b>Tested &amp; documented by:</b>		
Daoud Attayi Team Lead: Safety, SAR/HAC Compliance		08-June-2011
<b>Approved by:</b>		
Masud S. Attayi Manager, Regulatory Compliance		10-June-2011

	Document		Page
	<b>Hearing Aid Compatibility RF Emissions Test Report for the BlackBerry® Smartphone model RDH71CW/RDP71UW</b>		2(21)
Author Data	Dates of Test	Report No	FCC ID
<b>Daoud Attayi</b>	<b>Jan. 12-19, Feb. 28-Mar. 01, June 09, 2011</b>	<b>RTS-2605-1102-02A</b>	<b>L6ARDH70CW L6ARDP70UW</b>

## CONTENTS

1.0 Introduction .....	3
2.0 Applicable references .....	4
3.1 Picture of device .....	5
3.2 Device description .....	5
3.4 Antenna description .....	7
4.0 List of test equipment .....	7
5.2 Near-Field RF Emission .....	14
6.0 Summary of results .....	17
6.1 Conclusion .....	19
7.0 Measurement uncertainty .....	20
7.1 Site-Specific Uncertainty .....	21

### Annex A: Measurement plots and data

A.1 Spectrum analyser plots: CW, 80% AM and GSM signals

A.2 Dipole validation and probe modulation factor plots

Justification of step size and interpolation

A.3 RF emission field plots

### Annex B: Probe and dipole descriptions and calibration certificates

B.1 Probe and measurement chain description and specifications

B.2 Probe and dipole calibration certificates

### Annex C: Test set up photos

	Document		Page
	<b>Hearing Aid Compatibility RF Emissions Test Report for the BlackBerry® Smartphone model RDH71CW/RDP71UW</b>		3(21)
Author Data	Dates of Test	Report No	FCC ID
<b>Daoud Attayi</b>	<b>Jan. 12-19, Feb. 28-Mar. 01, June 09, 2011</b>	<b>RTS-2605-1102-02A</b>	<b>L6ARDH70CW L6ARDP70UW</b>

## 1.0 Introduction

This test report documents the measurement of the near electric and magnetic fields generated by a wireless communication device in the region where a hearing aid would be used. The measurement procedures of ANSI C63.19-2007 were followed along with the guidance provided by the FCC.

The electric and magnetic fields from a wireless device are scanned using a SPEAG DASY automated system with HAC extension and free-space probes (ER3DVx and H3DVx) in a 5cm x 5cm area, 15mm above the wireless device's acoustic output and the centre point of the probe element. The area is divided into 9 sub-grids and the maximum values of the electrical and a magnetic field scans are evaluated automatically according to the rules defined in the standard and the device is assigned a certain category. Should the wireless device's maximum T-Coil output occur in a location other than the centre of acoustic output, then the RF field scans are repeated with the measurement area centered on the maximum T-Coil output location.

The DASY HAC Extension consists of the following parts: the Test Arch phantom, three validation dipoles, dipole and DUT holders, magnetic and electric field probes and DASY software. The field probes and measurement electronics are described in Annex B.1.

The specially designed Test Arch allows high precision positioning of both the device and any of the validation dipoles. The broadband dipoles are calibrated at a single frequency and are used for system performance checks.

In order to correlate the usability of a hearing aid with a wireless device (WD), the WD's radio frequency (RF) and audio band emissions are measured. ANSI C63.19 requires:

- Radio frequency (RF) measurements of the near-field electric and magnetic fields emitted by a WD in the vicinity of the audio output to categorize these emissions for correlation with the RF immunity of the microphone mode of operation of a hearing aid.
- Audio frequency magnetic field measurements of a WD emitted in the vicinity of the audio output to categorize these emissions for correlation with the T-Coil mode of operation of a hearing aid.

Hence, the following measurements are made for the WDs:

1. RF E-Field emissions.
2. RF H-Field emissions.
3. T-Coil mode, magnetic signal strength in the audio band.
4. T-Coil mode, magnetic signal and noise articulation index.
5. T-Coil mode, magnetic signal frequency response through the audio band.
6. RF T-Coil environment: The worst case M rating from E or H field 5x5 cm scan centered at the axial T-coil highest peak location.

	Document		Page
	<b>Hearing Aid Compatibility RF Emissions Test Report for the BlackBerry® Smartphone model RDH71CW/RDP71UW</b>		4(21)
Author Data	Dates of Test	Report No	FCC ID
<b>Daoud Attayi</b>	<b>Jan. 12-19, Feb. 28-Mar. 01, June 09, 2011</b>	<b>RTS-2605-1102-02A</b>	<b>L6ARDH70CW L6ARDP70UW</b>

## 2.0 Applicable references

[1] ANSI C63.19-2007, American National Standard for Methods of Measurement of Compatibility between Wireless Communication Devices and Hearing Aids

[2] FCC 47CFR § 20.19 (10-1-07 Edition), Hearing Aid-Compatible Mobile Handsets

[3] FCC Public Notice DA 06-1215, June 2006

[4] SPEAG DASY V4.7 user manual, June 2006

[5] FCC Equipment Authorization Guidance on Hearing Aid Compatibility, Sep/Oct 2008

[6] FCC Report and Order, FCC 08-68, Feb 2008

	Document		Page
	<b>Hearing Aid Compatibility RF Emissions Test Report for the BlackBerry® Smartphone model RDH71CW/RDP71UW</b>		5(21)
Author Data <b>Daoud Attayi</b>	Dates of Test <b>Jan. 12-19, Feb. 28-Mar. 01, June 09, 2011</b>	Report No <b>RTS-2605-1102-02A</b>	FCC ID <b>L6ARDH70CW L6ARDP70UW</b>

### 3.0 Equipment unit tested

#### 3.1 Picture of device

Please refer to Annex C.

**Figure 3.1 BlackBerry® smartphone**

#### 3.2 Device description

<b>Device Model</b>	RDH71CW				
<b>FCC ID</b>	L6ARDH70CW				
<b>PIN</b>	329A77DF, 329CDE2B, 32EE924B				
<b>Hardware Rev</b>	Rev 1, Rev 3				
<b>Software Version</b>	6.1.0.70, 6.1.0.106, 7.0.0.984				
<b>Prototype or Production Unit</b>	Production				
<b>Mode(s) of Operation in North America</b>	GSM 850	GSM 1900	CDMA2000/ 1xEvDO 800	CDMA2000/ 1xEvDO 1900	* Bluetooth
<b>Nominal Maximum conducted RF Output Power (dBm)</b>	32.5	29.0	24.0	23.5	7.00
<b>Tolerance in Power Setting on centre channel (dB)</b>	± 0.5	± 0.5	± 0.5	± 0.5	N/A
<b>Duty Cycle</b>	1:8	1:8	1:1	1:1	N/A
<b>Transmitting Frequency Range (MHz)</b>	824.2 – 848.8	1850.2 – 1909.8	824.70 – 848.52	1851.25 – 1908.50	2402-2483
<b>Mode(s) of Operation</b>	** 802.11b	** 802.11g	** 802.11n		
<b>Nominal Maximum conducted RF Output Power (dBm)</b>	18.0	15.5	15.5		
<b>Tolerance in Power Setting on centre channel (dB)</b>	± 0.5	± 0.5	± 0.5		
<b>Duty Cycle</b>	1:1	1:1	1:1		
<b>Transmitting Frequency Range (MHz)</b>	2412-2462	2412-2462	2412-2462		

**Table 3.1 Test device characterization**

\* BT is not activated during test because it is not held-to-ear service.

\*\* Wi-Fi is not activated during test because ANSI C63.19-2007 standard does not cover this technology.

	Document			Page
	<b>Hearing Aid Compatibility RF Emissions Test Report for the BlackBerry® Smartphone model RDH71CW/RDP71UW</b>			6(21)
Author Data <b>Daoud Attayi</b>	Dates of Test <b>Jan. 12-19, Feb. 28-Mar. 01, June 09, 2011</b>	Report No <b>RTS-2605-1102-02A</b>	FCC ID <b>L6ARDH70CW L6ARDP70UW</b>	

<b>Device Model</b>	RDP71UW			
<b>FCC ID</b>	L6ARDP70UW			
<b>IC ID</b>	2503A-RDP70UW			
<b>PIN</b>	25FB01DF (Radiated), 25FB01DF (Conducted)			
<b>Hardware Version</b>	Rev 1			
<b>Software Version</b>	6.1.0.132			
<b>Prototype or Production Unit</b>	Production			
<b>Mode(s) of Operation in North America</b>	GSM 850	GSM 1900	WCDMA / UMTS FDD V (850)	WCDMA / UMTS FDD II (1900)
<b>Maximum nominal conducted RF Output Power (dBm)</b>	32.5	29.0	24.0	23.5
<b>Tolerance in Power Setting on centre channel (dB)</b>	± 0.5	± 0.5	± 0.50	± 0.50
<b>Duty Cycle</b>	1:8	1:8	1:1	1:1
<b>Tx Frequency Range (MHz)</b>	824.2 – 848.8	1850.2 – 1909.8	824.6 – 846.6	1852.4 – 1907.6
<b>Mode(s) of Operation in North America</b>	802.11b	802.11g	802.11n	* Bluetooth
<b>Maximum nominal conducted RF Output Power (dBm)</b>	18.0	15.5	15.5	7.00
<b>Tolerance in Power Setting on centre channel (dB)</b>	± 0.50	± 0.50	± 0.50	N/A
<b>Duty Cycle</b>	1:1	1:1	1:1	N/A
<b>Tx Frequency Range (MHz)</b>	2412-2462	2412-2462	2412-2462	2402-2483

**Table 3.2 Test device characterization**

\* BT is not activated during test because it is not held-to-ear service.

\*\* Wi-Fi is not activated during test because ANSI C63.19-2007 standard does not cover this technology.

**Note :** According to manufacturer's hardware similarity declaration document, the two models have identical design. Please refer to the declaration for more detail. The difference is model: RDP71UW does not support CDMA2000 bands, but supports UMTS band V and II.

	Document		Page
	<b>Hearing Aid Compatibility RF Emissions Test Report for the BlackBerry® Smartphone model RDH71CW/RDP71UW</b>		7(21)
Author Data <b>Daoud Attayi</b>	Dates of Test <b>Jan. 12-19, Feb. 28-Mar. 01, June 09, 2011</b>	Report No <b>RTS-2605-1102-02A</b>	FCC ID <b>L6ARDH70CW L6ARDP70UW</b>

### 3.3 Battery

- 1) BAT-30615-006

### 3.4 Antenna description

<b>Type</b>	Internal fixed antenna
<b>Location</b>	Bottom back centre (main licensed transmitter)
<b>Configuration</b>	Internal fixed antenna

**Table 3.3 Antenna description**

## 4.0 List of test equipment

Manufacturer	Test Equipment	Model Number	Serial Number	Calibration Due Date (MM/DD/YY)
SCHMID & Partner Engineering AG	Data Acquisition Electronics (DAE3)	DAE3 V1	472	05/17/2011
SCHMID & Partner Engineering AG	Data Acquisition Electronics (DAE4)	DAE4	881	09/19/2011
SCHMID & Partner Engineering AG	3-Dimensional E-Field Probe for Near-Field	ER3DV6	2285	03/08/2011
SCHMID & Partner Engineering AG	3-Dimensional E-Field Probe for Near-Field	ER3DV6	2286	01/14/2012
SCHMID & Partner Engineering AG	3-Dimensional H-Field Probe for Near-Field	H3DV6	6168	03/12/2011
SCHMID & Partner Engineering AG	3-Dimensional H-Field Probe for Near-Field	H3DV6	6105	11/18/2011
Rohde & Schwarz	Base Station Simulator	CMU200	109747	12/07/2011
Rohde & Schwarz	Spectrum Analyzer	ESP 30	100884	07/14/2011
Agilent Technologies	Signal generator	8648C	4037U03155	09/24/2011
Agilent Technologies	Power meter	E4419B	GB40202821	09/15/2011
Agilent Technologies	Power sensor	8481A	MY41095417	09/23/2011
Amplifier Research	Amplifier	5S1G4M3	300986	CNR

	Document <b>Hearing Aid Compatibility RF Emissions Test Report for the BlackBerry® Smartphone model RDH71CW/RDP71UW</b>		Page 8(21)
	Author Data <b>Daoud Attayi</b>	Dates of Test <b>Jan. 12-19, Feb. 28-Mar. 01, June 09, 2011</b>	Report No <b>RTS-2605-1102-02A</b>

SCHMID & Partner Engineering AG	Validation Dipole	CD835V3	1011	11/18/2011
SCHMID & Partner Engineering AG	Validation Dipole	CD1880V3	1008	11/18/2011

**Table 4.1 List of test equipment**



	Document <b>Hearing Aid Compatibility RF Emissions Test Report for the BlackBerry® Smartphone model RDH71CW/RDP71UW</b>		Page 9(21)
	Author Data <b>Daoud Attayi</b>	Dates of Test <b>Jan. 12-19, Feb. 28-Mar. 01, June 09, 2011</b>	Report No <b>RTS-2605-1102-02A</b>

## 5.0 Measurement procedures

### 5.1 System Validation

The test setup should be validated when first configured and verified periodically thereafter to ensure proper function. The procedure consists of two parts: dipole validation and determination of probe modulation factor.

#### 5.1.1 Dipole Validation

The HAC validation dipole antenna serves as a known source for an electrical and magnetic RF output.

1. The dipole antenna was placed in the position normally occupied by the WD.
2. The dipole was energized with a 20 dBm un-modulated continuous-wave signal.
3. The center point of the probe element(s) are 10 mm from the closest surface of the dipole elements.
4. The length of the dipole was scanned with both E-field and H-field probes and the maximum value for each scan was recorded.
5. The readings were compared with the values provided by the probe manufacturer and were found to agree within tolerance of +/- 10%. Please refer to Annex A.2 for Dipole Validation Plots.

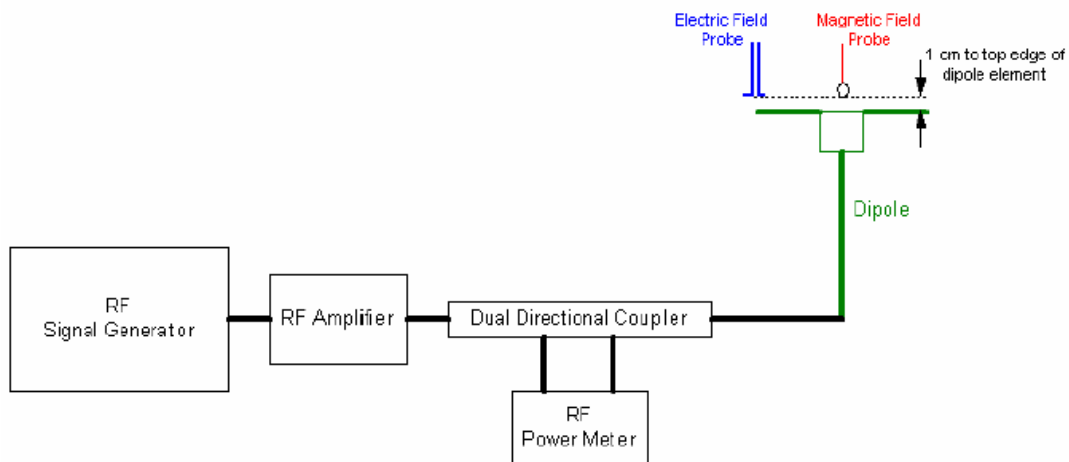

**Figure 5.1: Dipole validation procedure**

	Document <b>Hearing Aid Compatibility RF Emissions Test Report for the BlackBerry® Smartphone model RDH71CW/RDP71UW</b>		Page 10(21)
	Author Data <b>Daoud Attayi</b>	Dates of Test <b>Jan. 12-19, Feb. 28-Mar. 01, June 09, 2011</b>	Report No <b>RTS-2605-1102-02A</b>

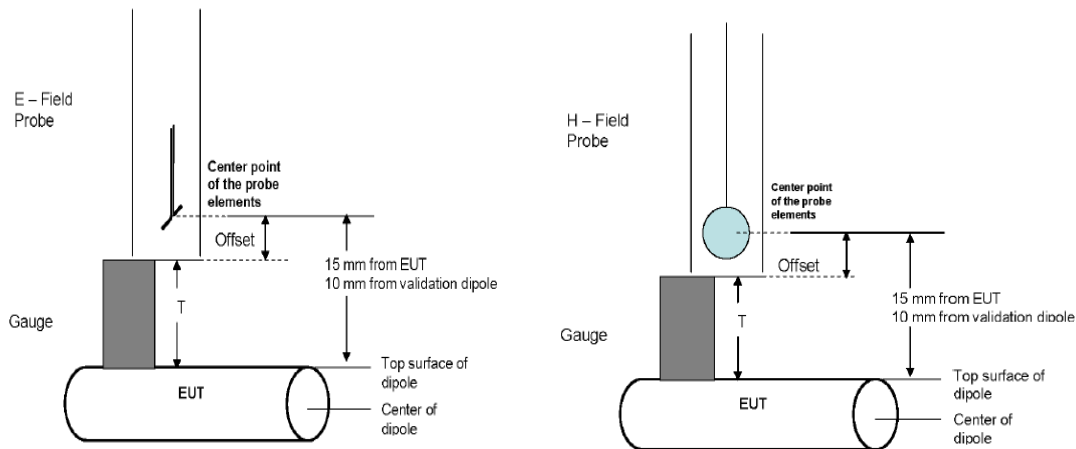

**Figure 5.2: Gauge Block with E-Field & H-Field probes**

### 5.1.2 RF Field Probe Modulation Factor

The Probe Modulation Factor (PMF) characterizes the responses of the E-field and H-field probes and their instrumentation chain to a modulated signal. The PMF is the ratio of the responses to fields produced by CW and modulated signals having equal peak amplitude.

Three test cases are recommended. The real or emulated WD (Wireless device) modulated signal, an unmodulated (CW) and an 80% AM RF signal shall be used for each relevant frequency band. Each of the test cases below shall be measured with both E\_ and H\_Field probe.

#### a) Measurement of real and emulated signal

- Set a WD or emulated signal source to apply full power into the reference dipole.
- Measure both the peak and average input power applied to the antenna and record the values using the following test instructions for measuring the RF interference of a modulated signal.

Spectrum analyzer set up:

RBW  $\geq$  emission bandwidth

Video Bandwidth  $\geq$  20 KHz

Span: Zero

Center Frequency: Nominal center of frequency channel

Amplitude: Linear (logarithmic scale may be used)

Detection: Peak detection

Trigger: Video or IF trigger

	Document		Page
	<b>Hearing Aid Compatibility RF Emissions Test Report for the BlackBerry® Smartphone model RDH71CW/RDP71UW</b>		11(21)
Author Data	Dates of Test	Report No	FCC ID
<b>Daoud Attayi</b>	<b>Jan. 12-19, Feb. 28-Mar. 01, June 09, 2011</b>	<b>RTS-2605-1102-02A</b>	<b>L6ARDH70CW L6ARDP70UW</b>

Sweep rate: sufficiently rapid to permit the complete pulse to be resolved accurately.

- Using near-field measurement system, scan the antenna over the appropriately sized area and record the greatest average power reading observed.

**b) Measurement of CW and AM**

- Set the RF signal generator for CW or 80 % AM and set the output power so the peak power applied to the antenna is equal to that recorded for the real or emulated signal using the WD modulation format.
- Measure both the peak and average input power applied to the antenna and record these values. Calculate the peak to average power ratio (PAR). The PAR for the CW signal should be 0.0 dB and 3.9 dB for the AM signal with 80% modulation depth from each other and the peak should be that amount above the target values.

The PMF was calculated for the following signals: 80% AM and the modulated signal produced by the WD. The PMF measurement was performed with the field probe and instrumentation that will be used together during RF emissions measurements. Once calculated, the PMF was entered into the DASY software and applied to the measured modulated fields of the specified type.

ANSI C63.19 outlines the following alternate procedure as one method for determining probe modulation factor:

1. Fix the field probe in a set location relative to a field generating device, such as the reference dipole antenna.
2. Illuminate the probe using the wireless device connected to the reference dipole with a test signal at the intended measurement frequency, Ensure there is sufficient field coupling between the probe and the antenna so the resulting reading is greater than 10 dB above the probe system noise floor but within the systems operating range.
3. Record the amplitude applied to the antenna during transmission and the field strength measured by the E-field probe located near the tip of the dipole antenna.
4. Replace the wireless device with an RF signal generator producing an unmodulated CW signal and set to the wireless device operating frequency.
5. Set the amplitude of the unmodulated signal to equal that recorded from the wireless device.
6. Record the reading of the probe measurement system of the unmodulated signal.
7. The ratio, in linear units, of the probe reading in step 6 to the reading in step 3 is the E-field modulation factor.
8. Repeat the above using the H-field probe, except locate the probe at the center of the dipole.

Please refer to Annex A.1 for 0 Hz-span spectrum analyzer plots. The signal generator was used to generate the CW and AM signals. The WD was used to generate the modulated signal.

Please refer to Annex A.2 for probe modulation factor measurement plots.

	Document		Page
	<b>Hearing Aid Compatibility RF Emissions Test Report for the BlackBerry® Smartphone model RDH71CW/RDP71UW</b>		12(21)
Author Data <b>Daoud Attayi</b>	Dates of Test <b>Jan. 12-19, Feb. 28-Mar. 01, June 09, 2011</b>	Report No <b>RTS-2605-1102-02A</b>	FCC ID <b>L6ARDH70CW L6ARDP70UW</b>

f (MHz)	Signal Type	Peak Power (dBm)	Measured E-Field (V/m)	Target E-Field (V/m)	Delta (%)	PMF
835	CW (Validation)	20.00	<b>169.7</b>	163.0	4.1	
835	<b>GSM 850</b>	20.13	55.1			<b>2.90</b>
835	CW	20.13	159.9			
835	80 % AM	20.12	81.1			
835	<b>CDMA 800</b>	11.50	48.7			<b>1.01</b>
835	CW	11.58	49.2			
835	80% AM	11.58	31.3			
1880	CW (Validation)	20.00	<b>127.8</b>	134.2	-4.8	
1880	<b>GSM 1900</b>	17.11	30.2			<b>2.90</b>
1880	CW	17.16	87.6			
1880	80% AM	17.16	45.2			
1880	<b>CDMA 1900</b>	10.68	42.2			<b>1.00</b>
1880	CW	10.71	42.1			
1880	80% AM	10.73	22.0			
f (MHz)	Signal Type	Peak Power (dBm)	Measured H-Field (A/m)	Target H-Field (A/m)	Delta (%)	PMF
835	CW (Validation)	20.00	<b>0.467</b>	0.464	0.65	
835	<b>GSM 850</b>	20.13	0.164			<b>2.79</b>
835	CW	20.13	0.458			
835	80 % AM	20.12	0.289			
835	<b>CDMA 800</b>	11.50	0.170			<b>1.01</b>
835	CW	11.58	0.172			
835	80% AM	11.58	0.110			
1880	<b>CW</b>	20.00	<b>0.450</b>	0.471	-4.46	
1880	<b>GSM 1900</b>	17.11	0.122			<b>2.52</b>
1880	CW	17.16	0.308			
1880	80% AM	17.16	0.199			
1880	<b>CDMA 1900</b>	10.68	0.103			<b>1.08</b>
1880	CW	10.71	0.111			
1880	80% AM	10.73	0.008			

**Table 5.1: Dipole Validation and Modulation Factors**

**Probe Modulation Factor** = Measured E or H-Field (CW)/Measured E or H-Field (Modulated)

	Document		Page
	<b>Hearing Aid Compatibility RF Emissions Test Report for the BlackBerry® Smartphone model RDH71CW/RDP71UW</b>		13(21)
Author Data <b>Daoud Attayi</b>	Dates of Test <b>Jan. 12-19, Feb. 28-Mar. 01, June 09, 2011</b>	Report No <b>RTS-2605-1102-02A</b>	FCC ID <b>L6ARDH70CW L6ARDP70UW</b>

f (MHz)	Signal Type	Peak Power (dBm)	Measured E-Field (V/m)	Target E-Field (V/m)	Delta (%)	PMF
835	CW (Validation)	20.00	<b>164.8</b>	163.0	1.1	
835	<b>UMTS band V</b>	10.91	56.9			<b>1.01</b>
835	CW	10.91	57.6			
835	80% AM	10.94	37.1			
1880	CW (Validation)	20.00	<b>132.7</b>	134.2	-1.11	
1880	<b>UMTS band II</b>	10.57	38.48			<b>1.12</b>
1880	CW	10.57	43.00			
1880	80% AM	10.58	27.50			
f (MHz)	Signal Type	Peak Power (dBm)	Measured H-Field (A/m)	Target H-Field (A/m)	Delta (%)	PMF
835	CW (Validation)	20.00	<b>0.478</b>	0.464	3.02	
835	<b>UMTS band V</b>	10.91	0.168			<b>0.99</b>
835	CW	10.91	0.166			
835	80% AM	10.94	0.106			
1880	CW (Validation)	20.00	<b>0.455</b>	0.471	-3.4	
1880	<b>UMTS band II</b>	10.57	0.138			<b>1.12</b>
1880	CW	10.57	0.155			
1880	80% AM	10.58	0.099			

**Table 5.2: Dipole Validation and Modulation Factors**

**Probe Modulation Factor = Measured E or H-Field (CW)/Measured E or H-Field (Modulated)**

	Document		Page
	<b>Hearing Aid Compatibility RF Emissions Test Report for the BlackBerry® Smartphone model RDH71CW/RDP71UW</b>		14(21)
Author Data	Dates of Test	Report No	FCC ID
<b>Daoud Attayi</b>	<b>Jan. 12-19, Feb. 28-Mar. 01, June 09, 2011</b>	<b>RTS-2605-1102-02A</b>	<b>L6ARDH70CW L6ARDP70UW</b>

## 5.2 Near-Field RF Emission

The following procedure was used to measure RF near E-field and H-field emissions:

1. Proper operation of the field probe, probe measurement system, other instrumentation, and the positioning system was confirmed.
2. The WD was oriented in its intended test position with the reference plane in the horizontal plane and was secured in the device holder to maintain position accuracy.
3. A CMU 200 Base Station Simulator was used to place a normal voice call to the WD on the desired channel and to transmit at maximum power.
4. The DASY system measures power drift as part of each scan. If the power during a scan drifted by more than 0.20 dB, the scan was repeated. Power drift measurements for the worst-case scans are included in Annex A.3. A fully charged battery was used for each test.
5. The 5cm x 5cm measurement grid was centered on the center of the acoustic output or the T-Coil output, as appropriate. The field probe was located at the initial position at the center of the measurement grid.
6. A surface verification was performed before each setup change to ensure repeatable spacing and proper maintenance of the measurement plane.
7. The electric field probe, and separately the magnetic field probe, was used to measure the highest field strength in the 5cm x 5cm reference plane. The center point of the probe measurement element(s) shall be held 15 mm from the WD reference plane.
8. The entire 5cm x 5cm region was scanned with a 5mm step size. The reading was recorded at each measurement location. Justification of the step size and interpolation used is provided at the end of Annex A.2.
9. Around the center sub-grid, five contiguous sub-grids were identified with the lowest maximum field strength readings. Please note that a maximum of five sub-grids can be excluded for both E- and H-field measurements.
10. The highest field reading was identified within the non-excluded sub-grids
11. The highest field reading was converted from average to peak V/m or A/m, as appropriate. This conversion was done by the DASY SEMCAD processor after entering correct PMF.
12. Once the worst-case configuration was determined, the WD was tested with second source battery.
13. The highest peak reading was compared to the categories defined in C63.19 using the appropriate AWF.

- If a WD has more than one antenna position, it is necessary to test the WD only in the condition of maximum antenna efficiency, i.e. antenna extended.
- The WD's backlight shuts off automatically a short time after a call is established.

	Document			Page
	<b>Hearing Aid Compatibility RF Emissions Test Report for the BlackBerry® Smartphone model RDH71CW/RDP71UW</b>			15(21)
Author Data <b>Daoud Attayi</b>	Dates of Test <b>Jan. 12-19, Feb. 28-Mar. 01, June 09, 2011</b>	Report No <b>RTS-2605-1102-02A</b>	FCC ID <b>L6ARDH70CW L6ARDP70UW</b>	

Category	Telephone RF Parameters < 960 MHz				
	Near Field	AWF	E-Field Emissions		H-Field Emissions
Category M1/T1	0	631.0 to 1122.0	V/m	1.91 to 3.39	A/m
	-5	473.2 to 841.4	V/m	1.43 to 2.54	A/m
Category M2/T2	0	354.8 to 631.0	V/m	1.07 to 1.91	A/m
	-5	266.1 to 473.2	V/m	0.80 to 1.43	A/m
Category M3/T3	0	199.5 to 354.8	V/m	0.60 to 1.07	A/m
	-5	149.6 to 266.1	V/m	0.45 to 0.80	A/m
Category M4/T4	0	< 199.5	V/m	< 0.60	A/m
	-5	< 149.6	V/m	< 0.45	A/m

Category	Telephone RF Parameters > 960 MHz				
	Near Field	AWF	E-Field Emissions		H-Field Emissions
Category M1/T1	0	199.5 to 354.8	V/m	0.60 to 1.07	A/m
	-5	149.6 to 266.1	V/m	0.45 to 0.80	A/m
Category M2/T2	0	112.2 to 199.5	V/m	0.34 to 0.60	A/m
	-5	84.1 to 149.6	V/m	0.25 to 0.45	A/m
Category M3/T3	0	63.1 to 112.2	V/m	0.19 to 0.34	A/m
	-5	47.3 to 84.1	V/m	0.14 to 0.25	A/m
Category M4/T4	0	<63.1	V/m	<0.19	A/m
	-5	<47.3	V/m	<0.14	A/m

Table 5.3: Wireless Device near-field categories

Standard	Technology	AWF (dB)
TIA/EIA/IS-2000	CDMA	0
TIA/EIA-136	TDMA (50 Hz)	0
J-STD-007	GSM (217)	-5
T1/T1P1/3GPP	UMTS (WCDMA)	0
iDEN™	TDMA (22 and 11 Hz)	0

Table 5.4: Articulation Weighting Factor (AWF)

	Document <b>Hearing Aid Compatibility RF Emissions Test Report for the BlackBerry® Smartphone model RDH71CW/RDP71UW</b>		Page 16(21)
	Author Data <b>Daoud Attayi</b>	Dates of Test <b>Jan. 12-19, Feb. 28-Mar. 01, June 09, 2011</b>	Report No <b>RTS-2605-1102-02A</b>

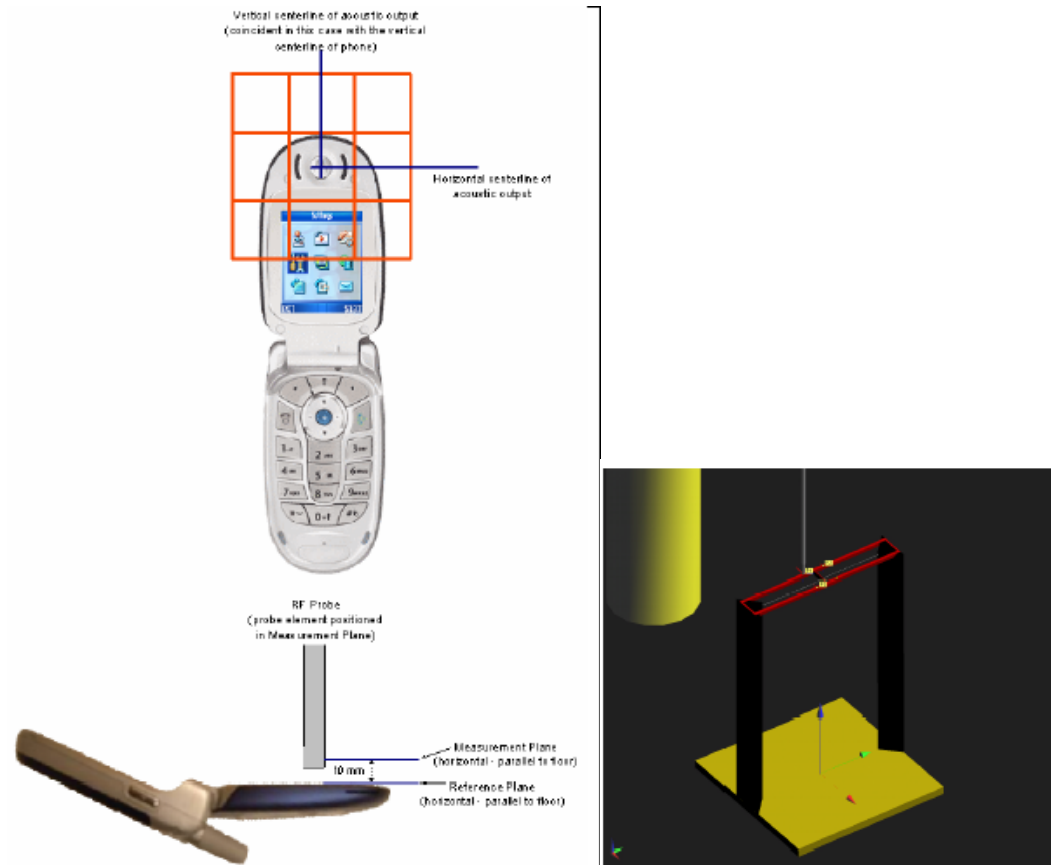

**Figure 5.3: WD reference plane for RF emission measurements    Figure 5.4: HAC Phantom/Test Arch**



	Document		Page
	<b>Hearing Aid Compatibility RF Emissions Test Report for the BlackBerry® Smartphone model RDH71CW/RDP71UW</b>		17(21)
Author Data <b>Daoud Attayi</b>	Dates of Test <b>Jan. 12-19, Feb. 28-Mar. 01, June 09, 2011</b>	Report No <b>RTS-2605-1102-02A</b>	FCC ID <b>L6ARDH70CW L6ARDP70UW</b>

## 6.0 Summary of results

RF Emissions Test					
Mode	f (MHz)	Cond. Pwr. (dBm)	Peak E-Field (V/m)	Center of Speaker or Telecoil	M-Rating
GSM 850	824.2	32.7	195.4	speaker	3
	836.8	32.7	211.5	speaker	3
	848.8	32.6	223.9	speaker	3
	848.8	32.6	222.4	telecoil	3
GSM 1900	1850.2	28.8	53.8	speaker	3
	1880.0	28.7	53.3	speaker	3
	1909.8	28.7	52.5	speaker	3
	1850.2	28.8	47.8	telecoil	3
Mode	f (MHz)	Cond. Pwr. (dBm)	Peak E-Field (V/m)	Center of Speaker or Telecoil	M-Rating
CDMA 800	824.70	24.3	27.3	Speaker	4
	836.52	24.2	27.3	Speaker	4
	848.52	24.2	26.4	Speaker	4
	836.52	24.2	27.1	Telecoil	4
CDMA 1900	1851.25	23.7	26.1	Speaker	4
	1880.00	23.9	25.0	Speaker	4
	1908.50	23.7	24.8	Speaker	4
	1851.25	23.7	21.2	Telecoil	4
<b>Overall M-Rating:</b>					<b>3</b>

**Table 6.1 – E-Field Data Summary**

RF Emissions Test					
Mode	f (MHz)	Cond. Pwr. (dBm)	Peak E-Field (V/m)	Center of Speaker or Telecoil	M-Rating
WCDMA band V 850	826.4	24.3	52.58	Speaker	4
	836.4	24.3	52.82	Speaker	4
	846.6	24.1	61.74	Speaker	4
	846.6	24.1	60.39	Telecoil	4
WCDMA band II 1900	1852.4	23.3	30.01	Speaker	4
	1880.0	23.6	33.10	Speaker	4
	1907.6	23.2	35.33	Speaker	4
	1880.0	23.6	40.24	Telecoil	4
<b>Overall M-Rating:</b>					<b>4</b>

**Table 6.2 – E-Field Data Summary**

	Document		Page
	<b>Hearing Aid Compatibility RF Emissions Test Report for the BlackBerry® Smartphone model RDH71CW/RDP71UW</b>		18(21)
Author Data <b>Daoud Attayi</b>	Dates of Test <b>Jan. 12-19, Feb. 28-Mar. 01, June 09, 2011</b>	Report No <b>RTS-2605-1102-02A</b>	FCC ID <b>L6ARDH70CW L6ARDP70UW</b>

RF Emissions Test					
Mode	f (MHz)	Cond. Pwr. (dBm)	Peak H- Field (A/m)	Center of Speaker or Telecoil	M-Rating
GSM 850	824.2	32.7	0.372	Speaker	4
	836.8	32.7	0.417	Speaker	4
	848.8	32.6	0.533	Speaker	3
	848.8	32.6	0.562	Telecoil	3
GSM 1900	1850.2	28.8	0.152	Speaker	3
	1880.0	28.7	0.155	Speaker	3
	1909.8	28.7	0.159	Speaker	3
	1909.8	28.8	0.153	Telecoil	3
Mode	f (MHz)	Cond. Pwr. (dBm)	Peak H- Field (A/m)	Center of Speaker or Telecoil	M-Rating
CDMA 800	824.70	24.3	0.057	Speaker	4
	836.52	24.2	0.051	Speaker	4
	848.52	24.2	0.053	Speaker	4
	824.70	24.3	0.053	Telecoil	4
CDMA 1900	1851.25	23.7	0.031	Speaker	4
	1880.00	23.9	0.032	Speaker	4
	1908.50	23.7	0.034	Speaker	4
	1908.50	23.7	0.032	Telecoil	4
<b>Overall M-Rating:</b>					<b>3</b>

**Table 6.3 – H-Field Data Summary**

RF Emissions Test					
Mode	f (MHz)	Cond. Pwr. (dBm)	Peak H- Field (A/m)	Center of Speaker or Telecoil	M-Rating
WCDMA band V 850	826.4	24.3	0.106	Speaker	4
	836.4	24.3	0.109	Speaker	4
	846.6	24.1	0.120	Speaker	4
	846.6	24.1	0.113	Telecoil	4
WCDMA band II 1900	1852.4	23.3	0.096	Speaker	4
	1880.0	23.6	0.105	Speaker	4
	1907.6	23.2	0.112	Speaker	4
	1880.0	23.6	0.122	Telecoil	4
<b>Overall M-Rating:</b>					

**Table 6.4 – H-Field Data Summary**

	Document		Page
	<b>Hearing Aid Compatibility RF Emissions Test Report for the BlackBerry® Smartphone model RDH71CW/RDP71UW</b>		19(21)
Author Data	Dates of Test	Report No	FCC ID
<b>Daoud Attayi</b>	<b>Jan. 12-19, Feb. 28-Mar. 01, June 09, 2011</b>	<b>RTS-2605-1102-02A</b>	<b>L6ARDH70CW L6ARDP70UW</b>

## 6.1 Conclusion

The BlackBerry® Smartphone Model: RDH71CW/RDP71UW categorized to be **M3T3** based on HAC RF Emission and Audio Band Magnetic T-Coil performance in accordance with ANSI C63.19-2007: American National Standard for Methods of Measurement of Compatibility between Wireless Communication Devices and Hearing Aids.

Therefore, the device is found to be in compliance with the requirements of FCC 20.19 (10-1-07 Edition) Hearing Aid-Compatible Mobile Handsets as modified by FCC Public Notice DA 06-1215 (Released: June 6, 2006) and FCC Report and Order, FCC 08-68 (Feb 28, 2008).

	Document <b>Hearing Aid Compatibility RF Emissions Test Report for the BlackBerry® Smartphone model RDH71CW/RDP71UW</b>			Page 20(21)
	Author Data <b>Daoud Attayi</b>	Dates of Test <b>Jan. 12-19, Feb. 28-Mar. 01, June 09, 2011</b>	Report No <b>RTS-2605-1102-02A</b>	FCC ID <b>L6ARDH70CW L6ARDP70UW</b>

## 7.0 Measurement uncertainty

HAC Uncertainty Budget According to ANSI C63.19 [1]							
Error Description	Uncertainty value	Prob. Dist.	Div.	(c <sub>1</sub> ) E	(c <sub>1</sub> ) H	Std. Unc. E	Std. Unc. H
Measurement System							
Probe Calibration	±5.1 %	N	1	1	1	±5.1 %	±5.1 %
Axial Isotropy	±4.7 %	R	$\sqrt{3}$	1	1	±2.7 %	±2.7 %
Sensor Displacement	±16.5 %	R	$\sqrt{3}$	1	0.145	±9.5 %	±1.4 %
Boundary Effects	±2.4 %	R	$\sqrt{3}$	1	1	±1.4 %	±1.4 %
Linearity	±4.7 %	R	$\sqrt{3}$	1	1	±2.7 %	±2.7 %
Scaling to Peak Envelope Power	±2.0 %	R	$\sqrt{3}$	1	1	±1.2 %	±1.2 %
System Detection Limit	±1.0 %	R	$\sqrt{3}$	1	1	±0.6 %	±0.6 %
Readout Electronics	±0.3 %	N	1	1	1	±0.3 %	±0.3 %
Response Time	±0.8 %	R	$\sqrt{3}$	1	1	±0.5 %	±0.5 %
Integration Time	±2.6 %	R	$\sqrt{3}$	1	1	±1.5 %	±1.5 %
RF Ambient Conditions	±3.0 %	R	$\sqrt{3}$	1	1	±1.7 %	±1.7 %
RF Reflections	±12.0 %	R	$\sqrt{3}$	1	1	±6.9 %	±6.9 %
Probe Positioner	±1.2 %	R	$\sqrt{3}$	1	0.67	±0.7 %	±0.5 %
Probe Positioning	±4.7 %	R	$\sqrt{3}$	1	0.67	±2.7 %	±1.8 %
Extrap. and Interpolation	±1.0 %	R	$\sqrt{3}$	1	1	±0.6 %	±0.6 %
<b>Test Sample Related</b>							
Device Positioning Vertical	±4.7 %	R	$\sqrt{3}$	1	0.67	±2.7 %	±1.8 %
Device Positioning Lateral	±1.0 %	R	$\sqrt{3}$	1	1	±0.6 %	±0.6 %
Device Holder and Phantom	±2.4 %	R	$\sqrt{3}$	1	1	±1.4 %	±1.4 %
Power Drift	±5.0 %	R	$\sqrt{3}$	1	1	±2.9 %	±2.9 %
<b>Phantom and Setup Related</b>							
Phantom Thickness	±2.4 %	R	$\sqrt{3}$	1	0.67	±1.4 %	±0.9 %
Combined Std. Uncertainty						±14.7 %	±10.9 %
Expanded Std. Uncertainty on Power						±29.4 %	±21.8 %
Expanded Std. Uncertainty on Field						±14.7 %	±10.9 %

**Table 7.1. Worst-Case uncertainty budget for HAC free field assessment according to ANSI C63.19.**

[1] The budget is valid for the frequency range 800 MHz - 3 GHz and represents a worst-case analysis.

	Document		Page
	<b>Hearing Aid Compatibility RF Emissions Test Report for the BlackBerry® Smartphone model RDH71CW/RDP71UW</b>		21(21)
Author Data	Dates of Test	Report No	FCC ID
<b>Daoud Attayi</b>	<b>Jan. 12-19, Feb. 28-Mar. 01, June 09, 2011</b>	<b>RTS-2605-1102-02A</b>	<b>L6ARDH70CW L6ARDP70UW</b>

## 7.1 Site-Specific Uncertainty

### RF Reflections

Section 4.2 of ANSI C63.19 requires that any RF reflecting objects are a minimum distance of 2 wavelengths away from the WD under test. For this WD, the longest wavelength occurs when the WD is transmitting at 824.7MHz. The wavelength is:

$$\lambda = \frac{c}{f} = \frac{3 \cdot 10^8 \text{ m/s}}{824.7 \text{ MHz}} = 0.364 \text{ m}$$

Therefore, 2 wavelengths result in a distance of 0.73m. Tests are performed in an RF shielded chamber. The distance to the nearest wall is > 1m and the distance to the robot's safety guardrail is ~1.0m, both satisfying the requirement. In addition, RF absorbing cones are placed at the base of the robot to further reduce reflections. The HAC phantom arch is made of low dielectric constant plastic and should not be a source of reflections.

### Environmental Conditions

During measurements, the temperature of the test lab was kept between 21°C and 25°C and relative humidity was maintained between 20% and 55%.

### Ambient Noise

ANSI C63.19 standard requires RF ambient noise to be at least 20dB below the measurement level. Scans of RF ambient noise fields were previously performed for verification and was determined to be < 20 dB than the measured WD RF field levels.