

EMI Test Report

Tested in accordance with
Federal Communications Commission (FCC)
Personal Communications Services
CFR 47 Parts 2, 22 and 24
&
Industry Canada (IC) RSS- Gen, 132 and 133



A division of Research In Motion Limited

REPORT NO: RTS-3640-1102-33A_rev1

PRODUCT MODEL NO:	RDM71UW, RDN71UW
TYPE NAME:	BlackBerry® smartphone
FCC ID:	L6ARDM70UW, L6ARDN70UW
IC:	2503A-RDM70UW, 2503A-RDN70UW
EMISSION DESIGNATOR (GSM):	248KGXW
EMISSION DESIGNATOR (EDGE):	245KG7W
EMISSION DESIGNATOR (WCDMA):	4M18F9W

This report supersedes the report RTS-3640-1102-33A dated 26 April 2011

DATE: 26 May 2011

		EMI Test Report for the BlackBerry® smartphone Model RDM71UW, RDN71UW
Test Report No. RTS-3640-1102-33A_rev1	Dates of Test January 11 to March 11 & 29 and May 24, 2011	FCC ID: L6ARDM70UW IC: 2503A-RDM70UW FCC ID: L6ARDN70UW IC: 2503A-RDN70UW

Report Revision History:

Rev1:

1. Editorial changes in the header.
2. The associated documents update in section B.
3. The sample EUT update in section C Product Identification.
4. The test update in section G Summary of Results subsection 2, Radiated Emissions, and the related test result update in Appendix 4A.
5. The equipment calibration date updates in section H.

Statement of Performance:

The BlackBerry® smartphone, model RDM71UW, part number CER-33224-001 Rev4 and accessories performs within the requirements of the test standards when configured and operated per RIM's instructions.

The BlackBerry® smartphone, model RDN71UW, part number CER-39230-001 Rev3 and accessories performs within the requirements of the test standards when configured and operated per RIM's instructions.

Declaration:

We hereby certify that:

The test data reported herein is an accurate record of the performance of the sample(s) tested. The test results are valid for the tested unit (s) only. The test equipment used was suitable for the tests performed and within manufacturer's published specifications and operating parameters. The test methods were consistent with the methods described in the relevant standards.

Documented by:



 Quan (Jerry) Ma
 Regulatory Compliance Associate
 Date: 26 May 2011

Reviewed by:



 Kevin Rose
 Regulatory Compliance Specialist
 Date: 26 May 2011

	EMI Test Report for the BlackBerry® smartphone Model RDM71UW, RDN71UW	
Test Report No. RTS-3640-1102-33A_rev1	Dates of Test January 11 to March 11 & 29 and May 24, 2011	FCC ID: L6ARDM70UW IC: 2503A-RDM70UW FCC ID: L6ARDN70UW IC: 2503A-RDN70UW

Reviewed and Approved by:



Masud S. Attayi, P.Eng.
Manager, Regulatory Compliance
Date: 26 May 2011



	EMI Test Report for the BlackBerry® smartphone Model RDM71UW, RDN71UW	
Test Report No. RTS-3640-1102-33A_rev1	Dates of Test January 11 to March 11 & 29 and May 24, 2011	FCC ID: L6ARDM70UW IC: 2503A-RDM70UW FCC ID: L6ARDN70UW IC: 2503A-RDN70UW

Table of Contents

A)	Scope.....	5
B)	1BAssociated Documents	5
C)	2BProduct Identification	5
D)	4BTest Voltage	7
E)	5BTest Results Chart	8
F)	6BSummary of Results.....	9
H)	7BCompliance Test Equipment Used.....	15
	APPENDIX 1A – GSM CONDUCTED RF EMISSIONS TEST DATA/PLOTS.....	17
	APPENDIX 1B – UMTS CONDUCTED RF EMISSIONS TEST DATA/PLOTS.....	34
	APPENDIX 2A – GSM CONDUCTED RF OUTPUT POWER TEST DATA.....	51
	APPENDIX 2B – UMTS CONDUCTED RF OUTPUT POWER TEST DATA.....	53
	APPENDIX 3A – GSM FREQUENCY STABILITY TEST DATA	55
	APPENDIX 3B – UMTS FREQUENCY STABILITY TEST DATA	67
	APPENDIX 4A – GSM RADIATED EMISSIONS TEST DATA.....	79
	APPENDIX 4B – UMTS RADIATED EMISSIONS TEST DATA.....	88

		EMI Test Report for the BlackBerry® smartphone Model RDM71UW, RDN71UW
Test Report No. RTS-3640-1102-33A_rev1	Dates of Test January 11 to March 11 & 29 and May 24, 2011	FCC ID: L6ARDM70UW IC: 2503A-RDM70UW FCC ID: L6ARDN70UW IC: 2503A-RDN70UW

A) Scope

This report details the results of compliance tests which were performed in accordance to the requirements of:

- FCC CFR 47 Part 2, October, 2010
- FCC CFR 47 Part 22, Subpart H, Cellular Radiotelephone Services, October, 2010
- FCC CFR 47 Part 24 Subpart E, Broadband PCS, October, 2010
- Industry Canada, RSS-132 Issue 2, September 2005, Cellular Telephones Employing New Technologies Operating in the Bands 824-849 MHz and 869-894 MHz.
- Industry Canada, RSS-133 Issue 5, February 2009, 2 GHz Personal Communications Services.
- Industry Canada, RSS-GEN Issue 3, December 2010, General Requirements and Information for the Certification of Radiocommunication Equipment

B) Associated Documents

1. RDM71UW_HW_Declaration_CER-33224_Rev2.doc
2. RDM71UW_HW_Declaration_CER-33224_Rev3.doc
3. RDM71UW_HW_Declaration_CER-33224_Rev4.doc
4. MultiSourceDeclaration_RDM71UW_b157.doc
5. RDN71UW_HW_Declaration_CER-39230_Rev1.doc
6. RDN71UW_HW_Declaration_CER-39230_Rev2.doc
7. RDN71UW_HW_Declaration_CER-39230_Rev3.doc
8. BlackBerrySystemSimilarity_RDM71UW_RDN71UW
9. MultiSourceDeclaration_RDM71UW_b301
10. MultiSourceDeclaration_RDM71UW_b871

C) Product Identification

Manufactured by Research In Motion Limited whose headquarters is located at:

295 Phillip Street
 Waterloo, Ontario
 Canada, N2L 3W8
 Phone: 519 888 7465
 Fax: 519 888 6906

		EMI Test Report for the BlackBerry® smartphone Model RDM71UW, RDN71UW	
Test Report No. RTS-3640-1102-33A_rev1	Dates of Test January 11 to March 11 & 29 and May 24, 2011	FCC ID: L6ARDM70UW IC: 2503A-RDM70UW	FCC ID: L6ARDN70UW IC: 2503A-RDN70UW

The equipment under test (EUT) was tested at the following locations:

RIM Testing Services EMI test facilities

305 Phillip Street Waterloo, Ontario Canada, N2L 3W8 Phone: 519 888 7465 Fax: 519 888 6906	440 Phillip Street Waterloo, Ontario, Canada, N2L 5R9 Phone: 519 888 7465 Fax: 519 888 6906
--	---

The testing was performed from Jan 11 to March 11, 29 and May 24, 2011.

The sample EUT included:

Sample	Model	CER NUMBER	PIN	Software Information
1	RDM71UW	CER-33224-001 Rev1	25FFBC1	v6.1.0.8 Bundle 70
2	RDM71UW	CER-33224-001 Rev2	269676F9	v6.1.0.16 Bundle 157
3	RDM71UW	CER-33224-001 Rev2	2696796A	v6.1.0.16 Bundle 157
4	RDM71UW	CER-32270-001 Rev2	2696B23E	v6.1.0.16 Bundle 157
5	RDN71UW	CER-39230-001 Rev1	26CF8DA8	v6.1.0.31 Bundle 301
6	RDN71UW	CER-39230-001 Rev1	26CF8E46	v6.1.0.31 Bundle 301
7	RDM71UW	CER-32270-001 Rev4	27490C92	V7.0.0.111 (Platform: 5.0.0.273) Bundle 871
8	RDN71UW	CER-39230-001 Rev3	27491EF9	V7.0.0.111 (Platform:5.0.0.273) Bundle 871

RF Conducted Emissions testing was performed on sample 1 and 4.

RF Radiated Emissions testing was performed on samples 2, 3, 5, 6, 7 and 8.

To view the differences between bundle 70 and 871, see document number MultiSourceDeclaration_RDM71UW_b157, MultiSourceDeclaration_RDM71UW_b301 and MultiSourceDeclaration_RDM71UW_b871.

To view the differences between CER-33224-001 Rev. 1 and CER-33224-001 Rev. 4, see document HW_Declaration_CER-33224-001 Rev 2, HW_Declaration_CER-33224-001 Rev 3 and HW_Declaration_CER-33224-001 Rev 4.

Only the characteristics that may have been affected by the changes from Rev 1 to Rev 4 have been re-tested.

	EMI Test Report for the BlackBerry® smartphone Model RDM71UW, RDN71UW	
Test Report No. RTS-3640-1102-33A_rev1	Dates of Test January 11 to March 11 & 29 and May 24, 2011	FCC ID: L6ARDM70UW IC: 2503A-RDM70UW FCC ID: L6ARDN70UW IC: 2503A-RDN70UW

Only the characteristics that may have been affected by the changes from model RDM71UW to RDN71UW were re-tested. For more information, see BlackBerrySystemSimilarity_RDM71UW_RDN71UW.

To view the differences between CER-39230-001 Rev. 1 and CER-39230-001 Rev. 3, see document HW_Declaration_CER-39230-001 Rev 2 and HW_Declaration_CER-39230-001 Rev 3.

No support equipment required; for list of equipment refer to section H, Compliance Test Equipment Used.

D) Test Voltage

The ac input voltage was 120 volts, 60 Hz where applicable. This configuration was per RIM's specifications.

		EMI Test Report for the BlackBerry® smartphone Model RDM71UW, RDN71UW	
Test Report No. RTS-3640-1102-33A_rev1	Dates of Test January 11 to March 11 & 29 and May 24, 2011	FCC ID: L6ARDM70UW IC: 2503A-RDM70UW FCC ID: L6ARDN70UW IC: 2503A-RDN70UW	

E) Test Results Chart

SPECIFICATION		TEST TYPE	RESULT	TEST DATA APPENDIX
FCC CFR 47	IC			
Part 2.1051 Part 22.917 Part 22.901	RSS-GEN, 4.9	GSM 850 Conducted Spurious Emissions	Pass	1A
Part 2.1051 Part 24.238(a)	RSS-GEN, 4.9	PCS 1900 Conducted Spurious Emissions	Pass	1A
Part 2.202 Part 22.917	RSS-GEN, 4.6	GSM 850 Occupied Bandwidth and Channel Mask	Pass	1A
Part 2.202 Part 24.238	RSS-GEN, 4.6	PCS 1900 Occupied Bandwidth and Channel Mask	Pass	1A
Part 2.1046(a)	RSS-133, 6.4 RSS-132, 4.4	GSM Conducted RF Output Power	Pass	2A
Part 2.1055(a)(d) Part 22.917	RSS-132, 4.3	GSM 850 Frequency Stability vs. Temperature and Voltage	Pass	3A
Part 2.1055(a)(d) Part 24.235	RSS-132, 4.3	PCS 1900 Frequency Stability vs. Temperature and Voltage	Pass	3A
Part 22, Subpart H, Part 24, Subpart E	RSS-GEN, 4.9	GSM ERP, EIRP	Pass	4A
Part 22, Subpart H Part 24, Subpart E	RSS-GEN, 4.9	GSM Radiated Spurious/Harmonic Emissions	Pass	4A
Part 2.1051 Part 22.917 Part 22.901(d)	RSS-GEN, 4.9	UMTS Band 5 Conducted Spurious Emissions	Pass	1B
Part 2.1051 Part 24.238(a)	RSS-GEN, 4.9	UMTS Band 2 Conducted Spurious Emissions	Pass	1B
Part 2.202 Part 22.917	RSS-GEN, 4.6	UMTS Band 5 Occupied Bandwidth and Channel Mask	Pass	1B
Part 2.202 Part 24.238	RSS-GEN, 4.6	UMTS Band 2 Occupied Bandwidth and Channel Mask	Pass	1B
Part 2.1046(a)	RSS-133, 6.4 RSS-132, 4.4	UMTS Band 2 and 5 Conducted RF Output Power	Pass	2B
Part 2.1055(a)(d) Part 22.917	RSS-132, 4.3	UMTS Band 5 Frequency Stability vs. Temperature and Voltage	Pass	3B

		EMI Test Report for the BlackBerry® smartphone Model RDM71UW, RDN71UW	
Test Report No. RTS-3640-1102-33A_rev1	Dates of Test January 11 to March 11 & 29 and May 24, 2011	FCC ID: L6ARDM70UW IC: 2503A-RDM70UW FCC ID: L6ARDN70UW IC: 2503A-RDN70UW	

Part 2.1055(a)(d) Part 24.235	RSS-GEN, 4.7	UMTS Band 2 Frequency Stability vs. Temperature and Voltage	Pass	3B
Part 22, Subpart H	RSS-GEN, 4.9	UMTS Band 5 Radiated Spurious/Harmonic Emissions, ERP	Pass	4B
Part 24, Subpart E	RSS-GEN, 4.9	UMTS Band 2 Radiated Spurious/Harmonic Emissions, EIRP	Pass	4B

F) Summary of Results

1) Conducted Emission Measurements

The following results are for RDM71UW

a) The BlackBerry® smartphone met the requirements of the Tx Conducted Spurious Emissions requirements in the GSM850 as per 47 CFR 2.1051, CFR 22.917, CFR 22.901(d) and RSS-GEN, 4.9. The EUT was measured on the low, middle and high channels. The frequency range investigated was from 10 MHz to 10 GHz.

See APPENDIX 1A for test data.

The BlackBerry® smartphone met the requirements of the Tx Conducted Spurious Emissions requirements in the PCS1900 as per 47 CFR 2.1051, CFR 24.238(a) and RSS-GEN, 4.9. The EUT was on the low, middle and high channels. The frequency range investigated was from 10 MHz to 20 GHz.

See APPENDIX 1A for test data

b) The BlackBerry® smartphone met the requirements of the Occupied Bandwidth and channel mask requirements in the GSM850 as per 47 CFR 2.202, CFR 22.917 and RSS-GEN, 4.6. The EUT was measured in GSM and EDGE mode on the low, middle and high channels. The worst case occupied bandwidth was 246.7 kHz on middle channel in GSM mode, and 245.0 kHz on high channel in EDGE mode.

See APPENDIX 1A for test data.

The BlackBerry® smartphone met the requirements of the Occupied Bandwidth and channel mask requirements in the PCS1900 as per 47 CFR 2.202, CFR 24.238 and RSS-GEN, 4.6. The EUT was measured in GSM and EDGE mode on the low, middle and high channels. The worst case occupied bandwidth was 247.7 kHz on high channel in GSM, and 245 kHz on middle and high channel in EDGE mode.

See APPENDIX 1A for test data.

	EMI Test Report for the BlackBerry® smartphone Model RDM71UW, RDN71UW	
Test Report No. RTS-3640-1102-33A_rev1	Dates of Test January 11 to March 11 & 29 and May 24, 2011	FCC ID: L6ARDM70UW IC: 2503A-RDM70UW FCC ID: L6ARDN70UW IC: 2503A-RDN70UW

c) The BlackBerry® smartphone met the requirements of the Tx Conducted RF output Power requirements in the GSM850 as per 47 CFR 2.1046, and RSS-GEN, 4.4. The EUT was measured on the low, middle and high channels. The frequency range investigated was from 10 MHz to 10 GHz.
See APPENDIX 2A for test data.

The BlackBerry® smartphone met the requirements of the Tx Conducted RF output Power requirements in the PCS1900 as per 47 CFR 2.1046, and RSS-GEN, 6.4. The EUT was on the low, middle and high channels. The frequency range investigated was from 10 MHz to 20 GHz.
See APPENDIX 2A for test data

d) The BlackBerry® smartphone met the requirements of the Frequency Satbility requirements in the GSM850 as per 47 CFR 2.1055, CFR 22.917 and RSS-GEN, 4.3. The EUT was measured in GSM850 mode on the low, middle and high channels.
See APPENDIX 3A for test data.

The BlackBerry® smartphone met the requirements of the Frequency Satbility requirements in the PCS1900 as per 47 CFR 2.1055, CFR 24.235 and RSS-GEN, 4.7. The EUT was measured in PCS1900 mode on the low, middle and high channels.
See APPENDIX 3A for test data.

e) The BlackBerry® smartphone met the requirements of the Conducted Spurious Emissions in the UMTS band 5 as per 47 CFR 2.1057, CFR 22.917, CFR 22.901(d) CFR 22.901(d) and RSS-GEN, 4.9. The EUT was measured in Loopback and HSUPA mode on the low, middle and high channels. The frequency range investigated was from 10 MHz to 10 GHz.
See APPENDIX 1B for the test data.

The BlackBerry® smartphone met the requirements of the Conducted Spurious Emissions in the UMTS band 2 band as per 47 CFR 2.1057, CFR 24.238(a) and RSS-GEN, 4.9. The EUT was measured in Loopback and HSUPA mode on the low, middle and high channels. The frequency range investigated was from 10 MHz to 20 GHz.
See APPENDIX 1B for the test data.

f) The BlackBerry® smartphone met the requirements of the Occupied Bandwidth and channel mask in the UMTS band 5 as per 47 CFR 2.202, CFR 22.917 and RSS-GEN, 4.6. The channels were measured in Loopback and HSUPA mode on the low, middle and high channels. The worst case occupied bandwidth was 4.183 MHz on middle channel in Loopback and 4.183 MHz on middle channels in HSUPA mode.

	EMI Test Report for the BlackBerry® smartphone Model RDM71UW, RDN71UW	
Test Report No. RTS-3640-1102-33A_rev1	Dates of Test January 11 to March 11 & 29 and May 24, 2011	FCC ID: L6ARDM70UW IC: 2503A-RDM70UW FCC ID: L6ARDN70UW IC: 2503A-RDN70UW

See APPENDIX 1B for the test data.

The BlackBerry® smartphone met the requirements of the Occupied Bandwidth and channel mask in the UMTS Band 2 as per 47 CFR 2.202, CFR 24.238 and RSS-GEN, 4.6. The channels were measured in Loopback and HSUPA mode on the low, middle and high channels. The worst case occupied bandwidth was 4.175 MHz on low and mid channels in Loopback and 4.175 MHz on low, middle and high channels in HSUPA mode.

See APPENDIX 1B for the test data.

g) The BlackBerry® smartphone met the requirements of the Tx Conducted RF output Power requirements in the UMTS 5 as per 47 CFR 2.1046, and RSS-GEN, 4.4. The EUT was measured on the low, middle and high channels.

See APPENDIX 2B for test data.

The BlackBerry® smartphone met the requirements of the Tx Conducted RF output Power requirements in the UMTS 2 as per 47 CFR 2.1046, and RSS-GEN, 6.4. The EUT was on the low, middle and high channels.

See APPENDIX 2B for test data

h) The BlackBerry® smartphone met the requirements of the Frequency Satbility requirements in the UMTS 5 as per 47 CFR 2.1055, CFR 22.917 and RSS-GEN, 4.3. The EUT was measured in UMTS 5 mode on the low, middle and high channels.

See APPENDIX 3B for test data.

The BlackBerry® smartphone met the requirements of the Frequency Satbility requirements in the UMTS 2 as per 47 CFR 2.1055, CFR 24.235 and RSS-GEN, 4.7. The EUT was measured in UMTS 2 mode on the low, middle and high channels.

See APPENDIX 3B for test data.

	EMI Test Report for the BlackBerry® smartphone Model RDM71UW, RDN71UW	
Test Report No. RTS-3640-1102-33A_rev1	Dates of Test January 11 to March 11 & 29 and May 24, 2011	FCC ID: L6ARDM70UW IC: 2503A-RDM70UW FCC ID: L6ARDN70UW IC: 2503A-RDN70UW

2) Radiated Emission Measurements

The radiated spurious emissions/harmonics and ERP/EIRP were measured for GSM 850, PCS 1900, UMTS band 2 and UMTS band 5. The results are within the limits. The BlackBerry® smartphone was placed on a nonconductive styrofoam table, 100 cm high that was positioned on a remotely controlled turntable. The test distance used between the BlackBerry® smartphone and the receiving antenna was three metres. Then the emissions were maximized by elevating the antenna in the range of 1 to 4 metres. The turntable was rotated to determine the azimuth of the peak emissions. Both the horizontal and vertical polarizations of the emissions were measured. The maximum emissions level was recorded. The BlackBerry® smartphone was then substituted with an antenna placed in the same location as the BlackBerry® smartphone. A Dipole antenna was used for the ERP measurements and a Horn antenna was used for EIRP measurements. The substitution antenna was connected into a signal generator that was set to the test frequency.

The emissions were maximized by elevating the antenna in the range of 1 to 4 metres. The signal generator output was then adjusted to match the BlackBerry® smartphone output reading. The signal generator output was recorded. Both the horizontal and vertical polarizations of the emissions were measured.

The following measurements were done in a semi-anechoic chamber (SAC) below 1 GHz and a Semi-anechoic Chamber ((SAC) with floor absorber) above 1 GHz. The SAC's FCC registration number is **778487** and the Industry Canada (IC) file number is **2503B-1**. The SAC with floor absorber's FCC registration number is **959115** and the IC file number is **2503C-1**. The BlackBerry® smartphone was measured on the low, middle and high channels.

The following results are for RDM71UW

The highest ERP in the 850 band call mode measured was 30.26 dBm (1.06 W) at 848.80 MHz (channel 251).

The highest ERP in the 850 band EDGE mode measured was 27.76 dBm (0.6 W) at 848.80 MHz (channel 251).

The highest EIRP in the PCS band call mode measured was 32.63 dBm (1.83 W) at 1880.00 MHz (channel 661).

The highest EIRP in the PCS band EDGE mode measured was 32.69 dBm (1.86 W) at 1880.00 MHz (channel 661).

	EMI Test Report for the BlackBerry® smartphone Model RDM71UW, RDN71UW	
Test Report No. RTS-3640-1102-33A_rev1	Dates of Test January 11 to March 11 & 29 and May 24, 2011	FCC ID: L6ARDM70UW IC: 2503A-RDM70UW FCC ID: L6ARDN70UW IC: 2503A-RDN70UW

The highest ERP in the UMTS band 5, Call Service mode was 20.28 dBm (0.11 W) at 846.60 MHz (channel 4233).

The highest ERP in the UMTS band 5, HSUPA mode was 21.39 dBm (0.14 W) at 846.60 MHz (channel 4233).

The highest EIRP in the UMTS band 2, Call Service mode measured was 26.50 dBm (0.44 W) at 1852.40MHz (channel 9262).

The highest EIRP in the UMTS band 2, HSUPA mode measured was 26.66 dBm (0.46 W) at 1852.40MHz (channel 9262).

The radiated spurious emission and carrier harmonics were measured up to the 10th harmonic for low, middle, and high channels in the GSM850 and PCS 1900 bands. Each band was measured in GSM and EDGE mode. Both the horizontal and vertical polarizations were measured.

The worst margins in the 850 band for GSM and EDGE modes harmonic emissions were 12.7 dB below the limit at 2509.816 MHz.

The margins in the PCS band for GSM and EDGE modes harmonic emissions were greater than 25 dB below the accepted limits for all test frequencies.

The radiated carrier harmonics were measured up to the 10th harmonic for low, middle and high channels in the UMTS band 5 and UMTS band 2. Each band was measured in Call, and HSUPA modes. Both the horizontal and vertical polarizations were measured.

The margins in the UMTS band 5 for harmonic emissions were greater than 25 dB below the accepted limits for all test frequencies.

The margins in the UMTS band 2 for harmonic emissions were greater than 25 dB below the accepted limits for all test frequencies.

The following results are for RDN71UW

The highest ERP in the 850 band call mode measured was 29.35 dBm (0.86 W) at 848.80 MHz (channel 251).

The highest ERP in the 850 band EDGE mode measured was 24.05 dBm (0.25 W) at 824.20 MHz (channel 128).

The highest EIRP in the PCS band call mode measured was 32.48 dBm (1.77 W) at 1880.00 MHz (channel 661).

	EMI Test Report for the BlackBerry® smartphone Model RDM71UW, RDN71UW	
Test Report No. RTS-3640-1102-33A_rev1	Dates of Test January 11 to March 11 & 29 and May 24, 2011	FCC ID: L6ARDM70UW IC: 2503A-RDM70UW FCC ID: L6ARDN70UW IC: 2503A-RDN70UW

The highest EIRP in the PCS band EDGE mode measured was 32.77 dBm (1.89 W) at 1880.00 MHz (channel 661).

The highest EIRP in the UMTS band 2, Call Service mode measured was 25.96 dBm (0.39 W) at 1852.40MHz (channel 9262).

The highest EIRP in the UMTS band 2, HSUPA mode measured was 27.07 dBm (0.51 W) at 1852.40MHz (channel 9262).

Sample Calculation:

Field Strength (dBµV/M) is calculated as follows:

FS = Measured Level (dBµV) + A.F. (dB/m) + Cable Loss (dB) - Preamp (dB) + Filter Loss (dB)

To view the test data see APPENDIX 4A and 4B.

Measurement Uncertainty ±4.6 dB

		EMI Test Report for the BlackBerry® smartphone Model RDM71UW, RDN71UW	
Test Report No. RTS-3640-1102-33A_rev1	Dates of Test January 11 to March 11 & 29 and May 24, 2011	FCC ID: L6ARDM70UW IC: 2503A-RDM70UW	FCC ID: L6ARDN70UW IC: 2503A-RDN70UW

H) Compliance Test Equipment Used

<u>UNIT</u>	<u>MANUFACTURER</u>	<u>MODEL</u>	<u>SERIAL NUMBER</u>	<u>CAL DUE DATE</u> (YY MM DD)	<u>USE</u>
Preamplifier	Sonoma	310N/11909A	185831	11-11-24	Radiated Emissions
Preamplifier system	TDK RF Solutions	PA-02	080010	11-11-24	Radiated Emissions
Preamplifier	Rohde & Schwarz	TS-ANA4-SP	001	11-12-01	Radiated Emissions
Preamplifier	Rohde & Schwarz	TS-ANA-SP	001	11-12-01	Radiated Emissions
Hybrid Log Antenna	EMC Automation	HLP-3003C	017401	12-01-04	Radiated Emissions
Horn Antenna	EMC Automation	HRN-0118	030101	12-07-20	Radiated Emissions
Horn Antenna	EMC Automation	HRN-0118	030201	12-09-22	Radiated Emissions
Horn Antenna	Emco	3117	47563	11-07-15	Radiated Emissions
Horn Antenna	CMT	LHA 0180	R52734-001	12-01-21	Radiated Emissions
Dipole Antenna	Schwarzbeck	UHAP	1018	12-04-20	Radiated Emissions
Dipole Antenna	Schwarzbeck	UHAP	974	13-02-21	Radiated Emissions
Universal Radio Communication Tester	Rohde & Schwarz	CMU 200	837493/073	11-10-01	Radiated Emissions
Universal Radio Communication Tester	Rohde & Schwarz	CMU 200	112394	11-10-01	Radiated Emissions
Universal Radio Communication Tester	Rohde & Schwarz	CMU 200	102204	11-11-30	RF Conducted Emissions
EMI Receiver	Rohde & Schwarz	ESIB-40	100255	11-11-28	Radiated Emissions
EMI Receiver	Rohde & Schwarz	ESU-40	100162	11-11-30	Radiated Emissions
Spectrum Analyzer	HP	8563E	3745A08112	11-09-30	RF Conducted Emissions
DC Power Supply	HP	6632B	US37472178	11-11-19	RF Conducted Emissions
Environment Monitor	Omega	iTHX-SD	0380561	11-10-13	Radiated Emissions

		EMI Test Report for the BlackBerry® smartphone Model RDM71UW, RDN71UW	
Test Report No. RTS-3640-1102-33A_rev1	Dates of Test January 11 to March 11 & 29 and May 24, 2011	FCC ID: L6ARDM70UW IC: 2503A-RDM70UW	FCC ID: L6ARDN70UW IC: 2503A-RDN70UW

Compliance Test Equipment Used cont'd

<u>UNIT</u>	<u>MANUFACTURER</u>	<u>MODEL</u>	<u>SERIAL NUMBER</u>	<u>CAL DUE DATE (YY MM DD)</u>	<u>USE</u>
Environment Monitor	Omega	iTHX-SD	0340060	11-10-13	RF Conducted Emissions
Environment Monitor	Omega	iTHX-SD	0380567	11-10-13	Radiated Emissions
Signal Generator	Agilent	E8257D	MY45140527	11-11-05	Radiated Emissions
Signal Generator	Agilent	83630B	3844A00927	12-10-28	Radiated Emissions

APPENDIX 1A – GSM CONDUCTED RF EMISSIONS TEST DATA/PLOTS

	EMI Test Report for the BlackBerry® smartphone Model RDM71UW, RDN71UW APPENDIX 1A	
	Test Report No. RTS-3640-1102-33A_rev1	Dates of Test January 11 to March 11 & 29 and May 24, 2011

GSM Conducted RF Emission Test Data

The following results are for RDM71UW

This appendix contains measurement data pertaining to conducted spurious emissions, -26 dBc bandwidth, 99% power bandwidth and the channel mask on BlackBerry® smartphone.

Test Setup Diagram

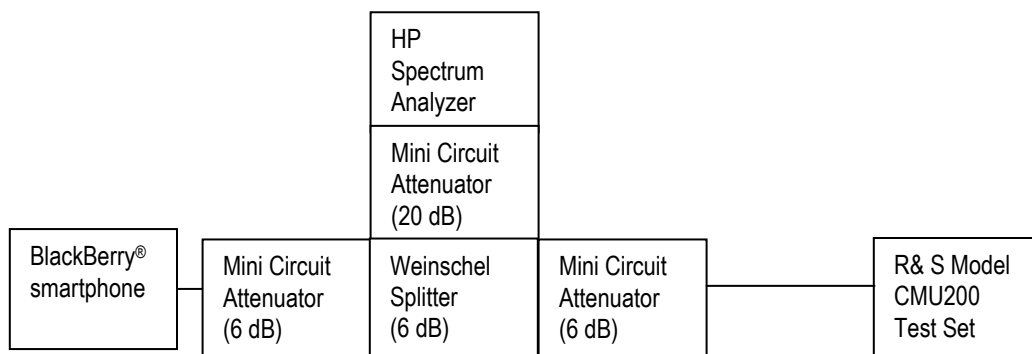

Date of Test: Jan 13, 2011

The environmental test conditions were:

Temperature: 24.0 °C

Relative Humidity: 29.8 %

The following measurements were performed by Maurice Battler.

	EMI Test Report for the BlackBerry® smartphone Model RDM71UW, RDN71UW APPENDIX 1A	
	Test Report No. RTS-3640-1102-33A_rev1	Dates of Test January 11 to March 11 & 29 and May 24, 2011

GSM Conducted RF Emission Test Data cont'd

The conducted spurious emissions – As per 47 CFR 2.1051, CFR 24.238(a), RSS-GEN, 4.9, CFR 22 Subpart H and RSS-132 were measured from 10 MHz to 20 GHz. The EUT emissions were in the noise floor.

See figures 1-1a to 1-12a for the plots of the conducted spurious emissions.

–26 dBc Bandwidth and Occupied Bandwidth (99%)

For each carrier frequency of low, middle and high, the modulation spectrum was measured by both methods of 99% power bandwidth and –26 dBc bandwidth.

The resolution bandwidth required for out-of-band emissions in the 1 MHz bands immediately outside and adjacent to the frequency block, was determined to be at least 1% of the emission bandwidth.

The worst case –26dBc bandwidth for the GSM850 band was measured to be 273 kHz, and for the PCS1900 band was measured to be 277 kHz as shown below. This results in a 3.0 kHz resolution bandwidth.

On any frequency outside the frequency block and outside the adjacent 1 MHz bands, a resolution bandwidth of at least 1 MHz was applied.

Test Data for 850 band and 1900 band selected Frequencies in GSM mode.

850 band Frequency (MHz)	-26dBc Bandwidth (kHz)	99% Occupied Bandwidth (kHz)
824.2	268	243.3
837.6	273	246.7
848.8	270	241.7

1900 band Frequency (MHz)	-26dBc Bandwidth (kHz)	99% Occupied Bandwidth (kHz)
1850.2	270	245.0
1880.0	277	245.0
1909.8	270	247.7

Measurement Plots for 850 and 1900 in GSM mode

Refer to the following measurement plots for more detail.

See Figures 1-13a to 1-24a for the plots of the –26dBc Bandwidth and 99% Occupied Bandwidth.

See Figures 1-25a to 1-28a for plots of the channel mask results.

The RF power output was at maximum for all the recorded measurements shown below.

	EMI Test Report for the BlackBerry® smartphone Model RDM71UW, RDN71UW APPENDIX 1A	
	Test Report No. RTS-3640-1102-33A_rev1	Dates of Test January 11 to March 11 & 29 and May 24, 2011

GSM Conducted RF Emission Test Data cont'd

Date of Test: Feb 10, 2011

Test Data for 850 and 1900 bands selected Frequencies in EDGE mode.

850 band Frequency (MHz)	99% Occupied Bandwidth (kHz)
824.2	241.7
837.6	243.3
848.8	245.0

1900 band Frequency (MHz)	99% Occupied Bandwidth (kHz)
1850.2	243.3
1880.0	245.0
1909.8	245.0

Measurement Plots for 850 and 1900 bands in EDGE mode

Refer to the following measurement plots for more detail.

See Figures 1-29a to 1-34a for the plots of the 99% Occupied Bandwidth.

See Figures 1-35a to 1-38a for the plots of channel mask EDGE results.

See figures 1-39a to 1-50a for the plots of the conducted spurious emissions

The RF power output was at maximum for all the recorded measurements shown below.

	EMI Test Report for the BlackBerry® smartphone Model RDM71UW, RDN71UW APPENDIX 1A	
	Test Report No. RTS-3640-1102-33A_rev1	Dates of Test January 11 to March 11 & 29 and May 24, 2011

GSM Conducted RF Emission Test Data cont'd

Figure 1-1a: GSM850 band, Spurious Conducted Emissions, Low channel

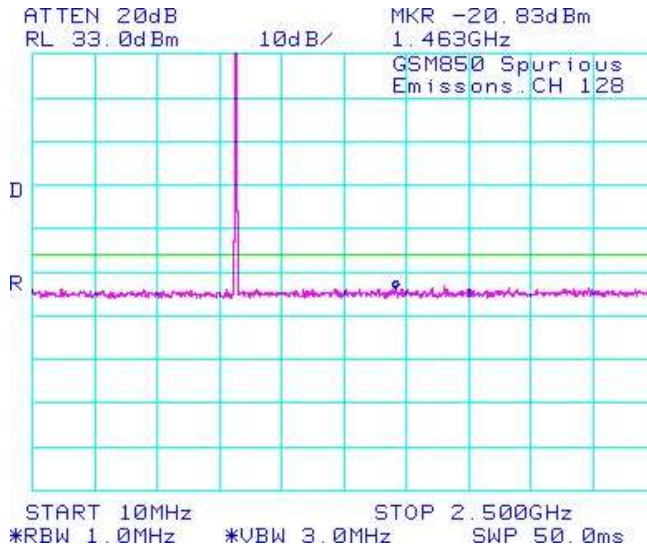

Figure 1-2a: GSM850 band, Spurious Conducted Emissions, Low channel

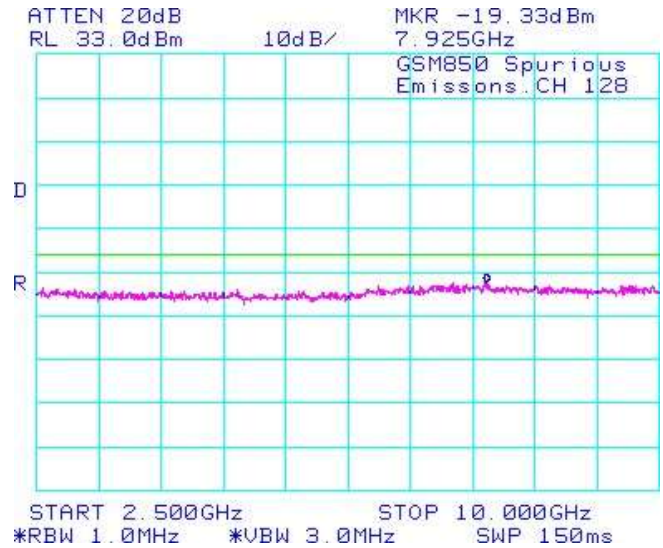

Figure 1-3a: GSM850 band, Spurious Conducted Emissions, Middle Channel

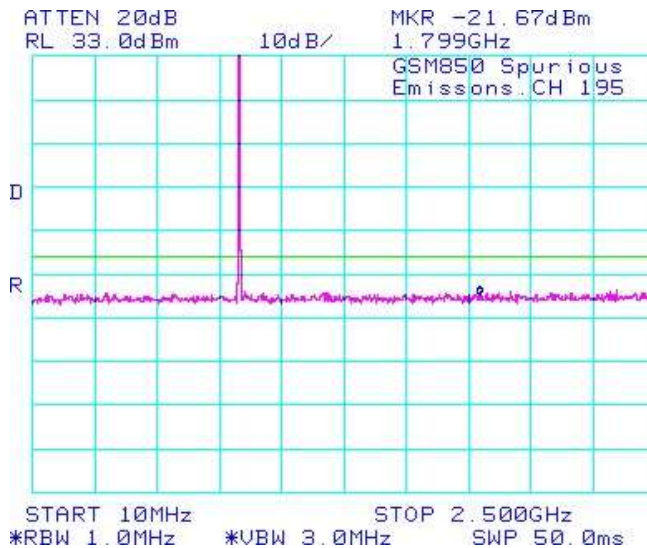
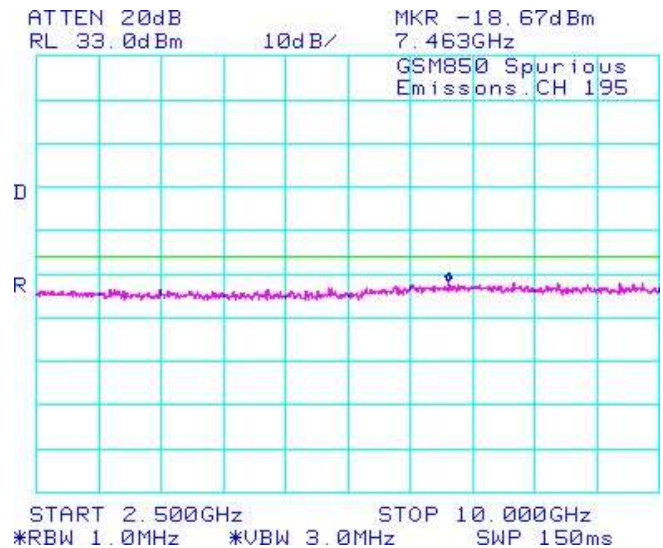



Figure 1-4a: GSM850 band, Spurious Conducted Emissions, Middle Channel



	EMI Test Report for the BlackBerry® smartphone Model RDM71UW, RDN71UW APPENDIX 1A	
	Test Report No. RTS-3640-1102-33A_rev1	Dates of Test January 11 to March 11 & 29 and May 24, 2011

GSM Conducted RF Emission Test Data cont'd

Figure 1-5a: GSM850 band, Spurious Conducted Emissions, High Channel

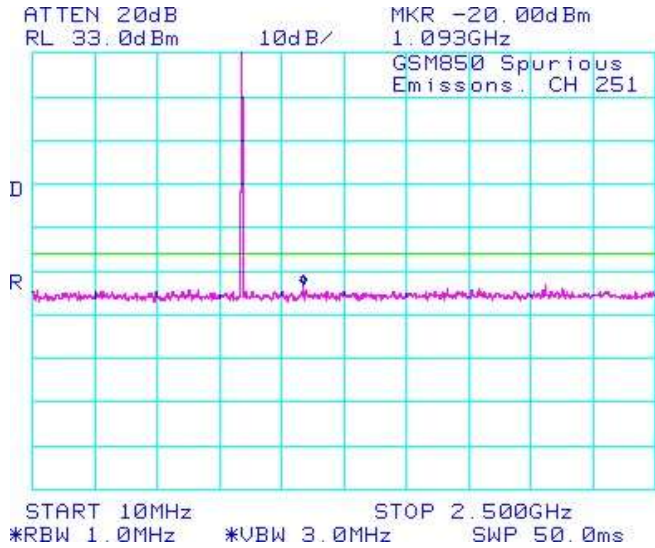

Figure 1-6a: GSM850 band, Spurious Conducted Emissions, High Channel

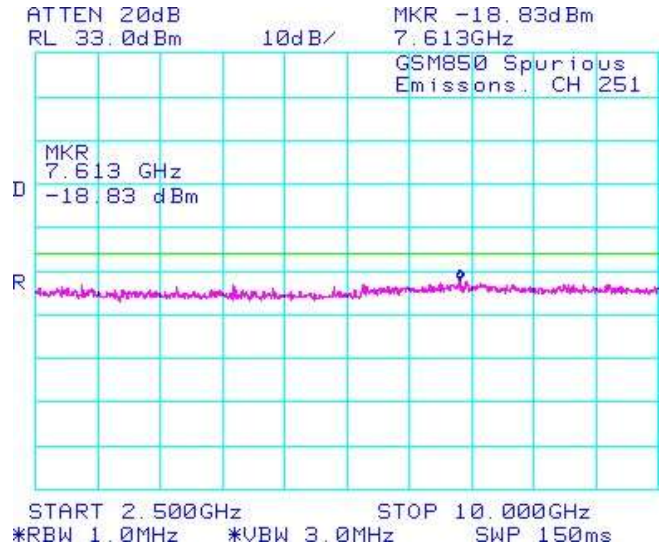

Figure 1-7a: PCS1900 band, Spurious Conducted Emissions, Low Channel

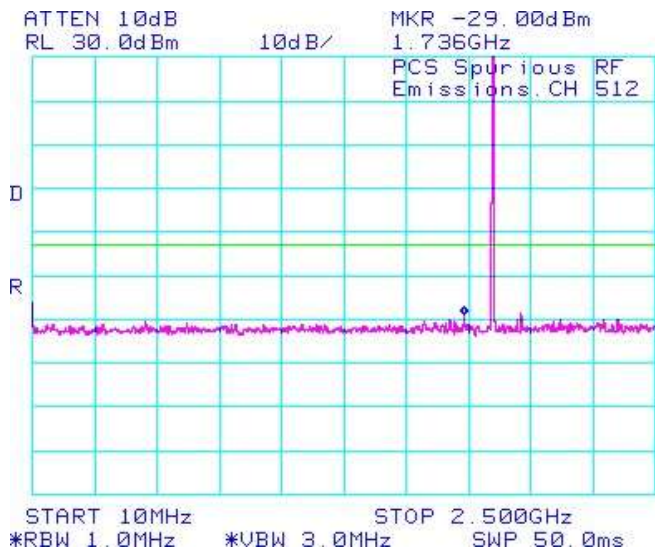
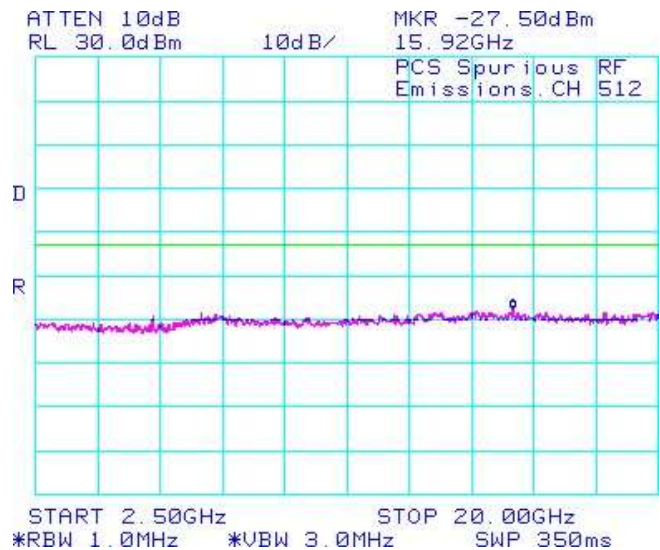



Figure 1-8a: PCS1900 band, Spurious Conducted Emissions, Low Channel



	EMI Test Report for the BlackBerry® smartphone Model RDM71UW, RDN71UW APPENDIX 1A	
	Test Report No. RTS-3640-1102-33A_rev1	Dates of Test January 11 to March 11 & 29 and May 24, 2011

GSM Conducted RF Emission Test Data cont'd

Figure 1-9a: PCS1900 band, Spurious Conducted Emissions, Middle Channel

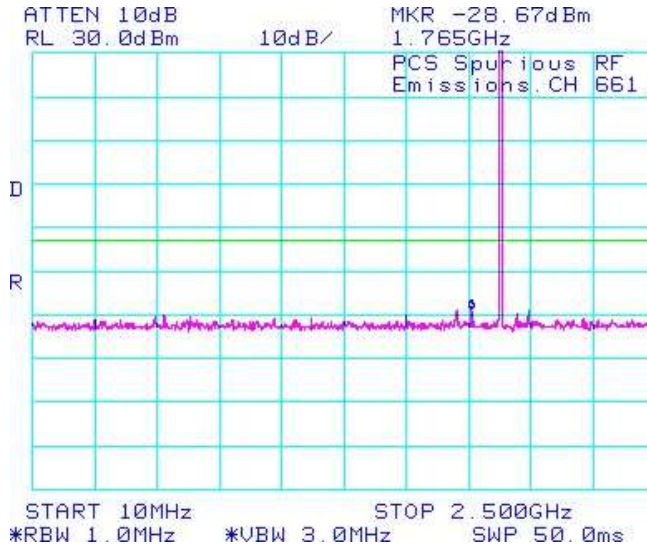

Figure 1-10a: PCS1900 band, Spurious Conducted Emissions, Middle Channel

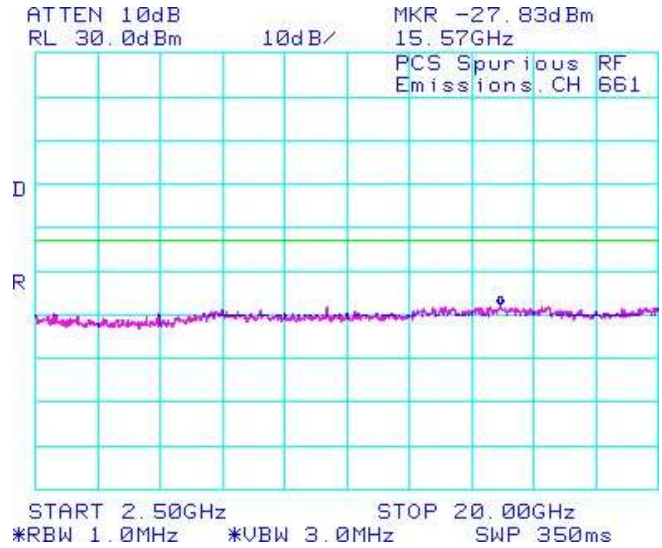

Figure 1-11a: PCS1900 band, Spurious Conducted Emissions, High Channel

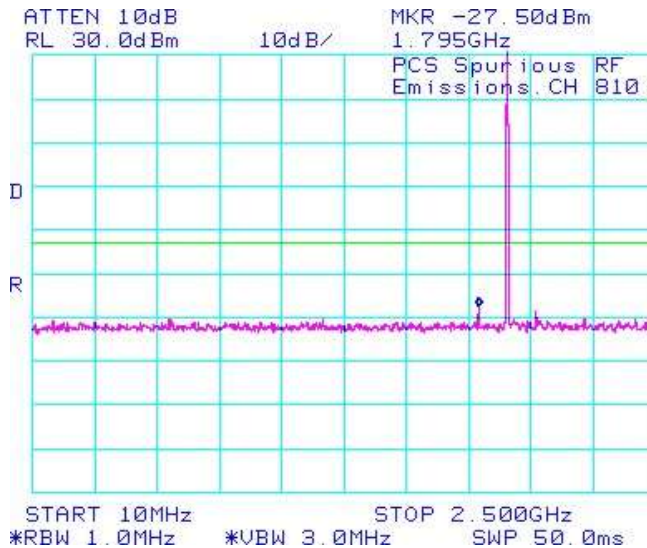
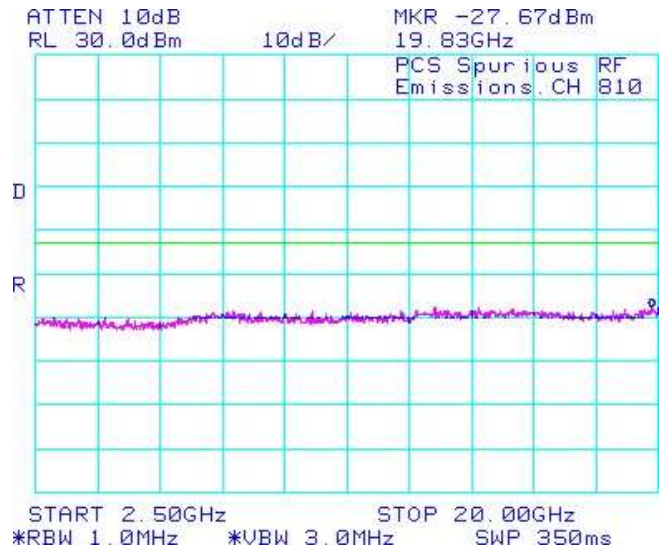

Figure 1-12a: PCS1900 band, Spurious Conducted Emissions, High Channel



GSM Conducted RF Emission Test Data cont'd

Figure 1-13a: -26dBc bandwidth, GSM850 band Low Channel in GSM mode

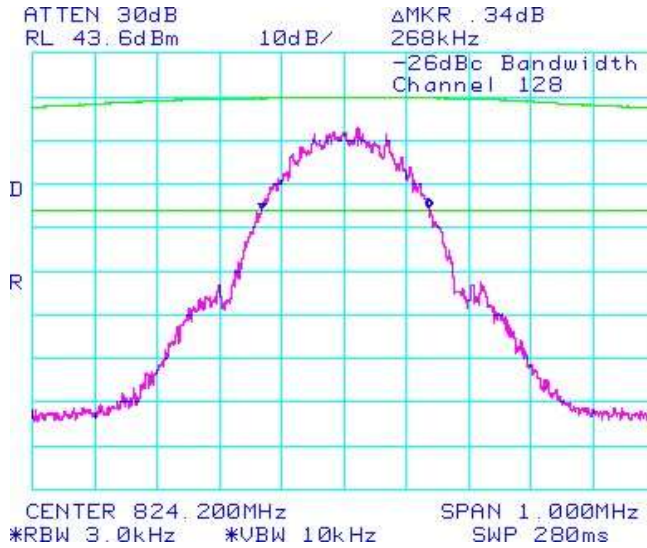

Figure 1-14a: Occupied Bandwidth, GSM850 band Low Channel in GSM mode



Figure 1-15a: -26dBc bandwidth, GSM850 band Middle Channel in GSM mode

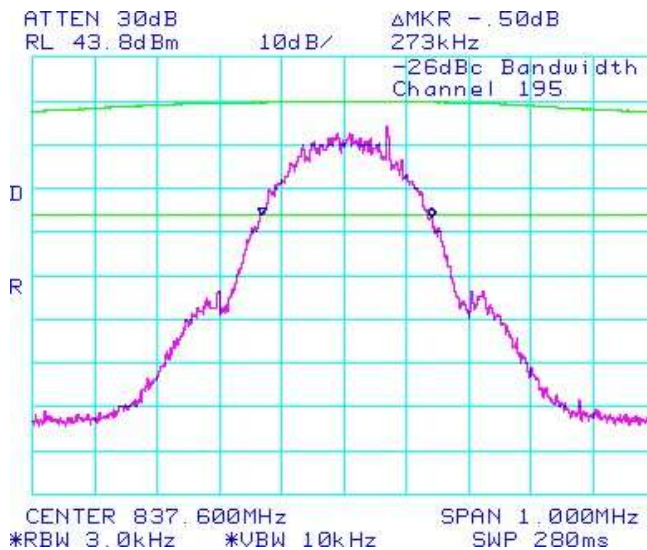



Figure 1-16a: Occupied Bandwidth, GSM850 band Middle Channel in GSM mode



	EMI Test Report for the BlackBerry® smartphone Model RDM71UW, RDN71UW APPENDIX 1A	
	Test Report No. RTS-3640-1102-33A_rev1	Dates of Test January 11 to March 11 & 29 and May 24, 2011

GSM Conducted RF Emission Test Data cont'd

Figure 1-17a: -26dBc bandwidth, GSM850 band High Channel in GSM mode



Figure 1-18a: Occupied Bandwidth, GSM850 band High Channel in GSM mode

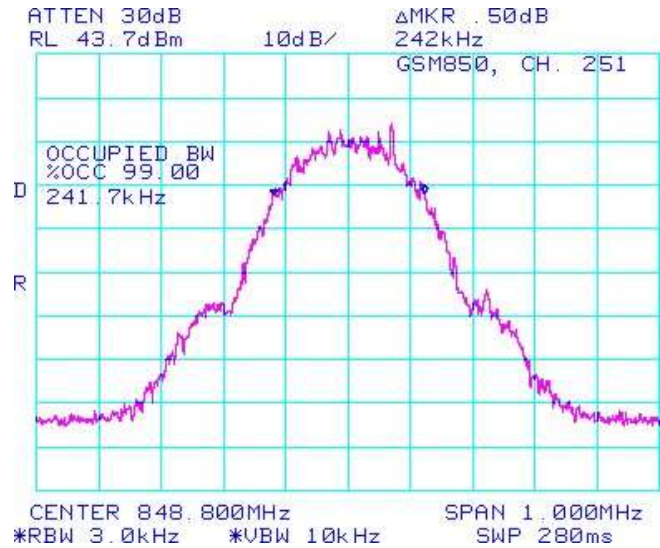

Figure 1-19a: -26dBc bandwidth, PCS1900 Low Channel in GSM mode

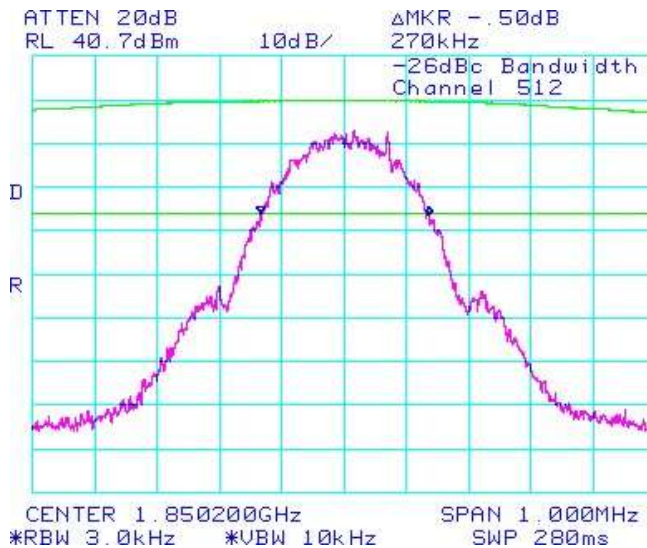
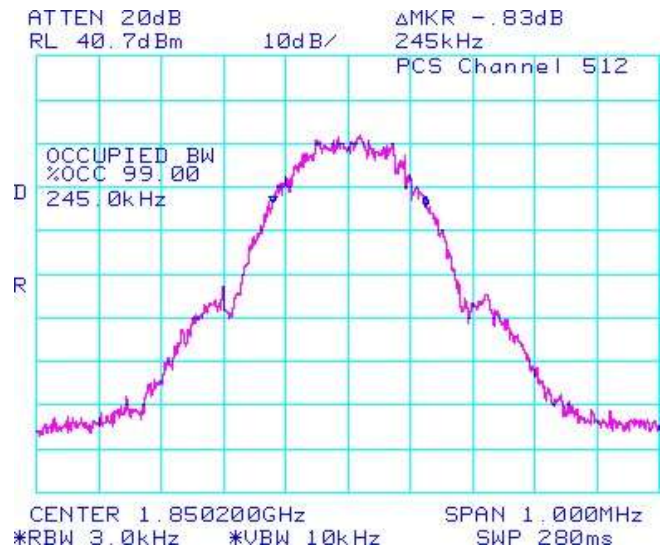



Figure 1-20a: Occupied Bandwidth, PCS1900 Low Channel in GSM mode



	EMI Test Report for the BlackBerry® smartphone Model RDM71UW, RDN71UW APPENDIX 1A	
	Test Report No. RTS-3640-1102-33A_rev1	Dates of Test January 11 to March 11 & 29 and May 24, 2011

GSM Conducted RF Emission Test Data cont'd

**Figure 1-21a: -26dBc bandwidth, PCS1900
Middle Channel in GSM mode**



**Figure 1-22a: Occupied Bandwidth, PCS1900
Middle Channel in GSM mode**

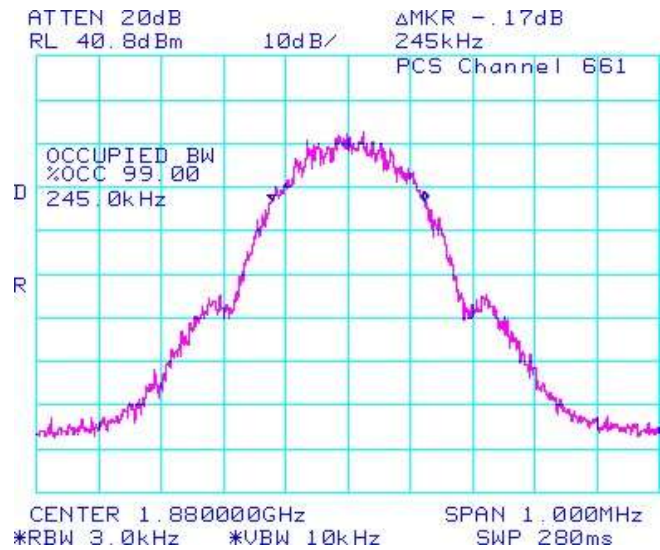

**Figure 1-23a: -26dBc bandwidth, PCS1900
High Channel in GSM mode**

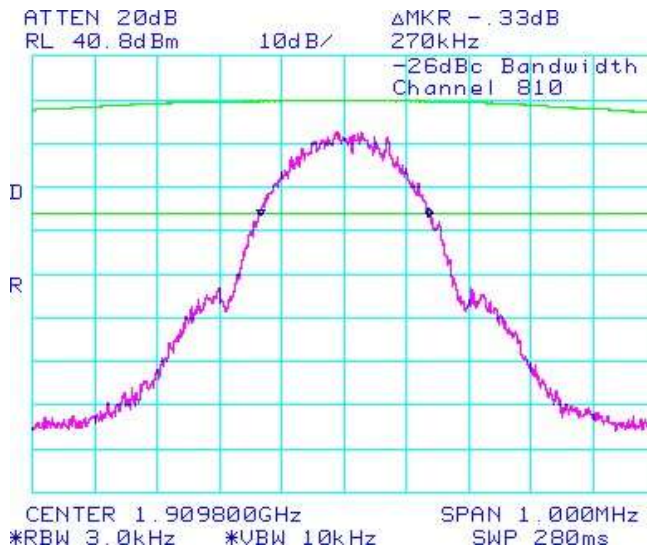

**Figure 1-24a: Occupied Bandwidth, PCS1900
High Channel in GSM mode**



	EMI Test Report for the BlackBerry® smartphone Model RDM71UW, RDN71UW APPENDIX 1A	
	Test Report No. RTS-3640-1102-33A_rev1	Dates of Test January 11 to March 11 & 29 and May 24, 2011

GSM Conducted RF Emission Test Data cont'd

Figure 1-25a: GSM850 band, Low Channel Mask in GSM mode

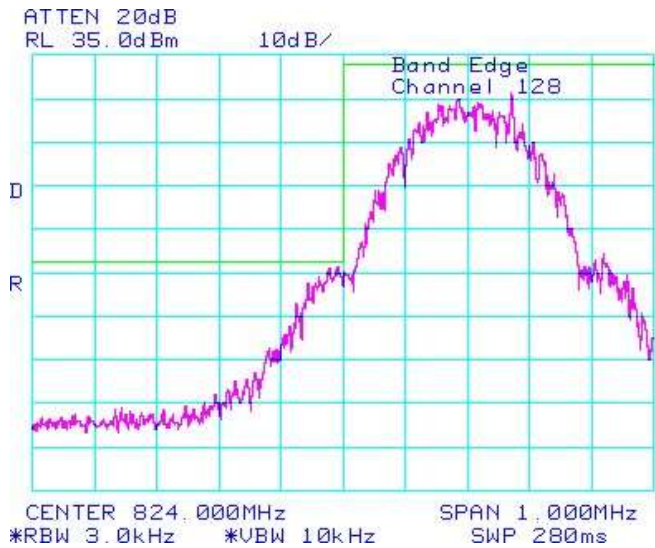

Figure 1-26a: GSM850 band High Channel Mask in GSM mode

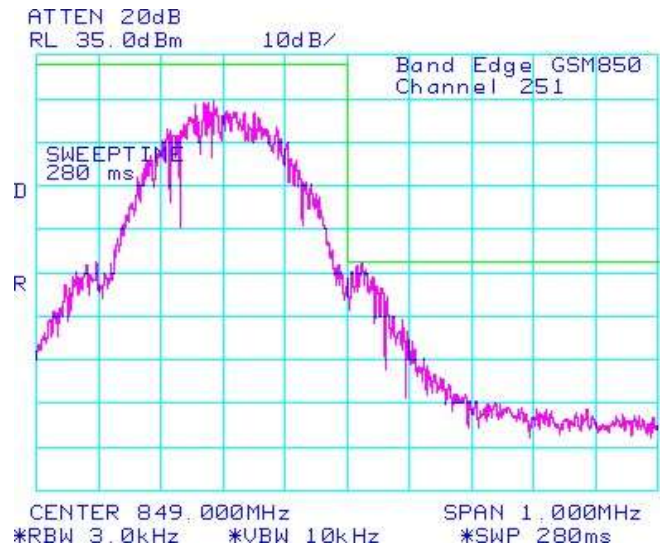

Figure 1-27a: PCS1900, Low Channel Mask in GSM mode

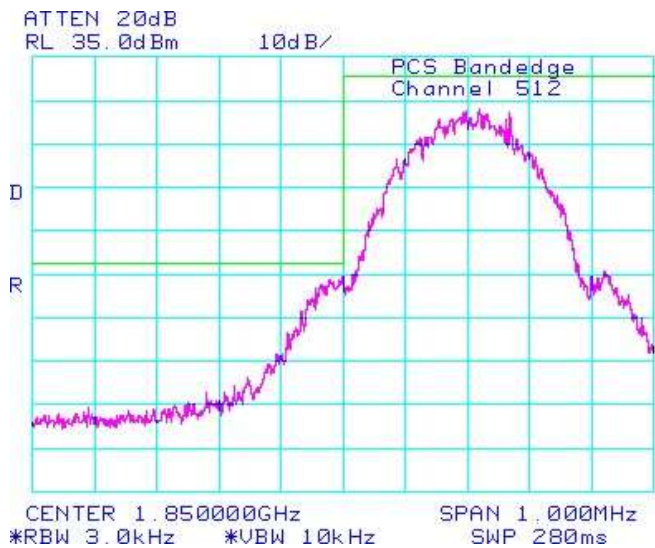
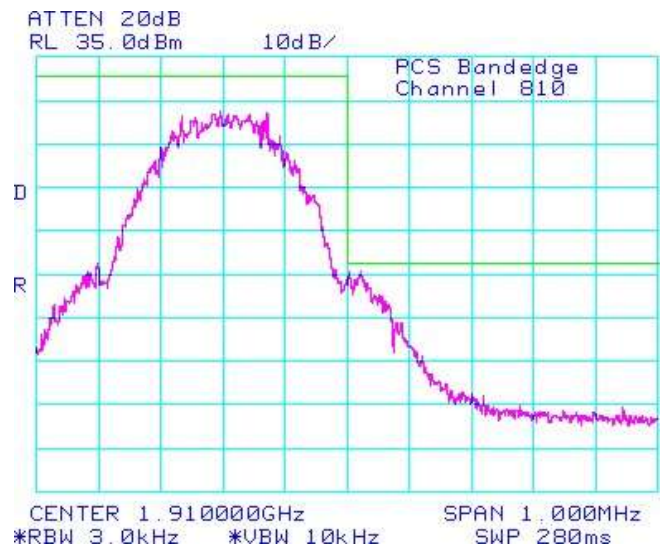



Figure 1-28a: PCS1900, High Channel Mask in GSM mode



	EMI Test Report for the BlackBerry® smartphone Model RDM71UW, RDN71UW APPENDIX 1A	
	Test Report No. RTS-3640-1102-33A_rev1	Dates of Test January 11 to March 11 & 29 and May 24, 2011

GSM Conducted RF Emission Test Data cont'd

Figure 1-29a: Occupied Bandwidth, GSM850 Band, Low Channel in EDGE mode

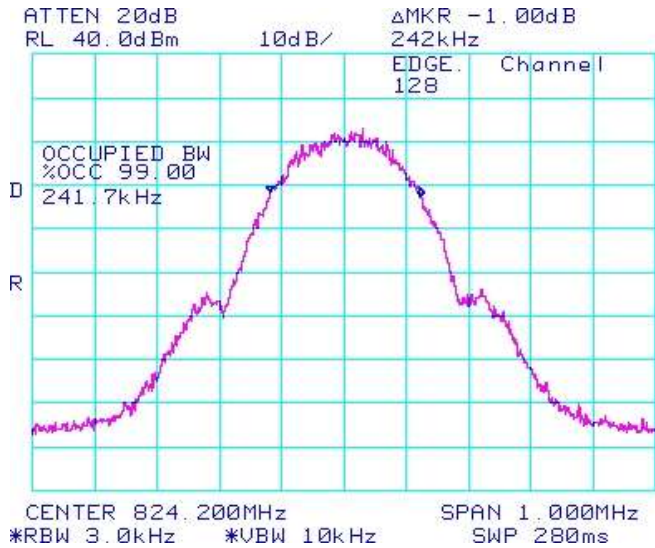

Figure 1-30a: Occupied Bandwidth, GSM850 Band, Middle Channel in EDGE mode

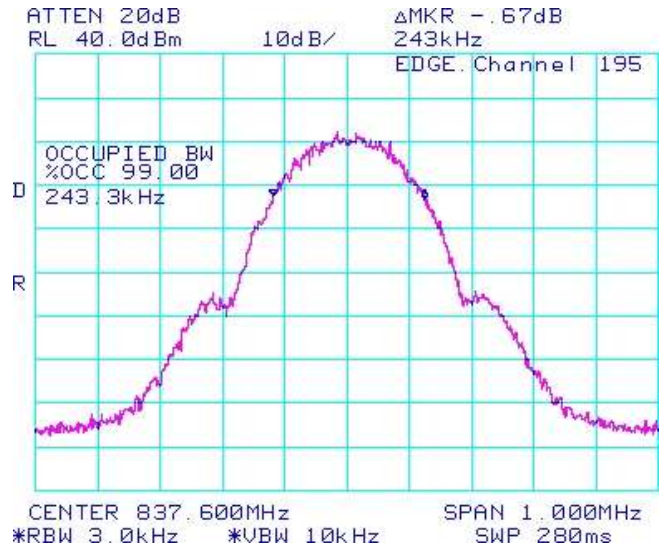

Figure 1-31a: Occupied Bandwidth, GSM850 band, High Channel in EDGE mode

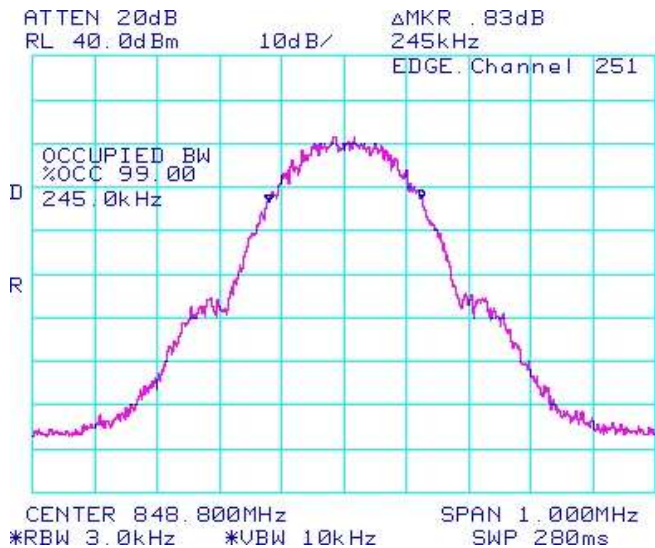
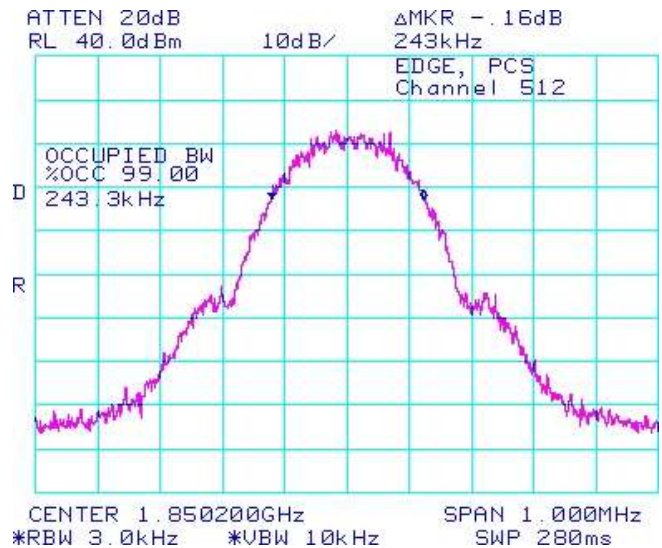



Figure 1-32a: Occupied Bandwidth, PCS1900 Band, Low Channel in EDGE mode



	EMI Test Report for the BlackBerry® smartphone Model RDM71UW, RDN71UW	
	APPENDIX 1A	
Test Report No. RTS-3640-1102-33A_rev1	Dates of Test January 11 to March 11 & 29 and May 24, 2011	FCC ID: L6ARDM70UW IC: 2503A-RDM70UW FCC ID: L6ARDN70UW IC: 2503A-RDN70UW

GSM Conducted RF Emission Test Data cont'd

Figure 1-33a: Occupied Bandwidth, PCS1900 Band, Middle Channel in EDGE mode

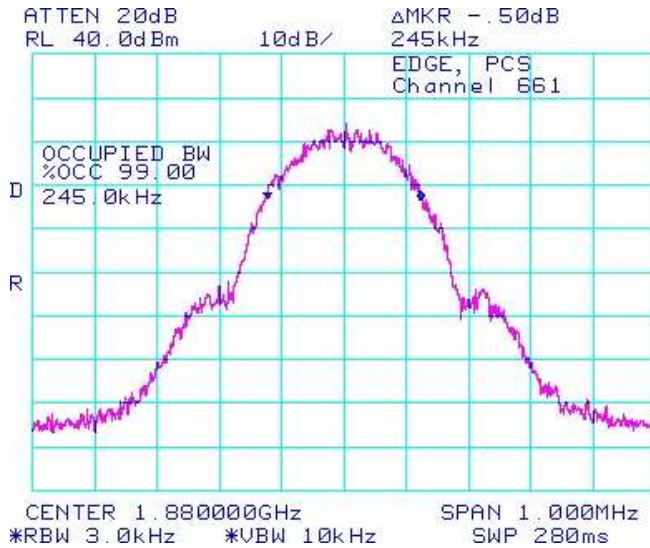

Figure 1-34a: Occupied Bandwidth, PCS1900 Band, High Channel in EDGE mode

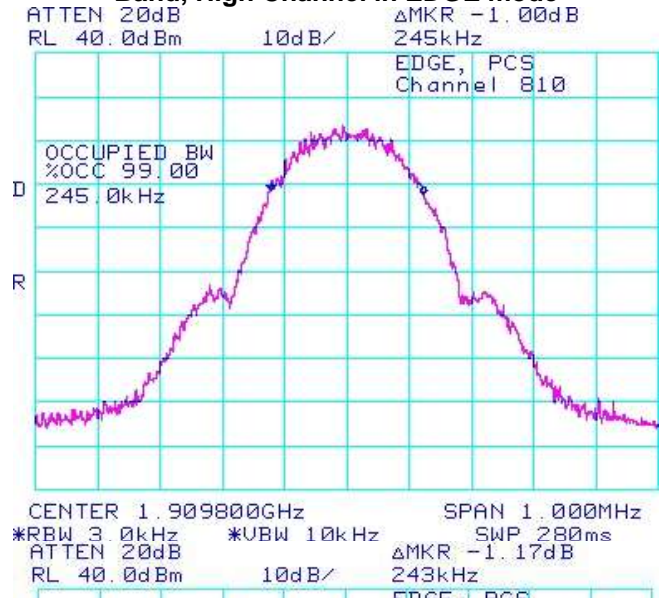

Figure 1-35a: GSM850 Band, Low Channel Mask in EDGE mode

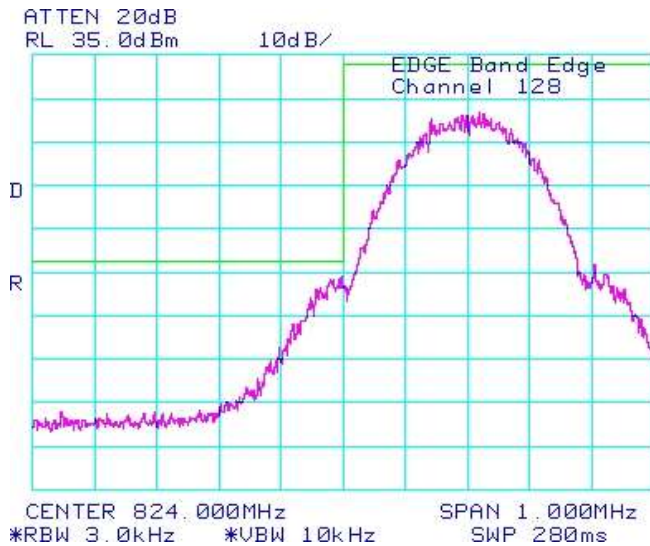
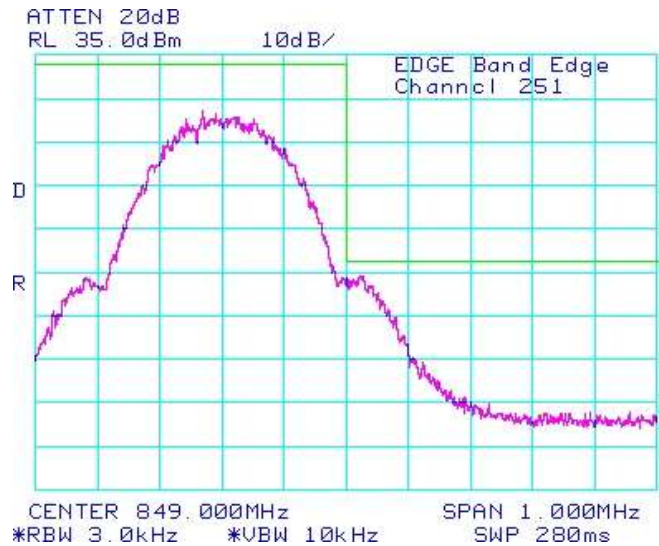



Figure 1-36a: GSM850 Band, High Channel Mask in EDGE mode



	EMI Test Report for the BlackBerry® smartphone Model RDM71UW, RDN71UW APPENDIX 1A	
	Test Report No. RTS-3640-1102-33A_rev1	Dates of Test January 11 to March 11 & 29 and May 24, 2011

GSM Conducted RF Emission Test Data cont'd

Figure 1-37a: PCS1900 Band, Low Channel Mask in EDGE mode

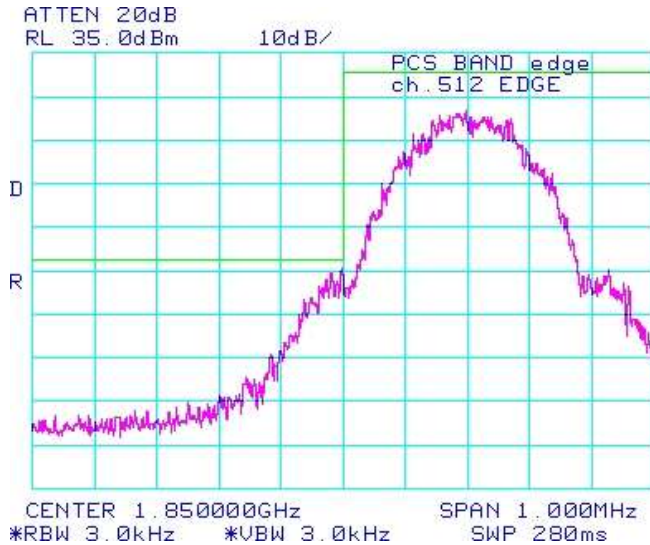
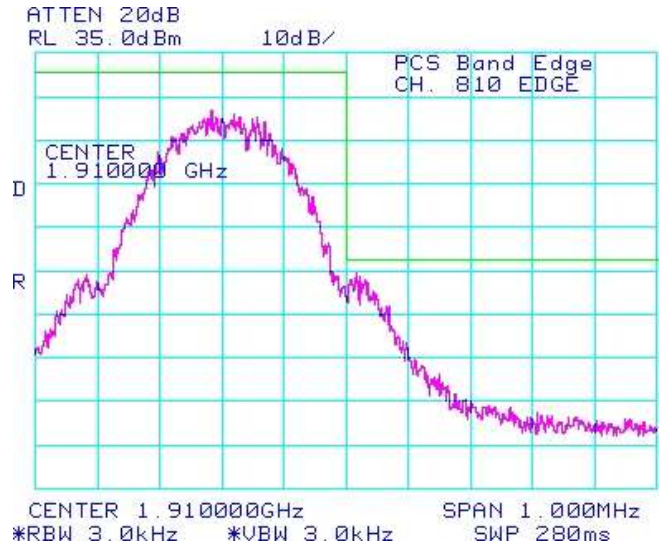



Figure 1-38a: PCS1900 Band, High Channel Mask in EDGE mode



	EMI Test Report for the BlackBerry® smartphone Model RDM71UW, RDN71UW APPENDIX 1A	
	Test Report No. RTS-3640-1102-33A_rev1	Dates of Test January 11 to March 11 & 29 and May 24, 2011

GSM Conducted RF Emission Test Data cont'd

Figure 1-39a: GSM850 band, Spurious Conducted Emissions, Low channel in Edge Mode

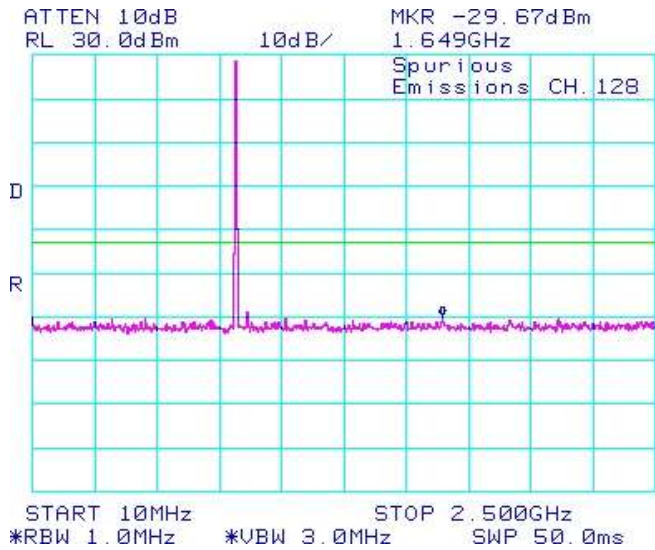

Figure 1-40a: GSM850 band, Spurious Conducted Emissions, Low channel in Edge Mode

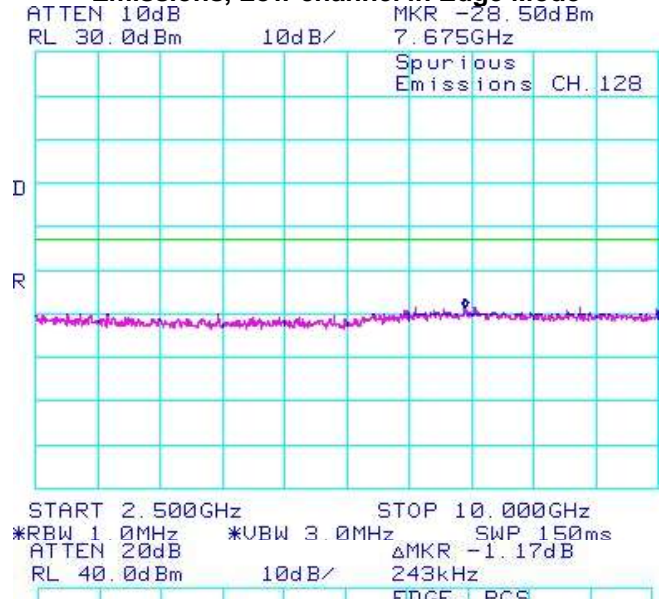

Figure 1-41a: GSM850 band, Spurious Conducted Emissions, Middle channel in Edge Mode

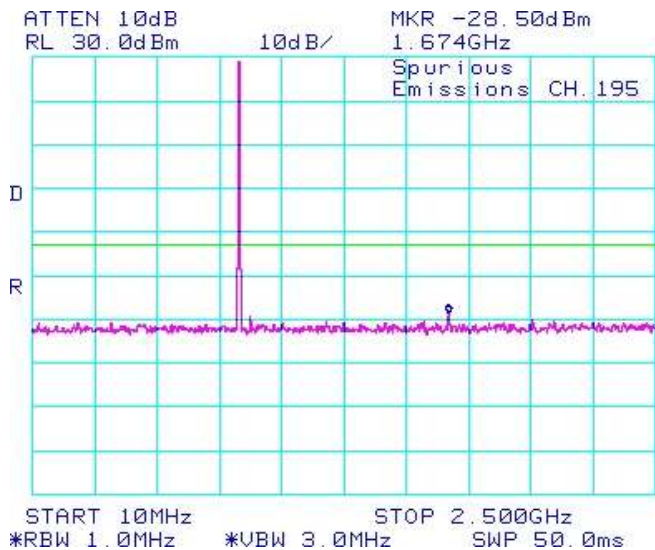
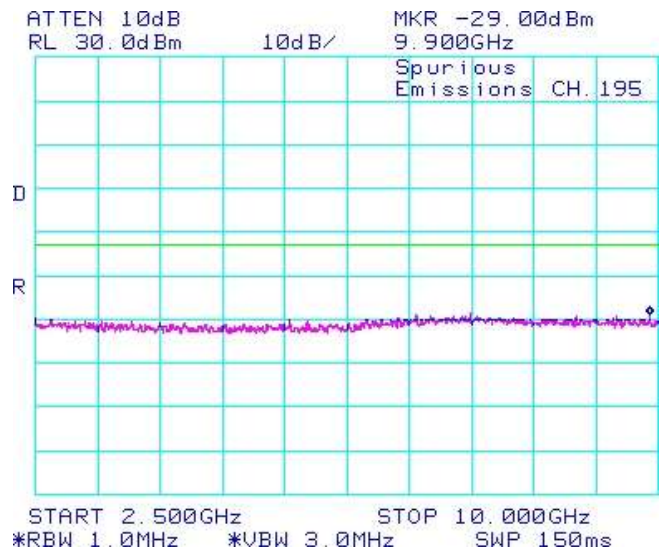



Figure 1-42a: GSM850 band, Spurious Conducted Emissions, Middle channel in Edge Mode



	EMI Test Report for the BlackBerry® smartphone Model RDM71UW, RDN71UW APPENDIX 1A	
	Test Report No. RTS-3640-1102-33A_rev1	Dates of Test January 11 to March 11 & 29 and May 24, 2011

GSM Conducted RF Emission Test Data cont'd

Figure 1-43a: GSM850 band, Spurious Conducted Emissions, High channel in Edge Mode

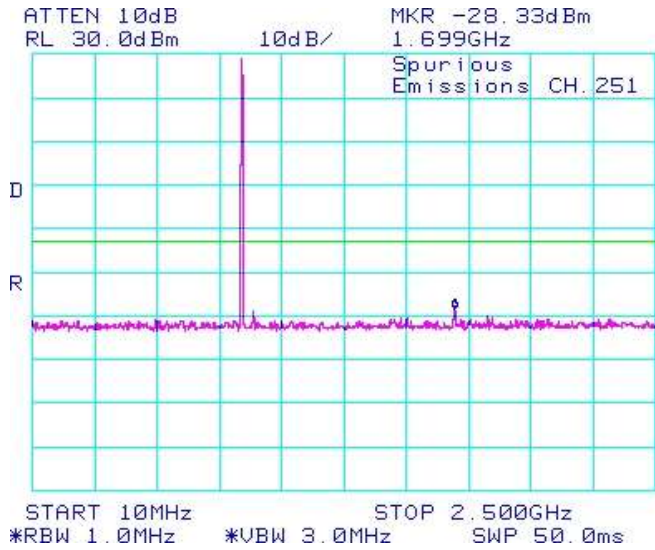

Figure 1-44a: GSM850 band, Spurious Conducted Emissions, High channel in Edge Mode

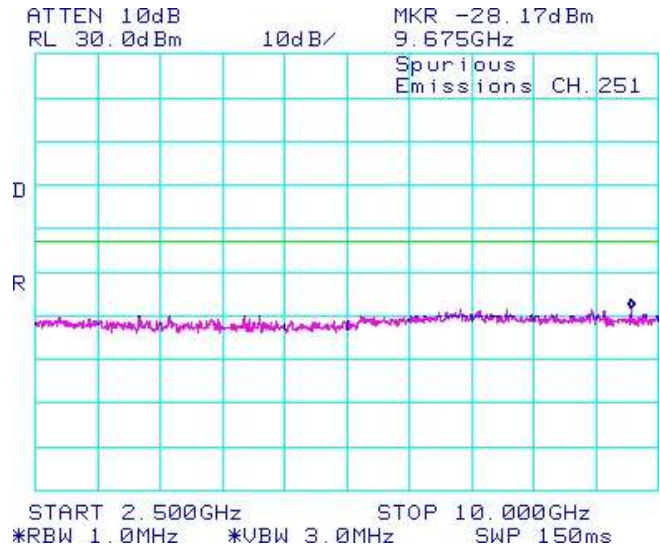

Figure 1-45a: PCS1900 band, Spurious Conducted Emissions, Low channel in Edge Mode

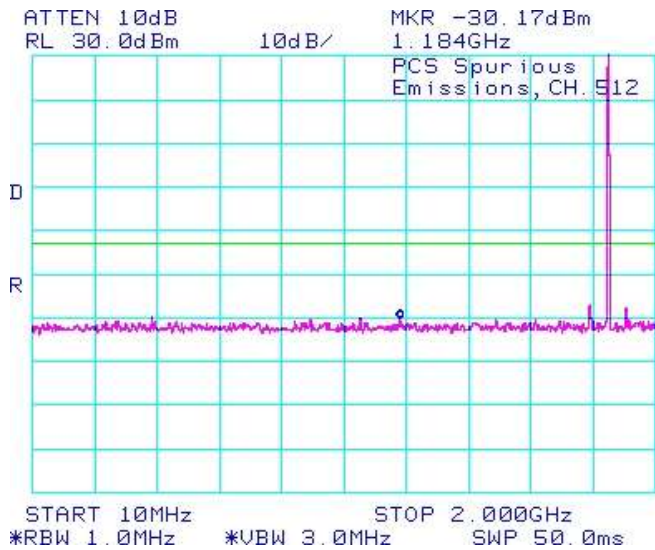
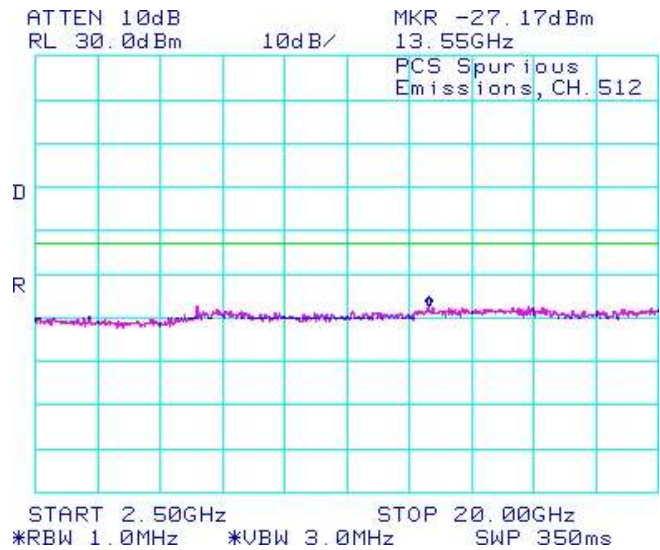



Figure 1-46a: PCS1900 band, Spurious Conducted Emissions, Low channel in Edge Mode



	EMI Test Report for the BlackBerry® smartphone Model RDM71UW, RDN71UW APPENDIX 1A	
	Test Report No. RTS-3640-1102-33A_rev1	Dates of Test January 11 to March 11 & 29 and May 24, 2011

GSM Conducted RF Emission Test Data cont'd

Figure 1-47a: PCS1900 band, Spurious Conducted Emissions, Low channel in Edge Mode

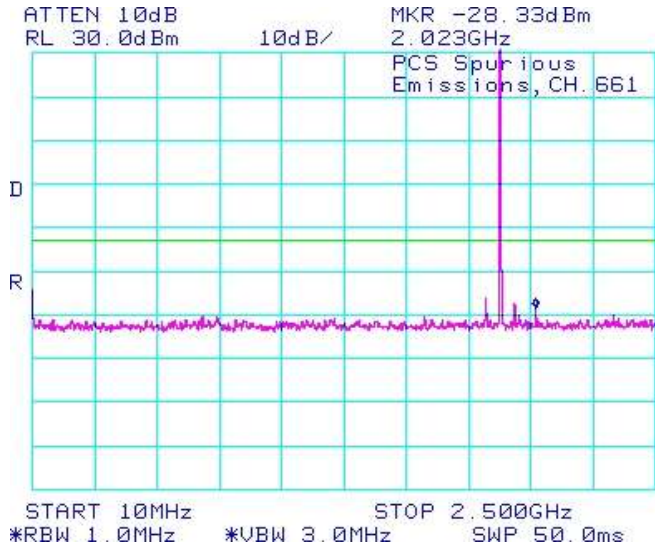

Figure 1-48a: PCS1900 band, Spurious Conducted Emissions, Low channel in Edge Mode

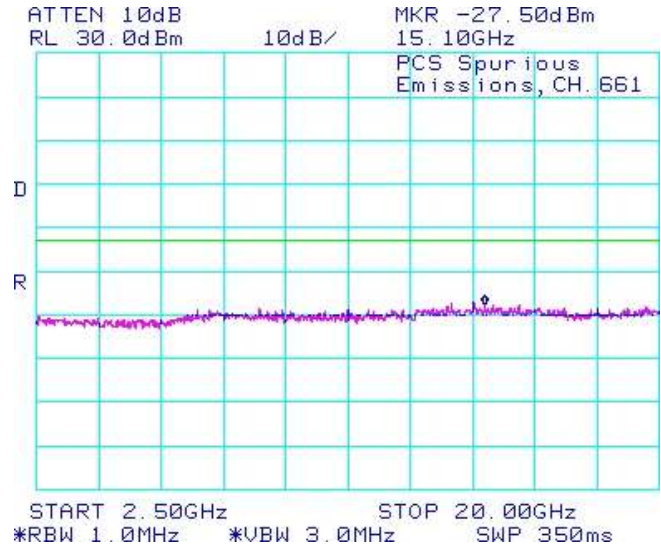

Figure 1-49a: PCS1900 band, Spurious Conducted Emissions, High channel in Edge Mode

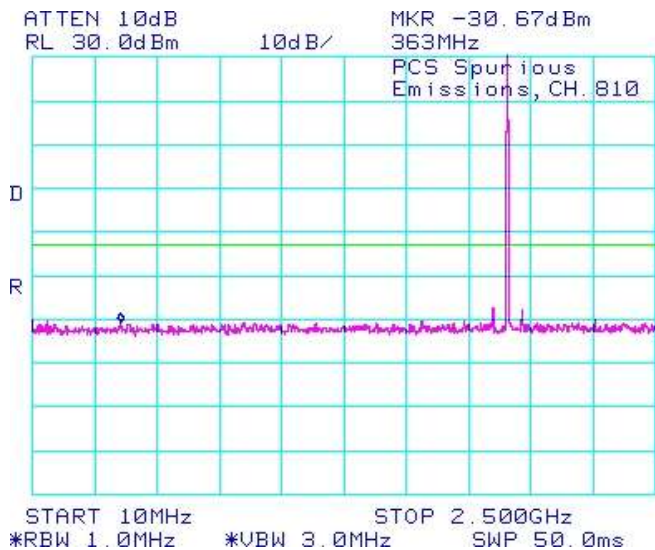
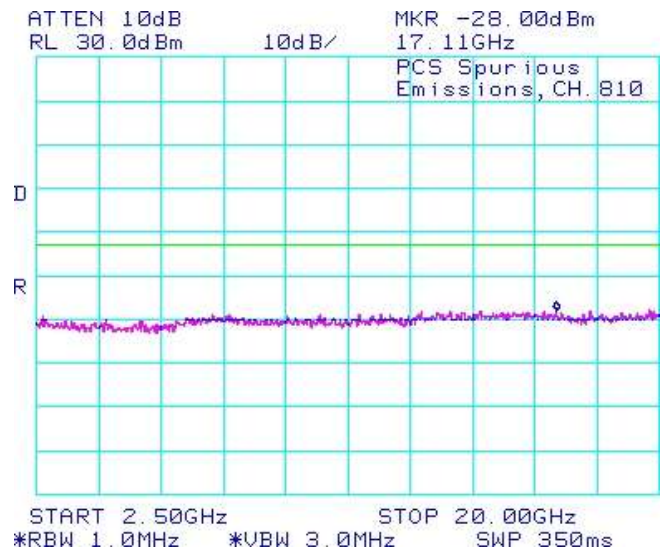



Figure 1-50a: PCS1900 band, Spurious Conducted Emissions, High channel in Edge Mode



APPENDIX 1B – UMTS CONDUCTED RF EMISSIONS TEST DATA/PLOTS

	EMI Test Report for the BlackBerry® smartphone Model RDM71UW, RDN71UW APPENDIX 1B	
	Test Report No. RTS-3640-1102-33A_rev1	Dates of Test January 11 to March 11 & 29 and May 24, 2011

UMTS Conducted RF Emission Test Data

This appendix contains measurement data pertaining to conducted spurious emissions, -26 dBc bandwidth, 99% power bandwidth and the channel mask.

Test Setup Diagram

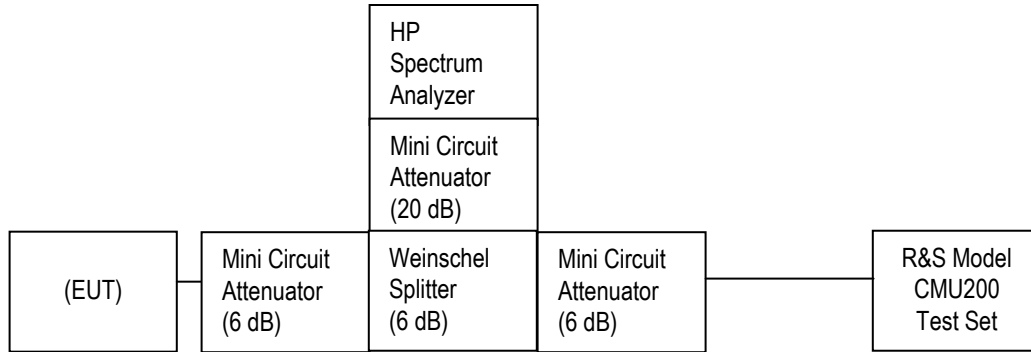

The environmental test conditions were: Temperature: 22.8 °C
Relative Humidity: 34 %

	EMI Test Report for the BlackBerry® smartphone Model RDM71UW, RDN71UW APPENDIX 1B	
	Test Report No. RTS-3640-1102-33A_rev1	Dates of Test January 11 to March 11 & 29 and May 24, 2011

UMTS Conducted RF Emission Test Data cont'd

The following results are for RDM71UW

The conducted spurious emissions – As per 47 CFR 2.1051, CFR 24.238(a), CFR 4.202, CFR 22 Subpart H, RSS-132 and RSS - 133 were measured from 10 MHz to 20 GHz.

See figures 1-1b to 1-12b for the plots of the conducted spurious emissions.

Date of Test: Feb 10, 2011

Test Data for Band 5 and Band 2 selected Frequencies in Loopback mode

UMTS Band 5 Frequency (MHz)	-26 dBc Bandwidth (MHz)	99% Occupied Bandwidth (MHz)
826.400	4.558	4.125
836.400	4.633	4.183
846.600	4.575	4.117

UMTS Band 2 Frequency (MHz)	-26 dBc Bandwidth (MHz)	99% Occupied Bandwidth (MHz)
1852.400	4.642	4.175
1880.000	4.633	4.175
1907.600	4.625	4.158

Measurement Plots for band 2 and band 5 in Loopback mode

Refer to the following measurement plots for more detail.

See Figures 1-13b to 1-18b for the plots of the 99% Occupied Bandwidth.

See Figures 1-19b to 1-22b for plots of the Channel Mask.

See Figures 1-23b to 1-28b for plots of the -26 dBc Bandwidth.

The RF power output was at maximum for all the recorded measurements shown below.

	EMI Test Report for the BlackBerry® smartphone Model RDM71UW, RDN71UW APPENDIX 1B	
	Test Report No. RTS-3640-1102-33A_rev1	Dates of Test January 11 to March 11 & 29 and May 24, 2011

UMTS Conducted RF Emission Test Data cont'd

Figure 1-1b: UMTS band 5, Spurious Conducted Emissions, Low channel

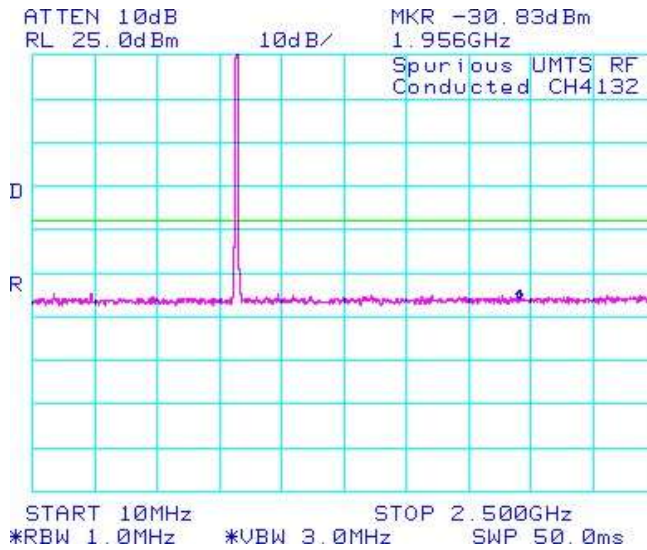

Figure 1-2b: UMTS band 5, Spurious Conducted Emissions, Low channel

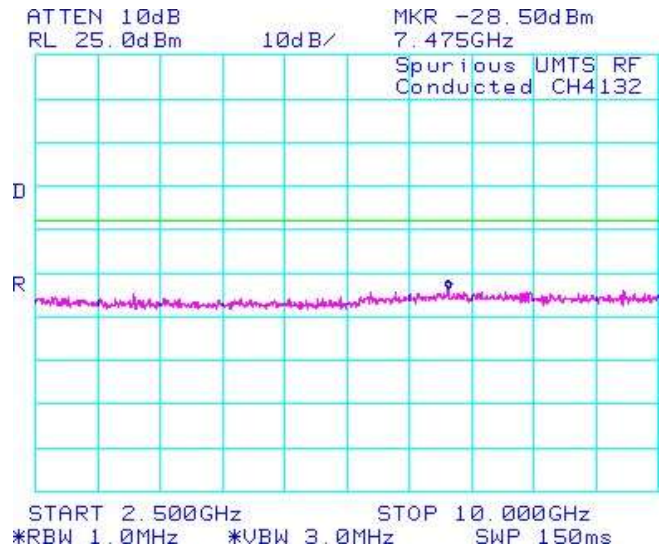

Figure 1-3b: UMTS band 5, Spurious Conducted Emissions, Middle channel

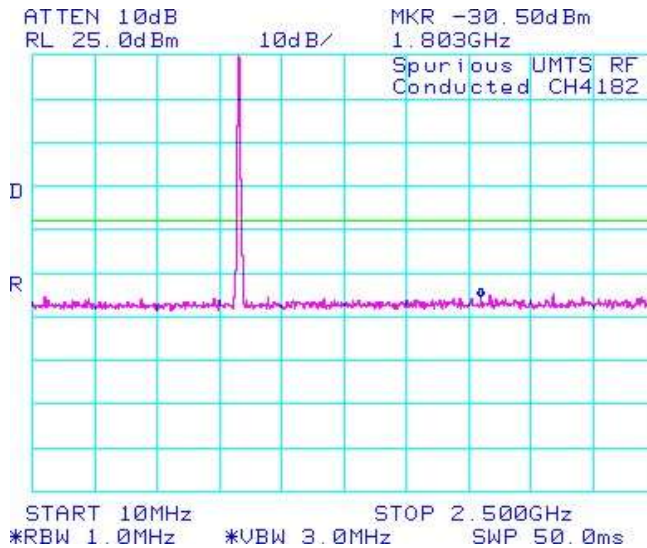
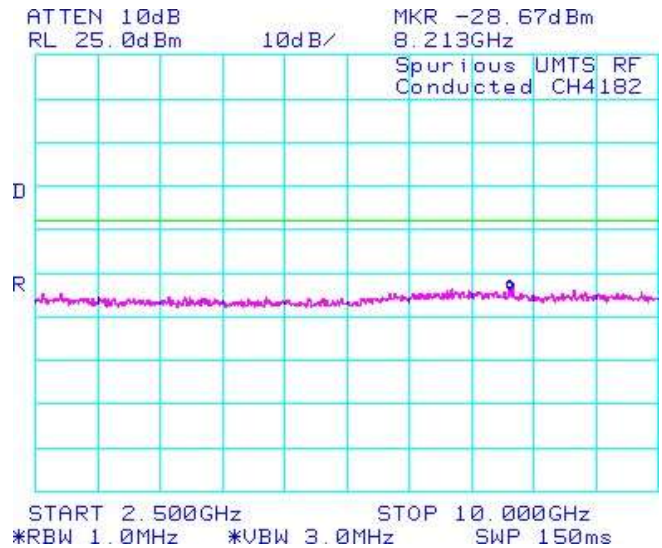



Figure 1-4b: UMTS band 5, Spurious Conducted Emissions, Middle channel



	EMI Test Report for the BlackBerry® smartphone Model RDM71UW, RDN71UW APPENDIX 1B	
	Test Report No. RTS-3640-1102-33A_rev1	Dates of Test January 11 to March 11 & 29 and May 24, 2011

UMTS Conducted RF Emission Test Data cont'd

Figure 7-5b: UMTS band 5, Spurious Conducted Emissions, High Channel

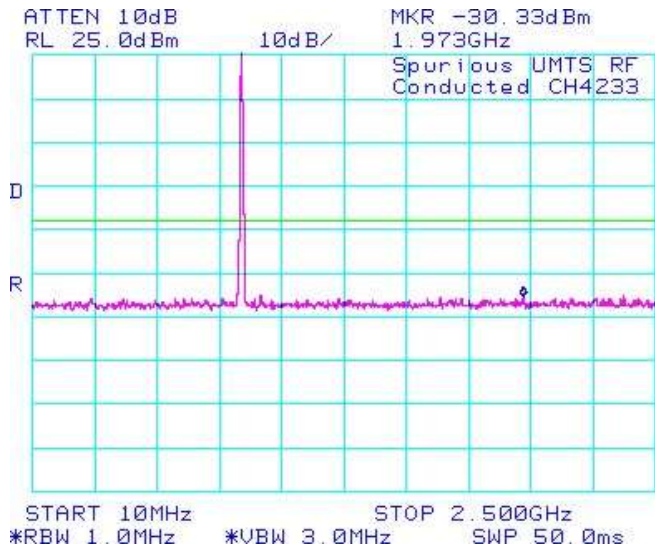

Figure 1-6b: UMTS band 5, Spurious Conducted Emissions, High Channel

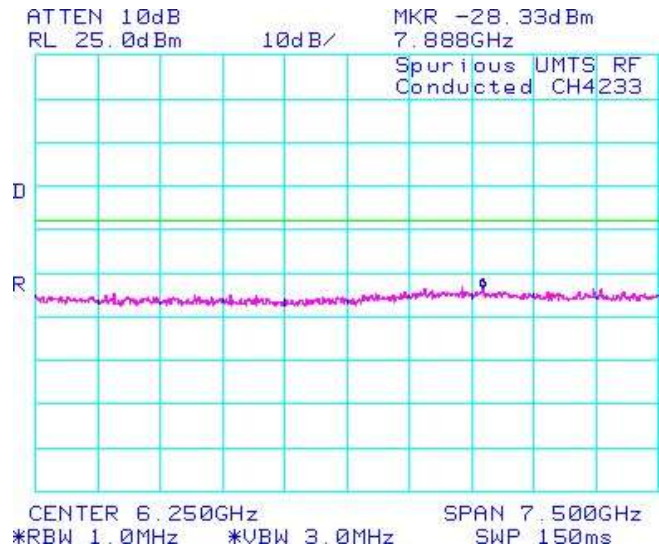

Figure 1-7b: UMTS band 2, Spurious Conducted Emissions, Low Channel

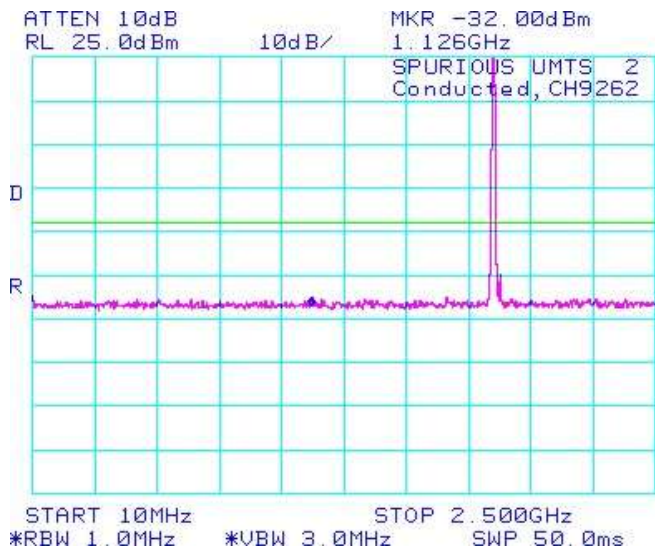
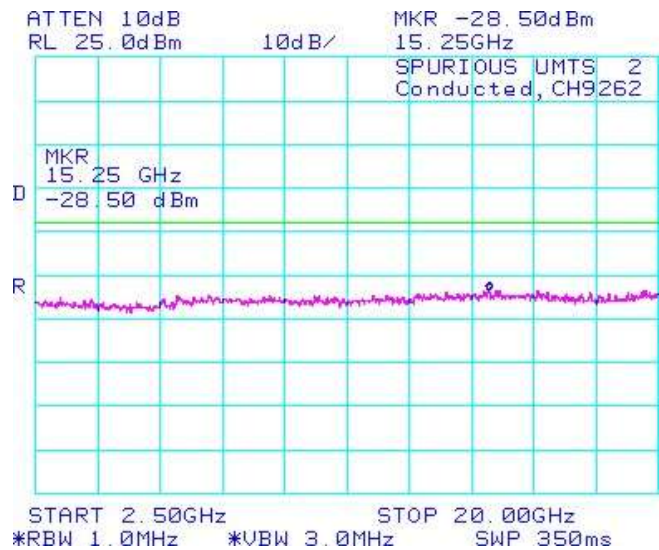

Figure 1-8b: UMTS band 2, Spurious Conducted Emissions, Low Channel



UMTS Conducted RF Emission Test Data cont'd

Figure 8-9b: UMTS band 2, Spurious Conducted Emissions, Middle Channel

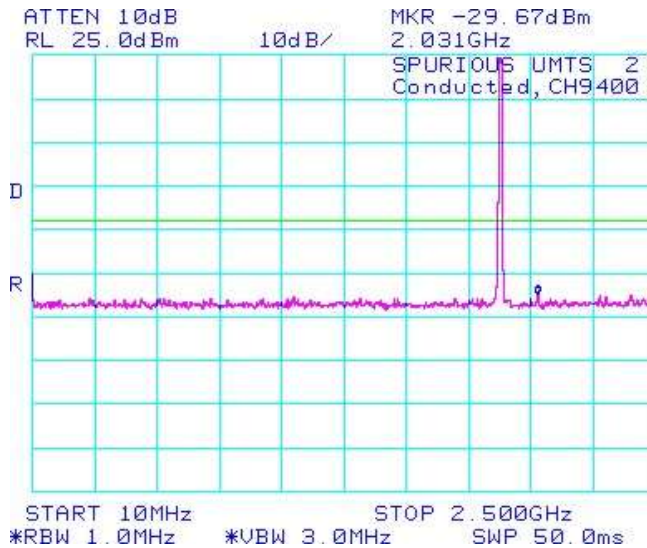

Figure 1-10b: UMTS band 2, Spurious Conducted Emissions, Middle Channel

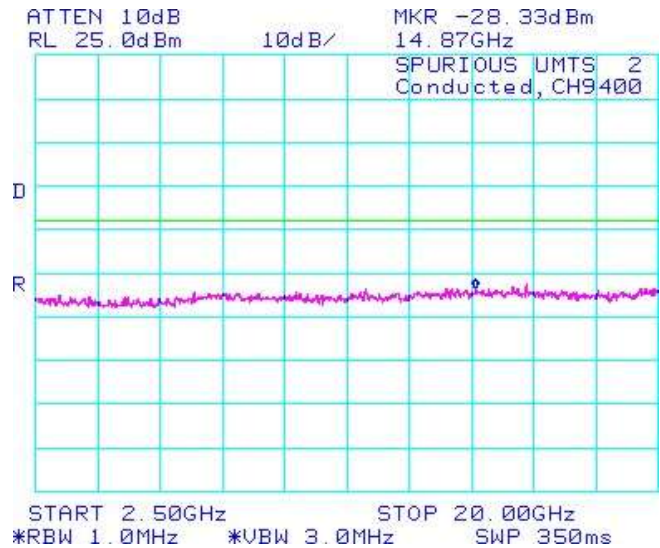

Figure 1-11b: UMTS band 2, Spurious Conducted Emissions, High Channel

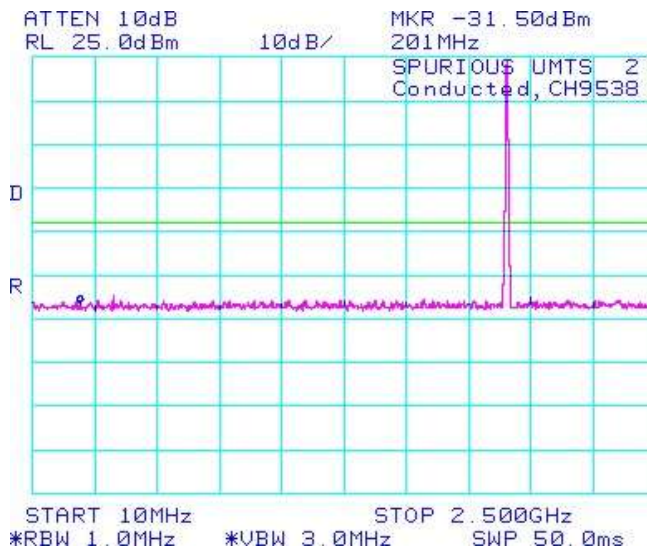
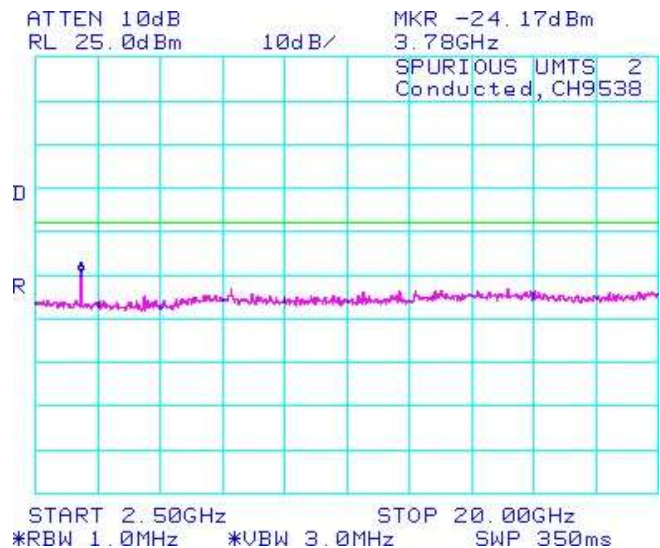

Figure 1-12b: UMTS band 2, Spurious Conducted Emissions, High Channel



UMTS Conducted RF Emission Test Data cont'd

Figure 10-21b: UMTS band 2 Low Channel Mask

Figure 1-22b: UMTS band 2 High Channel Mask

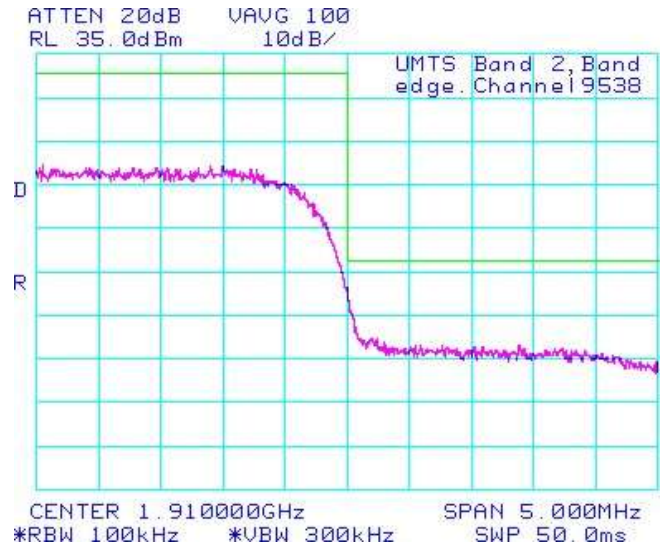
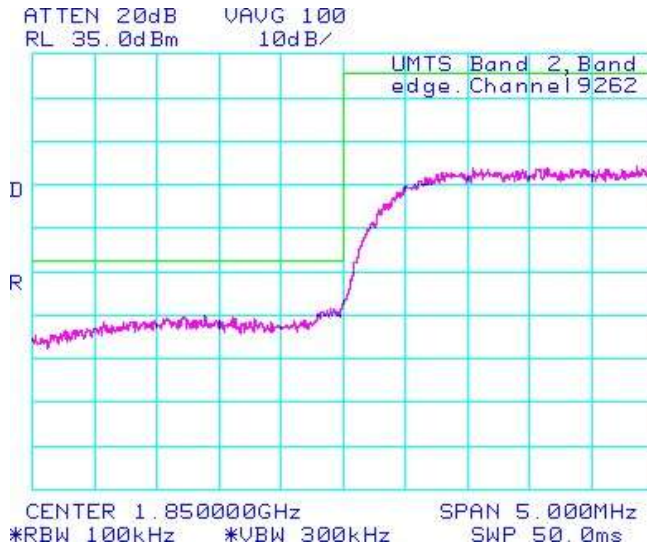
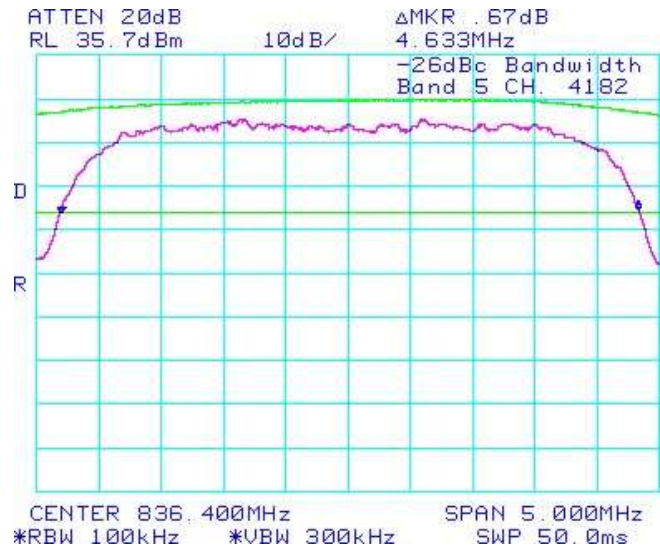
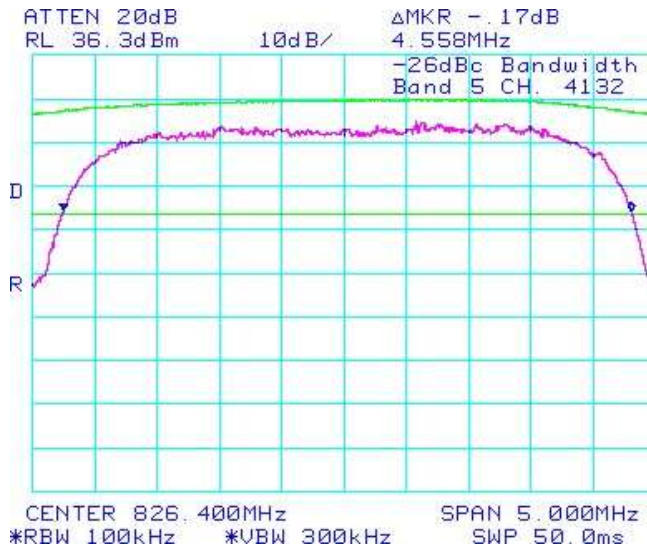



Figure 1-23b: UMTS band 5 -26 dBc Bandwidth Low Channel;

Figure 1-24b: UMTS band 5 -26 dBc Bandwidth Middle Channel



	EMI Test Report for the BlackBerry® smartphone Model RDM71UW, RDN71UW APPENDIX 1B	
	Test Report No. RTS-3640-1102-33A_rev1	Dates of Test January 11 to March 11 & 29 and May 24, 2011

UMTS Conducted RF Emission Test Data cont'd

Figure 1-25b: UMTS band 5 -26 dBc Bandwidth High Channel

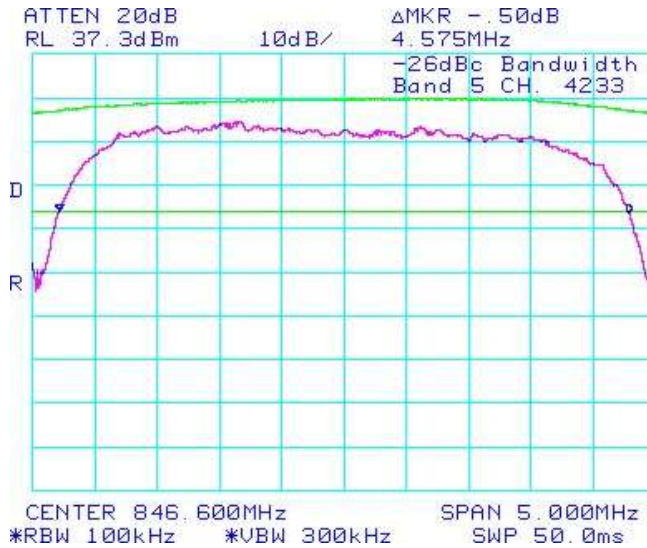

Figure 1-26b: UMTS band 2 -26 dBc Bandwidth Low Channel

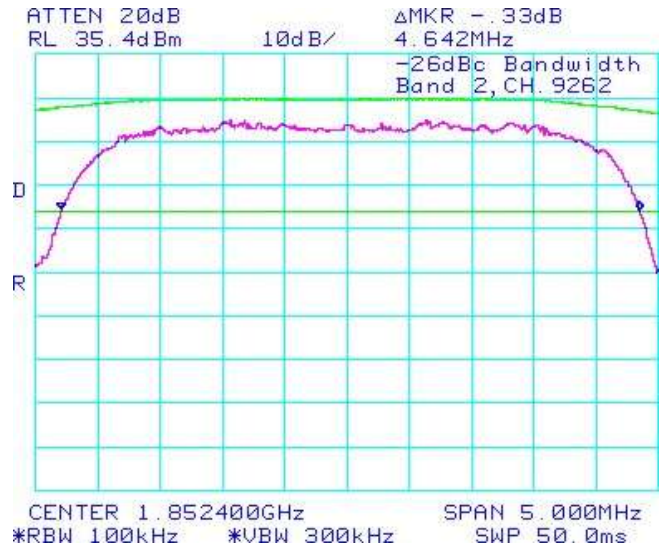

Figure 1-27b: UMTS band 5 -26 dBc Bandwidth Middle Channel

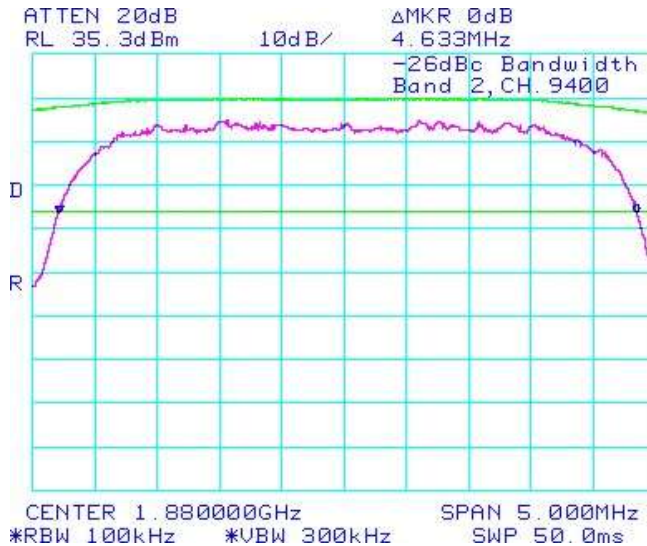
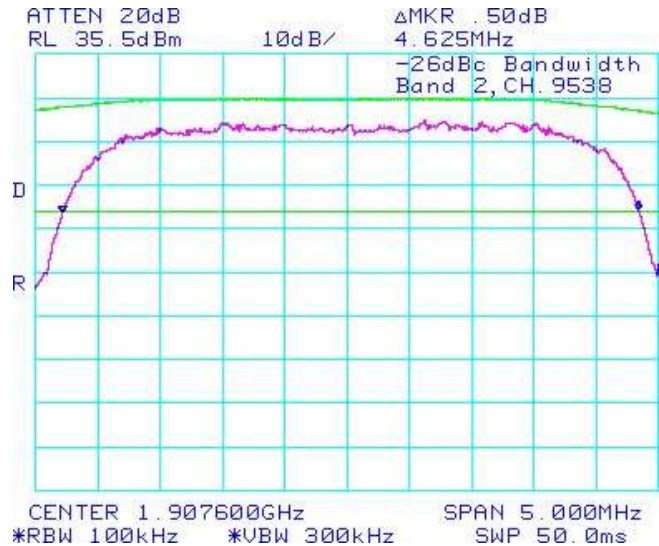



Figure 1-28b: UMTS band 5 -26 dBc Bandwidth High Channel



	EMI Test Report for the BlackBerry® smartphone Model RDM71UW, RDN71UW APPENDIX 1B	
	Test Report No. RTS-3640-1102-33A_rev1	Dates of Test January 11 to March 11 & 29 and May 24, 2011

UMTS Conducted RF Emission Test Data cont'd

The conducted spurious emissions – As per 47 CFR 2.1051, CFR 24.238(a), CFR 4.202, CFR 22 Subpart H, RSS-132 and RSS - 133 were measured from 10 MHz to 20 GHz.

See figures 1-29b to 1-40b for the plots of the conducted spurious emissions.

Date of Test: Feb 11, 2011

The environmental test conditions were: Temperature: 24 °C
Relative Humidity: 31.1 %

Test Data for band 2 and band 5 selected Frequencies in HSUPA mode

Band 5 Frequency (MHz)	99% Occupied Bandwidth (MHz)
826.400	4.133
836.400	4.183
846.600	4.125

Band 2 Frequency (MHz)	99% Occupied Bandwidth (MHz)
1852.400	4.175
1880.000	4.175
1907.600	4.175

Measurement Plots for band 2 and band 5 in HSUPA mode

Refer to the following measurement plots for more detail.

See Figures 1-41b to 1-46b for the plots of the 99% Occupied Bandwidth.

See Figures 1-47b to 1-50b for plots of the Channel Mask.

The RF power output was at maximum for all the recorded measurements shown below.

UMTS Conducted RF Emission Test Data cont'd

Figure 1-29b: UMTS band 5, Spurious Conducted Emissions, Low channel

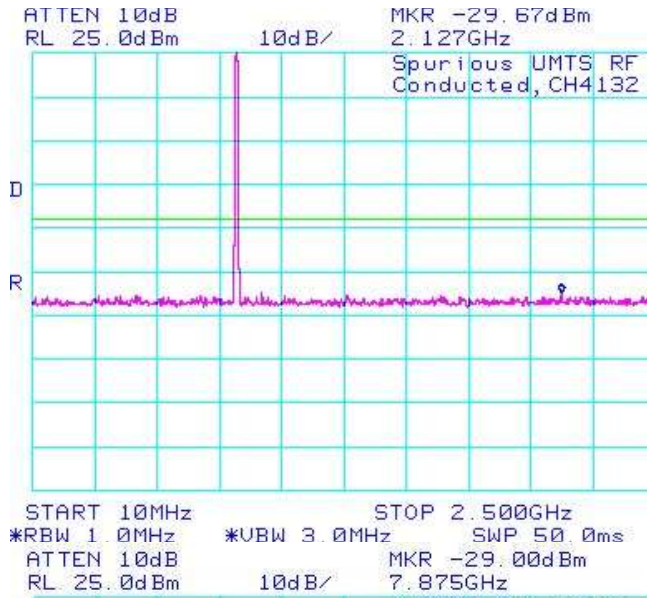

Figure 1-30b: UMTS band 5, Spurious Conducted Emissions, Low channel

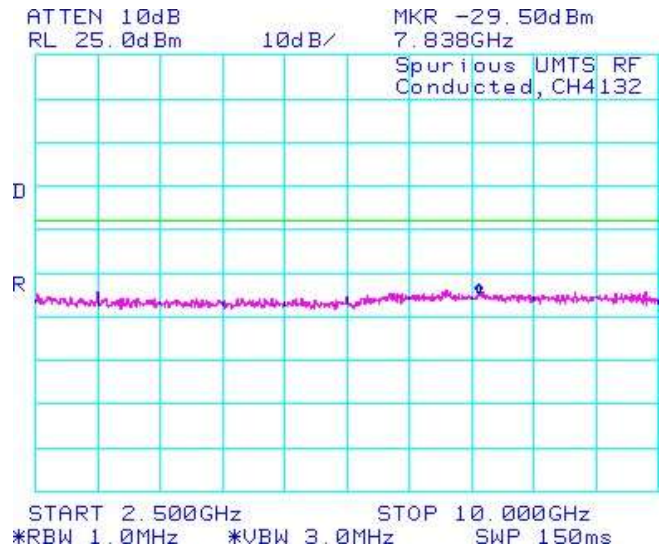

Figure 1-31b: UMTS band 5, Spurious Conducted Emissions, Middle channel

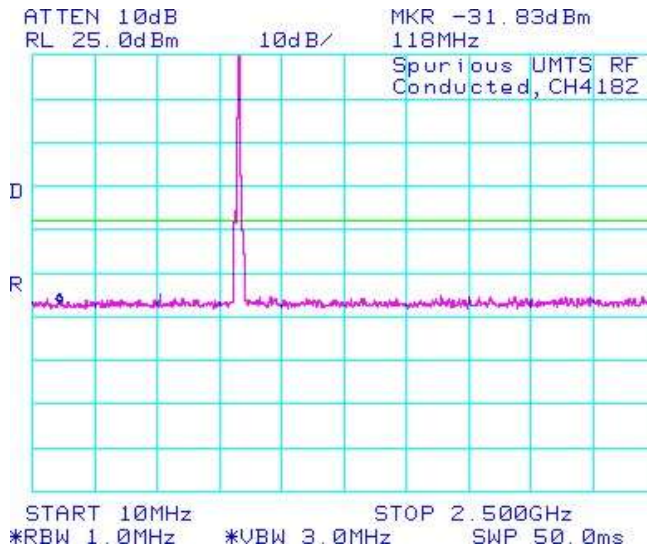
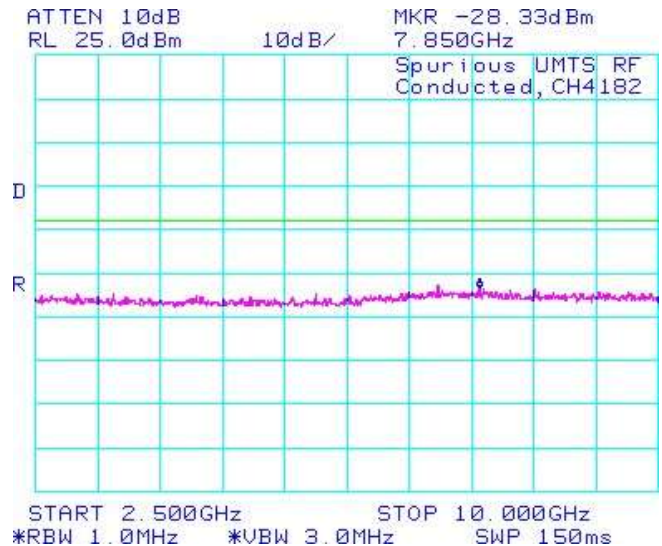



Figure 1-32b: UMTS band 5, Spurious Conducted Emissions, Middle channel



	EMI Test Report for the BlackBerry® smartphone Model RDM71UW, RDN71UW APPENDIX 1B	
	Test Report No. RTS-3640-1102-33A_rev1	Dates of Test January 11 to March 11 & 29 and May 24, 2011

UMTS Conducted RF Emission Test Data cont'd

Figure 11-33b: UMTS band 5, Spurious Conducted Emissions, High Channel

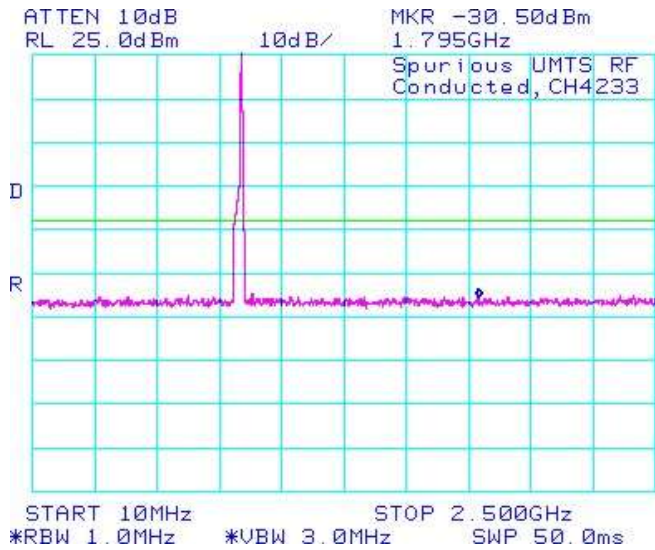

Figure 1-34b: UMTS band 5, Spurious Conducted Emissions, High Channel

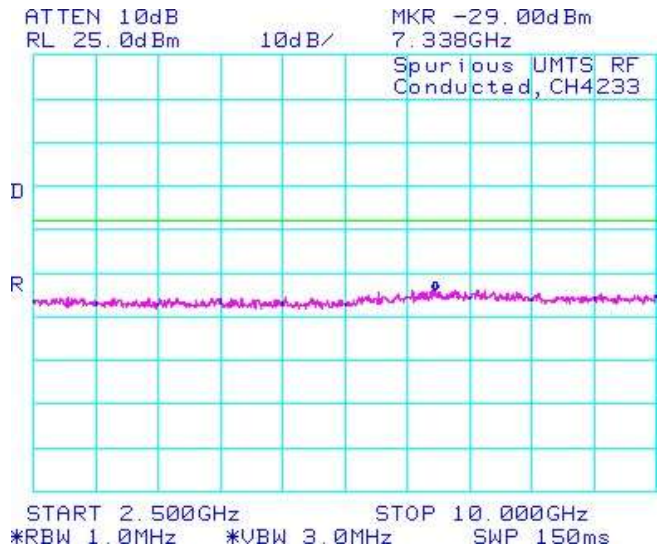

Figure 1-35b: UMTS band 2, Spurious Conducted Emissions, Low Channel

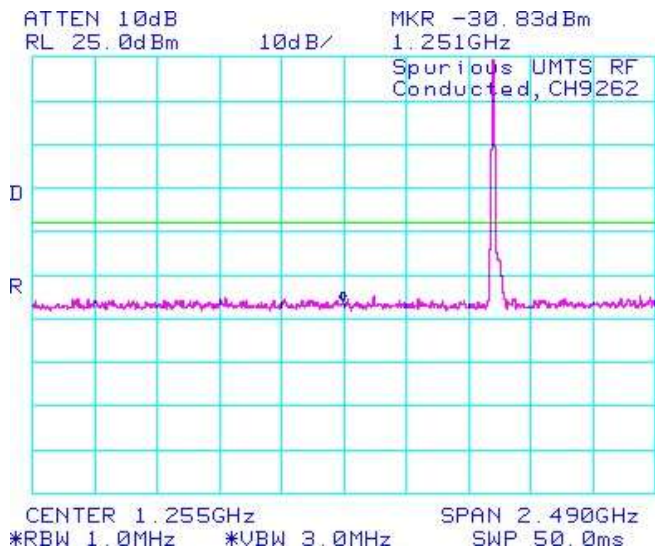
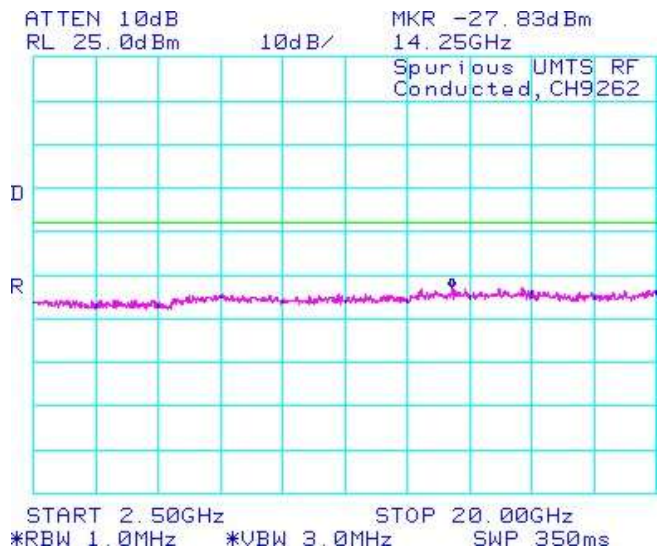



Figure 1-36b: UMTS band 2, Spurious Conducted Emissions, Low Channel



	EMI Test Report for the BlackBerry® smartphone Model RDM71UW, RDN71UW APPENDIX 1B	
	Test Report No. RTS-3640-1102-33A_rev1	Dates of Test January 11 to March 11 & 29 and May 24, 2011

UMTS Conducted RF Emission Test Data cont'd

Figure 1-37b: UMTS band 2, Spurious Conducted Emissions, Middle Channel

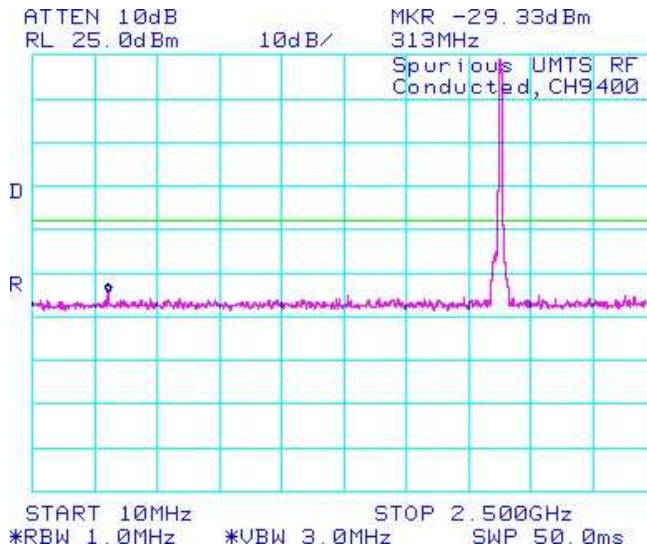

Figure 1-38b: UMTS band 2, Spurious Conducted Emissions, Middle Channel

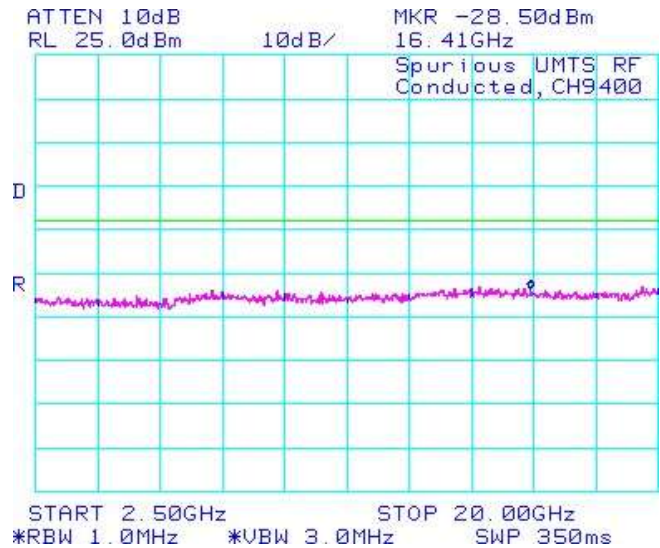

Figure 1-39b: UMTS band 2, Spurious Conducted Emissions, High Channel

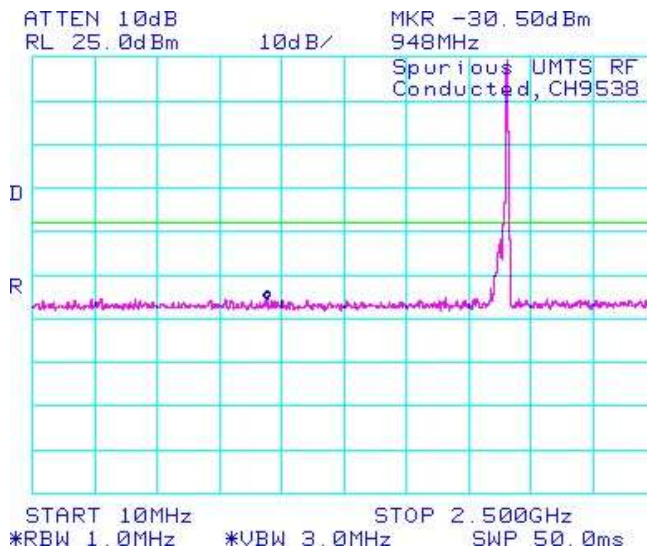
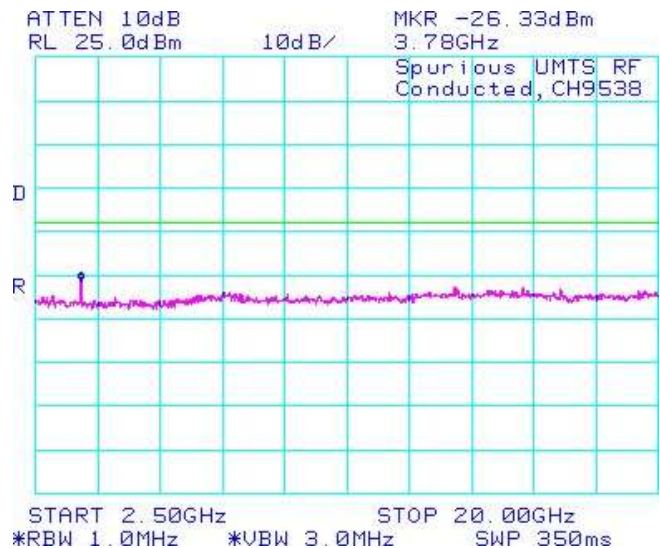



Figure 1-40b: UMTS band 2, Spurious Conducted Emissions, High Channel



	EMI Test Report for the BlackBerry® smartphone Model RDM71UW, RDN71UW APPENDIX 1B	
	Test Report No. RTS-3640-1102-33A_rev1	Dates of Test January 11 to March 11 & 29 and May 24, 2011

UMTS Conducted RF Emission Test Data cont'd

Figure 1-41b: Occupied Bandwidth, UMTS band 5 Low Channel

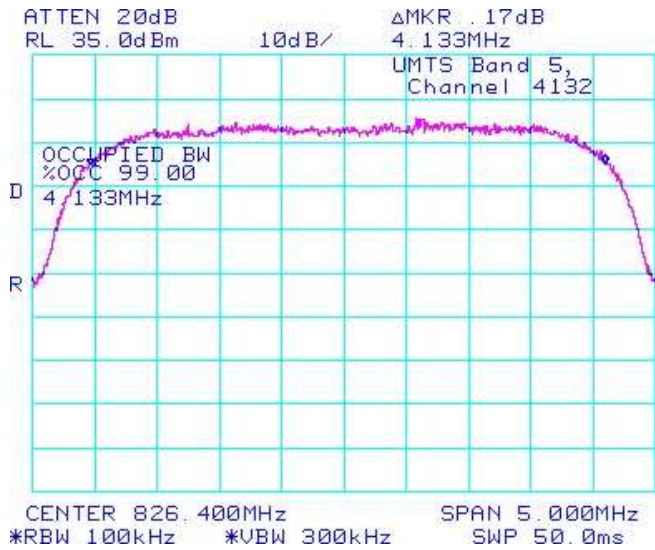

Figure 1-42b: Occupied Bandwidth, UMTS band 5 Middle Channel

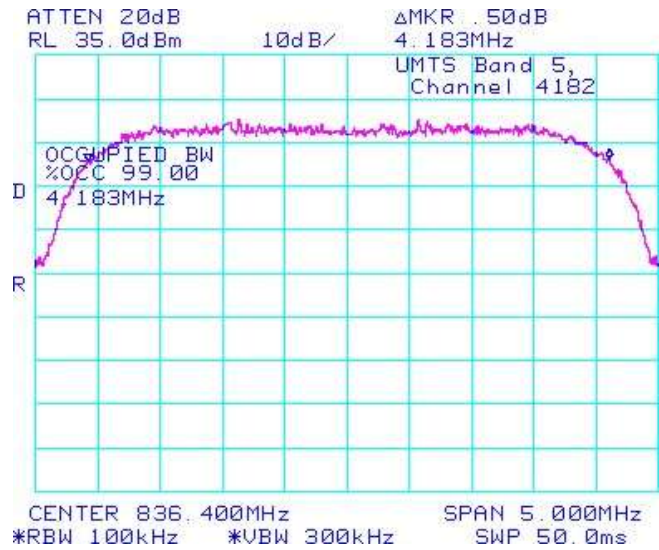

Figure 1-43b: Occupied Bandwidth, UMTS band 5 High Channel

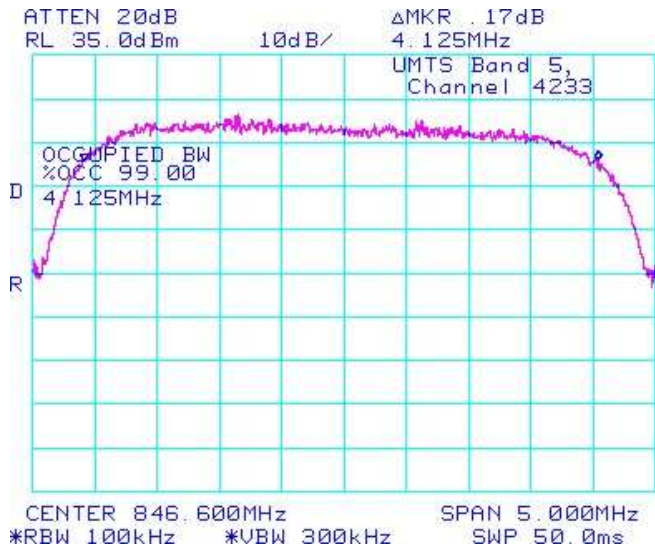
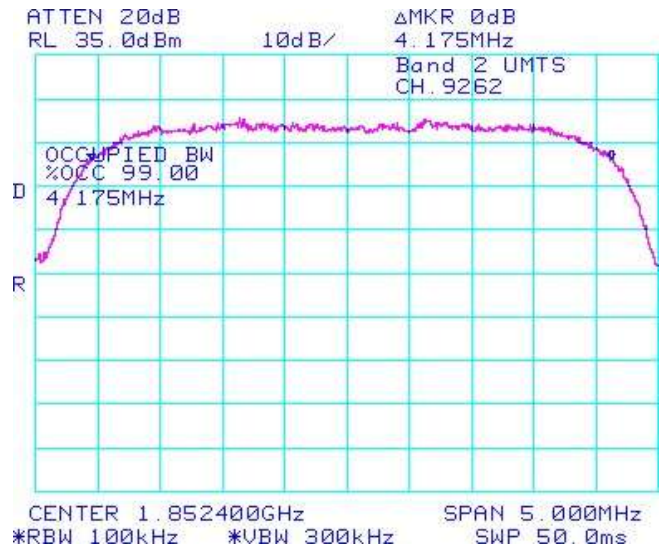



Figure 1-44b: Occupied Bandwidth, UMTS band 2 Low Channel



	EMI Test Report for the BlackBerry® smartphone Model RDM71UW, RDN71UW APPENDIX 1B	
	Test Report No. RTS-3640-1102-33A_rev1	Dates of Test January 11 to March 11 & 29 and May 24, 2011

UMTS Conducted RF Emission Test Data cont'd

Figure 1-49b: UMTS band 2, Low Channel Mask

Figure 1-50b: UMTS band 2, High Channel Mask

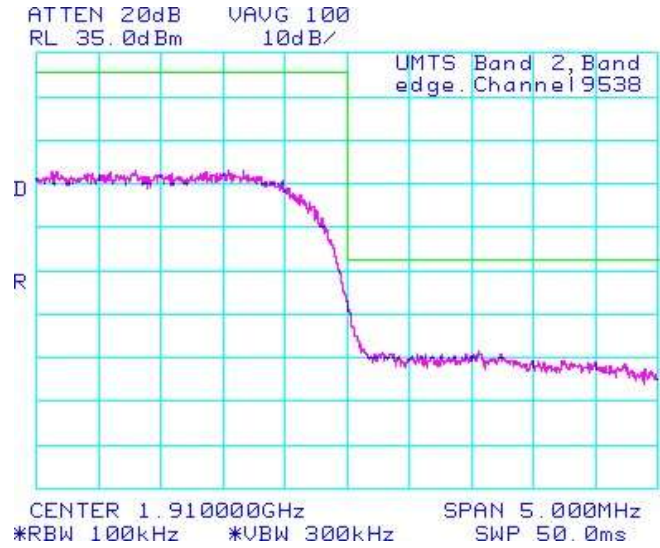
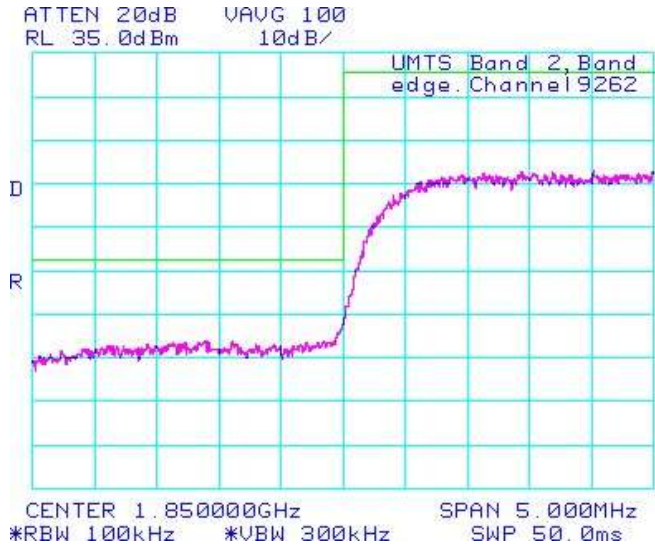

APPENDIX 2A – GSM CONDUCTED RF OUTPUT POWER TEST DATA

APPENDIX 2B – UMTS CONDUCTED RF OUTPUT POWER TEST DATA

APPENDIX 3A – GSM FREQUENCY STABILITY TEST DATA

	EMI Test Report for the BlackBerry® smartphone Model RDM71UW, RDN71UW APPENDIX 3A	
Test Report No. RTS-3640-1102-33A_rev1	Dates of Test January 11 to March 11 & 29 and May 24, 2011	FCC ID: L6ARDM70UW IC: 2503A-RDM70UW FCC ID: L6ARDN70UW IC: 2503A-RDN70UW

GSM Frequency Stability Test Data

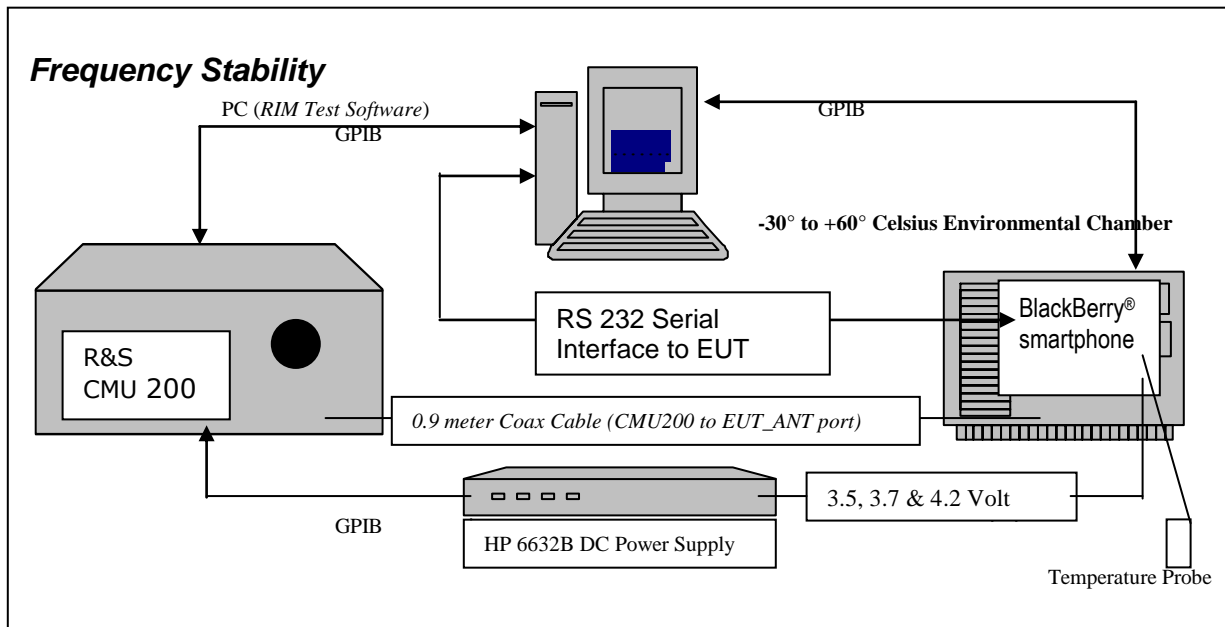

The measurements were performed by Maurice Battler.

CFR 47 Chapter 1 - Federal Communications Commission Rules

Part 2 Required Measurements

- 2.995 Frequency Stability - Procedures
- (a,b) Frequency Stability - Temperature Variation
- (d) Frequency Stability - Voltage Variation

24.235 Frequency Stability.

The frequency stability shall be sufficient to ensure that the fundamental emission stays within the authorized frequency block.

The EUT meets the requirements as stated in CFR 47 chapter 1, Section 24.235, CFR 47 chapter 1, Section 22.917 and RSS-132, 4.3 Frequency Stability.

Frequency Stability measurement devices were configured as presented in the block diagram recording frequency, power, data, temperatures, and stepped voltages controlled via a GPIB interface linked to the Environmental chamber, a DC power supply, and the Communications Test Set. A 0.9-metre coax cable was calibrated to characterize the insertion loss for the transmitted frequencies between the RF input/output of the CMU 200 and the EUT antenna port.

Calibration for the Cable Loss was performed in the RF Laboratory using the Agilent power meter and Agilent Signal Generator.

The cable assembly from the RF input to the RF output was measured at the following Frequencies:

	EMI Test Report for the BlackBerry® smartphone Model RDM71UW, RDN71UW APPENDIX 3A	
Test Report No. RTS-3640-1102-33A_rev1	Dates of Test January 11 to March 11 & 29 and May 24, 2011	FCC ID: L6ARDM70UW IC: 2503A-RDM70UW FCC ID: L6ARDN70UW IC: 2503A-RDN70UW

Procedure:

The EUT was placed in the Temperature chamber and connected to CMU 200 outside as shown in the figure above. Dry air was pumped inside the temperature chamber to maintain a backpressure during the test. The EUT was kept in the off condition at all times except when the measurements were to be made.

The chamber was switched on and the temperature was set to -30°C. After the chamber stabilized at -30 °C there was a soak period of one hour to alleviate moisture in the chamber, the EUT voltage was enabled. The system software recorded the frequency, power, and associated measurements.

A Computer system controlled the automated software. This application was given the command of activating all machines intrinsic to the temperature and voltage tests controlling the CMU 200 via the GPIB Bus. The Environmental Chamber was instructed through an RS-232 serial line. The EUT dialogue was passed through a serial connection.

The EUT repetitively transmitted 100 bursts for each set of programmed parameters recording temperature, voltage settings, and systematically selected frequencies. The power supply was cycled from minimum voltage 3.6 volts, to 3.7 volts to 4.2 volts maximum voltage. The frequency error was measured at a maximum output power and recorded by the automated system test software.

The EUT output power and frequency was measured at 3.6 volts, 3.7 volts and 4.2 volts. The transmit frequency was varied in 3 steps consisting of 824.2, 836.4, and 848.8 MHz for the GSM850 band, 1850.2, 1880.0 and 1909.8 MHz for the PCS1900 band. This frequency was recorded in MHz and deviation from nominal, in Parts Per Million. After the initial one-hour soak at the beginning of the tests, a period of thirty minutes soak was initialized between each ascending temperature step, before proceeding to the next measurement test cycle.

	EMI Test Report for the BlackBerry® smartphone Model RDM71UW, RDN71UW APPENDIX 3A	
	Test Report No. RTS-3640-1102-33A_rev1	Dates of Test January 11 to March 11 & 29 and May 24, 2011

PROCEDURE:

The test system software for commencing the Frequency Stability Tests carried through the following cycle.

1. Switch on the HP 6632B power supply; CMU 200 Communications test Set, and Environmental Chamber.
2. Start test program
3. Set the Temperature to -30°C and maintain a period of one- hour soak time, with the EUT supply voltage disabled.
4. Set power supply voltage to 3.6 volts.
5. Set up CMU 200 Radio Communication Tester.
6. Command the CMU 200 to switch to the low channel.
7. Enable the voltage to the EUT, and connect a link to the CMU 200 test set.
8. EUT is commanded to Transmit 100 Bursts.
9. Software logs the following data from the CMU 200, power supply and temperature chamber: Traffic Channel Number, Traffic Channel Frequency, Power Level, Chamber Temperature, Supply Voltage, Power and Frequency Error.
10. The CMU 200 commands the EUT to change frequency to the middle channel and high channel and repeats steps 7 to 9.
11. Repeat steps 5 to 10 changing the supply voltage to 3.7 Volts
12. Increase temperature by 10°C and soak for 1/2 hour.
13. Repeat steps 4 - 12 for temperatures -30°C to 60°C .
14. Repeat steps 5 to 10 changing the supply voltage to 4.2 volts

Procedure 5 to 10 was repeated at room temperature (20°C) with the power supply voltage set to 3.6, 3.7 and 4.2 volts.

The following results are for RDM71UW

The maximum frequency error in the GSM850 band measured was **-0.0463 PPM**.
The maximum frequency error in the PCS1900 band measured was **0.0450 PPM**.

	EMI Test Report for the BlackBerry® smartphone Model RDM71UW, RDN71UW APPENDIX 3A	
	Test Report No. RTS-3640-1102-33A_rev1	Dates of Test January 11 to March 11 & 29 and May 24, 2011

GSM850 Channel results: channels 128, 189 and 250 @ 20°C maximum transmitted power

Traffic Channel Number	GSM850 Frequency (MHz)	Voltage (Volts)	Temperature (Celsius)	Frequency Error (Hz)	PPM
128	824.20	3.6	20	9.49	0.0115
189	836.40	3.6	20	8.72	0.0104
250	848.60	3.6	20	4.84	0.0057

Traffic Channel Number	GSM850 Frequency (MHz)	Voltage (Volts)	Temperature (Celsius)	Frequency Error (Hz)	PPM
128	824.20	3.7	20	-12.59	-0.0153
189	836.40	3.7	20	-9.30	-0.0111
250	848.60	3.7	20	-8.27	-0.0097

Traffic Channel Number	GSM850 Frequency (MHz)	Voltage (Volts)	Temperature (Celsius)	Frequency Error (Hz)	PPM
128	824.20	4.2	20	-21.24	-0.0258
189	836.40	4.2	20	-8.27	-0.0099
250	848.60	4.2	20	-5.42	-0.0064

	EMI Test Report for the BlackBerry® smartphone Model RDM71UW, RDN71UW APPENDIX 3A	
	Test Report No. RTS-3640-1102-33A_rev1	Dates of Test January 11 to March 11 & 29 and May 24, 2011 FCC ID: L6ARDM70UW IC: 2503A-RDM70UW FCC ID: L6ARDN70UW IC: 2503A-RDN70UW

GSM850 Results: channel 128 @ maximum transmitted power

Traffic Channel Number	Frequency (MHz)	Voltage (Volts)	Temperature (Celsius)	Frequency Error (Hz)	PPM
128	824.20	3.6	-30	-16.98	-0.0206
128	824.20	3.6	-20	15.37	0.0186
128	824.20	3.6	-10	28.61	0.0347
128	824.20	3.6	0	20.28	0.0246
128	824.20	3.6	10	9.62	0.0117
128	824.20	3.6	20	9.49	0.0115
128	824.20	3.6	30	13.95	0.0169
128	824.20	3.6	40	-13.75	-0.0167
128	824.20	3.6	50	-22.47	-0.0273
128	824.20	3.6	60	-35.32	-0.0429
Traffic Channel Number	Frequency (MHz)	Voltage (Volts)	Temperature (Celsius)	Frequency Error (Hz)	PPM
128	824.20	3.7	-30	5.55	0.0067
128	824.20	3.7	-20	14.21	0.0172
128	824.20	3.7	-10	23.89	0.0290
128	824.20	3.7	0	15.05	0.0183
128	824.20	3.7	10	8.01	0.0097
128	824.20	3.7	20	-12.59	-0.0153
128	824.20	3.7	30	-9.69	-0.0118
128	824.20	3.7	40	-9.81	-0.0119
128	824.20	3.7	50	-24.47	-0.0297
128	824.20	3.7	60	-23.63	-0.0287
Traffic Channel Number	Frequency (MHz)	Voltage (Volts)	Temperature (Celsius)	Frequency Error (Hz)	PPM
128	824.20	4.2	-30	15.11	0.0183
128	824.20	4.2	-20	5.23	0.0063
128	824.20	4.2	-10	19.18	0.0233
128	824.20	4.2	0	-8.01	-0.0097
128	824.20	4.2	10	-16.79	-0.0204
128	824.20	4.2	20	-21.24	-0.0258
128	824.20	4.2	30	-24.02	-0.0291
128	824.20	4.2	40	-16.34	-0.0198
128	824.20	4.2	50	20.28	0.0246
128	824.20	4.2	60	37.45	0.0454

	EMI Test Report for the BlackBerry® smartphone Model RDM71UW, RDN71UW APPENDIX 3A	
	Test Report No. RTS-3640-1102-33A_rev1	Dates of Test January 11 to March 11 & 29 and May 24, 2011 FCC ID: L6ARDM70UW IC: 2503A-RDM70UW FCC ID: L6ARDN70UW IC: 2503A-RDN70UW

GSM850 Results: channel 189 @ maximum transmitted power

Traffic Channel Number	Frequency (MHz)	Voltage (Volts)	Temperature (Celsius)	Frequency Error (Hz)	PPM
189	836.40	3.6	-30	-19.95	-0.0239
189	836.40	3.6	-20	17.05	0.0204
189	836.40	3.6	-10	31.45	0.0376
189	836.40	3.6	0	26.09	0.0312
189	836.40	3.6	10	6.46	0.0077
189	836.40	3.6	20	8.72	0.0104
189	836.40	3.6	30	8.78	0.0105
189	836.40	3.6	40	-10.78	-0.0129
189	836.40	3.6	50	-29.64	-0.0354
189	836.40	3.6	60	-37.00	-0.0442
Traffic Channel Number	Frequency (MHz)	Voltage (Volts)	Temperature (Celsius)	Frequency Error (Hz)	PPM
189	836.40	3.7	-30	-5.23	-0.0063
189	836.40	3.7	-20	16.59	0.0198
189	836.40	3.7	-10	23.96	0.0286
189	836.40	3.7	0	16.40	0.0196
189	836.40	3.7	10	6.13	0.0073
189	836.40	3.7	20	-9.30	-0.0111
189	836.40	3.7	30	-10.33	-0.0124
189	836.40	3.7	40	-13.95	-0.0167
189	836.40	3.7	50	-28.48	-0.0341
189	836.40	3.7	60	-15.11	-0.0181
Traffic Channel Number	Frequency (MHz)	Voltage (Volts)	Temperature (Celsius)	Frequency Error (Hz)	PPM
189	836.40	4.2	-30	14.79	0.0177
189	836.40	4.2	-20	5.68	0.0068
189	836.40	4.2	-10	23.89	0.0286
189	836.40	4.2	0	8.72	0.0104
189	836.40	4.2	10	-7.17	-0.0086
189	836.40	4.2	20	-8.27	-0.0099
189	836.40	4.2	30	-11.17	-0.0134
189	836.40	4.2	40	-18.27	-0.0218
189	836.40	4.2	50	20.92	0.0250
189	836.40	4.2	60	22.86	0.0273

GSM850 Results: channel 251 @ maximum transmitted power

Traffic Channel Number	Frequency (MHz)	Voltage (Volts)	Temperature (Celsius)	Frequency Error (Hz)	PPM
251	848.8	3.6	-30	-10.98	-0.0129
251	848.8	3.6	-20	11.24	0.0132
251	848.8	3.6	-10	20.53	0.0242
251	848.8	3.6	0	15.17	0.0179
251	848.8	3.6	10	8.85	0.0104
251	848.8	3.6	20	4.84	0.0057
251	848.8	3.6	30	-12.20	-0.0144
251	848.8	3.6	40	-14.92	-0.0176
251	848.8	3.6	50	-36.68	-0.0432
251	848.8	3.6	60	-39.26	-0.0463
Traffic Channel Number	Frequency (MHz)	Voltage (Volts)	Temperature (Celsius)	Frequency Error (Hz)	PPM
251	848.8	3.7	-30	-5.49	-0.0065
251	848.8	3.7	-20	14.33	0.0169
251	848.8	3.7	-10	20.15	0.0237
251	848.8	3.7	0	21.63	0.0255
251	848.8	3.7	10	-7.30	-0.0086
251	848.8	3.7	20	-8.27	-0.0097
251	848.8	3.7	30	-13.17	-0.0155
251	848.8	3.7	40	-10.85	-0.0128
251	848.8	3.7	50	-18.79	-0.0221
251	848.8	3.7	60	-18.92	-0.0223
Traffic Channel Number	Frequency (MHz)	Voltage (Volts)	Temperature (Celsius)	Frequency Error (Hz)	PPM
251	848.8	4.2	-30	13.24	0.0156
251	848.8	4.2	-20	17.43	0.0205
251	848.8	4.2	-10	24.99	0.0294
251	848.8	4.2	0	8.98	0.0106
251	848.8	4.2	10	6.72	0.0079
251	848.8	4.2	20	-5.42	-0.0064
251	848.8	4.2	30	-14.33	-0.0169
251	848.8	4.2	40	-14.33	-0.0169
251	848.8	4.2	50	14.40	0.0170
251	848.8	4.2	60	10.72	0.0126

	EMI Test Report for the BlackBerry® smartphone Model RDM71UW, RDN71UW APPENDIX 3A	
	Test Report No. RTS-3640-1102-33A_rev1	Dates of Test January 11 to March 11 & 29 and May 24, 2011

PCS Channel results: channels 512, 661, & 810 @ 20°C maximum transmitted power

Traffic Channel Number	PCS Frequency (MHz)	Voltage (Volts)	Temperature (Celsius)	Frequency Error (Hz)	PPM
512	1850.20	3.6	20	40.16	0.0217
661	1880.00	3.6	20	44.75	0.0238
810	1909.80	3.6	20	49.40	0.0259
Traffic Channel Number	PCS Frequency (MHz)	Voltage (Volts)	Temperature (Celsius)	Frequency Error (Hz)	PPM
512	1850.20	3.7	20	23.12	0.0125
661	1880.00	3.7	20	24.28	0.0129
810	1909.80	3.7	20	33.13	0.0173
Traffic Channel Number	PCS Frequency (MHz)	Voltage (Volts)	Temperature (Celsius)	Frequency Error (Hz)	PPM
512	1850.20	4.2	20	7.88	0.0043
661	1880.00	4.2	20	6.52	0.0035
810	1909.80	4.2	20	19.31	0.0101

	EMI Test Report for the BlackBerry® smartphone Model RDM71UW, RDN71UW APPENDIX 3A	
	Test Report No. RTS-3640-1102-33A_rev1	Dates of Test January 11 to March 11 & 29 and May 24, 2011 FCC ID: L6ARDM70UW IC: 2503A-RDM70UW FCC ID: L6ARDN70UW IC: 2503A-RDN70UW

PCS1900 Results: channel 512 @ maximum transmitted power

Traffic Channel Number	Frequency (MHz)	Voltage (Volts)	Temperature (Celsius)	Frequency Error (Hz)	PPM
512	1850.20	3.6	-30	19.95	0.0108
512	1850.20	3.6	-20	31.83	0.0172
512	1850.20	3.6	-10	60.12	0.0325
512	1850.20	3.6	0	72.32	0.0391
512	1850.20	3.6	10	68.51	0.0370
512	1850.20	3.6	20	40.16	0.0217
512	1850.20	3.6	30	21.24	0.0115
512	1850.20	3.6	40	22.28	0.0120
512	1850.20	3.6	50	-12.91	-0.0070
512	1850.20	3.6	60	-22.34	-0.0121
Traffic Channel Number	Frequency (MHz)	Voltage (Volts)	Temperature (Celsius)	Frequency Error (Hz)	PPM
512	1850.20	3.7	-30	11.95	0.0065
512	1850.20	3.7	-20	20.15	0.0109
512	1850.20	3.7	-10	55.40	0.0299
512	1850.20	3.7	0	77.87	0.0421
512	1850.20	3.7	10	56.18	0.0304
512	1850.20	3.7	20	23.12	0.0125
512	1850.20	3.7	30	21.37	0.0116
512	1850.20	3.7	40	-11.11	-0.0060
512	1850.20	3.7	50	7.62	0.0041
512	1850.20	3.7	60	-22.99	-0.0124
Traffic Channel Number	Frequency (MHz)	Voltage (Volts)	Temperature (Celsius)	Frequency Error (Hz)	PPM
512	1850.20	4.2	-30	42.29	0.0229
512	1850.20	4.2	-20	29.64	0.0160
512	1850.20	4.2	-10	43.65	0.0236
512	1850.20	4.2	0	60.25	0.0326
512	1850.20	4.2	10	44.23	0.0239
512	1850.20	4.2	20	7.88	0.0043
512	1850.20	4.2	30	7.62	0.0041
512	1850.20	4.2	40	-12.85	-0.0069
512	1850.20	4.2	50	-10.85	-0.0059
512	1850.20	4.2	60	-32.03	-0.0173

	EMI Test Report for the BlackBerry® smartphone Model RDM71UW, RDN71UW APPENDIX 3A	
	Test Report No. RTS-3640-1102-33A_rev1	Dates of Test January 11 to March 11 & 29 and May 24, 2011 FCC ID: L6ARDM70UW IC: 2503A-RDM70UW FCC ID: L6ARDN70UW IC: 2503A-RDN70UW

PCS1900 Results: channel 661 @ maximum transmitted power

Traffic Channel Number	Frequency (MHz)	Voltage (Volts)	Temperature (Celsius)	Frequency Error (Hz)	PPM
661	1880.00	3.6	-30	22.66	0.0121
661	1880.00	3.6	-20	25.96	0.0138
661	1880.00	3.6	-10	50.75	0.0270
661	1880.00	3.6	0	81.30	0.0432
661	1880.00	3.6	10	61.80	0.0329
661	1880.00	3.6	20	44.75	0.0238
661	1880.00	3.6	30	31.19	0.0166
661	1880.00	3.6	40	14.59	0.0078
661	1880.00	3.6	50	-10.91	-0.0058
661	1880.00	3.6	60	-33.38	-0.0178
Traffic Channel Number	Frequency (MHz)	Voltage (Volts)	Temperature (Celsius)	Frequency Error (Hz)	PPM
661	1880.00	3.7	-30	27.06	0.0144
661	1880.00	3.7	-20	24.47	0.0130
661	1880.00	3.7	-10	58.82	0.0313
661	1880.00	3.7	0	83.56	0.0444
661	1880.00	3.7	10	61.92	0.0329
661	1880.00	3.7	20	24.28	0.0129
661	1880.00	3.7	30	18.98	0.0101
661	1880.00	3.7	40	14.72	0.0078
661	1880.00	3.7	50	-12.01	-0.0064
661	1880.00	3.7	60	-22.99	-0.0122
Traffic Channel Number	Frequency (MHz)	Voltage (Volts)	Temperature (Celsius)	Frequency Error (Hz)	PPM
661	1880.00	4.2	-30	41.71	0.0222
661	1880.00	4.2	-20	42.42	0.0226
661	1880.00	4.2	-10	55.34	0.0294
661	1880.00	4.2	0	64.77	0.0345
661	1880.00	4.2	10	47.98	0.0255
661	1880.00	4.2	20	6.52	0.0035
661	1880.00	4.2	30	-12.79	-0.0068
661	1880.00	4.2	40	-11.69	-0.0062
661	1880.00	4.2	50	-15.37	-0.0082
661	1880.00	4.2	60	-11.17	-0.0059

	EMI Test Report for the BlackBerry® smartphone Model RDM71UW, RDN71UW APPENDIX 3A	
	Test Report No. RTS-3640-1102-33A_rev1	Dates of Test January 11 to March 11 & 29 and May 24, 2011 FCC ID: L6ARDM70UW IC: 2503A-RDM70UW FCC ID: L6ARDN70UW IC: 2503A-RDN70UW

PCS1900 Results: channel 810 @ maximum transmitted power

Traffic Channel Number	Frequency (MHz)	Voltage (Volts)	Temperature (Celsius)	Frequency Error (Hz)	PPM
810	1909.80	3.6	-30	22.08	0.0116
810	1909.80	3.6	-20	21.24	0.0111
810	1909.80	3.6	-10	51.08	0.0267
810	1909.80	3.6	0	85.88	0.0450
810	1909.80	3.6	10	68.77	0.0360
810	1909.80	3.6	20	49.40	0.0259
810	1909.80	3.6	30	17.82	0.0093
810	1909.80	3.6	40	25.18	0.0132
810	1909.80	3.6	50	5.68	0.0030
810	1909.80	3.6	60	-20.73	-0.0109
Traffic Channel Number	Frequency (MHz)	Voltage (Volts)	Temperature (Celsius)	Frequency Error (Hz)	PPM
810	1909.80	3.7	-30	21.95	0.0115
810	1909.80	3.7	-20	30.87	0.0162
810	1909.80	3.7	-10	54.89	0.0287
810	1909.80	3.7	0	83.17	0.0435
810	1909.80	3.7	10	65.99	0.0346
810	1909.80	3.7	20	33.13	0.0173
810	1909.80	3.7	30	21.57	0.0113
810	1909.80	3.7	40	17.43	0.0091
810	1909.80	3.7	50	12.66	0.0066
810	1909.80	3.7	60	-22.79	-0.0119
Traffic Channel Number	Frequency (MHz)	Voltage (Volts)	Temperature (Celsius)	Frequency Error (Hz)	PPM
810	1909.80	4.2	-30	42.94	0.0225
810	1909.80	4.2	-20	45.01	0.0236
810	1909.80	4.2	-10	50.43	0.0264
810	1909.80	4.2	0	74.52	0.0390
810	1909.80	4.2	10	51.33	0.0269
810	1909.80	4.2	20	19.31	0.0101
810	1909.80	4.2	30	-10.78	-0.0056
810	1909.80	4.2	40	-9.94	-0.0052
810	1909.80	4.2	50	-6.13	-0.0032
810	1909.80	4.2	60	-8.98	-0.0047

APPENDIX 3B – UMTS FREQUENCY STABILITY TEST DATA

	EMI Test Report for the BlackBerry® smartphone Model RDM71UW, RDN71UW APPENDIX 3B	
Test Report No. RTS-3640-1102-33A_rev1	Dates of Test January 11 to March 11 & 29 and May 24, 2011	FCC ID: L6ARDM70UW IC: 2503A-RDM70UW FCC ID: L6ARDN70UW IC: 2503A-RDN70UW

UMTS Frequency Stability Test Data

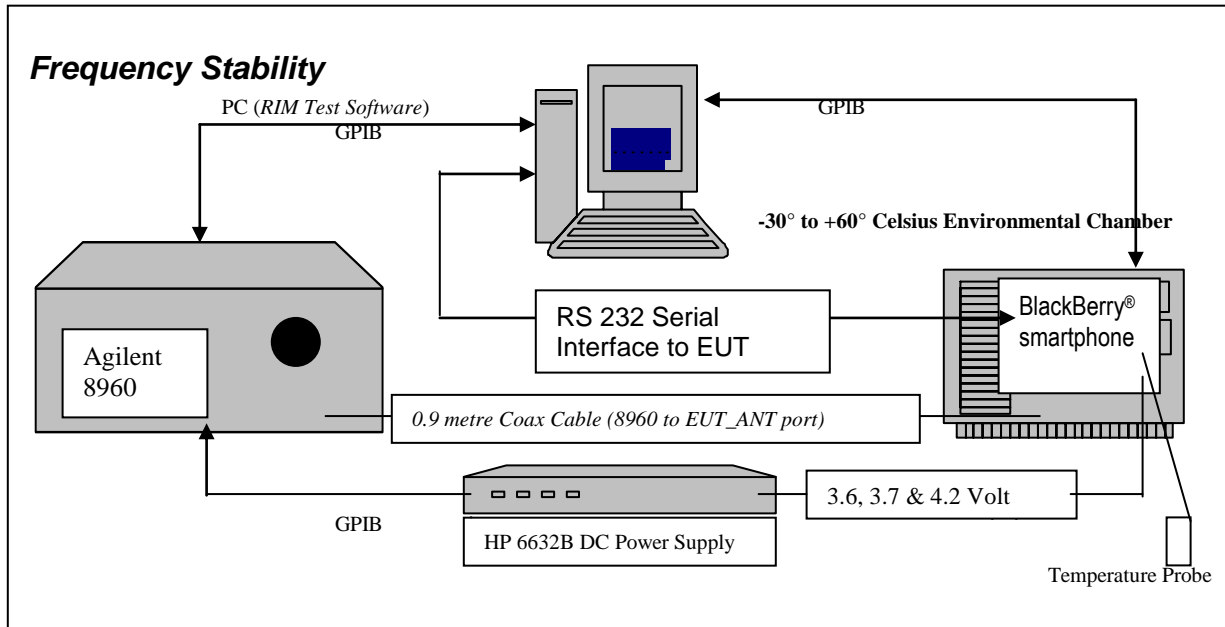

The following measurements were performed by Maurice Battler.

CFR 47 Chapter 1 - Federal Communications Commission Rules

Part 2 Required Measurements

2.1055 Frequency Stability - Procedures

(a,b) Frequency Stability - Temperature Variation

(d) Frequency Stability - Voltage Variation

24.236 *Frequency Stability.*

The frequency stability shall be sufficient to ensure that the fundamental emission stays within the authorized frequency block.

The EUT meets the requirements as stated in CFR 47 chapter 1, Section 27.54, CFR 47 and RSS-139, 6.3 Frequency Stability.

Frequency Stability measurement devices were configured as presented in the block diagram recording frequency, power, data, temperatures, and stepped voltages controlled via a GPIB interface linked to the Environmental chamber, a DC power supply, and the Communications Test Set. A 0.9-metre coax cable was calibrated to characterize the insertion loss for the transmitted frequencies between the RF input/output of the CMU 200 and the EUT antenna port.

Calibration for the Cable Loss was performed in the RF Laboratory using the Agilent power meter and Agilent Signal Generator.

	EMI Test Report for the BlackBerry® smartphone Model RDM71UW, RDN71UW APPENDIX 3B	
	Test Report No. RTS-3640-1102-33A_rev1	Dates of Test January 11 to March 11 & 29 and May 24, 2011

The cable assembly from the RF input to the RF output was measured at the following Frequencies:

Procedure:

The EUT was placed in the Temperature chamber and connected to CMU 200 outside as shown in the figure above. Dry air was pumped inside the temperature chamber to maintain a backpressure during the test. The EUT was kept in the off condition at all times except when the following measurements were to be made.

The chamber was switched on and the temperature was set to -30°C. After the chamber stabilized at -30 °C there was a soak period of one hour to alleviate moisture in the chamber, the EUT voltage was enabled. The system software recorded the frequency, power, and associated measurements.

A Computer system controlled the automated software. This application was given the command of activating all machines intrinsic to the temperature and voltage tests controlling the CMU 200 via the GPIB Bus. The Environmental Chamber was instructed through an RS-232 serial line. The EUT dialogue was passed through a serial connection.

The EUT repetitively transmitted 100 bursts for each set of programmed parameters recording temperature, voltage settings, and systematically selected frequencies. The power supply was cycled from minimum voltage 3.6 volts, to 3.7 volts to 4.2 volts maximum voltage. The frequency error was measured at a maximum output power and recorded by the automated system test software.

The EUT output power and frequency was measured at 3.6 volts, 3.7 volts and 4.2 volts. The transmit frequency was varied in 3 steps consisting of 1852.4, 1880.0 and 1907.6 MHz for the UMTS band 2. This frequency was recorded in MHz and deviation from nominal, in Parts Per Million. After the initial one-hour soak at the beginning of the tests, a period of thirty minutes soak was initialized between each ascending temperature step, before proceeding to the next measurement test cycle.

	EMI Test Report for the BlackBerry® smartphone Model RDM71UW, RDN71UW APPENDIX 3B	
	Test Report No. RTS-3640-1102-33A_rev1	Dates of Test January 11 to March 11 & 29 and May 24, 2011

PROCEDURE:

The test system software for commencing the Frequency Stability Tests carried through the following cycle.

1. Switch on the HP 6632B power supply; CMU 200 Communications test Set, and Environmental Chamber.
2. Start test program
3. Set the Temperature to -30°C and maintain a period of one- hour soak time, with the EUT supply voltage disabled.
4. Set power supply voltage to 3.6 volts.
5. Set up CMU 200 Radio Communication Tester.
6. Command the CMU 200 to switch to the low channel.
7. Enable the voltage to the EUT, and connect a link to the CMU 200 test set.
8. EUT is commanded to Transmit 100 Bursts.
9. Software logs the following data from the CMU 200, power supply and temperature chamber: Traffic Channel Number, Traffic Channel Frequency, Power Level, Chamber Temperature, Supply Voltage, Power and Frequency Error.
10. The CMU 200 commands the EUT to change frequency to the middle channel and high channel and repeats steps 7 to 9.
11. Repeat steps 5 to 10 changing the supply voltage to 3.7 Volts
12. Increase temperature by 10°C and soak for 1/2 hour.
13. Repeat steps 4 - 12 for temperatures -30°C to 60°C .
14. Repeat steps 5 to 10 changing the supply voltage to 4.2 volts

Procedure 5 to 10 was repeated at room temperature (20°C) with the power supply voltage set to 3.6, 3.7 and 4.2 volts

The following results are for RDM71UW

The maximum frequency error in the UMTS band 5 measured was **0.0532 PPM**.
The maximum frequency error in the UMTS band 2 measured was **-0.0410 PPM**.

	EMI Test Report for the BlackBerry® smartphone Model RDM71UW, RDN71UW APPENDIX 3B	
	Test Report No. RTS-3640-1102-33A_rev1	Dates of Test January 11 to March 11 & 29 and May 24, 2011 FCC ID: L6ARDM70UW IC: 2503A-RDM70UW FCC ID: L6ARDN70UW IC: 2503A-RDN70UW

UMTS Band 5 Channel results: channels 4132, 4182 and 4233 @ 20°C maximum transmitted power

Traffic Channel Number	UMTS band 5 Frequency (MHz)	Voltage (Volts)	Temperature (Celsius)	Frequency Error (Hz)	PPM
4132	826.4	3.6	20	-12	-0.0145
4182	836.4	3.6	20	-11	-0.0132
4233	846.6	3.6	20	-17	-0.0201

Traffic Channel Number	UMTS band 5 Frequency (MHz)	Voltage (Volts)	Temperature (Celsius)	Frequency Error (Hz)	PPM
4132	826.4	3.7	20	-24	-0.0290
4182	836.4	3.7	20	-30	-0.0359
4233	846.6	3.7	20	-24	-0.0283

Traffic Channel Number	UMTS band 5 Frequency (MHz)	Voltage (Volts)	Temperature (Celsius)	Frequency Error (Hz)	PPM
4132	826.4	4.2	20	-32	-0.0387
4182	836.4	4.2	20	-16	-0.0191
4233	846.6	4.2	20	-16	-0.0189

	EMI Test Report for the BlackBerry® smartphone Model RDM71UW, RDN71UW APPENDIX 3B	
	Test Report No. RTS-3640-1102-33A_rev1	Dates of Test January 11 to March 11 & 29 and May 24, 2011 FCC ID: L6ARDM70UW IC: 2503A-RDM70UW FCC ID: L6ARDN70UW IC: 2503A-RDN70UW

UMTS band 5 Results: channel 4132 @ maximum transmitted power

Traffic Channel Number	Frequency (MHz)	Voltage (Volts)	Temperature (Celsius)	Frequency Error (Hz)	PPM
4132	826.4	3.6	-30	-21	-0.0254
4132	826.4	3.6	-20	-16	-0.0194
4132	826.4	3.6	-10	-40	-0.0484
4132	826.4	3.6	0	-23	0.0182
4132	826.4	3.6	10	-19	-0.0230
4132	826.4	3.6	20	-12	-0.0145
4132	826.4	3.6	30	-19	-0.0230
4132	826.4	3.6	40	-11	-0.0133
4132	826.4	3.6	50	-33	-0.0399
4132	826.4	3.6	60	15	0.0182

Traffic Channel Number	Frequency (MHz)	Voltage (Volts)	Temperature (Celsius)	Frequency Error (Hz)	PPM
4132	826.4	3.7	-30	25	0.0303
4132	826.4	3.7	-20	-18	-0.0218
4132	826.4	3.7	-10	-44	-0.0532
4132	826.4	3.7	0	-21	-0.0254
4132	826.4	3.7	10	-21	-0.0254
4132	826.4	3.7	20	-24	-0.0290
4132	826.4	3.7	30	-21	-0.0254
4132	826.4	3.7	40	-14	-0.0169
4132	826.4	3.7	50	-15	-0.0182
4132	826.4	3.7	60	-24	-0.0290

Traffic Channel Number	Frequency (MHz)	Voltage (Volts)	Temperature (Celsius)	Frequency Error (Hz)	PPM
4132	826.4	4.2	-30	25	0.0303
4132	826.4	4.2	-20	-29	-0.0351
4132	826.4	4.2	-10	-23	-0.0278
4132	826.4	4.2	0	-38	-0.0460
4132	826.4	4.2	10	-31	-0.0375
4132	826.4	4.2	20	-32	-0.0387
4132	826.4	4.2	30	-16	-0.0194
4132	826.4	4.2	40	23	0.0278
4132	826.4	4.2	50	-11	-0.0133
4132	826.4	4.2	60	10	0.0121

UMTS band 5 Results: channel 4182 @ maximum transmitted power

Traffic Channel Number	Frequency (MHz)	Voltage (Volts)	Temperature (Celsius)	Frequency Error (Hz)	PPM
4182	836.4	3.6	-30	16	0.0191
4182	836.4	3.6	-20	19	0.0227
4182	836.4	3.6	-10	15	0.0179
4182	836.4	3.6	0	-14	-0.0215
4182	836.4	3.6	10	17	0.0203
4182	836.4	3.6	20	-11	-0.0132
4182	836.4	3.6	30	-28	-0.0335
4182	836.4	3.6	40	-17	-0.0203
4182	836.4	3.6	50	-21	-0.0251
4182	836.4	3.6	60	-18	-0.0215

Traffic Channel Number	Frequency (MHz)	Voltage (Volts)	Temperature (Celsius)	Frequency Error (Hz)	PPM
4182	836.4	3.7	-30	-27	-0.0323
4182	836.4	3.7	-20	-12	-0.0143
4182	836.4	3.7	-10	-35	-0.0418
4182	836.4	3.7	0	-42	-0.0502
4182	836.4	3.7	10	-23	-0.0275
4182	836.4	3.7	20	-30	-0.0359
4182	836.4	3.7	30	-30	-0.0359
4182	836.4	3.7	40	21	0.0251
4182	836.4	3.7	50	20	0.0239
4182	836.4	3.7	60	-15	-0.0179

Traffic Channel Number	Frequency (MHz)	Voltage (Volts)	Temperature (Celsius)	Frequency Error (Hz)	PPM
4182	836.4	4.2	-30	31	0.0371
4182	836.4	4.2	-20	-31	-0.0371
4182	836.4	4.2	-10	-16	-0.0191
4182	836.4	4.2	0	-15	-0.0179
4182	836.4	4.2	10	-18	-0.0215
4182	836.4	4.2	20	-16	-0.0191
4182	836.4	4.2	30	-15	-0.0179
4182	836.4	4.2	40	-30	-0.0359
4182	836.4	4.2	50	-14	-0.0167
4182	836.4	4.2	60	-11	-0.0132

	EMI Test Report for the BlackBerry® smartphone Model RDM71UW, RDN71UW APPENDIX 3B	
	Test Report No. RTS-3640-1102-33A_rev1	Dates of Test January 11 to March 11 & 29 and May 24, 2011 FCC ID: L6ARDM70UW IC: 2503A-RDM70UW FCC ID: L6ARDN70UW IC: 2503A-RDN70UW

UMTS band 5 Results: channel 4233 @ maximum transmitted power

Traffic Channel Number	Frequency (MHz)	Voltage (Volts)	Temperature (Celsius)	Frequency Error (Hz)	PPM
4233	846.6	3.6	-30	23	0.0272
4233	846.6	3.6	-20	17	0.0201
4233	846.6	3.6	-10	20	0.0236
4233	846.6	3.6	0	16	-0.0236
4233	846.6	3.6	10	-23	-0.0272
4233	846.6	3.6	20	-17	-0.0201
4233	846.6	3.6	30	-30	-0.0354
4233	846.6	3.6	40	-16	-0.0189
4233	846.6	3.6	50	-36	-0.0425
4233	846.6	3.6	60	-20	-0.0236

Traffic Channel Number	Frequency (MHz)	Voltage (Volts)	Temperature (Celsius)	Frequency Error (Hz)	PPM
4233	846.6	3.7	-30	19	0.0224
4233	846.6	3.7	-20	23	0.0272
4233	846.6	3.7	-10	18	0.0213
4233	846.6	3.7	0	13	0.0154
4233	846.6	3.7	10	-18	-0.0213
4233	846.6	3.7	20	-24	-0.0283
4233	846.6	3.7	30	-24	-0.0283
4233	846.6	3.7	40	-21	-0.0248
4233	846.6	3.7	50	-23	-0.0272
4233	846.6	3.7	60	-20	-0.0236

Traffic Channel Number	Frequency (MHz)	Voltage (Volts)	Temperature (Celsius)	Frequency Error (Hz)	PPM
4233	846.6	4.2	-30	20	0.0236
4233	846.6	4.2	-20	-26	-0.0307
4233	846.6	4.2	-10	17	0.0201
4233	846.6	4.2	0	-18	-0.0213
4233	846.6	4.2	10	-15	-0.0177
4233	846.6	4.2	20	-16	-0.0189
4233	846.6	4.2	30	-18	-0.0213
4233	846.6	4.2	40	-18	-0.0213
4233	846.6	4.2	50	-23	-0.0272
4233	846.6	4.2	60	-19	-0.0224

	EMI Test Report for the BlackBerry® smartphone Model RDM71UW, RDN71UW APPENDIX 3B	
	Test Report No. RTS-3640-1102-33A_rev1	Dates of Test January 11 to March 11 & 29 and May 24, 2011 FCC ID: L6ARDM70UW IC: 2503A-RDM70UW FCC ID: L6ARDN70UW IC: 2503A-RDN70UW

UMTS band 2 Channel results: channels 9262, 9400, & 9538 @ 20°C maximum transmitted power

Traffic Channel Number	UMTS1900 Frequency (MHz)	Voltage (Volts)	Temperature (Celsius)	Frequency Error (Hz)	PPM
9262	1852.40	3.6	20	-72	-0.0389
9400	1880.00	3.6	20	-29	-0.0154
9538	1907.60	3.6	20	33	0.0173

Traffic Channel Number	UMTS1900 Frequency (MHz)	Voltage (Volts)	Temperature (Celsius)	Frequency Error (Hz)	PPM
9262	1852.40	3.7	20	-33	-0.0178
9400	1880.00	3.7	20	-59	-0.0314
9538	1907.60	3.7	20	-77	-0.0404

Traffic Channel Number	UMTS1900 Frequency (MHz)	Voltage (Volts)	Temperature (Celsius)	Frequency Error (Hz)	PPM
9262	1852.40	4.2	20	48	0.0259
9400	1880.00	4.2	20	-52	-0.0277
9538	1907.60	4.2	20	-63	-0.0330

	EMI Test Report for the BlackBerry® smartphone Model RDM71UW, RDN71UW APPENDIX 3B	
	Test Report No. RTS-3640-1102-33A_rev1	Dates of Test January 11 to March 11 & 29 and May 24, 2011 FCC ID: L6ARDM70UW IC: 2503A-RDM70UW FCC ID: L6ARDN70UW IC: 2503A-RDN70UW

UMTS band 2 Results: channel 9262 @ maximum transmitted power

Traffic Channel Number	Frequency (MHz)	Voltage (Volts)	Temperature (Celsius)	Frequency Error (Hz)	PPM
9262	1852.40	3.6	-30	-66	-0.0356
9262	1852.40	3.6	-20	-42	-0.0227
9262	1852.40	3.6	-10	-27	-0.0146
9262	1852.40	3.6	0	-38	-0.0205
9262	1852.40	3.6	10	-35	-0.0189
9262	1852.40	3.6	20	-72	-0.0389
9262	1852.40	3.6	30	-36	-0.0194
9262	1852.40	3.6	40	24	0.0130
9262	1852.40	3.6	50	47	0.0254
9262	1852.40	3.6	60	-50	-0.0270

Traffic Channel Number	Frequency (MHz)	Voltage (Volts)	Temperature (Celsius)	Frequency Error (Hz)	PPM
9262	1852.40	3.7	-30	-29	-0.0157
9262	1852.40	3.7	-20	-31	-0.0167
9262	1852.40	3.7	-10	-29	-0.0157
9262	1852.40	3.7	0	-30	-0.0162
9262	1852.40	3.7	10	-32	-0.0173
9262	1852.40	3.7	20	-33	-0.0178
9262	1852.40	3.7	30	-67	-0.0362
9262	1852.40	3.7	40	-65	-0.0351
9262	1852.40	3.7	50	63	0.0340
9262	1852.40	3.7	60	-24	-0.0130

Traffic Channel Number	Frequency (MHz)	Voltage (Volts)	Temperature (Celsius)	Frequency Error (Hz)	PPM
9262	1852.40	4.2	-30	-35	-0.0189
9262	1852.40	4.2	-20	-30	-0.0162
9262	1852.40	4.2	-10	-37	-0.0200
9262	1852.40	4.2	0	-28	-0.0151
9262	1852.40	4.2	10	-41	-0.0221
9262	1852.40	4.2	20	48	0.0259
9262	1852.40	4.2	30	-29	-0.0157
9262	1852.40	4.2	40	-26	-0.0140
9262	1852.40	4.2	50	-58	-0.0313
9262	1852.40	4.2	60	44	0.0238

	EMI Test Report for the BlackBerry® smartphone Model RDM71UW, RDN71UW APPENDIX 3B	
	Test Report No. RTS-3640-1102-33A_rev1	Dates of Test January 11 to March 11 & 29 and May 24, 2011 FCC ID: L6ARDM70UW IC: 2503A-RDM70UW FCC ID: L6ARDN70UW IC: 2503A-RDN70UW

UMTS band 2 Results: channel 9400 @ maximum transmitted power

Traffic Channel Number	Frequency (MHz)	Voltage (Volts)	Temperature (Celsius)	Frequency Error (Hz)	PPM
9400	1880.00	3.6	-30	-26	-0.0138
9400	1880.00	3.6	-20	-30	-0.0160
9400	1880.00	3.6	-10	23	0.0122
9400	1880.00	3.6	0	29	0.0154
9400	1880.00	3.6	10	28	0.0149
9400	1880.00	3.6	20	-29	-0.0154
9400	1880.00	3.6	30	-59	-0.0314
9400	1880.00	3.6	40	-72	-0.0383
9400	1880.00	3.6	50	-28	-0.0149
9400	1880.00	3.6	60	-33	-0.0176

Traffic Channel Number	Frequency (MHz)	Voltage (Volts)	Temperature (Celsius)	Frequency Error (Hz)	PPM
9400	1880.00	3.7	-30	42	0.0223
9400	1880.00	3.7	-20	-23	-0.0122
9400	1880.00	3.7	-10	-62	-0.0330
9400	1880.00	3.7	0	30	0.0160
9400	1880.00	3.7	10	24	0.0128
9400	1880.00	3.7	20	-59	-0.0314
9400	1880.00	3.7	30	-32	-0.0170
9400	1880.00	3.7	40	-26	-0.0138
9400	1880.00	3.7	50	-28	-0.0149
9400	1880.00	3.7	60	42	0.0223

Traffic Channel Number	Frequency (MHz)	Voltage (Volts)	Temperature (Celsius)	Frequency Error (Hz)	PPM
9400	1880.00	4.2	-30	-26	-0.0138
9400	1880.00	4.2	-20	31	0.0165
9400	1880.00	4.2	-10	41	0.0218
9400	1880.00	4.2	0	-29	-0.0154
9400	1880.00	4.2	10	-27	-0.0144
9400	1880.00	4.2	20	-52	-0.0277
9400	1880.00	4.2	30	-72	-0.0383
9400	1880.00	4.2	40	-77	-0.0410
9400	1880.00	4.2	50	-26	-0.0138
9400	1880.00	4.2	60	28	0.0149

	EMI Test Report for the BlackBerry® smartphone Model RDM71UW, RDN71UW APPENDIX 3B	
	Test Report No. RTS-3640-1102-33A_rev1	Dates of Test January 11 to March 11 & 29 and May 24, 2011

UMTS band 2 Results: channel 9538 @ maximum transmitted power

Traffic Channel Number	Frequency (MHz)	Voltage (Volts)	Temperature (Celsius)	Frequency Error (Hz)	PPM
9538	1907.60	3.6	-30	-33	-0.0173
9538	1907.60	3.6	-20	-33	-0.0173
9538	1907.60	3.6	-10	38	0.0199
9538	1907.60	3.6	0	-56	-0.0294
9538	1907.60	3.6	10	-38	-0.0199
9538	1907.60	3.6	20	33	0.0173
9538	1907.60	3.6	30	-37	-0.0194
9538	1907.60	3.6	40	-35	-0.0183
9538	1907.60	3.6	50	-35	-0.0183
9538	1907.60	3.6	60	-35	-0.0183
Traffic Channel Number	Frequency (MHz)	Voltage (Volts)	Temperature (Celsius)	Frequency Error (Hz)	PPM
9538	1907.60	3.7	-30	-58	-0.0304
9538	1907.60	3.7	-20	29	0.0152
9538	1907.60	3.7	-10	29	0.0152
9538	1907.60	3.7	0	32	0.0168
9538	1907.60	3.7	10	40	0.0210
9538	1907.60	3.7	20	-77	-0.0404
9538	1907.60	3.7	30	-41	-0.0215
9538	1907.60	3.7	40	-34	-0.0178
9538	1907.60	3.7	50	-40	-0.0210
9538	1907.60	3.7	60	-70	-0.0367
Traffic Channel Number	Frequency (MHz)	Voltage (Volts)	Temperature (Celsius)	Frequency Error (Hz)	PPM
9538	1907.60	4.2	-30	-26	-0.0136
9538	1907.60	4.2	-20	45	0.0236
9538	1907.60	4.2	-10	51	0.0267
9538	1907.60	4.2	0	-47	-0.0246
9538	1907.60	4.2	10	31	0.0163
9538	1907.60	4.2	20	-63	-0.0330
9538	1907.60	4.2	30	-29	-0.0152
9538	1907.60	4.2	40	-78	-0.0409
9538	1907.60	4.2	50	-30	-0.0157
9538	1907.60	4.2	60	-36	-0.0189

APPENDIX 4A – GSM RADIATED EMISSIONS TEST DATA

	EMI Test Report for the BlackBerry® smartphone Model RDM71UW, RDN71UW APPENDIX 4B		
	Test Report No. RTS-3640-1102-33A_rev1	Dates of Test January 11 to March 11 & 29 and May 24, 2011	FCC ID: L6ARDM70UW IC: 2503A-RDM70UW FCC ID: L6ARDN70UW IC: 2503A-RDN70UW

Radiated Power Test Data Results

The following results are for RDM71UW

Date of test: March 11, 2011

The following measurements were performed by Kevin Rose.

The environmental tests conditions were: Temperature: 23.8 °C
Relative Humidity: 15.9 %

The BlackBerry® smartphone was in standalone, slider closed vertical position.
Test distance was 3.0 metres.

GSM850 Band Call Mode

EUT				Rx Antenna		Spectrum Analyzer		Substitution Method				Limit (dBm)	Diff. To Limit (dB)
Type	Ch	Frequency (MHz)	Band	Type	Pol.	Reading (dBuV)	Max (V,H) (dBuV)	Pol. Tx-Rx	Reading (dBm)	Corrected Reading (relative to Dipole)			
											(dBm)	(W)	
F0	128	824.20	850	Dipole	V	87.12	87.12	V-V	14.18	30.01	1.00	38.50	-8.49
F0	128	824.20	850	Dipole	H	78.09		H-H	12.03				
F0	190	836.60	850	Dipole	V	86.96	86.96	V-V	14.04	30.02	1.00	38.50	-8.48
F0	190	836.60	850	Dipole	H	77.67		H-H	12.11				
F0	251	848.80	850	Dipole	V	86.9	86.9	V-V	14.45	30.26	1.06	38.50	-8.24
F0	251	848.80	850	Dipole	H	77.36		H-H	12.95				

GSM850 Band EDGE Mode

EUT				Rx Antenna		Spectrum Analyzer		Substitution Method				Limit (dBm)	Diff. To Limit (dB)
Type	Ch	Frequency (MHz)	Band	Type	Pol.	Reading (dBuV)	Max (V,H) (dBuV)	Pol. Tx-Rx	Reading (dBm)	Corrected Reading (relative to Dipole)			
											(dBm)	(W)	
F0	128	824.20	850	Dipole	V	84.58	84.58	V-V	11.59	27.42	0.55	38.50	-11.08
F0	128	824.20	850	Dipole	H	74.43		H-H	9.46				
F0	190	836.60	850	Dipole	V	84.07	84.07	V-V	11.12	27.10	0.51	38.50	-11.40
F0	190	836.60	850	Dipole	H	73.5		H-H	9.19				
F0	251	848.80	850	Dipole	V	84.45	84.45	V-V	11.95	27.76	0.60	38.50	-10.74
F0	251	848.80	850	Dipole	H	74.35		H-H	10.48				

		EMI Test Report for the BlackBerry® smartphone Model RDM71UW, RDN71UW APPENDIX 4B	
Test Report No. RTS-3640-1102-33A_rev1		Dates of Test January 11 to March 11 & 29 and May 24, 2011	FCC ID: L6ARDM70UW IC: 2503A-RDM70UW FCC ID: L6ARDN70UW IC: 2503A-RDN70UW

Radiated Power Test Data Results cont'd

Date of test: May 24, 2011

The following measurements were performed by Shuo Wang.

The environmental tests conditions were: Temperature: 25.0 °C
Relative Humidity: 41.4 %

The BlackBerry® smartphone was in standalone, slider open horizontal down position.
Test distance is 3.0 metres.

PCS1900 Band Call Mode

EUT								Receive Antenna		Spectrum Analyzer		Tracking Generator		Substitution Method	
Type	Ch	Frequency (MHz)	Band	Type	Pol.	Reading (dBuV)	Max (V,H) dBuV	Pol. Tx-Rx	Reading (dBm)	Corrected Reading (relative to Isotropic Radiator)		Limit (dBm)	Diff to Limit (dB)		
										(dBm)	(W)				
F0	512	1850.20	1900	Horn	V	88.14	91.17	V-V	-2.86	31.95	1.57	33.00	-1.05		
F0	512	1850.20	1900	Horn	H	91.17		H-H	-3.00						
F0	661	1880.00	1900	Horn	V	87.24	91.49	V-V	-2.44	32.63	1.83	33.00	-0.37		
F0	661	1880.00	1900	Horn	H	91.49		H-H	-2.27						
F0	810	1909.80	1900	Horn	V	87.54	91.36	V-V	-1.74	32.56	1.80	33.00	-0.44		
F0	810	1909.80	1900	Horn	H	91.36		H-H	-1.39						

PCS1900 Band EDGE Mode

EUT								Receive Antenna		Spectrum Analyzer		Tracking Generator		Substitution Method	
Type	Ch	Frequency (MHz)	Band	Type	Pol.	Reading (dBuV)	Max (V,H) dBuV	Pol. Tx-Rx	Reading (dBm)	Corrected Reading (relative to Isotropic Radiator)		Limit (dBm)	Diff to Limit (dB)		
										(dBm)	(W)				
F0	512	1850.20	1900	Horn	V	88.24	91.38	V-V	-2.65	32.16	1.64	33.00	-0.84		
F0	512	1850.20	1900	Horn	H	91.38		H-H	-2.79						
F0	661	1880.00	1900	Horn	V	87.52	91.55	V-V	-2.38	32.69	1.86	33.00	-0.31		
F0	661	1880.00	1900	Horn	H	91.55		H-H	-2.21						
F0	810	1909.80	1900	Horn	V	87.34	91.41	V-V	-1.69	32.61	1.82	33.00	-0.39		
F0	810	1909.80	1900	Horn	H	91.41		H-H	-1.34						

	EMI Test Report for the BlackBerry® smartphone Model RDM71UW, RDN71UW APPENDIX 4B	
	Test Report No. RTS-3640-1102-33A_rev1	Dates of Test January 11 to March 11 & 29 and May 24, 2011

Radiated Emissions Test Data Results cont'd

GSM850 Call Mode

Date of Test: February 10, 2011

The following measurements were performed by Quan (Jerry) Ma.

The environmental test conditions were: Temperature: 24.3 °C
Relative Humidity: 10.2 %

Test Distance was 3.0 metres with a height of 1.0 metres, and a frequency range of 30 MHz to 1000 MHz.

The BlackBerry® smartphone was in standalone, slider closed horizontal position.

The measurements were performed in GSM850 Call Tx mode, channels 128, 190, 251.

All emissions had a test margin greater than 25.0 dB.

Date of Test: Feb 12, 2011

The following measurements were performed by Heng Lin.

The environmental test conditions were: Temperature: 24.9 °C
Relative Humidity: 34.0 %

Test Distance was 3.0 metres with a height of 1 metre, and a frequency range of 1 GHz to 9 GHz.

The BlackBerry® smartphone was in standalone, slider closed horizontal position.

The measurements were performed in GSM850 Call Tx mode, channels 128, 190, 251.

Frequency (MHz)	Channel Of Occurrence	Antenna		Test Angle (Deg.)	Detector (PK or QP)	Measured Level (dBm)	Correction Factor for preamp/antenna/ cables/ filter (dB)	Field Strength Level (reading+corr) (dBm)	Limit @ 3.0 m (dBm)	Test Margin (dB)
		Pol. (V/H)	Height (metres)							
2509.816	128	H	1.00	139.00	PK	-25.651	-86.47	-25.7	-13.00	-12.7
2546.564	195	H	1.00	146.00	PK	-32.909	-85.61	-32.9	-13.00	-19.9
2472.414	251	H	1.00	318.00	PK	-36.382	-86.32	-36.4	-13.00	-23.4
1673.104	195	H	1.00	146.00	PK	-36.453	-91.55	-36.5	-13.00	-23.5
1697.572	251	H	1.00	318.00	PK	-37.535	-91.51	-37.5	-13.00	-24.5

All other emissions had a test margin greater than 25.0 dB

	EMI Test Report for the BlackBerry® smartphone Model RDM71UW, RDN71UW APPENDIX 4B	
	Test Report No. RTS-3640-1102-33A_rev1	Dates of Test January 11 to March 11 & 29 and May 24, 2011

Radiated Emissions Test Data Results cont'd

GSM850 EDGE Mode

Date of Test: February 10, 2011

The following measurements were performed by Quan (Jerry) Ma.

The environmental test conditions were: Temperature: 24.3 °C
Relative Humidity: 10.2 %

Test Distance was 3.0 metres with a height of 1.0 metres, and a frequency range of 30 MHz to 1000 MHz.

The BlackBerry® smartphone was in standalone, slider closed horizontal position.

The measurements were performed in GSM850 EDGE Tx mode, channels 128, 190, 251.

All emissions had a test margin greater than 25.0 dB.

Date of Test: Feb 12, 2011

The following measurements were performed by Heng Lin.

The environmental test conditions were: Temperature: 24.9 °C
Relative Humidity: 34.0 %

Test Distance was 3.0 metres with a height of 1-4 metres, and a frequency range of 1 GHz to 9 GHz.

The BlackBerry® smartphone was in standalone, slider closed horizontal position.

The measurements were performed in GSM850 EDGE Tx mode, channels 128, 190, 251.

Frequency (MHz)	Channel Of Occurrence	Antenna		Test Angle (Deg.)	Detector (PK or QP)	Measured Level (dBm)	Correction Factor for preamp/antenna/ cables/ filter (dB)	Field Strength Level (reading+corr) (dBm)	Limit @ 3.0 m (dBm)	Test Margin (dB)
		Pol. (V/H)	Height (metres)							
1697.572	251	H	1.00	139.00	PK	-37.535	-91.52	-37.5	-13.00	-24.5

All other emissions had a test margin greater than 25.0 dB

	EMI Test Report for the BlackBerry® smartphone Model RDM71UW, RDN71UW APPENDIX 4B	
Test Report No. RTS-3640-1102-33A_rev1	Dates of Test January 11 to March 11 & 29 and May 24, 2011	FCC ID: L6ARDM70UW IC: 2503A-RDM70UW FCC ID: L6ARDN70UW IC: 2503A-RDN70UW

Radiated Emissions Test Data Results cont'd

PCS1900 GSM Mode

Date of Test: February 10, 2011

The following measurements were performed by Quan (Jerry) Ma.

The environmental test conditions were: Temperature: 24.3 °C
Relative Humidity: 10.2 %

Test Distance was 3.0 metres with a height of 1-4 meters, and a frequency range of 30 - 1000 MHz.

The BlackBerry® smartphone was in standalone, slider closed USB down position.

The measurements were performed in PCS1900 Call Tx mode, channels 512, 661, 810.

All emissions had a test margin greater than 25.0 dB.

Date of Test: February 09, 2011

The following measurements were performed by Heng Lin.

The environmental test conditions were: Temperature: 24.3 °C
Relative Humidity: 38.5 %

Test Distance was 3.0 metres with a height of 1.0 metres, and a frequency range of 1 GHz to 20 GHz.

The BlackBerry® smartphone was in standalone, slider closed vertical position.

The measurements were performed in PCS1900 Call Tx mode, channels 512, 661, 810.

All emissions had a test margin greater than 25.0 dB.

	EMI Test Report for the BlackBerry® smartphone Model RDM71UW, RDN71UW APPENDIX 4B	
	Test Report No. RTS-3640-1102-33A_rev1	Dates of Test January 11 to March 11 & 29 and May 24, 2011

Radiated Emissions Test Data Results cont'd
PCS1900 EDGE Mode

Date of Test: February 10, 2011

The following measurements were performed by Quan (Jerry) Ma.

The environmental test conditions were: Temperature: 24.3 °C
Relative Humidity: 10.2 %

Test Distance was 3.0 metres with a height of 1metre, and a frequency range of 30 - 1000 MHz.

The BlackBerry® smartphone was in standalone, slider closed USB down position.

The measurements were performed in PCS1900 Edge Tx mode, channels 512, 661, 810.

All emissions had a test margin greater than 25.0 dB.

Date of Test: February 10, 2011

The following measurements were performed by Heng Lin.

The environmental test conditions were: Temperature: 24.9 °C
Relative Humidity: 34.9 %

Test Distance was 3.0 metres with a height of 1.0 metres, and a frequency range of 1 GHz to 20 GHz.

The BlackBerry® smartphone was in standalone, slider closed vertical position.

The measurements were performed in PCS1900 Edge Tx mode, channels 512, 661, 810.

All emissions had a test margin greater than 25.0 dB.

	EMI Test Report for the BlackBerry® smartphone Model RDM71UW, RDN71UW APPENDIX 4B		
	Test Report No. RTS-3640-1102-33A_rev1	Dates of Test January 11 to March 11 & 29 and May 24, 2011	FCC ID: L6ARDM70UW IC: 2503A-RDM70UW FCC ID: L6ARDN70UW IC: 2503A-RDN70UW

Radiated Power Test Data Results cont'd

The following results are for RDN71UW

Date of test: March 29, 2011

The following measurements were performed by Kevin Rose.

The environmental tests conditions were: Temperature: 22.8 °C

Relative Humidity: 18.9 %

The BlackBerry® smartphone was in standalone, slider closed vertical position.

Test distance is 3.0 metres.

GSM850 Band Call Mode

EUT				Rx Antenna		Spectrum Analyzer		Substitution Method				Limit (dBm)	Diff. To Limit (dB)
Type	Ch	Frequency (MHz)	Band	Type	Pol.	Reading (dBuV)	Max (V,H) (dBuV)	Pol. Tx-Rx	Reading (dBm)	Corrected Reading (relative to Dipole)			
										(dBm)	(W)		
F0	128	824.20	850	Dipole	V	85.53	85.53	V-V	12.14	27.97	0.63	38.50	-10.53
F0	128	824.20	850	Dipole	H	75.48		H-H	10.53				
F0	190	836.60	850	Dipole	V	86.14	86.14	V-V	13.14	29.12	0.82	38.50	-9.38
F0	190	836.60	850	Dipole	H	74.72		H-H	11.87				
F0	251	848.80	850	Dipole	V	86.6	86.6	V-V	13.54	29.35	0.86	38.50	-9.15
F0	251	848.80	850	Dipole	H	75.54		H-H	12.01				

GSM850 Band EDGE Mode

EUT				Rx Antenna		Spectrum Analyzer		Substitution Method				Limit (dBm)	Diff. To Limit (dB)
Type	Ch	Frequency (MHz)	Band	Type	Pol.	Reading (dBuV)	Max (V,H) (dBuV)	Pol. Tx-Rx	Reading (dBm)	Corrected Reading (relative to Dipole)			
										(dBm)	(W)		
F0	128	824.20	850	Dipole	V	80.35	80.35	V-V	8.22	24.05	0.25	38.50	-14.45
F0	128	824.20	850	Dipole	H	68.22		H-H	5.03				
F0	190	836.60	850	Dipole	V	80.17	80.17	V-V	7.55	23.53	0.23	38.50	-14.97
F0	190	836.60	850	Dipole	H	68.13		H-H	6.40				
F0	251	848.80	850	Dipole	V	81.54	81.54	V-V	8.05	23.86	0.24	38.50	-14.64
F0	251	848.80	850	Dipole	H	68.9		H-H	7.41				

		EMI Test Report for the BlackBerry® smartphone Model RDM71UW, RDN71UW APPENDIX 4B	
Test Report No. RTS-3640-1102-33A_rev1		Dates of Test January 11 to March 11 & 29 and May 24, 2011	FCC ID: L6ARDM70UW IC: 2503A-RDM70UW FCC ID: L6ARDN70UW IC: 2503A-RDN70UW

Radiated Power Test Data Results cont'd

Date of test: May 24, 2011

The following measurements were performed by Shuo Wang.

The environmental tests conditions were: Temperature: 25.0 °C
Relative Humidity: 41.4 %

The BlackBerry® smartphone was in standalone, slider open horizontal down position.
Test distance is 3.0 metres.

PCS1900 Band Call Mode

EUT								Substitution Method					
EUT				Receive Antenna		Spectrum Analyzer		Tracking Generator					
Type	Ch	Frequency (MHz)	Band	Type	Pol	Reading (dBuV)	Max (V,H) dBuV	Pol. Tx-Rx	Reading (dBm)	Corrected Reading (relative to Isotropic Radiator)		Limit (dBm)	Diff to Limit (dB)
										(dBm)	(W)		
F0	512	1850.20	1900	Horn	V	87.54	91.16	V-V	-2.87	31.94	1.56	33.00	1.06
F0	512	1850.20	1900	Horn	H	91.16		H-H	-3.01				
F0	661	1880.00	1900	Horn	V	87.84	91.34	V-V	-2.59	32.48	1.77	33.00	0.52
F0	661	1880.00	1900	Horn	H	91.34		H-H	-2.42				
F0	810	1909.80	1900	Horn	V	85.84	90.77	V-V	-2.33	31.97	1.57	33.00	1.03
F0	810	1909.80	1900	Horn	H	90.77		H-H	-1.98				

PCS1900 Band EDGE Mode

EUT								Substitution Method					
EUT				Receive Antenna		Spectrum Analyzer		Tracking Generator					
Type	Ch	Frequency (MHz)	Band	Type	Pol	Reading (dBuV)	Max (V,H) dBuV	Pol. Tx-Rx	Reading (dBm)	Corrected Reading (relative to Isotropic Radiator)		Limit (dBm)	Diff to Limit (dB)
										(dBm)	(W)		
F0	512	1850.20	1900	Horn	V	87.33	91.32	V-V	-2.71	32.10	1.62	33.00	4.52
F0	512	1850.20	1900	Horn	H	91.32		H-H	-2.85				
F0	661	1880.00	1900	Horn	V	87.54	91.63	V-V	-2.30	32.77	1.89	33.00	3.23
F0	661	1880.00	1900	Horn	H	91.63		H-H	-2.13				
F0	810	1909.80	1900	Horn	V	86.12	91.39	V-V	-1.71	32.59	1.82	33.00	3.54
F0	810	1909.80	1900	Horn	H	91.39		H-H	-1.36				

	EMI Test Report for the BlackBerry® smartphone Model RDM71UW, RDN71UW APPENDIX 4B	
Test Report No. RTS-3640-1102-33A_rev1	Dates of Test January 11 to March 11 & 29 and May 24, 2011	FCC ID: L6ARDM70UW IC: 2503A-RDM70UW FCC ID: L6ARDN70UW IC: 2503A-RDN70UW

APPENDIX 4B – UMTS RADIATED EMISSIONS TEST DATA

		EMI Test Report for the BlackBerry® smartphone Model RDM71UW, RDN71UW APPENDIX 4B	
Test Report No. RTS-3640-1102-33A_rev1	Dates of Test January 11 to March 11 & 29 and May 24, 2011	FCC ID: L6ARDM70UW IC: 2503A-RDM70UW FCC ID: L6ARDN70UW IC: 2503A-RDN70UW	

Radiated Power Test Data Results

The following results are for RDM71UW

Date of Test: February 18, 2011

The following measurements were performed by Quan (Jerry) Ma.

The environmental tests conditions were: Temperature: 23.8 °C
Relative Humidity: 15.9 %

The BlackBerry® smartphone - was in standalone, slider closed vertical position.
Test distance is 3.0 metres

UMTS band 5 Call Service Mode

EUT				Rx Antenna		Spectrum Analyzer		Substitution Method					
Type	Ch	Frequency (MHz)	Band	Type	Pol.	Reading (dBuV)	Max (V,H) (dBuV)	Tracking Generator		Corrected Reading (relative to Dipole)		Limit (dBm)	Diff. To Limit (dB)
								Pol. Tx-Rx	Reading (dBm)	(dBm)	(W)		
F0	4132	826.40	5	Dipole	V	77.22	77.22	V-V	4.19	20.02	0.10	39	-18.98
F0	4132	826.40	5	Dipole	H	67.58		H-H	2.26				
F0	4182	836.40	5	Dipole	V	76.68	76.68	V-V	3.69	19.67	0.09	39	-19.33
F0	4182	836.40	5	Dipole	H	65.59		H-H	1.77				
F0	4233	846.60	5	Dipole	V	77.82	77.82	V-V	4.47	20.28	0.11	39	-18.72
F0	4233	846.60	5	Dipole	H	66.67		H-H	3.57				

UMTS band 5 HSUPA Mode

EUT				Rx Antenna		Spectrum Analyzer		Substitution Method					
Type	Ch	Frequency (MHz)	Band	Type	Pol.	Reading (dBuV)	Max (V,H) (dBuV)	Tracking Generator		Corrected Reading (relative to Dipole)		Limit (dBm)	Diff. To Limit (dB)
								Pol. Tx-Rx	Reading (dBm)	(dBm)	(W)		
F0	4132	826.40	5	Dipole	V	77.51	77.51	V-V	4.42	20.25	0.11	39	-18.75
F0	4132	826.40	5	Dipole	H	67.43		H-H	2.51				
F0	4182	836.40	5	Dipole	V	77.14	77.14	V-V	4.12	20.10	0.10	39	-18.9
F0	4182	836.40	5	Dipole	H	65.4		H-H	2.31				
F0	4233	846.60	5	Dipole	V	79.09	79.09	V-V	5.58	21.39	0.14	39	-17.61
F0	4233	846.60	5	Dipole	H	67.73		H-H	4.65				

	EMI Test Report for the BlackBerry® smartphone Model RDM71UW, RDN71UW APPENDIX 4B		
	Test Report No. RTS-3640-1102-33A_rev1	Dates of Test January 11 to March 11 & 29 and May 24, 2011	FCC ID: L6ARDM70UW IC: 2503A-RDM70UW FCC ID: L6ARDN70UW IC: 2503A-RDN70UW

Radiated Power Test Data Results cont'd

Date of Test: March 11, 2011

The following measurements were performed by Quan (Jerry) Ma.

The environmental tests conditions were: Temperature: 23.8 °C
Relative Humidity: 20.8%

The BlackBerry® smartphone was in standalone, slider closed USB down position.
Test Distance was 3.0 metres.

UMTS band 2 Call Service Mode

										Substitution Method			
EUT				Receive Antenna		Spectrum Analyzer		Tracking Generator				Limit (dBm)	Diff to Limit (dB)
Type	Ch	Frequency (MHz)	Band	Type	Pol.	Reading (dBuV)	Max (V,H) (dBuV)	Pol. Tx-Rx	Reading (dBm)	(dBm)	(W)		
F0	9262	1852.40	2	Horn	V	87.62	87.62	V-V	-10.93	26.50	0.44	33.00	-6.5
F0	9262	1852.40	2	Horn	H	80.28		H-H	-9.88				
F0	9400	1880.00	2	Horn	V	86.99	86.99	V-V	-11.29	25.8	0.38	33.00	-7.2
F0	9400	1880.00	2	Horn	H	77.62		H-H	-10.48				
F0	9538	1907.60	2	Horn	V	86.64	86.64	V-V	-11.09	25.66	0.36	33.00	-7.34
F0	9538	1907.60	2	Horn	H	79.64		H-H	-10.66				

UMTS band 2 HSUPA Mode

										Substitution Method			
EUT				Receive Antenna		Spectrum Analyzer		Tracking Generator				Limit (dBm)	Diff to Limit (dB)
Type	Ch	Frequency (MHz)	Band	Type	Pol.	Reading (dBuV)	Max (V,H) (dBuV)	Pol. Tx-Rx	Reading (dBm)	(dBm)	(W)		
F0	9262	1852.40	2	Horn	V	87.88	87.88	V-V	-10.81	26.66	0.46	33.00	-6.34
F0	9262	1852.40	2	Horn	H	81.92		H-H	-9.72				
F0	9400	1880.00	2	Horn	V	87.11	87.11	V-V	-10.94	25.72	0.37	33.00	-7.28
F0	9400	1880.00	2	Horn	H	82.01		H-H	-10.56				
F0	9538	1907.60	2	Horn	V	87.9	87.9	V-V	-10.83	25.49	0.35	33.00	-7.51
F0	9538	1907.60	2	Horn	H	81.29		H-H	-10.86				

	EMI Test Report for the BlackBerry® smartphone Model RDM71UW, RDN71UW APPENDIX 4B	
Test Report No. RTS-3640-1102-33A_rev1	Dates of Test January 11 to March 11 & 29 and May 24, 2011	FCC ID: L6ARDM70UW IC: 2503A-RDM70UW FCC ID: L6ARDN70UW IC: 2503A-RDN70UW

Radiated Emissions Test Data Results cont'd
UMTS band 5 Call Service Mode

Date of Test: March 7, 2010

The following measurements were performed by Quan (Jerry) Ma

The environmental test conditions were: Temperature: 23.2 °C
Relative Humidity: 15.5 %

Test Distance was 3.0 metres with a height of 1-4 metres, a frequency range of 30MHz to 1000MHz.

The BlackBerry® smartphone was in standalone, slider closed vertical position.

The following measurements were performed in UMTS band 5 Call mode on channels 4132, 4182, 4233.

All emissions had a test margin greater than 25.0 dB.

Date of Test: Feb 14, 2010

The following measurements were performed by Adam Rusinek

The environmental test conditions were: Temperature: 24.6 °C
Relative Humidity: 37.3%

Test Distance was 3.0 metres with a height of 1-4 meters, a frequency range of 1-9GHz.

The BlackBerry® smartphone was in standalone, slider open vertical position.

The following measurements were performed in UMTS band 5 Call mode on channels 4132, 4182, 4233.

All emissions had a test margin greater than 25.0 dB.

	EMI Test Report for the BlackBerry® smartphone Model RDM71UW, RDN71UW APPENDIX 4B	
Test Report No. RTS-3640-1102-33A_rev1	Dates of Test January 11 to March 11 & 29 and May 24, 2011	FCC ID: L6ARDM70UW IC: 2503A-RDM70UW FCC ID: L6ARDN70UW IC: 2503A-RDN70UW

Radiated Emissions Test Data Results cont'd
UMTS 5 HSUPA Mode

Date of Test: March 7, 2010

The following measurements were performed by Kevin Rose

The environmental test conditions were: Temperature: 23.2 °C
Relative Humidity: 13.5 %

Test Distance was 3.0 metres with a height of 1-4 metres, a frequency range of 30MHz to 1000MHz.

The BlackBerry® smartphone was in standalone, slider closed vertical position.

The following measurements were performed in UMTS band 5 HSUPA mode on channels 4132, 4182, 4233.

All emissions had a test margin greater than 25.0 dB.

Date of Test: Feb 16, 2010

The following measurements were performed by Adam Rusinek

The environmental test conditions were: Temperature: 25.0 °C
Relative Humidity: 36.4 %

Test Distance was 3.0 metres with a height of 1-4 meters, and a frequency range of 1-9GHz.

The BlackBerry® smartphone was in standalone, slider open vertical position.

The following measurements were performed in UMTS band 5 HSUPA mode on channels 4132, 4182, 4233.

All emissions had a test margin greater than 25.0 dB.

	EMI Test Report for the BlackBerry® smartphone Model RDM71UW, RDN71UW APPENDIX 4B	
	Test Report No. RTS-3640-1102-33A_rev1	Dates of Test January 11 to March 11 & 29 and May 24, 2011

Radiated Emissions Test Data Results cont'd

UMTS band 2 Call Service mode

Date of Test: March 7, 2010

The following measurements were performed by Quan (Jerry) Ma

The environmental test conditions were: Temperature: 23.2 °C
Relative Humidity: 15.5 %

Test Distance was 3.0 metres with a height of 1-4 metres, and a frequency range of 30 MHz to 1000 MHz.

The BlackBerry® smartphone was in standalone, slider closed vertical position.

The following measurements were performed in UMTS band 2 Call mode on channels 9262, 9400, 9500.

All emissions had a test margin greater than 25.0 dB.

Date of Test: February 25, 2011

The following measurements were performed by Adam Rusinek

The environmental test conditions were: Temperature: 24.8°C
Relative Humidity: 38.2 %

Test Distance was 3.0 metres with a height of 1-4 metres, and a frequency range of 1-20GHz.

The BlackBerry® smartphone was in standalone, slider open horizontal down position.

The following measurements were performed in UMTS band 2 Call mode on channels 9262, 9400, 9500.

All emissions had a test margin greater than 25.0 dB.

	EMI Test Report for the BlackBerry® smartphone Model RDM71UW, RDN71UW APPENDIX 4B	
Test Report No. RTS-3640-1102-33A_rev1	Dates of Test January 11 to March 11 & 29 and May 24, 2011	FCC ID: L6ARDM70UW IC: 2503A-RDM70UW FCC ID: L6ARDN70UW IC: 2503A-RDN70UW

Radiated Emissions Test Data Results cont'd
UMTS band 2 HSUPA Mode

Date of Test: March 7, 2010

The following measurements were performed by Quan (Jerry) Ma

The environmental test conditions were: Temperature: 23.2 °C
Relative Humidity: 15.5 %

Test Distance was 3.0 metres with a height of 1-4 metres, a frequency range of 30 MHz to 1000 MHz.

The BlackBerry® smartphone was in standalone, slider closed vertical position.

The following measurements were performed in UMTS band 2 HSUPA mode on channels 9262, 9400, 9500.

All emissions had a test margin greater than 25.0 dB.

Date of Test: February 25, 2011

The following measurements were performed by Adam Rusinek.

The environmental test conditions were: Temperature: 24.8°C
Relative Humidity: 38.2 %

Test Distance was 3.0 metres with a height of 1-4 metres, a frequency range of 1-20GHz.

The BlackBerry® smartphone was in standalone, slider open horizontal down position.

The following measurements were performed in UMTS band 2 HSUPA mode on channels 9262, 9400, 9500.

All emissions had a test margin greater than 25.0 dB.

	EMI Test Report for the BlackBerry® smartphone Model RDM71UW, RDN71UW APPENDIX 4B		
	Test Report No. RTS-3640-1102-33A_rev1	Dates of Test January 11 to March 11 & 29 and May 24, 2011	FCC ID: L6ARDM70UW IC: 2503A-RDM70UW FCC ID: L6ARDN70UW IC: 2503A-RDN70UW

The following results are for RDN71UW

Date of Test: March 29, 2011

The following measurements were performed by Quan (Jerry) Ma.

The environmental tests conditions were: Temperature: 23.8 °C
Relative Humidity: 20.8%

The BlackBerry® smartphone was in standalone, slider closed USB down position.
Test Distance was 3.0 metres.

UMTS band 2 Call Service Mode

										Substitution Method			
EUT				Receive Antenna		Spectrum Analyzer		Tracking Generator					
Type	Ch	Frequency (MHz)	Band	Type	Pol.	Reading (dBuV)	Max (V,H) (dBuV)	Pol. Tx-Rx	Reading (dBm)	(dBm)	(W)	Limit (dBm)	Diff to Limit (dB)
F0	9262	1852.40	2	Horn	V	87.4	87.4	V-V	-11.54	25.96	0.39	33.00	-7.04
F0	9262	1852.40	2	Horn	H	80.46		H-H	-10.42				
F0	9400	1880.00	2	Horn	V	86.84	86.84	V-V	-11.79	25.49	0.35	33.00	-7.51
F0	9400	1880.00	2	Horn	H	80.14		H-H	-10.79				
F0	9538	1907.60	2	Horn	V	86.66	86.66	V-V	-11.34	25.70	0.37	33.00	-7.30
F0	9538	1907.60	2	Horn	H	81		H-H	-10.62				

UMTS band 2 HSUPA Mode

										Substitution Method			
EUT				Receive Antenna		Spectrum Analyzer		Tracking Generator					
Type	Ch	Frequency (MHz)	Band	Type	Pol.	Reading (dBuV)	Max (V,H) (dBuV)	Pol. Tx-Rx	Reading (dBm)	(dBm)	(W)	Limit (dBm)	Diff to Limit (dB)
F0	9262	1852.40	2	Horn	V	88.54	88.54	V-V	-10.38	27.07	0.51	33.00	-5.93
F0	9262	1852.40	2	Horn	H	81.46		H-H	-9.31				
F0	9400	1880.00	2	Horn	V	87.47	87.47	V-V	-11.14	26.12	0.41	33.00	-6.88
F0	9400	1880.00	2	Horn	H	81.3		H-H	-10.16				
F0	9538	1907.60	2	Horn	V	87.23	87.23	V-V	-10.77	26.26	0.42	33.00	-6.74
F0	9538	1907.60	2	Horn	H	81.88		H-H	-10.06				