



A D T

# FCC TEST REPORT (15.247)

**REPORT NO.:** RF110111C23

**MODEL NO.:** RDJ21WW

**FCC ID:** L6ARDJ20WW

**RECEIVED:** Jan. 12, 2011

**TESTED:** Jan. 18 ~ Feb. 08, 2011

**ISSUED:** Feb. 10, 2011

**APPLICANT:** Research In Motion Limited

**ADDRESS:** 295 Phillip Street, Waterloo, Ontario, Canada

**ISSUED BY:** Bureau Veritas Consumer Products Services  
(H.K.) Ltd., Taoyuan Branch

**LAB ADDRESS:** No. 47, 14th Ling, Chia Pau Tsuen, Lin Kou  
Hsiang, Taipei Hsien 244, Taiwan, R.O.C.

**TEST LOCATION:** No. 19, Hwa Ya 2nd Rd, Wen Hwa Tsuen, Kwei  
Shan Hsiang, Taoyuan Hsien 333, Taiwan, R.O.C.

This test report consists of 98 pages in total. It may be duplicated completely for legal use with the approval of the applicant. It should not be reproduced except in full, without the written approval of our laboratory. The client should not use it to claim product certification, approval, or endorsement by TAF or any government agency. The test results in the report only apply to the tested sample.





A D T

## TABLE OF CONTENTS

RELEASE CONTROL RECORD.....	5
1. CERTIFICATION.....	6
2. SUMMARY OF TEST RESULTS .....	7
2.1 MEASUREMENT UNCERTAINTY .....	7
3. GENERAL INFORMATION.....	8
3.1 GENERAL DESCRIPTION OF EUT .....	8
3.2 DESCRIPTION OF TEST MODES .....	10
3.2.1 CONFIGURATION OF SYSTEM UNDER TEST .....	10
3.2.2 TEST MODE APPLICABILITY AND TESTED CHANNEL DETAIL .....	11
3.3 GENERAL DESCRIPTION OF APPLIED STANDARDS .....	15
3.4 DESCRIPTION OF SUPPORT UNITS .....	15
4. TEST TYPES AND RESULTS (FOR 2.4GHz BAND) .....	16
4.1 RADIATED EMISSION MEASUREMENT .....	16
4.1.1 LIMITS OF RADIATED EMISSION MEASUREMENT.....	16
4.1.2 TEST INSTRUMENTS.....	17
4.1.3 TEST PROCEDURES .....	18
4.1.4 DEVIATION FROM TEST STANDARD.....	18
4.1.5 TEST SETUP.....	19
4.1.6 EUT OPERATING CONDITIONS .....	19
4.1.7 TEST RESULT .....	20
4.2 CONDUCTED EMISSION MEASUREMENT .....	30
4.2.1 LIMITS OF CONDUCTED EMISSION MEASUREMENT .....	30
4.2.2 TEST INSTRUMENTS.....	30
4.2.3 TEST PROCEDURES .....	31
4.2.4 DEVIATION FROM TEST STANDARD.....	31
4.2.5 TEST SETUP .....	32
4.2.6 EUT OPERATING CONDITIONS .....	32
4.2.7 TEST RESULTS .....	33
4.3 6dB BANDWIDTH MEASUREMENT.....	35
4.3.1 LIMITS OF 6dB BANDWIDTH MEASUREMENT .....	35
4.3.2 TEST INSTRUMENTS.....	35
4.3.3 TEST PROCEDURE.....	35
4.3.4 DEVIATION FROM TEST STANDARD.....	35
4.3.5 TEST SETUP .....	36
4.3.6 EUT OPERATING CONDITIONS .....	36
4.3.7 TEST RESULTS .....	37
4.4 MAXIMUM OUTPUT POWER .....	40



4.4.1	LIMITS OF MAXIMUM OUTPUT POWER MEASUREMENT.....	40
4.4.2	INSTRUMENTS.....	40
4.4.3	TEST PROCEDURE.....	40
4.4.4	DEVIATION FROM TEST STANDARD.....	41
4.4.5	TEST SETUP.....	41
4.4.6	EUT OPERATING CONDITIONS.....	41
4.4.7	TEST RESULTS.....	42
4.5	POWER SPECTRAL DENSITY MEASUREMENT.....	43
4.5.1	LIMITS OF POWER SPECTRAL DENSITY MEASUREMENT.....	43
4.5.2	TEST INSTRUMENTS.....	43
4.5.3	TEST PROCEDURE.....	43
4.5.4	DEVIATION FROM TEST STANDARD.....	44
4.5.5	TEST SETUP.....	44
4.5.6	EUT OPERATING CONDITION.....	44
4.5.7	TEST RESULTS.....	45
4.6	BAND EDGES MEASUREMENT.....	48
4.6.1	LIMITS OF BAND EDGES MEASUREMENT.....	48
4.6.2	TEST INSTRUMENTS.....	48
4.6.3	TEST PROCEDURE.....	48
4.6.4	DEVIATION FROM TEST STANDARD.....	48
4.6.5	EUT OPERATING CONDITION.....	48
4.6.6	TEST RESULTS.....	49
5.	TEST TYPES AND RESULTS (FOR 5.0GHz BAND).....	61
5.1	RADIATED EMISSION MEASUREMENT.....	61
5.1.1	LIMITS OF RADIATED EMISSION MEASUREMENT.....	61
5.1.2	TEST INSTRUMENTS.....	62
5.1.3	TEST PROCEDURES.....	63
5.1.4	DEVIATION FROM TEST STANDARD.....	63
5.1.5	TEST SETUP.....	64
5.1.6	EUT OPERATING CONDITIONS.....	64
5.1.7	TEST RESULTS.....	65
5.2	CONDUCTED EMISSION MEASUREMENT.....	72
5.2.1	LIMITS OF CONDUCTED EMISSION MEASUREMENT.....	72
5.2.2	TEST INSTRUMENTS.....	72
5.2.3	TEST PROCEDURES.....	73
5.2.4	DEVIATION FROM TEST STANDARD.....	73
5.2.5	TEST SETUP.....	74
5.2.6	EUT OPERATING CONDITIONS.....	74
5.2.7	TEST RESULTS.....	75



A D T

5.3	6dB BANDWIDTH MEASUREMENT .....	77
5.3.1	LIMITS OF 6dB BANDWIDTH MEASUREMENT .....	77
5.3.2	TEST INSTRUMENTS.....	77
5.3.3	TEST PROCEDURE.....	77
5.3.4	DEVIATION FROM TEST STANDARD.....	78
5.3.5	TEST SETUP.....	78
5.3.6	EUT OPERATING CONDITIONS .....	78
5.3.7	TEST RESULTS .....	79
5.4	MAXIMUM OUTPUT POWER .....	81
5.4.1	LIMITS OF MAXIMUM OUTPUT POWER MEASUREMENT.....	81
5.4.2	INSTRUMENTS.....	81
5.4.3	TEST PROCEDURE.....	81
5.4.4	DEVIATION FROM TEST STANDARD.....	82
5.4.5	TEST SETUP .....	82
5.4.6	EUT OPERATING CONDITIONS .....	82
5.4.7	TEST RESULTS .....	83
5.5	POWER SPECTRAL DENSITY MEASUREMENT .....	84
5.5.1	LIMITS OF POWER SPECTRAL DENSITY MEASUREMENT .....	84
5.5.2	TEST INSTRUMENTS.....	84
5.5.3	TEST PROCEDURE.....	84
5.5.4	DEVIATION FROM TEST STANDARD.....	85
5.5.5	TEST SETUP.....	85
5.5.6	EUT OPERATING CONDITION.....	85
5.5.7	TEST RESULTS .....	86
5.6	BAND EDGES MEASUREMENT .....	88
5.6.1	LIMITS OF BAND EDGES MEASUREMENT .....	88
5.6.2	TEST INSTRUMENTS.....	88
5.6.3	TEST PROCEDURE.....	88
5.6.4	DEVIATION FROM TEST STANDARD.....	88
5.6.5	EUT OPERATING CONDITION.....	89
5.6.6	TEST RESULTS .....	89
6.	PHOTOGRAPHS OF THE TEST CONFIGURATION .....	96
7.	INFORMATION ON THE TESTING LABORATORIES .....	97
8.	APPENDIX A - MODIFICATIONS RECORDERS FOR ENGINEERING CHANGES TO THE EUT BY THE LAB.....	98



A D T

## RELEASE CONTROL RECORD

ISSUE NO.	REASON FOR CHANGE	DATE ISSUED
Original release	N/A	Feb. 10, 2011



A D T

## 1. CERTIFICATION

**PRODUCT:** Tablet Device

**MODEL:** RDJ21WW

**BRAND:** RIM

**APPLICANT:** Research In Motion Limited

**TEST SAMPLE:** ENGINEERING SAMPLE

**TESTED:** Jan. 18 ~ Feb. 08, 2011

**STANDARDS:** **FCC Part 15, Subpart C (Section 15.247)**

ANSI C63.4-2003

ANSI C63.10-2009

The above equipment (Model: RDJ21WW) has been tested by **Bureau Veritas Consumer Products Services (H.K.) Ltd., Taoyuan Branch**, and found compliance with the requirement of the above standards. The test record, data evaluation & Equipment Under Test (EUT) configurations represented herein are true and accurate accounts of the measurements of the sample's EMC characteristics under the conditions specified in this report.

PREPARED BY :  , DATE : Feb. 10, 2011  
Joanna Wang / Senior Specialist

APPROVED BY :  , DATE : Feb. 10, 2011  
Gary Chang / Assistant Manager



## 2. SUMMARY OF TEST RESULTS

The EUT has been tested according to the following specifications:

APPLIED STANDARD: FCC PART 15, SUBPART C (SECTION 15.247)			
STANDARD SECTION	TEST TYPE AND LIMIT	RESULT	REMARK
15.207	AC Power Conducted Emission	PASS	Meet the requirement of limit. Minimum passing margin is -14.26dB at 0.478MHz.
15.247(a)(2)	Spectrum Bandwidth of a Direct Sequence Spread Spectrum System Limit: min. 500kHz	PASS	Meet the requirement of limit.
15.247(b)	Maximum Output Power Limit: max. 30dBm	PASS	Meet the requirement of limit.
15.247(d)	Radiated Emissions Limit: Table 15.209	PASS	Meet the requirement of limit. Minimum passing margin is -1.4dB at 2390.00MHz.
15.247(e)	Power Spectral Density Limit: max. 8dBm	PASS	Meet the requirement of limit.
15.247(d)	Band Edge Measurement Limit: 20dB less than the peak value of fundamental frequency	PASS	Meet the requirement of limit.
15.203	Antenna Requirement	PASS	Antenna connector is I-pex not a standard connector.

### 2.1 MEASUREMENT UNCERTAINTY

Where relevant, the following measurement uncertainty levels have been estimated for tests performed on the EUT as specified in CISPR 16-4-2:

MEASUREMENT	FREQUENCY	UNCERTAINTY
Conducted emissions	9kHz~30MHz	2.44dB
Radiated emissions	30MHz ~ 200MHz	3.19dB
	200MHz ~1000MHz	3.21dB
	1GHz ~ 18GHz	2.26dB
	18GHz ~ 40GHz	1.94dB

This uncertainty represents an expanded uncertainty expressed at approximately the 95% confidence level using a coverage factor of k = 2.



A D T

### 3. GENERAL INFORMATION

#### 3.1 GENERAL DESCRIPTION OF EUT

<b>EUT</b>	Tablet Device
<b>MODEL NO.</b>	RDJ21WW
<b>FCC ID</b>	L6ARDJ20WW
<b>POWER SUPPLY</b>	5Vdc (adapter) 3.7Vdc (battery)
<b>MODULATION TYPE</b>	CCK, DQPSK, DBPSK for DSSS 64QAM, 16QAM, QPSK, BPSK for OFDM
<b>MODULATION TECHNOLOGY</b>	DSSS, OFDM
<b>TRANSFER RATE</b>	802.11b:11.0/ 5.5/ 2.0/ 1.0Mbps 802.11g: 54.0/ 48.0/ 36.0/ 24.0/ 18.0/ 12.0/ 9.0/ 6.0Mbps 802.11a: 54.0/ 48.0/ 36.0/ 24.0/ 18.0/ 12.0/ 9.0/ 6.0Mbps 802.11n (20MHz): up to 72.0Mbps
<b>OPERATING FREQUENCY</b>	<b>2.4GHz:</b> 2412 ~ 2462MHz <b>5.0GHz:</b> 5745 ~ 5825MHz
<b>NUMBER OF CHANNEL</b>	<b>2.4GHz:</b> 11 <b>5.0GHz:</b> 5
<b>OUTPUT POWER</b>	309.0mW for 2412 ~ 2462MHz 281.8mW for 5745 ~ 5825MHz
<b>ANTENNA TYPE</b>	<b>2.4GHz:</b> PIFA antenna with -1.2dBi gain <b>5.0GHz:</b> PIFA antenna with -0.1dBi gain
<b>ANTENNA CONNECTOR</b>	I-pex
<b>I/O PORTS</b>	Refer to users' manual
<b>DATA CABLE</b>	0.3m non-shielded USB cable without core 1.0m non-shielded USB cable without core 1.2m non-shielded USB cable without core 1.5m non-shielded USB cable without core
<b>ACCESSORY DEVICES</b>	Adapter, battery

**NOTE:**

1. The EUT is a Tablet Device. The test data are separated into following test reports.

	<b>TEST STANDARD</b>	<b>REFERENCE REPORT</b>
<b>WLAN 802.11b/g, 802.11n</b>	FCC Part 15, Subpart C (Section 15.247)	RF110111C23
<b>WLAN 802.11a, 802.11n</b> (5745~5825 MHz)		
<b>WLAN 802.11a, 802.11n</b> (5180~5320MHz & 5500 ~5700MHz)	FCC Part 15, Subpart E (Section 15.407)	RF110111C23-1
<b>Bluetooth</b>	FCC Part 15, Subpart C (Section 15.247)	RF110111C23-2
<b>WLAN 802.11a, 802.11n</b> (For DFS report) (5250~5350MHz & 5470~5725MHz)	FCC Part 15, Subpart E (Section 15.407)	RF110111C23-3





2. The frequency bands used in this EUT are listed as follows:

Frequency Band (MHz)	2412~2462	5180~5320	5500~5700	5745~5825
802.11b	√	-	-	-
802.11g	√	-	-	-
802.11a	-	√	√	√
802.11n (20MHz)	√	√	√	√

3. The EUT provides one completed transmitter and one receiver.

MODULATION MODE	TX FUNCTION
802.11b	1TX
802.11g	1TX
802.11a	1TX
802.11n (20MHz)	1TX

4. The EUT was powered by the following adapters and battery:

ADAPTER 1	
BRAND	Phihong(BlackBerry)
MODEL	PSAC10R-050QT
INPUT POWER	100-240Vac, 50-60Hz, 0.3A
OUTPUT POWER	5Vdc, 2A
POWER LINE	DC: 2m non-shielded cable without core

ADAPTER 2	
BRAND	Tamura(BlackBerry)
MODEL	RQT050180
INPUT POWER	100-240Vac, 50/60Hz, 0.4A
OUTPUT POWER	5Vdc, 1.8A
POWER LINE	DC: 2m non-shielded cable without core

ADAPTER 3	
BRAND	Phihong(BlackBerry)
MODEL	PSM09A-050RIM
INPUT POWER	100-240Vac, 50/60Hz, 0.3A
OUTPUT POWER	5Vdc, 1.8A
POWER LINE	DC: 2m non-shielded cable without core

ADAPTER 4	
BRAND	PI Electronics
MODEL	AD8213HF
INPUT POWER	100-240Vac, 50/60Hz, 0.3A
OUTPUT POWER	5Vdc, 1.8A
POWER LINE	DC: 2m non-shielded cable without core

\* The above adapters had been pre-tested and adapter 1 was found and chose to be the worst case for final test.

BATTERY	
RATING	3.7Vdc, 5400mAH

5. The above EUT information is declared by manufacturer and for more detailed features description, please refer to the manufacturer's specifications or user's manual.

### 3.2 DESCRIPTION OF TEST MODES

#### FOR 2.4GHz:

11 channels are provided for 802.11b, 802.11g and 802.11n (20MHz):

CHANNEL	FREQUENCY	CHANNEL	FREQUENCY
1	2412MHz	7	2442MHz
2	2417MHz	8	2447MHz
3	2422MHz	9	2452MHz
4	2427MHz	10	2457MHz
5	2432MHz	11	2462MHz
6	2437MHz		

#### FOR 5.0GHz (5745 ~ 5825MHz):

5 channels are provided for 802.11a, 802.11n (20MHz):

CHANNEL	FREQUENCY	CHANNEL	FREQUENCY
149	5745MHz	161	5805MHz
153	5765MHz	165	5825MHz
157	5785MHz		

#### 3.2.1 CONFIGURATION OF SYSTEM UNDER TEST

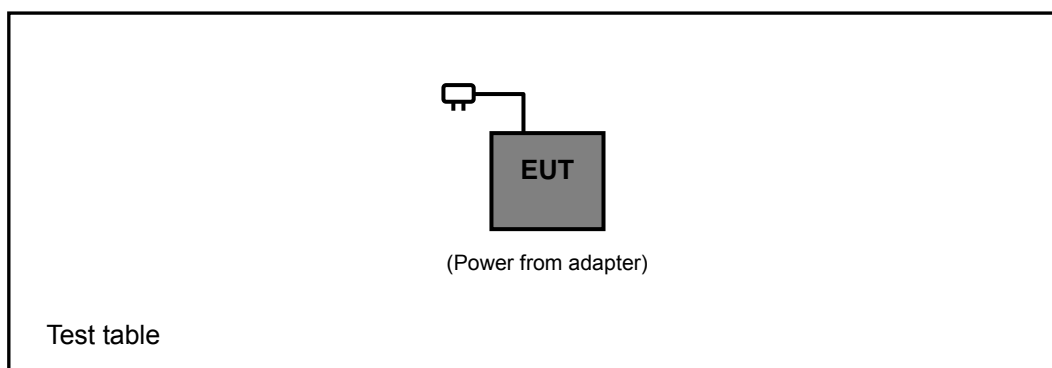



### 3.2.2 TEST MODE APPLICABILITY AND TESTED CHANNEL DETAIL

#### FOR 2.4GHz:

EUT CONFIGURE MODE	APPLICABLE TO				DESCRIPTION
	RE≥1G	RE<1G	PLC	APCM	
-	√	√	√	√	-

Where **RE≥1G**: Radiated Emission above 1GHz      **RE<1G**: Radiated Emission below 1GHz  
**PLC**: Power Line Conducted Emission      **APCM**: Antenna Port Conducted Measurement

#### RADIATED EMISSION TEST (ABOVE 1GHz):

- Pre-Scan has been conducted to determine the worst-case mode from all possible combinations between available modulations, XYZ axis and antenna ports (if EUT with antenna diversity architecture).
- Following channel(s) was (were) selected for the final test as listed below.

MODE	AVAILABLE CHANNEL	TESTED CHANNEL	MODULATION TECHNOLOGY	MODULATION TYPE	DATA RATE (Mbps)	AXIS
802.11b	1 to 11	1, 6, 11	DSSS	DBPSK	1.0	Y
802.11g	1 to 11	1, 6, 11	OFDM	BPSK	6.0	Y
802.11n (20MHz)	1 to 11	1, 6, 11	OFDM	BPSK	6.5	Y

#### RADIATED EMISSION TEST (BELOW 1GHz):

- Pre-Scan has been conducted to determine the worst-case mode from all possible combinations between available modulations, XYZ axis and antenna ports (if EUT with antenna diversity architecture).
- Following channel(s) was (were) selected for the final test as listed below.

MODE	AVAILABLE CHANNEL	TESTED CHANNEL	MODULATION TECHNOLOGY	MODULATION TYPE	DATA RATE (Mbps)	AXIS
802.11g	1 to 11	6	OFDM	BPSK	6.0	Y

#### POWER LINE CONDUCTED EMISSION TEST:

- Pre-Scan has been conducted to determine the worst-case mode from all possible combinations between available modulations, data rates and antenna ports (if EUT with antenna diversity architecture).
- Following channel(s) was (were) selected for the final test as listed below.

MODE	AVAILABLE CHANNEL	TESTED CHANNEL	MODULATION TECHNOLOGY	MODULATION TYPE	DATA RATE (Mbps)
802.11g	1 to 11	6	OFDM	BPSK	6.0



A D T

**BANDEDGE MEASUREMENT:**

- Pre-Scan has been conducted to determine the worst-case mode from all possible combinations between available modulations, data rates and antenna ports (if EUT with antenna diversity architecture).
- Following channel(s) was (were) selected for the final test as listed below.

MODE	AVAILABLE CHANNEL	TESTED CHANNEL	MODULATION TECHNOLOGY	MODULATION TYPE	DATA RATE (Mbps)
802.11b	1 to 11	1, 11	DSSS	DBPSK	1.0
802.11g	1 to 11	1, 11	OFDM	BPSK	6.0
802.11n (20MHz)	1 to 11	1, 11	OFDM	BPSK	6.5

**ANTENNA PORT CONDUCTED MEASUREMENT:**

- This item includes all test value of each mode, but only includes spectrum plot of worst value of each mode.
- Pre-Scan has been conducted to determine the worst-case mode from all possible combinations between available modulations, data rates and antenna ports (if EUT with antenna diversity architecture).
- Following channel(s) was (were) selected for the final test as listed below.

MODE	AVAILABLE CHANNEL	TESTED CHANNEL	MODULATION TECHNOLOGY	MODULATION TYPE	DATA RATE (Mbps)
802.11b	1 to 11	1, 6, 11	DSSS	DBPSK	1.0
802.11g	1 to 11	1, 6, 11	OFDM	BPSK	6.0
802.11n (20MHz)	1 to 11	1, 6, 11	OFDM	BPSK	6.5

**TEST CONDITION:**

APPLICABLE TO	ENVIRONMENTAL CONDITIONS	INPUT POWER	TESTED BY
RE≥1G	24deg. C, 64%RH, 1021 hPa	120Vac, 60Hz	Match Tsui
RE<1G	24deg. C, 64%RH, 1019 hPa	120Vac, 60Hz	Match Tsui
PLC	22deg. C, 64%RH, 1021 hPa	120Vac, 60Hz	David Huang
APCM	22deg. C, 65%RH, 1009 hPa	120Vac, 60Hz	David Huang



A D T

### FOR 5.745 ~ 5.825GHz:

EUT CONFIGURE MODE	APPLICABLE TO				DESCRIPTION
	RE $\geq$ 1G	RE<1G	PLC	APCM	
-	√	√	√	√	-

Where RE $\geq$ 1G: Radiated Emission above 1GHz RE<1G: Radiated Emission below 1GHz  
PLC: Power Line Conducted Emission APCM: Antenna Port Conducted Measurement

### RADIATED EMISSION TEST (ABOVE 1GHz):

- Pre-Scan has been conducted to determine the worst-case mode from all possible combinations between available modulations, XYZ axis and antenna ports (if EUT with antenna diversity architecture).
- Following channel(s) was (were) selected for the final test as listed below.

MODE	AVAILABLE CHANNEL	TESTED CHANNEL	MODULATION TECHNOLOGY	MODULATION TYPE	DATA RATE (Mbps)	AXIS
802.11a	149 to 165	149, 157, 165	OFDM	BPSK	6.0	Y
802.11n (20MHz)	149 to 165	149, 157, 165	OFDM	BPSK	6.5	Y

### RADIATED EMISSION TEST (BELOW 1GHz):

- Pre-Scan has been conducted to determine the worst-case mode from all possible combinations between available modulations, XYZ axis and antenna ports (if EUT with antenna diversity architecture).
- Following channel(s) was (were) selected for the final test as listed below.

MODE	AVAILABLE CHANNEL	TESTED CHANNEL	MODULATION TECHNOLOGY	MODULATION TYPE	DATA RATE (Mbps)	AXIS
802.11a	149 to 165	157	OFDM	BPSK	6.0	Y

### POWER LINE CONDUCTED EMISSION TEST:

- Pre-Scan has been conducted to determine the worst-case mode from all possible combinations between available modulations, data rates and antenna ports (if EUT with antenna diversity architecture).
- Following channel(s) was (were) selected for the final test as listed below.

MODE	AVAILABLE CHANNEL	TESTED CHANNEL	MODULATION TECHNOLOGY	MODULATION TYPE	DATA RATE (Mbps)
802.11a	149 to 165	157	OFDM	BPSK	6.0



**BANDEDGE MEASUREMENT:**

- Pre-Scan has been conducted to determine the worst-case mode from all possible combinations between available modulations, data rates and antenna ports (if EUT with antenna diversity architecture).
- Following channel(s) was (were) selected for the final test as listed below.

MODE	AVAILABLE CHANNEL	TESTED CHANNEL	MODULATION TECHNOLOGY	MODULATION TYPE	DATA RATE (Mbps)
802.11a	149 to 165	149, 165	OFDM	BPSK	6.0
802.11n (20MHz)	149 to 165	149, 165	OFDM	BPSK	6.5

**ANTENNA PORT CONDUCTED MEASUREMENT:**

- This item includes all test value of each mode, but only includes spectrum plot of worst value of each mode.
- Pre-Scan has been conducted to determine the worst-case mode from all possible combinations between available modulations, data rates and antenna ports (if EUT with antenna diversity architecture).
- Following channel(s) was (were) selected for the final test as listed below.

MODE	AVAILABLE CHANNEL	TESTED CHANNEL	MODULATION TECHNOLOGY	MODULATION TYPE	DATA RATE (Mbps)
802.11a	149 to 165	149, 157, 165	OFDM	BPSK	6.0
802.11n (20MHz)	149 to 165	149, 157, 165	OFDM	BPSK	6.5

**TEST CONDITION:**

APPLICABLE TO	ENVIRONMENTAL CONDITIONS	INPUT POWER	TESTED BY
RE≥1G	24deg. C, 64%RH, 1015 hPa	120Vac, 60Hz	Match Tsui
RE<1G	24deg. C, 64%RH, 1019 hPa	120Vac, 60Hz	Match Tsui
PLC	22deg. C, 64%RH, 1021 hPa	120Vac, 60Hz	David Huang
APCM	22deg. C, 65%RH, 1009 hPa	120Vac, 60Hz	David Huang



A D T

### 3.3 GENERAL DESCRIPTION OF APPLIED STANDARDS

The EUT is a RF Product. According to the specifications of the manufacturer, it must comply with the requirements of the following standards:

**FCC Part 15, Subpart C (15.247)**

**ANSI C63.4-2003**

**ANSI C63.10-2009**

All test items have been performed and recorded as per the above standards.

**NOTE:** The EUT is also considered as a kind of computer peripheral, because the connection to computer is necessary for typical use. It has been verified to comply with the requirements of FCC Part 15, Subpart B, Class B (DoC). The test report has been issued separately.

### 3.4 DESCRIPTION OF SUPPORT UNITS

The EUT has been tested as an independent unit.



A D T

## 4. TEST TYPES AND RESULTS (FOR 2.4GHz BAND)

### 4.1 RADIATED EMISSION MEASUREMENT

#### 4.1.1 LIMITS OF RADIATED EMISSION MEASUREMENT

Emissions radiated outside of the specified bands, shall be according to the general radiated limits in 15.209 as following:

FREQUENCIES (MHz)	FIELD STRENGTH (microvolts/meter)	MEASUREMENT DISTANCE (meters)
0.009 ~ 0.490	2400/F(kHz)	300
0.490 ~ 1.705	24000/F(kHz)	30
1.705 ~ 30.0	30	30
30 ~ 88	100	3
88 ~ 216	150	3
216 ~ 960	200	3
Above 960	500	3

**NOTE:**

1. The lower limit shall apply at the transition frequencies.
2. Emission level (dBuV/m) = 20 log Emission level (uV/m).
3. As shown in 15.35(b), for frequencies above 1000MHz, the field strength limits are based on average detector, however, the peak field strength of any emission shall not exceed the maximum permitted average limits, specified above by more than 20dB under any condition of modulation.





A D T

#### 4.1.2 TEST INSTRUMENTS

DESCRIPTION & MANUFACTURER	MODEL NO.	SERIAL NO.	DATE OF CALIBRATION	DUE DATE OF CALIBRATION
Test Receiver ROHDE & SCHWARZ	ESI7	838496/016	Dec. 27, 2010	Dec. 26, 2011
Spectrum Analyzer ROHDE & SCHWARZ	FSU43	100115	Aug. 02, 2010	Aug. 01, 2011
BILOG Antenna SCHWARZBECK	VULB9168	9168-155	Apr. 28, 2010	Apr. 27, 2011
HORN Antenna SCHWARZBECK	BBHA 9120D	9120D-408	Jan. 06, 2011	Jan. 05, 2012
HORN Antenna SCHWARZBECK	BBHA 9170	BBHA9170243	Dec. 27, 2010	Dec. 26, 2011
Preamplifier Agilent	8449B	3008A01961	Nov. 02, 2010	Nov. 01, 2011
Preamplifier Agilent	8447D	2944A10738	Nov. 02, 2010	Nov. 01, 2011
RF signal cable HUBER+SUHNNER	SUCOFLEX 104	274041/4	Aug. 21, 2010	Aug. 20, 2011
RF signal cable HUBER+SUHNNER	SUCOFLEX 104	283397/4	Aug. 21, 2010	Aug. 20, 2011
Software ADT.	ADT_Radiated_ V7.6.15.9.2	NA	NA	NA
Antenna Tower inn-co GmbH	MA 4000	010303	NA	NA
Antenna Tower Controller inn-co GmbH	CO2000	019303	NA	NA
Turn Table ADT.	TT100.	TT93021704	NA	NA
Turn Table Controller ADT.	SC100.	SC93021704	NA	NA

- NOTE:**
1. The calibration interval of the above test instruments is 12 months and the calibrations are traceable to NML/ROC and NIST/USA.
  2. The test was performed in HwaYa Chamber 4.
  3. The horn antenna and HP preamplifier (model: 8449B) are used only for the measurement of emission frequency above 1GHz if tested.
  4. The FCC Site Registration No. is 988962.
  5. The IC Site Registration No. is IC7450F-4.



#### 4.1.3 TEST PROCEDURES

- a. The EUT was placed on the top of a rotating table 0.8 meters above the ground at a 3 meters semi-anechoic chamber. The table was rotated 360 degrees to determine the position of the highest radiation.
- b. The EUT was set 3 meters away from the interference-receiving antenna, which was mounted on the top of a variable-height antenna tower.
- c. The antenna is a broadband antenna, and its height is varied from one meter to four meters above the ground to determine the maximum value of the field strength. Both horizontal and vertical polarizations of the antenna are set to make the measurement.
- d. For each suspected emission, the EUT was arranged to its worst case and then the antenna was tuned to heights from 1 meter to 4 meters and the rotatable table was turned from 0 degrees to 360 degrees to find the maximum reading.
- e. The test-receiver system was set to Peak Detect Function and Specified Bandwidth with Maximum Hold Mode.
- f. If the emission level of the EUT in peak mode was lower than the limit specified, then testing could be stopped and the peak values of the EUT would be reported. Otherwise the emissions would be re-tested one by one using peak, quasi-peak or average method as specified and then reported in a data sheet.

**NOTE:**

1. The resolution bandwidth and video bandwidth of test receiver/spectrum analyzer is 120kHz for Quasi-peak detection at frequency below 1GHz.
2. The resolution bandwidth of test receiver/spectrum analyzer is 1MHz and video bandwidth is 3MHz for Peak detection at frequency above 1GHz.
3. The resolution bandwidth of test receiver/spectrum analyzer is 1MHz and the video bandwidth is 10Hz for Average detection (AV) at frequency above 1GHz.
4. All modes of operation were investigated and the worst-case emissions are reported.

#### 4.1.4 DEVIATION FROM TEST STANDARD

No deviation.

#### 4.1.5 TEST SETUP

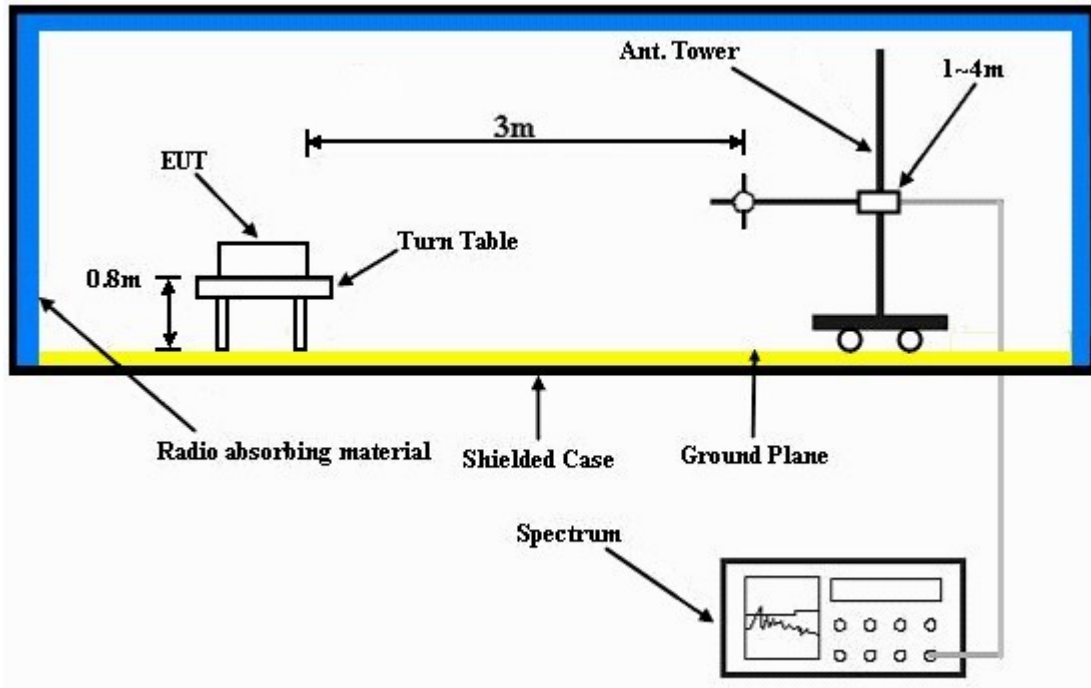

For the actual test configuration, please refer to the attached file (Test Setup Photo).

#### 4.1.6 EUT OPERATING CONDITIONS

- Placed the EUT on the testing table.
- Set the EUT under transmitting condition continuously at specific channel frequency.



A D T

#### 4.1.7 TEST RESULT

##### 802.11b

EUT TEST CONDITION		MEASUREMENT DETAIL	
CHANNEL	Channel 1	FREQUENCY RANGE	1 ~ 25GHz
INPUT POWER	120Vac, 60 Hz	DETECTOR FUNCTION	Peak (PK) Average (AV)
ENVIRONMENTAL CONDITIONS	24deg. C, 64%RH 1021 hPa	TESTED BY	Match Tsui

ANTENNA POLARITY & TEST DISTANCE: HORIZONTAL AT 3 M								
NO.	FREQ. (MHz)	EMISSION LEVEL (dBuV/m)	LIMIT (dBuV/m)	MARGIN (dB)	ANTENNA HEIGHT (m)	TABLE ANGLE (Degree)	RAW VALUE (dBuV)	CORRECTION FACTOR (dB/m)
1	2385.00	56.9 PK	74.0	-17.1	1.38 H	140	25.80	31.10
2	2385.00	46.5 AV	54.0	-7.5	1.38 H	140	15.40	31.10
3	*2412.00	107.3 PK			1.36 H	146	76.10	31.20
4	*2412.00	103.9 AV			1.36 H	146	72.70	31.20
5	4824.00	47.4 PK	74.0	-26.6	1.29 H	123	10.20	37.20
6	4824.00	37.8 AV	54.0	-16.2	1.29 H	123	0.60	37.20
ANTENNA POLARITY & TEST DISTANCE: VERTICAL AT 3 M								
NO.	FREQ. (MHz)	EMISSION LEVEL (dBuV/m)	LIMIT (dBuV/m)	MARGIN (dB)	ANTENNA HEIGHT (m)	TABLE ANGLE (Degree)	RAW VALUE (dBuV)	CORRECTION FACTOR (dB/m)
1	2386.00	57.0 PK	74.0	-17.0	1.25 V	77	25.90	31.10
2	2386.00	44.0 AV	54.0	-10.0	1.25 V	77	12.90	31.10
3	*2412.00	102.7 PK			1.20 V	98	71.50	31.20
4	*2412.00	98.7 AV			1.20 V	98	67.50	31.20
5	4824.00	46.5 PK	74.0	-27.5	1.28 V	91	9.30	37.20
6	4824.00	36.3 AV	54.0	-17.7	1.28 V	91	-0.90	37.20

- REMARKS:**
1. Emission level (dBuV/m) = Raw Value (dBuV) + Correction Factor (dB/m).
  2. Correction Factor (dB/m) = Antenna Factor (dB/m) + Cable Factor (dB).
  3. The other emission levels were very low against the limit.
  4. Margin value = Emission level – Limit value.
  5. “ \* “: Fundamental frequency.



A D T

EUT TEST CONDITION		MEASUREMENT DETAIL	
CHANNEL	Channel 6	FREQUENCY RANGE	1 ~ 25GHz
INPUT POWER	120Vac, 60 Hz	DETECTOR FUNCTION	Peak (PK) Average (AV)
ENVIRONMENTAL CONDITIONS	24deg. C, 64%RH 1021 hPa	TESTED BY	Match Tsui

ANTENNA POLARITY & TEST DISTANCE: HORIZONTAL AT 3 M								
NO.	FREQ. (MHz)	EMISSION LEVEL (dBuV/m)	LIMIT (dBuV/m)	MARGIN (dB)	ANTENNA HEIGHT (m)	TABLE ANGLE (Degree)	RAW VALUE (dBuV)	CORRECTION FACTOR (dB/m)
1	2390.00	56.1 PK	74.0	-17.9	1.33 H	144	25.00	31.10
2	2390.00	44.1 AV	54.0	-9.9	1.33 H	144	13.00	31.10
3	*2437.00	107.6 PK			1.33 H	144	76.40	31.20
4	*2437.00	104.1 AV			1.33 H	144	72.90	31.20
5	4874.00	48.6 PK	74.0	-25.4	1.22 H	120	11.30	37.30
6	4874.00	39.2 AV	54.0	-14.8	1.22 H	120	1.90	37.30

ANTENNA POLARITY & TEST DISTANCE: VERTICAL AT 3 M								
NO.	FREQ. (MHz)	EMISSION LEVEL (dBuV/m)	LIMIT (dBuV/m)	MARGIN (dB)	ANTENNA HEIGHT (m)	TABLE ANGLE (Degree)	RAW VALUE (dBuV)	CORRECTION FACTOR (dB/m)
1	2390.00	56.2 PK	74.0	-17.8	1.21 V	75	25.10	31.10
2	2390.00	43.9 AV	54.0	-10.1	1.21 V	75	12.80	31.10
3	*2437.00	102.9 PK			1.21 V	75	71.70	31.20
4	*2437.00	98.8 AV			1.21 V	75	67.60	31.20
5	4874.00	46.8 PK	74.0	-27.2	1.24 V	77	9.50	37.30
6	4874.00	37.2 AV	54.0	-16.8	1.24 V	77	-0.10	37.30

- REMARKS:**
1. Emission level (dBuV/m) = Raw Value (dBuV) + Correction Factor (dB/m).
  2. Correction Factor (dB/m) = Antenna Factor (dB/m) + Cable Factor (dB).
  3. The other emission levels were very low against the limit.
  4. Margin value = Emission level – Limit value.
  5. “ \* “: Fundamental frequency.



A D T

EUT TEST CONDITION		MEASUREMENT DETAIL	
CHANNEL	Channel 11	FREQUENCY RANGE	1 ~ 25GHz
INPUT POWER	120Vac, 60 Hz	DETECTOR FUNCTION	Peak (PK) Average (AV)
ENVIRONMENTAL CONDITIONS	24deg. C, 64%RH 1021 hPa	TESTED BY	Match Tsui

ANTENNA POLARITY & TEST DISTANCE: HORIZONTAL AT 3 M								
NO.	FREQ. (MHz)	EMISSION LEVEL (dBuV/m)	LIMIT (dBuV/m)	MARGIN (dB)	ANTENNA HEIGHT (m)	TABLE ANGLE (Degree)	RAW VALUE (dBuV)	CORRECTION FACTOR (dB/m)
1	*2462.00	108.4 PK			1.31 H	144	77.10	31.30
2	*2462.00	104.7 AV			1.31 H	144	73.40	31.30
3	2486.00	58.5 PK	74.0	-15.5	1.29 H	140	27.10	31.40
4	2486.00	47.3 AV	54.0	-6.7	1.29 H	140	15.90	31.40
5	4924.00	48.9 PK	74.0	-25.1	1.28 H	118	11.50	37.40
6	4924.00	43.1 AV	54.0	-10.9	1.28 H	118	5.70	37.40
ANTENNA POLARITY & TEST DISTANCE: VERTICAL AT 3 M								
NO.	FREQ. (MHz)	EMISSION LEVEL (dBuV/m)	LIMIT (dBuV/m)	MARGIN (dB)	ANTENNA HEIGHT (m)	TABLE ANGLE (Degree)	RAW VALUE (dBuV)	CORRECTION FACTOR (dB/m)
1	*2462.00	103.2 PK			1.18 V	87	71.90	31.30
2	*2462.00	99.4 AV			1.18 V	87	68.10	31.30
3	2486.00	55.5 PK	74.0	-18.5	1.19 V	70	24.10	31.40
4	2486.00	44.7 AV	54.0	-9.3	1.19 V	70	13.30	31.40
5	4924.00	47.0 PK	74.0	-27.0	1.23 V	81	9.60	37.40
6	4924.00	38.8 AV	54.0	-15.2	1.23 V	81	1.40	37.40

- REMARKS:**
1. Emission level (dBuV/m) = Raw Value (dBuV) + Correction Factor (dB/m).
  2. Correction Factor (dB/m) = Antenna Factor (dB/m) + Cable Factor (dB).
  3. The other emission levels were very low against the limit.
  4. Margin value = Emission level – Limit value.
  5. “ \* “: Fundamental frequency.



A D T

802.11g

EUT TEST CONDITION		MEASUREMENT DETAIL	
CHANNEL	Channel 1	FREQUENCY RANGE	1 ~ 25GHz
INPUT POWER	120Vac, 60 Hz	DETECTOR FUNCTION	Peak (PK) Average (AV)
ENVIRONMENTAL CONDITIONS	24deg. C, 64%RH 1021 hPa	TESTED BY	Match Tsui

ANTENNA POLARITY & TEST DISTANCE: HORIZONTAL AT 3 M								
NO.	FREQ. (MHz)	EMISSION LEVEL (dBuV/m)	LIMIT (dBuV/m)	MARGIN (dB)	ANTENNA HEIGHT (m)	TABLE ANGLE (Degree)	RAW VALUE (dBuV)	CORRECTION FACTOR (dB/m)
1	2390.00	72.6 PK	74.0	-1.4	1.36 H	144	41.50	31.10
2	2390.00	51.7 AV	54.0	-2.3	1.36 H	144	20.60	31.10
3	*2412.00	108.8 PK			1.36 H	146	77.60	31.20
4	*2412.00	98.4 AV			1.36 H	146	67.20	31.20
5	4824.00	45.3 PK	74.0	-28.7	1.00 H	360	8.10	37.20
6	4824.00	32.8 AV	54.0	-21.2	1.00 H	360	-4.40	37.20
ANTENNA POLARITY & TEST DISTANCE: VERTICAL AT 3 M								
NO.	FREQ. (MHz)	EMISSION LEVEL (dBuV/m)	LIMIT (dBuV/m)	MARGIN (dB)	ANTENNA HEIGHT (m)	TABLE ANGLE (Degree)	RAW VALUE (dBuV)	CORRECTION FACTOR (dB/m)
1	2390.00	63.6 PK	74.0	-10.4	1.00 V	81	32.50	31.10
2	2390.00	48.2 AV	54.0	-5.8	1.00 V	81	17.10	31.10
3	*2412.00	104.6 PK			1.20 V	100	73.40	31.20
4	*2412.00	94.2 AV			1.20 V	100	63.00	31.20
5	4824.00	45.2 PK	74.0	-28.8	1.00 V	355	8.00	37.20
6	4824.00	32.4 AV	54.0	-21.6	1.00 V	355	-4.80	37.20

- REMARKS:**
1. Emission level (dBuV/m) = Raw Value (dBuV) + Correction Factor (dB/m).
  2. Correction Factor (dB/m) = Antenna Factor (dB/m) + Cable Factor (dB).
  3. The other emission levels were very low against the limit.
  4. Margin value = Emission level – Limit value.
  5. “ \* “: Fundamental frequency.



A D T

EUT TEST CONDITION		MEASUREMENT DETAIL	
CHANNEL	Channel 6	FREQUENCY RANGE	1 ~ 25GHz
INPUT POWER	120Vac, 60 Hz	DETECTOR FUNCTION	Peak (PK) Average (AV)
ENVIRONMENTAL CONDITIONS	24deg. C, 64%RH 1021 hPa	TESTED BY	Match Tsui

ANTENNA POLARITY & TEST DISTANCE: HORIZONTAL AT 3 M								
NO.	FREQ. (MHz)	EMISSION LEVEL (dBuV/m)	LIMIT (dBuV/m)	MARGIN (dB)	ANTENNA HEIGHT (m)	TABLE ANGLE (Degree)	RAW VALUE (dBuV)	CORRECTION FACTOR (dB/m)
1	2390.00	56.3 PK	74.0	-17.7	1.39 H	141	25.20	31.10
2	2390.00	44.3 AV	54.0	-9.7	1.39 H	141	13.20	31.10
3	*2437.00	109.7 PK			1.39 H	141	78.50	31.20
4	*2437.00	99.5 AV			1.39 H	141	68.30	31.20
5	4874.00	46.2 PK	74.0	-27.8	1.21 H	360	8.90	37.30
6	4874.00	33.1 AV	54.0	-20.9	1.21 H	360	-4.20	37.30

ANTENNA POLARITY & TEST DISTANCE: VERTICAL AT 3 M								
NO.	FREQ. (MHz)	EMISSION LEVEL (dBuV/m)	LIMIT (dBuV/m)	MARGIN (dB)	ANTENNA HEIGHT (m)	TABLE ANGLE (Degree)	RAW VALUE (dBuV)	CORRECTION FACTOR (dB/m)
1	2390.00	56.2 PK	74.0	-17.8	1.14 V	62	25.10	31.10
2	2390.00	44.0 AV	54.0	-10.0	1.14 V	62	12.90	31.10
3	*2437.00	105.0 PK			1.14 V	62	73.80	31.20
4	*2437.00	94.7 AV			1.14 V	62	63.50	31.20
5	4874.00	45.7 PK	74.0	-28.3	1.04 V	360	8.40	37.30
6	4874.00	32.8 AV	54.0	-21.2	1.04 V	360	-4.50	37.30

- REMARKS:**
1. Emission level (dBuV/m) = Raw Value (dBuV) + Correction Factor (dB/m).
  2. Correction Factor (dB/m) = Antenna Factor (dB/m) + Cable Factor (dB).
  3. The other emission levels were very low against the limit.
  4. Margin value = Emission level – Limit value.
  5. “ \* “: Fundamental frequency.





A D T

EUT TEST CONDITION		MEASUREMENT DETAIL	
CHANNEL	Channel 11	FREQUENCY RANGE	1 ~ 25GHz
INPUT POWER	120Vac, 60 Hz	DETECTOR FUNCTION	Peak (PK) Average (AV)
ENVIRONMENTAL CONDITIONS	24deg. C, 64%RH 1021 hPa	TESTED BY	Match Tsui

ANTENNA POLARITY & TEST DISTANCE: HORIZONTAL AT 3 M								
NO.	FREQ. (MHz)	EMISSION LEVEL (dBuV/m)	LIMIT (dBuV/m)	MARGIN (dB)	ANTENNA HEIGHT (m)	TABLE ANGLE (Degree)	RAW VALUE (dBuV)	CORRECTION FACTOR (dB/m)
1	*2462.00	110.0 PK			1.32 H	144	78.70	31.30
2	*2462.00	99.9 AV			1.32 H	144	68.60	31.30
3	2483.50	71.0 PK	74.0	-3.0	1.29 H	135	39.60	31.40
4	2483.50	51.0 AV	54.0	-3.0	1.29 H	135	19.60	31.40
5	4924.00	46.5 PK	74.0	-27.5	1.29 H	360	9.10	37.40
6	4924.00	33.5 AV	54.0	-20.5	1.29 H	360	-3.90	37.40
ANTENNA POLARITY & TEST DISTANCE: VERTICAL AT 3 M								
NO.	FREQ. (MHz)	EMISSION LEVEL (dBuV/m)	LIMIT (dBuV/m)	MARGIN (dB)	ANTENNA HEIGHT (m)	TABLE ANGLE (Degree)	RAW VALUE (dBuV)	CORRECTION FACTOR (dB/m)
1	*2462.00	105.2 PK			1.18 V	52	73.90	31.30
2	*2462.00	94.8 AV			1.18 V	52	63.50	31.30
3	2483.50	67.3 PK	74.0	-6.7	1.18 V	64	35.90	31.40
4	2483.50	48.1 AV	54.0	-5.9	1.18 V	64	16.70	31.40
5	4924.00	45.8 PK	74.0	-28.2	1.06 V	0	8.40	37.40
6	4924.00	33.0 AV	54.0	-21.0	1.06 V	0	-4.40	37.40

- REMARKS:**
1. Emission level (dBuV/m) = Raw Value (dBuV) + Correction Factor (dB/m).
  2. Correction Factor (dB/m) = Antenna Factor (dB/m) + Cable Factor (dB).
  3. The other emission levels were very low against the limit.
  4. Margin value = Emission level – Limit value.
  5. “ \* “: Fundamental frequency.



A D T

802.11n (20MHz)

EUT TEST CONDITION		MEASUREMENT DETAIL	
CHANNEL	Channel 1	FREQUENCY RANGE	1 ~ 25GHz
INPUT POWER	120Vac, 60 Hz	DETECTOR FUNCTION	Peak (PK) Average (AV)
ENVIRONMENTAL CONDITIONS	24deg. C, 64%RH 1021 hPa	TESTED BY	Match Tsui

ANTENNA POLARITY & TEST DISTANCE: HORIZONTAL AT 3 M								
NO.	FREQ. (MHz)	EMISSION LEVEL (dBuV/m)	LIMIT (dBuV/m)	MARGIN (dB)	ANTENNA HEIGHT (m)	TABLE ANGLE (Degree)	RAW VALUE (dBuV)	CORRECTION FACTOR (dB/m)
1	2390.00	70.3 PK	74.0	-3.7	1.35 H	144	39.20	31.10
2	2390.00	51.8 AV	54.0	-2.2	1.35 H	144	20.70	31.10
3	*2412.00	107.4 PK			1.36 H	143	76.20	31.20
4	*2412.00	97.4 AV			1.36 H	143	66.20	31.20
5	4824.00	45.8 PK	74.0	-28.2	1.13 H	213	8.60	37.20
6	4824.00	32.9 AV	54.0	-21.1	1.13 H	213	-4.30	37.20

ANTENNA POLARITY & TEST DISTANCE: VERTICAL AT 3 M								
NO.	FREQ. (MHz)	EMISSION LEVEL (dBuV/m)	LIMIT (dBuV/m)	MARGIN (dB)	ANTENNA HEIGHT (m)	TABLE ANGLE (Degree)	RAW VALUE (dBuV)	CORRECTION FACTOR (dB/m)
1	2390.00	66.6 PK	74.0	-7.4	1.00 V	85	35.50	31.10
2	2390.00	48.1 AV	54.0	-5.9	1.00 V	85	17.00	31.10
3	*2412.00	102.9 PK			1.20 V	100	71.70	31.20
4	*2412.00	92.8 AV			1.20 V	100	61.60	31.20
5	4824.00	45.8 PK	74.0	-28.2	1.04 V	103	8.60	37.20
6	4824.00	32.5 AV	54.0	-21.5	1.04 V	103	-4.70	37.20

- REMARKS:**
1. Emission level (dBuV/m) = Raw Value (dBuV) + Correction Factor (dB/m).
  2. Correction Factor (dB/m) = Antenna Factor (dB/m) + Cable Factor (dB).
  3. The other emission levels were very low against the limit.
  4. Margin value = Emission level – Limit value.
  5. “ \* “: Fundamental frequency.



A D T

EUT TEST CONDITION		MEASUREMENT DETAIL	
CHANNEL	Channel 6	FREQUENCY RANGE	1 ~ 25GHz
INPUT POWER	120Vac, 60 Hz	DETECTOR FUNCTION	Peak (PK) Average (AV)
ENVIRONMENTAL CONDITIONS	24deg. C, 64%RH 1021 hPa	TESTED BY	Match Tsui

ANTENNA POLARITY & TEST DISTANCE: HORIZONTAL AT 3 M								
NO.	FREQ. (MHz)	EMISSION LEVEL (dBuV/m)	LIMIT (dBuV/m)	MARGIN (dB)	ANTENNA HEIGHT (m)	TABLE ANGLE (Degree)	RAW VALUE (dBuV)	CORRECTION FACTOR (dB/m)
1	2390.00	56.2 PK	74.0	-17.8	1.31 H	140	25.10	31.10
2	2390.00	44.2 AV	54.0	-9.8	1.31 H	140	13.10	31.10
3	*2437.00	108.3 PK			1.31 H	140	77.10	31.20
4	*2437.00	98.1 AV			1.31 H	140	66.90	31.20
5	4874.00	45.8 PK	74.0	-28.2	1.23 H	333	8.50	37.30
6	4874.00	33.0 AV	54.0	-21.0	1.23 H	333	-4.30	37.30
ANTENNA POLARITY & TEST DISTANCE: VERTICAL AT 3 M								
NO.	FREQ. (MHz)	EMISSION LEVEL (dBuV/m)	LIMIT (dBuV/m)	MARGIN (dB)	ANTENNA HEIGHT (m)	TABLE ANGLE (Degree)	RAW VALUE (dBuV)	CORRECTION FACTOR (dB/m)
1	2390.00	56.1 PK	74.0	-17.9	1.19 V	98	25.00	31.10
2	2390.00	44.0 AV	54.0	-10.0	1.19 V	98	12.90	31.10
3	*2437.00	103.4 PK			1.19 V	98	72.20	31.20
4	*2437.00	93.0 AV			1.19 V	98	61.80	31.20
5	4874.00	45.6 PK	74.0	-28.4	1.11 V	360	8.30	37.30
6	4874.00	32.7 AV	54.0	-21.3	1.11 V	360	-4.60	37.30

- REMARKS:**
1. Emission level (dBuV/m) = Raw Value (dBuV) + Correction Factor (dB/m).
  2. Correction Factor (dB/m) = Antenna Factor (dB/m) + Cable Factor (dB).
  3. The other emission levels were very low against the limit.
  4. Margin value = Emission level – Limit value.
  5. “ \* “: Fundamental frequency.



A D T

EUT TEST CONDITION		MEASUREMENT DETAIL	
CHANNEL	Channel 11	FREQUENCY RANGE	1 ~ 25GHz
INPUT POWER	120Vac, 60 Hz	DETECTOR FUNCTION	Peak (PK) Average (AV)
ENVIRONMENTAL CONDITIONS	24deg. C, 64%RH 1021 hPa	TESTED BY	Match Tsui

ANTENNA POLARITY & TEST DISTANCE: HORIZONTAL AT 3 M								
NO.	FREQ. (MHz)	EMISSION LEVEL (dBuV/m)	LIMIT (dBuV/m)	MARGIN (dB)	ANTENNA HEIGHT (m)	TABLE ANGLE (Degree)	RAW VALUE (dBuV)	CORRECTION FACTOR (dB/m)
1	*2462.00	108.5 PK			1.32 H	145	77.20	31.30
2	*2462.00	98.6 AV			1.32 H	145	67.30	31.30
3	2483.50	68.9 PK	74.0	-5.1	1.27 H	137	37.50	31.40
4	2483.50	51.7 AV	54.0	-2.3	1.27 H	137	20.30	31.40
5	4924.00	45.9 PK	74.0	-28.1	1.27 H	360	8.50	37.40
6	4924.00	33.2 AV	54.0	-20.8	1.27 H	360	-4.20	37.40
ANTENNA POLARITY & TEST DISTANCE: VERTICAL AT 3 M								
NO.	FREQ. (MHz)	EMISSION LEVEL (dBuV/m)	LIMIT (dBuV/m)	MARGIN (dB)	ANTENNA HEIGHT (m)	TABLE ANGLE (Degree)	RAW VALUE (dBuV)	CORRECTION FACTOR (dB/m)
1	*2462.00	103.6 PK			1.17 V	69	72.30	31.30
2	*2462.00	93.1 AV			1.17 V	69	61.80	31.30
3	2483.50	67.2 PK	74.0	-6.8	1.16 V	65	35.80	31.40
4	2483.50	49.0 AV	54.0	-5.0	1.16 V	65	17.60	31.40
5	4924.00	45.5 PK	74.0	-28.5	1.16 V	360	8.10	37.40
6	4924.00	32.9 AV	54.0	-21.1	1.16 V	360	-4.50	37.40

- REMARKS:**
1. Emission level (dBuV/m) = Raw Value (dBuV) + Correction Factor (dB/m).
  2. Correction Factor (dB/m) = Antenna Factor (dB/m) + Cable Factor (dB).
  3. The other emission levels were very low against the limit.
  4. Margin value = Emission level – Limit value.
  5. “ \* “: Fundamental frequency.



A D T

**BELOW 1GHz WORST-CASE DATA : 802.11g**

EUT TEST CONDITION		MEASUREMENT DETAIL	
CHANNEL	Channel 6	FREQUENCY RANGE	Below 1000MHz
INPUT POWER	120Vac, 60 Hz	DETECTOR FUNCTION	Quasi-Peak
ENVIRONMENTAL CONDITIONS	24deg. C, 64%RH 1019 hPa	TESTED BY	Match Tsui

ANTENNA POLARITY & TEST DISTANCE: HORIZONTAL AT 3 M								
NO.	FREQ. (MHz)	EMISSION LEVEL (dBuV/m)	LIMIT (dBuV/m)	MARGIN (dB)	ANTENNA HEIGHT (m)	TABLE ANGLE (Degree)	RAW VALUE (dBuV)	CORRECTION FACTOR (dB/m)
1	199.05	33.5 QP	43.5	-10.0	1.50 H	259	21.30	12.20
2	234.05	34.1 QP	46.0	-11.9	1.00 H	241	21.00	13.10
3	374.04	35.2 QP	46.0	-10.8	1.00 H	205	17.40	17.80
4	399.31	37.6 QP	46.0	-8.4	2.00 H	322	19.00	18.60
5	558.75	33.3 QP	46.0	-12.7	1.50 H	352	10.50	22.80
6	638.46	33.8 QP	46.0	-12.2	1.25 H	319	9.60	24.20
7	718.18	35.6 QP	46.0	-10.4	1.25 H	13	10.10	25.50
ANTENNA POLARITY & TEST DISTANCE: VERTICAL AT 3 M								
NO.	FREQ. (MHz)	EMISSION LEVEL (dBuV/m)	LIMIT (dBuV/m)	MARGIN (dB)	ANTENNA HEIGHT (m)	TABLE ANGLE (Degree)	RAW VALUE (dBuV)	CORRECTION FACTOR (dB/m)
1	66.84	27.2 QP	40.0	-12.8	1.00 V	235	14.10	13.10
2	374.04	36.7 QP	46.0	-9.3	1.25 V	232	18.90	17.80
3	399.31	38.2 QP	46.0	-7.8	1.25 V	46	19.60	18.60
4	558.75	35.0 QP	46.0	-11.0	1.00 V	274	12.20	22.80
5	718.18	33.3 QP	46.0	-12.7	2.00 V	202	7.80	25.50
6	877.61	33.7 QP	46.0	-12.3	1.00 V	199	5.30	28.40
7	998.00	41.8 QP	54.0	-12.2	1.25 V	1	11.90	29.90

- REMARKS:**
1. Emission level (dBuV/m) = Raw Value (dBuV) + Correction Factor (dB/m).
  2. Correction Factor (dB/m) = Antenna Factor (dB/m) + Cable Factor (dB).
  3. The other emission levels were very low against the limit.
  4. Margin value = Emission level – Limit value.



## 4.2 CONDUCTED EMISSION MEASUREMENT

### 4.2.1 LIMITS OF CONDUCTED EMISSION MEASUREMENT

FREQUENCY OF EMISSION (MHz)	CONDUCTED LIMIT (dBµV)	
	Quasi-peak	Average
0.15 ~ 0.5	66 to 56	56 to 46
0.5 ~ 5	56	46
5 ~ 30	60	50

- NOTE:**
1. The lower limit shall apply at the transition frequencies.
  2. The limit decreases in line with the logarithm of the frequency in the range of 0.15 to 0.50MHz.
  3. All emanations from a class A/B digital device or system, including any network of conductors and apparatus connected thereto, shall not exceed the level of field strengths specified above.

### 4.2.2 TEST INSTRUMENTS

DESCRIPTION & MANUFACTURER	MODEL NO.	SERIAL NO.	DATE OF CALIBRATION	DUE DATE OF CALIBRATION
Test Receiver ROHDE & SCHWARZ	ESCS30	100289	Nov. 23, 2010	Nov. 22, 2011
RF signal cable Woken	5D-FB	Cable-HYCO2-01	Dec. 30, 2010	Dec. 29, 2011
LISN ROHDE & SCHWARZ	ESH2-Z5	100100	Jan. 06, 2011	Jan. 05, 2012
LISN ROHDE & SCHWARZ	ESH3-Z5	100311	Jul. 08, 2010	Jul. 07, 2011
V-LISN SCHWARZBECK	NNBL 8226-2	8226-142	Jul. 12, 2010	Jul. 11, 2011
LISN ROHDE & SCHWARZ	ENV216	100072	Jun. 11, 2010	Jun. 10, 2011
Software ADT	ADT_Cond_ V7.3.7	NA	NA	NA

- NOTE:**
1. The calibration interval of the above test instruments is 12 months and the calibrations are traceable to NML/ROC and NIST/USA.
  2. The test was performed in HwaYa Shielded Room 2.
  3. The VCCI Site Registration No. is C-2047.



A D T

#### 4.2.3 TEST PROCEDURES

- a. The EUT was placed 0.4 meters from the conducting wall of the shielded room with EUT being connected to the power mains through a line impedance stabilization network (LISN). Other support units were connected to the power mains through another LISN. The two LISNs provide 50 ohm/ 50uH of coupling impedance for the measuring instrument.
- b. Both lines of the power mains connected to the EUT were checked for maximum conducted interference.
- c. The frequency range from 150kHz to 30MHz was searched. Emission levels under (Limit - 20dB) was not recorded.

**NOTE:** All modes of operation were investigated and the worst-case emissions are reported.

#### 4.2.4 DEVIATION FROM TEST STANDARD

No deviation.

#### 4.2.5 TEST SETUP

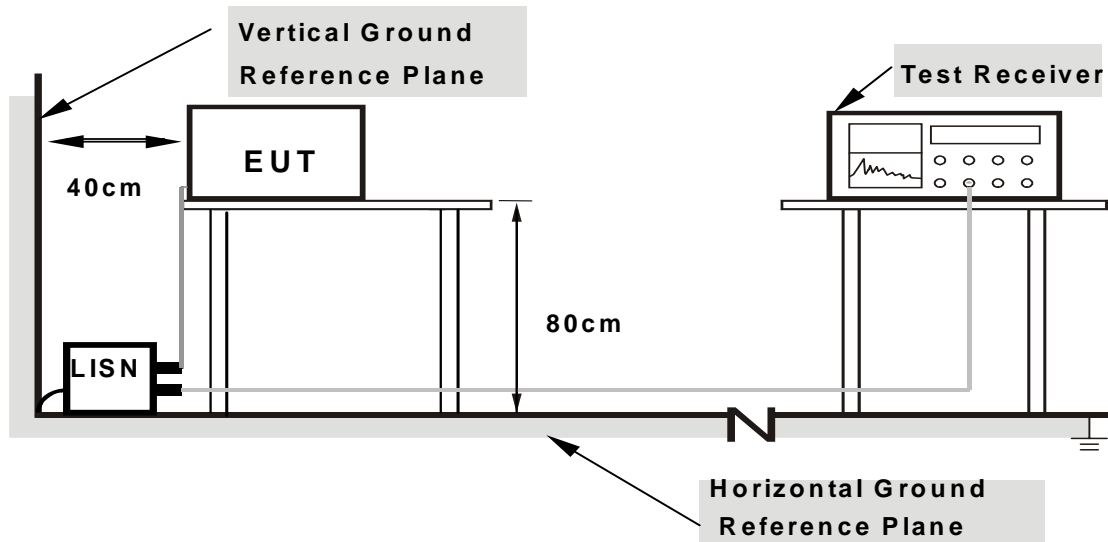

**Note: 1.Support units were connected to second LISN.**

**2.Both of LISNs (AMN) are 80 cm from EUT and at least 80 from other units and other metal planes**

For the actual test configuration, please refer to the attached file (Test Setup Photo).

#### 4.2.6 EUT OPERATING CONDITIONS

Same as 4.1.6.



### 4.2.7 TEST RESULTS

**CONDUCTED WORST-CASE DATA : 802.11g**

<b>PHASE</b>	Line 1	<b>6dB BANDWIDTH</b>	9kHz
--------------	--------	----------------------	------

No	Freq. [MHz]	Corr. Factor (dB)	Reading Value		Emission Level		Limit		Margin	
			[dB (uV)]		[dB (uV)]		[dB (uV)]		(dB)	
			Q.P.	AV.	Q.P.	AV.	Q.P.	AV.	Q.P.	AV.
1	0.162	0.15	40.68	-	40.83	-	65.38	55.38	-24.55	-
2	0.185	0.15	41.28	-	41.43	-	64.25	54.25	-22.82	-
3	0.466	0.17	41.27	-	41.44	-	56.58	46.58	-15.14	-
4	0.849	0.18	38.95	-	39.13	-	56.00	46.00	-16.87	-
5	6.375	0.41	27.35	-	27.76	-	60.00	50.00	-32.24	-
6	23.109	1.20	28.57	-	29.77	-	60.00	50.00	-30.23	-

- REMARKS:**
1. Q.P. and AV. are abbreviations of quasi-peak and average individually.
  2. "-": The Quasi-peak reading value also meets average limit and measurement with the average detector is unnecessary.
  3. The emission levels of other frequencies were very low against the limit.
  4. Margin value = Emission level - Limit value
  5. Correction factor = Insertion loss + Cable loss
  6. Emission Level = Correction Factor + Reading Value.

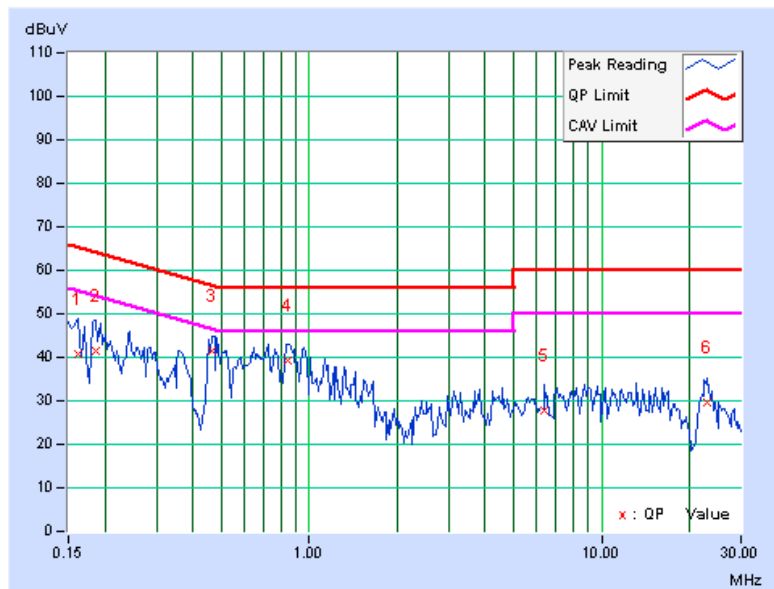

PHASE	Line 2	6dB BANDWIDTH	9kHz
-------	--------	---------------	------

No	Freq. [MHz]	Corr. Factor (dB)	Reading Value		Emission Level		Limit		Margin	
			[dB (uV)]		[dB (uV)]		[dB (uV)]		(dB)	
			Q.P.	AV.	Q.P.	AV.	Q.P.	AV.	Q.P.	AV.
1	0.185	0.17	40.96	-	41.13	-	64.25	54.25	-23.13	-
2	0.248	0.17	40.00	-	40.17	-	61.84	51.84	-21.66	-
3	0.482	0.19	41.57	-	41.76	-	56.30	46.30	-14.54	-
4	0.834	0.20	38.35	-	38.55	-	56.00	46.00	-17.45	-
5	6.871	0.41	27.05	-	27.46	-	60.00	50.00	-32.54	-
6	22.141	0.97	27.01	-	27.98	-	60.00	50.00	-32.02	-

- REMARKS:**
1. Q.P. and AV. are abbreviations of quasi-peak and average individually.
  2. "-": The Quasi-peak reading value also meets average limit and measurement with the average detector is unnecessary.
  3. The emission levels of other frequencies were very low against the limit.
  4. Margin value = Emission level - Limit value
  5. Correction factor = Insertion loss + Cable loss
  6. Emission Level = Correction Factor + Reading Value.

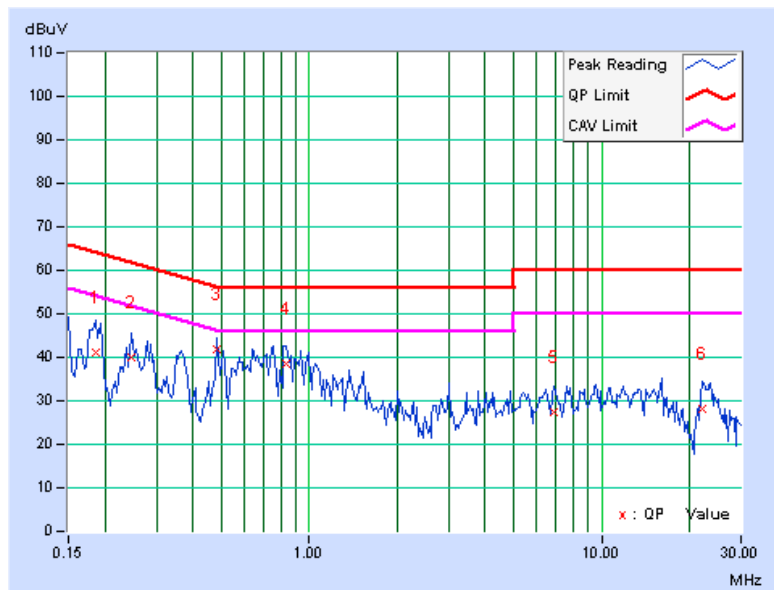

### 4.3 6dB BANDWIDTH MEASUREMENT

#### 4.3.1 LIMITS OF 6dB BANDWIDTH MEASUREMENT

The minimum of 6dB Bandwidth Measurement is 0.5 MHz.

#### 4.3.2 TEST INSTRUMENTS

DESCRIPTION & MANUFACTURER	MODEL NO.	SERIAL NO.	DATE OF CALIBRATION	DUE DATE OF CALIBRATION
SPECTRUM ANALYZER R&S	FSP40	100039	Jan. 11, 2011	Jan. 10, 2012

**NOTE:** The calibration interval of the above test instruments is 12 months and the calibrations are traceable to NML/ROC and NIST/USA.

#### 4.3.3 TEST PROCEDURE

The transmitter output was connected to the spectrum analyzer through an attenuator. The bandwidth of the fundamental frequency was measured by spectrum analyzer with 100kHz RBW and 300kHz VBW. The 6dB bandwidth is defined as the total spectrum the power of which is higher than peak power minus 6dB.

#### 4.3.4 DEVIATION FROM TEST STANDARD

No deviation.

#### 4.3.5 TEST SETUP

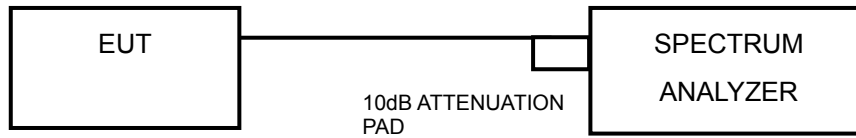

#### 4.3.6 EUT OPERATING CONDITIONS

The software provided by client to enable the EUT under transmission condition continuously at lowest, middle and highest channel frequencies individually.



A D T

### 4.3.7 TEST RESULTS

#### 802.11b

CHANNEL	CHANNEL FREQUENCY (MHz)	6dB BANDWIDTH (MHz)	MINIMUM LIMIT (MHz)	PASS / FAIL
1	2412	9.14	0.5	PASS
6	2437	8.61	0.5	PASS
11	2462	9.50	0.5	PASS

#### CH 11

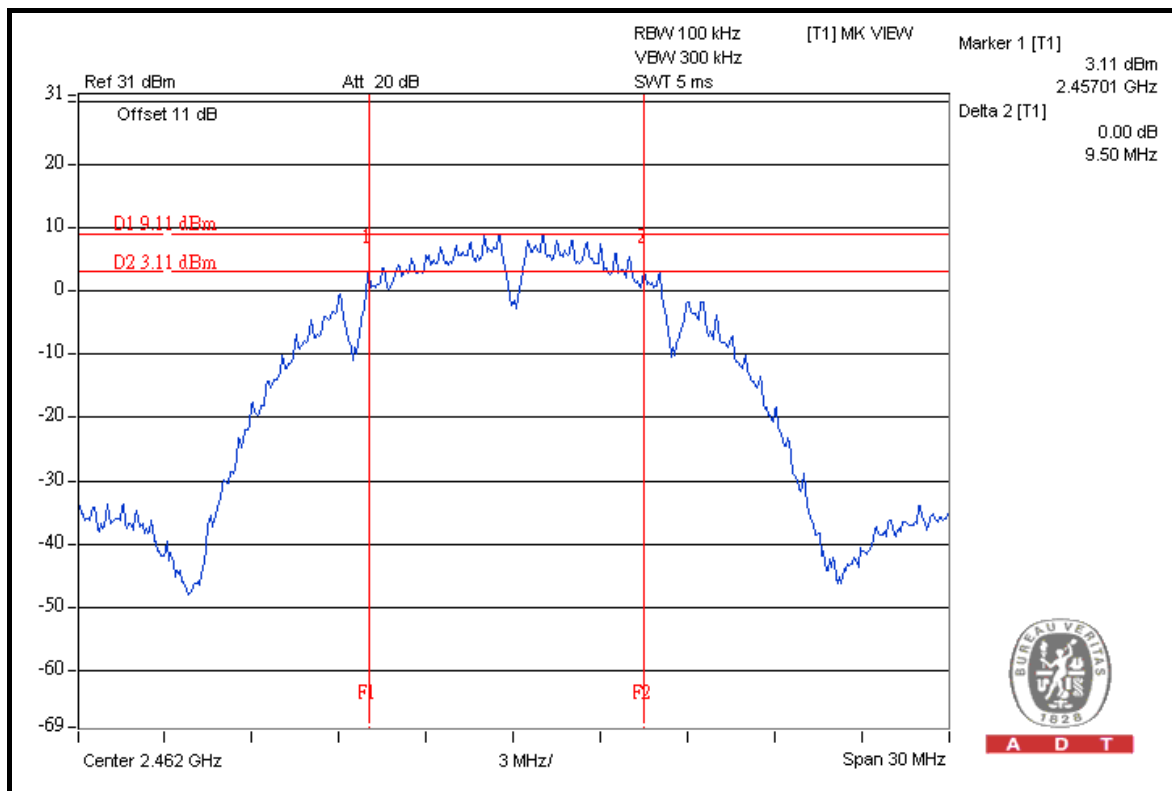





A D T

### 802.11n (20MHz)

CHANNEL	CHANNEL FREQUENCY (MHz)	6dB BANDWIDTH (MHz)	MINIMUM LIMIT (MHz)	PASS / FAIL
1	2412	15.13	0.5	PASS
6	2437	15.17	0.5	PASS
11	2462	15.18	0.5	PASS

### CH 11

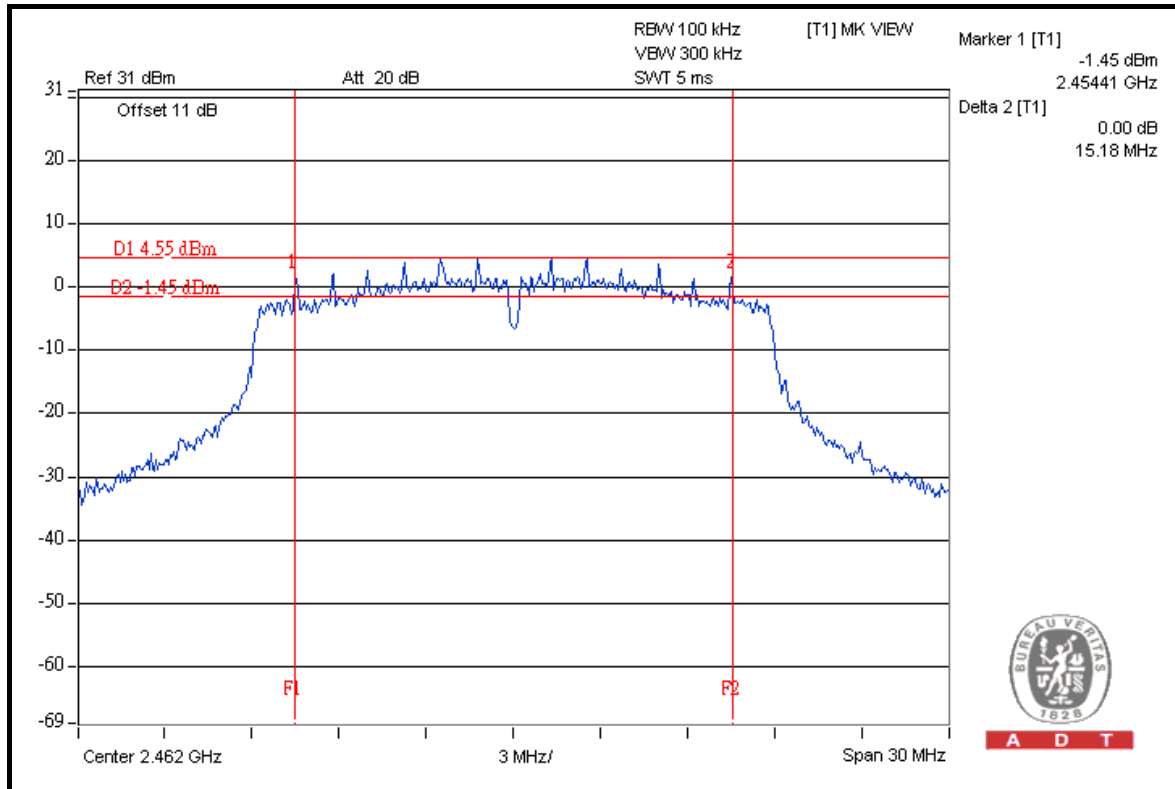



A D T

## 4.4 MAXIMUM OUTPUT POWER

### 4.4.1 LIMITS OF MAXIMUM OUTPUT POWER MEASUREMENT

The Maximum Output Power Measurement is 30dBm.

### 4.4.2 INSTRUMENTS

DESCRIPTION & MANUFACTURER	MODEL NO.	SERIAL NO.	DATE OF CALIBRATION	DUE DATE OF CALIBRATION
High Speed Peak Power Meter	ML2495A	0842014	Apr. 21, 2010	Apr. 20, 2011
Power Sensor	MA2411B	0738404	Apr. 21, 2010	Apr. 20, 2011

**NOTE:**

1. The calibration interval of the above test instruments is 12 months and the calibrations are traceable to NML/ROC and NIST/USA.
2. Measurement Bandwidth of ML2495A is 65MHz greater than 6dB bandwidth of emission.

### 4.4.3 TEST PROCEDURE

A power sensor was used on the output port of the EUT. A power meter was used to read the response of the power sensor. Record the power level.



#### 4.4.4 DEVIATION FROM TEST STANDARD

No deviation.

#### 4.4.5 TEST SETUP

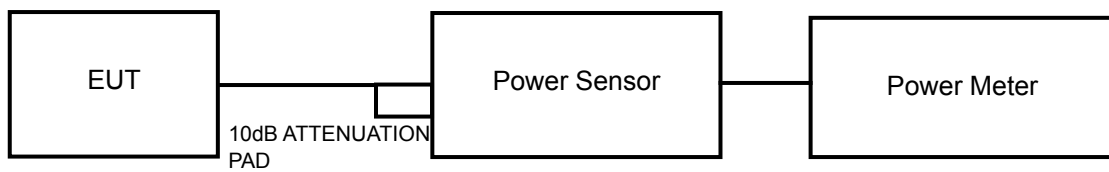

#### 4.4.6 EUT OPERATING CONDITIONS

Same as Item 4.3.6.



#### 4.4.7 TEST RESULTS

##### 802.11b

CHANNEL	CHANNEL FREQUENCY (MHz)	POWER OUTPUT (mW)	POWER OUTPUT (dBm)	POWER LIMIT (dBm)	PASS/FAIL
1	2412	109.6	20.4	30	PASS
6	2437	120.2	20.8	30	PASS
11	2462	117.5	20.7	30	PASS

##### 802.11g

CHANNEL	CHANNEL FREQUENCY (MHz)	POWER OUTPUT (mW)	POWER OUTPUT (dBm)	POWER LIMIT (dBm)	PASS/FAIL
1	2412	269.2	24.3	30	PASS
6	2437	309.0	24.9	30	PASS
11	2462	302.0	24.8	30	PASS

##### 802.11n (20MHz)

CHANNEL	CHANNEL FREQUENCY (MHz)	POWER OUTPUT (mW)	POWER OUTPUT (dBm)	POWER LIMIT (dBm)	PASS/FAIL
1	2412	251.2	24.0	30	PASS
6	2437	269.2	24.3	30	PASS
11	2462	275.4	24.4	30	PASS



A D T

## 4.5 POWER SPECTRAL DENSITY MEASUREMENT

### 4.5.1 LIMITS OF POWER SPECTRAL DENSITY MEASUREMENT

The Maximum of Power Spectral Density Measurement is 8dBm.

### 4.5.2 TEST INSTRUMENTS

DESCRIPTION & MANUFACTURER	MODEL NO.	SERIAL NO.	DATE OF CALIBRATION	DUE DATE OF CALIBRATION
SPECTRUM ANALYZER R&S	FSP40	100039	Jan. 11, 2011	Jan. 10, 2012

**NOTE:** The calibration interval of the above test instruments is 12 months and the calibrations are traceable to NML/ROC and NIST/USA.

### 4.5.3 TEST PROCEDURE

1. Follow DTS measurement (PSD Option 2), the transmitter output was connected to the spectrum analyzer through an attenuator, the bandwidth of the fundamental frequency was measured with the spectrum analyzer. Locate and zoom in on emission peak(s) within the pass band.
2. Set RBW = 3 kHz /VBW > 9 kHz and sweep time to Automatic.
3. Detector use peak mode and a video trigger with the trigger level set to enable triggering only on full power pulses.
4. Trace average 100 traces in power averaging mode. The power spectral density was measured and recorded.

#### 4.5.4 DEVIATION FROM TEST STANDARD

No deviation.

#### 4.5.5 TEST SETUP

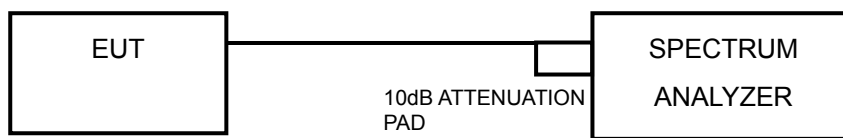

#### 4.5.6 EUT OPERATING CONDITION

Same as Item 4.3.6.



A D T

### 4.5.7 TEST RESULTS

#### 802.11b

CHANNEL	CHANNEL FREQUENCY (MHz)	RF POWER LEVEL IN 3 kHz BW (dBm)	MAXIMUM LIMIT (dBm)	PASS/FAIL
1	2412	-5.3	8	PASS
6	2437	-4.8	8	PASS
11	2462	-5.0	8	PASS

#### CH 6

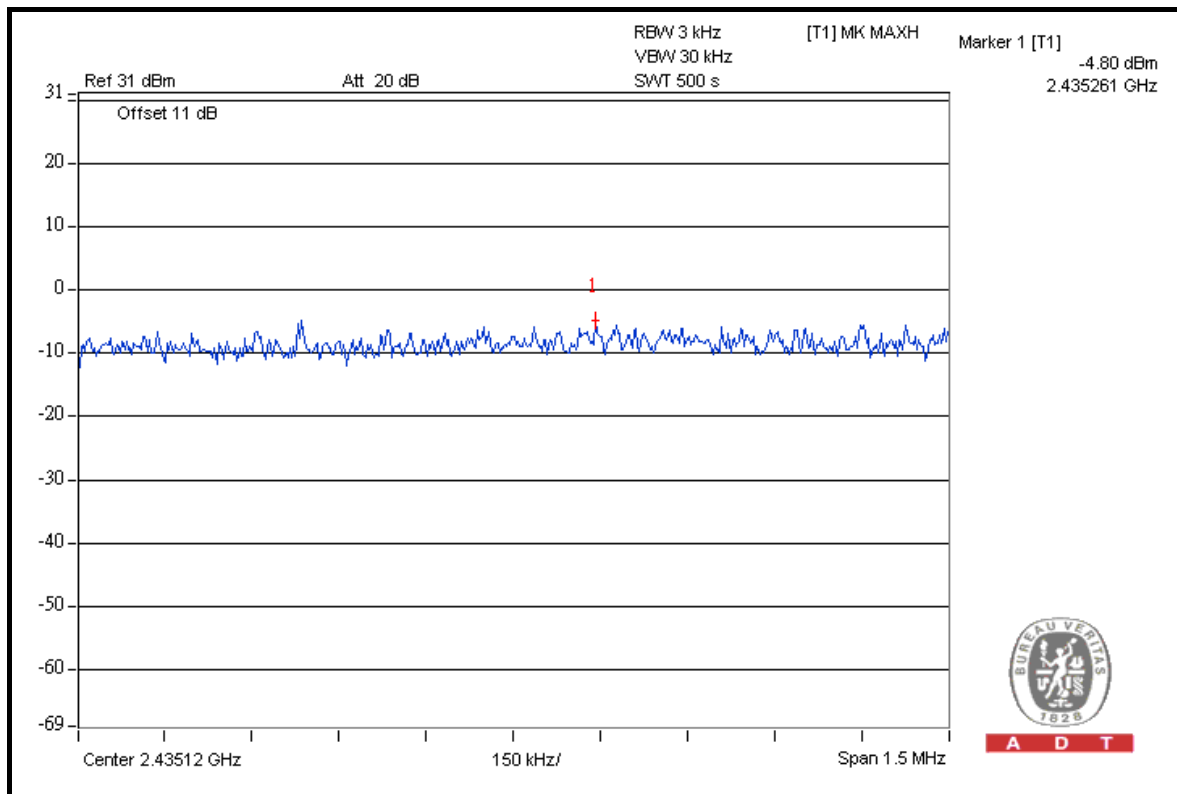

A D T



A D T

### 802.11g

CHANNEL	CHANNEL FREQUENCY (MHz)	RF POWER LEVEL IN 3 kHz BW (dBm)	MAXIMUM LIMIT (dBm)	PASS/FAIL
1	2412	-5.8	8	PASS
6	2437	-5.1	8	PASS
11	2462	-6.2	8	PASS

### CH 6

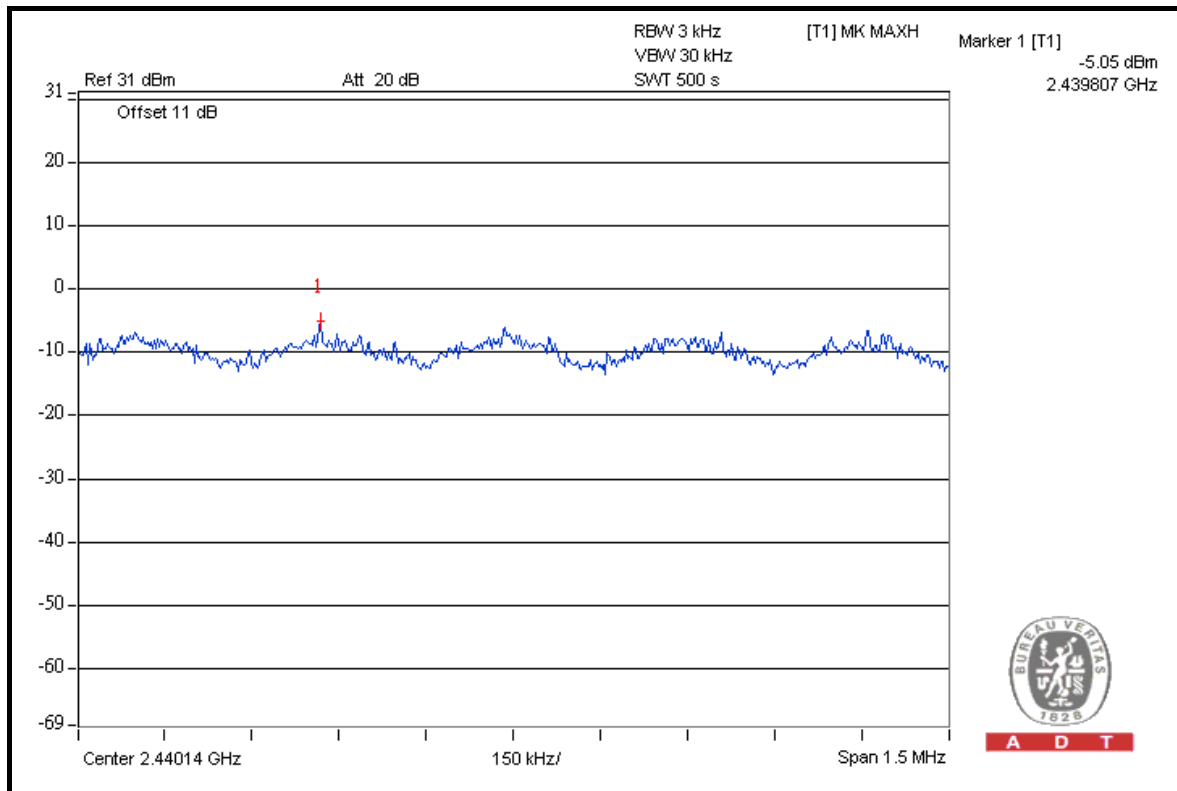



A D T

### 802.11n (20MHz)

CHANNEL	CHANNEL FREQUENCY (MHz)	RF POWER LEVEL IN 3 kHz BW (dBm)	MAXIMUM LIMIT (dBm)	PASS/FAIL
1	2412	-9.1	8	PASS
6	2437	-9.0	8	PASS
11	2462	-8.5	8	PASS

### CH 11

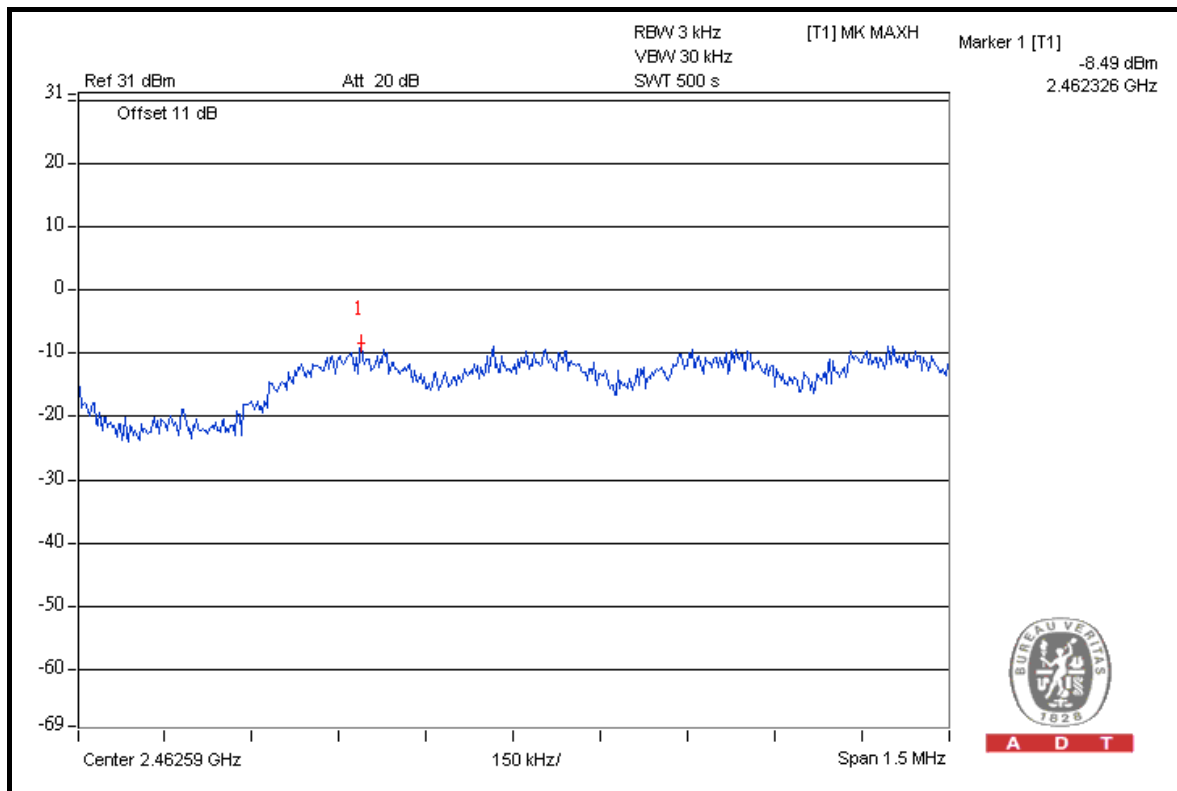

A D T

## 4.6 BAND EDGES MEASUREMENT

### 4.6.1 LIMITS OF BAND EDGES MEASUREMENT

Below  $-20\text{dB}$  of the highest emission level of operating band (in 100kHz Resolution Bandwidth).

**Note:** Follow DTS measurement, If the device complies with the use of power option 2 the attenuation under this paragraph shall be 30 dB instead of 20 dB.

### 4.6.2 TEST INSTRUMENTS

DESCRIPTION & MANUFACTURER	MODEL NO.	SERIAL NO.	DATE OF CALIBRATION	DUE DATE OF CALIBRATION
SPECTRUM ANALYZER R&S	FSP40	100039	Jan. 11, 2011	Jan. 10, 2012

**NOTE:** The calibration interval of the above test instruments is 12 months and the calibrations are traceable to NML/ROC and NIST/USA.

### 4.6.3 TEST PROCEDURE

The transmitter output was connected to the spectrum analyzer via a low lose cable. Set both RBW and VBW of spectrum analyzer to 100kHz and 300kHz with suitable frequency span including 100MHz bandwidth from band edge. The band edges was measured and recorded.

The spectrum plots (Peak RBW = 100kHz, VBW = 300kHz; Average RBW = 1MHz, VBW = 10Hz) are attached on the following pages.

### 4.6.4 DEVIATION FROM TEST STANDARD

No deviation.

### 4.6.5 EUT OPERATING CONDITION

Same as Item 4.3.6.





#### 4.6.6 TEST RESULTS

The spectrum plots are attached on the following pages. D1 line indicates the highest level, and D2 line indicates the 20dB offset below D1. It shows compliance with the requirement in part 15.247(d).

#### 802.11b

##### RESTRICT BAND (2310 ~ 2390 MHz)

FREQUENCY (MHz)	FUNDAMENTAL EMISSION (dBuV/m)	DELTA (dB)	MAXIMUM FIELD STRENGTH IN RESTRICT BAND (dBuV/m)	LIMIT (dBuV/m)
2412.00 (PK)	107.30	55.86	51.44	74.00
2412.00 (AV)	103.90	58.03	45.87	54.00

##### RESTRICT BAND (2483.5 ~ 2500 MHz)

FREQUENCY (MHz)	FUNDAMENTAL EMISSION (dBuV/m)	DELTA (dB)	MAXIMUM FIELD STRENGTH IN RESTRICT BAND (dBuV/m)	LIMIT (dBuV/m)
2462.00 (PK)	108.40	54.61	53.79	74.00
2462.00 (AV)	104.70	59.20	45.50	54.00

**NOTE:**

1. Delta = Amplitude between the peak of the fundamental and the peak of the band edge emission. Please check following 3 pages.
2. Maximum field strength in restrict band = Fundamental emission – Delta.



A D T

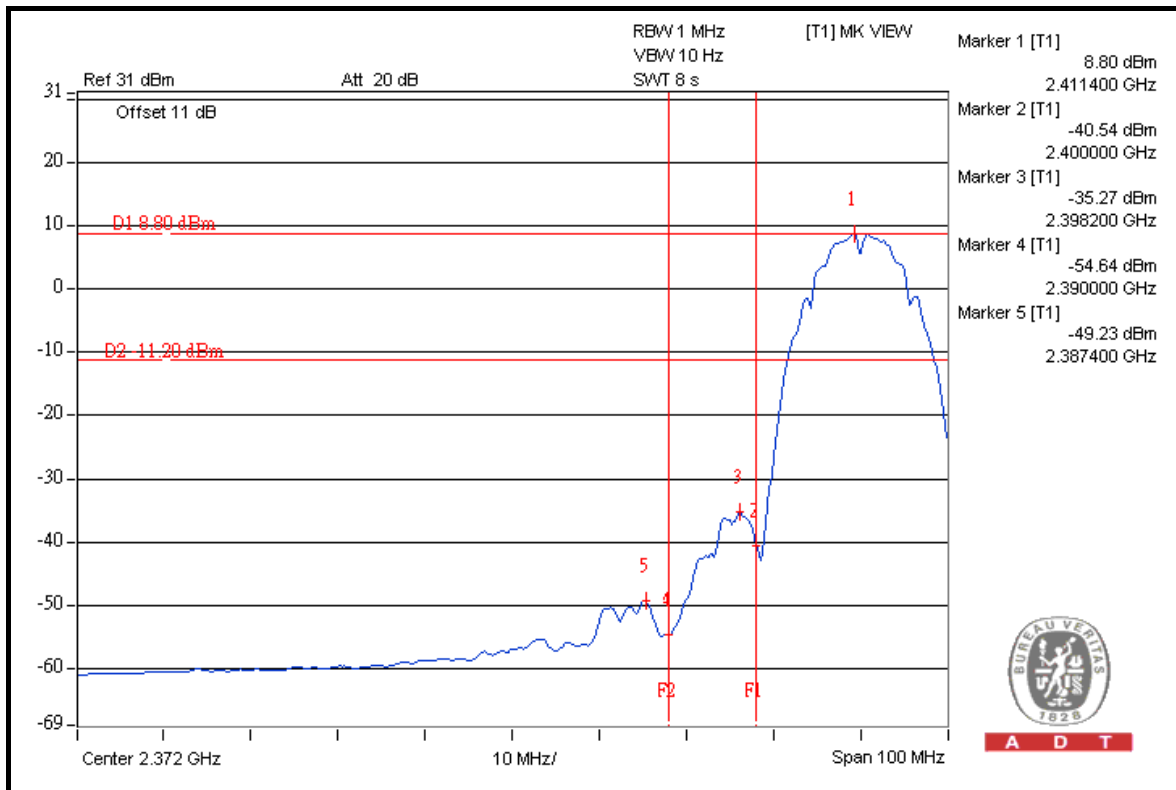
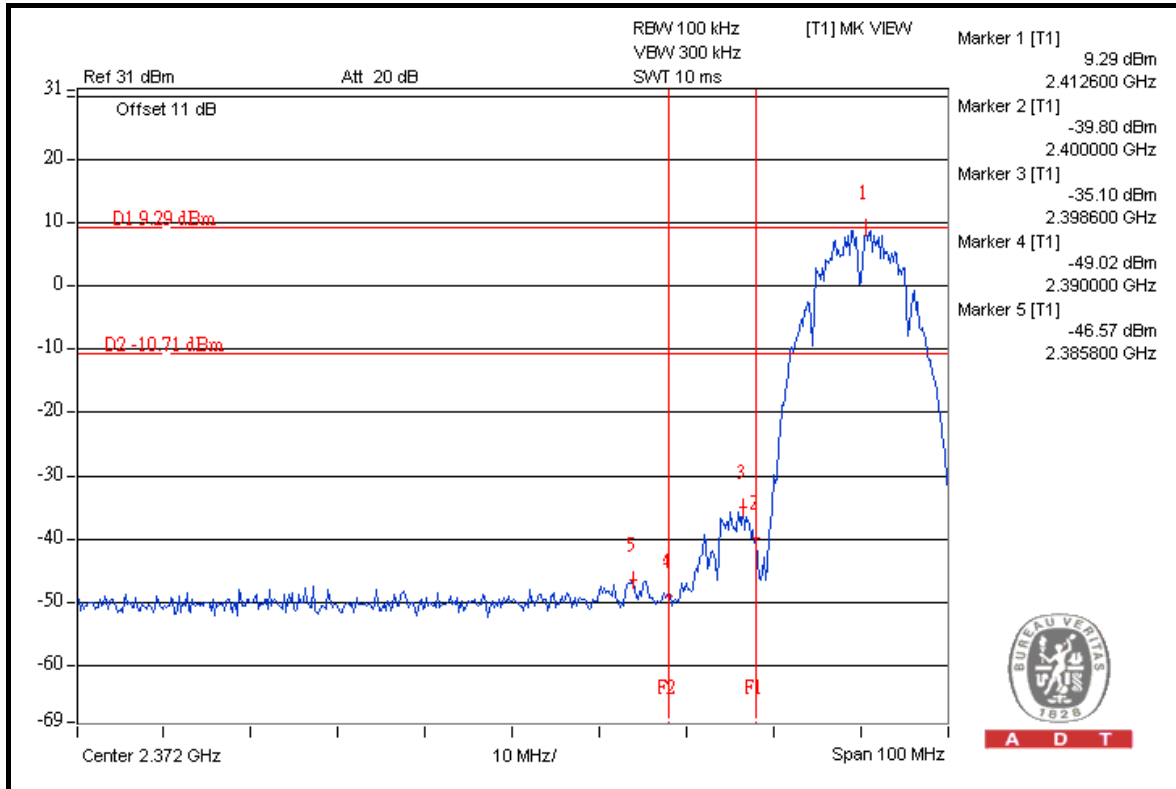



A D T

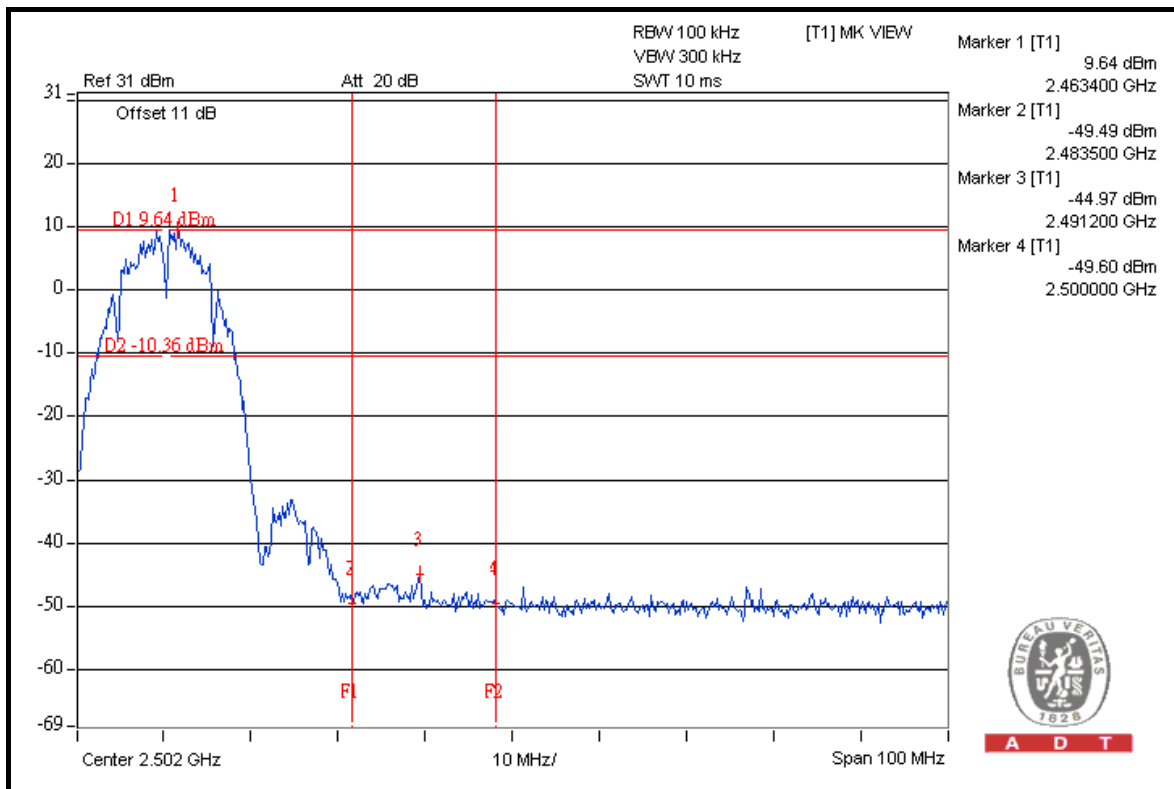
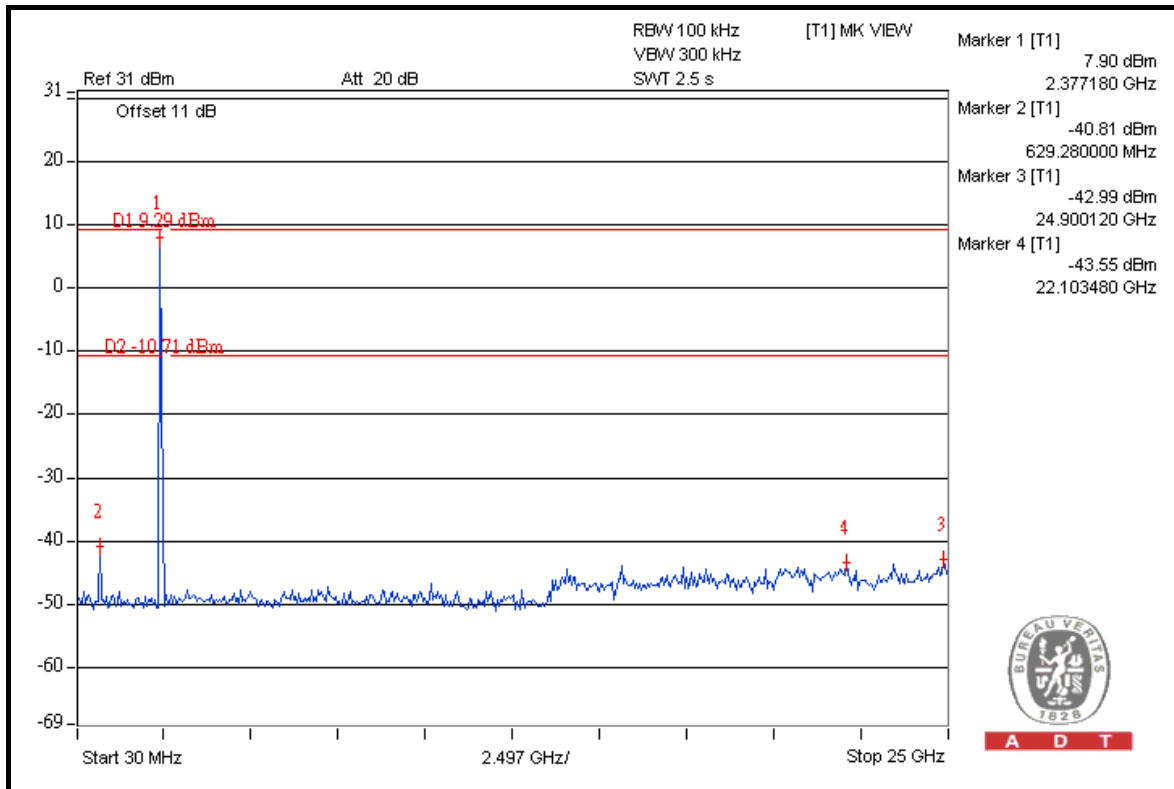



A D T

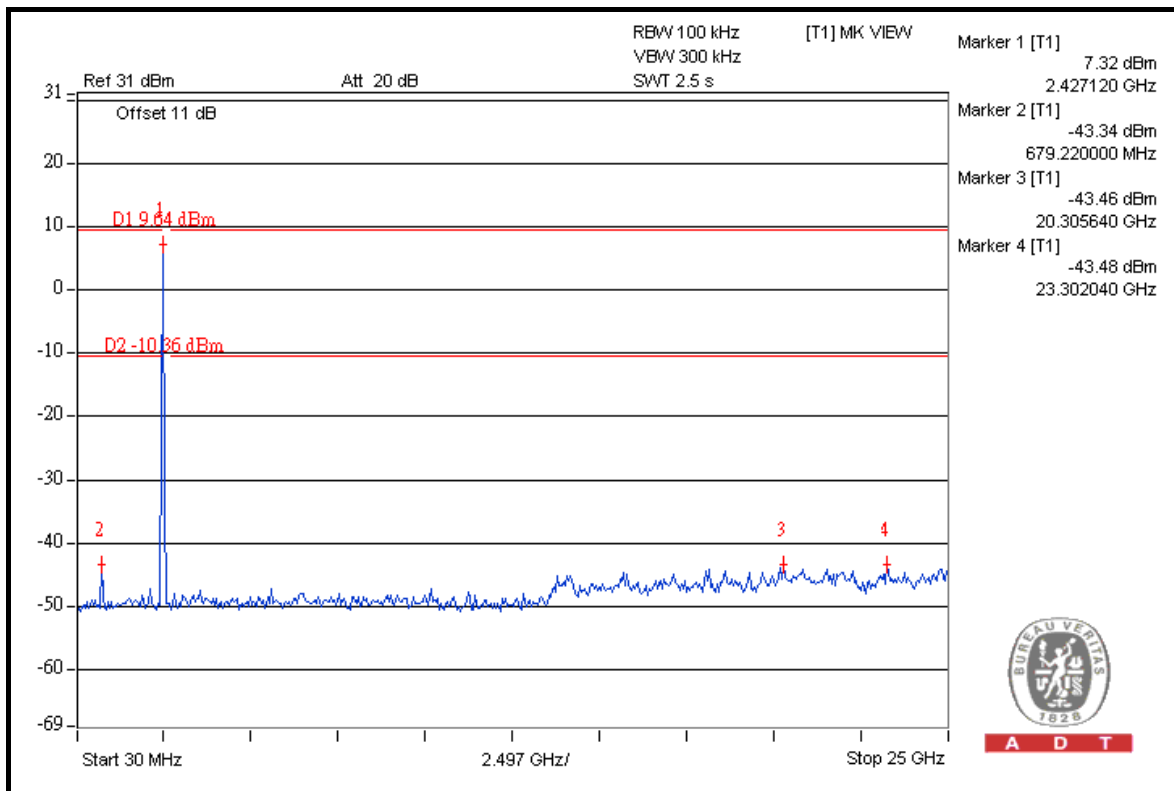
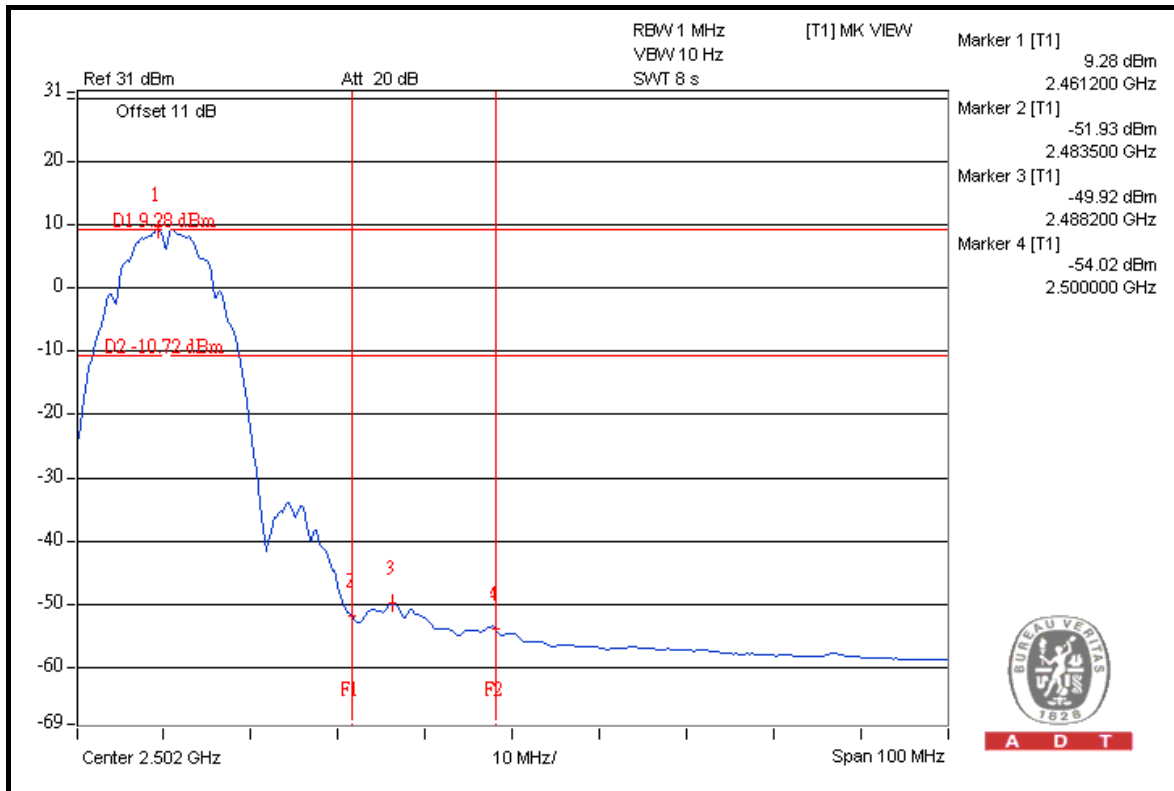



A D T

## 802.11g

### RESTRICT BAND (2310 ~ 2390 MHz)

FREQUENCY (MHz)	FUNDAMENTAL EMISSION (dBuV/m)	DELTA (dB)	MAXIMUM FIELD STRENGTH IN RESTRICT BAND (dBuV/m)	LIMIT (dBuV/m)
2412.00 (PK)	108.80	47.87	60.93	74.00
2412.00 (AV)	98.40	49.69	48.71	54.00

### RESTRICT BAND (2483.5 ~ 2500 MHz)

FREQUENCY (MHz)	FUNDAMENTAL EMISSION (dBuV/m)	DELTA (dB)	MAXIMUM FIELD STRENGTH IN RESTRICT BAND (dBuV/m)	LIMIT (dBuV/m)
2462.00 (PK)	110.00	44.46	65.54	74.00
2462.00 (AV)	99.90	48.05	51.85	54.00

#### NOTE:

1. Delta = Amplitude between the peak of the fundamental and the peak of the band edge emission. Please check following 3 pages.
2. Maximum field strength in restrict band = Fundamental emission – Delta.



A D T

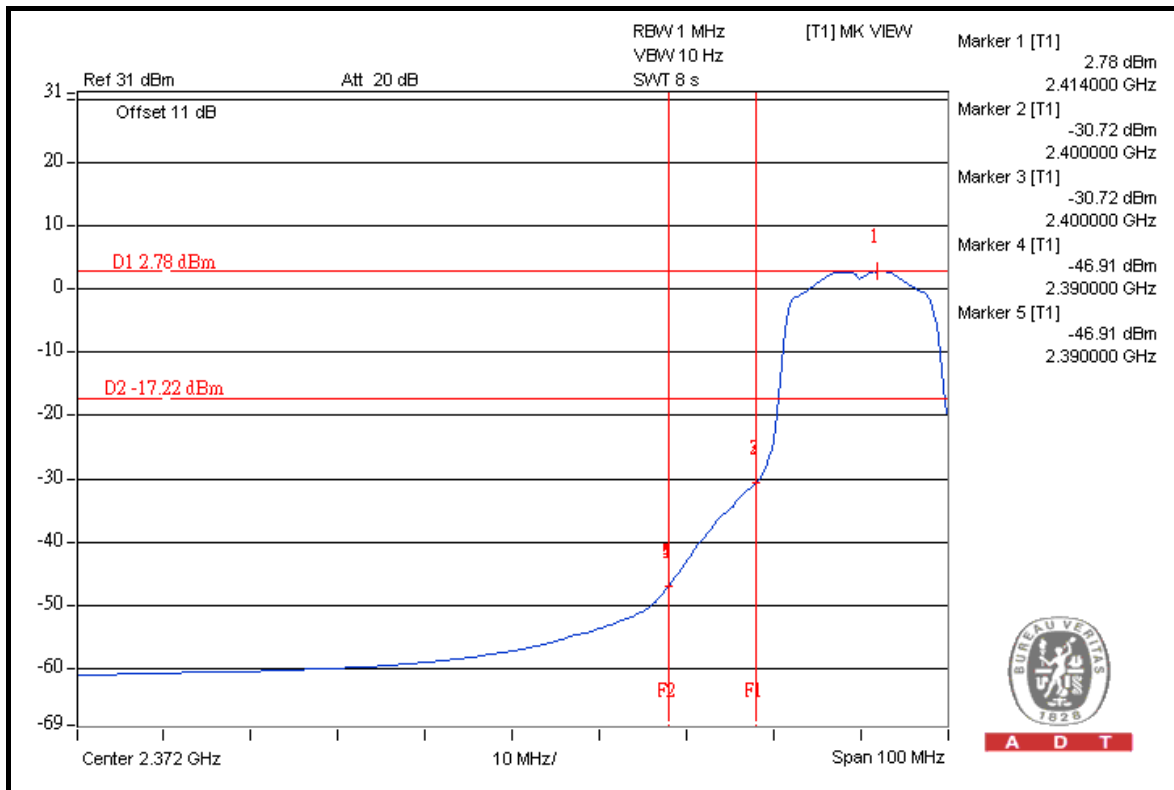
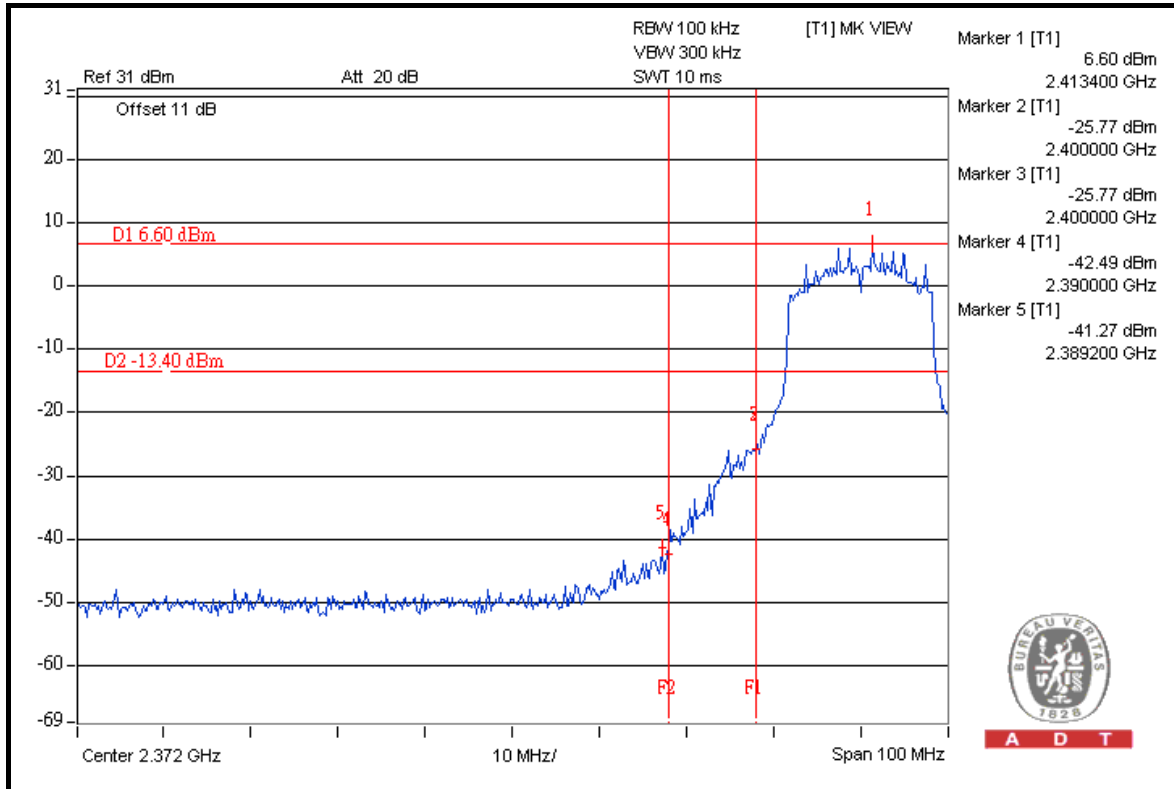



A D T

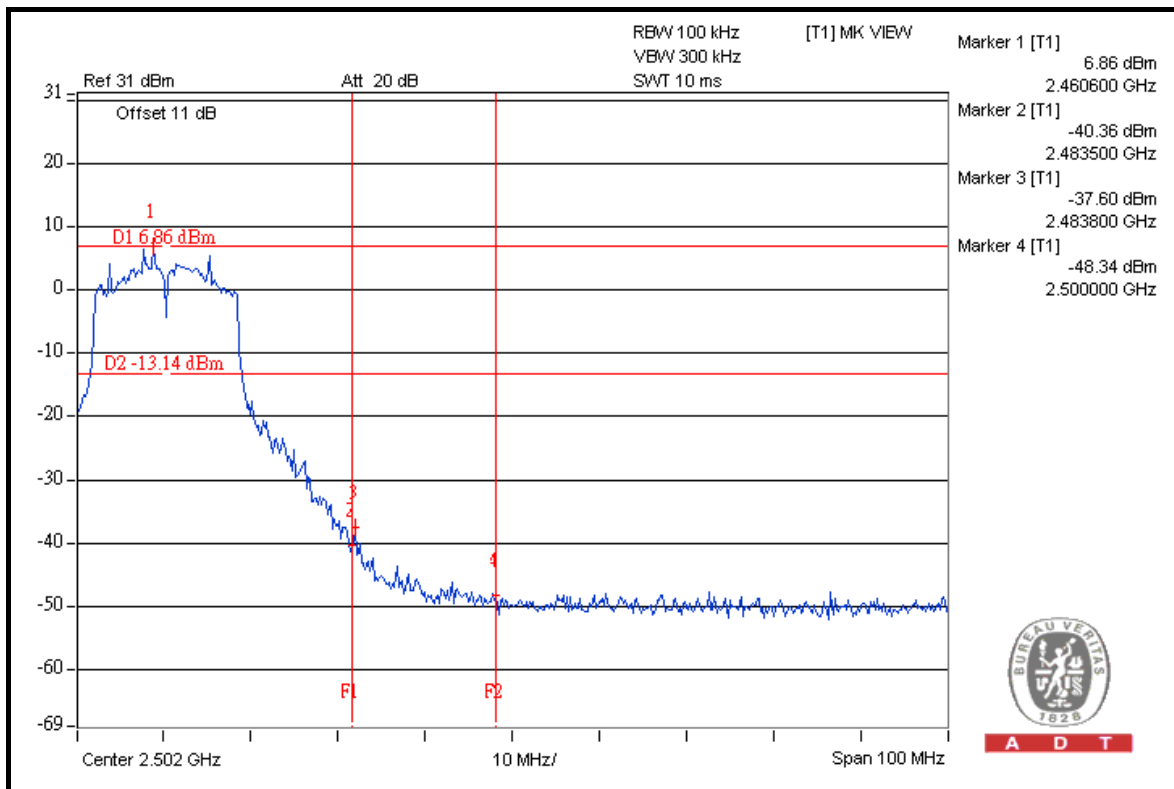
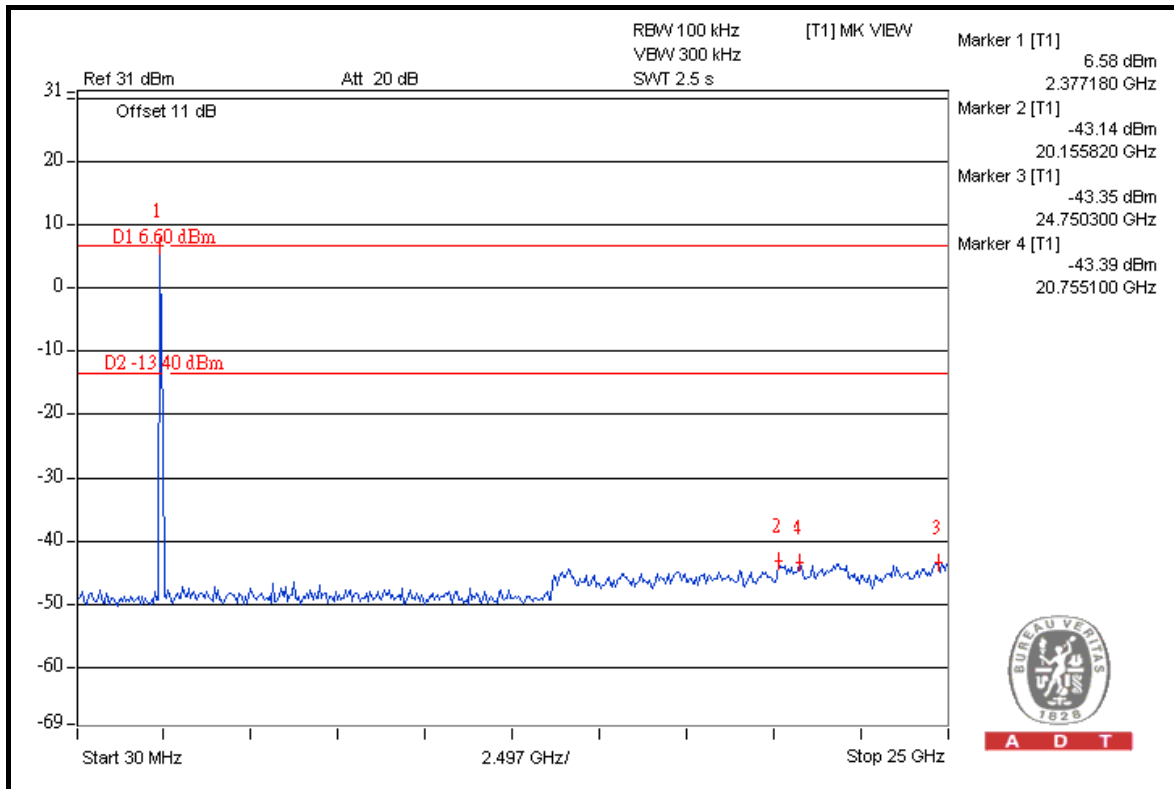



A D T

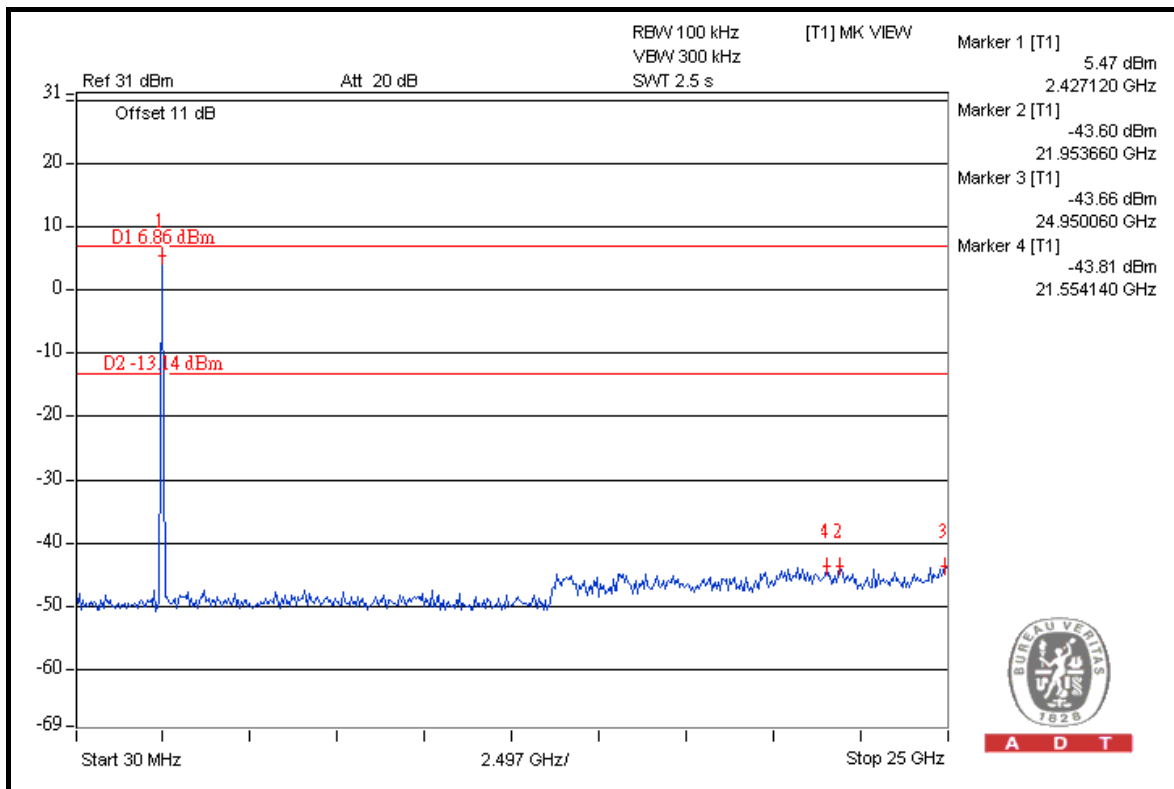
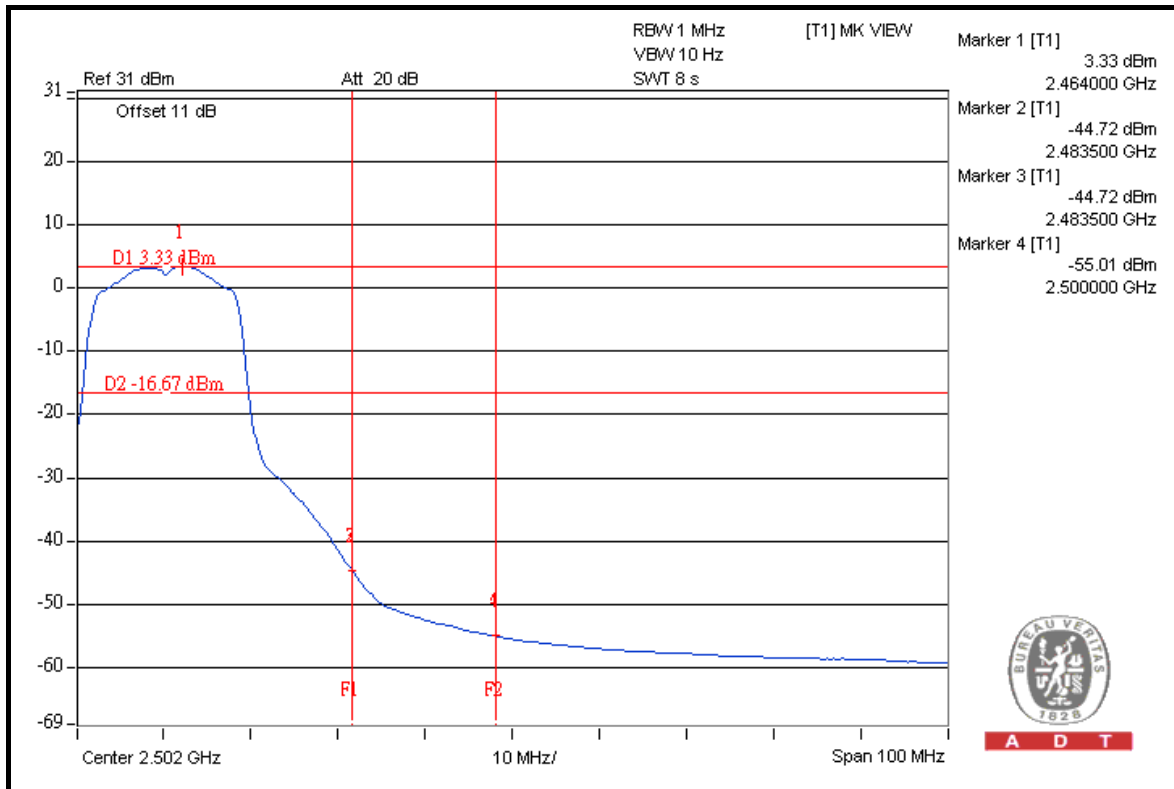





A D T

### 802.11n (20MHz)

#### RESTRICT BAND (2310 ~ 2390 MHz)

FREQUENCY (MHz)	FUNDAMENTAL EMISSION (dBuV/m)	DELTA (dB)	MAXIMUM FIELD STRENGTH IN RESTRICT BAND (dBuV/m)	LIMIT (dBuV/m)
2412.00 (PK)	107.40	46.41	60.99	74.00
2412.00 (AV)	97.40	48.52	48.88	54.00

#### RESTRICT BAND (2483.5 ~ 2500 MHz)

FREQUENCY (MHz)	FUNDAMENTAL EMISSION (dBuV/m)	DELTA (dB)	MAXIMUM FIELD STRENGTH IN RESTRICT BAND (dBuV/m)	LIMIT (dBuV/m)
2462.00 (PK)	108.50	49.41	59.09	74.00
2462.00 (AV)	98.60	47.32	51.28	54.00

**NOTE:**

1. Delta = Amplitude between the peak of the fundamental and the peak of the band edge emission. Please check following 3 pages.
2. Maximum field strength in restrict band = Fundamental emission – Delta.





A D T

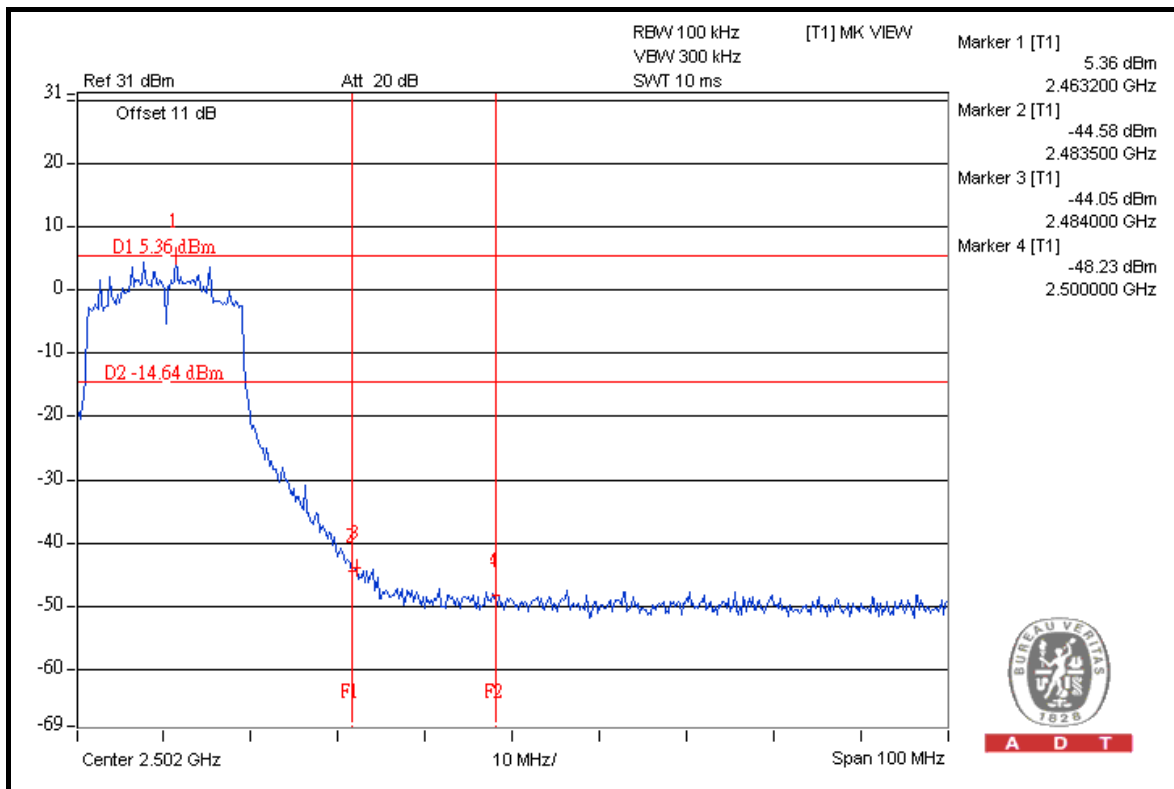
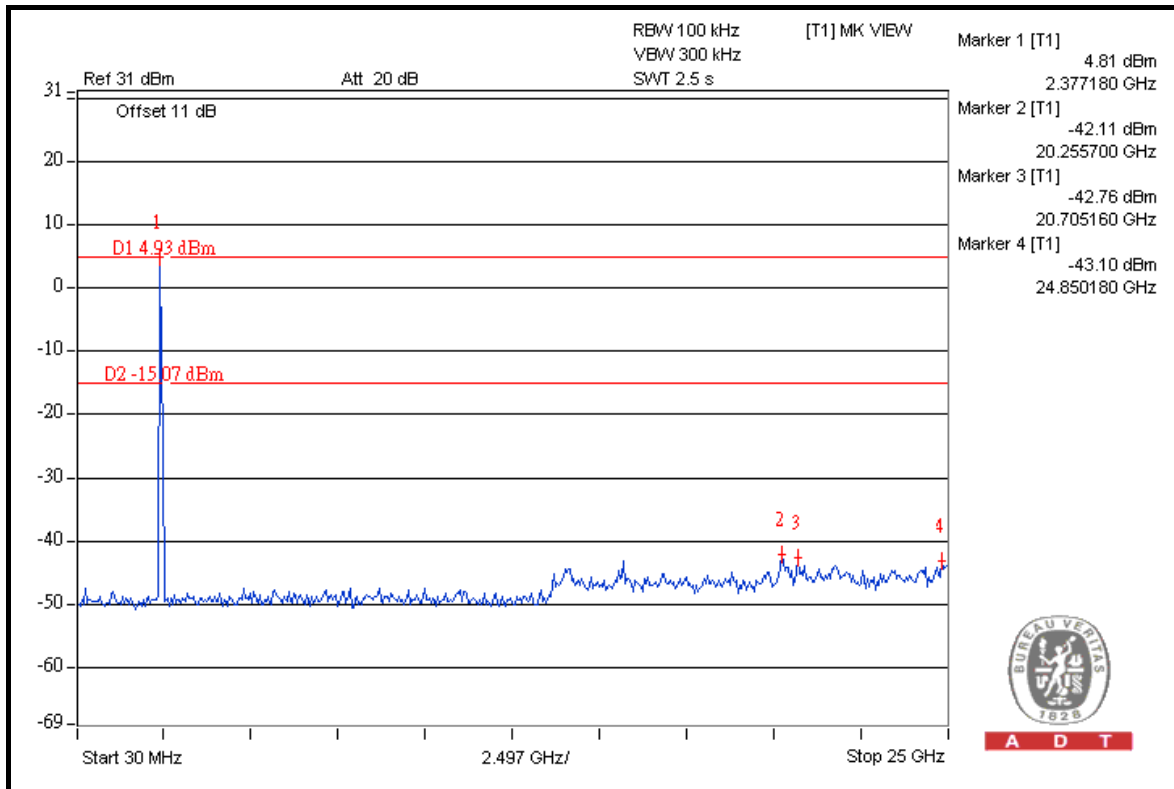



A D T

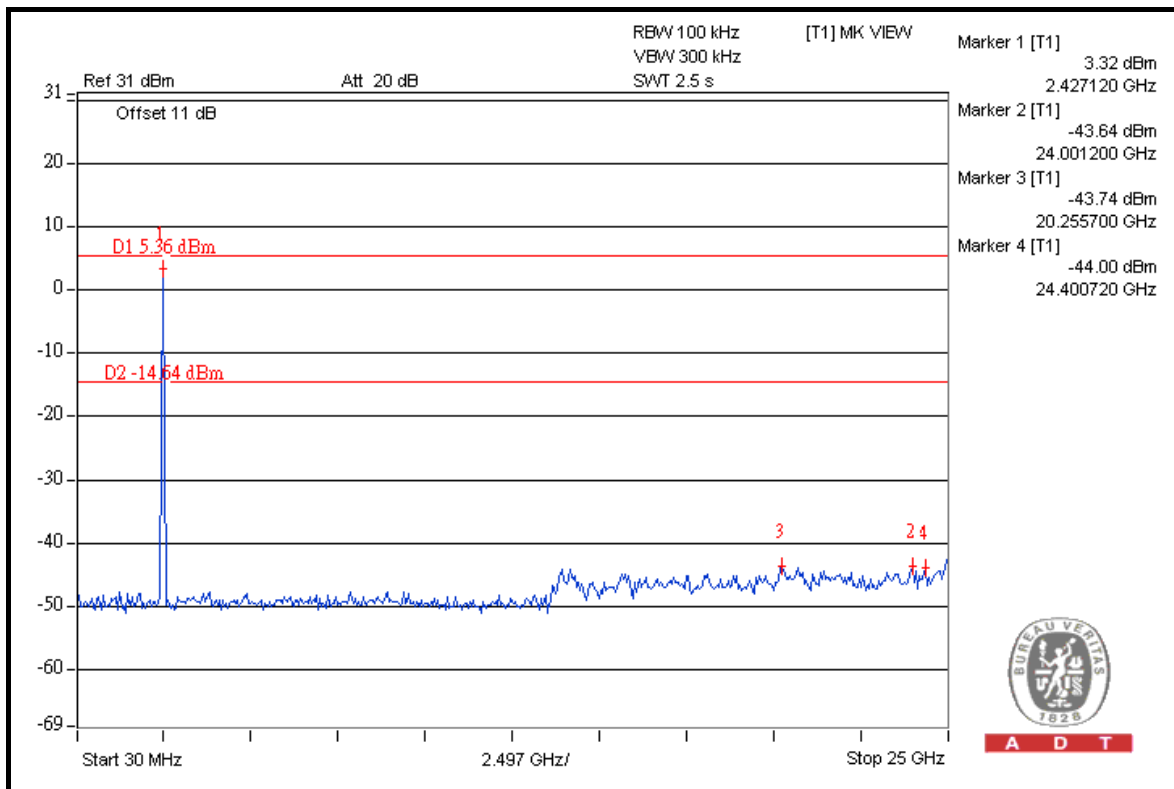
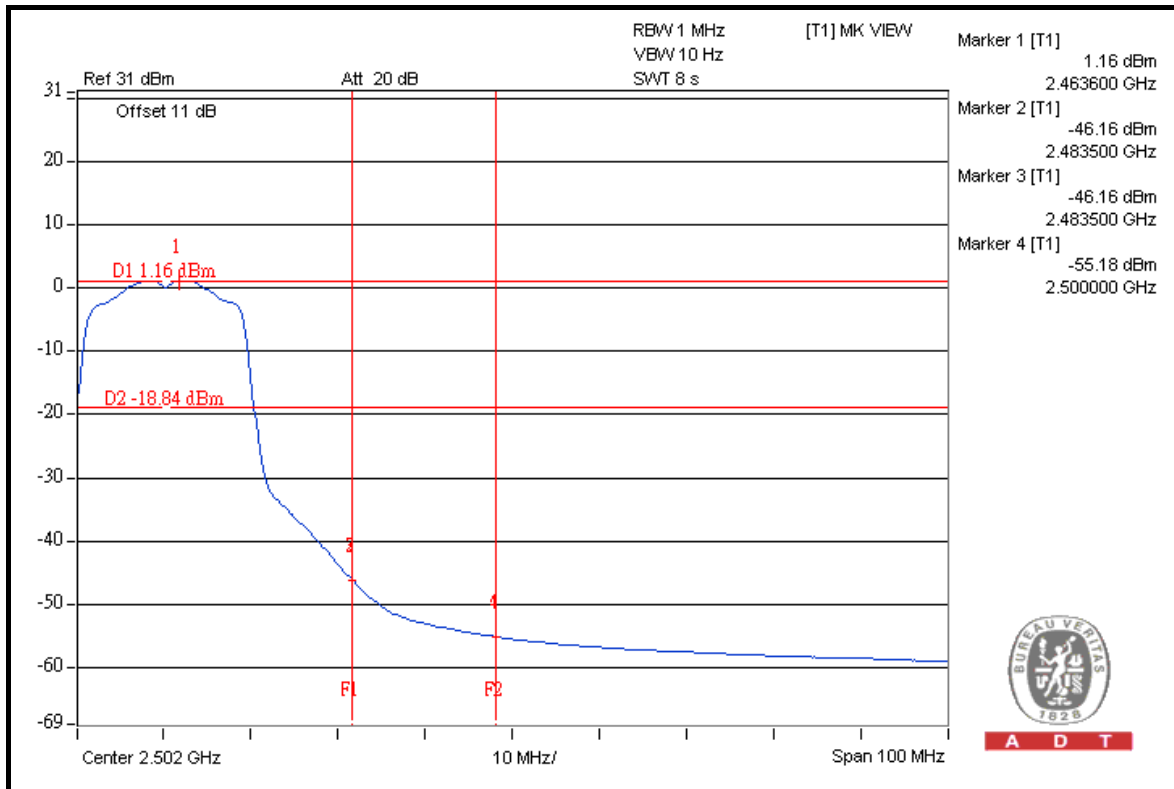



A D T

## 5. TEST TYPES AND RESULTS (FOR 5.0GHz BAND)

### 5.1 RADIATED EMISSION MEASUREMENT

#### 5.1.1 LIMITS OF RADIATED EMISSION MEASUREMENT

Emissions radiated outside of the specified bands, shall be according to the general radiated limits in 15.209 as following:

FREQUENCIES (MHz)	FIELD STRENGTH (microvolts/meter)	MEASUREMENT DISTANCE (meters)
0.009 ~ 0.490	2400/F(kHz)	300
0.490 ~ 1.705	24000/F(kHz)	30
1.705 ~ 30.0	30	30
30 ~ 88	100	3
88 ~ 216	150	3
216 ~ 960	200	3
Above 960	500	3

**NOTE:**

1. The lower limit shall apply at the transition frequencies.
2. Emission level (dBuV/m) = 20 log Emission level (uV/m).
3. As shown in 15.35(b), for frequencies above 1000MHz, the field strength limits are based on average detector, however, the peak field strength of any emission shall not exceed the maximum permitted average limits, specified above by more than 20dB under any condition of modulation.



A D T

### 5.1.2 TEST INSTRUMENTS

DESCRIPTION & MANUFACTURER	MODEL NO.	SERIAL NO.	DATE OF CALIBRATION	DUE DATE OF CALIBRATION
Test Receiver ROHDE & SCHWARZ	ESI7	838496/016	Dec. 27, 2010	Dec. 26, 2011
Spectrum Analyzer ROHDE & SCHWARZ	FSU43	100115	Aug. 02, 2010	Aug. 01, 2011
BILOG Antenna SCHWARZBECK	VULB9168	9168-155	Apr. 28, 2010	Apr. 27, 2011
HORN Antenna SCHWARZBECK	BBHA 9120D	9120D-408	Jan. 06, 2011	Jan. 05, 2012
HORN Antenna SCHWARZBECK	BBHA 9170	BBHA9170243	Dec. 27, 2010	Dec. 26, 2011
Preamplifier Agilent	8449B	3008A01961	Nov. 02, 2010	Nov. 01, 2011
Preamplifier Agilent	8447D	2944A10738	Nov. 02, 2010	Nov. 01, 2011
RF signal cable HUBER+SUHNNER	SUCOFLEX 104	274041/4	Aug. 21, 2010	Aug. 20, 2011
RF signal cable HUBER+SUHNNER	SUCOFLEX 104	283397/4	Aug. 21, 2010	Aug. 20, 2011
Software ADT.	ADT_Radiated_ V7.6.15.9.2	NA	NA	NA
Antenna Tower inn-co GmbH	MA 4000	010303	NA	NA
Antenna Tower Controller inn-co GmbH	CO2000	019303	NA	NA
Turn Table ADT.	TT100.	TT93021704	NA	NA
Turn Table Controller ADT.	SC100.	SC93021704	NA	NA
26GHz ~ 40GHz Amplifier	EM26400	07026401	Aug. 25, 2010	Aug. 24, 2011

- NOTE:**
1. The calibration interval of the above test instruments is 12 months and the calibrations are traceable to NML/ROC and NIST/USA.
  2. The test was performed in HwaYa Chamber 4.
  3. The horn antenna and HP preamplifier (model: 8449B) are used only for the measurement of emission frequency above 1GHz if tested.
  4. The FCC Site Registration No. is 988962.
  5. The IC Site Registration No. is IC7450F-4.



### 5.1.3 TEST PROCEDURES

- a. The EUT was placed on the top of a rotating table 0.8 meters above the ground at a 3 meters semi-anechoic chamber. The table was rotated 360 degrees to determine the position of the highest radiation.
- b. The EUT was set 3 meters away from the interference-receiving antenna, which was mounted on the top of a variable-height antenna tower.
- c. The antenna is a broadband antenna, and its height is varied from one meter to four meters above the ground to determine the maximum value of the field strength. Both horizontal and vertical polarizations of the antenna are set to make the measurement.
- d. For each suspected emission, the EUT was arranged to its worst case and then the antenna was tuned to heights from 1 meter to 4 meters and the rotatable table was turned from 0 degrees to 360 degrees to find the maximum reading.
- e. The test-receiver system was set to Peak Detect Function and Specified Bandwidth with Maximum Hold Mode.
- f. If the emission level of the EUT in peak mode was lower than the limit specified, then testing could be stopped and the peak values of the EUT would be reported. Otherwise the emissions would be re-tested one by one using peak, quasi-peak or average method as specified and then reported in a data sheet.

**NOTE:**

1. The resolution bandwidth and video bandwidth of test receiver/spectrum analyzer is 120kHz for Quasi-peak detection at frequency below 1GHz.
2. The resolution bandwidth of test receiver/spectrum analyzer is 1MHz and video bandwidth is 3MHz for Peak detection at frequency above 1GHz.
3. The resolution bandwidth of test receiver/spectrum analyzer is 1MHz and the video bandwidth is 10Hz for Average detection (AV) at frequency above 1GHz.
4. All modes of operation were investigated and the worst-case emissions are reported.

### 5.1.4 DEVIATION FROM TEST STANDARD

No deviation.

### 5.1.5 TEST SETUP

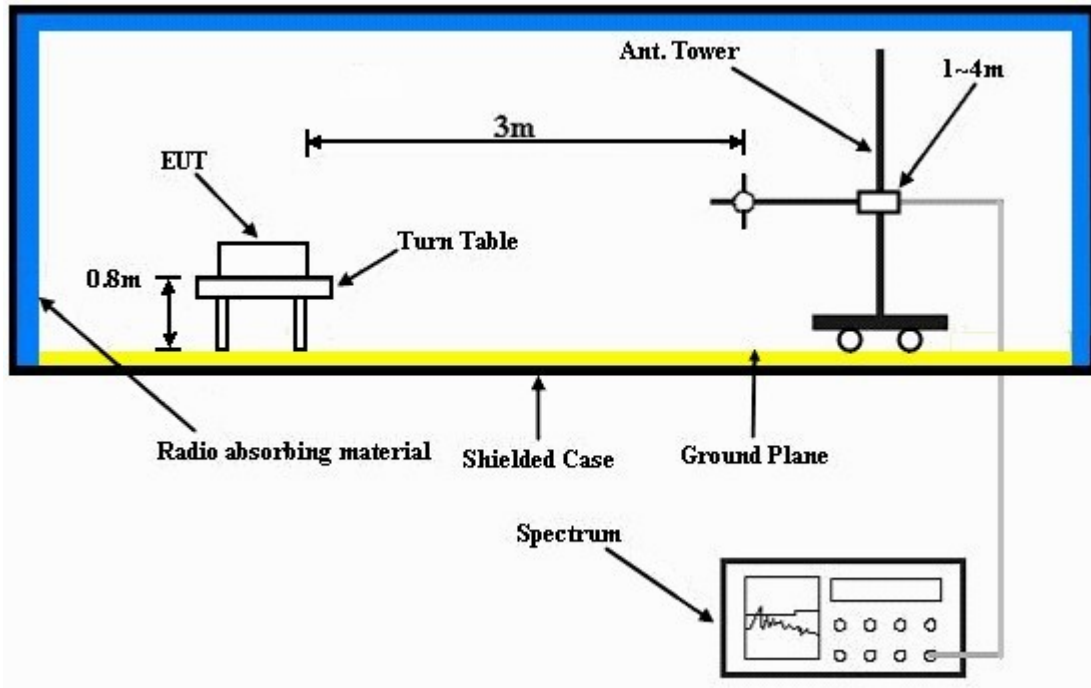

For the actual test configuration, please refer to the attached file (Test Setup Photo).

### 5.1.6 EUT OPERATING CONDITIONS

Same as 4.1.6.





A D T

### 5.1.7 TEST RESULTS

#### 802.11a

EUT TEST CONDITION		MEASUREMENT DETAIL	
CHANNEL	Channel 149	FREQUENCY RANGE	1 ~ 40GHz
INPUT POWER	120Vac, 60 Hz	DETECTOR FUNCTION	Peak (PK) Average (AV)
ENVIRONMENTAL CONDITIONS	24deg. C, 64%RH 1015 hPa	TESTED BY	Match Tsui

ANTENNA POLARITY & TEST DISTANCE: HORIZONTAL AT 3 M								
NO.	FREQ. (MHz)	EMISSION LEVEL (dBuV/m)	LIMIT (dBuV/m)	MARGIN (dB)	ANTENNA HEIGHT (m)	TABLE ANGLE (Degree)	RAW VALUE (dBuV)	CORRECTION FACTOR (dB/m)
1	#5725.00	66.2 PK	85.0	-18.8	1.07 H	250	27.50	38.70
2	#5725.00	51.8 AV	74.8	-23.0	1.07 H	250	13.10	38.70
3	*5745.00	105.0 PK			1.07 H	252	66.20	38.80
4	*5745.00	94.8 AV			1.07 H	252	56.00	38.80
5	11490.00	59.5 PK	74.0	-14.5	1.00 H	180	9.30	50.20
6	11490.00	46.6 AV	54.0	-7.4	1.00 H	180	-3.60	50.20
ANTENNA POLARITY & TEST DISTANCE: VERTICAL AT 3 M								
NO.	FREQ. (MHz)	EMISSION LEVEL (dBuV/m)	LIMIT (dBuV/m)	MARGIN (dB)	ANTENNA HEIGHT (m)	TABLE ANGLE (Degree)	RAW VALUE (dBuV)	CORRECTION FACTOR (dB/m)
1	#5725.00	61.8 PK	83.2	-21.4	1.37 V	118	23.10	38.70
2	#5725.00	51.1 AV	72.5	-21.4	1.37 V	118	12.40	38.70
3	*5745.00	103.2 PK			1.37 V	118	64.40	38.80
4	*5745.00	92.5 AV			1.37 V	118	53.70	38.80
5	11490.00	59.4 PK	74.0	-14.6	1.01 V	10	9.20	50.20
6	11490.00	46.5 AV	54.0	-7.5	1.01 V	10	-3.70	50.20

- REMARKS:**
1. Emission level (dBuV/m) = Raw Value (dBuV) + Correction Factor (dB/m).
  2. Correction Factor (dB/m) = Antenna Factor (dB/m) + Cable Factor (dB).
  3. The other emission levels were very low against the limit.
  4. Margin value = Emission level – Limit value.
  5. “ \* “: Fundamental frequency.
  6. The limit value is defined as per 15.247.
  7. "#":The radiated frequency is out the restricted band.



A D T

EUT TEST CONDITION		MEASUREMENT DETAIL	
CHANNEL	Channel 157	FREQUENCY RANGE	1 ~ 40GHz
INPUT POWER	120Vac, 60 Hz	DETECTOR FUNCTION	Peak (PK) Average (AV)
ENVIRONMENTAL CONDITIONS	24deg. C, 64%RH 1015 hPa	TESTED BY	Match Tsui

ANTENNA POLARITY & TEST DISTANCE: HORIZONTAL AT 3 M								
NO.	FREQ. (MHz)	EMISSION LEVEL (dBuV/m)	LIMIT (dBuV/m)	MARGIN (dB)	ANTENNA HEIGHT (m)	TABLE ANGLE (Degree)	RAW VALUE (dBuV)	CORRECTION FACTOR (dB/m)
1	#5725.00	62.5 PK	86.4	-23.9	1.10 H	251	23.80	38.70
2	#5725.00	48.4 AV	75.6	-27.2	1.10 H	251	9.70	38.70
3	*5785.00	106.4 PK			1.10 H	251	67.50	38.90
4	*5785.00	95.6 AV			1.10 H	251	56.70	38.90
5	11570.00	59.2 PK	74.0	-14.8	1.10 H	360	9.20	50.00
6	11570.00	46.7 AV	54.0	-7.3	1.10 H	360	-3.30	50.00

ANTENNA POLARITY & TEST DISTANCE: VERTICAL AT 3 M								
NO.	FREQ. (MHz)	EMISSION LEVEL (dBuV/m)	LIMIT (dBuV/m)	MARGIN (dB)	ANTENNA HEIGHT (m)	TABLE ANGLE (Degree)	RAW VALUE (dBuV)	CORRECTION FACTOR (dB/m)
1	#5725.00	62.1 PK	83.5	-21.4	1.33 V	120	23.40	38.70
2	#5725.00	47.9 AV	73.0	-25.1	1.33 V	120	9.20	38.70
3	*5785.00	103.5 PK			1.33 V	120	64.60	38.90
4	*5785.00	93.0 AV			1.33 V	120	54.10	38.90
5	11570.00	59.1 PK	74.0	-14.9	1.00 V	333	9.10	50.00
6	11570.00	46.3 AV	54.0	-7.7	1.00 V	333	-3.70	50.00

- REMARKS:**
1. Emission level (dBuV/m) = Raw Value (dBuV) + Correction Factor (dB/m).
  2. Correction Factor (dB/m) = Antenna Factor (dB/m) + Cable Factor (dB).
  3. The other emission levels were very low against the limit.
  4. Margin value = Emission level – Limit value.
  5. “ \* “: Fundamental frequency.
  6. The limit value is defined as per 15.247.
  7. “#”:The radiated frequency is out the restricted band.



A D T

EUT TEST CONDITION		MEASUREMENT DETAIL	
CHANNEL	Channel 165	FREQUENCY RANGE	1 ~ 40GHz
INPUT POWER	120Vac, 60 Hz	DETECTOR FUNCTION	Peak (PK) Average (AV)
ENVIRONMENTAL CONDITIONS	24deg. C, 64%RH 1015 hPa	TESTED BY	Match Tsui

ANTENNA POLARITY & TEST DISTANCE: HORIZONTAL AT 3 M								
NO.	FREQ. (MHz)	EMISSION LEVEL (dBuV/m)	LIMIT (dBuV/m)	MARGIN (dB)	ANTENNA HEIGHT (m)	TABLE ANGLE (Degree)	RAW VALUE (dBuV)	CORRECTION FACTOR (dB/m)
1	*5825.00	107.5 PK			1.05 H	262	68.60	38.90
2	*5825.00	96.7 AV			1.05 H	262	57.80	38.90
3	#5850.00	63.3 PK	87.5	-24.2	1.05 H	262	24.30	39.00
4	#5850.00	51.3 AV	76.7	-25.4	1.05 H	262	12.30	39.00
5	11650.00	59.4 PK	74.0	-14.6	1.05 H	360	9.50	49.90
6	11650.00	46.4 AV	54.0	-7.6	1.05 H	360	-3.50	49.90
ANTENNA POLARITY & TEST DISTANCE: VERTICAL AT 3 M								
NO.	FREQ. (MHz)	EMISSION LEVEL (dBuV/m)	LIMIT (dBuV/m)	MARGIN (dB)	ANTENNA HEIGHT (m)	TABLE ANGLE (Degree)	RAW VALUE (dBuV)	CORRECTION FACTOR (dB/m)
1	*5825.00	103.8 PK			1.00 V	309	64.90	38.90
2	*5825.00	93.1 AV			1.00 V	309	54.20	38.90
3	#5850.00	61.4 PK	83.8	-22.4	1.00 V	309	22.40	39.00
4	#5850.00	50.8 AV	73.1	-22.3	1.00 V	309	11.80	39.00
5	11650.00	59.0 PK	74.0	-15.0	1.00 V	180	9.10	49.90
6	11650.00	46.3 AV	54.0	-7.7	1.00 V	180	-3.60	49.90

- REMARKS:**
1. Emission level (dBuV/m) = Raw Value (dBuV) + Correction Factor (dB/m).
  2. Correction Factor (dB/m) = Antenna Factor (dB/m) + Cable Factor (dB).
  3. The other emission levels were very low against the limit.
  4. Margin value = Emission level – Limit value.
  5. “ \* “: Fundamental frequency.
  6. The limit value is defined as per 15.247.
  7. “#”:The radiated frequency is out the restricted band.



A D T

### 802.11n (20MHz)

EUT TEST CONDITION		MEASUREMENT DETAIL	
CHANNEL	Channel 149	FREQUENCY RANGE	1 ~ 40GHz
INPUT POWER	120Vac, 60 Hz	DETECTOR FUNCTION	Peak (PK) Average (AV)
ENVIRONMENTAL CONDITIONS	24deg. C, 64%RH 1015 hPa	TESTED BY	Match Tsui

ANTENNA POLARITY & TEST DISTANCE: HORIZONTAL AT 3 M								
NO.	FREQ. (MHz)	EMISSION LEVEL (dBuV/m)	LIMIT (dBuV/m)	MARGIN (dB)	ANTENNA HEIGHT (m)	TABLE ANGLE (Degree)	RAW VALUE (dBuV)	CORRECTION FACTOR (dB/m)
1	#5725.00	67.2 PK	84.8	-17.6	1.00 H	264	28.50	38.70
2	#5725.00	52.7 AV	74.4	-21.7	1.00 H	264	14.00	38.70
3	*5745.00	104.8 PK			1.00 H	264	66.00	38.80
4	*5745.00	94.4 AV			1.00 H	264	55.60	38.80
5	11490.00	59.6 PK	74.0	-14.4	1.00 H	360	9.40	50.20
6	11490.00	46.7 AV	54.0	-7.3	1.00 H	360	-3.50	50.20

ANTENNA POLARITY & TEST DISTANCE: VERTICAL AT 3 M								
NO.	FREQ. (MHz)	EMISSION LEVEL (dBuV/m)	LIMIT (dBuV/m)	MARGIN (dB)	ANTENNA HEIGHT (m)	TABLE ANGLE (Degree)	RAW VALUE (dBuV)	CORRECTION FACTOR (dB/m)
1	#5725.00	61.9 PK	83.0	-21.1	1.31 V	120	23.20	38.70
2	#5725.00	51.4 AV	72.2	-20.8	1.31 V	120	12.70	38.70
3	*5745.00	103.0 PK			1.31 V	120	64.20	38.80
4	*5745.00	92.2 AV			1.31 V	120	53.40	38.80
5	11490.00	59.4 PK	74.0	-14.6	1.31 V	0	9.20	50.20
6	11490.00	46.5 AV	54.0	-7.5	1.31 V	0	-3.70	50.20

- REMARKS:**
1. Emission level (dBuV/m) = Raw Value (dBuV) + Correction Factor (dB/m).
  2. Correction Factor (dB/m) = Antenna Factor (dB/m) + Cable Factor (dB).
  3. The other emission levels were very low against the limit.
  4. Margin value = Emission level – Limit value.
  5. “ \* “: Fundamental frequency.
  6. The limit value is defined as per 15.247.
  7. “#”:The radiated frequency is out the restricted band.



A D T

EUT TEST CONDITION		MEASUREMENT DETAIL	
CHANNEL	Channel 157	FREQUENCY RANGE	1 ~ 40GHz
INPUT POWER	120Vac, 60 Hz	DETECTOR FUNCTION	Peak (PK) Average (AV)
ENVIRONMENTAL CONDITIONS	24deg. C, 64%RH 1015 hPa	TESTED BY	Match Tsui

ANTENNA POLARITY & TEST DISTANCE: HORIZONTAL AT 3 M								
NO.	FREQ. (MHz)	EMISSION LEVEL (dBuV/m)	LIMIT (dBuV/m)	MARGIN (dB)	ANTENNA HEIGHT (m)	TABLE ANGLE (Degree)	RAW VALUE (dBuV)	CORRECTION FACTOR (dB/m)
1	#5725.00	62.1 PK	86.0	-23.9	1.09 H	249	23.40	38.70
2	#5725.00	48.0 AV	75.4	-27.4	1.09 H	249	9.30	38.70
3	*5785.00	106.0 PK			1.09 H	249	67.10	38.90
4	*5785.00	95.4 AV			1.09 H	249	56.50	38.90
5	11570.00	59.1 PK	74.0	-14.9	1.00 H	360	9.10	50.00
6	11570.00	46.3 AV	54.0	-7.7	1.00 H	360	-3.70	50.00
ANTENNA POLARITY & TEST DISTANCE: VERTICAL AT 3 M								
NO.	FREQ. (MHz)	EMISSION LEVEL (dBuV/m)	LIMIT (dBuV/m)	MARGIN (dB)	ANTENNA HEIGHT (m)	TABLE ANGLE (Degree)	RAW VALUE (dBuV)	CORRECTION FACTOR (dB/m)
1	#5725.00	61.9 PK	83.2	-21.3	1.31 V	122	23.20	38.70
2	#5725.00	47.2 AV	72.6	-25.4	1.31 V	122	8.50	38.70
3	*5785.00	103.2 PK			1.31 V	122	64.30	38.90
4	*5785.00	92.6 AV			1.31 V	122	53.70	38.90
5	11570.00	59.1 PK	74.0	-14.9	1.01 V	0	9.10	50.00
6	11570.00	46.3 AV	54.0	-7.7	1.01 V	0	-3.70	50.00

- REMARKS:**
1. Emission level (dBuV/m) = Raw Value (dBuV) + Correction Factor (dB/m).
  2. Correction Factor (dB/m) = Antenna Factor (dB/m) + Cable Factor (dB).
  3. The other emission levels were very low against the limit.
  4. Margin value = Emission level – Limit value.
  5. “ \* “: Fundamental frequency.
  6. The limit value is defined as per 15.247.
  7. "#":The radiated frequency is out the restricted band.



A D T

EUT TEST CONDITION		MEASUREMENT DETAIL	
CHANNEL	Channel 165	FREQUENCY RANGE	1 ~ 40GHz
INPUT POWER	120Vac, 60 Hz	DETECTOR FUNCTION	Peak (PK) Average (AV)
ENVIRONMENTAL CONDITIONS	24deg. C, 64%RH 1015 hPa	TESTED BY	Match Tsui

ANTENNA POLARITY & TEST DISTANCE: HORIZONTAL AT 3 M								
NO.	FREQ. (MHz)	EMISSION LEVEL (dBuV/m)	LIMIT (dBuV/m)	MARGIN (dB)	ANTENNA HEIGHT (m)	TABLE ANGLE (Degree)	RAW VALUE (dBuV)	CORRECTION FACTOR (dB/m)
1	*5825.00	106.8 PK			1.04 H	266	67.90	38.90
2	*5825.00	96.1 AV			1.04 H	266	57.20	38.90
3	#5850.00	63.0 PK	86.8	-23.8	1.04 H	266	24.00	39.00
4	#5850.00	51.1 AV	76.1	-25.0	1.04 H	266	12.10	39.00
5	11650.00	59.4 PK	74.0	-14.6	1.04 H	360	9.50	49.90
6	11650.00	46.4 AV	54.0	-7.6	1.04 H	360	-3.50	49.90
ANTENNA POLARITY & TEST DISTANCE: VERTICAL AT 3 M								
NO.	FREQ. (MHz)	EMISSION LEVEL (dBuV/m)	LIMIT (dBuV/m)	MARGIN (dB)	ANTENNA HEIGHT (m)	TABLE ANGLE (Degree)	RAW VALUE (dBuV)	CORRECTION FACTOR (dB/m)
1	*5825.00	103.5 PK			1.29 V	119	64.60	38.90
2	*5825.00	92.8 AV			1.29 V	119	53.90	38.90
3	#5850.00	61.6 PK	83.5	-21.9	1.29 V	119	22.60	39.00
4	#5850.00	51.1 AV	72.8	-21.7	1.29 V	119	12.10	39.00
5	11650.00	59.1 PK	74.0	-14.9	1.09 V	10	9.20	49.90
6	11650.00	46.3 AV	54.0	-7.7	1.09 V	10	-3.60	49.90

- REMARKS:**
1. Emission level (dBuV/m) = Raw Value (dBuV) + Correction Factor (dB/m).
  2. Correction Factor (dB/m) = Antenna Factor (dB/m) + Cable Factor (dB).
  3. The other emission levels were very low against the limit.
  4. Margin value = Emission level – Limit value.
  5. “ \* “: Fundamental frequency.
  6. The limit value is defined as per 15.247.
  7. “#”:The radiated frequency is out the restricted band.



A D T

**BELOW 1GHz WORST-CASE DATA : 802.11a**

EUT TEST CONDITION		MEASUREMENT DETAIL	
CHANNEL	Channel 157	FREQUENCY RANGE	Below 1000MHz
INPUT POWER	120Vac, 60 Hz	DETECTOR FUNCTION	Quasi-Peak
ENVIRONMENTAL CONDITIONS	24deg. C, 64%RH 1019 hPa	TESTED BY	Match Tsui

ANTENNA POLARITY & TEST DISTANCE: HORIZONTAL AT 3 M								
NO.	FREQ. (MHz)	EMISSION LEVEL (dBuV/m)	LIMIT (dBuV/m)	MARGIN (dB)	ANTENNA HEIGHT (m)	TABLE ANGLE (Degree)	RAW VALUE (dBuV)	CORRECTION FACTOR (dB/m)
1	199.05	32.6 QP	43.5	-10.9	1.00 H	274	20.40	12.20
2	232.11	33.9 QP	46.0	-12.1	1.25 H	253	20.90	13.00
3	374.04	34.2 QP	46.0	-11.8	1.00 H	205	16.40	17.80
4	399.31	38.3 QP	46.0	-7.7	1.00 H	346	19.70	18.60
5	558.75	33.2 QP	46.0	-12.8	1.50 H	4	10.40	22.80
6	638.46	33.1 QP	46.0	-12.9	1.25 H	337	8.90	24.20
7	718.18	35.1 QP	46.0	-10.9	1.25 H	10	9.60	25.50
ANTENNA POLARITY & TEST DISTANCE: VERTICAL AT 3 M								
NO.	FREQ. (MHz)	EMISSION LEVEL (dBuV/m)	LIMIT (dBuV/m)	MARGIN (dB)	ANTENNA HEIGHT (m)	TABLE ANGLE (Degree)	RAW VALUE (dBuV)	CORRECTION FACTOR (dB/m)
1	66.84	27.7 QP	40.0	-12.3	1.50 V	175	14.60	13.10
2	374.04	36.3 QP	46.0	-9.7	1.25 V	232	18.50	17.80
3	399.31	38.6 QP	46.0	-7.4	1.25 V	313	20.00	18.60
4	558.75	34.5 QP	46.0	-11.5	1.00 V	271	11.70	22.80
5	718.18	32.6 QP	46.0	-13.4	2.00 V	232	7.10	25.50
6	900.94	32.1 QP	46.0	-13.9	1.00 V	268	3.40	28.70

- REMARKS:**
1. Emission level (dBuV/m) = Raw Value (dBuV) + Correction Factor (dB/m).
  2. Correction Factor (dB/m) = Antenna Factor (dB/m) + Cable Factor (dB).
  3. The other emission levels were very low against the limit.
  4. Margin value = Emission level – Limit value.



## 5.2 CONDUCTED EMISSION MEASUREMENT

### 5.2.1 LIMITS OF CONDUCTED EMISSION MEASUREMENT

FREQUENCY OF EMISSION (MHz)	CONDUCTED LIMIT (dBµV)	
	Quasi-peak	Average
0.15 ~ 0.5	66 to 56	56 to 46
0.5 ~ 5	56	46
5 ~ 30	60	50

- NOTE:** 1. The lower limit shall apply at the transition frequencies.  
 2. The limit decreases in line with the logarithm of the frequency in the range of 0.15 to 0.50MHz.  
 3. All emanations from a class A/B digital device or system, including any network of conductors and apparatus connected thereto, shall not exceed the level of field strengths specified above.

### 5.2.2 TEST INSTRUMENTS

DESCRIPTION & MANUFACTURER	MODEL NO.	SERIAL NO.	DATE OF CALIBRATION	DUE DATE OF CALIBRATION
Test Receiver ROHDE & SCHWARZ	ESCS30	100289	Nov. 23, 2010	Nov. 22, 2011
RF signal cable Woken	5D-FB	Cable-HYCO2-01	Dec. 30, 2010	Dec. 29, 2011
LISN ROHDE & SCHWARZ	ESH2-Z5	100100	Jan. 06, 2011	Jan. 05, 2012
LISN ROHDE & SCHWARZ	ESH3-Z5	100311	Jul. 08, 2010	Jul. 07, 2011
V-LISN SCHWARZBECK	NNBL 8226-2	8226-142	Jul. 12, 2010	Jul. 11, 2011
LISN ROHDE & SCHWARZ	ENV216	100072	Jun. 11, 2010	Jun. 10, 2011
Software ADT	ADT_Cond_ V7.3.7	NA	NA	NA

- NOTE:** 1. The calibration interval of the above test instruments is 12 months and the calibrations are traceable to NML/ROC and NIST/USA.  
 2. The test was performed in HwaYa Shielded Room 2.  
 3. The VCCI Site Registration No. is C-2047.





A D T

### 5.2.3 TEST PROCEDURES

- a. The EUT was placed 0.4 meters from the conducting wall of the shielded room with EUT being connected to the power mains through a line impedance stabilization network (LISN). Other support units were connected to the power mains through another LISN. The two LISNs provide 50 ohm/ 50uH of coupling impedance for the measuring instrument.
- b. Both lines of the power mains connected to the EUT were checked for maximum conducted interference.
- c. The frequency range from 150kHz to 30MHz was searched. Emission levels under (Limit - 20dB) was not recorded.

**NOTE:** All modes of operation were investigated and the worst-case emissions are reported.

### 5.2.4 DEVIATION FROM TEST STANDARD

No deviation.

## 5.2.5 TEST SETUP

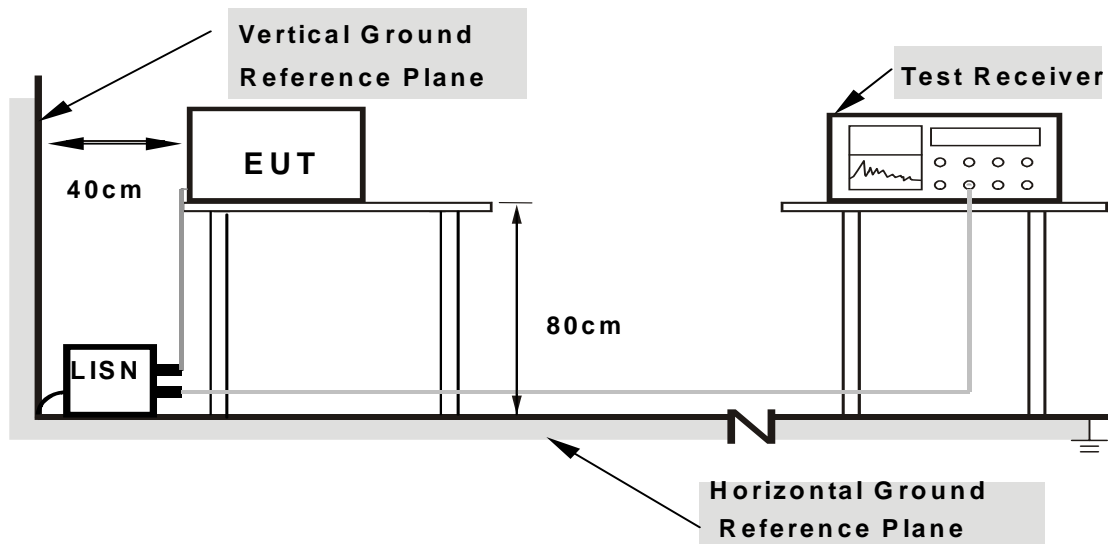

**Note: 1.Support units were connected to second LISN.**

**2.Both of LISNs (AMN) are 80 cm from EUT and at least 80 from other units and other metal planes**

For the actual test configuration, please refer to the attached file (Test Setup Photo).

## 5.2.6 EUT OPERATING CONDITIONS

Same as 4.1.6.

### 5.2.7 TEST RESULTS

**CONDUCTED WORST-CASE DATA : 802.11a**

<b>PHASE</b>	Line 1	<b>6dB BANDWIDTH</b>	9kHz
--------------	--------	----------------------	------

No	Freq.	Corr.	Reading Value		Emission Level		Limit		Margin	
	[MHz]	(dB)	[dB (uV)]		[dB (uV)]		[dB (uV)]		(dB)	
			Q.P.	AV.	Q.P.	AV.	Q.P.	AV.	Q.P.	AV.
1	0.162	0.15	41.06	-	41.21	-	65.38	55.38	-24.17	-
<b>2</b>	<b>0.478</b>	<b>0.17</b>	<b>41.94</b>	-	<b>42.11</b>	-	<b>56.37</b>	<b>46.37</b>	<b>-14.26</b>	-
3	0.845	0.18	39.14	-	39.32	-	56.00	46.00	-16.68	-
4	3.199	0.28	26.55	-	26.83	-	56.00	46.00	-29.17	-
5	7.281	0.45	27.79	-	28.24	-	60.00	50.00	-31.76	-
6	23.230	1.20	27.88	-	29.08	-	60.00	50.00	-30.92	-

- REMARKS:**
1. Q.P. and AV. are abbreviations of quasi-peak and average individually.
  2. "-": The Quasi-peak reading value also meets average limit and measurement with the average detector is unnecessary.
  3. The emission levels of other frequencies were very low against the limit.
  4. Margin value = Emission level - Limit value
  5. Correction factor = Insertion loss + Cable loss
  6. Emission Level = Correction Factor + Reading Value.

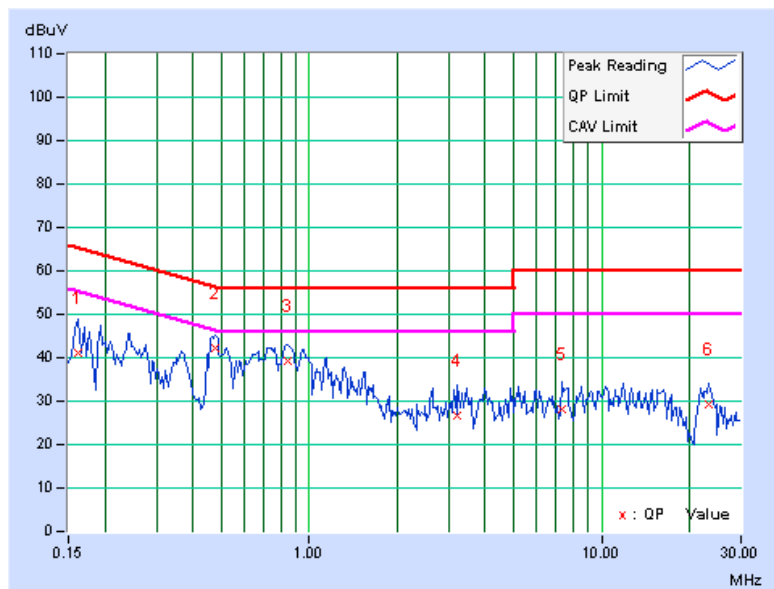

PHASE	Line 2	6dB BANDWIDTH	9kHz
-------	--------	---------------	------

No	Freq.	Corr.	Reading Value		Emission Level		Limit		Margin	
	[MHz]	Factor	[dB (uV)]		[dB (uV)]		[dB (uV)]		(dB)	
		(dB)	Q.P.	AV.	Q.P.	AV.	Q.P.	AV.	Q.P.	AV.
1	0.166	0.16	42.07	-	42.23	-	65.18	55.18	-22.95	-
2	0.248	0.17	39.62	-	39.79	-	61.84	51.84	-22.04	-
3	0.818	0.20	35.10	-	35.30	-	56.00	46.00	-20.70	-
4	4.789	0.34	26.78	-	27.12	-	56.00	46.00	-28.88	-
5	14.801	0.72	27.84	-	28.56	-	60.00	50.00	-31.44	-
6	23.160	1.00	28.13	-	29.13	-	60.00	50.00	-30.87	-

- REMARKS:**
1. Q.P. and AV. are abbreviations of quasi-peak and average individually.
  2. "-": The Quasi-peak reading value also meets average limit and measurement with the average detector is unnecessary.
  3. The emission levels of other frequencies were very low against the limit.
  4. Margin value = Emission level - Limit value
  5. Correction factor = Insertion loss + Cable loss
  6. Emission Level = Correction Factor + Reading Value.

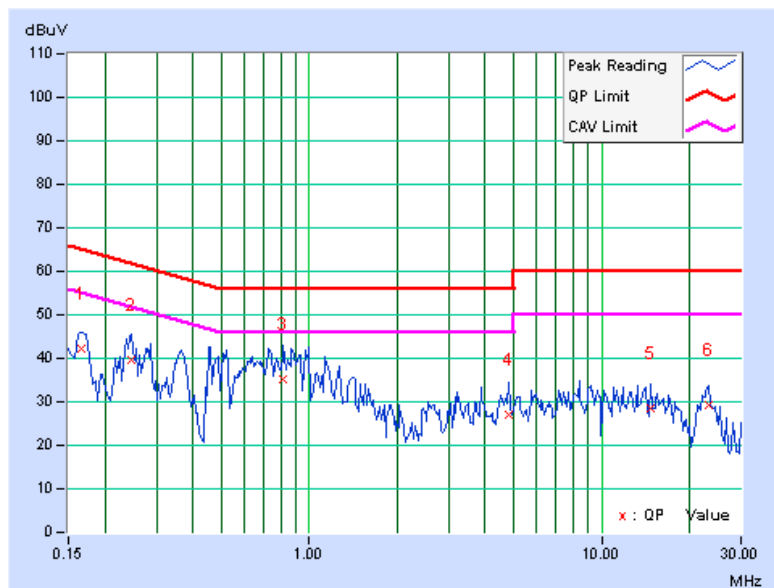

### 5.3 6dB BANDWIDTH MEASUREMENT

#### 5.3.1 LIMITS OF 6dB BANDWIDTH MEASUREMENT

The minimum of 6dB Bandwidth Measurement is 0.5MHz.

#### 5.3.2 TEST INSTRUMENTS

DESCRIPTION & MANUFACTURER	MODEL NO.	SERIAL NO.	DATE OF CALIBRATION	DUE DATE OF CALIBRATION
SPECTRUM ANALYZER R&S	FSP40	100039	Jan. 11, 2011	Jan. 10, 2012

**NOTE:** The calibration interval of the above test instruments is 12 months and the calibrations are traceable to NML/ROC and NIST/USA.

#### 5.3.3 TEST PROCEDURE

The transmitter output was connected to the spectrum analyzer through an attenuator. The bandwidth of the fundamental frequency was measured by spectrum analyzer with 100kHz RBW and 300kHz VBW. The 6dB bandwidth is defined as the total spectrum the power of which is higher than peak power minus 6dB.

### 5.3.4 DEVIATION FROM TEST STANDARD

No deviation.

### 5.3.5 TEST SETUP

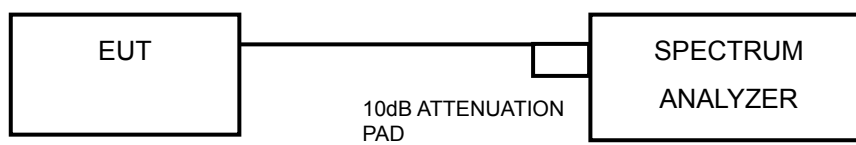

### 5.3.6 EUT OPERATING CONDITIONS

The software provided by client to enable the EUT under transmission condition continuously at lowest, middle and highest channel frequencies individually.



A D T

### 5.3.7 TEST RESULTS

#### 802.11a

CHANNEL	CHANNEL FREQUENCY (MHz)	6dB BANDWIDTH (MHz)	MINIMUM LIMIT (MHz)	PASS / FAIL
149	5745	15.17	0.5	PASS
157	5785	15.18	0.5	PASS
165	5825	15.17	0.5	PASS

#### CH 157

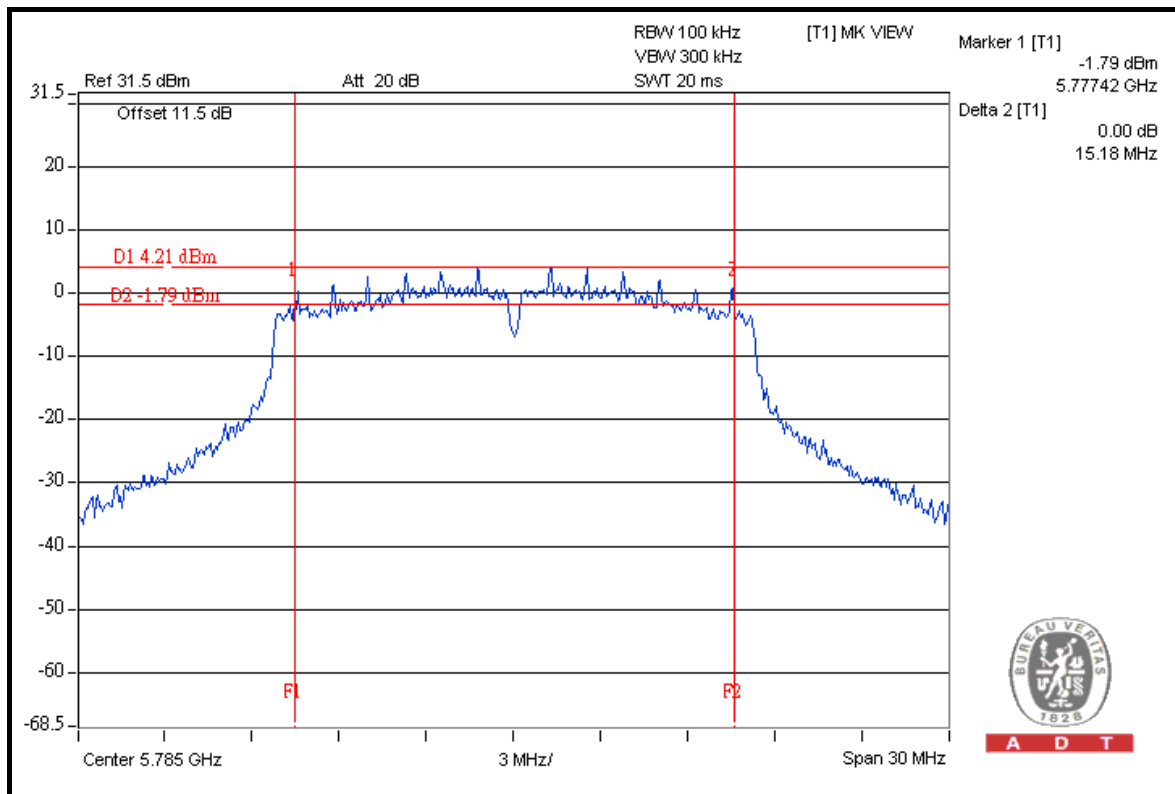



A D T

### 802.11n (20MHz)

CHANNEL	CHANNEL FREQUENCY (MHz)	6dB BANDWIDTH (MHz)	MINIMUM LIMIT (MHz)	PASS / FAIL
149	5745	13.91	0.5	PASS
157	5785	15.17	0.5	PASS
165	5825	15.16	0.5	PASS

### CH 157

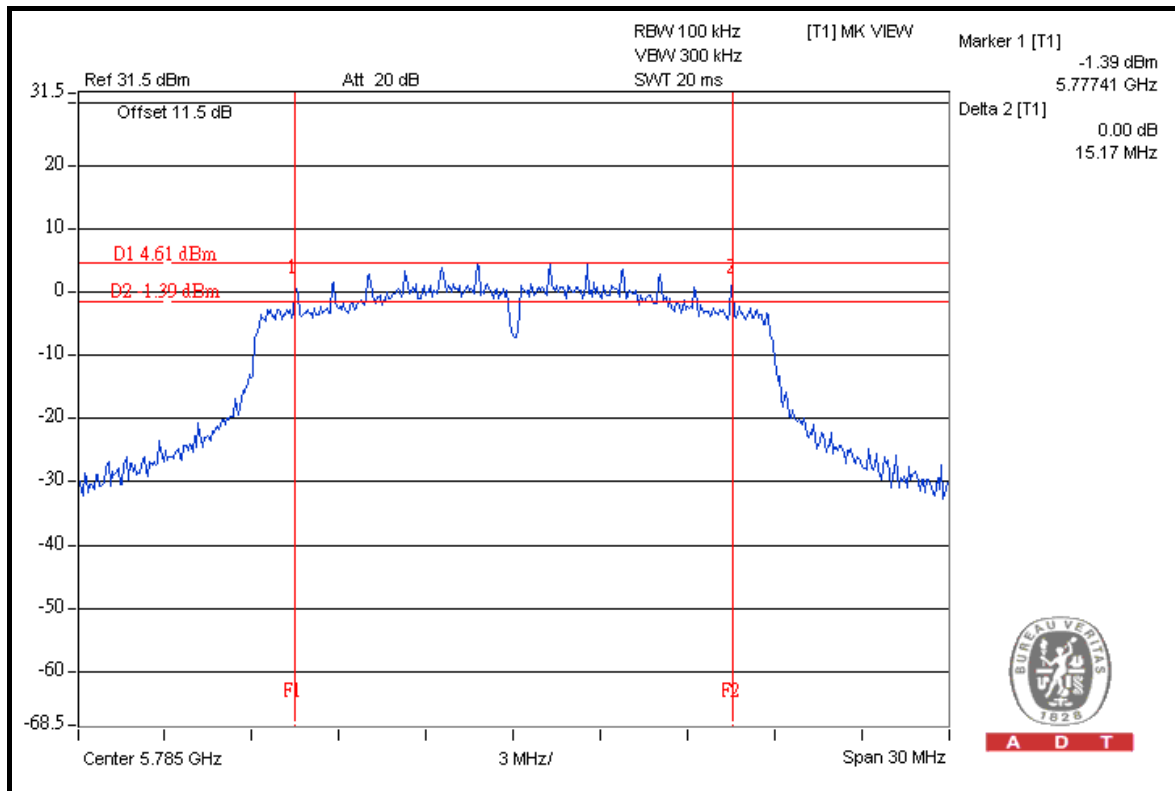





A D T

## 5.4 MAXIMUM OUTPUT POWER

### 5.4.1 LIMITS OF MAXIMUM OUTPUT POWER MEASUREMENT

The Maximum Output Power Measurement is 30dBm.

### 5.4.2 INSTRUMENTS

DESCRIPTION & MANUFACTURER	MODEL NO.	SERIAL NO.	DATE OF CALIBRATION	DUE DATE OF CALIBRATION
High Speed Peak Power Meter	ML2495A	0842014	Apr. 21, 2010	Apr. 20, 2011
Power Sensor	MA2411B	0738404	Apr. 21, 2010	Apr. 20, 2011

**NOTE:**

1. The calibration interval of the above test instruments is 12 months and the calibrations are traceable to NML/ROC and NIST/USA.
2. Measurement Bandwidth of ML2495A is 65MHz greater than 6dB bandwidth of emission.

### 5.4.3 TEST PROCEDURE

A power sensor was used on the output port of the EUT. A power meter was used to read the response of the power sensor. Record the power level.

#### 5.4.4 DEVIATION FROM TEST STANDARD

No deviation.

#### 5.4.5 TEST SETUP

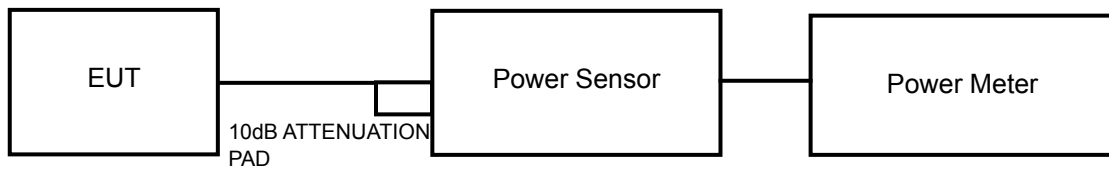

#### 5.4.6 EUT OPERATING CONDITIONS

Same as Item 5.3.6.



A D T

## 5.4.7 TEST RESULTS

### 802.11a

CHANNEL	CHANNEL FREQUENCY (MHz)	POWER OUTPUT (mW)	POWER OUTPUT (dBm)	POWER LIMIT (dBm)	PASS/FAIL
149	5745	263.0	24.2	30	PASS
157	5785	281.8	24.5	30	PASS
165	5825	257.0	24.1	30	PASS

### 802.11n (20MHz)

CHANNEL	CHANNEL FREQUENCY (MHz)	POWER OUTPUT (mW)	POWER OUTPUT (dBm)	POWER LIMIT (dBm)	PASS/FAIL
149	5745	269.2	24.3	30	PASS
157	5785	281.8	24.5	30	PASS
165	5825	263.0	24.2	30	PASS



## 5.5 POWER SPECTRAL DENSITY MEASUREMENT

### 5.5.1 LIMITS OF POWER SPECTRAL DENSITY MEASUREMENT

The Maximum of Power Spectral Density Measurement is 8dBm.

### 5.5.2 TEST INSTRUMENTS

DESCRIPTION & MANUFACTURER	MODEL NO.	SERIAL NO.	DATE OF CALIBRATION	DUE DATE OF CALIBRATION
SPECTRUM ANALYZER R&S	FSP40	100039	Jan. 11, 2011	Jan. 10, 2012

**NOTE:** The calibration interval of the above test instruments is 12 months and the calibrations are traceable to NML/ROC and NIST/USA.

### 5.5.3 TEST PROCEDURE

1. Follow DTS measurement (PSD Option 2), the transmitter output was connected to the spectrum analyzer through an attenuator, the bandwidth of the fundamental frequency was measured with the spectrum analyzer. Locate and zoom in on emission peak(s) within the pass band.
2. Set RBW = 3 kHz /VBW > 9 kHz and sweep time to Automatic.
3. Detector use peak mode and a video trigger with the trigger level set to enable triggering only on full power pulses.
4. Trace average 100 traces in power averaging mode. The power spectral density was measured and recorded.

#### 5.5.4 DEVIATION FROM TEST STANDARD

No deviation.

#### 5.5.5 TEST SETUP

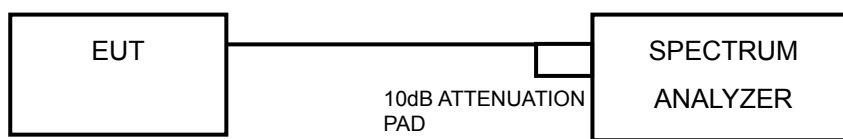

#### 5.5.6 EUT OPERATING CONDITION

Same as Item 5.3.6.



A D T

### 5.5.7 TEST RESULTS

#### 802.11a

CHANNEL	CHANNEL FREQUENCY (MHz)	RF POWER LEVEL IN 3 kHz BW (dBm)	MAXIMUM LIMIT (dBm)	PASS/FAIL
149	5745	-10.5	8	PASS
157	5785	-10.0	8	PASS
165	5825	-10.5	8	PASS

#### CH 157

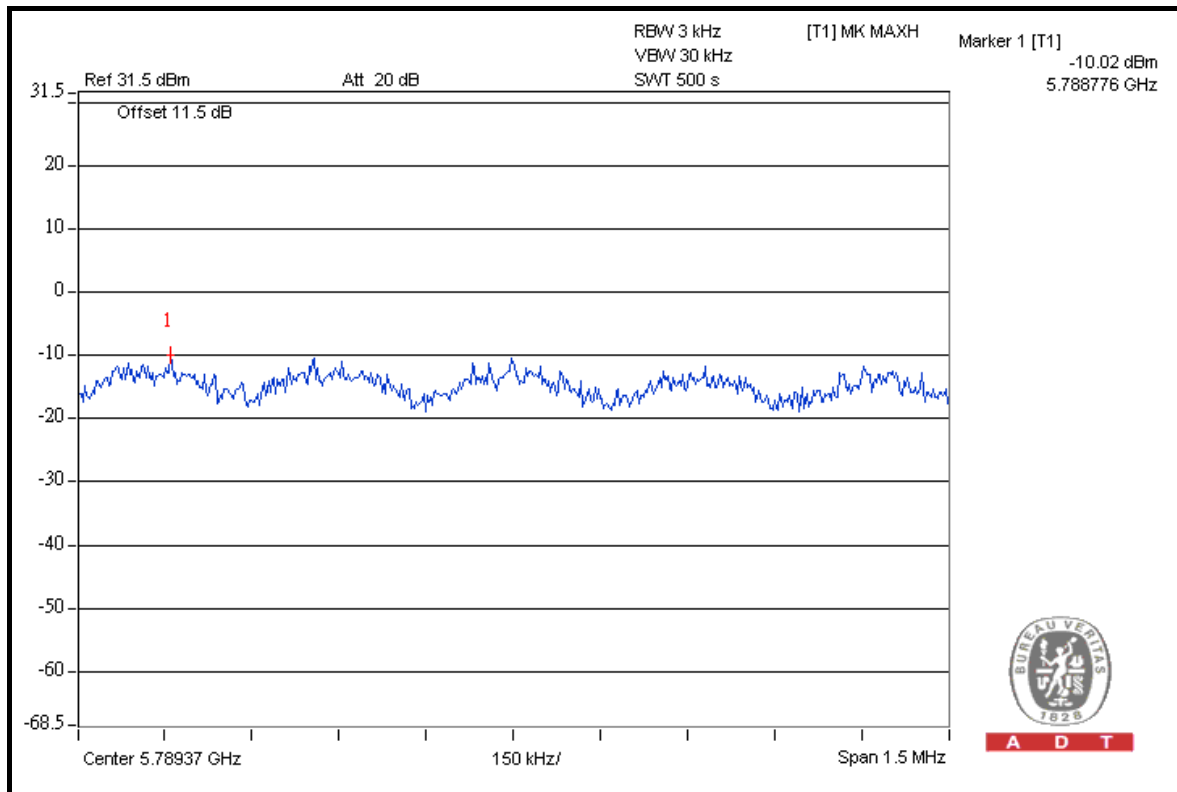

A D T



A D T

### 802.11n (20MHz)

CHANNEL	CHANNEL FREQUENCY (MHz)	RF POWER LEVEL IN 3 kHz BW (dBm)	MAXIMUM LIMIT (dBm)	PASS/FAIL
149	5745	-9.8	8	PASS
157	5785	-9.8	8	PASS
165	5825	-10.0	8	PASS

### CH 157

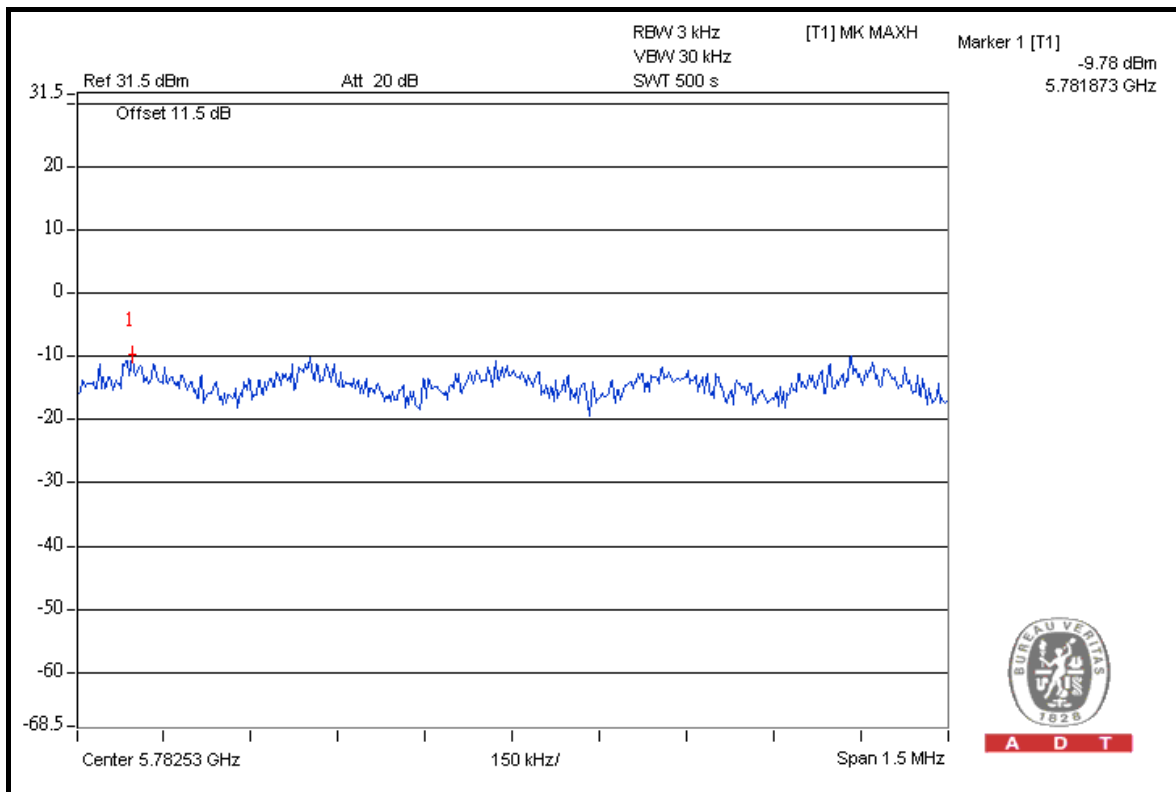



A D T

## 5.6 BAND EDGES MEASUREMENT

### 5.6.1 LIMITS OF BAND EDGES MEASUREMENT

Below  $-20\text{dB}$  of the highest emission level of operating band (in 100kHz Resolution Bandwidth).

**Note:** Follow DTS measurement, If the device complies with the use of power option 2 the attenuation under this paragraph shall be 30 dB instead of 20 dB.

### 5.6.2 TEST INSTRUMENTS

DESCRIPTION & MANUFACTURER	MODEL NO.	SERIAL NO.	DATE OF CALIBRATION	DUE DATE OF CALIBRATION
SPECTRUM ANALYZER R&S	FSP40	100039	Jan. 11, 2011	Jan. 10, 2012

**NOTE:** The calibration interval of the above test instruments is 12 months and the calibrations are traceable to NML/ROC and NIST/USA.

### 5.6.3 TEST PROCEDURE

The transmitter output was connected to the spectrum analyzer via a low lose cable. Set both RBW and VBW of spectrum analyzer to 100kHz and 300kHz with suitable frequency span including 100MHz bandwidth from band edge. The band edges was measured and recorded.

The spectrum plots (Peak RBW = 100kHz, VBW = 300kHz; Average RBW = 1MHz, VBW = 10Hz) are attached on the following pages.

### 5.6.4 DEVIATION FROM TEST STANDARD

No deviation.





A D T

### 5.6.5 EUT OPERATING CONDITION

Same as Item 5.3.6.

### 5.6.6 TEST RESULTS

The spectrum plots are attached on the following pages. D1 line indicates the highest level, D2 line indicates the 20dB offset below D1. It shows compliance with the requirement in part 15.247(d).



A D T

### 802.11a

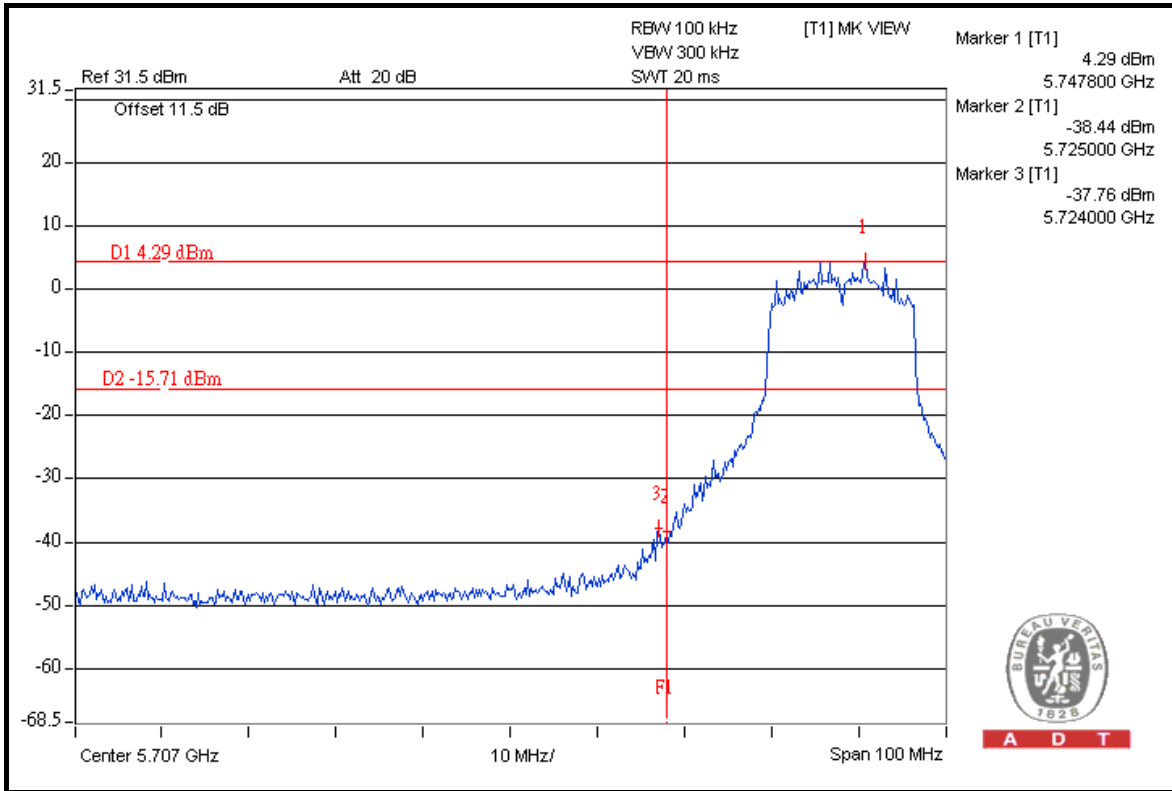

A D T

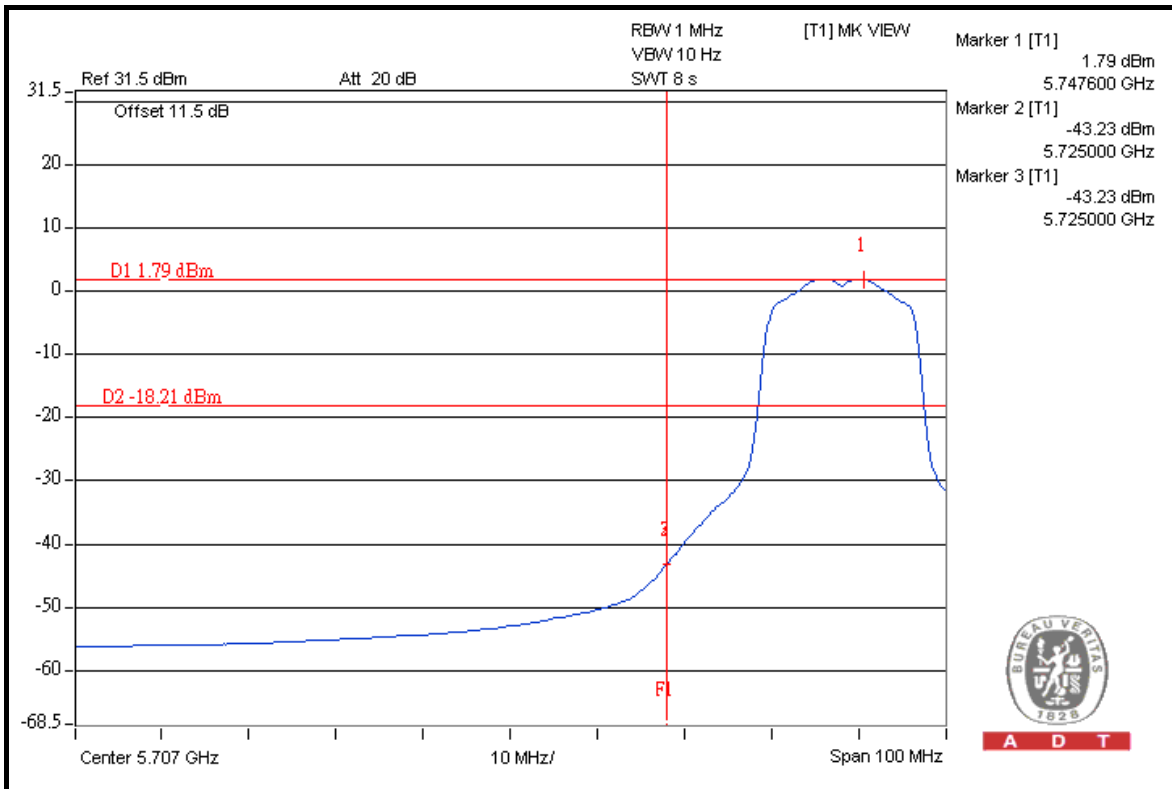

A D T



A D T

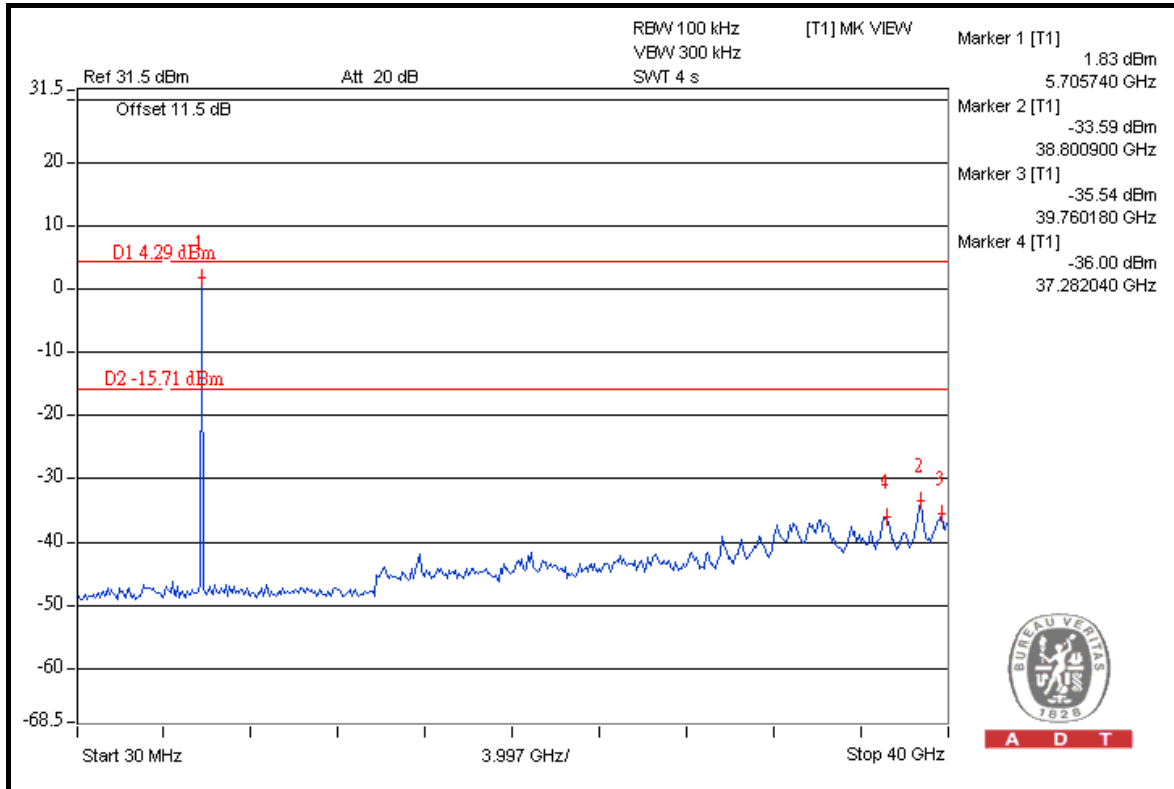

A D T

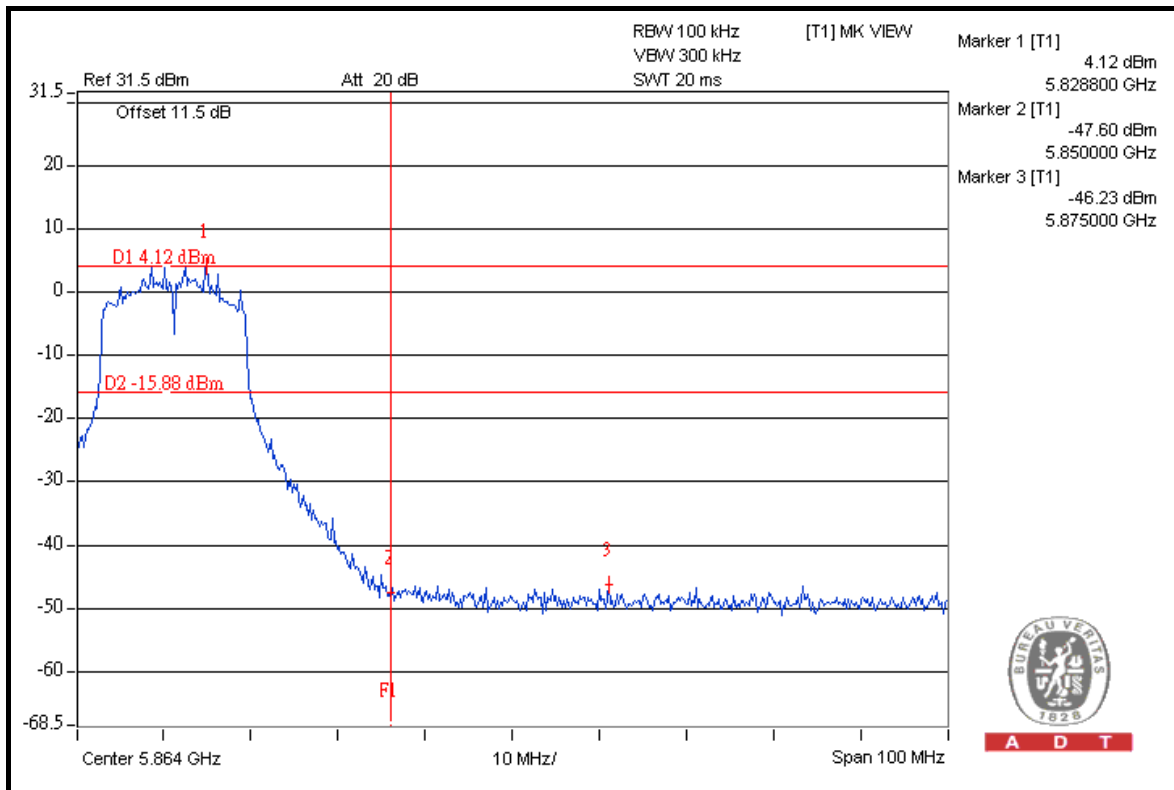

A D T



A D T

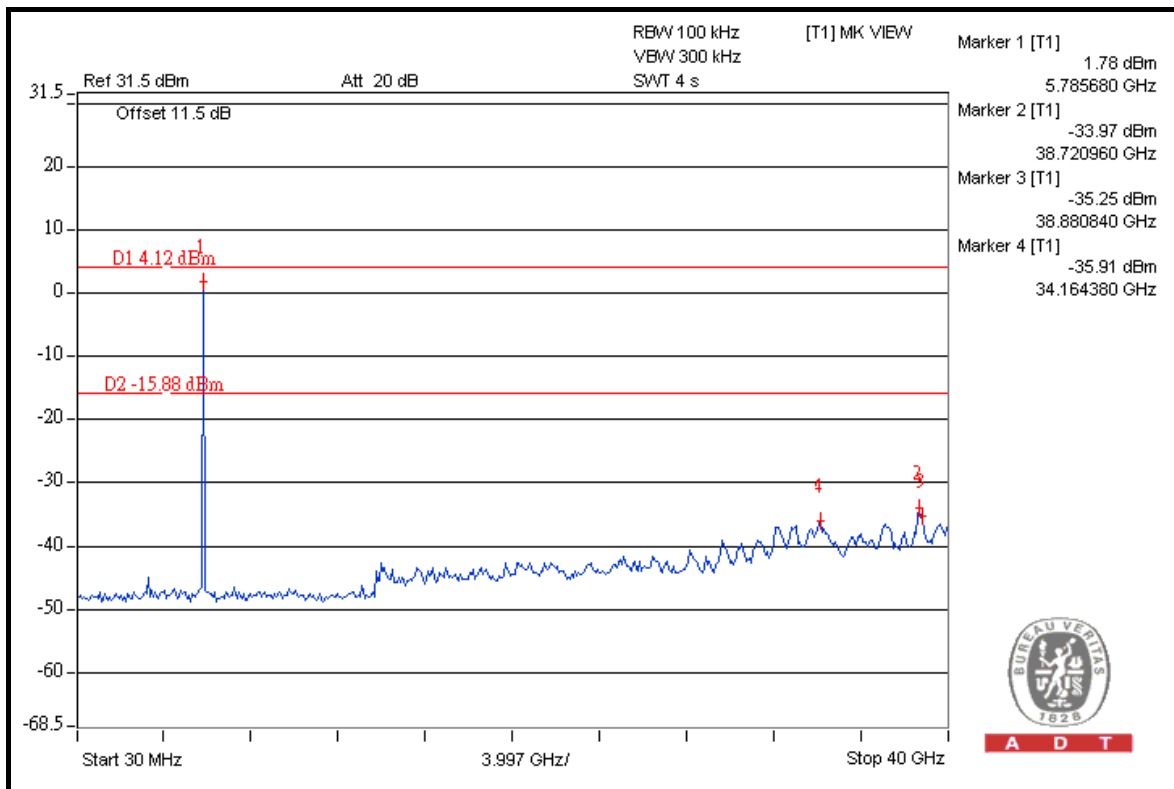
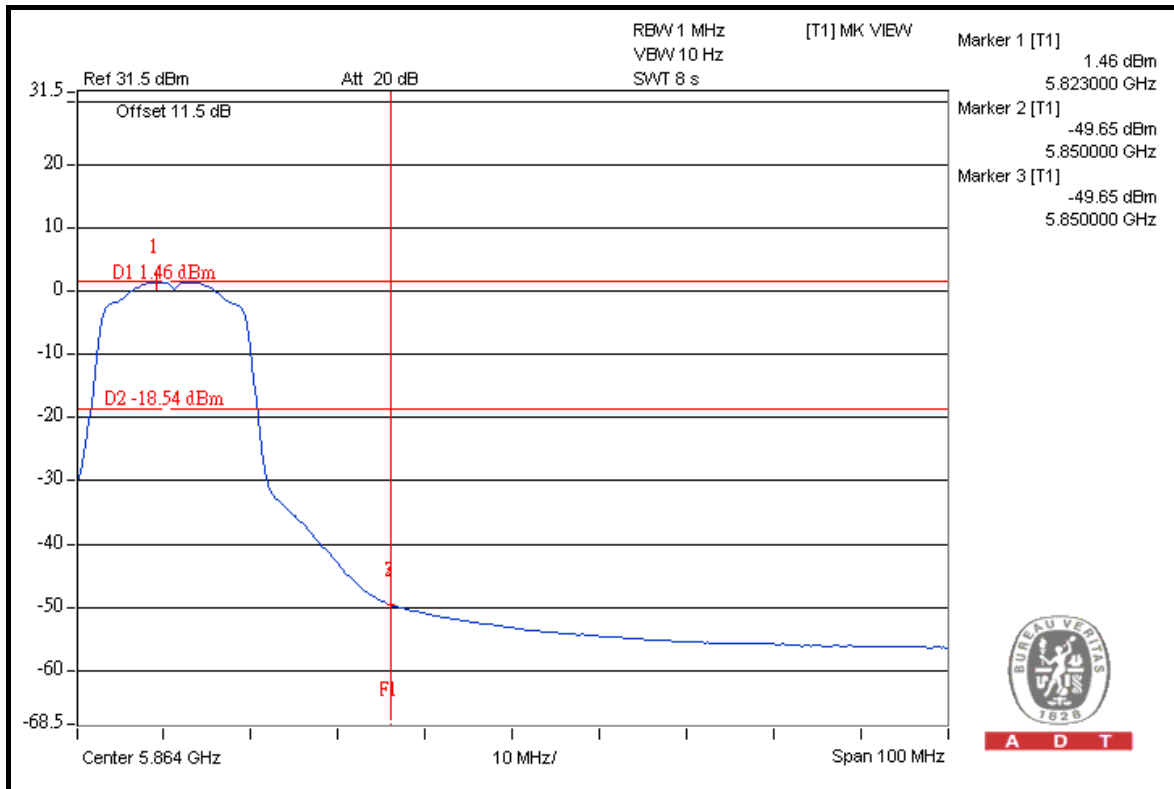



A D T

### 802.11n (20MHz)

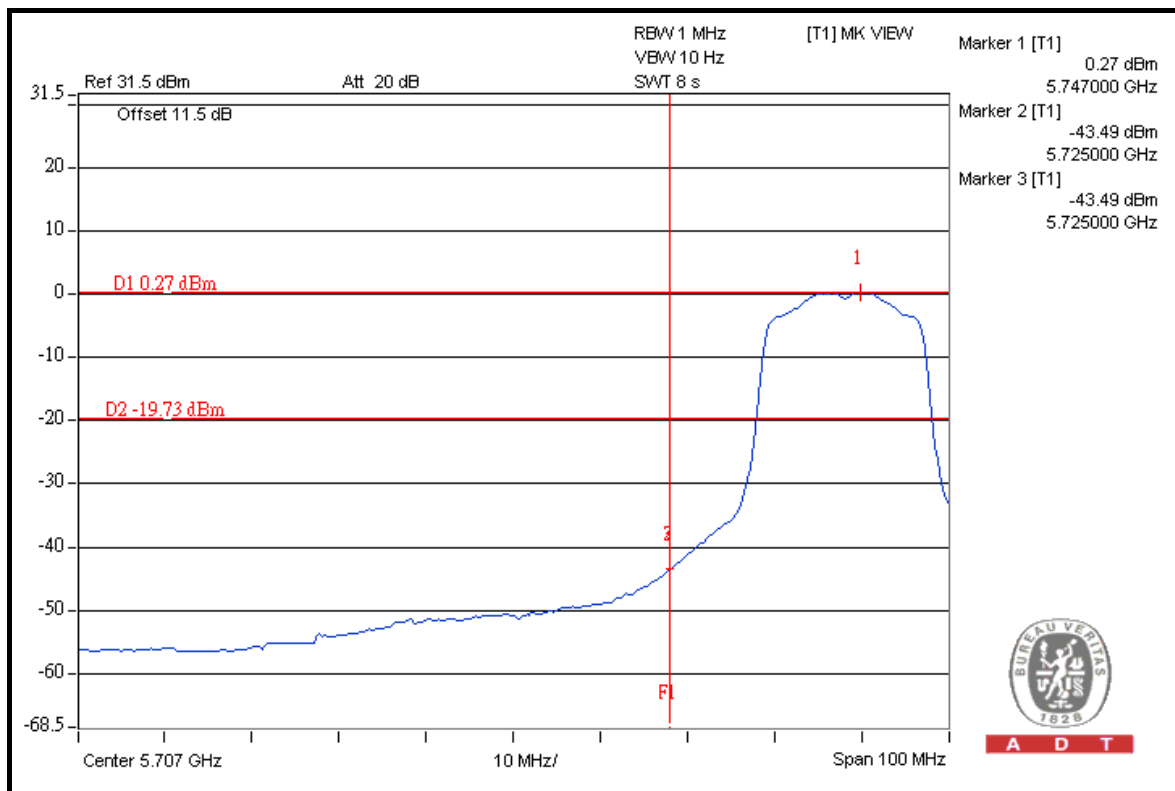
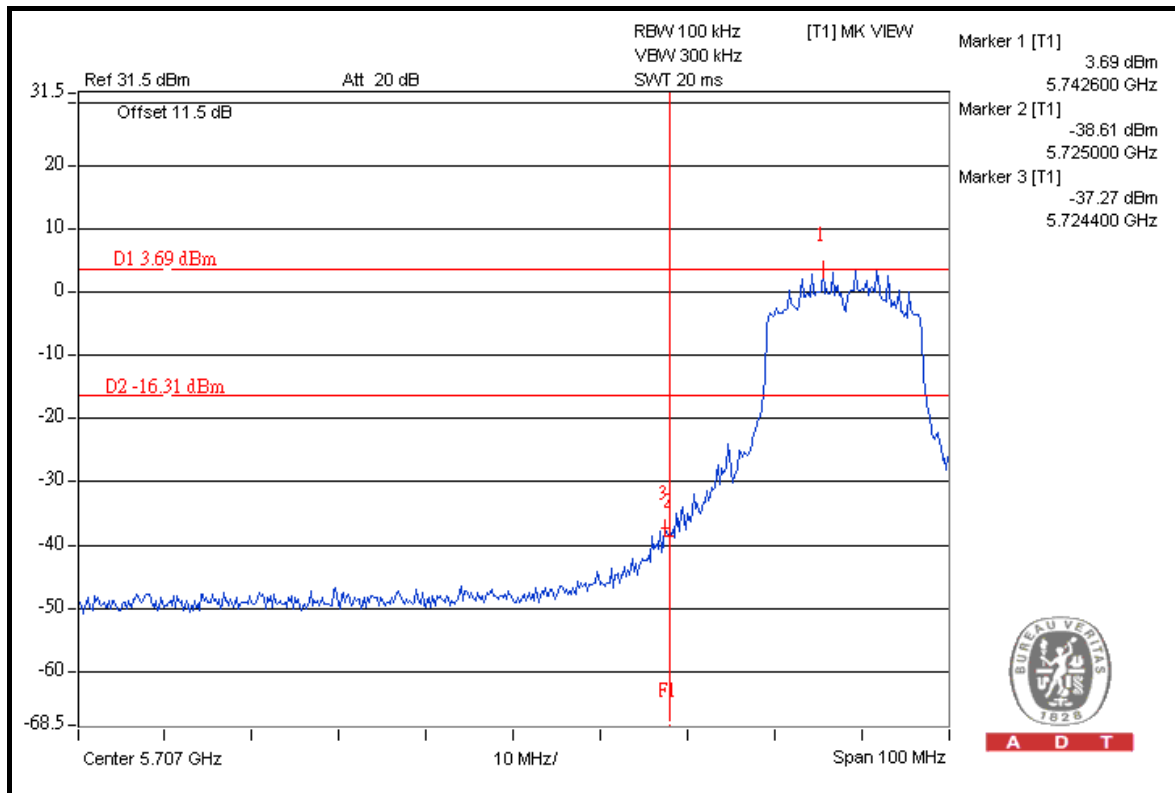



A D T

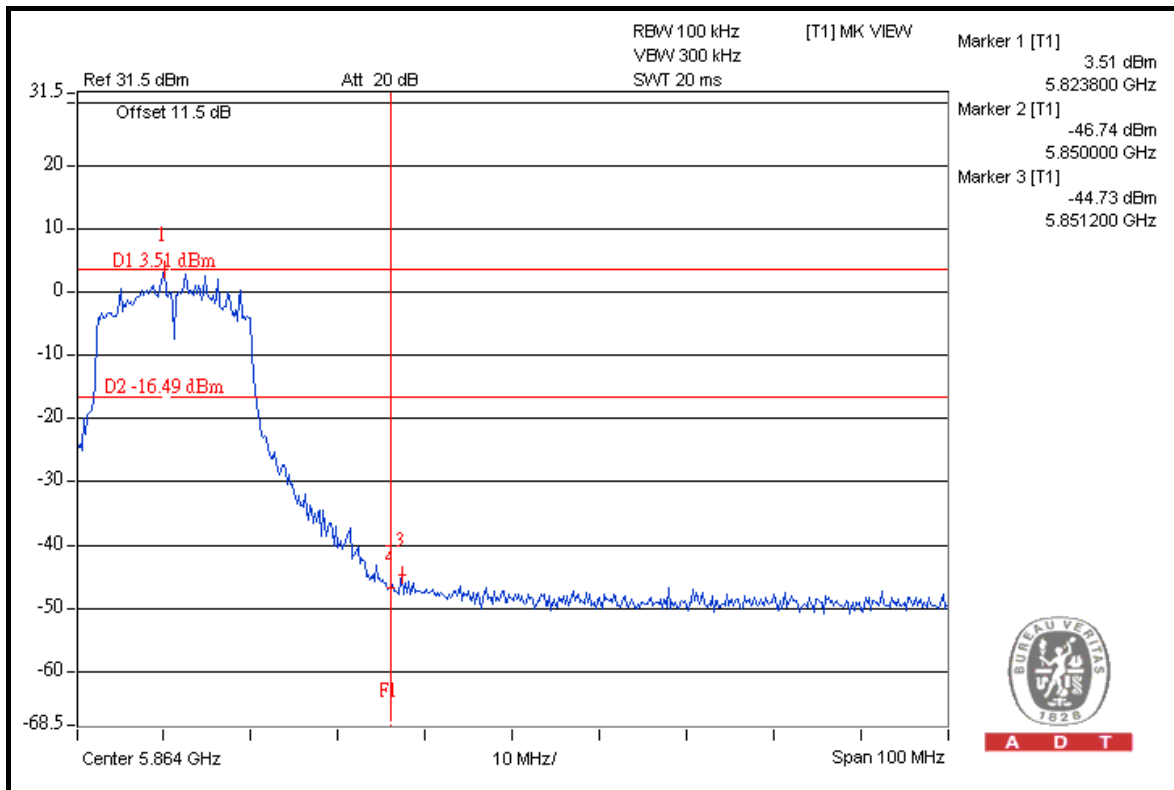
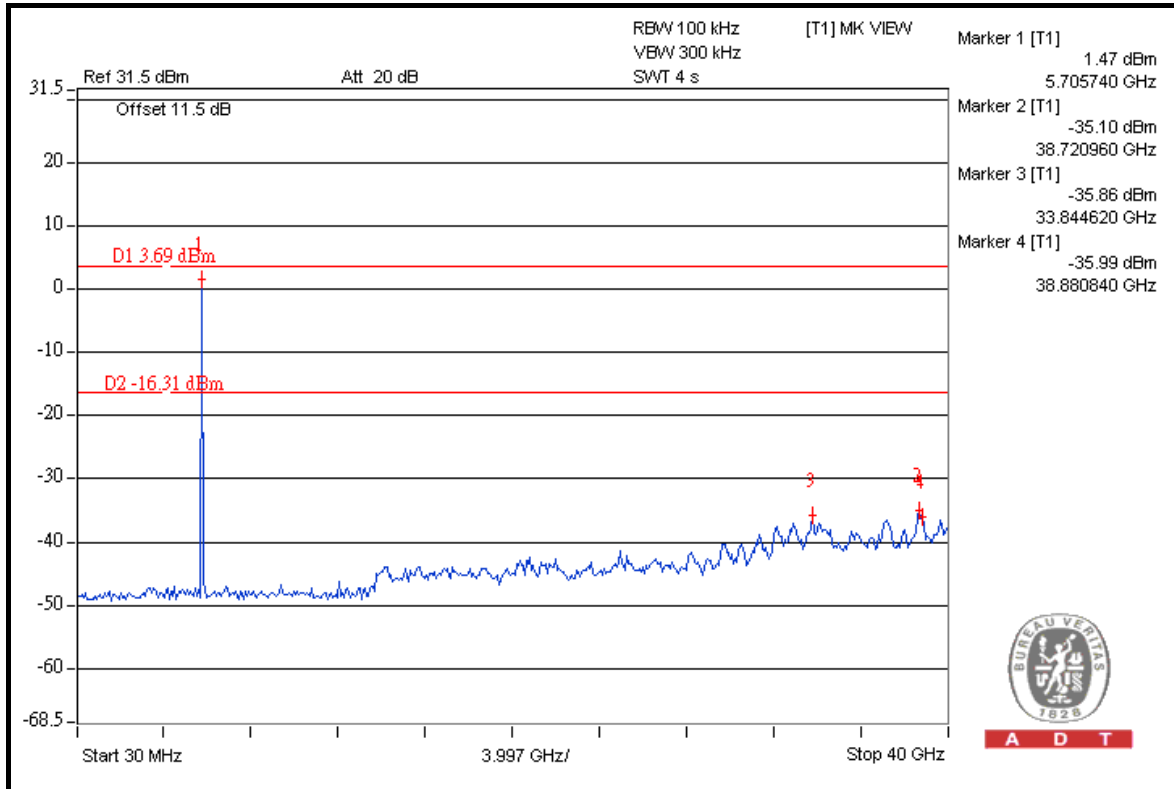



A D T

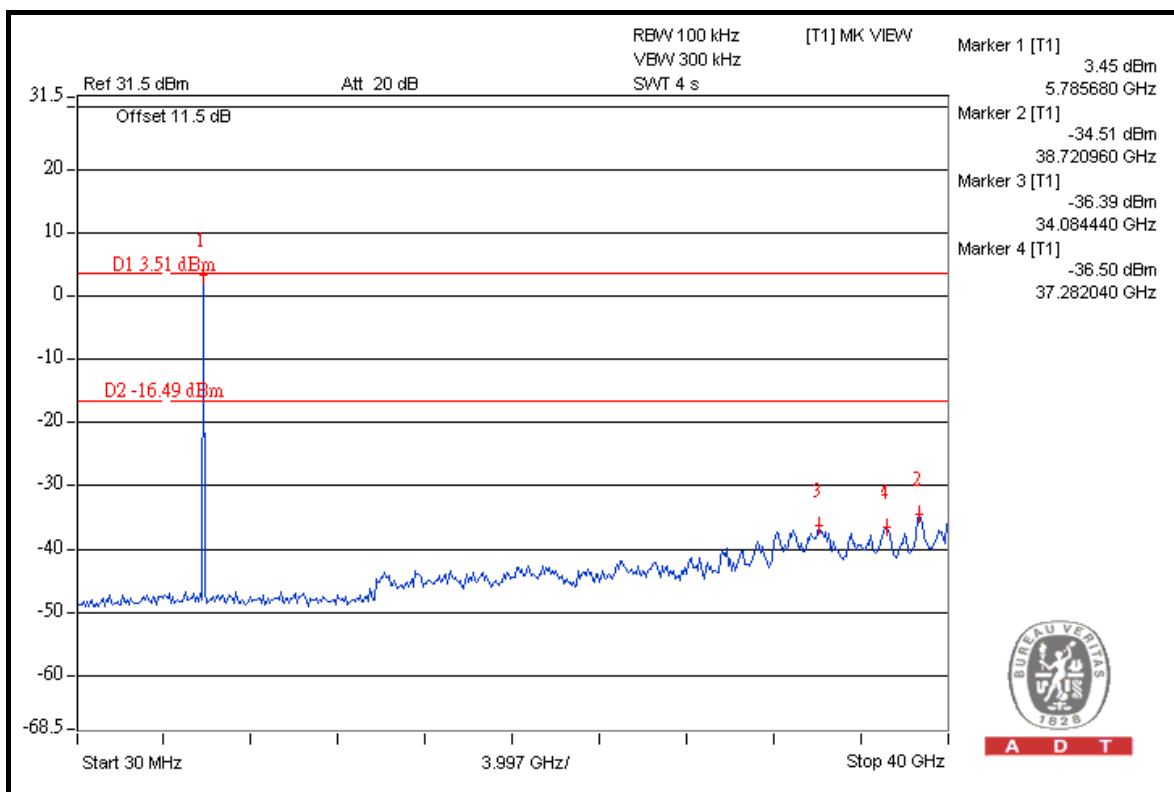
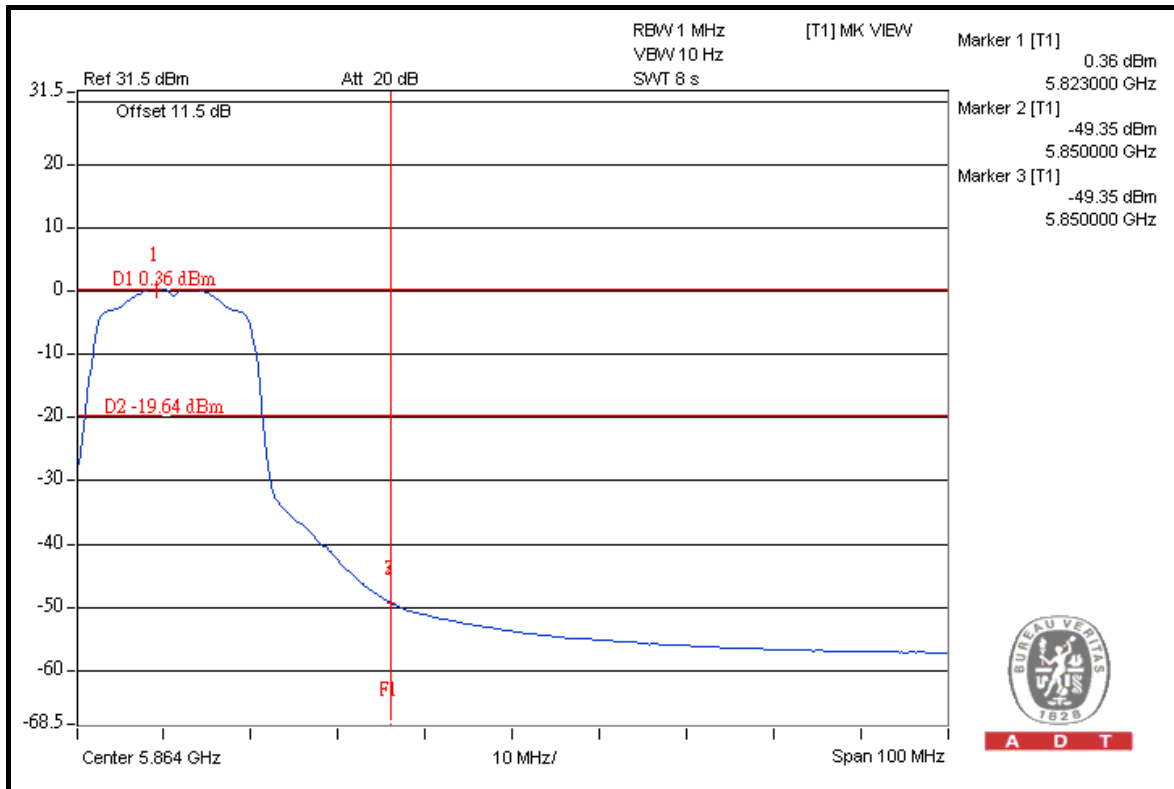



A D T

## 6. PHOTOGRAPHS OF THE TEST CONFIGURATION

Please refer to the attached file (Test Setup Photo).





A D T

## 7. INFORMATION ON THE TESTING LABORATORIES

We, Bureau Veritas Consumer Products Services (H.K.) Ltd., Taoyuan Branch., were founded in 1988 to provide our best service in EMC, Radio, Telecom and Safety consultation. Our laboratories are accredited and approved according to ISO/IEC 17025:

Copies of accreditation certificates of our laboratories obtained from approval agencies can be downloaded from our web site:

[www.adt.com.tw/index.5.phtml](http://www.adt.com.tw/index.5.phtml). If you have any comments, please feel free to contact us at the following:

**Linko EMC/RF Lab:**

Tel: 886-2-26052180

Fax: 886-2-26051924

**Hsin Chu EMC/RF Lab:**

Tel: 886-3-5935343

Fax: 886-3-5935342

**Hwa Ya EMC/RF/Safety/TPCI Lab:**

Tel: 886-3-3183232

Fax: 886-3-3185050

**Web Site:** [www.adt.com.tw](http://www.adt.com.tw)

The address and road map of all our labs can be found in our web site also.



A D T

## **8. APPENDIX A - MODIFICATIONS RECORDERS FOR ENGINEERING CHANGES TO THE EUT BY THE LAB**

No any modifications are made to the EUT by the lab during the test.

**---END---**