



A D T

# SAR TEST REPORT

**REPORT NO.:** SA110111C23-1

**MODEL NO.:** RDJ21WW

**FCC ID:** L6ARDJ20WW

**IC ID:** 2503A-RDJ20WW

**RECEIVED:** Jan. 12, 2011

**TESTED:** Feb. 10 ~ Feb. 11, 2011

**ISSUED:** Feb. 16, 2011

**APPLICANT:** Research In Motion Limited

**ADDRESS:** 295 Phillip Street, Waterloo, Ontario, Canada

**ISSUED BY:** Bureau Veritas Consumer Products Services  
(H.K.) Ltd., Taoyuan Branch

**LAB ADDRESS:** No. 47, 14th Ling, Chia Pau Tsuen, Lin Kou  
Hsiang, Taipei Hsien 244, Taiwan, R.O.C.

**TEST LOCATION:** No. 19, Hwa Ya 2nd Rd, Wen Hwa Tsuen, Kwei  
Shan Hsiang, Taoyuan Hsien 333, Taiwan, R.O.C.

This test report consists of 30 pages in total except Appendix. It may be duplicated completely for legal use with the approval of the applicant. It should not be reproduced except in full, without the written approval of our laboratory. The client should not use it to claim product, certification, approval or endorsement by TAF or any government agency. The test results in the report only apply to the tested sample.





## TABLE OF CONTENTS

RELEASE CONTROL RECORD.....	3
1. CERTIFICATION .....	4
2. GENERAL INFORMATION .....	5
2.1 GENERAL DESCRIPTION OF EUT.....	5
2.2 GENERAL DESCRIPTION OF APPLIED STANDARDS.....	7
2.3 GENERAL INFORMATION OF THE SAR SYSTEM .....	8
2.4 TEST EQUIPMENT .....	11
2.5 GENERAL DESCRIPTION OF THE SPATIAL PEAK SAR EVALUATION .....	12
2.6 DESCRIPTION OF SUPPORT UNITS.....	15
3. DESCRIPTION OF ANTENNA LOCATION .....	16
4. RECIPES FOR TISSUE SIMULATING LIQUIDS.....	17
5. SYSTEM VALIDATION.....	21
5.1. TEST PROCEDURE .....	21
5.2. VALIDATION RESULTS .....	22
5.3. SYSTEM VALIDATION UNCERTAINTIES .....	23
6. TEST RESULTS .....	24
6.1 TEST PROCEDURES.....	24
6.2 CONDUCTED POWER.....	26
6.3 DESCRIPTION OF TEST CONDITION.....	26
6.4 MEASURED SAR RESULT.....	27
6.5 NO SIMULTANEOUS SAR JUSTIFICATION .....	28
6.6 SAR LIMITS .....	29
7. INFORMATION ON THE TESTING LABORATORIES.....	30
APPENDIX A: TEST CONFIGURATIONS AND TEST DATA	
APPENDIX B: ADT SAR MEASUREMENT SYSTEM	
APPENDIX C: PHOTOGRAPHS OF SYSTEM VALIDATION	
APPENDIX D: SYSTEM CERTIFICATE & CALIBRATION	



A D T

## RELEASE CONTROL RECORD

ISSUE NO.	REASON FOR CHANGE	DATE ISSUED
Original release	N/A	Feb. 16, 2011



A D T

## 1. CERTIFICATION

**PRODUCT:** Tablet Device

**MODEL:** RDJ21WW

**BRAND:** RIM

**APPLICANT:** Research In Motion Limited

**TESTED:** Feb. 09 ~ Feb. 11, 2011

**TEST SAMPLE:** ENGINEERING SAMPLE

**STANDARDS:** FCC Part 2 (Section 2.1093)

FCC OET Bulletin 65, Supplement C (01-01)

RSS-102 Issue 4 (March 2010)

The above equipment (Model: RDJ21WW) has been tested by **Bureau Veritas Consumer Products Services (H.K.) Ltd., Taoyuan Branch**, and found compliance with the requirement of the above standards. The test record, data evaluation & Equipment Under Test (EUT) configurations represented herein are true and accurate accounts of the measurements of the sample's EMC characteristics under the conditions specified in this report.

PREPARED BY :  , DATE : Feb. 16, 2011  
Joanna Wang / Senior Specialist

APPROVED BY :  , DATE : Feb. 16, 2011  
Gary Chang / Assistant Manager



## 2. GENERAL INFORMATION

### 2.1 GENERAL DESCRIPTION OF EUT

<b>EUT</b>	Tablet Device
<b>MODEL NO.</b>	RDJ21WW
<b>FCC ID</b>	L6ARDJ20WW
<b>IC ID</b>	2503A-RDJ20WW
<b>POWER SUPPLY</b>	5Vdc (adapter) 3.7Vdc (battery)
<b>MODULATION TYPE</b>	64QAM, 16QAM, QPSK, BPSK
<b>MODULATION TECHNOLOGY</b>	OFDM
<b>TRANSFER RATE</b>	802.11a: 54.0/ 48.0/ 36.0/ 24.0/ 18.0/ 12.0/ 9.0/ 6.0Mbps 802.11n (20MHz): up to 72.0Mbps
<b>OPERATING FREQUENCY</b>	5180 ~ 5320MHz & 5500 ~ 5700MHz
<b>NUMBER OF CHANNEL</b>	5180 ~ 5320MHz: 8 5500 ~ 5700MHz: 11
<b>MAXIMUM SAR (1g)</b>	1.41W/kg
<b>ANTENNA TYPE</b>	PIFA antenna with -0.3dBi gain for 5180 ~ 5320MHz PIFA antenna with 0.9dBi gain for 5500 ~ 5700MHz
<b>ANTENNA CONNECTOR</b>	I-pex
<b>DATA CABLE</b>	Refer to users' manual
<b>I/O PORTS</b>	0.3m non-shielded USB cable without core 1.0m non-shielded USB cable without core 1.2m non-shielded USB cable without core 1.5m non-shielded USB cable without core
<b>ACCESSORY DEVICES</b>	Adapter, battery

#### NOTE:

1. The EUT is a Tablet Device. The test data are separated into following test reports.

	REFERENCE REPORT
WLAN 802.11b/g, 802.11n	SA110111C23
WLAN 802.11a, 802.11n (5745~5825 MHz)	
WLAN 802.11a, 802.11n (5180~5320MHz & 5500 ~5700MHz)	SA110111C23-1



2. The frequency bands used in this EUT are listed as follows:

Frequency Band (MHz)	2412~2462	5180~5320	5500~5700	5745~5825
802.11b	√	-	-	-
802.11g	√	-	-	-
802.11a	-	√	√	√
802.11n (20MHz)	√	√	√	√

3. The EUT provides one completed transmitter and one receiver.

MODULATION MODE	TX FUNCTION
802.11b	1TX
802.11g	1TX
802.11a	1TX
802.11n (20MHz)	1TX

4. The EUT was powered by the following adapters and battery:

ADAPTER 1	
BRAND	Phihong(BlackBerry)
MODEL	PSAC10R-050QT
INPUT POWER	100-240Vac, 50-60Hz, 0.3A
OUTPUT POWER	5Vdc, 2A
POWER LINE	DC: 2m non-shielded cable without core

ADAPTER 2	
BRAND	Tamura(BlackBerry)
MODEL	RQT050180
INPUT POWER	100-240Vac, 50/60Hz, 0.4A
OUTPUT POWER	5Vdc, 1.8A
POWER LINE	DC: 2m non-shielded cable without core

ADAPTER 3	
BRAND	Phihong(BlackBerry)
MODEL	PSM09A-050RIM
INPUT POWER	100-240Vac, 50/60Hz, 0.3A
OUTPUT POWER	5Vdc, 1.8A
POWER LINE	DC: 2m non-shielded cable without core

ADAPTER 4	
BRAND	PI Electronics
MODEL	AD8213HF
INPUT POWER	100-240Vac, 50/60Hz, 0.3A
OUTPUT POWER	5Vdc, 1.8A
POWER LINE	DC: 2m non-shielded cable without core

\* The above adapters had been pre-tested and adapter 1 was found and chose to be the worst case for final test.

BATTERY	
RATING	3.7Vdc, 5400mAH

5. The above EUT information is declared by manufacturer and for more detailed features description, please refer to the manufacturer's specifications or user's manual.

## **2.2 GENERAL DESCRIPTION OF APPLIED STANDARDS**

According to the specifications of the manufacturer, this product must comply with the requirements of the following standards:

**FCC Part 2 (2.1093)**

**FCC OET Bulletin 65, Supplement C (01- 01)**

**RSS-102 Issue 4 (March 2010)**

**IEEE 1528-2003**

All test items have been performed and recorded as per the above standards.



## 2.3 GENERAL INFORMATION OF THE SAR SYSTEM

DASY52 (Version 52.6) consists of high precision robot, probe alignment sensor, phantom, robot controller, controlled measurement server and near-field probe. The robot includes six axes that can move to the precision position of the DASY52 software defined. The DASY52 software can define the area that is detected by the probe. The robot is connected to controlled box. Controlled measurement server is connected to the controlled robot box. The DAE includes amplifier, signal multiplexing, AD converter, offset measurement and surface detection. It is connected to the Electro-optical coupler (ECO). The ECO performs the conversion from the optical into digital electric signal of the DAE and transfers data to the PC.

### EX3DV4 ISOTROPIC E-FIELD PROBE

<b>CONSTRUCTION</b>	Symmetrical design with triangular core Built-in shielding against static charges PEEK enclosure material (resistant to organic solvents, e.g., DGBE)
<b>FREQUENCY</b>	10 MHz to > 6 GHz Linearity: $\pm 0.2$ dB (30 MHz to 6 GHz)
<b>DIRECTIVITY</b>	$\pm 0.3$ dB in HSL (rotation around probe axis) $\pm 0.5$ dB in tissue material (rotation normal to probe axis)
<b>DYNAMIC RANGE</b>	10 $\mu$ W/g to > 100 mW/g Linearity: $\pm 0.2$ dB (noise: typically < 1 $\mu$ W/g)
<b>DIMENSIONS</b>	Overall length: 330 mm (Tip: 20 mm) Tip diameter: 2.5 mm (Body: 12 mm) Typical distance from probe tip to dipole centers: 1 mm
<b>APPLICATION</b>	High precision dosimetric measurements in any exposure scenario (e.g., very strong gradient fields). Only probe which enables compliance testing for frequencies up to 6 GHz with precision of better 30%.

#### NOTE

1. The Probe parameters have been calibrated by the SPEAG. Please reference "APPENDIX D" for the Calibration Certification Report.
2. For frequencies above 800MHz, calibration in a rectangular wave-guide is used, because wave-guide size is manageable.
3. For frequencies below 800MHz, temperature transfer calibration is used because the wave-guide size becomes relatively large.





## TWIN SAM V4.0

### CONSTRUCTION

The shell corresponds to the specifications of the Specific Anthropomorphic Mannequin (SAM) phantom defined in IEEE 1528-2003, EN 62209-1 and IEC 62209. It enables the dosimetric evaluation of left and right hand phone usage as well as body mounted usage at the flat phantom region. A cover prevents evaporation of the liquid. Reference markings on the phantom allow the complete setup of all predefined phantom positions and measurement grids by manually teaching three points with the robot.

### SHELL THICKNESS

2 ± 0.2mm

### FILLING VOLUME

Approx. 25liters

### DIMENSIONS

Height: 810mm; Length: 1000mm; Width: 500mm

## SYSTEM VALIDATION KITS:

### CONSTRUCTION

Symmetrical dipole with 1/4 balun enables measurement of feedpoint impedance with NWA matched for use near flat phantoms filled with brain simulating solutions. Includes distance holder and tripod adaptor

### CALIBRATION

Calibrated SAR value for specified position and input power at the flat phantom in brain simulating solutions

### FREQUENCY

5800MHz

### RETURN LOSS

> 20dB at specified validation position

### POWER CAPABILITY

> 100W (f < 1GHz); > 40W (f > 1GHz)

### OPTIONS

Dipoles for other frequencies or solutions and other calibration conditions upon request

## DEVICE HOLDER FOR SAM TWIN PHANTOM

### CONSTRUCTION

The device holder for the mobile phone device is designed to cope with different positions given in the standard. It has two scales for the device rotation (with respect to the body axis) and the device inclination (with respect to the line between the ear reference points). The rotation centers for both scales are the ear reference point (ERP). Thus the device needs no repositioning when changing the angles. The holder has been made out of low-loss POM material having the following dielectric parameters: relative permittivity  $\varepsilon = 3$  and loss tangent  $\delta = 0.02$ . The amount of dielectric material has been reduced in the closest vicinity of the device, since measurements have suggested that the influence of the clamp on the test results could thus be lowered. The device holder for the portable device makes up of the polyethylene foam. The dielectric parameters of material close to the dielectric parameters of the air.

## DATA ACQUISITION ELECTRONICS

### CONSTRUCTION

The data acquisition electronics (DAE3) consists of a highly sensitive electrometer grade preamplifier with auto-zeroing, a channel and gain-switching multiplex, a fast 16 bit AD converter and a command decoder and control logic unit. Transmission to the measurement server is accomplished through an optical downlink for data and status information as well as an optical uplink for commands and the clock. The mechanical probe is mounting device includes two different sensor systems for frontal and sideways probe contacts. They are used for mechanical surface detection and probe collision detection. The input impedance of the DAE3 box is 200M $\Omega$ ; the inputs are symmetrical and floating. Common mode rejection is above 80 dB.



A D T

## 2.4 TEST EQUIPMENT

### FOR SAR MEASUREMENT

ITEM	NAME	BRAND	TYPE	SERIES NO.	DATE OF CALIBRATION	DUE DATE OF CALIBRATION
1	ELI 4.0 Phantom	S & P	QDOVA001BA	1043	NA	NA
2	Signal Generator	Agilent	E8257C	MY43320668	Feb. 23, 2010	Feb. 22, 2011
3	E-Field Probe	S & P	EX3DV4	3590	Mar. 25, 2010	Mar. 24, 2011
4	DAE	S & P	DAE 3	510	Oct. 04, 2010	Oct. 03, 2011
5	Robot Positioner	Staubli Unimation	NA	NA	NA	NA
6	Validation Dipole	S & P	D5GHzV2	1019	Jan. 25, 2011	Jan. 24, 2012

**NOTE:** Before starting the measurement, all test equipment shall be warmed up for 30min.

### FOR TISSUE PROPERTY

ITEM	NAME	BRAND	TYPE	SERIES NO.	DATE OF CALIBRATION	DUE DATE OF CALIBRATION
1	Network Analyzer	Agilent	E5071C	MY46104190	Apr. 06, 2010	Apr. 05, 2011
2	Dielectric Probe	Agilent	85070D	US01440176	NA	NA

**NOTE:**

1. Before starting, all test equipment shall be warmed up for 30min.
2. The tolerance ( $k=1$ ) specified by Agilent for general dielectric measurements, deriving from inaccuracies in the calibration data, analyzer drift, and random errors, are usually  $\pm 2.5\%$  and  $\pm 5\%$  for measured permittivity and conductivity, respectively. However, the tolerances for the conductivity is smaller for material with large loss tangents, i.e., less than  $\pm 2.5\%$  ( $k=1$ ). It can be substantially smaller if more accurate methods are applied.



## 2.5 GENERAL DESCRIPTION OF THE SPATIAL PEAK SAR EVALUATION

The DASY52 post-processing software (SEMCAD) automatically executes the following procedures to calculate the field units from the micro-volt readings at the probe connector. The parameters used in the evaluation are stored in the configuration modules of the software:

Probe parameters:	- Sensitivity	Norm <sub>i</sub> , a <sub>i0</sub> , a <sub>i1</sub> , a <sub>i2</sub>
	- Conversion factor	ConvF <sub>i</sub>
	- Diode compression point	dcp <sub>i</sub>
Device parameters:	- Frequency	F
	- Crest factor	Cf
Media parameters:	- Conductivity	$\sigma$
	- Density	$\rho$

The first step of the evaluation is a linearization of the filtered input signal to account for the compression characteristics of the detector diode. The compensation depends on the input signal, the diode type and the DC-transmission factor from the diode to the evaluation electronics. If the exciting field is pulsed, the crest factor of the signal must be known to correctly compensate for peak power. The formula for each channel can be given as:

$$V_i = U_i + U_i^2 \cdot \frac{cf}{dcp_i}$$

V <sub>i</sub>	=compensated signal of channel i	(i = x, y, z)
U <sub>i</sub>	=input signal of channel i	(i = x, y, z)
Cf	=crest factor of exciting field	(DASY parameter)
dcp <sub>i</sub>	=diode compression point	(DASY parameter)

From the compensated input signals the primary field data for each channel can be evaluated:

$$\text{E-field probes: } E_i = \sqrt{\frac{V_i}{\text{Norm}_i \cdot \text{ConvF}}}$$

$$\text{H-field probes: } H_i = \sqrt{V_i} \cdot \frac{a_{i0} + a_{i1}f + a_{i2}f^2}{f}$$

- $V_i$  = compensated signal of channel I (i = x, y, z)
- $\text{Norm}_i$  = sensor sensitivity of channel i  $\mu\text{V}/(\text{V/m})^2$  for E-field Probes (i = x, y, z)
- $\text{ConvF}$  = sensitivity enhancement in solution
- $a_{ij}$  = sensor sensitivity factors for H-field probes
- $F$  = carrier frequency [GHz]
- $E_i$  = electric field strength of channel i in V/m
- $H_i$  = magnetic field strength of channel i in A/m

The RSS value of the field components gives the total field strength (Hermitian magnitude):

$$E_{tot} = \sqrt{E_x^2 + E_y^2 + E_z^2}$$

The primary field data are used to calculate the derived field units.

$$SAR = E_{tot}^2 \cdot \frac{\sigma}{\rho \cdot 1'000}$$

- $SAR$  = local specific absorption rate in mW/g
- $E_{tot}$  = total field strength in V/m
- $\sigma$  = conductivity in [mho/m] or [Siemens/m]
- $\rho$  = equivalent tissue density in g/cm<sup>3</sup>



Note that the density is set to 1, to account for actual head tissue density rather than the density of the tissue simulating liquid. The entire evaluation of the spatial peak values is performed within the Post-processing engine (SEMCAD). The system always gives the maximum values for the 1g and 10g cubes. The algorithm to find the cube with highest averaged SAR is divided into the following stages:

1. The extraction of the measured data (grid and values) from the Zoom Scan
2. The calculation of the SAR value at every measurement point based on all stored data (A/D values and measurement parameters)
3. The generation of a high-resolution mesh within the measured volume
4. The interpolation of all measured values from the measurement grid to the high-resolution grid
5. The extrapolation of the entire 3-D field distribution to the phantom surface over the distance from sensor to surface
6. The calculation of the averaged SAR within masses of 1g and 10g.

The probe is calibrated at the center of the dipole sensors that is located 1 to 2.7mm away from the probe tip. During measurements, the probe stops shortly above the phantom surface, depending on the probe and the surface detecting system. Both distances are included as parameters in the probe configuration file. The software always knows exactly how far away the measured point is from the surface. As the probe cannot directly measure at the surface, the values between the deepest measured point and the surface must be extrapolated. The angle between the probe axis and the surface normal line is less than 30 degree.



The maximum search is automatically performed after each area scan measurement. It is based on splines in two or three dimensions. The procedure can find the maximum for most SAR distributions even with relatively large grid spacing. After the area scanning measurement, the probe is automatically moved to a position at the interpolated maximum. The following scan can directly use this position for reference, e.g., for a finer resolution grid or the cube evaluations. The 1g and 10g peak evaluations are only available for the predefined cube 7 x 7 x 7 scans. The routines are verified and optimized for the grid dimensions used in these cube measurements. The measured volume of 30 x 30 x 30mm contains about 30g of tissue. The first procedure is an extrapolation (incl. boundary correction) to get the points between the lowest measured plane and the surface. The next step uses 3D interpolation to get all points within the measured volume in a 1mm grid (42875 points). In the last step, a 1g cube is placed numerically into the volume and its averaged SAR is calculated. This cube is then moved around until the highest averaged SAR is found. If the highest SAR is found at the edge of the measured volume, the system will issue a warning: higher SAR values might be found outside of the measured volume. In that case the cube measurement can be repeated, using the new interpolated maximum as the center.

## 2.6 DESCRIPTION OF SUPPORT UNITS

The EUT has been tested as an independent unit.

### 3. DESCRIPTION OF ANTENNA LOCATION

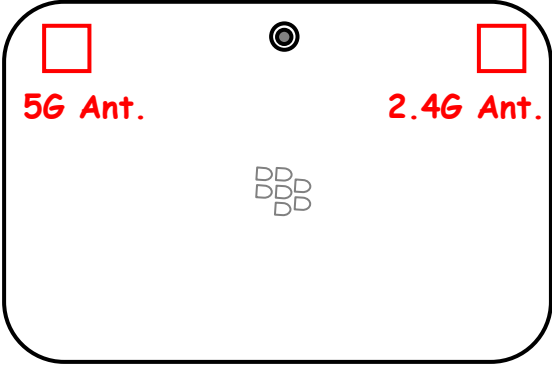



## 4. RECIPES FOR TISSUE SIMULATING LIQUIDS

For the measurement of the field distribution inside the SAM phantom, the phantom must be filled with 25 liters of tissue simulation liquid.

The following ingredients are used :

- **WATER-** Deionized water (pure H<sub>2</sub>O), resistivity  $\geq 16$  M - as basis for the liquid
- **DGMBE-** Diethylenglycol-monobuthyl ether (DGMBE), Fluka Chemie GmbH, CAS # 112-34-5 - to reduce relative permittivity

### THE INFORMATION FOR 5GHz SIMULATING LIQUID

**The 5GHz liquids was purchased from SPEAG.**

**Body liquid model:** HSL 5800, P/N: SL AAH 5800 AA

**Head liquid model:** M 5800, P/N: SL AAM 580 AD

**5GHz liquids contain the following ingredients:**

Water 64 - 78%

Mineral Oil 11 - 18%

Emulsifiers 9 - 15%

Additives and Salt 2 - 3%

Testing the liquids using the Agilent Network Analyzer E5071C and Agilent Dielectric Probe Kit 85070D. The testing procedure is following as

1. Turn Network Analyzer on and allow at least 30min. warm up.
2. Mount dielectric probe kit so that interconnecting cable to Network Analyzer will not be moved during measurements or calibration.
3. Pour de-ionized water and measure water temperature ( $\pm 1^\circ$ ).
4. Set water temperature in Agilent-Software (Calibration Setup).
5. Perform calibration.
6. Validate calibration with dielectric material of known properties (e.g. polished ceramic slab with  $>8\text{mm}$  thickness  $\epsilon' = 10.0$ ,  $\epsilon'' = 0.0$ ). If measured parameters do not fit within tolerance, repeat calibration ( $\pm 0.2$  for  $\epsilon'$ :  $\pm 0.1$  for  $\epsilon''$ ).
7. Conductivity can be calculated from  $\epsilon''$  by  $\sigma = \omega \epsilon_0 \epsilon'' = \epsilon'' f [\text{GHz}] / 18$ .
8. Measure liquid shortly after calibration. Repeat calibration every hour.
9. Stir the liquid to be measured. Take a sample ( $\sim 50\text{ml}$ ) with a syringe from the center of the liquid container.
10. Pour the liquid into a small glass flask. Hold the syringe at the bottom of the flask to avoid air bubbles.
11. Put the dielectric probe in the glass flask. Check that there are no air bubbles in front of the opening in the dielectric probe kit.
12. Perform measurements.
13. Adjust medium parameters in DASY52 for the frequencies necessary for the measurements ('Setup Config', select medium (e.g. Brain 900MHz) and press 'Option'-button.
14. Select the current medium for the frequency of the validation (e.g. Setup Medium Brain 900MHz).



A D T

**FOR 5GHz BAND SIMULATING LIQUID**

<b>LIQUID TYPE</b>		MSL-5800			
<b>SIMULATING LIQUID TEMP.</b>		22.1			
<b>TEST DATE</b>		Feb. 10, 2011			
<b>TESTED BY</b>		Morrison Huang			
<b>FREQ. (MHz)</b>	<b>LIQUID PARAMETER</b>	<b>STANDARD VALUE</b>	<b>MEASUREMENT VALUE</b>	<b>ERROR PERCENTAGE (%)</b>	<b>LIMIT(%)</b>
5200	Permittivity ( $\epsilon$ )	49.01	50.16	2.35	±5
5300		48.88	49.96	2.21	
5500		48.61	49.76	2.37	
5520		48.58	49.46	1.81	
5580		48.50	49.36	1.77	
5620		48.44	49.26	1.69	
5680		48.36	49.16	1.65	
5745		48.27	49.06	1.64	
5785		48.22	48.96	1.53	
5800		48.20	48.92	1.49	
5825		48.17	48.87	1.45	
5200	Conductivity ( $\sigma$ ) S/m	5.30	5.21	-1.70	
5300		5.42	5.36	-1.11	
5500		5.65	5.68	0.53	
5520		5.67	5.69	0.35	
5580		5.74	5.76	0.35	
5620		5.79	5.83	0.69	
5680		5.86	5.91	0.85	
5745		5.94	6.01	1.18	
5785		5.98	6.07	1.51	
5800		6.00	6.10	1.67	
5825		6.03	6.13	1.66	



A D T

LIQUID TYPE		MSL-5800			
SIMULATING LIQUID TEMP.		21.8			
TEST DATE		Feb. 11, 2011			
TESTED BY		Morrison Huang			
FREQ. (MHz)	LIQUID PARAMETER	STANDARD VALUE	MEASUREMENT VALUE	ERROR PERCENTAGE (%)	LIMIT(%)
5200	Permittivity ( $\epsilon$ )	49.01	50.03	2.08	±5
5300		48.88	49.83	1.94	
5500		48.61	49.63	2.10	
5520		48.58	49.33	1.54	
5580		48.50	49.23	1.51	
5620		48.44	49.13	1.42	
5680		48.36	49.03	1.39	
5745		48.27	48.93	1.37	
5785		48.22	48.83	1.27	
5800		48.20	48.78	1.20	
5825		48.17	48.72	1.14	
5200	Conductivity ( $\sigma$ ) S/m	5.30	5.23	-1.32	
5300		5.42	5.38	-0.74	
5500		5.65	5.70	0.88	
5520		5.67	5.71	0.71	
5580		5.74	5.78	0.70	
5620		5.79	5.85	1.04	
5680		5.86	5.93	1.19	
5745		5.94	6.03	1.52	
5785		5.98	6.09	1.84	
5800		6.00	6.12	2.00	
5825		6.03	6.15	1.99	



## 5. SYSTEM VALIDATION

The system validation was performed in the flat phantom with equipment listed in the following table. Since the SAR value is calculated from the measured electric field, dielectric constant and conductivity of the body tissue and the SAR is proportional to the square of the electric field. So, the SAR value will be also proportional to the RF power input to the system validation dipole under the same test environment. In our system validation test, 250mW RF input power was used.

### 5.1. TEST PROCEDURE

Before the system performance check, we need only to tell the system which components (probe, medium, and device) are used for the system performance check; the system will take care of all parameters. The dipole must be placed beneath the flat section of the SAM Twin Phantom with the correct distance holder in place. The distance holder should touch the phantom surface with a light pressure at the reference marking (little cross) and be oriented parallel to the long side of the phantom. Accurate positioning is not necessary, since the system will search for the peak SAR location, except that the dipole arms should be parallel to the surface. The device holder for mobile phones can be left in place but should be rotated away from the dipole.

1. The "Power Reference Measurement" and "Power Drift Measurement" jobs are located at the beginning and end of the batch process. They measure the field drift at one single point in the liquid over the complete procedure. The indicated drift is mainly the variation of the amplifier output power. If it is too high (above  $\pm 0.1$  dB), the system performance check should be repeated; some amplifiers have very high drift during warm-up. A stable amplifier gives drift results in the DASY system below  $\pm 0.02$ dB.
2. The "Surface Check" job tests the optical surface detection system of the DASY system by repeatedly detecting the surface with the optical and mechanical surface detector and comparing the results. The output gives the detecting heights of both systems, the difference between the two systems and the standard deviation of the detection repeatability. Air bubbles or refraction in the liquid due to separation of the sugar-water mixture gives poor repeatability (above  $\pm 0.1$ mm). In that case it is better to abort the system performance check and stir the liquid.

3. The "Area Scan" job measures the SAR above the dipole on a plane parallel to the surface. It is used to locate the approximate location of the peak SAR. The proposed scan uses large grid spacing for faster measurement; due to the symmetric field, the peak detection is reliable. If a finer graphic is desired, the grid spacing can be reduced. Grid spacing and orientation have no influence on the SAR result.
4. The "Zoom Scan" job measures the field in a volume around the peak SAR value assessed in the previous "Area Scan" job (for more information see the application note on SAR evaluation).

About the validation dipole positioning uncertainty, the constant and low loss dielectric spacer is used to establish the correct distance between the top surface of the dipole and the bottom surface of the phantom, the error component introduced by the uncertainty of the distance between the liquid (i.e., phantom shell) and the validation dipole in the DASY52 system is less than  $\pm 0.1$ mm.

$$SAR_{tolerance} [\%] = 100 \times \left( \frac{(a + d)^2}{a^2} - 1 \right)$$

As the closest distance is 10mm, the resulting tolerance  $SAR_{tolerance}[\%]$  is <2%.

## 5.2. VALIDATION RESULTS

SYSTEM VALIDATION TEST OF SIMULATING LIQUID					
FREQUENCY (MHz)	REQUIRED SAR (mW/g)	MEASURED SAR (mW/g)	DEVIATION (%)	SEPARATION DISTANCE	TESTED DATE
MSL 5200	7.77 (1g)	8.03	3.35	10mm	Feb. 10, 2011
MSL 5500	8.31 (1g)	8.23	-0.96	10mm	Feb. 10, 2011
MSL 5200	7.77 (1g)	8.15	4.89	10mm	Feb. 11, 2011
MSL 5500	8.31 (1g)	8.17	-1.68	10mm	Feb. 11, 2011

**NOTE:** Please see Appendix for the photo of system validation test.

### 5.3. SYSTEM VALIDATION UNCERTAINTIES

In the table below, the system validation uncertainty with respect to the analytically assessed SAR value of a dipole source as given in the IEEE 1528 standard is given. This uncertainty is smaller than the expected uncertainty for mobile phone measurements due to the simplified setup and the symmetric field distribution.

Error Description	Tolerance (±%)	Probability Distribution	Divisor	(C <sub>i</sub> )		Standard Uncertainty (±%)		(v <sub>i</sub> )
				(1g)	(10g)	(1g)	(10g)	
<b>Measurement System</b>								
Probe Calibration	6.55	Normal	1	1	1	6.55	6.55	∞
Axial Isotropy	0.25	Rectangular	√3	0.7	0.7	0.10	0.10	∞
Hemispherical Isotropy	1.30	Rectangular	√3	0.7	0.7	0.53	0.53	∞
Boundary effects	1.00	Rectangular	√3	1	1	0.58	0.58	∞
Linearity	0.30	Rectangular	√3	1	1	0.17	0.17	∞
System Detection Limits	1.00	Rectangular	√3	1	1	0.58	0.58	∞
Readout Electronics	0.30	Normal	1	1	1	0.30	0.30	∞
Response Time	0.80	Rectangular	√3	1	1	0.46	0.46	∞
Integration Time	2.60	Rectangular	√3	1	1	1.50	1.50	∞
RF Ambient Noise	3.00	Rectangular	√3	1	1	1.73	1.73	9
RF Ambient Reflections	3.00	Rectangular	√3	1	1	1.73	1.73	9
Probe Positioner	0.40	Rectangular	√3	1	1	0.23	0.23	∞
Probe Positioning	2.90	Rectangular	√3	1	1	1.67	1.67	∞
Max. SAR Eval.	1.00	Rectangular	√3	1	1	0.58	0.58	∞
<b>Test sample related</b>								
Sample positioning	1.90	Normal	1	1	1	1.90	1.90	4
Device holder uncertainty	2.80	Normal	1	1	1	2.80	2.80	4
Output power variation-SAR drift measurement	4.50	Rectangular	√3	1	1	2.60	2.60	1
<b>Dipole Related</b>								
Dipole Axis to Liquid Distance	1.60	Rectangular	√3	1	1	0.92	0.92	4
Input Power Drift	4.47	Rectangular	√3	1	1	2.58	2.58	1
<b>Phantom and Tissue parameters</b>								
Phantom Uncertainty	4.00	Rectangular	√3	1	1	2.31	2.31	∞
Liquid Conductivity (target)	5.00	Rectangular	√3	0.64	0.43	1.85	1.24	∞
Liquid Conductivity (measurement)	2.50	Normal	1	0.64	0.43	1.28	0.86	9
Liquid Permittivity (target)	5.00	Rectangular	√3	0.6	0.49	1.73	1.41	∞
Liquid Permittivity (measurement)	2.35	Normal	1	0.6	0.49	1.42	1.16	9
<b>Combined Standard Uncertainty</b>						<b>9.84</b>	<b>9.61</b>	
<b>Coverage Factor for 95%</b>						<b>Kp=2</b>		
<b>Expanded Uncertainty (K=2)</b>						<b>19.67</b>	<b>19.22</b>	

**NOTE:** About the system validation uncertainty assessment, please reference the section 7.

## 6. TEST RESULTS

### 6.1 TEST PROCEDURES

Use the software to control the EUT channel and transmission power. Then record the conducted power before the testing. Place the EUT to the specific test location. After the testing, must writing down the conducted power of the EUT into the report. The SAR value was calculated via the 3D spline interpolation algorithm that has been implemented in the software of DASY52 SAR measurement system manufactured and calibrated by SPEAG. According to the IEEE 1528 standards, the recommended procedure for assessing the peak spatial-average SAR value consists of the following steps:

- Power reference measurement
- Verification of the power reference measurement
- Area scan
- Zoom scan
- Power reference measurement

The area scan was performed for the highest spatial SAR location. The zoom scan with volume was performed for SAR value averaged over 1g and 10g spatial volumes.





In the zoom scan, the distance between the measurement point at the probe sensor location (geometric center behind the probe tip) and the phantom surface is 2mm and maintained at a constant distance of  $\pm 0.5\text{mm}$  during a zoom scan to determine peak SAR locations. The distance is 2mm between the first measurement point and the bottom surface of the phantom. The secondary measurement point to the bottom surface of the phantom is with 4.5mm separation distance. The cube size is 7 x 7 x 9 points the grid space is 4 x 4 x 2.5mm.

The measurement time is 0.5s at each point of the zoom scan. The probe boundary effect compensation shall be applied during the SAR test. Because of the tip of the probe to the Phantom surface separated distances are longer than half a tip probe diameter.

In the area scan, the separation distance is 2mm between the each measurement point and the phantom surface. The scan size shall be included the transmission portion of the EUT. The measurement time is the same as the zoom scan. At last the reference power drift shall be less than  $\pm 5\%$ .



A D T

## 6.2 CONDUCTED POWER

TEST MODE		802.11a	802.11n (20MHz)
CHAN.	FREQ. (MHz)	AVG (dBm)	AVG (dBm)
36	5180	16.2	16.1
40	5200	16.3	16.2
44	5220	16.1	16.1
48	5240	16.2	16.1
52	5260	16.7	16.4
56	5280	16.6	16.5
60	5300	16.8	16.5
64	5320	16.6	16.6
100	5500	16.6	16.5
104	5520	16.7	16.5
108	5540	16.5	16.5
112	5560	16.5	16.5
116	5580	16.9	16.5
120	5600	16.5	16.5
124	5620	16.8	16.6
128	5640	16.6	16.6
132	5660	16.6	16.4
136	5680	16.7	16.6
140	5700	16.6	16.5

## 6.3 DESCRIPTION OF TEST CONDITION

TEST DATE	TEMPERATURE(°C)		HUMIDITY(%RH)	TESTED BY
	AIRBENT	LIQUID		
Feb. 10, 2011	23.0	22.1	58	Morrison Huang
Feb. 11, 2011	22.7	21.8	60	Morrison Huang



## 6.4 MEASURED SAR RESULT

FCC accept the device to follow Interim SAR Test for UMPC Mini Mini-Tablets shown on RF Exposure Procedures Update Oct, 2010 in KDB 261713.

“A composite test separation distance of 5 mm should be applied to test all sides and edges of the device with an antenna closer than 2.5 cm from the surface or edge”.

Therefore, 5 mm is used to be the test distance.

Distance between EUT and phantom is 5mm				
802.11a				
CHAN.	FREQ. (MHz)	Top	Bottom	Right Edge
40	5200	0.087	0.392	0.330
60	5300	0.138	0.660	0.616
104	5520	0.437	1.210	1.290
116	5580	0.471	1.160	1.370
124	5620	0.484	1.130	<b>1.410</b>
136	5680	0.454	1.070	1.400
802.11n (20MHz)				
CHAN.	FREQ. (MHz)	Top	Bottom	Right Edge
40	5200	0.085	0.389	0.300
60	5300	0.130	0.664	0.631
104	5520	0.414	1.260	1.170
116	5580	0.453	1.230	1.230
124	5620	0.413	1.140	1.230
136	5680	0.430	1.070	1.100

**NOTE:**

1. In this testing, the limit for General Population Spatial Peak averaged over 1g, 1.6 W/kg, is applied.
2. Please see the Appendix A for the data.
3. The variation of the EUT conducted power measured before and after SAR testing should not over 5%.
4. Per KDB 447498, when 1-g SAR for the highest output channel is less than 0.8 W/kg, testing for the other channels is not required.

## 6.5 NO SIMULTANEOUS SAR JUSTIFICATION

The device has 2.4 / 5GHz WiFi and Bluetooth. 2.4GHz and 5GHz can not work at the same time. Below transmission simultaneous mode is supported for the device.

### 1) 2.4GHz WiFi + Bluetooth

Max SAR value at 3 test positions

Mode	Position		
	Top	Bottom	Right edge
2.4GHz WiFi	0.144	1.38	0.934
Bluetooth	0	0	0
2.4GHz WiFi +Bluetooth	0.144	0.138	0.934

\*Max SAR value of 2.4GHz is shown on Report No.: SA110111C23.

### 2) 5GHz WiFi+ Bluetooth

Max SAR value at 3 test positions

Mode	Position		
	Top	Bottom	Right edge
5GHz WiFi	0.484	1.26	1.41
Bluetooth	0	0	0
5GHz WiFi +Bluetooth	0.484	1.26	1.41

## SAR evaluation for Transmitter

### 2.4 / 5 GHz WiFi

Since the output power  $> 60/f(\text{GHz})$ , SAR is necessary.

### Bluetooth

The max output power is  $6.6 \text{ mW} < 24 \text{ mW} (2.P_{\text{Ref}})$  and antenna separation between WiFi and Bluetooth is  $> 5 \text{ cm}$ . Therefore, SAR evaluation is not necessary.

## Antenna separation distance (cm)

	2.4GHz antenna	5GHz antenna	BT antenna
2.4GHz antenna		16.537	7.41
5GHz antenna	16.537		18.48
BT antenna	7.41	18.48	

## Conclusion

- 1) Antenna separation distance for each transmission simultaneous pair is  $> 5\text{cm}$
- 2) Sum of SAR is  $< 1.6 \text{ W/ kg}$

Accordingly, simultaneous Transmission SAR is not required for this device.



## 6.6 SAR LIMITS

HUMAN EXPOSURE	SAR (W/kg)	
	(GENERAL POPULATION / UNCONTROLLED EXPOSURE ENVIRONMENT)	(OCCUPATIONAL / CONTROLLED EXPOSURE ENVIRONMENT)
Spatial Average (whole body)	0.08	0.4
Spatial Peak (averaged over 1 g)	1.6	8.0
Spatial Peak (hands / wrists / feet / ankles averaged over 10 g)	4.0	20.0

**NOTE:** This limits accord to 47 CFR 2.1093 – Safety Limit.



## 7. INFORMATION ON THE TESTING LABORATORIES

We, Bureau Veritas Consumer Products Services (H.K.) Ltd., Taoyuan Branch, were founded in 1988 to provide our best service in EMC, Radio, Telecom and Safety consultation. Our laboratories are accredited and approved according to ISO/IEC 17025.

Copies of accreditation certificates of our laboratories obtained from approval agencies can be downloaded from our web site: [www.adt.com.tw/index.5.phtml](http://www.adt.com.tw/index.5.phtml). If you have any comments, please feel free to contact us at the following:

**Linko EMC/RF Lab:**

Tel: 886-2-26052180

Fax: 886-2-26051924

**Hsin Chu EMC/RF Lab:**

Tel: 886-3-5935343

Fax: 886-3-5935342

**Hwa Ya EMC/RF/Safety/Telecom Lab:**

Tel: 886-3-3183232

Fax: 886-3-3185050

**Web Site:** [www.adt.com.tw](http://www.adt.com.tw)

The address and road map of all our labs can be found in our web site also.

---END---



香港商立德國際商品試驗有限公司桃園分公司

Bureau Veritas Consumer Products Services (H.K.) Ltd., Taoyuan Branch

**APPENDIX A: TEST DATA**

**Product Name: Wireless Handheld Devices ; Model Number: RDJ21WW**

**Liquid Level Photo**

**Tissue 5800MHz D=150mm**

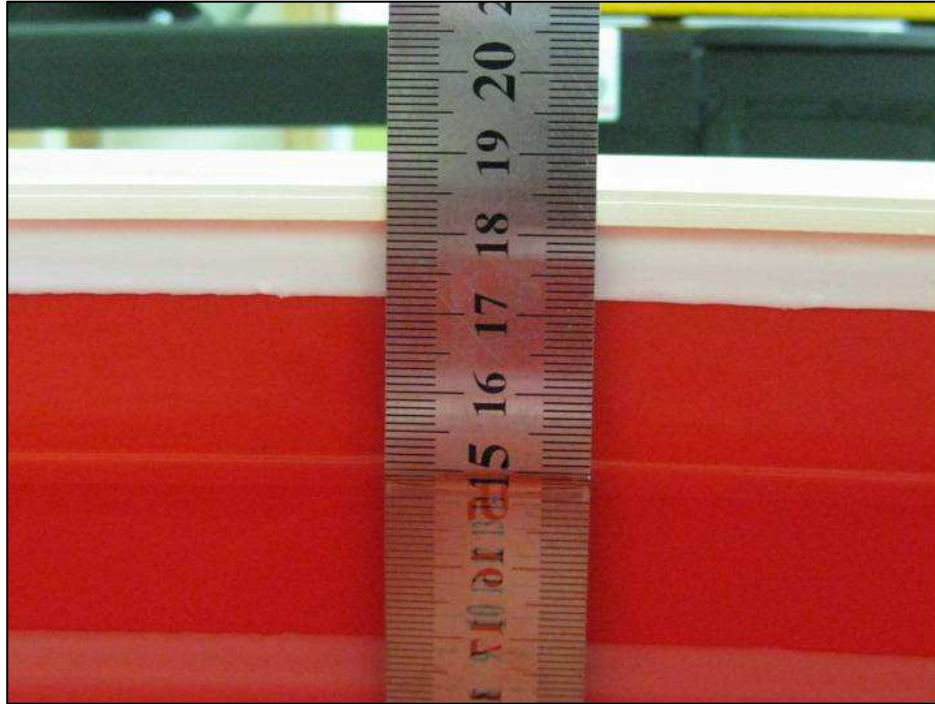

## M01-11a\_Ch40

Communication System: 802.11a ; Frequency: 5200 MHz ; Duty Cycle: 1:1 ; Modulation type: BPSK  
Medium: MSL5800 Medium parameters used:  $f = 5200$  MHz;  $\sigma = 5.21$  mho/m;  $\epsilon_r = 50.16$ ;  $\rho = 1000$  kg/m<sup>3</sup>

Phantom section: Flat Section ; Separation distance : 5 mm (The bottom side of the EUT to the Phantom)

DASY5 Configuration:

- Probe: EX3DV4 - SN3590; ConvF(4.8, 4.8, 4.8); Calibrated: 2010/3/25
- Sensor-Surface: 2mm (Mechanical Surface Detection)
- Electronics: DAE3 Sn510; Calibrated: 2010/10/4
- Phantom: ELI 4.0; Type: QDOVA001BA;Serial: 1043
- Measurement SW: DASY52, Version 52.6 (1); SEMCAD X Version 14.4.2 (2595)

**Flat-Section MSL/Flat Section 5mm /Area Scan (9x11x1):** Measurement grid: dx=10mm, dy=10mm

Maximum value of SAR (measured) = 0.611 mW/g

**Flat-Section MSL/Flat Section 5mm /Zoom Scan (7x7x9)/Cube 0:** Measurement grid: dx=4mm, dy=4mm, dz=2.5mm

Reference Value = 3.228 V/m; Power Drift = 0.10 dB

Peak SAR (extrapolated) = 1.216 W/kg

**SAR(1 g) = 0.392 mW/g; SAR(10 g) = 0.181 mW/g**

Maximum value of SAR (measured) = 0.685 mW/g

**Flat-Section MSL/Flat Section 5mm /Zoom Scan (7x7x9)/Cube 1:** Measurement grid: dx=4mm, dy=4mm, dz=2.5mm

Reference Value = 3.228 V/m; Power Drift = 0.10 dB

Peak SAR (extrapolated) = 0.762 W/kg

Peak SAR (extrapolated) = 0.762 W/kg

**SAR(1 g) = 0.294 mW/g; SAR(10 g) = 0.162 mW/g**

Maximum value of SAR (measured) = 0.462 mW/g

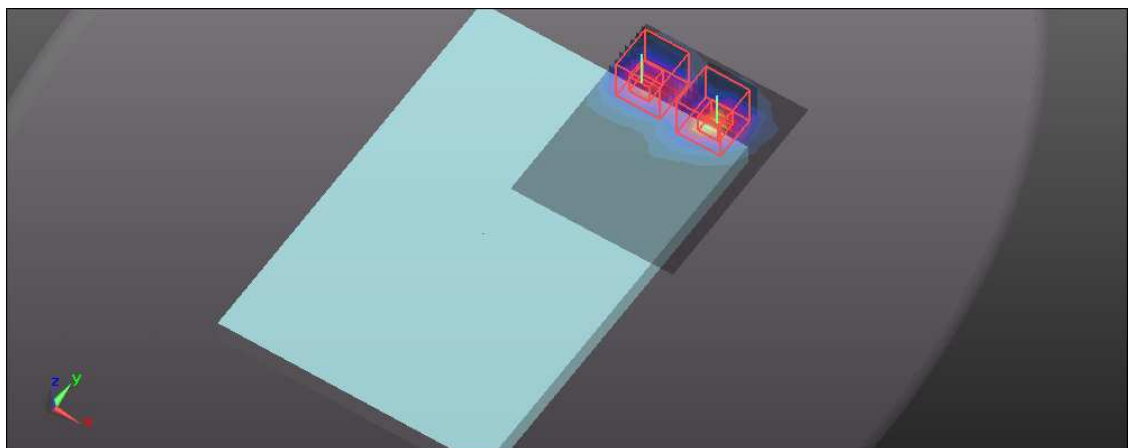
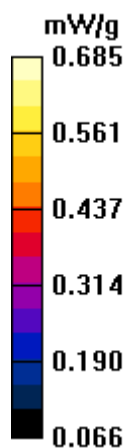



## M02-11a\_Ch60

Communication System: 802.11a ; Frequency: 5300 MHz ; Duty Cycle: 1:1 ; Modulation type: BPSK  
Medium: MSL5800 Medium parameters used:  $f = 5300$  MHz;  $\sigma = 5.36$  mho/m;  $\epsilon_r = 49.96$ ;  $\rho = 1000$  kg/m<sup>3</sup>

Phantom section: Flat Section ; Separation distance : 5 mm (The bottom side of the EUT to the Phantom)

DASY5 Configuration:

- Probe: EX3DV4 - SN3590; ConvF(4.5, 4.5, 4.5); Calibrated: 2010/3/25
- Sensor-Surface: 2mm (Mechanical Surface Detection)
- Electronics: DAE3 Sn510; Calibrated: 2010/10/4
- Phantom: ELI 4.0; Type: QDOVA001BA;Serial: 1043
- Measurement SW: DASY52, Version 52.6 (1); SEMCAD X Version 14.4.2 (2595)

**Flat-Section MSL/Flat Section 5mm /Area Scan (9x11x1):** Measurement grid: dx=10mm, dy=10mm

Maximum value of SAR (measured) = 1.134 mW/g

**Flat-Section MSL/Flat Section 5mm /Zoom Scan (7x7x9)/Cube 0:** Measurement grid: dx=4mm, dy=4mm, dz=2.5mm

Reference Value = 3.402 V/m; Power Drift = 0.19 dB

Peak SAR (extrapolated) = 1.816 W/kg

**SAR(1 g) = 0.660 mW/g; SAR(10 g) = 0.276 mW/g**

Maximum value of SAR (measured) = 0.792 mW/g

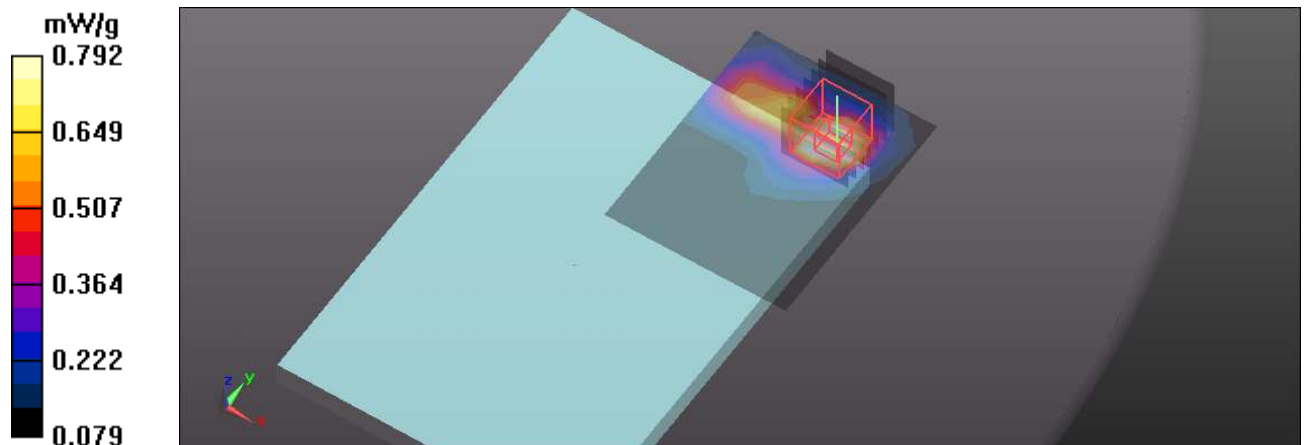

### M03-11a\_Ch104

Communication System: 802.11a ; Frequency: 5520 MHz ; Duty Cycle: 1:1 ; Modulation type: BPSK  
Medium: MSL5800 Medium parameters used:  $f = 5520$  MHz;  $\sigma = 5.69$  mho/m;  $\epsilon_r = 49.46$ ;  $\rho = 1000$  kg/m<sup>3</sup>

Phantom section: Flat Section ; Separation distance : 5 mm (The bottom side of the EUT to the Phantom)

DASY5 Configuration:

- Probe: EX3DV4 - SN3590; ConvF(4.32, 4.32, 4.32); Calibrated: 2010/3/25
- Sensor-Surface: 2mm (Mechanical Surface Detection)
- Electronics: DAE3 Sn510; Calibrated: 2010/10/4
- Phantom: ELI 4.0; Type: QDOVA001BA;Serial: 1043
- Measurement SW: DASY52, Version 52.6 (1); SEMCAD X Version 14.4.2 (2595)

**Flat-Section MSL/Flat Section 5mm /Area Scan (9x11x1):** Measurement grid: dx=10mm, dy=10mm

Maximum value of SAR (measured) = 1.800 mW/g

**Flat-Section MSL/Flat Section 5mm /Zoom Scan (7x7x9)/Cube 0:** Measurement grid: dx=4mm, dy=4mm, dz=2.5mm

Reference Value = 4.208 V/m; Power Drift = -0.18 dB

Peak SAR (extrapolated) = 4.086 W/kg

**SAR(1 g) = 1.21 mW/g; SAR(10 g) = 0.480 mW/g**

Maximum value of SAR (measured) = 2.273 mW/g

**Flat-Section MSL/Flat Section 5mm /Zoom Scan (7x7x9)/Cube 1:** Measurement grid: dx=4mm, dy=4mm, dz=2.5mm

Reference Value = 4.208 V/m; Power Drift = -0.18 dB

Peak SAR (extrapolated) = 3.080 W/kg

**SAR(1 g) = 0.860 mW/g; SAR(10 g) = 0.370 mW/g**

Maximum value of SAR (measured) = 1.598 mW/g

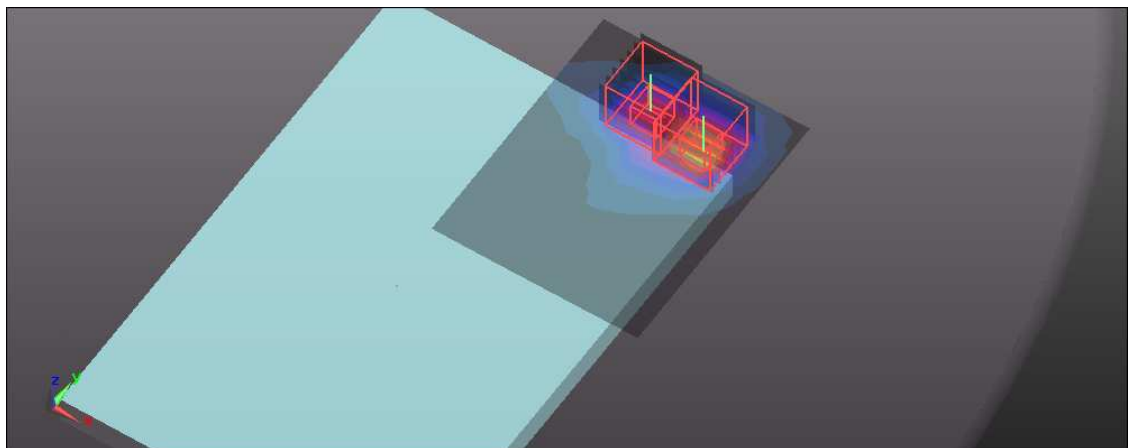
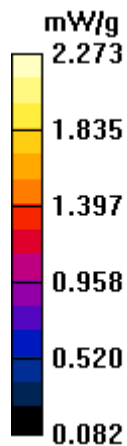



### M03-11a\_Ch116

Communication System: 802.11a ; Frequency: 5580 MHz ; Duty Cycle: 1:1 ; Modulation type: BPSK  
Medium: MSL5800 Medium parameters used:  $f = 5580 \text{ MHz}$ ;  $\sigma = 5.76 \text{ mho/m}$ ;  $\epsilon_r = 49.36$ ;  $\rho = 1000 \text{ kg/m}^3$

Phantom section: Flat Section ; Separation distance : 5 mm (The bottom side of the EUT to the Phantom)

DASY5 Configuration:

- Probe: EX3DV4 - SN3590; ConvF(4.16, 4.16, 4.16); Calibrated: 2010/3/25
- Sensor-Surface: 2mm (Mechanical Surface Detection)
- Electronics: DAE3 Sn510; Calibrated: 2010/10/4
- Phantom: ELI 4.0; Type: QDOVA001BA;Serial: 1043
- Measurement SW: DASY52, Version 52.6 (1); SEMCAD X Version 14.4.2 (2595)

**Flat-Section MSL/Flat Section 5mm /Area Scan (9x11x1):** Measurement grid:  $dx=10\text{mm}$ ,  $dy=10\text{mm}$

Maximum value of SAR (measured) = 1.718 mW/g

**Flat-Section MSL/Flat Section 5mm /Zoom Scan (7x7x9)/Cube 0:** Measurement grid:  $dx=4\text{mm}$ ,  $dy=4\text{mm}$ ,  $dz=2.5\text{mm}$

Reference Value = 4.068 V/m; Power Drift = -0.14 dB

Peak SAR (extrapolated) = 4.140 W/kg

**SAR(1 g) = 1.16 mW/g; SAR(10 g) = 0.462 mW/g**

Maximum value of SAR (measured) = 2.163 mW/g

**Flat-Section MSL/Flat Section 5mm /Zoom Scan (7x7x9)/Cube 1:** Measurement grid:  $dx=4\text{mm}$ ,  $dy=4\text{mm}$ ,  $dz=2.5\text{mm}$

Reference Value = 4.068 V/m; Power Drift = -0.14 dB

Peak SAR (extrapolated) = 3.317 W/kg

**SAR(1 g) = 0.910 mW/g; SAR(10 g) = 0.389 mW/g.**

Maximum value of SAR (measured) = 1.689 mW/g

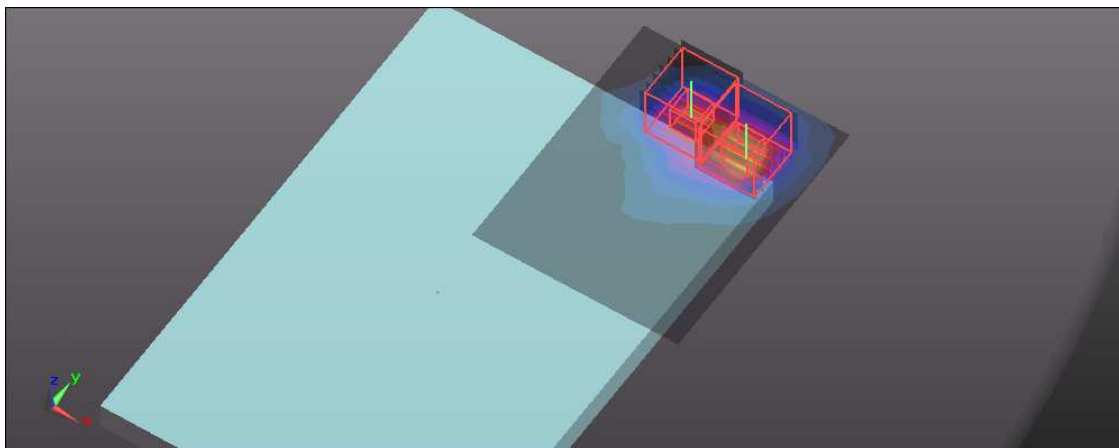
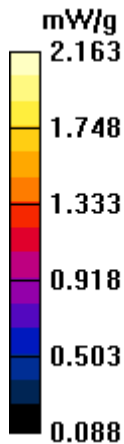



### M03-11a\_Ch124

Communication System: 802.11a ; Frequency: 5620 MHz ; Duty Cycle: 1:1 ; Modulation type: BPSK  
Medium: MSL5800 Medium parameters used:  $f = 5620 \text{ MHz}$ ;  $\sigma = 5.83 \text{ mho/m}$ ;  $\epsilon_r = 49.26$ ;  $\rho = 1000 \text{ kg/m}^3$

Phantom section: Flat Section ; Separation distance : 5 mm (The bottom side of the EUT to the Phantom)

DASY5 Configuration:

- Probe: EX3DV4 - SN3590; ConvF(4.16, 4.16, 4.16); Calibrated: 2010/3/25
- Sensor-Surface: 2mm (Mechanical Surface Detection)
- Electronics: DAE3 Sn510; Calibrated: 2010/10/4
- Phantom: ELI 4.0; Type: QDOVA001BA;Serial: 1043
- Measurement SW: DASY52, Version 52.6 (1); SEMCAD X Version 14.4.2 (2595)

**Flat-Section MSL/Flat Section 5mm /Area Scan (9x11x1):** Measurement grid:  $dx=10\text{mm}$ ,  $dy=10\text{mm}$

Maximum value of SAR (measured) = 1.631 mW/g

**Flat-Section MSL/Flat Section 5mm /Zoom Scan (7x7x9)/Cube 0:** Measurement grid:  $dx=4\text{mm}$ ,  $dy=4\text{mm}$ ,  $dz=2.5\text{mm}$

Reference Value = 3.928 V/m; Power Drift = 0.19 dB

Peak SAR (extrapolated) = 4.038 W/kg

**SAR(1 g) = 1.13 mW/g; SAR(10 g) = 0.455 mW/g**

Maximum value of SAR (measured) = 2.090 mW/g

**Flat-Section MSL/Flat Section 5mm /Zoom Scan (7x7x9)/Cube 1:** Measurement grid:  $dx=4\text{mm}$ ,  $dy=4\text{mm}$ ,  $dz=2.5\text{mm}$

Reference Value = 3.928 V/m; Power Drift = 0.19 dB

Peak SAR (extrapolated) = 3.537 W/kg

**SAR(1 g) = 0.946 mW/g; SAR(10 g) = 0.406 mW/g**

Maximum value of SAR (measured) = 1.769 mW/g

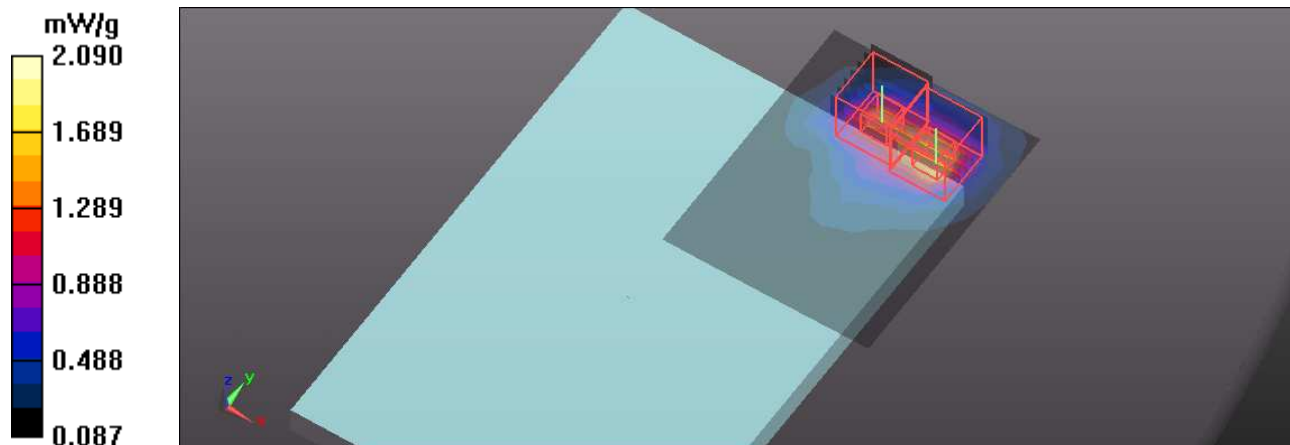



### M03-11a\_Ch136

Communication System: 802.11a ; Frequency: 5680 MHz ; Duty Cycle: 1:1 ; Modulation type: BPSK  
Medium: MSL5800 Medium parameters used:  $f = 5680 \text{ MHz}$ ;  $\sigma = 5.91 \text{ mho/m}$ ;  $\epsilon_r = 49.16$ ;  $\rho = 1000 \text{ kg/m}^3$

Phantom section: Flat Section ; Separation distance : 5 mm (The bottom side of the EUT to the Phantom)

DASY5 Configuration:

- Probe: EX3DV4 - SN3590; ConvF(4.16, 4.16, 4.16); Calibrated: 2010/3/25
- Sensor-Surface: 2mm (Mechanical Surface Detection)
- Electronics: DAE3 Sn510; Calibrated: 2010/10/4
- Phantom: ELI 4.0; Type: QDOVA001BA;Serial: 1043
- Measurement SW: DASY52, Version 52.6 (1); SEMCAD X Version 14.4.2 (2595)

**Flat-Section MSL/Flat Section 5mm /Area Scan (9x11x1):** Measurement grid:  $dx=10\text{mm}$ ,  $dy=10\text{mm}$

Maximum value of SAR (measured) = 1.548 mW/g

**Flat-Section MSL/Flat Section 5mm /Zoom Scan (7x7x9)/Cube 0:** Measurement grid:  $dx=4\text{mm}$ ,  $dy=4\text{mm}$ ,  $dz=2.5\text{mm}$

Reference Value = 3.681 V/m; Power Drift = 0.15 dB

Peak SAR (extrapolated) = 3.880 W/kg

**SAR(1 g) = 1.07 mW/g; SAR(10 g) = 0.439 mW/g**

Maximum value of SAR (measured) = 1.995 mW/g

**Flat-Section MSL/Flat Section 5mm /Zoom Scan (7x7x9)/Cube 1:** Measurement grid:  $dx=4\text{mm}$ ,  $dy=4\text{mm}$ ,  $dz=2.5\text{mm}$

Reference Value = 3.681 V/m; Power Drift = 0.15 dB

Peak SAR (extrapolated) = 3.576 W/kg

**SAR(1 g) = 0.972 mW/g; SAR(10 g) = 0.417 mW/g**

Maximum value of SAR (measured) = 1.803 mW/g

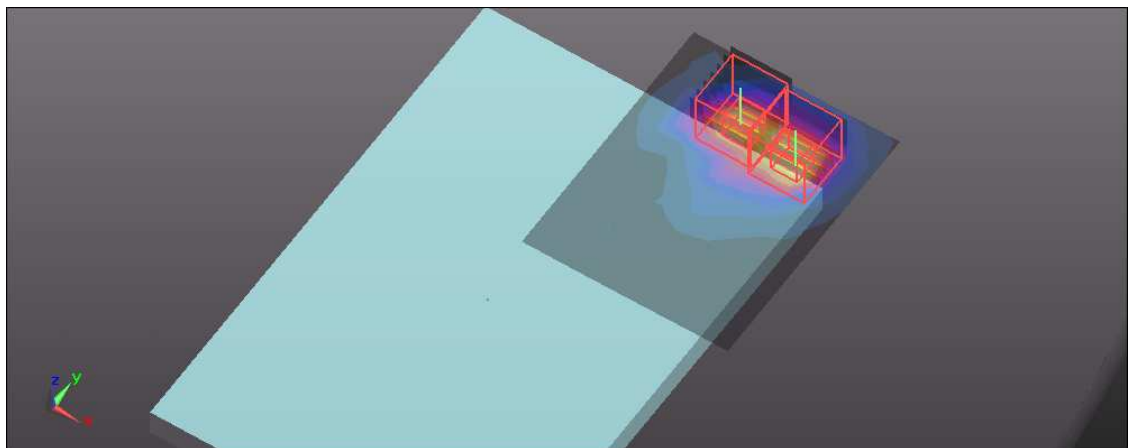
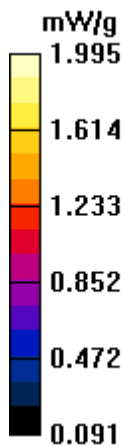

## M04-11a\_B1-Ch40

Communication System: 802.11a ; Frequency: 5200 MHz ; Duty Cycle: 1:1 ; Modulation type: BPSK  
Medium: MSL5800 Medium parameters used:  $f = 5200$  MHz;  $\sigma = 5.21$  mho/m;  $\epsilon_r = 50.16$ ;  $\rho = 1000$  kg/m<sup>3</sup>

Phantom section: Flat Section ; Separation distance : 5 mm (The top side of the EUT to the Phantom)

DASY5 Configuration:

- Probe: EX3DV4 - SN3590; ConvF(4.8, 4.8, 4.8); Calibrated: 2010/3/25
- Sensor-Surface: 2mm (Mechanical Surface Detection)
- Electronics: DAE3 Sn510; Calibrated: 2010/10/4
- Phantom: ELI 4.0; Type: QDOVA001BA;Serial: 1043
- Measurement SW: DASY52, Version 52.6 (1); SEMCAD X Version 14.4.2 (2595)

**Flat-Section MSL/Flat Section 5mm /Area Scan (7x11x1):** Measurement grid: dx=10mm, dy=10mm

Maximum value of SAR (measured) = 0.122 mW/g

**Flat-Section MSL/Flat Section 5mm /Zoom Scan (7x7x9)/Cube 0:** Measurement grid: dx=4mm, dy=4mm, dz=2.5mm

Reference Value = 2.156 V/m; Power Drift = 0.15 dB

Peak SAR (extrapolated) = 0.233 W/kg

**SAR(1 g) = 0.087 mW/g; SAR(10 g) = 0.055 mW/g**

Maximum value of SAR (measured) = 0.134 mW/g

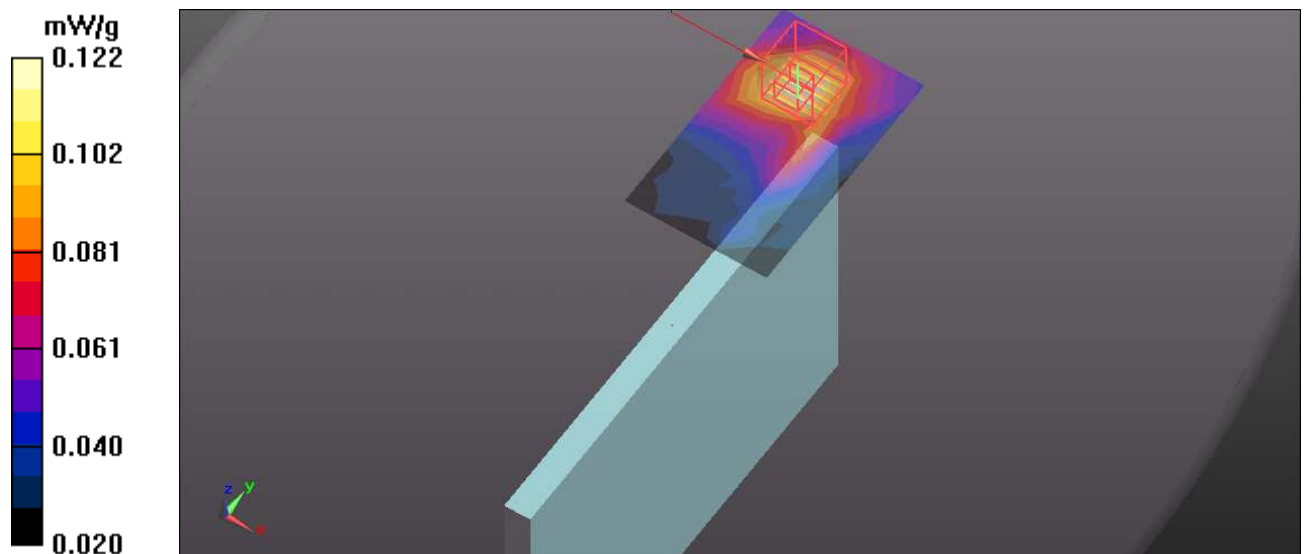

## M05-11a\_B2-Ch60

Communication System: 802.11a ; Frequency: 5300 MHz ; Duty Cycle: 1:1 ; Modulation type: BPSK  
Medium: MSL5800 Medium parameters used:  $f = 5300$  MHz;  $\sigma = 5.36$  mho/m;  $\epsilon_r = 49.96$ ;  $\rho = 1000$  kg/m<sup>3</sup>

Phantom section: Flat Section ; Separation distance : 5 mm (The top side of the EUT to the Phantom)  
DASY5 Configuration:

- Probe: EX3DV4 - SN3590; ConvF(4.5, 4.5, 4.5); Calibrated: 2010/3/25
- Sensor-Surface: 2mm (Mechanical Surface Detection)
- Electronics: DAE3 Sn510; Calibrated: 2010/10/4
- Phantom: ELI 4.0; Type: QDOVA001BA;Serial: 1043
- Measurement SW: DASY52, Version 52.6 (1); SEMCAD X Version 14.4.2 (2595)

**Flat-Section MSL/Flat Section 5mm /Area Scan (7x11x1):** Measurement grid: dx=10mm, dy=10mm

Maximum value of SAR (measured) = 0.213 mW/g

**Flat-Section MSL/Flat Section 5mm /Zoom Scan (7x7x9)/Cube 0:** Measurement grid: dx=4mm, dy=4mm, dz=2.5mm

Reference Value = 2.335 V/m; Power Drift = 0.16 dB

Peak SAR (extrapolated) = 0.405 W/kg

**SAR(1 g) = 0.138 mW/g; SAR(10 g) = 0.078 mW/g**

Maximum value of SAR (measured) = 0.221 mW/g

**Flat-Section MSL/Flat Section 5mm /Zoom Scan (7x7x9)/Cube 1:** Measurement grid: dx=4mm, dy=4mm, dz=2.5mm

Reference Value = 2.335 V/m; Power Drift = 0.16 dB

Peak SAR (extrapolated) = 1.284 W/kg

**SAR(1 g) = 0.099 mW/g; SAR(10 g) = 0.029 mW/g**

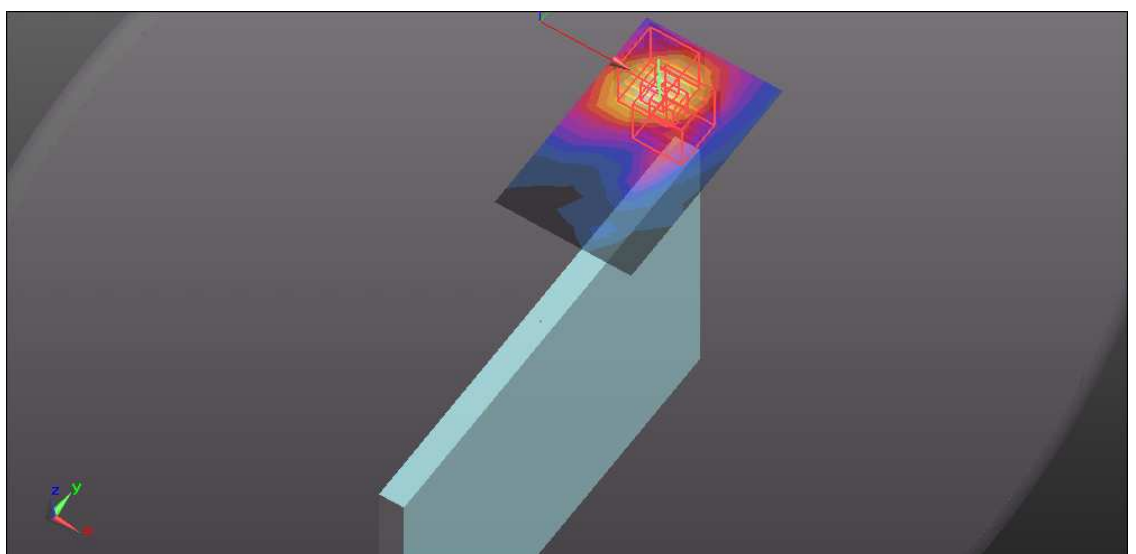
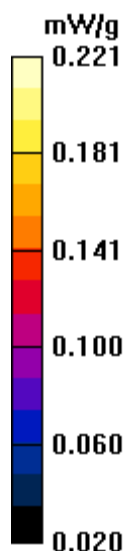

## M06-11a\_B3-Ch104

Communication System: 802.11a ; Frequency: 5520 MHz ; Duty Cycle: 1:1 ; Modulation type: BPSK  
Medium: MSL5800 Medium parameters used:  $f = 5520$  MHz;  $\sigma = 5.69$  mho/m;  $\epsilon_r = 49.46$ ;  $\rho = 1000$  kg/m<sup>3</sup>

Phantom section: Flat Section ; Separation distance : 5 mm (The top side of the EUT to the Phantom)

DASY5 Configuration:

- Probe: EX3DV4 - SN3590; ConvF(4.32, 4.32, 4.32); Calibrated: 2010/3/25
- Sensor-Surface: 2mm (Mechanical Surface Detection)
- Electronics: DAE3 Sn510; Calibrated: 2010/10/4
- Phantom: ELI 4.0; Type: QDOVA001BA;Serial: 1043
- Measurement SW: DASY52, Version 52.6 (1); SEMCAD X Version 14.4.2 (2595)

**Flat-Section MSL/Flat Section 5mm /Area Scan (7x11x1):** Measurement grid: dx=10mm, dy=10mm

Maximum value of SAR (measured) = 0.752 mW/g

**Flat-Section MSL/Flat Section 5mm /Zoom Scan (7x7x9)/Cube 0:** Measurement grid: dx=4mm, dy=4mm, dz=2.5mm

Reference Value = 3.275 V/m; Power Drift = -0.15 dB

Peak SAR (extrapolated) = 1.369 W/kg

**SAR(1 g) = 0.437 mW/g; SAR(10 g) = 0.205 mW/g**

Maximum value of SAR (measured) = 0.754 mW/g

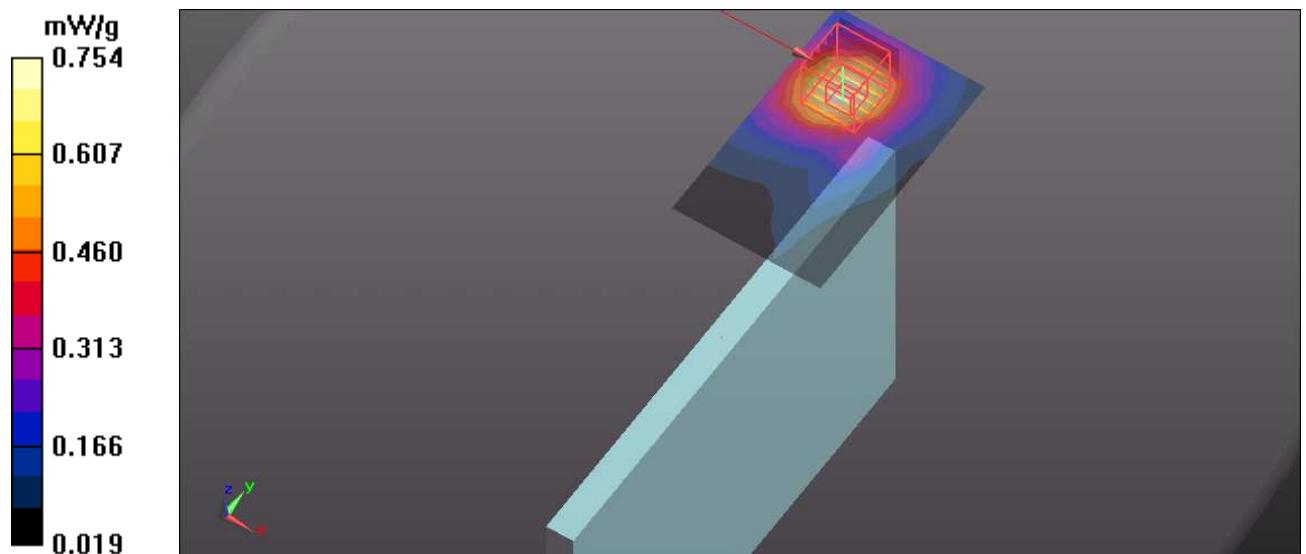



## M06-11a\_B3-Ch116

Communication System: 802.11a ; Frequency: 5580 MHz ; Duty Cycle: 1:1 ; Modulation type: BPSK  
Medium: MSL5800 Medium parameters used:  $f = 5580$  MHz;  $\sigma = 5.76$  mho/m;  $\epsilon_r = 49.36$ ;  $\rho = 1000$  kg/m<sup>3</sup>

Phantom section: Flat Section ; Separation distance : 5 mm (The top side of the EUT to the Phantom)

DASY5 Configuration:

- Probe: EX3DV4 - SN3590; ConvF(4.16, 4.16, 4.16); Calibrated: 2010/3/25
- Sensor-Surface: 2mm (Mechanical Surface Detection)
- Electronics: DAE3 Sn510; Calibrated: 2010/10/4
- Phantom: ELI 4.0; Type: QDOVA001BA;Serial: 1043
- Measurement SW: DASY52, Version 52.6 (1); SEMCAD X Version 14.4.2 (2595)

**Flat-Section MSL/Flat Section 5mm /Area Scan (7x24x1):** Measurement grid: dx=10mm, dy=10mm

Maximum value of SAR (measured) = 0.807 mW/g

**Flat-Section MSL/Flat Section 5mm /Zoom Scan (7x7x9)/Cube 0:** Measurement grid: dx=4mm, dy=4mm, dz=2.5mm

Reference Value = 3.263 V/m; Power Drift = 0.14 dB

Peak SAR (extrapolated) = 1.481 W/kg

**SAR(1 g) = 0.471 mW/g; SAR(10 g) = 0.222 mW/g**

Maximum value of SAR (measured) = 0.814 mW/g

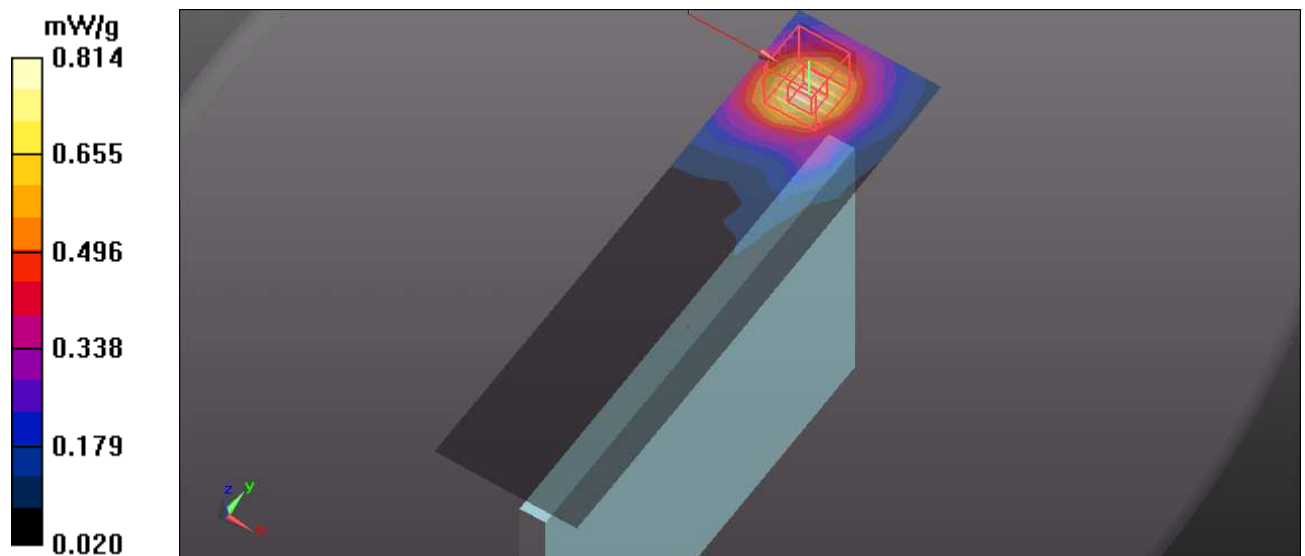

## M06-11a\_B3-Ch124

Communication System: 802.11a ; Frequency: 5620 MHz ; Duty Cycle: 1:1 ; Modulation type: BPSK  
Medium: MSL5800 Medium parameters used:  $f = 5620$  MHz;  $\sigma = 5.83$  mho/m;  $\epsilon_r = 49.26$ ;  $\rho = 1000$  kg/m<sup>3</sup>

Phantom section: Flat Section ; Separation distance : 5 mm (The top side of the EUT to the Phantom)

DASY5 Configuration:

- Probe: EX3DV4 - SN3590; ConvF(4.16, 4.16, 4.16); Calibrated: 2010/3/25
- Sensor-Surface: 2mm (Mechanical Surface Detection)
- Electronics: DAE3 Sn510; Calibrated: 2010/10/4
- Phantom: ELI 4.0; Type: QDOVA001BA;Serial: 1043
- Measurement SW: DASY52, Version 52.6 (1); SEMCAD X Version 14.4.2 (2595)

**Flat-Section MSL/Flat Section 5mm /Area Scan (7x11x1):** Measurement grid: dx=10mm, dy=10mm

Maximum value of SAR (measured) = 0.794 mW/g

**Flat-Section MSL/Flat Section 5mm /Zoom Scan (7x7x9)/Cube 0:** Measurement grid: dx=4mm, dy=4mm, dz=2.5mm

Reference Value = 2.855 V/m; Power Drift = 0.16 dB

Peak SAR (extrapolated) = 1.528 W/kg

**SAR(1 g) = 0.484 mW/g; SAR(10 g) = 0.230 mW/g**

Maximum value of SAR (measured) = 0.842 mW/g

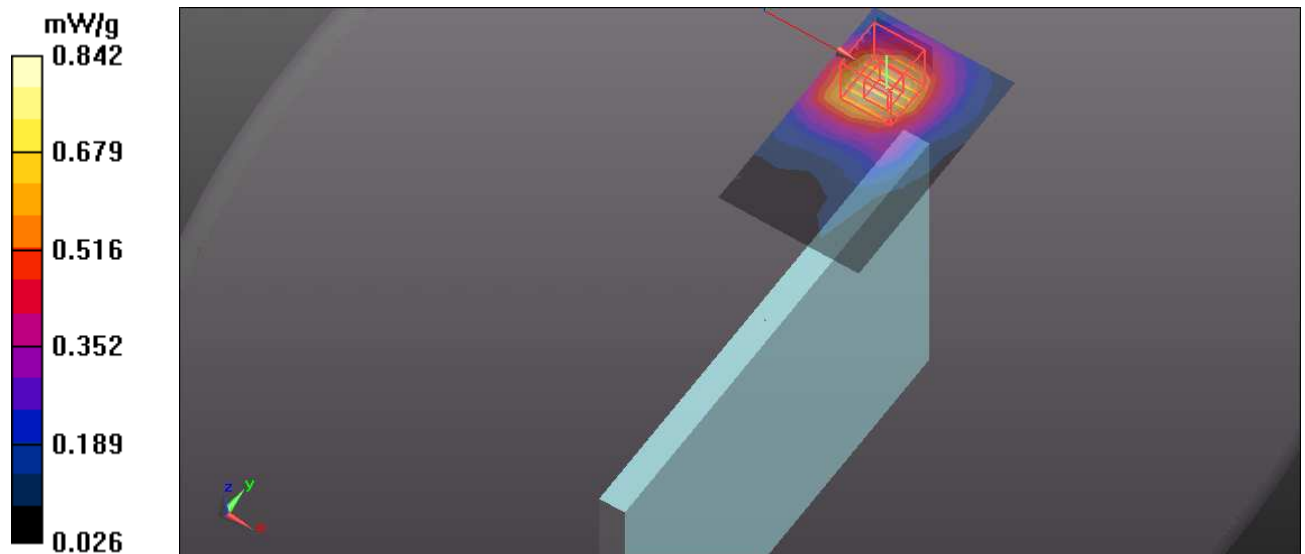

## M06-11a\_B3-Ch136

Communication System: 802.11a ; Frequency: 5680 MHz ; Duty Cycle: 1:1 ; Modulation type: BPSK  
Medium: MSL5800 Medium parameters used:  $f = 5680$  MHz;  $\sigma = 5.91$  mho/m;  $\epsilon_r = 49.16$ ;  $\rho = 1000$  kg/m<sup>3</sup>

Phantom section: Flat Section ; Separation distance :5 mm (The top side of the EUT to the Phantom)

DASY5 Configuration:

- Probe: EX3DV4 - SN3590; ConvF(4.16, 4.16, 4.16); Calibrated: 2010/3/25
- Sensor-Surface: 2mm (Mechanical Surface Detection)
- Electronics: DAE3 Sn510; Calibrated: 2010/10/4
- Phantom: ELI 4.0; Type: QDOVA001BA;Serial: 1043
- Measurement SW: DASY52, Version 52.6 (1); SEMCAD X Version 14.4.2 (2595)

**Flat-Section MSL/Flat Section 5mm /Area Scan (7x11x1):** Measurement grid: dx=10mm, dy=10mm

Maximum value of SAR (measured) = 0.767 mW/g

**Flat-Section MSL/Flat Section 5mm /Zoom Scan (7x7x9)/Cube 0:** Measurement grid: dx=4mm, dy=4mm, dz=2.5mm

Reference Value = 4.489 V/m; Power Drift = -0.12 dB

Peak SAR (extrapolated) = 1.459 W/kg

**SAR(1 g) = 0.454 mW/g; SAR(10 g) = 0.216 mW/g**

Maximum value of SAR (measured) = 0.797 mW/g

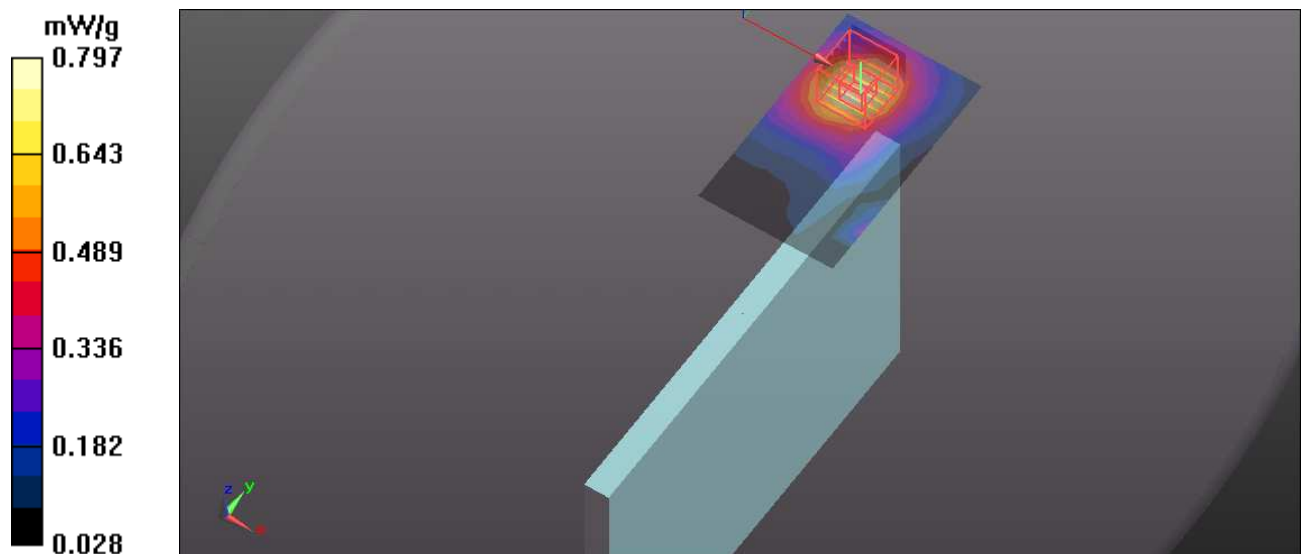

## M07-11a\_B1-Ch40

Communication System: 802.11a ; Frequency: 5200 MHz ; Duty Cycle: 1:1 ; Modulation type: BPSK  
Medium: MSL5800 Medium parameters used:  $f = 5200$  MHz;  $\sigma = 5.21$  mho/m;  $\epsilon_r = 50.16$ ;  $\rho = 1000$  kg/m<sup>3</sup>

Phantom section: Flat Section ; Separation distance : 5 mm (The right edge side of the EUT to the Phantom)

DASY5 Configuration:

- Probe: EX3DV4 - SN3590; ConvF(4.8, 4.8, 4.8); Calibrated: 2010/3/25
- Sensor-Surface: 2mm (Mechanical Surface Detection)
- Electronics: DAE3 Sn510; Calibrated: 2010/10/4
- Phantom: ELI 4.0; Type: QDOVA001BA;Serial: 1043
- Measurement SW: DASY52, Version 52.6 (1); SEMCAD X Version 14.4.2 (2595)

**Flat-Section MSL/Flat Section 5mm /Area Scan (9x5x1):** Measurement grid: dx=10mm, dy=10mm

Maximum value of SAR (measured) = 0.527 mW/g

**Flat-Section MSL/Flat Section 5mm /Zoom Scan (7x7x9)/Cube 0:** Measurement grid: dx=4mm, dy=4mm, dz=2.5mm

Reference Value = 6.984 V/m; Power Drift = 0.09 dB

Peak SAR (extrapolated) = 1.138 W/kg

**SAR(1 g) = 0.330 mW/g; SAR(10 g) = 0.125 mW/g**

Maximum value of SAR (measured) = 0.622 mW/g

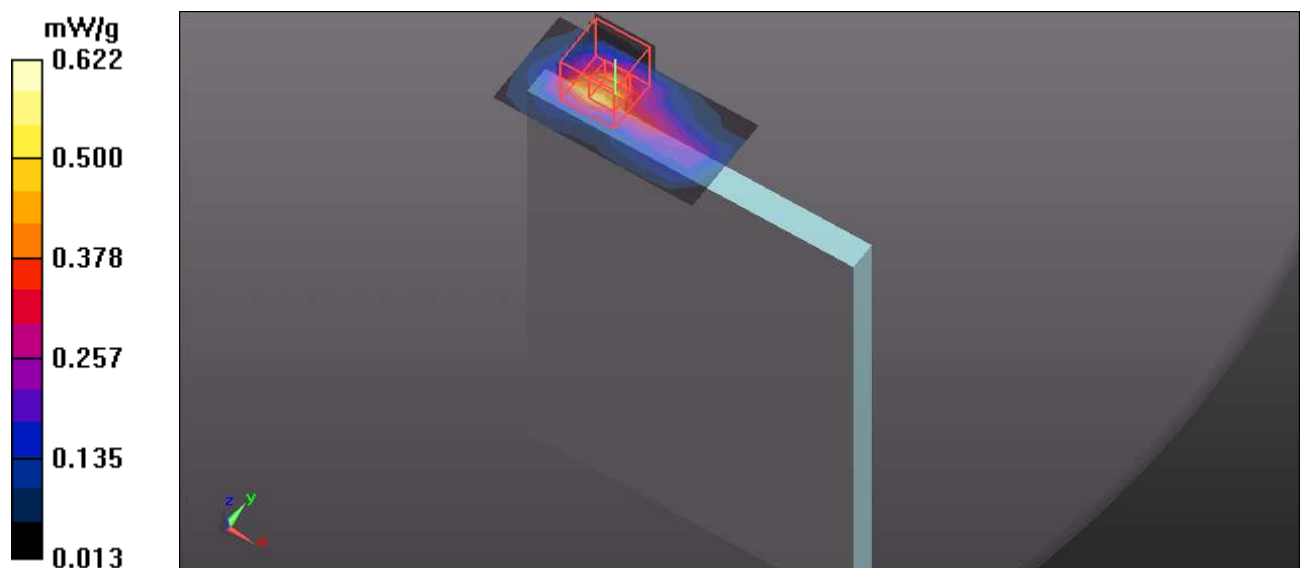

## M08-11a\_B2-Ch60

Communication System: 802.11a ; Frequency: 5300 MHz ; Duty Cycle: 1:1 ; Modulation type: BPSK  
Medium: MSL5800 Medium parameters used:  $f = 5300$  MHz;  $\sigma = 5.36$  mho/m;  $\epsilon_r = 49.96$ ;  $\rho = 1000$  kg/m<sup>3</sup>

Phantom section: Flat Section ; Separation distance : 5 mm (The right edge side of the EUT to the Phantom)

DASY5 Configuration:

- Probe: EX3DV4 - SN3590; ConvF(4.5, 4.5, 4.5); Calibrated: 2010/3/25
- Sensor-Surface: 2mm (Mechanical Surface Detection)
- Electronics: DAE3 Sn510; Calibrated: 2010/10/4
- Phantom: ELI 4.0; Type: QDOVA001BA;Serial: 1043
- Measurement SW: DASY52, Version 52.6 (1); SEMCAD X Version 14.4.2 (2595)

**Flat-Section MSL/Flat Section 5mm /Area Scan (9x5x1):** Measurement grid: dx=10mm, dy=10mm

Maximum value of SAR (measured) = 0.970 mW/g

**Flat-Section MSL/Flat Section 5mm /Zoom Scan (7x7x9)/Cube 0:** Measurement grid: dx=4mm, dy=4mm, dz=2.5mm

Reference Value = 8.593 V/m; Power Drift = 0.18 dB

Peak SAR (extrapolated) = 2.200 W/kg

**SAR(1 g) = 0.616 mW/g; SAR(10 g) = 0.227 mW/g**

Maximum value of SAR (measured) = 1.198 mW/g

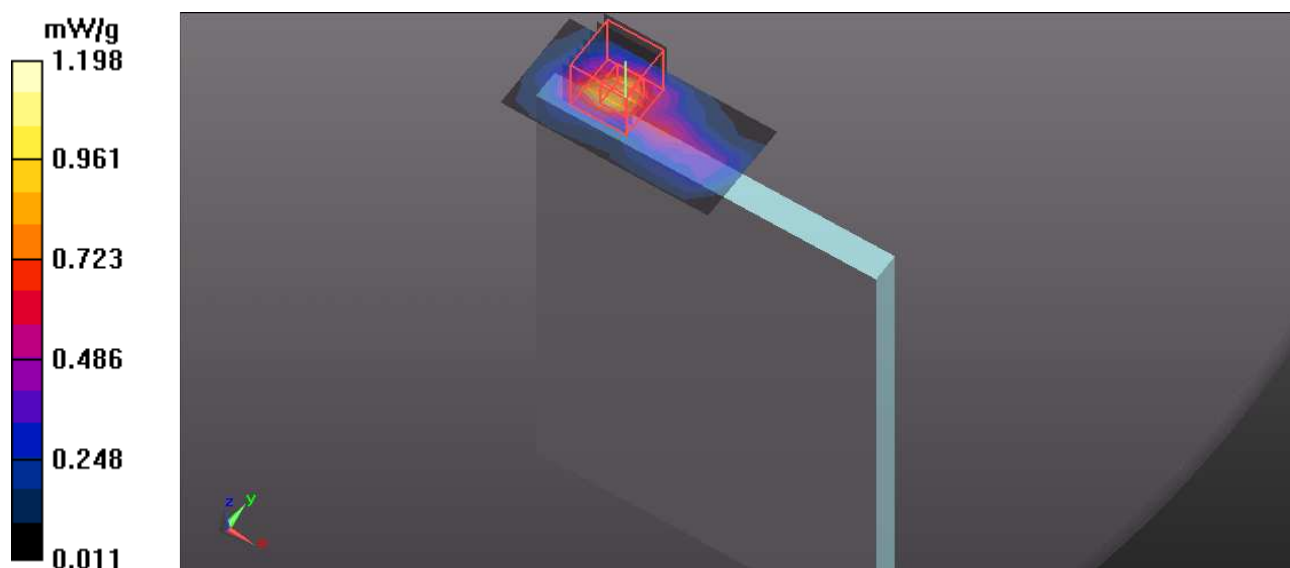

## M09-11a\_B3-Ch104

Communication System: 802.11a ; Frequency: 5520 MHz ; Duty Cycle: 1:1 ; Modulation type: BPSK  
Medium: MSL5800 Medium parameters used:  $f = 5520$  MHz;  $\sigma = 5.69$  mho/m;  $\epsilon_r = 49.46$ ;  $\rho = 1000$  kg/m<sup>3</sup>

Phantom section: Flat Section ; Separation distance : 5 mm (The right edge side of the EUT to the Phantom)

DASY5 Configuration:

- Probe: EX3DV4 - SN3590; ConvF(4.32, 4.32, 4.32); Calibrated: 2010/3/25
- Sensor-Surface: 2mm (Mechanical Surface Detection)
- Electronics: DAE3 Sn510; Calibrated: 2010/10/4
- Phantom: ELI 4.0; Type: QDOVA001BA;Serial: 1043
- Measurement SW: DASY52, Version 52.6 (1); SEMCAD X Version 14.4.2 (2595)

**Flat-Section MSL/Flat Section 5mm /Area Scan (9x5x1):** Measurement grid: dx=10mm, dy=10mm

Maximum value of SAR (measured) = 2.057 mW/g

**Flat-Section MSL/Flat Section 5mm /Zoom Scan (7x7x9)/Cube 0:** Measurement grid: dx=4mm, dy=4mm, dz=2.5mm

Reference Value = 8.904 V/m; Power Drift = 0.11 dB

Peak SAR (extrapolated) = 4.845 W/kg

**SAR(1 g) = 1.29 mW/g; SAR(10 g) = 0.453 mW/g**

Maximum value of SAR (measured) = 2.585 mW/g

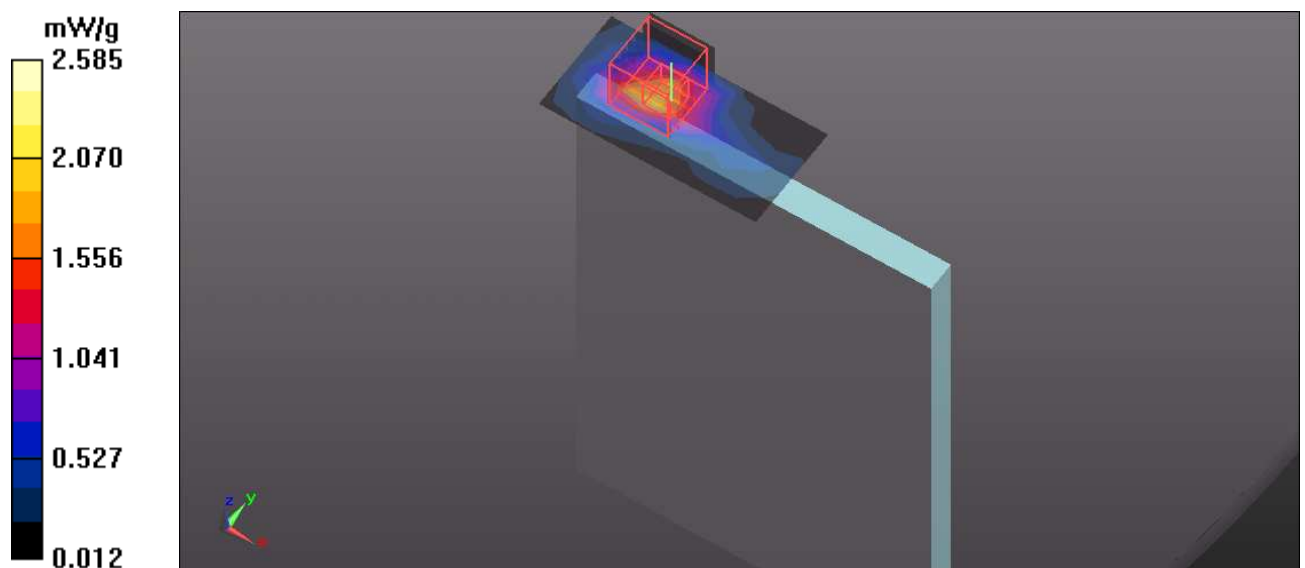

## M09-11a\_B3-Ch116

Communication System: 802.11a ; Frequency: 5580 MHz ; Duty Cycle: 1:1 ; Modulation type: BPSK  
Medium: MSL5800 Medium parameters used:  $f = 5580$  MHz;  $\sigma = 5.76$  mho/m;  $\epsilon_r = 49.36$ ;  $\rho = 1000$  kg/m<sup>3</sup>

Phantom section: Flat Section ; Separation distance : 5 mm (The right edge side of the EUT to the Phantom)

DASY5 Configuration:

- Probe: EX3DV4 - SN3590; ConvF(4.16, 4.16, 4.16); Calibrated: 2010/3/25
- Sensor-Surface: 2mm (Mechanical Surface Detection)
- Electronics: DAE3 Sn510; Calibrated: 2010/10/4
- Phantom: ELI 4.0; Type: QDOVA001BA;Serial: 1043
- Measurement SW: DASY52, Version 52.6 (1); SEMCAD X Version 14.4.2 (2595)

**Flat-Section MSL/Flat Section 5mm /Area Scan (16x5x1):** Measurement grid: dx=10mm, dy=10mm

Maximum value of SAR (measured) = 2.165 mW/g

**Flat-Section MSL/Flat Section 5mm /Zoom Scan (7x7x9)/Cube 0:** Measurement grid: dx=4mm, dy=4mm, dz=2.5mm

Reference Value = 8.370 V/m; Power Drift = -0.01 dB

Peak SAR (extrapolated) = 5.393 W/kg

**SAR(1 g) = 1.37 mW/g; SAR(10 g) = 0.466 mW/g**

Maximum value of SAR (measured) = 2.768 mW/g

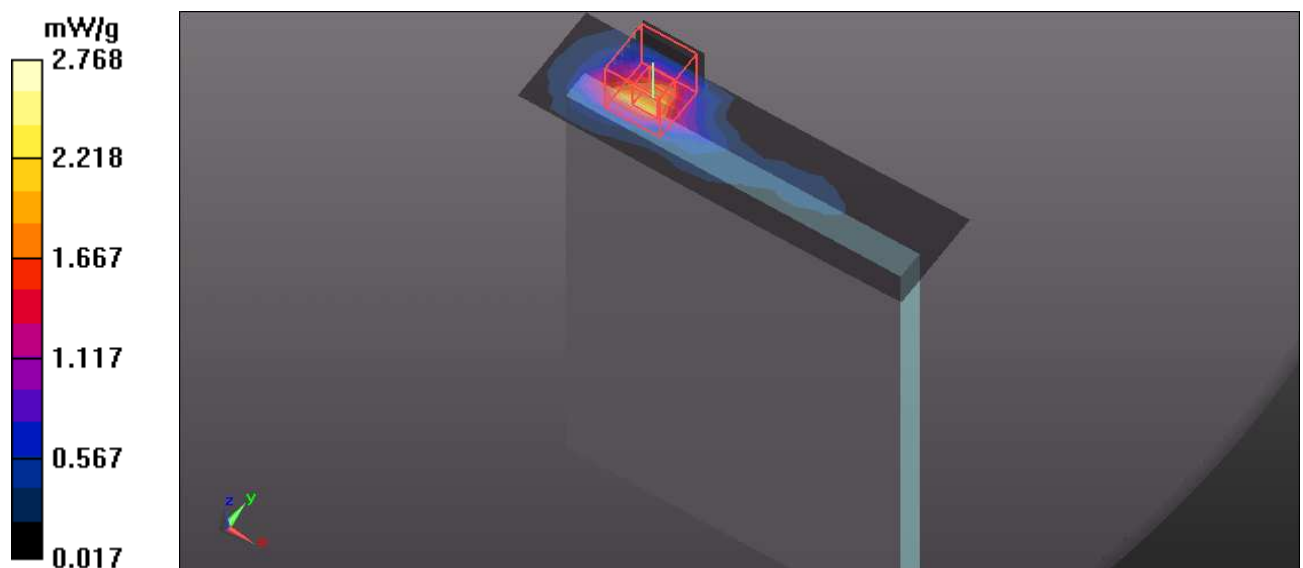

## M09-11a\_B3-Ch124

Communication System: 802.11a ; Frequency: 5620 MHz ; Duty Cycle: 1:1 ; Modulation type: BPSK  
Medium: MSL5800 Medium parameters used:  $f = 5620$  MHz;  $\sigma = 5.83$  mho/m;  $\epsilon_r = 49.26$ ;  $\rho = 1000$  kg/m<sup>3</sup>

Phantom section: Flat Section ; Separation distance : 5 mm (The right edge side of the EUT to the Phantom)

DASY5 Configuration:

- Probe: EX3DV4 - SN3590; ConvF(4.16, 4.16, 4.16); Calibrated: 2010/3/25
- Sensor-Surface: 2mm (Mechanical Surface Detection)
- Electronics: DAE3 Sn510; Calibrated: 2010/10/4
- Phantom: ELI 4.0; Type: QDOVA001BA;Serial: 1043
- Measurement SW: DASY52, Version 52.6 (1); SEMCAD X Version 14.4.2 (2595)

**Flat-Section MSL/Flat Section 5mm /Area Scan (9x5x1):** Measurement grid: dx=10mm, dy=10mm

Maximum value of SAR (measured) = 2.300 mW/g

**Flat-Section MSL/Flat Section 5mm /Zoom Scan (7x7x9)/Cube 0:** Measurement grid: dx=4mm, dy=4mm, dz=2.5mm

Reference Value = 7.891 V/m; Power Drift = 0.06 dB

Peak SAR (extrapolated) = 5.447 W/kg

**SAR(1 g) = 1.41 mW/g; SAR(10 g) = 0.488 mW/g**

Maximum value of SAR (measured) = 2.775 mW/g

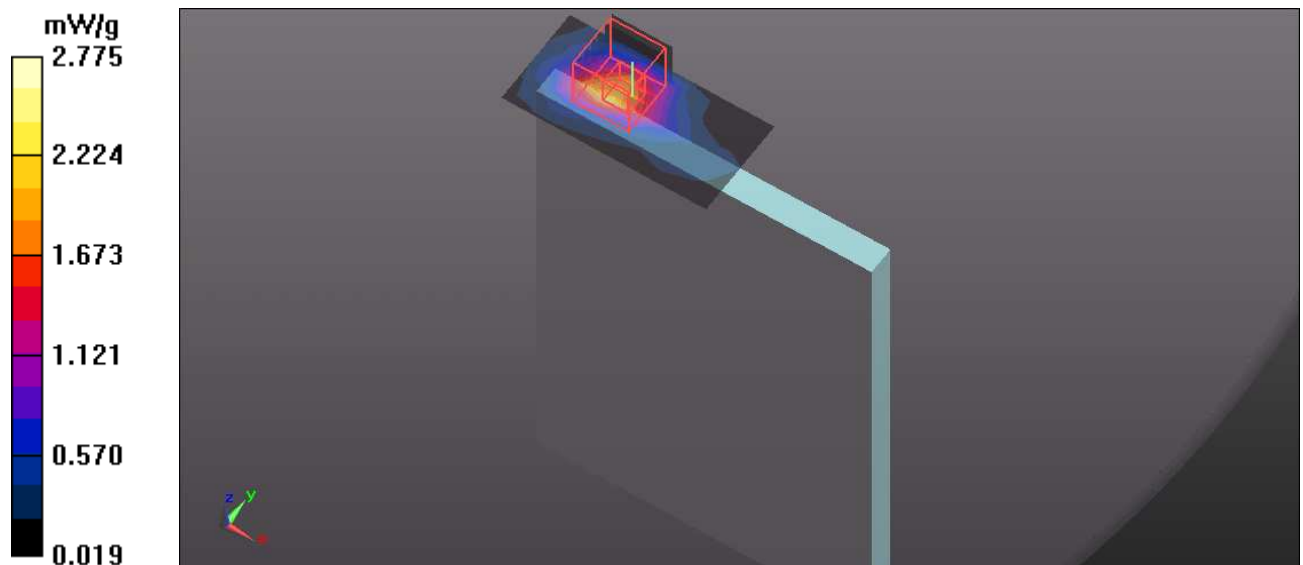



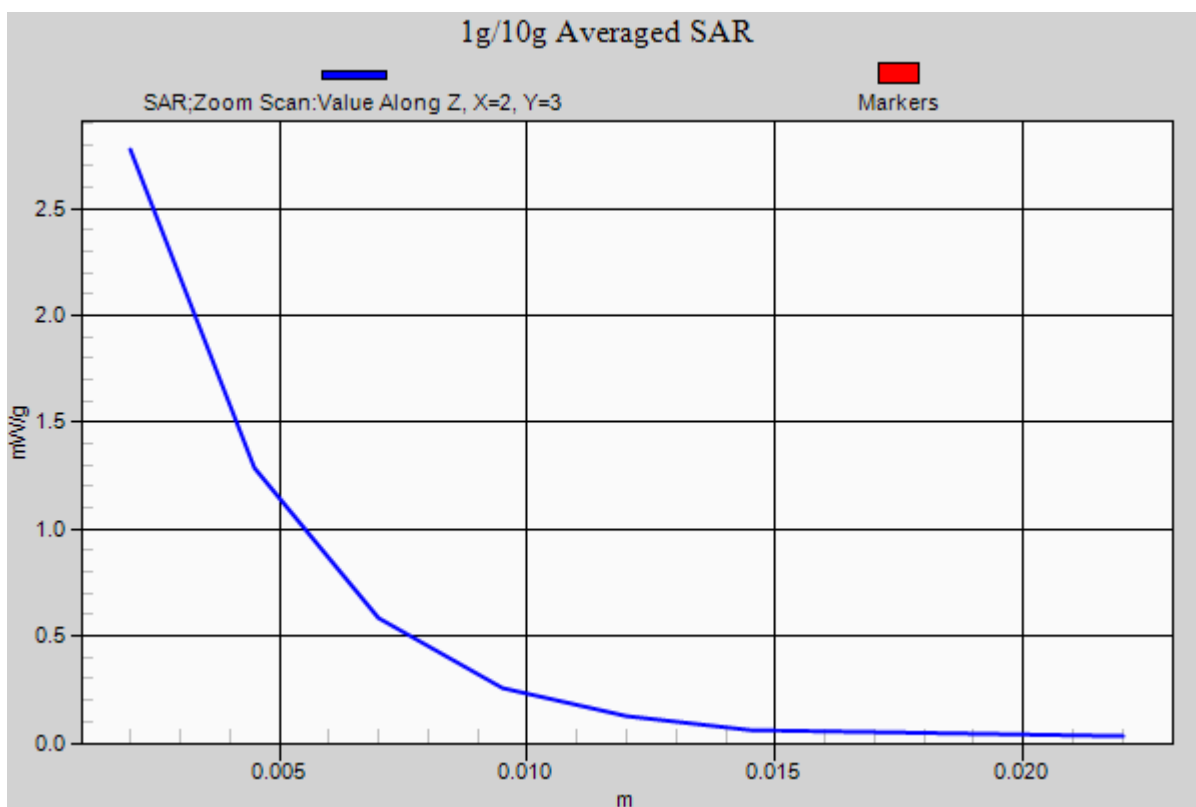

## M09-11a\_B3-Ch136

Communication System: 802.11a ; Frequency: 5680 MHz ; Duty Cycle: 1:1 ; Modulation type: BPSK  
Medium: MSL5800 Medium parameters used:  $f = 5680$  MHz;  $\sigma = 5.91$  mho/m;  $\epsilon_r = 49.16$ ;  $\rho = 1000$  kg/m<sup>3</sup>

Phantom section: Flat Section ; Separation distance : 5 mm (The right edge side of the EUT to the Phantom)

DASY5 Configuration:

- Probe: EX3DV4 - SN3590; ConvF(4.16, 4.16, 4.16); Calibrated: 2010/3/25
- Sensor-Surface: 2mm (Mechanical Surface Detection)
- Electronics: DAE3 Sn510; Calibrated: 2010/10/4
- Phantom: ELI 4.0; Type: QDOVA001BA;Serial: 1043
- Measurement SW: DASY52, Version 52.6 (1); SEMCAD X Version 14.4.2 (2595)

**Flat-Section MSL/Flat Section 5mm /Area Scan (9x5x1):** Measurement grid: dx=10mm, dy=10mm

Maximum value of SAR (measured) = 2.247 mW/g

**Flat-Section MSL/Flat Section 5mm /Zoom Scan (7x7x9)/Cube 0:** Measurement grid: dx=4mm, dy=4mm, dz=2.5mm

Reference Value = 8.025 V/m; Power Drift = -0.03 dB

Peak SAR (extrapolated) = 5.531 W/kg

**SAR(1 g) = 1.4 mW/g; SAR(10 g) = 0.475 mW/g**

Maximum value of SAR (measured) = 2.829 mW/g

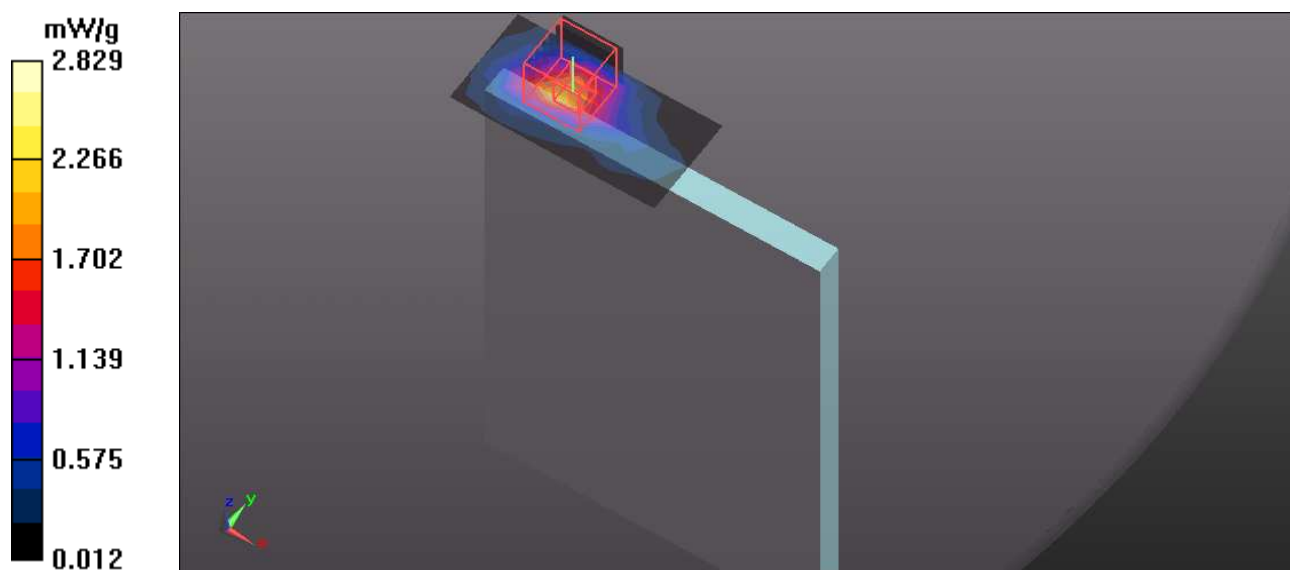

### M10-11an20\_B1-Ch40

Communication System: 802.11a ; Frequency: 5200 MHz ; Duty Cycle: 1:1 ; Modulation type: BPSK  
Medium: MSL5800 Medium parameters used:  $f = 5200$  MHz;  $\sigma = 5.23$  mho/m;  $\epsilon_r = 50.03$ ;  $\rho = 1000$  kg/m<sup>3</sup>

Phantom section: Flat Section ; Separation distance : 5 mm (The bottom side of the EUT to the Phantom)

DASY5 Configuration:

- Probe: EX3DV4 - SN3590; ConvF(4.8, 4.8, 4.8); Calibrated: 2010/3/25
- Sensor-Surface: 2mm (Mechanical Surface Detection)
- Electronics: DAE3 Sn510; Calibrated: 2010/10/4
- Phantom: ELI 4.0; Type: QDOVA001BA;Serial: 1043
- Measurement SW: DASY52, Version 52.6 (1); SEMCAD X Version 14.4.2 (2595)

**Flat-Section MSL/Flat Section 5mm /Area Scan (9x11x1):** Measurement grid: dx=10mm, dy=10mm

Maximum value of SAR (measured) = 0.659 mW/g

**Flat-Section MSL/Flat Section 5mm /Zoom Scan (7x7x9)/Cube 0:** Measurement grid:

dx=4mm, dy=4mm, dz=2.5mm

Reference Value = 2.454 V/m; Power Drift = 0.17 dB

Peak SAR (extrapolated) = 1.225 W/kg

**SAR(1 g) = 0.389 mW/g; SAR(10 g) = 0.170 mW/g**

Maximum value of SAR (measured) = 0.686 mW/g

**Flat-Section MSL/Flat Section 5mm /Zoom Scan (7x7x9)/Cube 1:** Measurement grid:

dx=4mm, dy=4mm, dz=2.5mm

Reference Value = 2.454 V/m; Power Drift = 0.17 dB

Peak SAR (extrapolated) = 0.750 W/kg

**SAR(1 g) = 0.281 mW/g; SAR(10 g) = 0.149 mW/g**

Maximum value of SAR (measured) = 0.450 mW/g

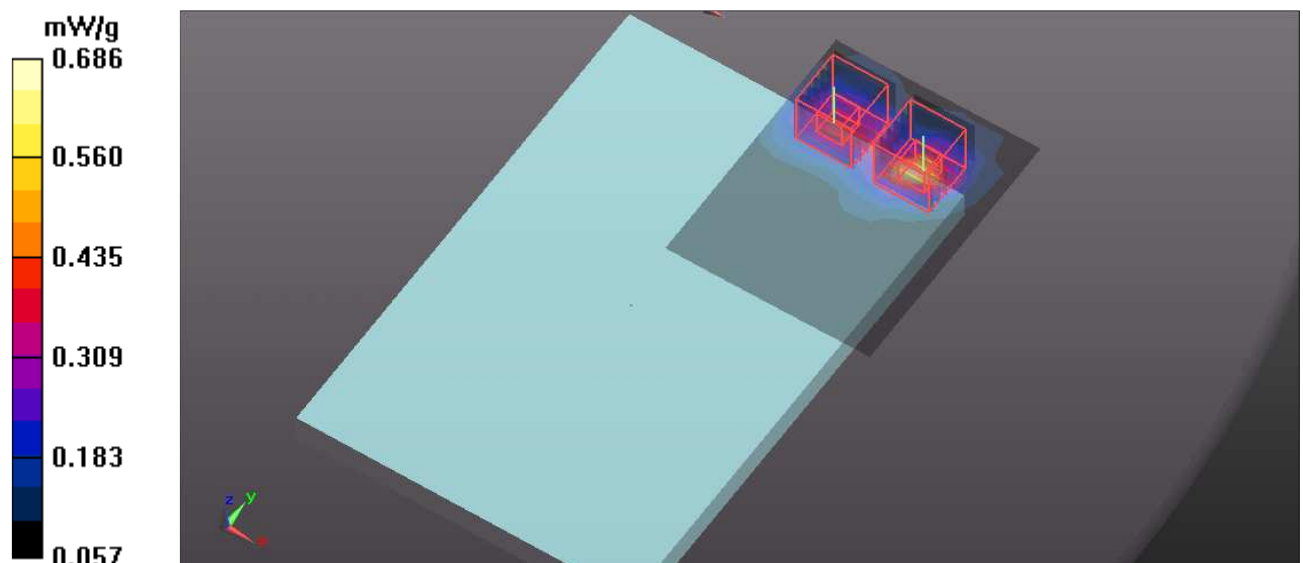

## M11-11an20\_B2-Ch60

Communication System: 802.11a ; Frequency: 5300 MHz ; Duty Cycle: 1:1 ; Modulation type: BPSK  
Medium: MSL5800 Medium parameters used:  $f = 5300$  MHz;  $\sigma = 5.38$  mho/m;  $\epsilon_r = 49.83$ ;  $\rho = 1000$  kg/m<sup>3</sup>

Phantom section: Flat Section ; Separation distance : 5 mm (The bottom side of the EUT to the Phantom)

DASY5 Configuration:

- Probe: EX3DV4 - SN3590; ConvF(4.5, 4.5, 4.5); Calibrated: 2010/3/25
- Sensor-Surface: 2mm (Mechanical Surface Detection)
- Electronics: DAE3 Sn510; Calibrated: 2010/10/4
- Phantom: ELI 4.0; Type: QDOVA001BA;Serial: 1043
- Measurement SW: DASY52, Version 52.6 (1); SEMCAD X Version 14.4.2 (2595)

**Flat-Section MSL/Flat Section 5mm /Area Scan (9x11x1):** Measurement grid: dx=10mm, dy=10mm

Maximum value of SAR (measured) = 0.821 mW/g

**Flat-Section MSL/Flat Section 5mm /Zoom Scan (7x7x9)/Cube 0:** Measurement grid: dx=4mm, dy=4mm, dz=2.5mm

Reference Value = 2.139 V/m; Power Drift = 0.17 dB

Peak SAR (extrapolated) = 1.827 W/kg

**SAR(1 g) = 0.664 mW/g; SAR(10 g) = 0.267 mW/g**

Maximum value of SAR (measured) = 0.797 mW/g

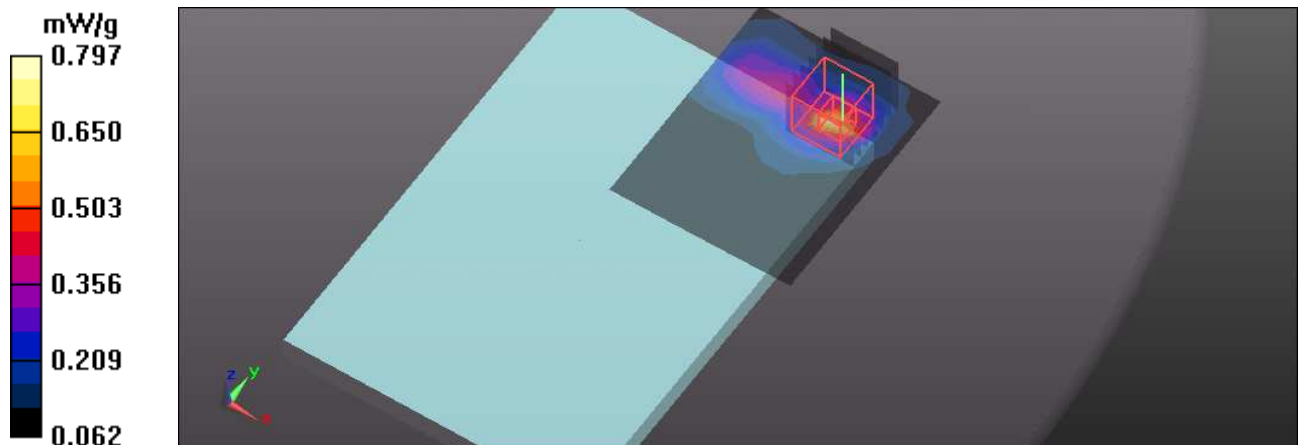

### M12-11an20\_B3-Ch104

Communication System: 802.11a ; Frequency: 5520 MHz ; Duty Cycle: 1:1 ; Modulation type: BPSK  
Medium: MSL5800 Medium parameters used:  $f = 5520$  MHz;  $\sigma = 5.71$  mho/m;  $\epsilon_r = 49.33$ ;  $\rho = 1000$  kg/m<sup>3</sup>

Phantom section: Flat Section ; Separation distance : 5 mm (The bottom side of the EUT to the Phantom)

DASY5 Configuration:

- Probe: EX3DV4 - SN3590; ConvF(4.32, 4.32, 4.32); Calibrated: 2010/3/25
- Sensor-Surface: 2mm (Mechanical Surface Detection)
- Electronics: DAE3 Sn510; Calibrated: 2010/10/4
- Phantom: ELI 4.0; Type: QDOVA001BA;Serial: 1043
- Measurement SW: DASY52, Version 52.6 (1); SEMCAD X Version 14.4.2 (2595)

**Flat-Section MSL/Flat Section 5mm /Area Scan (9x11x1):** Measurement grid: dx=10mm, dy=10mm

Maximum value of SAR (measured) = 2.002 mW/g

**Flat-Section MSL/Flat Section 5mm /Zoom Scan (7x7x9)/Cube 0:** Measurement grid:

dx=4mm, dy=4mm, dz=2.5mm

Reference Value = 3.352 V/m; Power Drift = -0.13 dB

Peak SAR (extrapolated) = 4.334 W/kg

**SAR(1 g) = 1.26 mW/g; SAR(10 g) = 0.471 mW/g**

Maximum value of SAR (measured) = 2.381 mW/g

**Flat-Section MSL/Flat Section 5mm /Zoom Scan (7x7x9)/Cube 1:** Measurement grid:

dx=4mm, dy=4mm, dz=2.5mm

Reference Value = 3.352 V/m; Power Drift = -0.13 dB

Peak SAR (extrapolated) = 3.117 W/kg

**SAR(1 g) = 0.884 mW/g; SAR(10 g) = 0.371 mW/g**

Maximum value of SAR (measured) = 1.707 mW/g

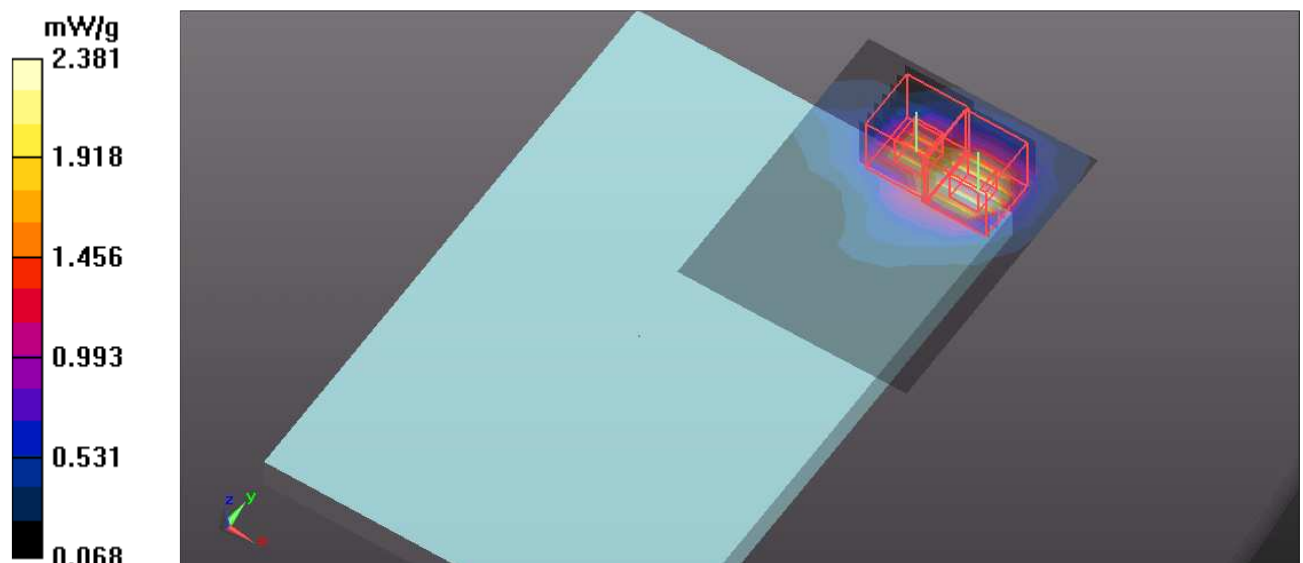



### M12-11an20\_B3-Ch116

Communication System: 802.11a ; Frequency: 5580 MHz ; Duty Cycle: 1:1 ; Modulation type: BPSK  
Medium: MSL5800 Medium parameters used:  $f = 5580$  MHz;  $\sigma = 5.78$  mho/m;  $\epsilon_r = 49.23$ ;  $\rho = 1000$  kg/m<sup>3</sup>

Phantom section: Flat Section ; Separation distance : 5 mm (The bottom side of the EUT to the Phantom)

DASY5 Configuration:

- Probe: EX3DV4 - SN3590; ConvF(4.16, 4.16, 4.16); Calibrated: 2010/3/25
- Sensor-Surface: 2mm (Mechanical Surface Detection)
- Electronics: DAE3 Sn510; Calibrated: 2010/10/4
- Phantom: ELI 4.0; Type: QDOVA001BA;Serial: 1043
- Measurement SW: DASY52, Version 52.6 (1); SEMCAD X Version 14.4.2 (2595)

**Flat-Section MSL/Flat Section 5mm /Area Scan (16x24x1):** Measurement grid: dx=10mm, dy=10mm

Maximum value of SAR (measured) = 1.978 mW/g

**Flat-Section MSL/Flat Section 5mm /Zoom Scan (7x7x9)/Cube 0:** Measurement grid:

dx=4mm, dy=4mm, dz=2.5mm

Reference Value = 3.113 V/m; Power Drift = 0.11 dB

Peak SAR (extrapolated) = 4.326 W/kg

**SAR(1 g) = 1.23 mW/g; SAR(10 g) = 0.473 mW/g**

Maximum value of SAR (measured) = 2.339 mW/g

**Flat-Section MSL/Flat Section 5mm /Zoom Scan (7x7x9)/Cube 1:** Measurement grid:

dx=4mm, dy=4mm, dz=2.5mm

Reference Value = 3.113 V/m; Power Drift = 0.11 dB

Peak SAR (extrapolated) = 3.494 W/kg

**SAR(1 g) = 0.958 mW/g; SAR(10 g) = 0.397 mW/g**

Maximum value of SAR (measured) = 1.823 mW/g

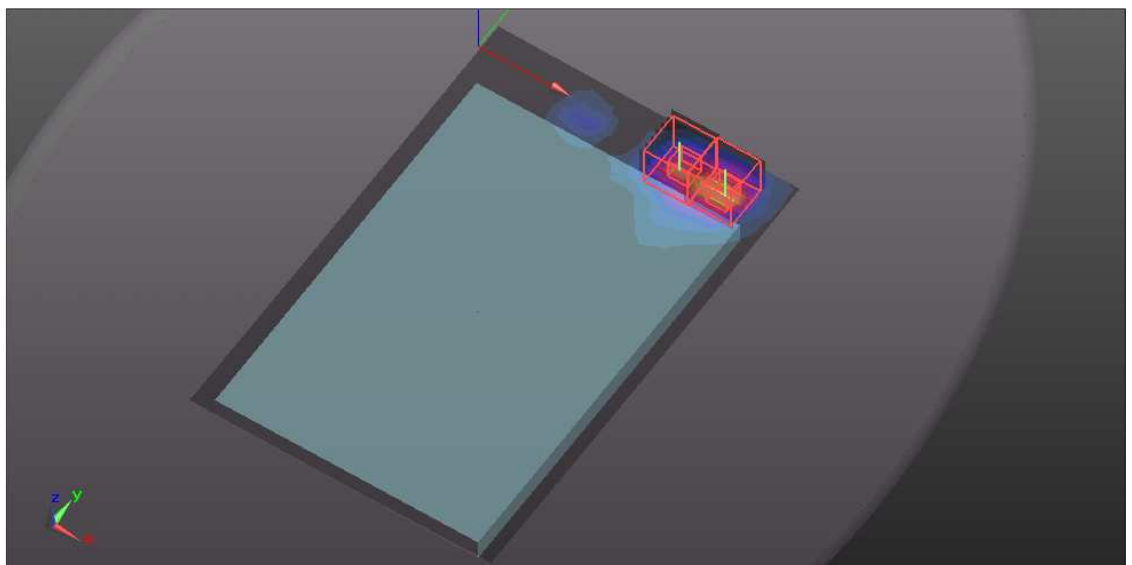
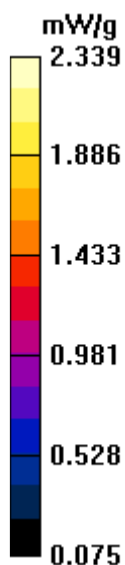

### M12-11an20\_B3-Ch124

Communication System: 802.11a ; Frequency: 5620 MHz ; Duty Cycle: 1:1 ; Modulation type: BPSK  
 Medium: MSL5800 Medium parameters used:  $f = 5620 \text{ MHz}$ ;  $\sigma = 5.85 \text{ mho/m}$ ;  $\epsilon_r = 49.13$ ;  $\rho = 1000 \text{ kg/m}^3$

Phantom section: Flat Section ; Separation distance : 5 mm (The bottom side of the EUT to the Phantom)

DASY5 Configuration:

- Probe: EX3DV4 - SN3590; ConvF(4.16, 4.16, 4.16); Calibrated: 2010/3/25
- Sensor-Surface: 2mm (Mechanical Surface Detection)
- Electronics: DAE3 Sn510; Calibrated: 2010/10/4
- Phantom: ELI 4.0; Type: QDOVA001BA;Serial: 1043
- Measurement SW: DASY52, Version 52.6 (1); SEMCAD X Version 14.4.2 (2595)

**Flat-Section MSL/Flat Section 5mm /Area Scan (9x11x1):** Measurement grid:  $dx=10\text{mm}$ ,  $dy=10\text{mm}$

Maximum value of SAR (measured) = 1.818 mW/g

**Flat-Section MSL/Flat Section 5mm /Zoom Scan (7x7x9)/Cube 0:** Measurement grid:

$dx=4\text{mm}$ ,  $dy=4\text{mm}$ ,  $dz=2.5\text{mm}$

Reference Value = 3.256 V/m; Power Drift = 0.14 dB

Peak SAR (extrapolated) = 4.040 W/kg

**SAR(1 g) = 1.14 mW/g; SAR(10 g) = 0.444 mW/g**

Maximum value of SAR (measured) = 2.141 mW/g

**Flat-Section MSL/Flat Section 5mm /Zoom Scan (7x7x9)/Cube 1:** Measurement grid:

$dx=4\text{mm}$ ,  $dy=4\text{mm}$ ,  $dz=2.5\text{mm}$

Reference Value = 3.256 V/m; Power Drift = 0.14 dB

Peak SAR (extrapolated) = 3.539 W/kg

**SAR(1 g) = 0.943 mW/g; SAR(10 g) = 0.390 mW/g**

Maximum value of SAR (measured) = 1.781 mW/g

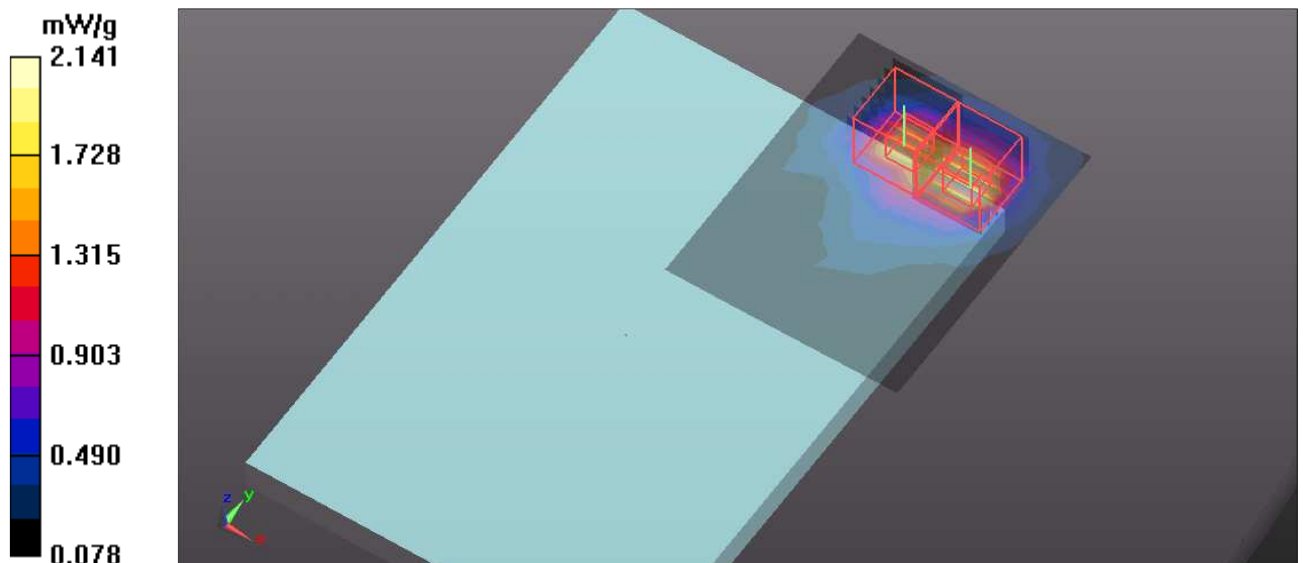

### M12-11an20\_B3-Ch136

Communication System: 802.11a ; Frequency: 5680 MHz ; Duty Cycle: 1:1 ; Modulation type: BPSK  
Medium: MSL5800 Medium parameters used:  $f = 5680$  MHz;  $\sigma = 5.93$  mho/m;  $\epsilon_r = 49.03$ ;  $\rho = 1000$  kg/m<sup>3</sup>

Phantom section: Flat Section ; Separation distance : 5 mm (The bottom side of the EUT to the Phantom)

DASY5 Configuration:

- Probe: EX3DV4 - SN3590; ConvF(4.16, 4.16, 4.16); Calibrated: 2010/3/25
- Sensor-Surface: 2mm (Mechanical Surface Detection)
- Electronics: DAE3 Sn510; Calibrated: 2010/10/4
- Phantom: ELI 4.0; Type: QDOVA001BA;Serial: 1043
- Measurement SW: DASY52, Version 52.6 (1); SEMCAD X Version 14.4.2 (2595)

**Flat-Section MSL/Flat Section 5mm /Area Scan (9x11x1):** Measurement grid: dx=10mm, dy=10mm

Maximum value of SAR (measured) = 1.726 mW/g

**Flat-Section MSL/Flat Section 5mm /Zoom Scan (7x7x9)/Cube 0:** Measurement grid:

dx=4mm, dy=4mm, dz=2.5mm

Reference Value = 3.134 V/m; Power Drift = -0.14 dB

Peak SAR (extrapolated) = 3.838 W/kg

**SAR(1 g) = 1.07 mW/g; SAR(10 g) = 0.427 mW/g**

Maximum value of SAR (measured) = 2.005 mW/g

**Flat-Section MSL/Flat Section 5mm /Zoom Scan (7x7x9)/Cube 1:** Measurement grid:

dx=4mm, dy=4mm, dz=2.5mm

Reference Value = 3.134 V/m; Power Drift = -0.14 dB

Peak SAR (extrapolated) = 3.567 W/kg

**SAR(1 g) = 0.970 mW/g; SAR(10 g) = 0.400 mW/g**

Maximum value of SAR (measured) = 1.826 mW/g

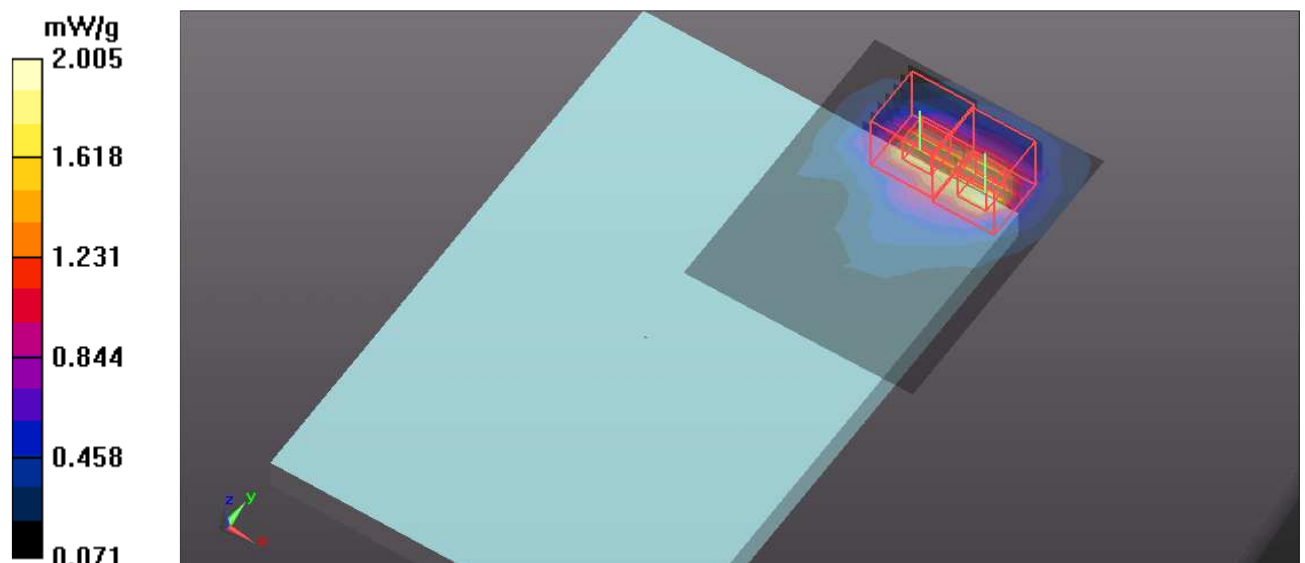



### M13-11an20\_B1-Ch40

Communication System: 802.11a ; Frequency: 5200 MHz ; Duty Cycle: 1:1 ; Modulation type: BPSK  
Medium: MSL5800 Medium parameters used:  $f = 5200$  MHz;  $\sigma = 5.23$  mho/m;  $\epsilon_r = 50.03$ ;  $\rho = 1000$  kg/m<sup>3</sup>

Phantom section: Flat Section ; Separation distance : 5 mm (The top side of the EUT to the Phantom)  
DASY5 Configuration:

- Probe: EX3DV4 - SN3590; ConvF(4.8, 4.8, 4.8); Calibrated: 2010/3/25
- Sensor-Surface: 2mm (Mechanical Surface Detection)
- Electronics: DAE3 Sn510; Calibrated: 2010/10/4
- Phantom: ELI 4.0; Type: QDOVA001BA;Serial: 1043
- Measurement SW: DASY52, Version 52.6 (1); SEMCAD X Version 14.4.2 (2595)

**Flat-Section MSL/Flat Section 5mm /Area Scan (8x11x1):** Measurement grid: dx=10mm, dy=10mm

Maximum value of SAR (measured) = 0.123 mW/g

**Flat-Section MSL/Flat Section 5mm /Zoom Scan (7x7x9)/Cube 0:** Measurement grid: dx=4mm, dy=4mm, dz=2.5mm

Reference Value = 2.761 V/m; Power Drift = -0.12 dB

Peak SAR (extrapolated) = 0.248 W/kg

**SAR(1 g) = 0.085 mW/g; SAR(10 g) = 0.052 mW/g**

Maximum value of SAR (measured) = 0.129 mW/g

**Flat-Section MSL/Flat Section 5mm /Zoom Scan (7x7x9)/Cube 1:** Measurement grid: dx=4mm, dy=4mm, dz=2.5mm

Reference Value = 2.761 V/m; Power Drift = -0.12 dB

Peak SAR (extrapolated) = 0.260 W/kg

**SAR(1 g) = 0.079 mW/g; SAR(10 g) = 0.047 mW/g**

Maximum value of SAR (measured) = 0.131 mW/g

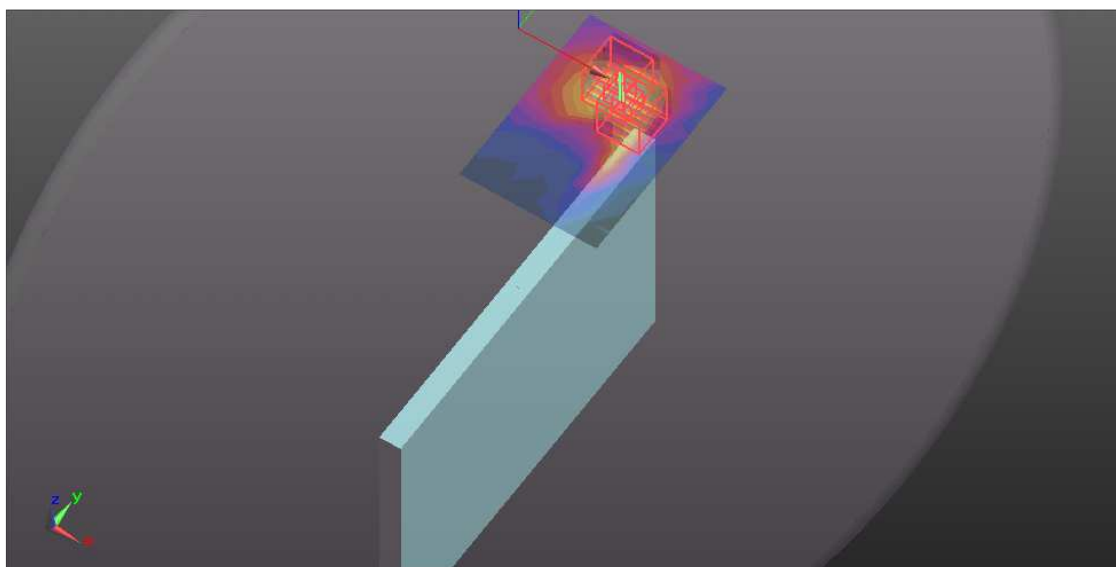
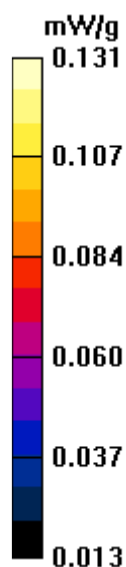

### M14-11an20\_B2-Ch60

Communication System: 802.11a ; Frequency: 5300 MHz ; Duty Cycle: 1:1 ; Modulation type: BPSK  
 Medium: MSL5800 Medium parameters used:  $f = 5300$  MHz;  $\sigma = 5.38$  mho/m;  $\epsilon_r = 49.83$ ;  $\rho = 1000$  kg/m<sup>3</sup>

Phantom section: Flat Section ; Separation distance : 5 mm (The top side of the EUT to the Phantom)  
 DASY5 Configuration:

- Probe: EX3DV4 - SN3590; ConvF(4.5, 4.5, 4.5); Calibrated: 2010/3/25
- Sensor-Surface: 2mm (Mechanical Surface Detection)
- Electronics: DAE3 Sn510; Calibrated: 2010/10/4
- Phantom: ELI 4.0; Type: QDOVA001BA;Serial: 1043
- Measurement SW: DASY52, Version 52.6 (1); SEMCAD X Version 14.4.2 (2595)

**Flat-Section MSL/Flat Section 5mm /Area Scan (8x11x1):** Measurement grid: dx=10mm, dy=10mm

Maximum value of SAR (measured) = 0.204 mW/g

**Flat-Section MSL/Flat Section 5mm /Zoom Scan (7x7x9)/Cube 0:** Measurement grid: dx=4mm, dy=4mm, dz=2.5mm

Reference Value = 2.841 V/m; Power Drift = -0.13 dB

Peak SAR (extrapolated) = 1.310 W/kg

**SAR(1 g) = 0.130 mW/g; SAR(10 g) = 0.059 mW/g**

Maximum value of SAR (measured) = 0.209 mW/g

**Flat-Section MSL/Flat Section 5mm /Zoom Scan (7x7x9)/Cube 1:** Measurement grid: dx=4mm, dy=4mm, dz=2.5mm

Reference Value = 2.841 V/m; Power Drift = -0.13 dB

Peak SAR (extrapolated) = 0.371 W/kg

**SAR(1 g) = 0.115 mW/g; SAR(10 g) = 0.051 mW/g**

Maximum value of SAR (measured) = 0.203 mW/g

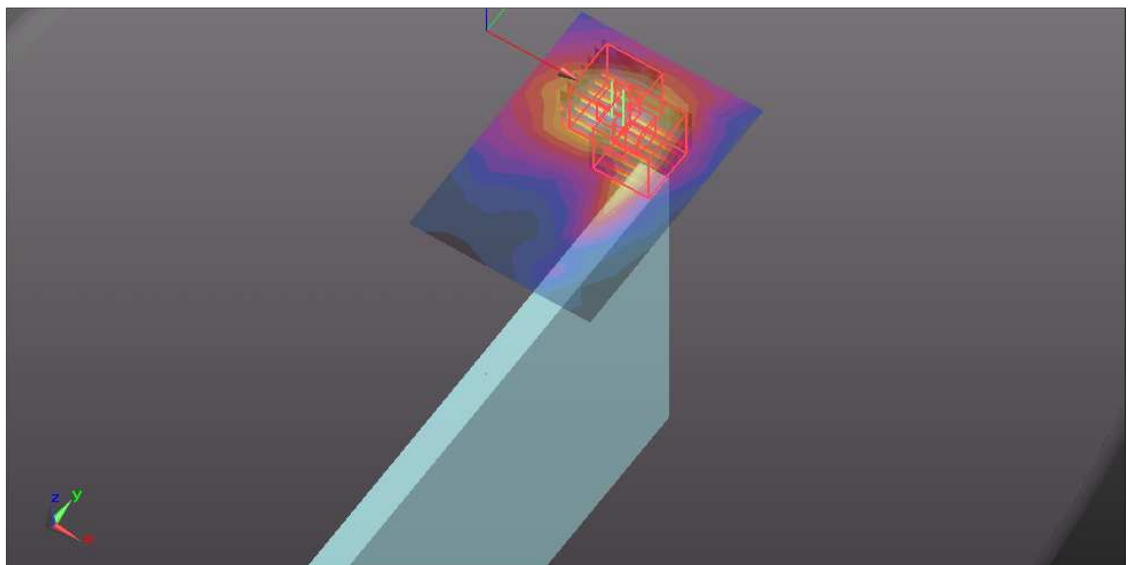
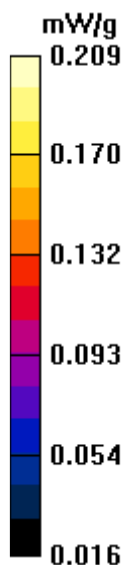

## M15-11an20\_B3-Ch104

Communication System: 802.11a ; Frequency: 5520 MHz ; Duty Cycle: 1:1 ; Modulation type: BPSK  
Medium: MSL5800 Medium parameters used:  $f = 5520$  MHz;  $\sigma = 5.71$  mho/m;  $\epsilon_r = 49.33$ ;  $\rho = 1000$  kg/m<sup>3</sup>

Phantom section: Flat Section ; Separation distance : 5 mm (The top side of the EUT to the Phantom)

DASY5 Configuration:

- Probe: EX3DV4 - SN3590; ConvF(4.32, 4.32, 4.32); Calibrated: 2010/3/25
- Sensor-Surface: 2mm (Mechanical Surface Detection)
- Electronics: DAE3 Sn510; Calibrated: 2010/10/4
- Phantom: ELI 4.0; Type: QDOVA001BA;Serial: 1043
- Measurement SW: DASY52, Version 52.6 (1); SEMCAD X Version 14.4.2 (2595)

**Flat-Section MSL/Flat Section 5mm /Area Scan (8x11x1):** Measurement grid: dx=10mm, dy=10mm

Maximum value of SAR (measured) = 0.711 mW/g

**Flat-Section MSL/Flat Section 5mm /Zoom Scan (7x7x9)/Cube 0:** Measurement grid: dx=4mm, dy=4mm, dz=2.5mm

Reference Value = 3.376 V/m; Power Drift = 0.18 dB

Peak SAR (extrapolated) = 1.292 W/kg

**SAR(1 g) = 0.414 mW/g; SAR(10 g) = 0.195 mW/g**

Maximum value of SAR (measured) = 0.721 mW/g

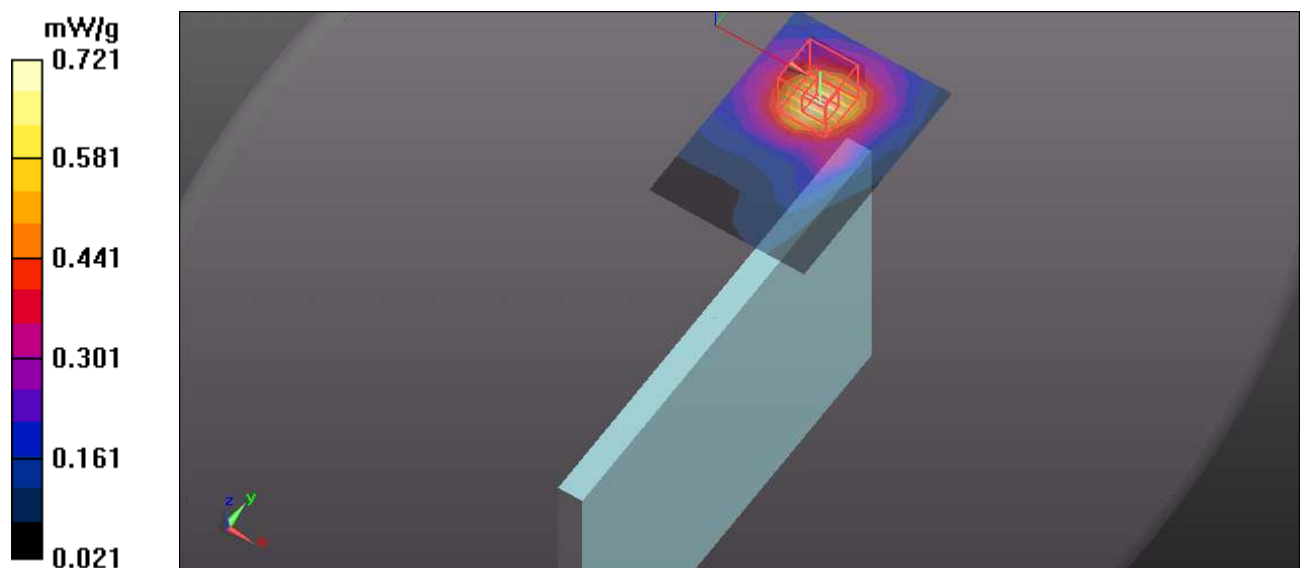

## M15-11an20\_B3-Ch116

Communication System: 802.11a ; Frequency: 5580 MHz ; Duty Cycle: 1:1 ; Modulation type: BPSK  
Medium: MSL5800 Medium parameters used:  $f = 5580$  MHz;  $\sigma = 5.78$  mho/m;  $\epsilon_r = 49.23$ ;  $\rho = 1000$  kg/m<sup>3</sup>

Phantom section: Flat Section ; Separation distance : 5 mm (The top side of the EUT to the Phantom)

DASY5 Configuration:

- Probe: EX3DV4 - SN3590; ConvF(4.16, 4.16, 4.16); Calibrated: 2010/3/25
- Sensor-Surface: 2mm (Mechanical Surface Detection)
- Electronics: DAE3 Sn510; Calibrated: 2010/10/4
- Phantom: ELI 4.0; Type: QDOVA001BA;Serial: 1043
- Measurement SW: DASY52, Version 52.6 (1); SEMCAD X Version 14.4.2 (2595)

**Flat-Section MSL/Flat Section 5mm /Area Scan (8x24x1):** Measurement grid: dx=10mm, dy=10mm

Maximum value of SAR (measured) = 0.787 mW/g

**Flat-Section MSL/Flat Section 5mm /Zoom Scan (7x7x9)/Cube 0:** Measurement grid: dx=4mm, dy=4mm, dz=2.5mm

Reference Value = 3.628 V/m; Power Drift = -0.13 dB

Peak SAR (extrapolated) = 1.425 W/kg

**SAR(1 g) = 0.453 mW/g; SAR(10 g) = 0.214 mW/g**

Maximum value of SAR (measured) = 0.790 mW/g

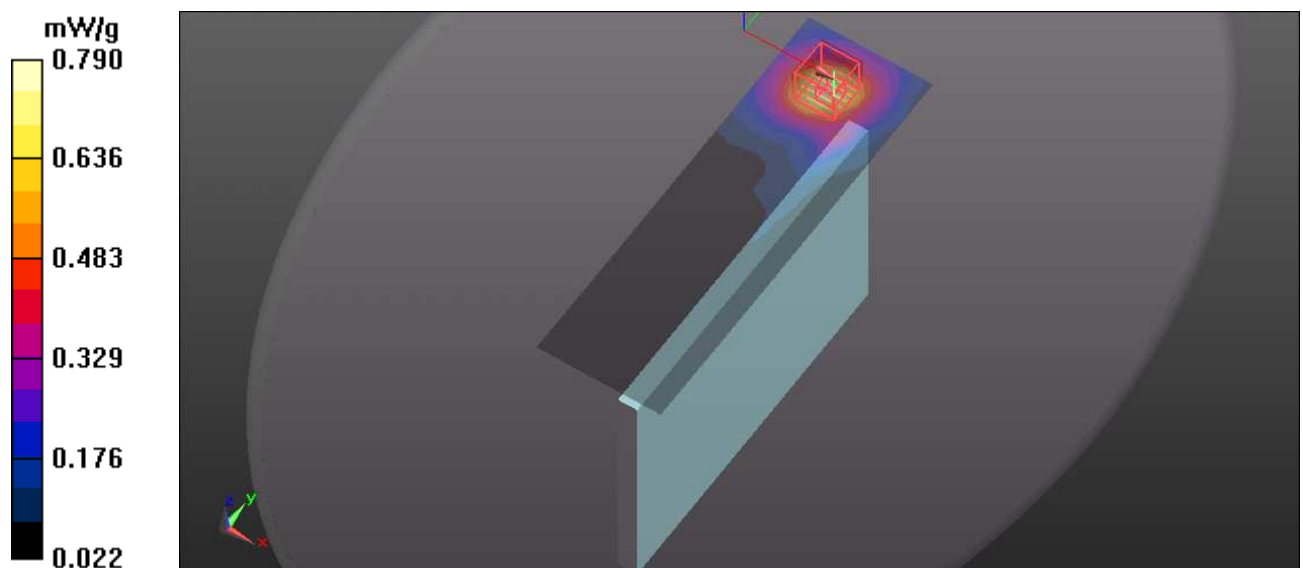

## M15-11an20\_B3-Ch124

Communication System: 802.11a ; Frequency: 5620 MHz ; Duty Cycle: 1:1 ; Modulation type: BPSK  
Medium: MSL5800 Medium parameters used:  $f = 5620$  MHz;  $\sigma = 5.85$  mho/m;  $\epsilon_r = 49.13$ ;  $\rho = 1000$  kg/m<sup>3</sup>

Phantom section: Flat Section ; Separation distance : 5 mm (The top side of the EUT to the Phantom)

DASY5 Configuration:

- Probe: EX3DV4 - SN3590; ConvF(4.16, 4.16, 4.16); Calibrated: 2010/3/25
- Sensor-Surface: 2mm (Mechanical Surface Detection)
- Electronics: DAE3 Sn510; Calibrated: 2010/10/4
- Phantom: ELI 4.0; Type: QDOVA001BA;Serial: 1043
- Measurement SW: DASY52, Version 52.6 (1); SEMCAD X Version 14.4.2 (2595)

**Flat-Section MSL/Flat Section 5mm /Area Scan (8x11x1):** Measurement grid: dx=10mm, dy=10mm

Maximum value of SAR (measured) = 0.738 mW/g

**Flat-Section MSL/Flat Section 5mm /Zoom Scan (7x7x9)/Cube 0:** Measurement grid: dx=4mm, dy=4mm, dz=2.5mm

Reference Value = 3.845 V/m; Power Drift = -0.12 dB

Peak SAR (extrapolated) = 1.330 W/kg

**SAR(1 g) = 0.413 mW/g; SAR(10 g) = 0.173 mW/g**

Maximum value of SAR (measured) = 0.750 mW/g

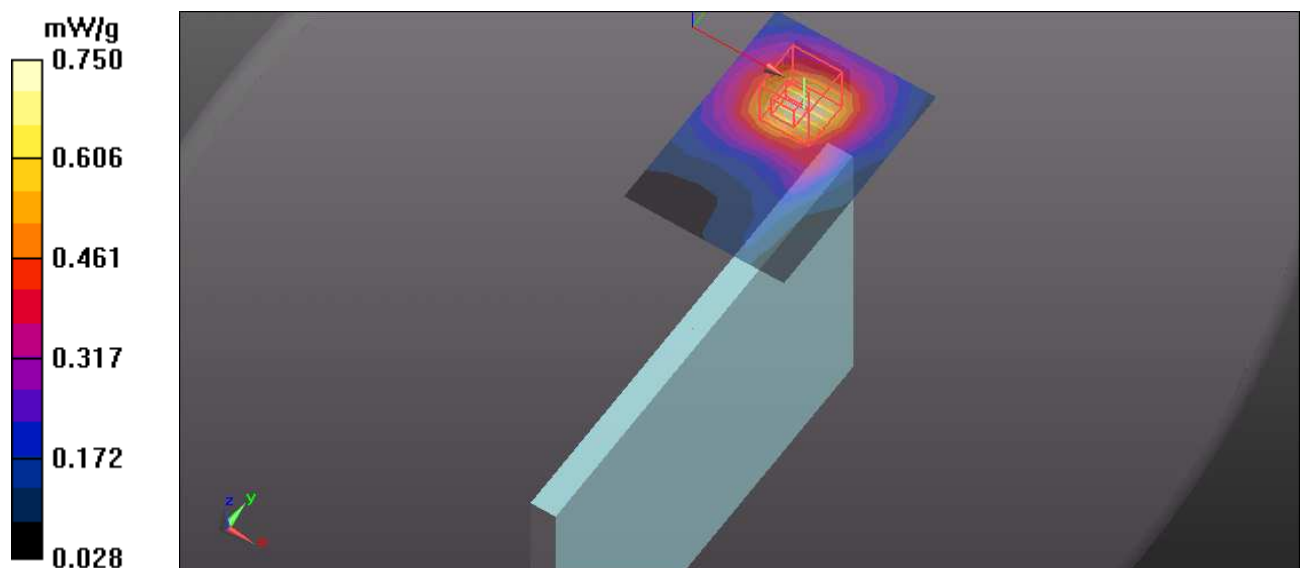

## M15-11an20\_B3-Ch136

Communication System: 802.11a ; Frequency: 5680 MHz ; Duty Cycle: 1:1 ; Modulation type: BPSK  
Medium: MSL5800 Medium parameters used:  $f = 5680$  MHz;  $\sigma = 5.93$  mho/m;  $\epsilon_r = 49.03$ ;  $\rho = 1000$  kg/m<sup>3</sup>

Phantom section: Flat Section ; Separation distance : 5 mm (The top side of the EUT to the Phantom)

DASY5 Configuration:

- Probe: EX3DV4 - SN3590; ConvF(4.16, 4.16, 4.16); Calibrated: 2010/3/25
- Sensor-Surface: 2mm (Mechanical Surface Detection)
- Electronics: DAE3 Sn510; Calibrated: 2010/10/4
- Phantom: ELI 4.0; Type: QDOVA001BA;Serial: 1043
- Measurement SW: DASY52, Version 52.6 (1); SEMCAD X Version 14.4.2 (2595)

**Flat-Section MSL/Flat Section 5mm /Area Scan (8x11x1):** Measurement grid: dx=10mm, dy=10mm

Maximum value of SAR (measured) = 0.731 mW/g

**Flat-Section MSL/Flat Section 5mm /Zoom Scan (7x7x9)/Cube 0:** Measurement grid: dx=4mm, dy=4mm, dz=2.5mm

Reference Value = 2.608 V/m; Power Drift = 0.11 dB

Peak SAR (extrapolated) = 1.461 W/kg

**SAR(1 g) = 0.430 mW/g; SAR(10 g) = 0.205 mW/g**

Maximum value of SAR (measured) = 0.747 mW/g

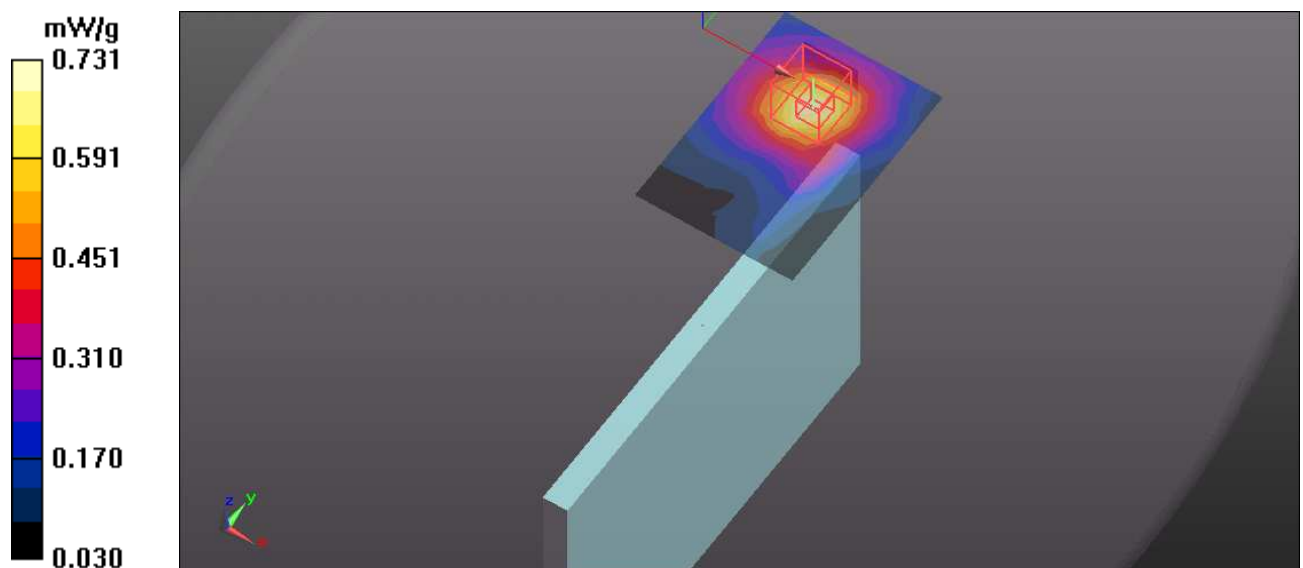

## M16-11an20\_B1-Ch40

Communication System: 5G 11n 20M ; Frequency: 5200 MHz ; Duty Cycle: 1:1 ; Modulation type: BPSK

Medium: MSL5800 Medium parameters used:  $f = 5200$  MHz;  $\sigma = 5.23$  mho/m;  $\epsilon_r = 50.03$ ;  $\rho = 1000$  kg/m<sup>3</sup>

Phantom section: Flat Section ; Separation distance : 5 mm (The right edge side of the EUT to the Phantom)

DASY5 Configuration:

- Probe: EX3DV4 - SN3590; ConvF(4.8, 4.8, 4.8); Calibrated: 2010/3/25
- Sensor-Surface: 2mm (Mechanical Surface Detection)
- Electronics: DAE3 Sn510; Calibrated: 2010/10/4
- Phantom: ELI 4.0; Type: QDOVA001BA; Serial: 1043
- Measurement SW: DASY52, Version 52.6 (1); SEMCAD X Version 14.4.2 (2595)

**Flat-Section MSL/Flat Section 5mm /Area Scan (9x5x1):** Measurement grid: dx=10mm, dy=10mm

Maximum value of SAR (measured) = 0.549 mW/g

**Flat-Section MSL/Flat Section 5mm /Zoom Scan (7x7x9)/Cube 0:** Measurement grid: dx=4mm, dy=4mm, dz=2.5mm

Reference Value = 4.334 V/m; Power Drift = -0.13 dB

Peak SAR (extrapolated) = 0.994 W/kg

**SAR(1 g) = 0.300 mW/g; SAR(10 g) = 0.117 mW/g**

Maximum value of SAR (measured) = 0.560 mW/g

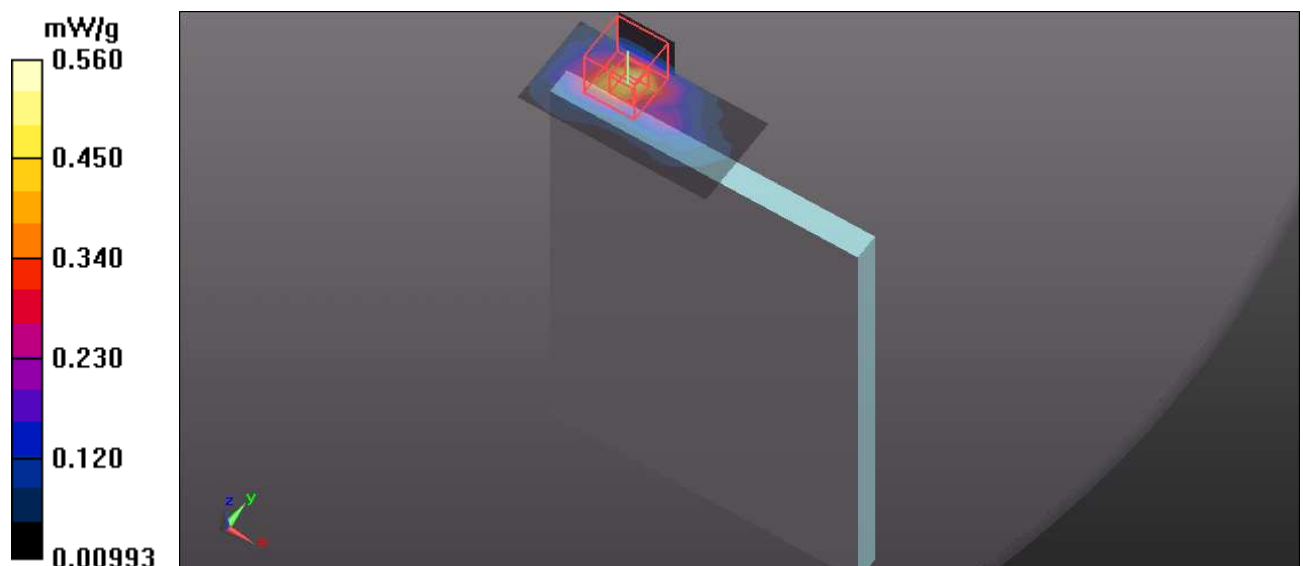

## M17-11an20\_B2-Ch60

Communication System: 5G 11n 20M ; Frequency: 5300 MHz ; Duty Cycle: 1:1 ; Modulation type: BPSK

Medium: MSL5800 Medium parameters used:  $f = 5300$  MHz;  $\sigma = 5.38$  mho/m;  $\epsilon_r = 49.83$ ;  $\rho = 1000$  kg/m<sup>3</sup>

Phantom section: Flat Section ; Separation distance : 5 mm (The right edge side of the EUT to the Phantom)

DASY5 Configuration:

- Probe: EX3DV4 - SN3590; ConvF(4.5, 4.5, 4.5); Calibrated: 2010/3/25
- Sensor-Surface: 2mm (Mechanical Surface Detection)
- Electronics: DAE3 Sn510; Calibrated: 2010/10/4
- Phantom: ELI 4.0; Type: QDOVA001BA; Serial: 1043
- Measurement SW: DASY52, Version 52.6 (1); SEMCAD X Version 14.4.2 (2595)

**Flat-Section MSL/Flat Section 5mm /Area Scan (9x5x1):** Measurement grid: dx=10mm, dy=10mm

Maximum value of SAR (measured) = 1.052 mW/g

**Flat-Section MSL/Flat Section 5mm /Zoom Scan (7x7x9)/Cube 0:** Measurement grid: dx=4mm, dy=4mm, dz=2.5mm

Reference Value = 6.453 V/m; Power Drift = 0.14 dB

Peak SAR (extrapolated) = 2.247 W/kg

**SAR(1 g) = 0.631 mW/g; SAR(10 g) = 0.229 mW/g**

Maximum value of SAR (measured) = 1.220 mW/g

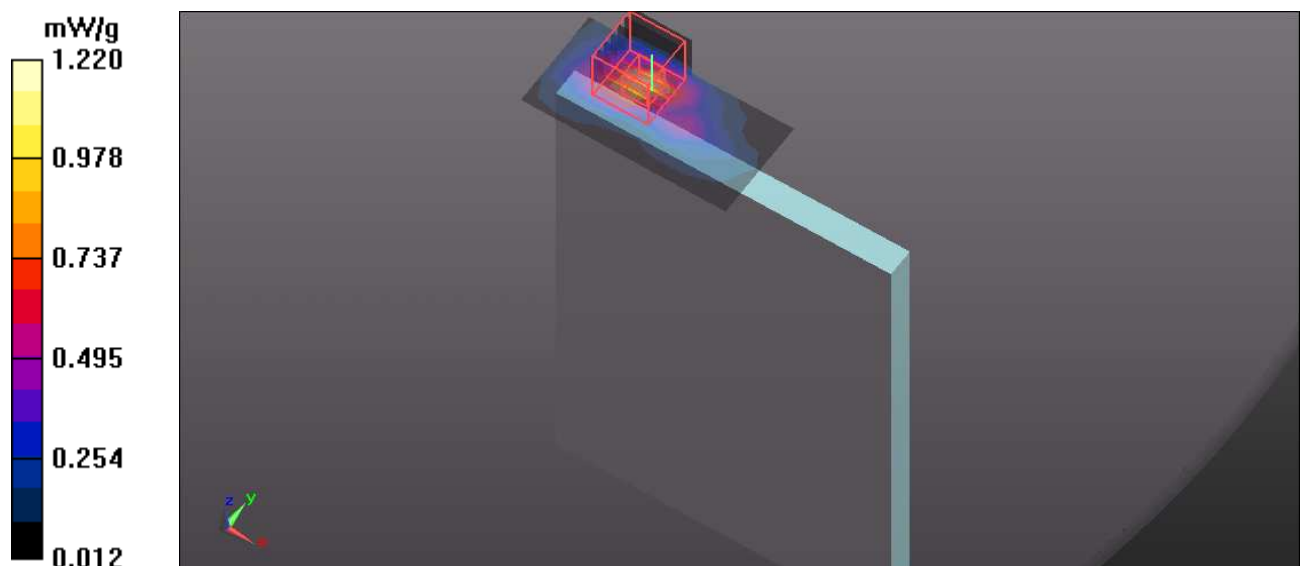



## M18-11an20\_B3-Ch104

Communication System: 5G 11n 20M ; Frequency: 5520 MHz ; Duty Cycle: 1:1 ; Modulation type: BPSK

Medium: MSL5800 Medium parameters used:  $f = 5520$  MHz;  $\sigma = 5.71$  mho/m;  $\epsilon_r = 49.33$ ;  $\rho = 1000$  kg/m<sup>3</sup>

Phantom section: Flat Section ; Separation distance : 5 mm (The right edge side of the EUT to the Phantom)

DASY5 Configuration:

- Probe: EX3DV4 - SN3590; ConvF(4.32, 4.32, 4.32); Calibrated: 2010/3/25
- Sensor-Surface: 2mm (Mechanical Surface Detection)
- Electronics: DAE3 Sn510; Calibrated: 2010/10/4
- Phantom: ELI 4.0; Type: QDOVA001BA;Serial: 1043
- Measurement SW: DASY52, Version 52.6 (1); SEMCAD X Version 14.4.2 (2595)

**Flat-Section MSL/Flat Section 5mm /Area Scan (9x5x1):** Measurement grid: dx=10mm, dy=10mm

Maximum value of SAR (measured) = 2.082 mW/g

**Flat-Section MSL/Flat Section 5mm /Zoom Scan (7x7x9)/Cube 0:** Measurement grid: dx=4mm, dy=4mm, dz=2.5mm

Reference Value = 7.944 V/m; Power Drift = -0.13 dB

Peak SAR (extrapolated) = 4.251 W/kg

**SAR(1 g) = 1.17 mW/g; SAR(10 g) = 0.425 mW/g**

Maximum value of SAR (measured) = 2.320 mW/g

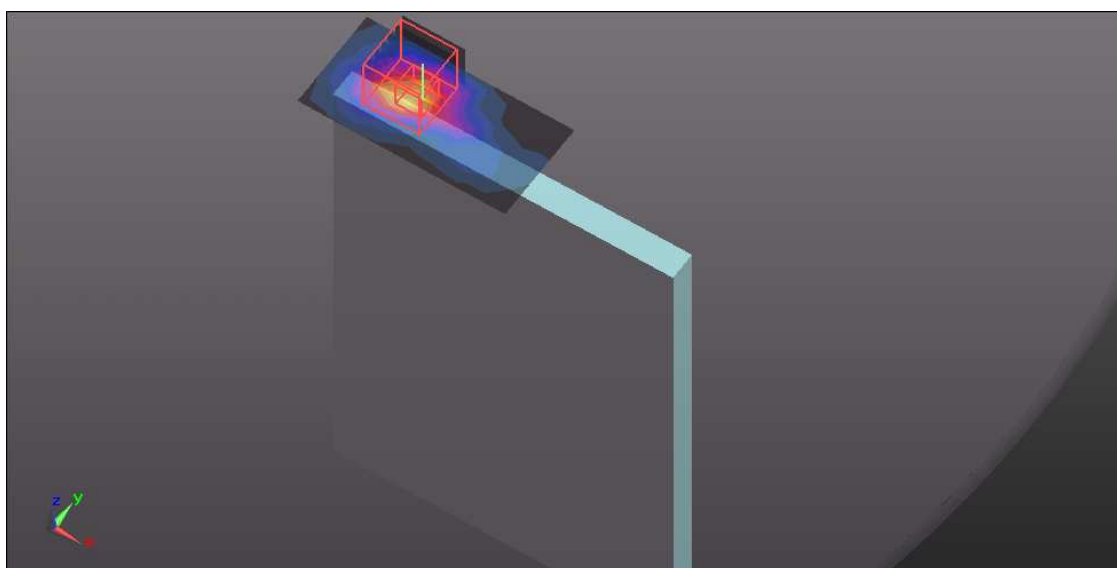
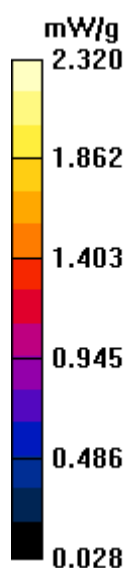

## M18-11an20\_B3-Ch116

Communication System: 5G 11n 20M ; Frequency: 5580 MHz ; Duty Cycle: 1:1 ; Modulation type: BPSK

Medium: MSL5800 Medium parameters used:  $f = 5580$  MHz;  $\sigma = 5.78$  mho/m;  $\epsilon_r = 49.23$ ;  $\rho = 1000$  kg/m<sup>3</sup>

Phantom section: Flat Section ; Separation distance : 5 mm (The right edge side of the EUT to the Phantom)

DASY5 Configuration:

- Probe: EX3DV4 - SN3590; ConvF(4.16, 4.16, 4.16); Calibrated: 2010/3/25
- Sensor-Surface: 2mm (Mechanical Surface Detection)
- Electronics: DAE3 Sn510; Calibrated: 2010/10/4
- Phantom: ELI 4.0; Type: QDOVA001BA; Serial: 1043
- Measurement SW: DASY52, Version 52.6 (1); SEMCAD X Version 14.4.2 (2595)

**Flat-Section MSL/Flat Section 5mm /Area Scan (16x5x1):** Measurement grid: dx=10mm, dy=10mm

Maximum value of SAR (measured) = 2.097 mW/g

**Flat-Section MSL/Flat Section 5mm /Zoom Scan (7x7x9)/Cube 0:** Measurement grid:

dx=4mm, dy=4mm, dz=2.5mm

Reference Value = 7.025 V/m; Power Drift = -0.11 dB

Peak SAR (extrapolated) = 4.624 W/kg

**SAR(1 g) = 1.23 mW/g; SAR(10 g) = 0.445 mW/g**

Maximum value of SAR (measured) = 2.438 mW/g

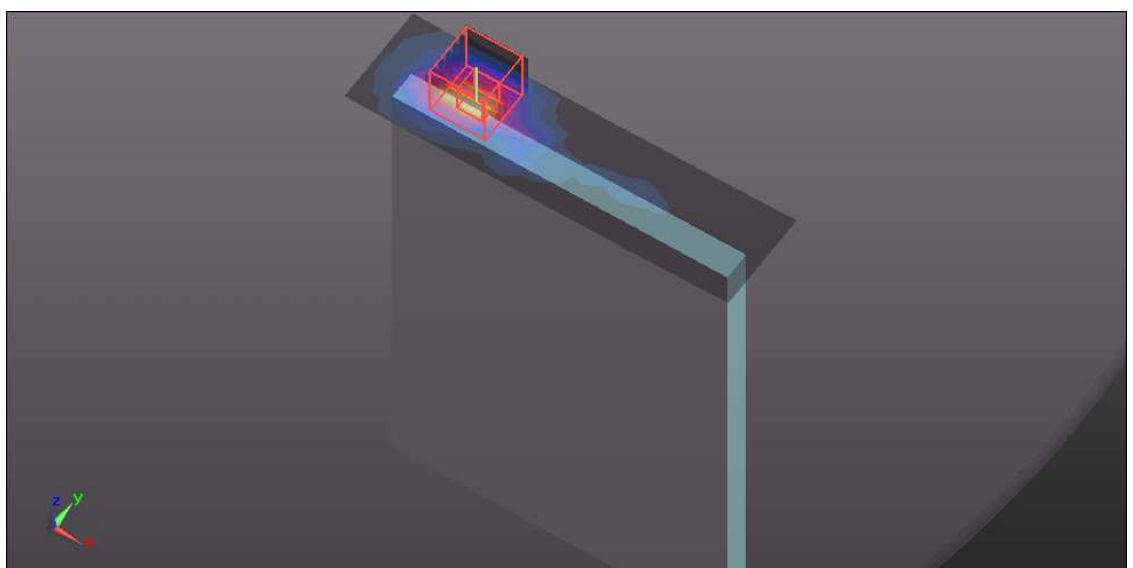
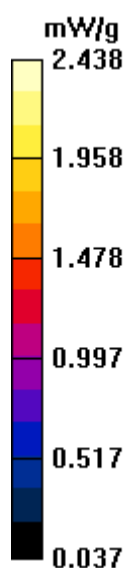

## M18-11an20\_B3-Ch124

Communication System: 5G 11n 20M ; Frequency: 5620 MHz ; Duty Cycle: 1:1 ; Modulation type: BPSK

Medium: MSL5800 Medium parameters used:  $f = 5620$  MHz;  $\sigma = 5.85$  mho/m;  $\epsilon_r = 49.13$ ;  $\rho = 1000$  kg/m<sup>3</sup>

Phantom section: Flat Section ; Separation distance : 5 mm (The right edge side of the EUT to the Phantom)

DASY5 Configuration:

- Probe: EX3DV4 - SN3590; ConvF(4.16, 4.16, 4.16); Calibrated: 2010/3/25
- Sensor-Surface: 2mm (Mechanical Surface Detection)
- Electronics: DAE3 Sn510; Calibrated: 2010/10/4
- Phantom: ELI 4.0; Type: QDOVA001BA; Serial: 1043
- Measurement SW: DASY52, Version 52.6 (1); SEMCAD X Version 14.4.2 (2595)

**Flat-Section MSL/Flat Section 5mm /Area Scan (9x5x1):** Measurement grid: dx=10mm, dy=10mm

Maximum value of SAR (measured) = 2.031 mW/g

**Flat-Section MSL/Flat Section 5mm /Zoom Scan (7x7x9)/Cube 0:** Measurement grid:

dx=4mm, dy=4mm, dz=2.5mm

Reference Value = 9.501 V/m; Power Drift = -0.14 dB

Peak SAR (extrapolated) = 4.764 W/kg

**SAR(1 g) = 1.23 mW/g; SAR(10 g) = 0.426 mW/g**

Maximum value of SAR (measured) = 2.475 mW/g

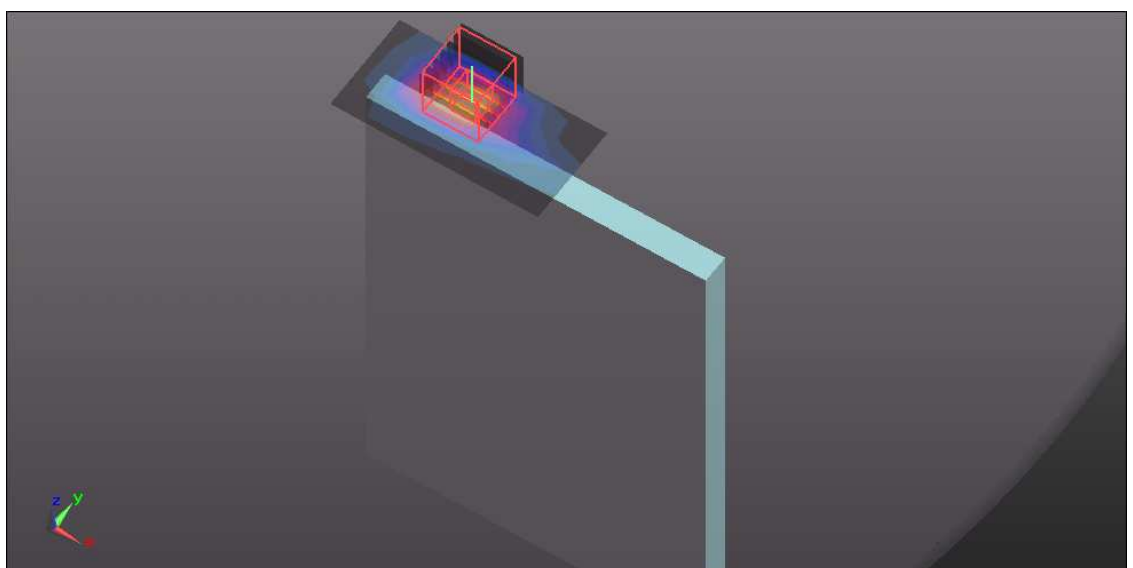
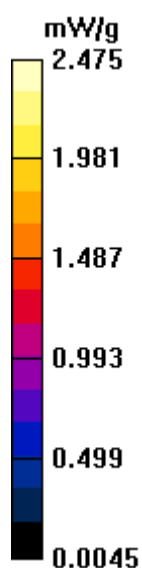

## M18-11an20\_B3-Ch136

Communication System: 5G 11n 20M ; Frequency: 5680 MHz ; Duty Cycle: 1:1 ; Modulation type: BPSK

Medium: MSL5800 Medium parameters used:  $f = 5680$  MHz;  $\sigma = 5.93$  mho/m;  $\epsilon_r = 49.03$ ;  $\rho = 1000$  kg/m<sup>3</sup>

Phantom section: Flat Section ; Separation distance : 5 mm (The right edge side of the EUT to the Phantom)

DASY5 Configuration:

- Probe: EX3DV4 - SN3590; ConvF(4.16, 4.16, 4.16); Calibrated: 2010/3/25
- Sensor-Surface: 2mm (Mechanical Surface Detection)
- Electronics: DAE3 Sn510; Calibrated: 2010/10/4
- Phantom: ELI 4.0; Type: QDOVA001BA; Serial: 1043
- Measurement SW: DASY52, Version 52.6 (1); SEMCAD X Version 14.4.2 (2595)

**Flat-Section MSL/Flat Section 5mm /Area Scan (9x5x1):** Measurement grid: dx=10mm, dy=10mm

Maximum value of SAR (measured) = 1.832 mW/g

**Flat-Section MSL/Flat Section 5mm /Zoom Scan (7x7x9)/Cube 0:** Measurement grid:

dx=4mm, dy=4mm, dz=2.5mm

Reference Value = 7.251 V/m; Power Drift = 0.07 dB

Peak SAR (extrapolated) = 4.387 W/kg

**SAR(1 g) = 1.1 mW/g; SAR(10 g) = 0.383 mW/g**

Maximum value of SAR (measured) = 2.251 mW/g

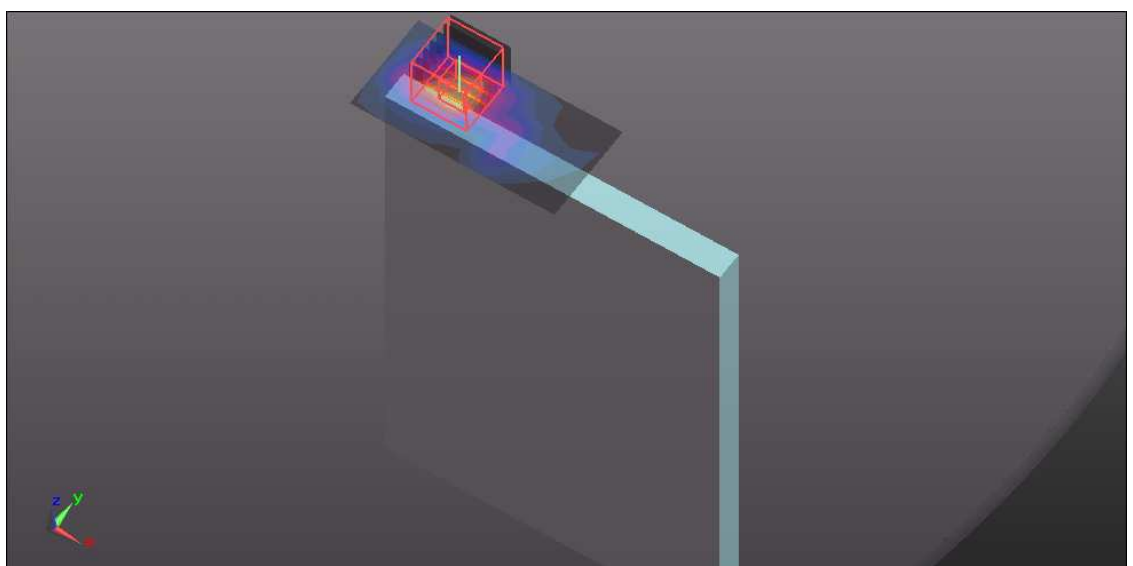
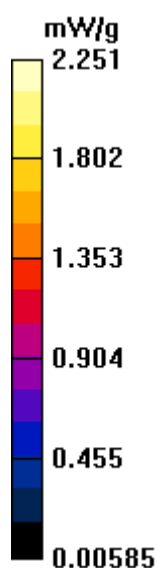

## SystemPerformanceCheck-D5GHz-uniform-MSL5200 MHz

**DUT: Dipole D5GHzV2 ; Type: D5GHzV2 ; Serial: D5GHzV2 - SN:1019 ; Test Frequency: 5200 MHz**

Communication System: CW-5GHz ; Frequency: 5200 MHz; Duty Cycle: 1:1; Modulation type: CW  
Medium: MSL5800;Medium parameters used:  $f = 5200$  MHz;  $\sigma = 5.21$  mho/m;  $\epsilon_r = 50.16$ ;  $\rho = 1000$  kg/m<sup>3</sup> ; Liquid level : 150 mm

Phantom section: Flat Section ; Separation distance : 10 mm (The feet point of the dipole to the Phantom)Air temp. : 23 degrees ; Liquid temp. : 22.1 degrees

DASY5 Configuration:

- Probe: EX3DV4 - SN3590; ConvF(4.8, 4.8, 4.8); Calibrated: 2010/3/25
- Sensor-Surface: 2mm (Mechanical Surface Detection)
- Electronics: DAE3 Sn510; Calibrated: 2010/10/4
- Phantom: ELI 4.0; Type: QDOVA001BA; Serial: 1043
- Measurement SW: DASY52, Version 52.6 (1); SEMCAD X Version 14.4.2 (2595)

**System Performance Check with D5GHzV2 Dipole (uniform grid)/d=10mm, Pin=100mW, f=5200 MHz/Area Scan (10x10x1):** Measurement grid: dx=10mm, dy=10mm  
Maximum value of SAR (measured) = 10.104 mW/g

**System Performance Check with D5GHzV2 Dipole (uniform grid)/d=10mm, Pin=100mW, f=5200 MHz/Zoom Scan (4x4x2.5mm), dist=2mm (8x8x10)/Cube 0:**  
Measurement grid: dx=4mm, dy=4mm, dz=2.5mm  
Reference Value = 62.438 V/m; Power Drift = -0.19 dB  
Peak SAR (extrapolated) = 44.217 W/kg  
**SAR(1 g) = 8.03 mW/g; SAR(10 g) = 2.18 mW/g**  
Maximum value of SAR (measured) = 8.013 mW/g

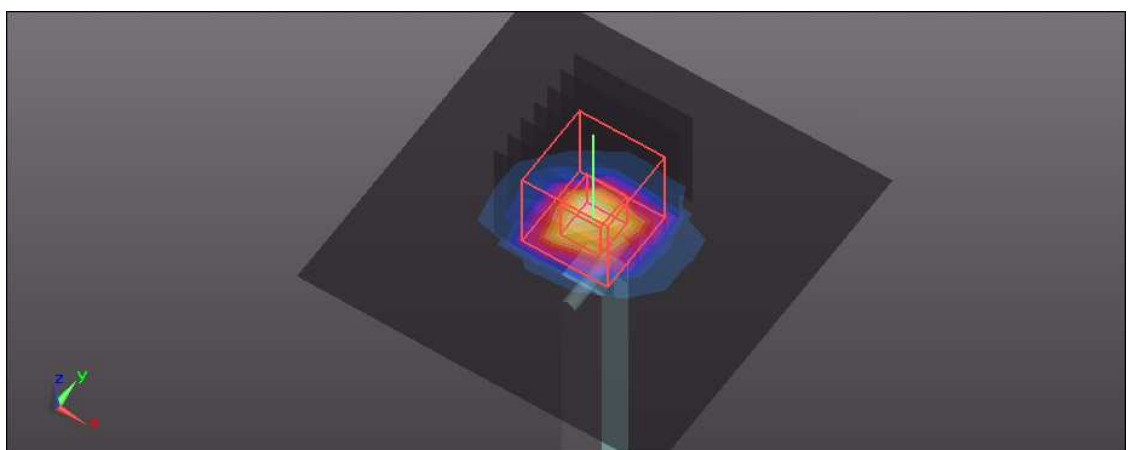
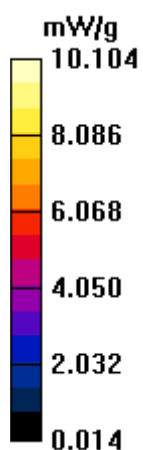

## SystemPerformanceCheck-D5GHz-uniform-MSL5500 MHz

**DUT: Dipole D5GHzV2 ; Type: D5GHzV2 ; Serial: D5GHzV2 - SN:1019 ; Test Frequency: 5500 MHz**

Communication System: CW-5GHz ; Frequency: 5500 MHz; Duty Cycle: 1:1; Modulation type: CW  
Medium: MSL5800;Medium parameters used:  $f = 5500$  MHz;  $\sigma = 5.68$  mho/m;  $\epsilon_r = 49.76$ ;  $\rho = 1000$  kg/m<sup>3</sup> ; Liquid level : 150 mm

Phantom section: Flat Section ; Separation distance : 10 mm (The feet point of the dipole to the Phantom)Air temp. : 23 degrees ; Liquid temp. : 22.1 degrees

DASY5 Configuration:

- Probe: EX3DV4 - SN3590; ConvF(4.32, 4.32, 4.32); Calibrated: 2010/3/25
- Sensor-Surface: 2mm (Mechanical Surface Detection)
- Electronics: DAE3 Sn510; Calibrated: 2010/10/4
- Phantom: ELI 4.0; Type: QDOVA001BA; Serial: 1043
- Measurement SW: DASY52, Version 52.6 (1); SEMCAD X Version 14.4.2 (2595)

**System Performance Check with D5GHzV2 Dipole (uniform grid)/d=10mm, Pin=100mW, f=5500 MHz/Area Scan (10x10x1):** Measurement grid: dx=10mm, dy=10mm  
Maximum value of SAR (measured) = 9.406 mW/g

**System Performance Check with D5GHzV2 Dipole (uniform grid)/d=10mm, Pin=100mW, f=5500 MHz/Zoom Scan (4x4x2.5mm), dist=2mm (8x8x10)/Cube 0:**  
Measurement grid: dx=4mm, dy=4mm, dz=2.5mm  
Reference Value = 57.578 V/m; Power Drift = 0.08 dB  
Peak SAR (extrapolated) = 53.038 W/kg  
**SAR(1 g) = 8.23 mW/g; SAR(10 g) = 2.24 mW/g**  
Maximum value of SAR (measured) = 7.426 mW/g

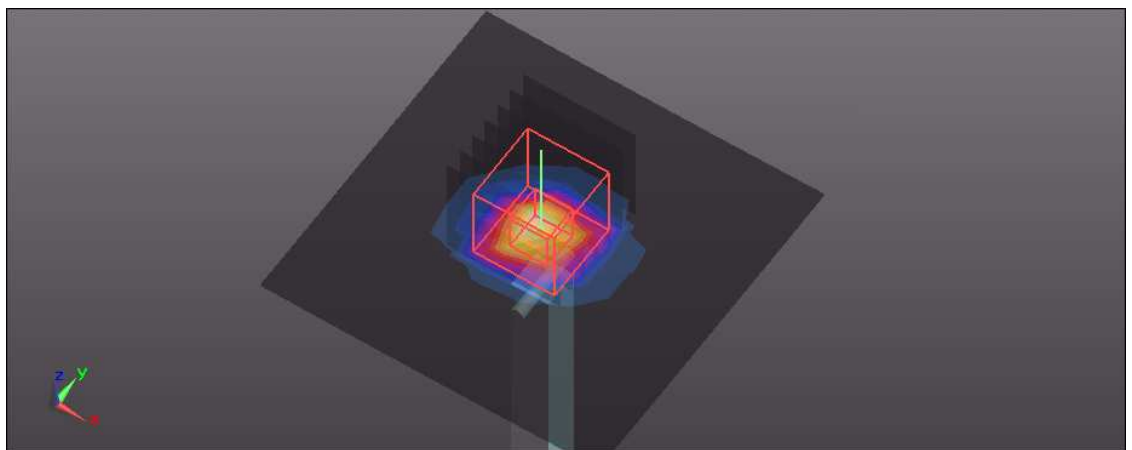
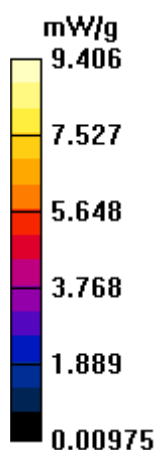

## SystemPerformanceCheck-D5GHz-uniform-MSL5200 MHz

**DUT: Dipole D5GHzV2 ; Type: D5GHzV2 ; Serial: D5GHzV2 - SN:1019 ; Test Frequency: 5200 MHz**

Communication System: CW-5GHz ; Frequency: 5200 MHz; Duty Cycle: 1:1; Modulation type: CW  
Medium: MSL5800;Medium parameters used:  $f = 5200$  MHz;  $\sigma = 5.23$  mho/m;  $\epsilon_r = 50.03$ ;  $\rho = 1000$  kg/m<sup>3</sup> ; Liquid level : 150 mm

Phantom section: Flat Section ; Separation distance : 10 mm (The feet point of the dipole to the Phantom)Air temp. : 22.7 degrees ; Liquid temp. : 21.8 degrees

DASY5 Configuration:

- Probe: EX3DV4 - SN3590; ConvF(4.8, 4.8, 4.8); Calibrated: 2010/3/25
- Sensor-Surface: 2mm (Mechanical Surface Detection)
- Electronics: DAE3 Sn510; Calibrated: 2010/10/4
- Phantom: ELI 4.0; Type: QDOVA001BA; Serial: 1043
- Measurement SW: DASY52, Version 52.6 (1); SEMCAD X Version 14.4.2 (2595)

**System Performance Check with D5GHzV2 Dipole (uniform grid)/d=10mm, Pin=100mW, f=5200 MHz/Area Scan (10x10x1):** Measurement grid: dx=10mm, dy=10mm  
Maximum value of SAR (measured) = 9.976 mW/g

**System Performance Check with D5GHzV2 Dipole (uniform grid)/d=10mm, Pin=100mW, f=5200 MHz/Zoom Scan (4x4x2.5mm), dist=2mm (8x8x10)/Cube 0:**  
Measurement grid: dx=4mm, dy=4mm, dz=2.5mm  
Reference Value = 60.636 V/m; Power Drift = -0.15 dB  
Peak SAR (extrapolated) = 42.542 W/kg  
**SAR(1 g) = 8.15 mW/g; SAR(10 g) = 2.23 mW/g**  
Maximum value of SAR (measured) = 8.384 mW/g

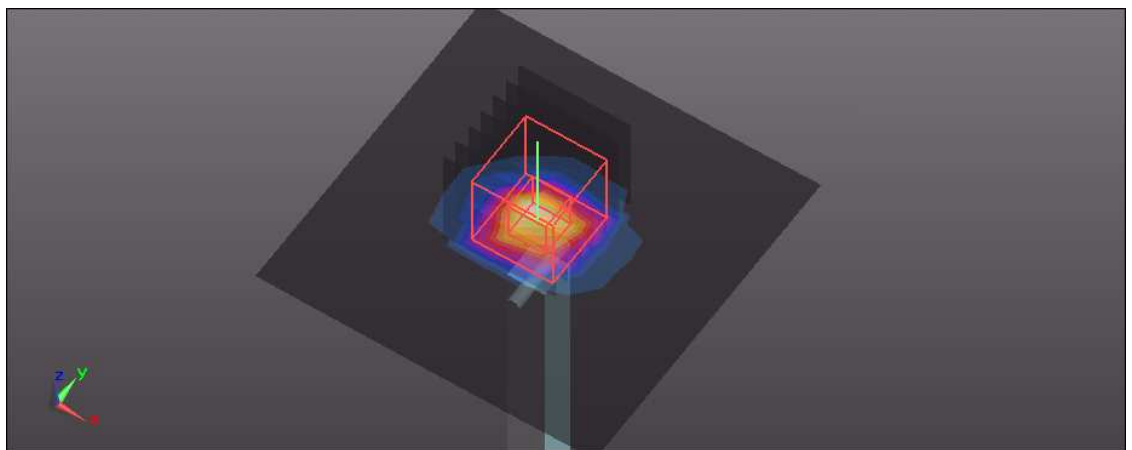
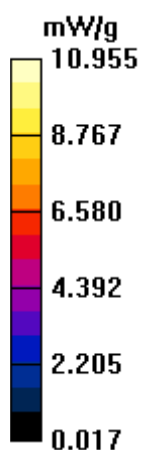

## System Performance Check-D5GHz-uniform-MSL5500 MHz

DUT: Dipole D5GHzV2 ; Type: D5GHzV2 ; Serial: D5GHzV2 - SN:1019 ; Test Frequency: 5500 MHz

Communication System: CW-5GHz ; Frequency: 5500 MHz; Duty Cycle: 1:1; Modulation type: CW  
Medium: MSL5800; Medium parameters used:  $f = 5500$  MHz;  $\sigma = 5.7$  mho/m;  $\epsilon_r = 49.63$ ;  $\rho = 1000$  kg/m<sup>3</sup> ; Liquid level : 150 mm

Phantom section: Flat Section ; Separation distance : 10 mm (The feet point of the dipole to the Phantom) Air temp. : 22.7 degrees ; Liquid temp. : 21.8 degrees

DASY5 Configuration:

- Probe: EX3DV4 - SN3590; ConvF(4.32, 4.32, 4.32); Calibrated: 2010/3/25
- Sensor-Surface: 2mm (Mechanical Surface Detection)
- Electronics: DAE3 Sn510; Calibrated: 2010/10/4
- Phantom: ELI 4.0; Type: QDOVA001BA; Serial: 1043
- Measurement SW: DASY52, Version 52.6 (1); SEMCAD X Version 14.4.2 (2595)

## System Performance Check with D5GHzV2 Dipole (uniform grid)/d=10mm,

**Pin=100mW, f=5500 MHz/Area Scan (10x10x1):** Measurement grid: dx=10mm, dy=10mm  
Maximum value of SAR (measured) = 9.304 mW/g

## System Performance Check with D5GHzV2 Dipole (uniform grid)/d=10mm,

**Pin=100mW, f=5500 MHz/Zoom Scan (4x4x2.5mm), dist=2mm (8x8x10)/Cube 0:**

Measurement grid: dx=4mm, dy=4mm, dz=2.5mm

Reference Value = 59.120 V/m; Power Drift = -0.14 dB

Peak SAR (extrapolated) = 51.437 W/kg

**SAR(1 g) = 8.17 mW/g; SAR(10 g) = 2.21 mW/g**

Maximum value of SAR (measured) = 7.668 mW/g

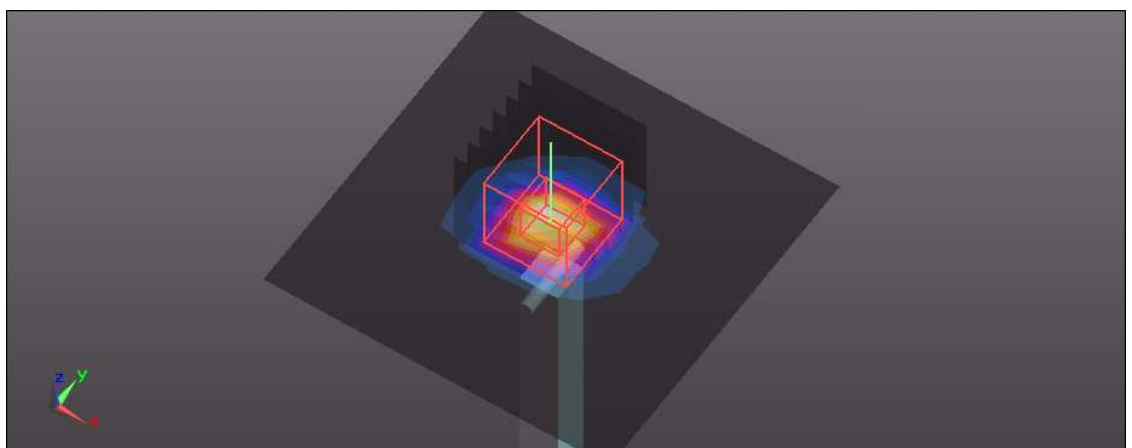
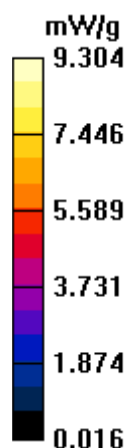



## APPENDIX B: BV ADT SAR MEASUREMENT SYSTEM

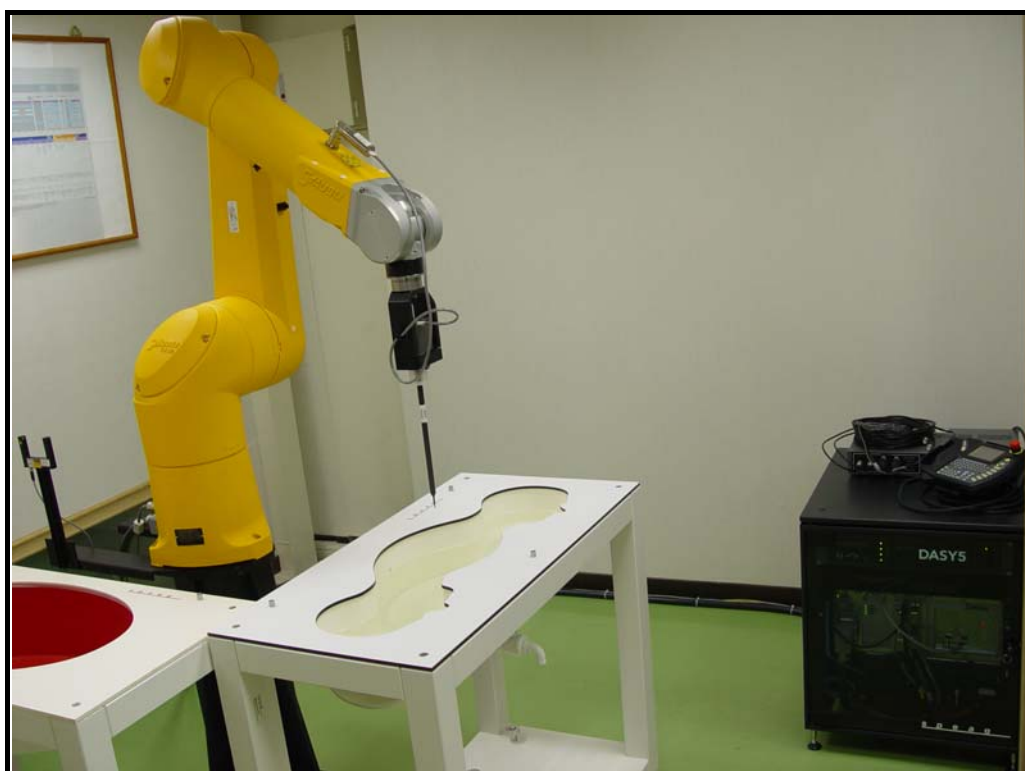

## APPENDIX C: PHOTOGRAPHS OF SYSTEM VALIDATION





## **APPENDIX D: SYSTEM CERTIFICATE & CALIBRATION**

### **D1: PHANTOM**

**Certificate of Conformity / First Article Inspection**

Item	Oval Flat Phantom ELI 4.0
Type No	QD OVA 001 B
Series No	1003 and higher
Manufacturer	SPEAG Zeughausstrasse 43 CH-8004 Zürich Switzerland

**Tests**

Complete tests were made on the prototype units QD OVA 001 AA 1001, QD OVA 001 AB 1002, pre-series units QD OVA 001 BA 1003-1005 as well as on the series units QD OVA 001 BB, 1006 ff.

Test	Requirement	Details	Units tested
Dimensions	Compliant with the standard IEC 62209 – 2 [1] requirements	Dimensions of bottom for 300 MHz – 6 GHz: longitudinal = 600 mm (max. dimension) width = 400 mm (min dimension) depth = 190 mm Shape: ellipse	Prototypes, Samples
Material thickness	Compliant with the standard IEC 62209 – 2 [1] requirements	Bottom plate: 2.0mm +/- 0.2mm	Prototypes, All items
Material parameters	Dielectric parameters for required frequencies	300 MHz – 6 GHz Rel. permittivity = 4 +/-1, Loss tangent ≤ 0.05	Material sample
Material resistivity	The material has been tested to be compatible with the liquids defined in the standards if handled and cleaned according to the instructions. Observe Technical Note for material compatibility.	DEGMBE based simulating liquids	Equivalent phantoms, Material sample
Sagging	Compliant with the requirements according to the standard. Sagging of the flat section when filled with tissue simulating liquid	< 1% typical < 0.8% if filled with 155mm of HSL900 and without DUT below	Prototypes, Sample testing

**Standards**

- [1] IEC 62209 – 2, Draft Version 0.9, "Evaluation of Human Exposure to Radio Frequency Fields from Handheld and Body-Mounted Wireless Communication Devices in the Frequency Range of 30 MHz to 6 GHz: Human models, Instrumentation and Procedures Part 2: Procedure to determine the Specific Absorption Rate (SAR) for ... including accessories and multiple transmitters", December 2004

**Conformity**

Based on the sample tests above, we certify that this item is in compliance with the standard [1].

Date

07.07.2005

**s p e a g**

Signature / Stamp

Schmid & Partner Engineering AG  
Zeughausstrasse 43, 8004 Zurich, Switzerland  
Phone +41 1 245 9700, Fax +41 1 245 9779  
info@speag.com, http://www.speag.com



## D2: DOSIMETRIC E-FIELD PROBE



Accredited by the Swiss Accreditation Service (SAS)  
The Swiss Accreditation Service is one of the signatories to the EA  
Multilateral Agreement for the recognition of calibration certificates

Accreditation No.: **SCS 108**

Client **BV-ADT (Auden)**

Certificate No: **EX3-3590\_Mar10**

## CALIBRATION CERTIFICATE

Object **EX3DV4 - SN:3590**

Calibration procedure(s) **QA CAL-01.v6, QA CAL-14.v3, QA CAL-23.v3 and QA CAL-25.v2  
Calibration procedure for dosimetric E-field probes**

Calibration date: **March 25, 2010**

This calibration certificate documents the traceability to national standards, which realize the physical units of measurements (SI).  
The measurements and the uncertainties with confidence probability are given on the following pages and are part of the certificate.

All calibrations have been conducted in the closed laboratory facility: environment temperature (22 ± 3)°C and humidity < 70%.

Calibration Equipment used (M&TE critical for calibration)

Primary Standards	ID #	Cal Date (Certificate No.)	Scheduled Calibration
Power meter E4419B	GB41293874	1-Apr-09 (No. 217-01030)	Apr-10
Power sensor E4412A	MY41495277	1-Apr-09 (No. 217-01030)	Apr-10
Power sensor E4412A	MY41498087	1-Apr-09 (No. 217-01030)	Apr-10
Reference 3 dB Attenuator	SN: S5054 (3c)	31-Mar-09 (No. 217-01026)	Mar-10
Reference 20 dB Attenuator	SN: S5086 (20b)	31-Mar-09 (No. 217-01028)	Mar-10
Reference 30 dB Attenuator	SN: S5129 (30b)	31-Mar-09 (No. 217-01027)	Mar-10
Reference Probe ES3DV2	SN: 3013	30-Dec-09 (No. ES3-3013_Dec09)	Dec-10
DAE4	SN: 660	29-Sep-09 (No. DAE4-660_Sep09)	Sep-10

Secondary Standards	ID #	Check Date (in house)	Scheduled Check
RF generator HP 8648C	US3642U01700	4-Aug-99 (in house check Oct-09)	In house check: Oct-11
Network Analyzer HP 8753E	US37390585	18-Oct-01 (in house check Oct-09)	In house check: Oct10

	Name	Function	Signature
Calibrated by:	Katja Pokovic	Technical Manager	
Approved by:	Niels Kuster	Quality Manager	

Issued: March 25, 2010

This calibration certificate shall not be reproduced except in full without written approval of the laboratory.



Accredited by the Swiss Accreditation Service (SAS)  
The Swiss Accreditation Service is one of the signatories to the EA  
Multilateral Agreement for the recognition of calibration certificates

Accreditation No.: **SCS 108**

### Glossary:

TSL	tissue simulating liquid
NORM <sub>x,y,z</sub>	sensitivity in free space
ConvF	sensitivity in TSL / NORM <sub>x,y,z</sub>
DCP	diode compression point
CF	crest factor (1/duty_cycle) of the RF signal
A, B, C	modulation dependent linearization parameters
Polarization $\varphi$	$\varphi$ rotation around probe axis
Polarization $\vartheta$	$\vartheta$ rotation around an axis that is in the plane normal to probe axis (at measurement center), i.e., $\vartheta = 0$ is normal to probe axis

### Calibration is Performed According to the Following Standards:

- IEEE Std 1528-2003, "IEEE Recommended Practice for Determining the Peak Spatial-Averaged Specific Absorption Rate (SAR) in the Human Head from Wireless Communications Devices: Measurement Techniques", December 2003
- IEC 62209-1, "Procedure to measure the Specific Absorption Rate (SAR) for hand-held devices used in close proximity to the ear (frequency range of 300 MHz to 3 GHz)", February 2005

### Methods Applied and Interpretation of Parameters:

- NORM<sub>x,y,z</sub>**: Assessed for E-field polarization  $\vartheta = 0$  ( $f \leq 900$  MHz in TEM-cell;  $f > 1800$  MHz: R22 waveguide). NORM<sub>x,y,z</sub> are only intermediate values, i.e., the uncertainties of NORM<sub>x,y,z</sub> does not effect the  $E^2$ -field uncertainty inside TSL (see below *ConvF*).
- NORM(f)<sub>x,y,z</sub>** = NORM<sub>x,y,z</sub> \* *frequency\_response* (see Frequency Response Chart). This linearization is implemented in DASY4 software versions later than 4.2. The uncertainty of the frequency response is included in the stated uncertainty of *ConvF*.
- DCP<sub>x,y,z</sub>**: DCP are numerical linearization parameters assessed based on the data of power sweep with CW signal (no uncertainty required). DCP does not depend on frequency nor media.
- A<sub>x,y,z</sub>; B<sub>x,y,z</sub>; C<sub>x,y,z</sub>; VR<sub>x,y,z</sub>; A, B, C** are numerical linearization parameters assessed based on the data of power sweep for specific modulation signal. The parameters do not depend on frequency nor media. VR is the maximum calibration range expressed in RMS voltage across the diode.
- ConvF and Boundary Effect Parameters**: Assessed in flat phantom using E-field (or Temperature Transfer Standard for  $f \leq 800$  MHz) and inside waveguide using analytical field distributions based on power measurements for  $f > 800$  MHz. The same setups are used for assessment of the parameters applied for boundary compensation (alpha, depth) of which typical uncertainty values are given. These parameters are used in DASY4 software to improve probe accuracy close to the boundary. The sensitivity in TSL corresponds to NORM<sub>x,y,z</sub> \* ConvF whereby the uncertainty corresponds to that given for ConvF. A frequency dependent ConvF is used in DASY version 4.4 and higher which allows extending the validity from  $\pm 50$  MHz to  $\pm 100$  MHz.
- Spherical isotropy (3D deviation from isotropy)**: in a field of low gradients realized using a flat phantom exposed by a patch antenna.
- Sensor Offset**: The sensor offset corresponds to the offset of virtual measurement center from the probe tip (on probe axis). No tolerance required.

# Probe EX3DV4

## SN:3590

Manufactured:	March 23, 2009
Last calibrated:	April 28, 2009
Recalibrated:	March 25, 2010

Calibrated for DASY Systems

(Note: non-compatible with DASY2 system!)



**DASY - Parameters of Probe: EX3DV4 SN:3590****Basic Calibration Parameters**

	Sensor X	Sensor Y	Sensor Z	Unc (k=2)
Norm ( $\mu\text{V}/(\text{V}/\text{m})^2$ ) <sup>A</sup>	0.49	0.49	0.50	± 10.1%
DCP (mV) <sup>B</sup>	88.1	87.5	87.6	

**Modulation Calibration Parameters**

UID	Communication System Name	PAR		A dB	B dBuV	C	VR mV	Unc <sup>E</sup> (k=2)
10000	CW	0.00	X	0.00	0.00	1.00	300	± 1.5%
			Y	0.00	0.00	1.00	300	
			Z	0.00	0.00	1.00	300	

The reported uncertainty of measurement is stated as the standard uncertainty of measurement multiplied by the coverage factor k=2, which for a normal distribution corresponds to a coverage probability of approximately 95%.

<sup>A</sup> The uncertainties of NormX,Y,Z do not affect the E<sup>2</sup>-field uncertainty inside TSL (see Pages 5 and 6).

<sup>B</sup> Numerical linearization parameter: uncertainty not required.

<sup>E</sup> Uncertainty is determined using the maximum deviation from linear response applying rectangular distribution and is expressed for the square of the field value.

## DASY - Parameters of Probe: EX3DV4 SN:3590

### Calibration Parameter Determined in Head Tissue Simulating Media

f [MHz]	Validity [MHz] <sup>c</sup>	Permittivity	Conductivity	ConvF X	ConvF Y	ConvF Z	Alpha	Depth Unc (k=2)
900	± 50 / ± 100	41.5 ± 5%	0.97 ± 5%	10.25	10.25	10.25	0.74	0.61 ± 11.0%
1750	± 50 / ± 100	40.1 ± 5%	1.37 ± 5%	8.89	8.89	8.89	0.76	0.58 ± 11.0%
1950	± 50 / ± 100	40.0 ± 5%	1.40 ± 5%	8.33	8.33	8.33	0.62	0.64 ± 11.0%
2450	± 50 / ± 100	39.2 ± 5%	1.80 ± 5%	7.90	7.90	7.90	0.36	0.84 ± 11.0%
2600	± 50 / ± 100	39.0 ± 5%	1.96 ± 5%	7.79	7.79	7.79	0.19	1.32 ± 11.0%
5200	± 50 / ± 100	36.0 ± 5%	4.66 ± 5%	5.30	5.30	5.30	0.40	1.90 ± 13.1%
5300	± 50 / ± 100	35.9 ± 5%	4.76 ± 5%	4.92	4.92	4.92	0.45	1.90 ± 13.1%
5500	± 50 / ± 100	35.6 ± 5%	4.96 ± 5%	4.93	4.93	4.93	0.45	1.90 ± 13.1%
5600	± 50 / ± 100	35.5 ± 5%	5.07 ± 5%	4.63	4.63	4.63	0.50	1.90 ± 13.1%
5800	± 50 / ± 100	35.3 ± 5%	5.27 ± 5%	4.54	4.54	4.54	0.50	1.90 ± 13.1%

<sup>c</sup> The validity of ± 100 MHz only applies for DASY v4.4 and higher (see Page 2). The uncertainty is the RSS of the ConvF uncertainty at calibration frequency and the uncertainty for the indicated frequency band.

## DASY - Parameters of Probe: EX3DV4 SN:3590

### Calibration Parameter Determined in Body Tissue Simulating Media

f [MHz]	Validity [MHz] <sup>c</sup>	Permittivity	Conductivity	ConvF X	ConvF Y	ConvF Z	Alpha	Depth Unc (k=2)
900	± 50 / ± 100	55.0 ± 5%	1.05 ± 5%	10.20	10.20	10.20	0.60	0.71 ± 11.0%
1750	± 50 / ± 100	53.4 ± 5%	1.49 ± 5%	8.69	8.69	8.69	0.79	0.58 ± 11.0%
1950	± 50 / ± 100	53.3 ± 5%	1.52 ± 5%	8.61	8.61	8.61	0.40	0.80 ± 11.0%
2450	± 50 / ± 100	52.7 ± 5%	1.95 ± 5%	8.20	8.20	8.20	0.28	1.02 ± 11.0%
2600	± 50 / ± 100	52.5 ± 5%	2.16 ± 5%	8.04	8.04	8.04	0.21	1.25 ± 11.0%
5200	± 50 / ± 100	49.0 ± 5%	5.30 ± 5%	4.80	4.80	4.80	0.53	1.95 ± 13.1%
5300	± 50 / ± 100	48.5 ± 5%	5.42 ± 5%	4.50	4.50	4.50	0.53	1.95 ± 13.1%
5500	± 50 / ± 100	48.6 ± 5%	5.65 ± 5%	4.32	4.32	4.32	0.55	1.95 ± 13.1%
5600	± 50 / ± 100	48.5 ± 5%	5.77 ± 5%	4.16	4.16	4.16	0.50	1.95 ± 13.1%
5800	± 50 / ± 100	48.2 ± 5%	6.00 ± 5%	4.41	4.41	4.41	0.60	1.95 ± 13.1%

<sup>c</sup> The validity of ± 100 MHz only applies for DASY v4.4 and higher (see Page 2). The uncertainty is the RSS of the ConvF uncertainty at calibration frequency and the uncertainty for the indicated frequency band.

# Frequency Response of E-Field

(TEM-Cell:ifi110 EXX, Waveguide: R22)

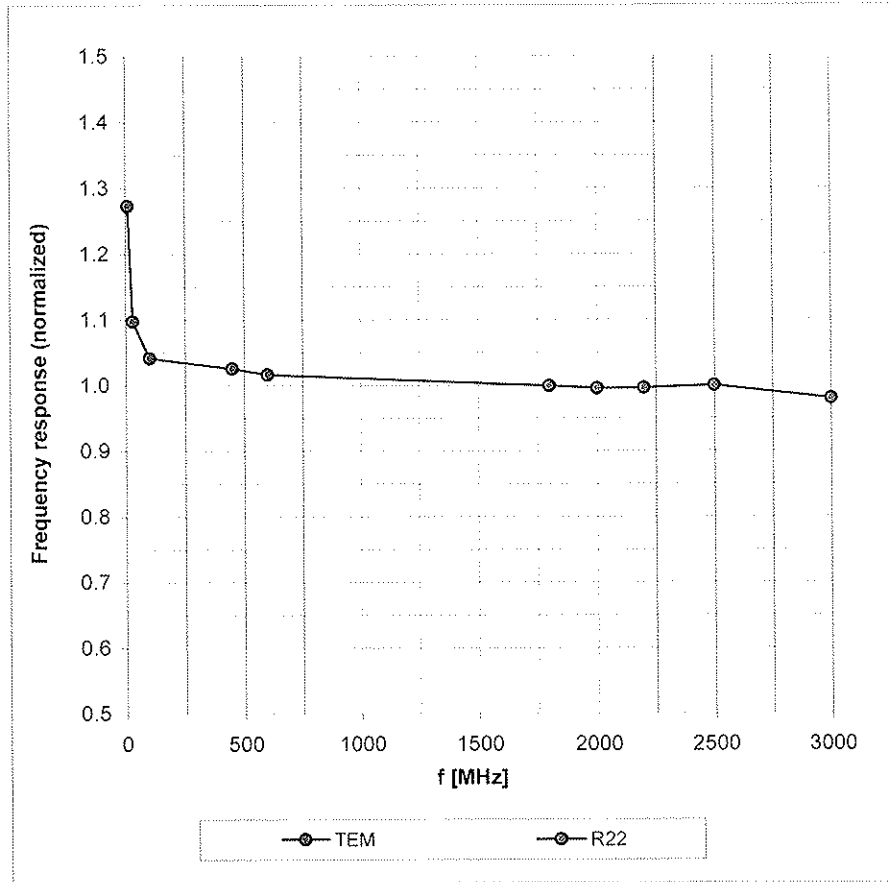

Uncertainty of Frequency Response of E-field:  $\pm 6.3\%$  (k=2)

### Receiving Pattern ( $\phi$ ), $\vartheta = 0^\circ$

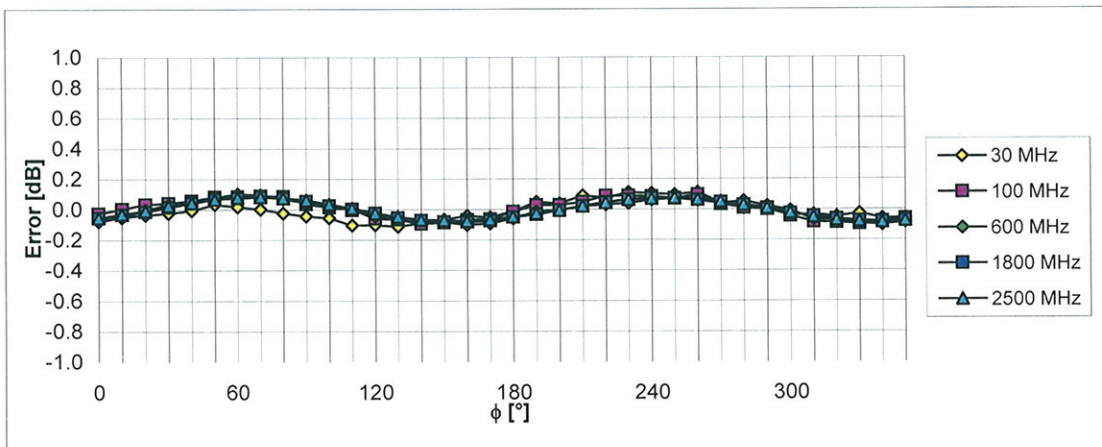
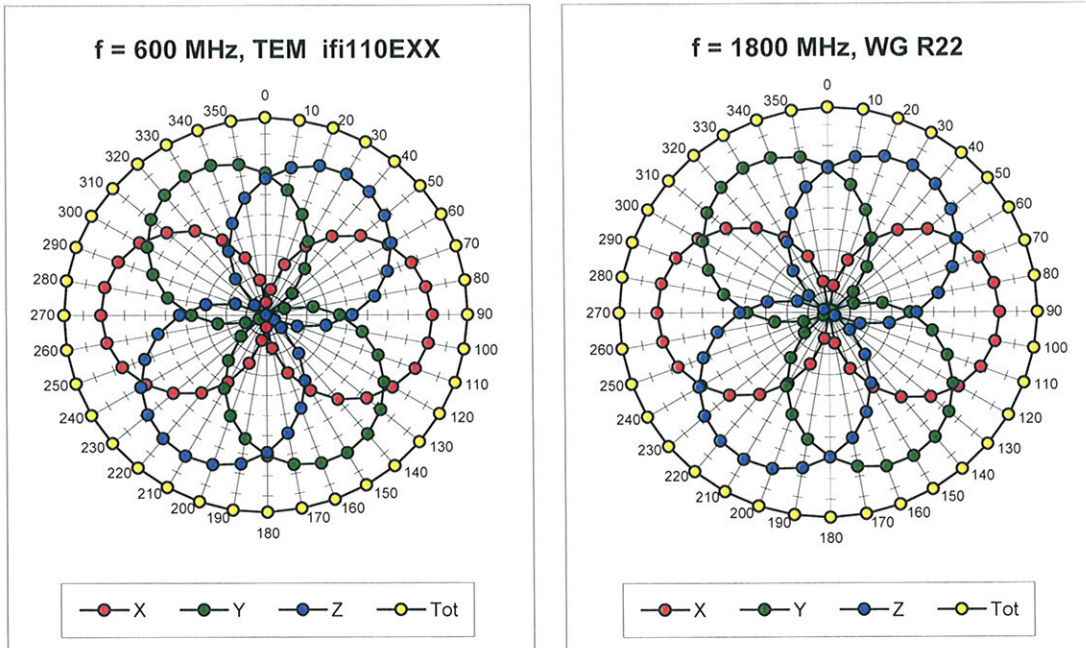

Uncertainty of Axial Isotropy Assessment:  $\pm 0.5\%$  (k=2)

### Dynamic Range $f(SAR_{head})$ (Waveguide R22, $f = 1800$ MHz)

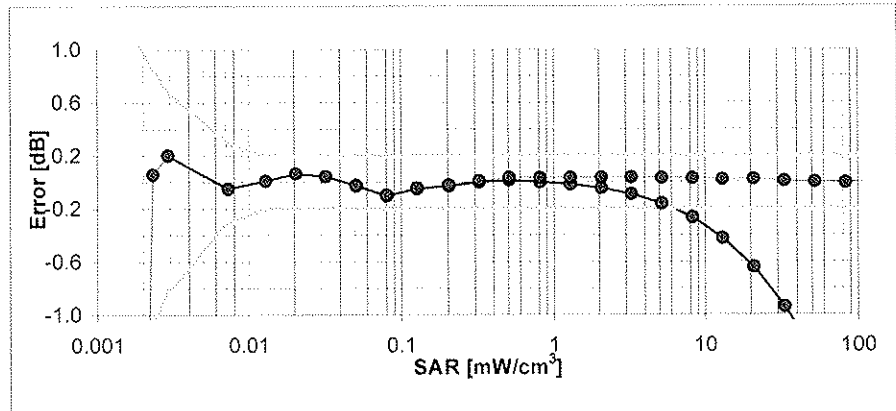
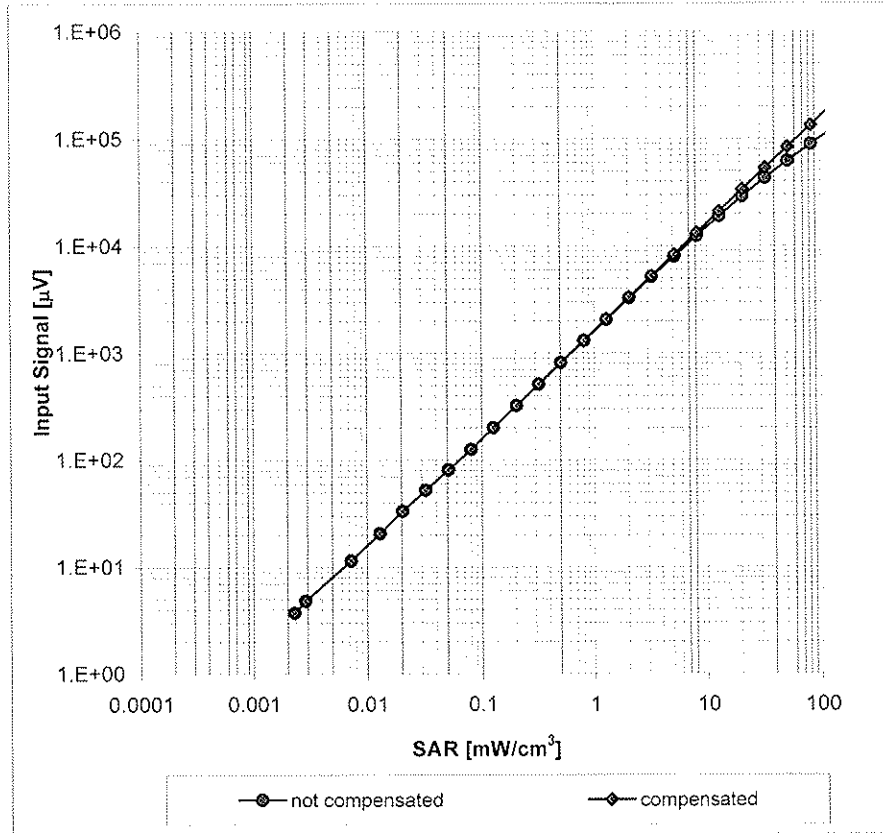

Uncertainty of Linearity Assessment:  $\pm 0.6\%$  ( $k=2$ )

### Conversion Factor Assessment

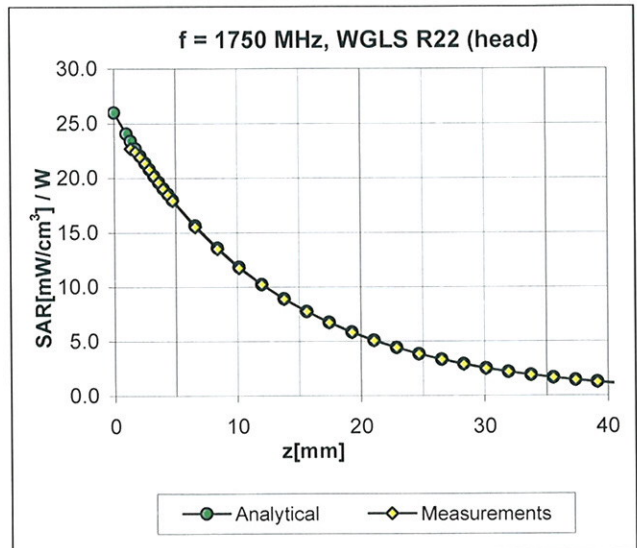
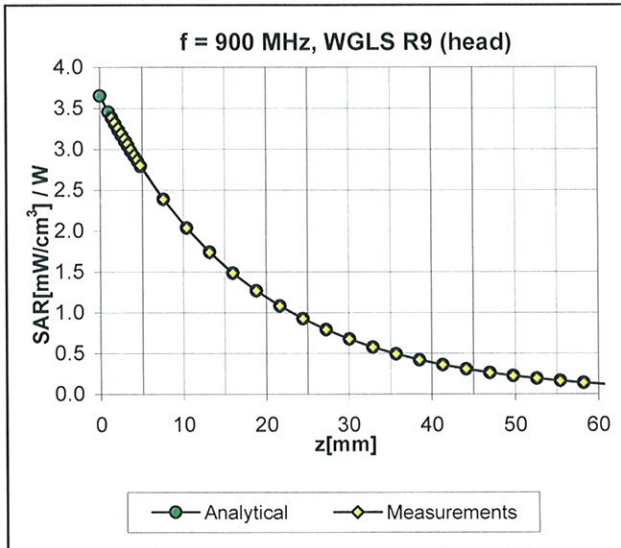

### Deviation from Isotropy in HSL

Error ( $\phi, \vartheta$ ), f = 900 MHz

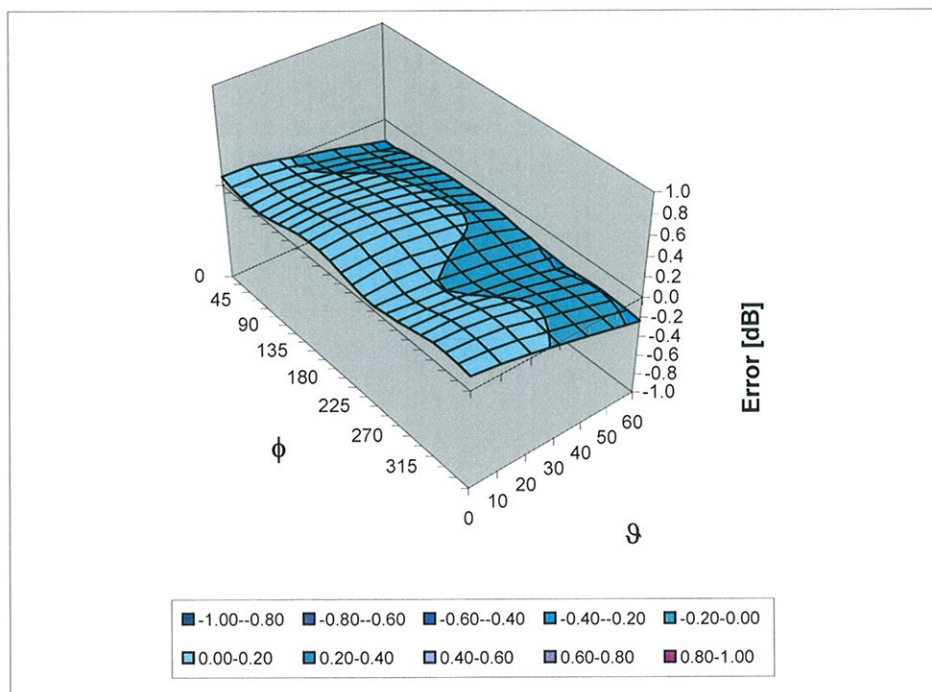

Uncertainty of Spherical Isotropy Assessment:  $\pm 2.6\%$  (k=2)

## Other Probe Parameters

Sensor Arrangement	Triangular
Connector Angle (°)	Not applicable
Mechanical Surface Detection Mode	enabled
Optical Surface Detection Mode	disabled
Probe Overall Length	337 mm
Probe Body Diameter	10 mm
Tip Length	9 mm
Tip Diameter	2.5 mm
Probe Tip to Sensor X Calibration Point	1 mm
Probe Tip to Sensor Y Calibration Point	1 mm
Probe Tip to Sensor Z Calibration Point	1 mm
Recommended Measurement Distance from Surface	2 mm





A D T

**D3: DAE**

## IMPORTANT NOTICE

### USAGE OF THE DAE 3

The DAE unit is a delicate, high precision instrument and requires careful treatment by the user. There are no serviceable parts inside the DAE. Special attention shall be given to the following points:

**Battery Exchange:** The battery cover of the DAE3 unit is connected to a fragile 3-pin battery connector. Customer is responsible to apply utmost caution not to bend or damage the connector when changing batteries.

**Shipping of the DAE:** Before shipping the DAE to SPEAG for calibration the customer shall remove the batteries and pack the DAE in an antistatic bag. This antistatic bag shall then be packed into a larger box or container which protects the DAE from impacts transportation. The package shall be marked to indicate that a fragile instrument is inside.

**E-Stop Failures:** Touch detection may be malfunctioning due to broken magnets in the E-stop. Rough handling of the E-stop may lead to damage of these magnets. Touch and collision errors are often caused by dust and dirt accumulated in the E-stop. To prevent E-stop failure, Customer shall always mount the probe to the DAE carefully and keep the DAE unit in a non-dusty environment if not used for measurements.

**Repair:** Minor repairs are performed at no extra cost during the annual calibration. However, SPEAG reserves the right to charge for any repair especially if rough unprofessional handling caused the defect.

**DASY Configuration Files:** Since the exact values of the DAE input resistances, as measured during the calibration procedure of a DAE unit, are not used by the DASY software, a nominal value of 200 MOhm is given in the corresponding configuration file.

**Important Note:**

Warranty and calibration is void if the DAE unit is disassembled partly or fully by the Customer.

**Important Note:**

Never attempt to grease or oil the E-stop assembly. Cleaning and readjusting of the E-stop assembly is allowed by certified SPEAG personnel only and is part of the annual calibration procedure.

**Important Note:**

To prevent damage of the DAE probe connector pins, use great care when installing the probe to the DAE. Carefully connect the probe with the connector notch oriented in the mating position. Avoid any rotational movement of the probe body versus the DAE while turning the locking nut of the connector. The same care shall be used when disconnecting the probe from the DAE.



Accredited by the Swiss Accreditation Service (SAS)  
The Swiss Accreditation Service is one of the signatories to the EA  
Multilateral Agreement for the recognition of calibration certificates

Accreditation No.: **SCS 108**

Client **ADT (Auden)**

Certificate No: **DAE3-510\_Oct10**

## CALIBRATION CERTIFICATE

Object **DAE3 - SD 000 D03 AA - SN: 510**

Calibration procedure(s) **QA CAL-06.v22  
Calibration procedure for the data acquisition electronics (DAE)**

Calibration date: **October 4, 2010**

This calibration certificate documents the traceability to national standards, which realize the physical units of measurements (SI).  
The measurements and the uncertainties with confidence probability are given on the following pages and are part of the certificate.

All calibrations have been conducted in the closed laboratory facility: environment temperature (22 ± 3)°C and humidity < 70%.

Calibration Equipment used (M&TE critical for calibration)

Primary Standards	ID #	Cal Date (Certificate No.)	Scheduled Calibration
Keithley Multimeter Type 2001	SN: 0810278	28-Sep-10 (No:10376)	Sep-11
Secondary Standards	ID #	Check Date (in house)	Scheduled Check
Calibrator Box V1.1	SE UMS 006 AB 1004	07-Jun-10 (in house check)	In house check: Jun-11

Calibrated by: **Name  
Dominique Steffen**

Function  
**Technician**

Signature

Approved by: **Fin Bomholt**

R&D Director

Issued: October 4, 2010

This calibration certificate shall not be reproduced except in full without written approval of the laboratory.



Accredited by the Swiss Accreditation Service (SAS)  
The Swiss Accreditation Service is one of the signatories to the EA  
Multilateral Agreement for the recognition of calibration certificates

Accreditation No.: **SCS 108**

## Glossary

DAE data acquisition electronics  
Connector angle information used in DASY system to align probe sensor X to the robot coordinate system.

## Methods Applied and Interpretation of Parameters

- *DC Voltage Measurement:* Calibration Factor assessed for use in DASY system by comparison with a calibrated instrument traceable to national standards. The figure given corresponds to the full scale range of the voltmeter in the respective range.
- *Connector angle:* The angle of the connector is assessed measuring the angle mechanically by a tool inserted. Uncertainty is not required.
- The following parameters as documented in the Appendix contain technical information as a result from the performance test and require no uncertainty.
  - *DC Voltage Measurement Linearity:* Verification of the Linearity at +10% and -10% of the nominal calibration voltage. Influence of offset voltage is included in this measurement.
  - *Common mode sensitivity:* Influence of a positive or negative common mode voltage on the differential measurement.
  - *Channel separation:* Influence of a voltage on the neighbor channels not subject to an input voltage.
  - *AD Converter Values with inputs shorted:* Values on the internal AD converter corresponding to zero input voltage
  - *Input Offset Measurement:* Output voltage and statistical results over a large number of zero voltage measurements.
  - *Input Offset Current:* Typical value for information; Maximum channel input offset current, not considering the input resistance.
  - *Input resistance:* Typical value for information: DAE input resistance at the connector, during internal auto-zeroing and during measurement.
  - *Low Battery Alarm Voltage:* Typical value for information. Below this voltage, a battery alarm signal is generated.
  - *Power consumption:* Typical value for information. Supply currents in various operating modes.

## DC Voltage Measurement

A/D - Converter Resolution nominal

High Range: 1LSB = 6.1 $\mu$ V, full range = -100...+300 mV

Low Range: 1LSB = 61nV, full range = -1.....+3mV

DASY measurement parameters: Auto Zero Time: 3 sec; Measuring time: 3 sec

Calibration Factors	X	Y	Z
High Range	404.204 $\pm$ 0.1% (k=2)	404.261 $\pm$ 0.1% (k=2)	404.619 $\pm$ 0.1% (k=2)
Low Range	3.97841 $\pm$ 0.7% (k=2)	3.96431 $\pm$ 0.7% (k=2)	3.98318 $\pm$ 0.7% (k=2)

## Connector Angle

Connector Angle to be used in DASY system	280.0 $^{\circ}$ $\pm$ 1 $^{\circ}$
---	-------------------------------------

## Appendix

### 1. DC Voltage Linearity

High Range		Reading ( $\mu\text{V}$ )	Difference ( $\mu\text{V}$ )	Error (%)
Channel X	+ Input	200002.6	1.33	0.00
Channel X	+ Input	20001.52	1.72	0.01
Channel X	- Input	-19997.99	1.81	-0.01
Channel Y	+ Input	200010.4	0.89	0.00
Channel Y	+ Input	20000.89	1.39	0.01
Channel Y	- Input	-19998.10	1.60	-0.01
Channel Z	+ Input	200007.2	-1.37	-0.00
Channel Z	+ Input	19998.21	-1.29	-0.01
Channel Z	- Input	-20001.73	-2.13	0.01

Low Range		Reading ( $\mu\text{V}$ )	Difference ( $\mu\text{V}$ )	Error (%)
Channel X	+ Input	2000.1	0.23	0.01
Channel X	+ Input	200.27	0.27	0.13
Channel X	- Input	-199.76	0.04	-0.02
Channel Y	+ Input	2000.8	0.66	0.03
Channel Y	+ Input	199.56	-0.44	-0.22
Channel Y	- Input	-200.06	-0.16	0.08
Channel Z	+ Input	1999.4	-0.75	-0.04
Channel Z	+ Input	199.53	-0.57	-0.28
Channel Z	- Input	-201.06	-1.16	0.58

### 2. Common mode sensitivity

DASY measurement parameters: Auto Zero Time: 3 sec; Measuring time: 3 sec

	Common mode Input Voltage (mV)	High Range Average Reading ( $\mu\text{V}$ )	Low Range Average Reading ( $\mu\text{V}$ )
Channel X	200	17.87	16.44
	- 200	-15.36	-17.11
Channel Y	200	14.99	14.97
	- 200	-16.63	-16.47
Channel Z	200	-8.65	-8.74
	- 200	7.23	7.63

### 3. Channel separation

DASY measurement parameters: Auto Zero Time: 3 sec; Measuring time: 3 sec

	Input Voltage (mV)	Channel X ( $\mu\text{V}$ )	Channel Y ( $\mu\text{V}$ )	Channel Z ( $\mu\text{V}$ )
Channel X	200	-	4.37	-3.14
Channel Y	200	6.07	-	3.36
Channel Z	200	3.03	-0.24	-

#### 4. AD-Converter Values with inputs shorted

DASY measurement parameters: Auto Zero Time: 3 sec; Measuring time: 3 sec

	High Range (LSB)	Low Range (LSB)
Channel X	15917	15639
Channel Y	16112	16210
Channel Z	16121	16322

#### 5. Input Offset Measurement

DASY measurement parameters: Auto Zero Time: 3 sec; Measuring time: 3 sec

Input 10M $\Omega$

	Average ( $\mu$ V)	min. Offset ( $\mu$ V)	max. Offset ( $\mu$ V)	Std. Deviation ( $\mu$ V)
Channel X	0.61	0.06	2.59	0.30
Channel Y	1.72	-0.56	3.01	0.39
Channel Z	-1.94	-2.73	-0.59	0.30

#### 6. Input Offset Current

Nominal Input circuitry offset current on all channels: <25fA

#### 7. Input Resistance (Typical values for information)

	Zeroing (kOhm)	Measuring (MOhm)
Channel X	200	200
Channel Y	200	200
Channel Z	200	200

#### 8. Low Battery Alarm Voltage (Typical values for information)

Typical values	Alarm Level (VDC)
Supply (+ Vcc)	+7.9
Supply (- Vcc)	-7.6

#### 9. Power Consumption (Typical values for information)

Typical values	Switched off (mA)	Stand by (mA)	Transmitting (mA)
Supply (+ Vcc)	+0.01	+6	+14
Supply (- Vcc)	-0.01	-8	-9



## D4: SYSTEM VALIDATION DIPOLE





Accredited by the Swiss Accreditation Service (SAS)  
The Swiss Accreditation Service is one of the signatories to the EA  
Multilateral Agreement for the recognition of calibration certificates

Accreditation No.: **SCS 108**

Client **B.V. ADT (Auden)**

Certificate No: **D5GHzV2-1019\_Jan11**

## CALIBRATION CERTIFICATE

Object **D5GHzV2 - SN: 1019**

Calibration procedure(s) **QA CAL-22.v1**  
**Calibration procedure for dipole validation kits between 3-6 GHz**

Calibration date: **January 25, 2011**

This calibration certificate documents the traceability to national standards, which realize the physical units of measurements (SI).  
The measurements and the uncertainties with confidence probability are given on the following pages and are part of the certificate.

All calibrations have been conducted in the closed laboratory facility: environment temperature ( $22 \pm 3$ )°C and humidity < 70%.

Calibration Equipment used (M&TE critical for calibration)

Primary Standards	ID #	Cal Date (Certificate No.)	Scheduled Calibration
Power meter EPM-442A	GB37480704	06-Oct-10 (No. 217-01266)	Oct-11
Power sensor HP 8481A	US37292783	06-Oct-10 (No. 217-01266)	Oct-11
Reference 20 dB Attenuator	SN: 5086 (20g)	30-Mar-10 (No. 217-01158)	Mar-11
Type-N mismatch combination	SN: 5047.2 / 06327	30-Mar-10 (No. 217-01162)	Mar-11
Reference Probe EX3DV4	SN: 3503	05-Mar-10 (No. EX3-3503_Mar10)	Mar-11
DAE4	SN: 60i	10-Jun-10 (No. DAE4-60i_Jun10)	Jun-11
Secondary Standards	ID #	Check Date (in house)	Scheduled Check
Power sensor HP 8481A	MY41092317	18-Oct-02 (in house check Oct-09)	In house check: Oct-11
RF generator R&S SMT-06	100005	4-Aug-99 (in house check Oct-09)	In house check: Oct-11
Network Analyzer HP 8753E	US37390585 S4206	18-Oct-01 (in house check Oct-10)	In house check: Oct-11

Calibrated by: **Jeton Kastrati**      Name: **Jeton Kastrati**      Function: **Laboratory Technician**

Approved by: **Katja Pokovic**      Name: **Katja Pokovic**      Function: **Technical Manager**

Signature

Issued: January 25, 2011

This calibration certificate shall not be reproduced except in full without written approval of the laboratory.



Accredited by the Swiss Accreditation Service (SAS)  
The Swiss Accreditation Service is one of the signatories to the EA  
Multilateral Agreement for the recognition of calibration certificates

Accreditation No.: **SCS 108**

### Glossary:

TSL	tissue simulating liquid
ConvF	sensitivity in TSL / NORM x,y,z
N/A	not applicable or not measured

### Calibration is Performed According to the Following Standards:

- a) IEC 62209-2, "Evaluation of Human Exposure to Radio Frequency Fields from Handheld and Body-Mounted Wireless Communication Devices in the Frequency Range of 30 MHz to 6 GHz: Human models, Instrumentation, and Procedures"; Part 2: "Procedure to determine the Specific Absorption Rate (SAR) for including accessories and multiple transmitters", March 2010
- b) Federal Communications Commission Office of Engineering & Technology (FCC OET), "Evaluating Compliance with FCC Guidelines for Human Exposure to Radiofrequency Electromagnetic Fields; Additional Information for Evaluating Compliance of Mobile and Portable Devices with FCC Limits for Human Exposure to Radiofrequency Emissions", Supplement C (Edition 01-01) to Bulletin 65

### Additional Documentation:

- c) DASY4/5 System Handbook

### Methods Applied and Interpretation of Parameters:

- *Measurement Conditions:* Further details are available from the Validation Report at the end of the certificate. All figures stated in the certificate are valid at the frequency indicated.
- *Antenna Parameters with TSL:* The dipole is mounted with the spacer to position its feed point exactly below the center marking of the flat phantom section, with the arms oriented parallel to the body axis.
- *Feed Point Impedance and Return Loss:* These parameters are measured with the dipole positioned under the liquid filled phantom. The impedance stated is transformed from the measurement at the SMA connector to the feed point. The Return Loss ensures low reflected power. No uncertainty required.
- *Electrical Delay:* One-way delay between the SMA connector and the antenna feed point. No uncertainty required.
- *SAR measured:* SAR measured at the stated antenna input power.
- *SAR normalized:* SAR as measured, normalized to an input power of 1 W at the antenna connector.
- *SAR for nominal TSL parameters:* The measured TSL parameters are used to calculate the nominal SAR result.

## Measurement Conditions

DASY system configuration, as far as not given on page 1.

DASY Version	DASY5	V52.6
Extrapolation	Advanced Extrapolation	
Phantom	Modular Flat Phantom V5.0	
Distance Dipole Center - TSL	10 mm	with Spacer
Area Scan resolution	dx, dy = 10 mm	
Zoom Scan Resolution	dx, dy = 4.0 mm, dz = 2.0 mm	
Frequency	5200 MHz ± 1 MHz 5500 MHz ± 1 MHz 5800 MHz ± 1 MHz	

## Head TSL parameters at 5200 MHz

The following parameters and calculations were applied.

	Temperature	Permittivity	Conductivity
Nominal Head TSL parameters	22.0 °C	36.0	4.66 mho/m
Measured Head TSL parameters	(22.0 ± 0.2) °C	35.3 ± 6 %	4.50 mho/m ± 6 %
Head TSL temperature during test	(21.8 ± 0.2) °C	----	----

## SAR result with Head TSL at 5200 MHz

SAR averaged over 1 cm <sup>3</sup> (1 g) of Head TSL	condition	
SAR measured	100 mW input power	8.21 mW / g
SAR normalized	normalized to 1W	82.1 mW / g
SAR for nominal Head TSL parameters	normalized to 1W	<b>81.8 mW / g ± 19.9 % (k=2)</b>

SAR averaged over 10 cm <sup>3</sup> (10 g) of Head TSL	condition	
SAR measured	100 mW input power	2.32 mW / g
SAR normalized	normalized to 1W	23.2 mW / g
SAR for nominal Head TSL parameters	normalized to 1W	<b>23.1 mW / g ± 19.5 % (k=2)</b>

### Head TSL parameters at 5500 MHz

The following parameters and calculations were applied.

	Temperature	Permittivity	Conductivity
Nominal Head TSL parameters	22.0 °C	35.6	4.96 mho/m
Measured Head TSL parameters	(22.0 ± 0.2) °C	36.2 ± 6 %	4.86 mho/m ± 6 %
Head TSL temperature during test	(21.8 ± 0.2) °C	----	----

### SAR result with Head TSL at 5500 MHz

SAR averaged over 1 cm <sup>3</sup> (1 g) of Head TSL	condition	
SAR measured	100 mW input power	8.87 mW / g
SAR normalized	normalized to 1W	88.7 mW / g
SAR for nominal Head TSL parameters	normalized to 1W	<b>88.9 mW / g ± 19.9 % (k=2)</b>

SAR averaged over 10 cm <sup>3</sup> (10 g) of Head TSL	condition	
SAR measured	100 mW input power	2.49 mW / g
SAR normalized	normalized to 1W	24.9 mW / g
SAR for nominal Head TSL parameters	normalized to 1W	<b>24.9 mW / g ± 19.5 % (k=2)</b>

### Head TSL parameters at 5800 MHz

The following parameters and calculations were applied.

	Temperature	Permittivity	Conductivity
Nominal Head TSL parameters	22.0 °C	35.3	5.27 mho/m
Measured Head TSL parameters	(22.0 ± 0.2) °C	35.5 ± 6 %	5.17 mho/m ± 6 %
Head TSL temperature during test	(21.8 ± 0.2) °C	----	----

### SAR result with Head TSL at 5800 MHz

SAR averaged over 1 cm <sup>3</sup> (1 g) of Head TSL	condition	
SAR measured	100 mW input power	8.32 mW / g
SAR normalized	normalized to 1W	83.2 mW / g
SAR for nominal Head TSL parameters	normalized to 1W	<b>83.2 mW / g ± 19.9 % (k=2)</b>

SAR averaged over 10 cm <sup>3</sup> (10 g) of Head TSL	condition	
SAR measured	100 mW input power	2.33 mW / g
SAR normalized	normalized to 1W	23.3 mW / g
SAR for nominal Head TSL parameters	normalized to 1W	<b>23.3 mW / g ± 19.5 % (k=2)</b>

### Body TSL parameters at 5200 MHz

The following parameters and calculations were applied.

	Temperature	Permittivity	Conductivity
Nominal Body TSL parameters	22.0 °C	49.0	5.30 mho/m
Measured Body TSL parameters	(22.0 ± 0.2) °C	47.2 ± 6 %	5.37 mho/m ± 6 %
Body TSL temperature during test	(21.5 ± 0.2) °C	----	----

### SAR result with Body TSL at 5200 MHz

SAR averaged over 1 cm <sup>3</sup> (1 g) of Body TSL	condition	
SAR measured	100 mW input power	7.77 mW / g
SAR normalized	normalized to 1W	77.7 mW / g
SAR for nominal Body TSL parameters	normalized to 1W	<b>77.1 mW / g ± 19.9 % (k=2)</b>

SAR averaged over 10 cm <sup>3</sup> (10 g) of Body TSL	condition	
SAR measured	100 mW input power	2.15 mW / g
SAR normalized	normalized to 1W	21.5 mW / g
SAR for nominal Body TSL parameters	normalized to 1W	<b>21.3 mW / g ± 19.5 % (k=2)</b>

### Body TSL parameters at 5500 MHz

The following parameters and calculations were applied.

	Temperature	Permittivity	Conductivity
Nominal Body TSL parameters	22.0 °C	48.6	5.65 mho/m
Measured Body TSL parameters	(22.0 ± 0.2) °C	46.6 ± 6 %	5.75 mho/m ± 6 %
Body TSL temperature during test	(21.5 ± 0.2) °C	----	----

### SAR result with Body TSL at 5500 MHz

SAR averaged over 1 cm <sup>3</sup> (1 g) of Body TSL	condition	
SAR measured	100 mW input power	8.31 mW / g
SAR normalized	normalized to 1W	83.1 mW / g
SAR for nominal Body TSL parameters	normalized to 1W	<b>82.4 mW / g ± 19.9 % (k=2)</b>

SAR averaged over 10 cm <sup>3</sup> (10 g) of Body TSL	condition	
SAR measured	100 mW input power	2.29 mW / g
SAR normalized	normalized to 1W	22.9 mW / g
SAR for nominal Body TSL parameters	normalized to 1W	<b>22.7 mW / g ± 19.5 % (k=2)</b>

### Body TSL parameters at 5800 MHz

The following parameters and calculations were applied.

	Temperature	Permittivity	Conductivity
Nominal Body TSL parameters	22.0 °C	48.2	6.00 mho/m
Measured Body TSL parameters	(22.0 ± 0.2) °C	46.1 ± 6 %	6.14 mho/m ± 6 %
Body TSL temperature during test	(21.5 ± 0.2) °C	----	----

### SAR result with Body TSL at 5800 MHz

SAR averaged over 1 cm <sup>3</sup> (1 g) of Body TSL	condition	
SAR measured	100 mW input power	7.40 mW / g
SAR normalized	normalized to 1W	74.0 mW / g
SAR for nominal Body TSL parameters	normalized to 1W	<b>73.4 mW / g ± 19.9 % (k=2)</b>

SAR averaged over 10 cm <sup>3</sup> (10 g) of Body TSL	condition	
SAR measured	100 mW input power	2.02 mW / g
SAR normalized	normalized to 1W	20.2 mW / g
SAR for nominal Body TSL parameters	normalized to 1W	<b>20.0 mW / g ± 19.5 % (k=2)</b>

## Appendix

### Antenna Parameters with Head TSL at 5200 MHz

Impedance, transformed to feed point	51.9 $\Omega$ - 8.4 j $\Omega$
Return Loss	-21.5 dB

### Antenna Parameters with Head TSL at 5500 MHz

Impedance, transformed to feed point	51.4 $\Omega$ - 2.1 j $\Omega$
Return Loss	-31.9 dB

### Antenna Parameters with Head TSL at 5800 MHz

Impedance, transformed to feed point	56.3 $\Omega$ + 2.6 j $\Omega$
Return Loss	-23.9 dB

### Antenna Parameters with Body TSL at 5200 MHz

Impedance, transformed to feed point	51.8 $\Omega$ - 6.7 j $\Omega$
Return Loss	-23.3 dB

### Antenna Parameters with Body TSL at 5500 MHz

Impedance, transformed to feed point	51.6 $\Omega$ - 0.4 j $\Omega$
Return Loss	-36.0 dB

### Antenna Parameters with Body TSL at 5800 MHz

Impedance, transformed to feed point	56.4 $\Omega$ + 3.9 j $\Omega$
Return Loss	-23.1 dB

## General Antenna Parameters and Design

Electrical Delay (one direction)	1.204 ns
----------------------------------	----------

After long term use with 40 W radiated power, only a slight warming of the dipole near the feedpoint can be measured.

The dipole is made of standard semirigid coaxial cable. The center conductor of the feeding line is directly connected to the second arm of the dipole. The antenna is therefore short-circuited for DC-signals.

No excessive force must be applied to the dipole arms, because they might bend or the soldered connections near the feedpoint may be damaged.

## Additional EUT Data

Manufactured by	SPEAG
Manufactured on	February 05, 2004



## DASY5 Validation Report for Head TSL

Date/Time: 25.01.2011 15:44:08

Test Laboratory: SPEAG, Zurich, Switzerland

**DUT: Dipole 5GHz; Type: D5GHz; Serial: D5GHzV2 - SN:1019**

Communication System: CW; Frequency: 5200 MHz, Frequency: 5500 MHz, Frequency: 5800 MHz; Duty Cycle: 1:1

Medium: HSL 5000

Medium parameters used:  $f = 5200$  MHz;  $\sigma = 4.51$  mho/m;  $\epsilon_r = 35.3$ ;  $\rho = 1000$  kg/m<sup>3</sup>,

Medium parameters used:  $f = 5500$  MHz;  $\sigma = 4.87$  mho/m;  $\epsilon_r = 36.2$ ;  $\rho = 1000$  kg/m<sup>3</sup>,

Medium parameters used:  $f = 5800$  MHz;  $\sigma = 5.18$  mho/m;  $\epsilon_r = 35.5$ ;  $\rho = 1000$  kg/m<sup>3</sup>

Phantom section: Flat Section

Measurement Standard: DASY5 (IEEE/IEC/ANSI C63.19-2007)

DASY5 Configuration:

- Probe: EX3DV4 - SN3503; ConvF(5.36, 5.36, 5.36), ConvF(4.85, 4.85, 4.85), ConvF(4.74, 4.74, 4.74); Calibrated: 05.03.2010
- Sensor-Surface: 2mm (Mechanical Surface Detection)
- Electronics: DAE4 Sn601; Calibrated: 10.06.2010
- Phantom: Flat Phantom 5.0 (front); Type: QD000P50AA; Serial: 1001
- Measurement SW: DASY52, V52.6.1 Build (408)
- Postprocessing SW: SEMCAD X, V14.4.2 Build (2595)

**Pin=100mW/d=10mm, f=5200 MHz/Zoom Scan (4x4x2mm), dist=2mm (8x8x6)/Cube 0:** Measurement grid: dx=4mm, dy=4mm, dz=2mm

Reference Value = 63.766 V/m; Power Drift = 0.13 dB

Peak SAR (extrapolated) = 31.432 W/kg

**SAR(1 g) = 8.21 mW/g; SAR(10 g) = 2.32 mW/g**

Maximum value of SAR (measured) = 16.241 mW/g

**Pin=100mW/d=10mm, f=5500 MHz/Zoom Scan (4x4x2mm), dist=2mm (8x8x6)/Cube 0:** Measurement grid: dx=4mm, dy=4mm, dz=2mm

Reference Value = 64.225 V/m; Power Drift = 0.13 dB

Peak SAR (extrapolated) = 36.205 W/kg

**SAR(1 g) = 8.87 mW/g; SAR(10 g) = 2.49 mW/g**

Maximum value of SAR (measured) = 17.917 mW/g

**Pin=100mW/d=10mm, f=5800 MHz/Zoom Scan (4x4x2mm), dist=2mm (8x8x6)/Cube 0:** Measurement grid: dx=4mm, dy=4mm, dz=4mm

Reference Value = 60.818 V/m; Power Drift = 0.12 dB

Peak SAR (extrapolated) = 37.120 W/kg

**SAR(1 g) = 8.32 mW/g; SAR(10 g) = 2.33 mW/g**

Maximum value of SAR (measured) = 16.571 mW/g

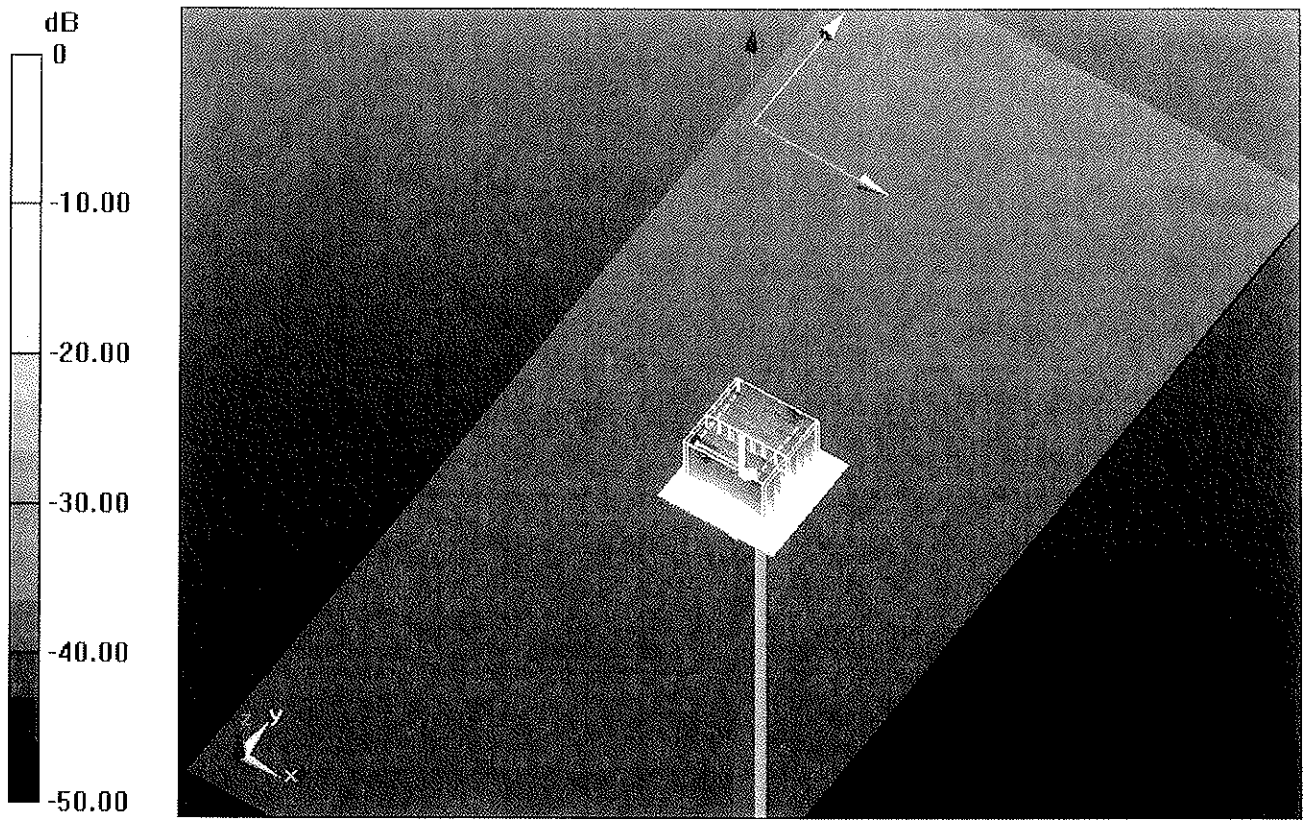

0 dB = 16.570mW/g

# Impedance Measurement Plot for Head TSL

17 Jan 2011 17:42:04

[CH1] S11 1 U FS 1: 51.904  $\Omega$  -8.3555  $\Omega$  3.6631 pF 5 200.000 000 MHz

\*

0e1

Cor

1  
2  
3

CH1 Markers

2: 51.426  $\Omega$   
-2.1426  $\Omega$   
5.50000 GHz  
3: 55.254  $\Omega$   
2.5820  $\Omega$   
5.00000 GHz

Avg  
16

↑

CH2 S11 LOG 5 dB/REF -20 dB 1: -21.534 dB 5 200.000 000 MHz

Cor

Avg  
16

↑

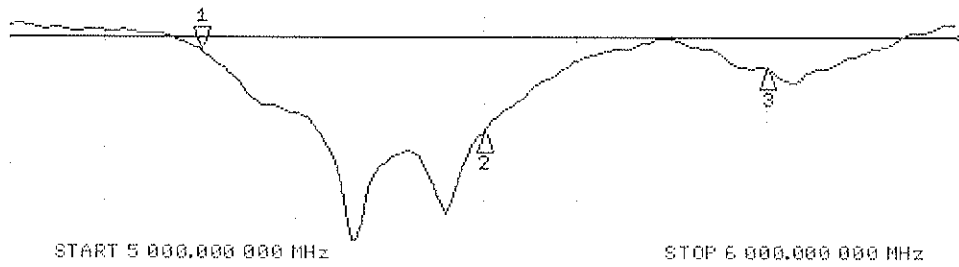

CH2 Markers

2: -31.912 dB  
5.50000 GHz  
3: -23.923 dB  
5.00000 GHz

## DASY5 Validation Report for Body TSL

Date/Time: 19.01.2011 11:41:41

Test Laboratory: SPEAG, Zurich, Switzerland

**DUT: Dipole 5GHz; Type: D5GHz; Serial: D5GHzV2 - SN:1019**

Communication System: CW; Frequency: 5200 MHz, Frequency: 5500 MHz, Frequency: 5800 MHz; Duty Cycle: 1:1

Medium: MSL 5000 MHz

Medium parameters used:  $f = 5200$  MHz;  $\sigma = 5.4$  mho/m;  $\epsilon_r = 47.2$ ;  $\rho = 1000$  kg/m<sup>3</sup>,

Medium parameters used:  $f = 5500$  MHz;  $\sigma = 5.78$  mho/m;  $\epsilon_r = 46.6$ ;  $\rho = 1000$  kg/m<sup>3</sup>,

Medium parameters used:  $f = 5800$  MHz;  $\sigma = 6.18$  mho/m;  $\epsilon_r = 46.1$ ;  $\rho = 1000$  kg/m<sup>3</sup>

Phantom section: Flat Section

Measurement Standard: DASY5 (IEEE/IEC/ANSI C63.19-2007)

DASY5 Configuration:

- Probe: EX3DV4 - SN3503; ConvF(4.88, 4.88, 4.88), ConvF(4.37, 4.37, 4.37), ConvF(4.57, 4.57, 4.57); Calibrated: 05.03.2010
- Sensor-Surface: 2mm (Mechanical Surface Detection)
- Electronics: DAE4 Sn601; Calibrated: 10.06.2010
- Phantom: Flat Phantom 5.0 (back); Type: QD000P50AA; Serial: 1002
- Measurement SW: DASY52, V52.6.1 Build (408)
- Postprocessing SW: SEMCAD X, V14.4.2 Build (2595)

**Pin=100mW/d=10mm, f=5200 MHz/Zoom Scan (4x4x2mm), dist=2mm (8x8x6)/Cube 0:** Measurement grid: dx=4mm, dy=4mm, dz=2mm

Reference Value = 60.081 V/m; Power Drift = -0.06 dB

Peak SAR (extrapolated) = 30.750 W/kg

**SAR(1 g) = 7.77 mW/g; SAR(10 g) = 2.15 mW/g**

Maximum value of SAR (measured) = 15.289 mW/g

**Pin=100mW/d=10mm, f=5500 MHz/Zoom Scan (4x4x2mm), dist=2mm (8x8x6)/Cube 0:** Measurement grid: dx=4mm, dy=4mm, dz=2mm

Reference Value = 60.368 V/m; Power Drift = 0.01 dB

Peak SAR (extrapolated) = 35.267 W/kg

**SAR(1 g) = 8.31 mW/g; SAR(10 g) = 2.29 mW/g**

Maximum value of SAR (measured) = 16.599 mW/g

**Pin=100mW/d=10mm, f=5800 MHz/Zoom Scan (4x4x2mm), dist=2mm (8x8x6)/Cube 0:** Measurement grid: dx=4mm, dy=4mm, dz=4mm

Reference Value = 54.998 V/m; Power Drift = -0.0083 dB

Peak SAR (extrapolated) = 35.336 W/kg

**SAR(1 g) = 7.4 mW/g; SAR(10 g) = 2.02 mW/g**

Maximum value of SAR (measured) = 14.674 mW/g

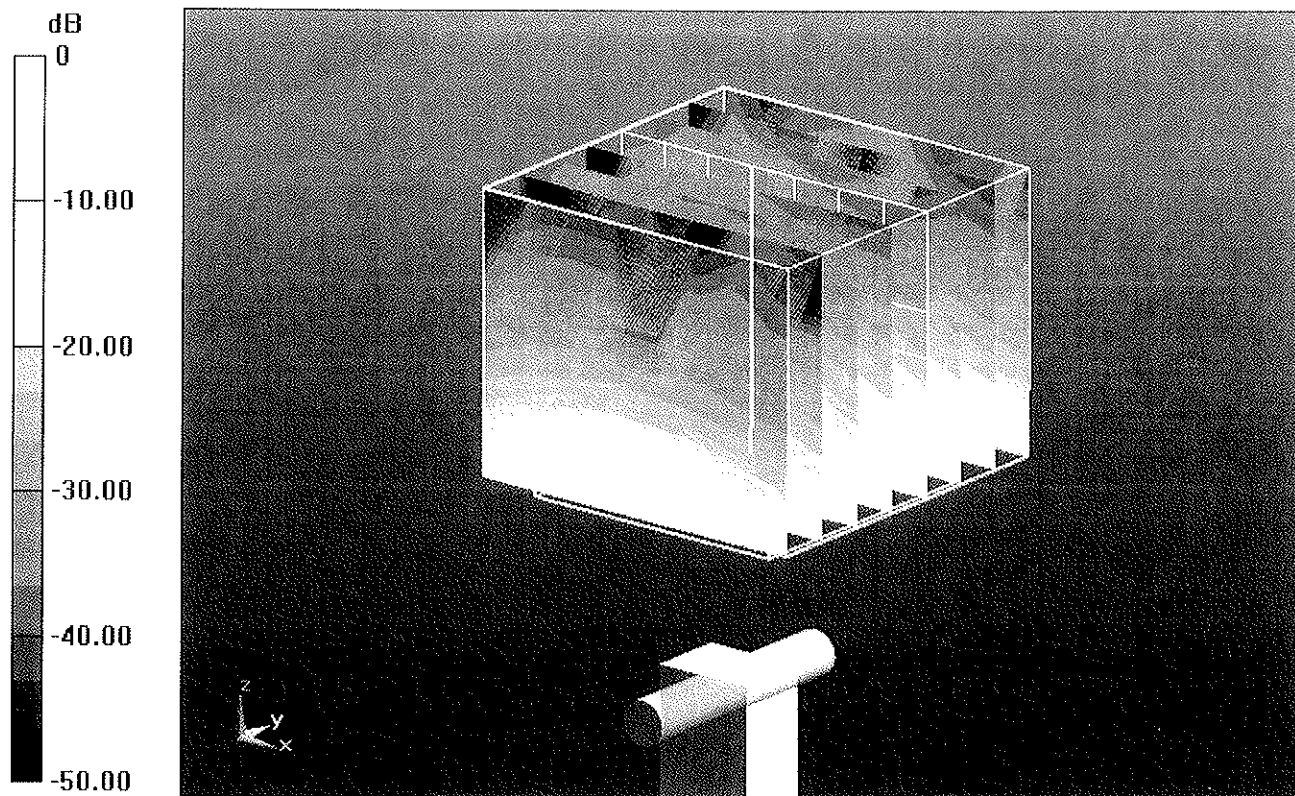

0 dB = 14.670mW/g

# Impedance Measurement Plot for Body TSL

19 Jan 2011 09:35:32

CH1 S11 1 U FS 1: 51.754  $\Omega$  -6.7227  $\Omega$  4.5528 pF 5 200.000 000 MHz

\*

Del

Cor

avg  
16

CH1 Markers

2: 51.551  $\Omega$   
-417.97  $\Omega$   
5.50000 GHz  
3: 56.357  $\Omega$   
3.9434  $\Omega$   
5.00000 GHz

1  
51.754  
 $\Omega$   
-6.7227  
 $\Omega$   
4.5528  
pF

CH2 S11 LOG 5 dB/REF -20 dB 1: -23.328 dB 5 200.000 000 MHz

Cor

avg  
16

CH2 Markers

2: -36.029 dB  
5.50000 GHz  
3: -23.065 dB  
5.00000 GHz

