



A D T

DFS TEST REPORT

REPORT NO.: RF110111C23-3

MODEL NO.: RDJ21WW

FCC ID: L6ARDJ20WW

IC ID: 2503A-RDJ20WW

RECEIVED: Jan. 12, 2011

TESTED: Feb. 22, 2011

ISSUED: Feb. 22, 2011

APPLICANT: Research In Motion Limited

ADDRESS: 295 Phillip Street, Waterloo, Ontario, Canada

ISSUED BY: Bureau Veritas Consumer Products Services (H.K.)
Ltd., Taoyuan Branch

LAB ADDRESS: No. 47, 14th Ling, Chia Pau Tsuen, Lin Kou Hsiang,
Taipei Hsien 244, Taiwan, R.O.C.

TEST LOCATION: No. 19, Hwa Ya 2nd Rd, Wen Hwa Tsuen, Kwei
Shan Hsiang, Taoyuan Hsien 333, Taiwan, R.O.C.

This test report consists of 22 pages in total. It may be duplicated completely for legal use with the approval of the applicant. It should not be reproduced except in full, without the written approval of our laboratory. The client should not use it to claim product certification, approval, or endorsement by TAF or any government agency. The test results in the report only apply to the tested sample.





Table of Contents

| | |
|--|----|
| RELEASE CONTROL RECORD..... | 3 |
| 1. LAB DECLARATION..... | 4 |
| 2. EUT INFORMATION..... | 5 |
| 2.1 OPERATING FREQUENCY BANDS AND MODE OF EUT..... | 5 |
| 2.2 EUT SOFTWARE AND FIRMWARE VERSION | 5 |
| 2.3 DESCRIPTION OF AVAILABLE ANTENNAS TO THE EUT | 5 |
| 2.4 EUT MAXIMUM AND MINIMUM CONDUCTED POWER | 6 |
| 2.5 EUT MAXIMUM AND MINIMUM E.I.R.P. POWER | 7 |
| 2.6 STATEMENT OF MAUNFACTURER..... | 7 |
| 3. U-NII DFS RULE REQUIREMENTS..... | 8 |
| 3.1 WORKING MODES AND REQUIRED TEST ITEMS | 8 |
| 3.2 TEST LIMITS AND RADAR SIGNAL PARAMETERS | 9 |
| 4. TEST & SUPPORT EQUIPMENT LIST | 11 |
| 4.1 TEST INSTRUMENTS..... | 11 |
| 4.2 DESCRIPTION OF SUPPORT UNITS | 11 |
| 5. TEST PROCEDURE..... | 12 |
| 5.1 BV ADT DFS MEASUREMENT SYSTEM:..... | 12 |
| 5.2 CALIBRATION OF DFS DETECTION THRESHOLD LEVEL:..... | 14 |
| 5.3 DEVIATION FROM TEST STANDARD | 14 |
| 5.4 CONDUCTED TEST SETUP CONFIGURATION..... | 15 |
| 5.4.1 CLIENT WITHOUT RADAR DETECTION MODE | 15 |
| 6. TEST RESULTS | 16 |
| 6.1 SUMMARY OF TEST RESULTS | 16 |
| 6.2 DETELED TEST RESULTS..... | 17 |
| 6.2.1 TEST MODE: DEVICE OPERATING IN CLIENT WITHOUT RADAR DETECTION MODE..... | 17 |
| 6.2.1.1 DFS DETECTION THRESHOLD | 17 |
| 6.2.1.2 CHANNEL CLOSING TRANSMISSION AND CHANNEL MOVE TIME | 18 |
| 6.2.2 NON-OCCUPANCY PERIOD | 20 |
| 7. TESTING LABORATORIES INFORMATION..... | 22 |



A D T

RELEASE CONTROL RECORD

| ISSUE NO. | REASON FOR CHANGE | DATE ISSUED |
|------------------|-------------------|---------------|
| Original release | N/A | Feb. 22, 2011 |



1. LAB DECLARATION

PRODUCT: Tablet Device
MODEL: RDJ21WW
BRAND: RIM
APPLICANT: Research In Motion Limited
TESTED: Feb. 22, 2011
TEST SAMPLE: ENGINEERING SAMPLE
STANDARDS: **FCC Part 15, Subpart E (Section 15.407)**
FCC 06-96
KDB 905642
Canada RSS-210 Issue 8 (2010-12)
Canada RSS-Gen Issue 3 (2010-12)

The above equipment (model: RDJ21WW) has been tested by **Bureau Veritas Consumer Products Services (H.K.) Ltd., Taoyuan Branch**, and found compliance with the requirement of the above standards. The test record, data evaluation & Equipment Under Test (EUT) configurations represented herein are true and accurate accounts of the measurements of the sample's EMC characteristics under the conditions specified in this report.

PREPARED BY :  , DATE : Feb. 22, 2011
Joanna Wang / Senior Specialist

APPROVED BY :  , DATE : Feb. 22, 2011
Gary Chang / Assistant Manager

2. EUT INFORMATION

2.1 OPERATING FREQUENCY BANDS AND MODE OF EUT

TABLE 1: OPERATING FREQUENCY BANDS AND MODE OF EUT

| OPERATIONAL MODE | OPERATING FREQUENCY RANGE | |
|--|---------------------------|--------------|
| | 5250~5350MHz | 5470~5725MHz |
| Client without radar detection and ad hoc function | ✓ | ✓ |

The EUT doesn't operate in 5600 ~ 5650MHz via software controls.

2.2 EUT SOFTWARE AND FIRMWARE VERSION

TABLE 2: THE EUT SOFTWARE/FIRMWARE VERSION

| NO. | PRODUCT | MODEL NO. | SOFTWARE/FIRMWARE VERSION |
|-----|---------------------------|-----------|---------------------------|
| 1 | Wireless Handheld Devices | RDJ21WW | 1.0 |

2.3 DESCRIPTION OF AVAILABLE ANTENNAS TO THE EUT

TABLE 3: ANTENNA LIST

| ANT NO. | ANTENNA TYPE | OPERATION FREQUENCY RANGE (MHz) | MAX. GAIN (dBi) |
|---------|--------------|---------------------------------|-----------------|
| 1 | PIFA | 5250~5350 | -0.3 |
| 1 | PIFA | 5470~5725 | 0.9 |

2.4 EUT MAXIMUM AND MINIMUM CONDUCTED POWER

TABLE 4: THE MEASURED CONDUCTED OUTPUT POWER

802.11a

| ANT NO. | FREQUENCY BAND (MHz) | MAX. POWER | | MIN. POWER | |
|---------|----------------------|-------------------|------------------|-------------------|------------------|
| | | OUTPUT POWER(dBm) | OUTPUT POWER(mW) | OUTPUT POWER(dBm) | OUTPUT POWER(mW) |
| 1 | 5250~5350 | 16.8 | 47.9 | 10.8 | 12.0 |
| 1 | 5470~5725 | 16.9 | 49.0 | 10.9 | 12.3 |

802.11n (20MHz)

| ANT NO. | FREQUENCY BAND (MHz) | MAX. POWER | | MIN. POWER | |
|---------|----------------------|-------------------|------------------|-------------------|------------------|
| | | OUTPUT POWER(dBm) | OUTPUT POWER(mW) | OUTPUT POWER(dBm) | OUTPUT POWER(mW) |
| 1 | 5250~5350 | 16.6 | 45.7 | 10.6 | 11.5 |
| 1 | 5470~5725 | 16.7 | 46.8 | 10.7 | 11.7 |

2.5 EUT MAXIMUM AND MINIMUM E.I.R.P. POWER

TABLE 5: THE E.I.R.P OUTPUT POWER LIST

802.11a

| ANT NO. | FREQUENCY BAND (MHz) | MAX. POWER | | MIN. POWER | |
|---------|----------------------|-------------------|------------------|-------------------|------------------|
| | | OUTPUT POWER(dBm) | OUTPUT POWER(mW) | OUTPUT POWER(dBm) | OUTPUT POWER(mW) |
| 1 | 5250~5350 | 16.5 | 44.7 | 10.5 | 11.2 |
| 1 | 5470~5725 | 17.8 | 60.3 | 11.8 | 15.1 |

802.11n (20MHz)

| ANT NO. | FREQUENCY BAND (MHz) | MAX. POWER | | MIN. POWER | |
|---------|----------------------|-------------------|------------------|-------------------|------------------|
| | | OUTPUT POWER(dBm) | OUTPUT POWER(mW) | OUTPUT POWER(dBm) | OUTPUT POWER(mW) |
| 1 | 5250~5350 | 16.3 | 42.7 | 10.3 | 10.7 |
| 1 | 5470~5725 | 17.6 | 57.5 | 11.6 | 14.5 |

2.6 STATEMENT OF MAUNFACTURER

Manufacturer statement confirming that information regarding the parameters of the detected Radar Waveforms is not available to the end user. **And the device doesn't have Ad Hoc mode on DFS frequency band.**

3. U-NII DFS RULE REQUIREMENTS

3.1 WORKING MODES AND REQUIRED TEST ITEMS

The manufacturer shall state whether the UUT is capable of operating as a Master and/or a Client. If the UUT is capable of operating in more than one operating mode then each operating mode shall be tested separately. See tables 1 and 2 for the applicability of DFS requirements for each of the operational modes.

TABLE 6: APPLICABILITY OF DFS REQUIREMENTS PRIOR TO USE A CHANNEL

| REQUIREMENT | OPERATIONAL MODE | | |
|---------------------------------|------------------|--------------------------------|-----------------------------|
| | MASTER | CLIENT WITHOUT RADAR DETECTION | CLIENT WITH RADAR DETECTION |
| Non-Occupancy Period | ✓ | Not required | ✓ |
| DFS Detection Threshold | ✓ | Not required | ✓ |
| Channel Availability Check Time | ✓ | Not required | Not required |
| Uniform Spreading | ✓ | Not required | Not required |
| U-NII Detection Bandwidth | ✓ | Not required | ✓ |

TABLE 7: APPLICABILITY OF DFS REQUIREMENTS DURING NORMAL OPERATION

| REQUIREMENT | OPERATIONAL MODE | | |
|-----------------------------------|------------------|--------------------------------|-----------------------------|
| | MASTER | CLIENT WITHOUT RADAR DETECTION | CLIENT WITH RADAR DETECTION |
| DFS Detection Threshold | ✓ | Not required | ✓ |
| Channel Closing Transmission Time | ✓ | ✓ | ✓ |
| Channel Move Time | ✓ | ✓ | ✓ |
| U-NII Detection Bandwidth | ✓ | Not required | ✓ |

3.2 TEST LIMITS AND RADAR SIGNAL PARAMETERS

DETECTION THRESHOLD VALUES

TABLE 8: DFS DETECTION THRESHOLDS FOR MASTER DEVICES AND CLIENT DEVICES WITH RADAR DETECTION

| MAXIMUM TRANSMIT POWER | VALUE (SEE Note 1 and 2) |
|------------------------|--------------------------|
| ≥ 200 milliwatt | -64 dBm |
| < 200 milliwatt | -62 dBm |

Note 1: This is the level at the input of the receiver assuming a 0 dBi receive antenna.

Note 2: Throughout these test procedures an additional 1 dB has been added to the amplitude of the test transmission waveforms to account for variations in measurement equipment. This will ensure that the test signal is at or above the detection threshold level to trigger a DFS response.

TABLE 9: DFS RESPONSE REQUIREMENT VALUES

| PARAMETER | VALUE |
|-----------------------------------|---|
| Non-occupancy period | Minimum 30 minutes |
| Channel Availability Check Time | 60 seconds |
| Channel Move Time | 10 seconds See Note 1. |
| Channel Closing Transmission Time | 200 milliseconds + an aggregate of 60 milliseconds over remaining 10 second period. See Notes 1 and 2. |
| U-NII Detection Bandwidth | Minimum 80% of the UNII 99% transmission power bandwidth. See Note 3. |

Note 1: The instant that the Channel Move Time and the Channel Closing Transmission Time begins is as follows:

- For the Short Pulse Radar Test Signals this instant is the end of the Burst.
- For the Frequency Hopping radar Test Signal, this instant is the end of the last radar Burst generated.
- For the Long Pulse Radar Test Signal this instant is the end of the 12 second period defining the Radar Waveform.

Note 2: The Channel Closing Transmission Time is comprised of 200 milliseconds starting at the beginning of the Channel Move Time plus any additional intermittent control signals required to facilitate a Channel move (an aggregate of 60 milliseconds) during the remainder of the 10 second period. The aggregate duration of control signals will not count quiet periods in between transmissions.

Note 3: During the U-NII Detection Bandwidth detection test, radar type 1 is used and for each frequency step the minimum percentage of detection is 90 percent. Measurements are performed with no data traffic.

PARAMETERS OF DFS TEST SIGNALS

Step intervals of 0.1 microsecond for Pulse Width, 1 microsecond for PRI, 1 MHz for chirp width and 1 for the number of pulses will be utilized for the random determination of specific test waveforms.

TABLE 10: SHORT PULSE RADAR TEST WAVEFORMS

| RADAR TYPE | PULSE WIDTH (μsec) | PRI (μsec) | NUMBER OF PULSES | MINIMUM PERCENTAGE OF SUCCESSFUL DETECTION | MINIMUM NUMBER OF TRIALS |
|-----------------------------|--------------------|------------|------------------|--|--------------------------|
| 1 | 1 | 1428 | 18 | 60% | 30 |
| 2 | 1-5 | 150-230 | 23-29 | 60% | 30 |
| 3 | 6-10 | 200-500 | 16-18 | 60% | 30 |
| 4 | 11-20 | 200-500 | 12-16 | 60% | 30 |
| Aggregate (Radar Types 1-4) | | | | 80% | 120 |

TABLE 11: LONG PULSE RADAR TEST WAVEFORM

| RADAR TYPE | PULSE WIDTH (μsec) | CHIRP WIDTH (MHz) | PRI (μsec) | NUMBER OF PULSES PER BURST | NUMBER OF BURSTS | MINIMUM PERCENTAGE OF SUCCESSFUL DETECTION | MINIMUM NUMBER OF TRIALS |
|------------|--------------------|-------------------|------------|----------------------------|------------------|--|--------------------------|
| 5 | 50-100 | 5-20 | 1000-2000 | 1-3 | 8-20 | 80% | 30 |

TABLE 12: FREQUENCY HOPPING RADAR TEST WAVEFORM

| RADAR TYPE | PULSE WIDTH (μsec) | PRI (μsec) | PULSES PER HOP | HOPPING RATE (kHz) | HOPPING SEQUENCE LENGTH (msec) | MINIMUM PERCENTAGE OF SUCCESSFUL DETECTION | MINIMUM NUMBER OF TRIALS |
|------------|--------------------|------------|----------------|--------------------|--------------------------------|--|--------------------------|
| 6 | 1 | 333 | 9 | 0.333 | 300 | 70% | 30 |

4. TEST & SUPPORT EQUIPMENT LIST

4.1 TEST INSTRUMENTS

TABLE 1: TEST INSTRUMENTS LIST.

| DESCRIPTION & MANUFACTURER | MODEL NO. | BRAND | CALIBRATED UNTIL |
|----------------------------|-----------|-----------|------------------|
| R&S Spectrum analyzer | FSP40 | R&S | 2011/07/28 |
| Signal generator | 8645A | Agilent | 2011/06/07 |
| Oscilloscope | TDS 5104 | Tektronix | 2011/09/02 |

4.2 DESCRIPTION OF SUPPORT UNITS

TABLE 2: SUPPORT UNIT INFORMATION.

| NO. | PRODUCT | BRAND | MODEL NO. | ID | SPEC. |
|-----|---------------------------|--------|-----------|-------------|-------|
| 1 | Xtreme N DUO MEDIA ROUTER | D-Link | DIR-855 | KA2DIR855A2 | -- |

NOTE: This device was functioned as a Master Slave device during the DFS test.

TABLE 3: SOFTWARE/FIRMWARE INFORMATION.

| NO. | PRODUCT | MODEL NO. | SOFTWARE/FIRMWARE VERSION |
|-----|---------------------------|-----------|---------------------------|
| 1. | Xtreme N DUO MEDIA ROUTER | DIR-855 | 1.11 |

5. TEST PROCEDURE

5.1 BV ADT DFS MEASUREMENT SYSTEM:

A complete BV ADT DFS Measurement System consists of two subsystems: (1) the Radar Signal Generating Subsystem and (2) the Traffic Monitoring Subsystem. The control PC is necessary for generating the Radar waveforms in Table 6, 7 and 8. The traffic monitoring subsystem is specified to the type of unit under test (UUT).

CONDUCTED SETUP CONFIGURATION OF ADT DFS MEASUREMENT SYSTEM

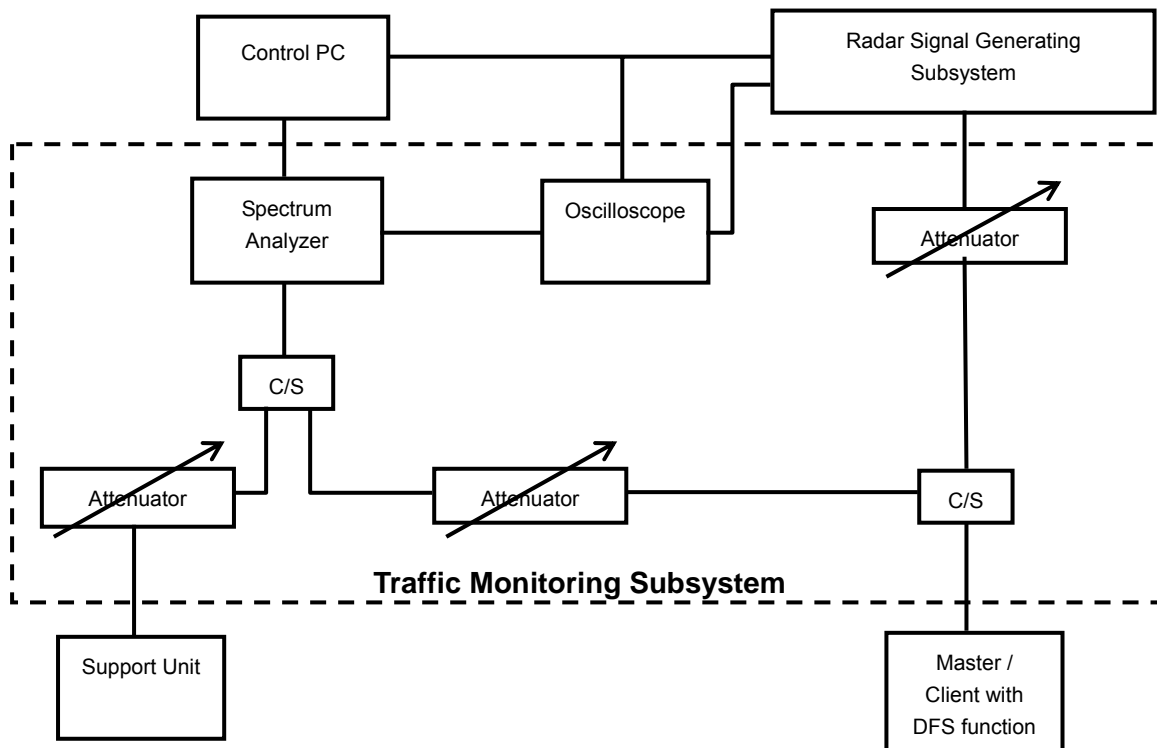

The test transmission will always be from the Master Device to the Client Device. The system was configured with an FTP transfer of a video file from the master device (sourced by the pc connected to the master device via an ethernet interface) to the client device. The FTP file transferred was the "FCC" test file and the client device was configured with 6 / 6.5 Mbps data rate to achieve a 33.401 / 32.086 % traffic load. The test setup is accepted by FCC in tracking no.630576

Wireless Traffic Loading

IEEE 802.11a Duty Cycle: 33.401% / 6Mbps

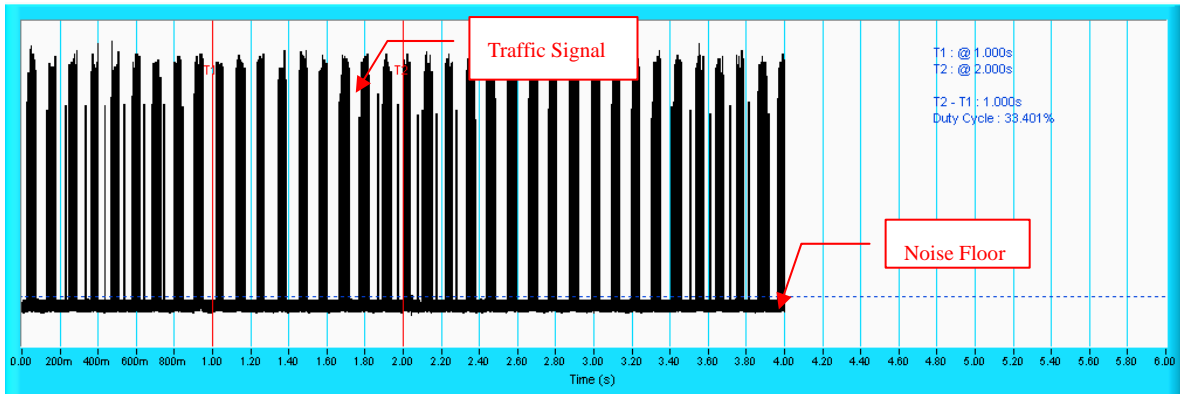

IEEE 802.11n 20MHz Duty Cycle: 32.086% / 6.5Mbps

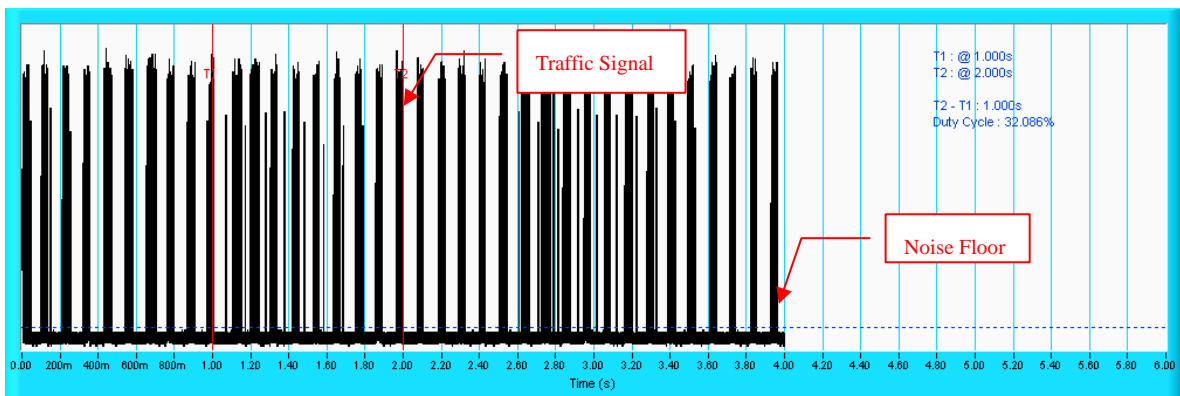

5.2 CALIBRATION OF DFS DETECTION THRESHOLD LEVEL:

The measured channel is 5500 MHz. The radar signal was the same as transmitted channels, and injected into the antenna port of AP (master) or Client Device with Radar Detection, measured the channel closing transmission time and channel move time. The calibrated conducted detection threshold level is set to -60dBm. The tested level is lower than required level hence it provides margin to the limit.

CONDUCTED SETUP CONFIGURATION OF CALIBRATION OF DFS DETECTION THRESHOLD LEVEL

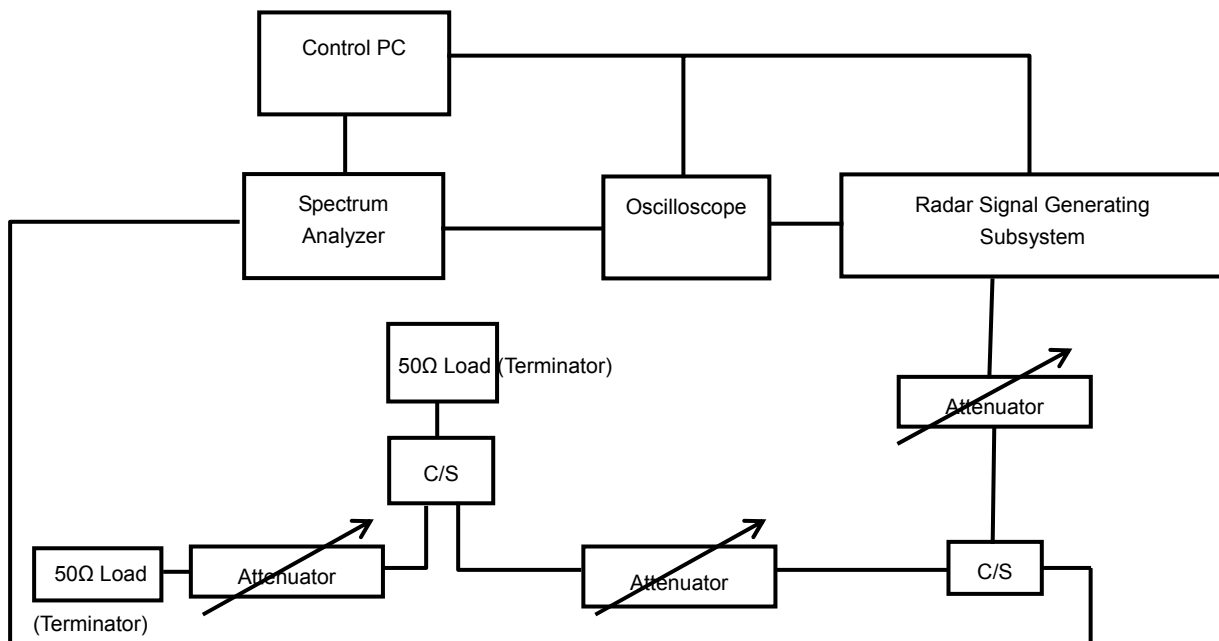

5.3 DEVIATION FROM TEST STANDARD

No deviation.

5.4 CONDUCTED TEST SETUP CONFIGURATION

5.4.1 CLIENT WITHOUT RADAR DETECTION MODE

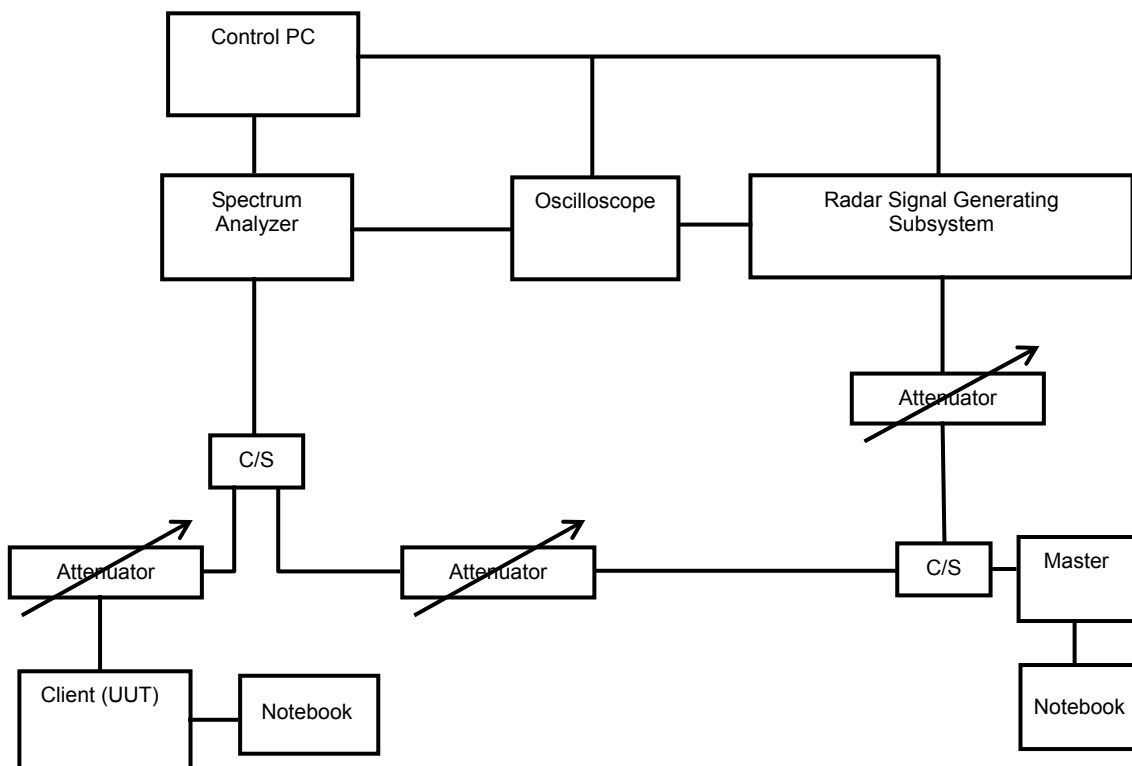

The UUT is a U-NII Device operating in Client mode without radar detection. The radar test signals are injected into the Master Device.

6. TEST RESULTS

6.1 SUMMARY OF TEST RESULTS

| CLAUSE | TEST PARAMETER | REMARKS | PASS/FAIL |
|--------|-----------------------------------|----------------|-----------|
| 15.407 | DFS Detection Threshold | Not Applicable | NA |
| 15.407 | Channel Availability Check Time | Not Applicable | NA |
| 15.407 | Channel Move Time | Applicable | Pass |
| 15.407 | Channel Closing Transmission Time | Applicable | Pass |
| 15.407 | Non- Occupancy Period | Applicable | Pass |
| 15.407 | Uniform Spreading | Not Applicable | NA |
| 15.407 | U-NII Detection Bandwidth | Not Applicable | NA |
| 15.407 | Non-associated test | Not Applicable | NA |

6.2 DETELED TEST RESULTS

6.2.1 TEST MODE: DEVICE OPERATING IN CLIENT WITHOUT RADAR DETECTION MODE.

Client with injection at the Master. (The radar test signals are injected into the Master Device)

6.2.1.1 DFS DETECTION THRESHOLD

For a detection threshold level of -62dBm and the Master antenna gain is 2dBi . The Required detection threshold is -60 dBm ($= -62 + 2$) dBm . The tested level is lower than required level hence it provides margin to the limit.

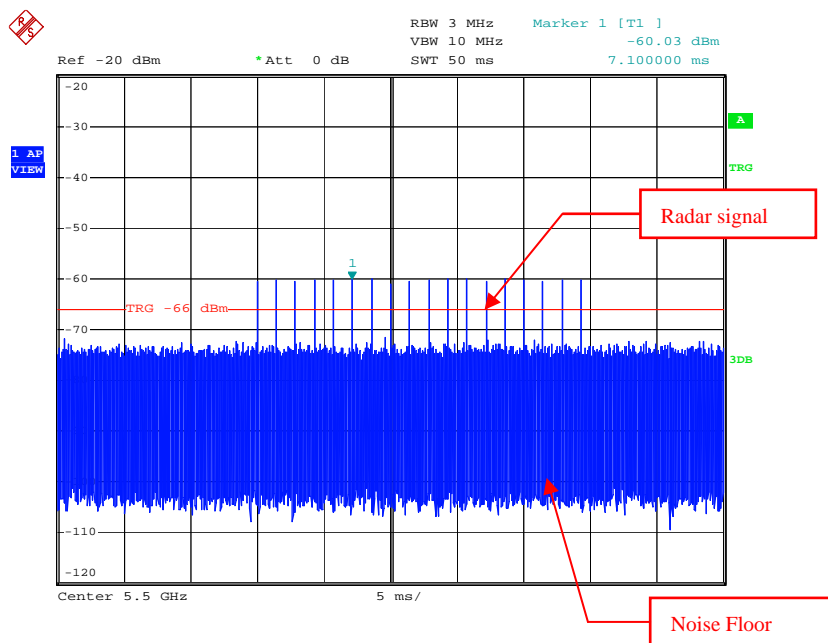

Radar Signal 1



6.2.1.2 CHANNEL CLOSING TRANSMISSION AND CHANNEL MOVE TIME

RADAR SIGNAL 1

802.11a

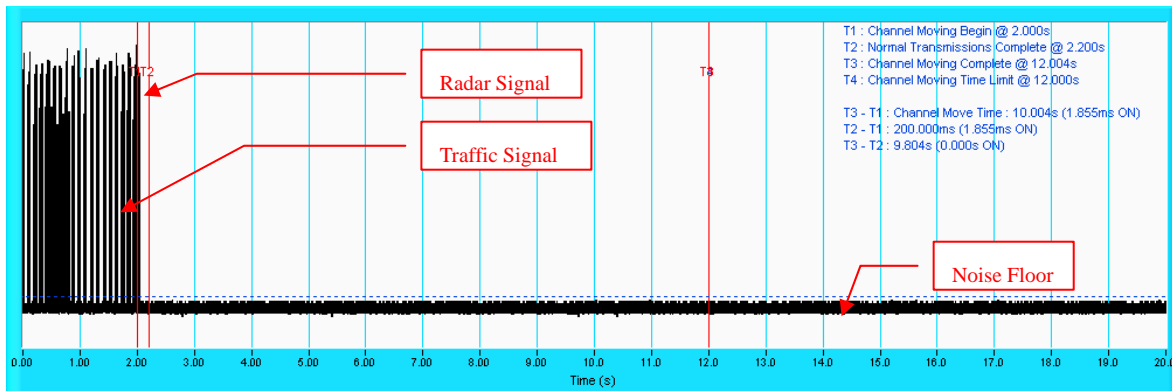

NOTE: T1 denotes the start of Channel Move Time upon the end of the last Radar burst. T2 denotes the data transmission time of 200ms from T1. T3 denotes the end of Channel Move Time. T4 denotes the 10 second from T1 to observe the aggregate duration of transmissions.

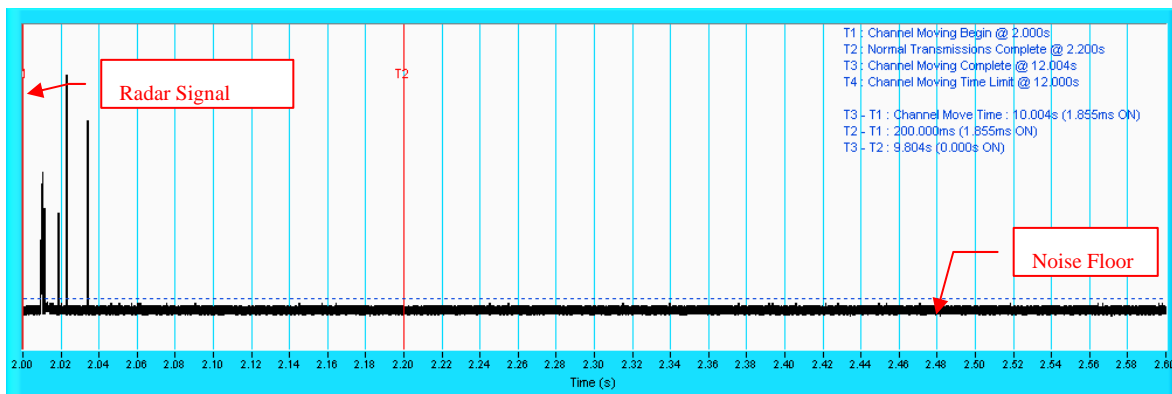

NOTE: A Zoom plot for the device vacates the channel in the required 600ms.



A D T

802.11n 20MHz

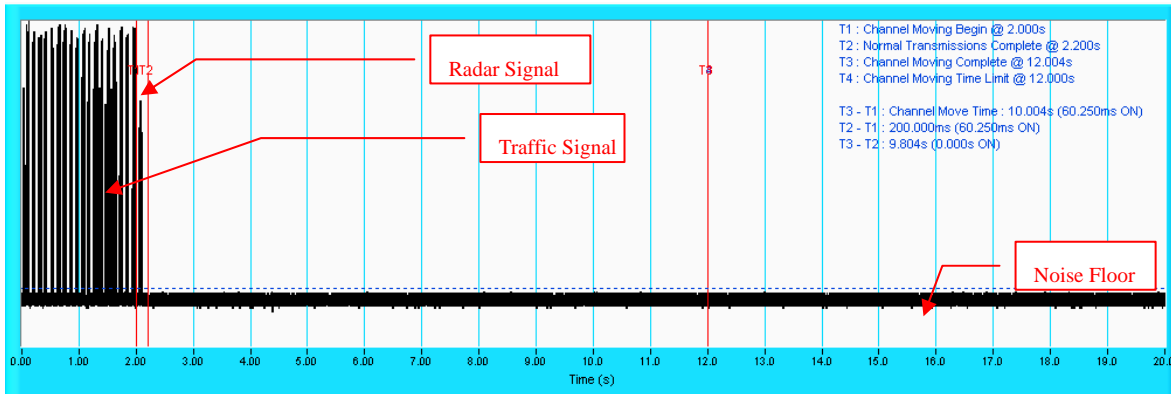

NOTE: T1 denotes the start of Channel Move Time upon the end of the last Radar burst. T2 denotes the data transmission time of 200ms from T1. T3 denotes the end of Channel Move Time. T4 denotes the 10 second from T1 to observe the aggregate duration of transmissions.

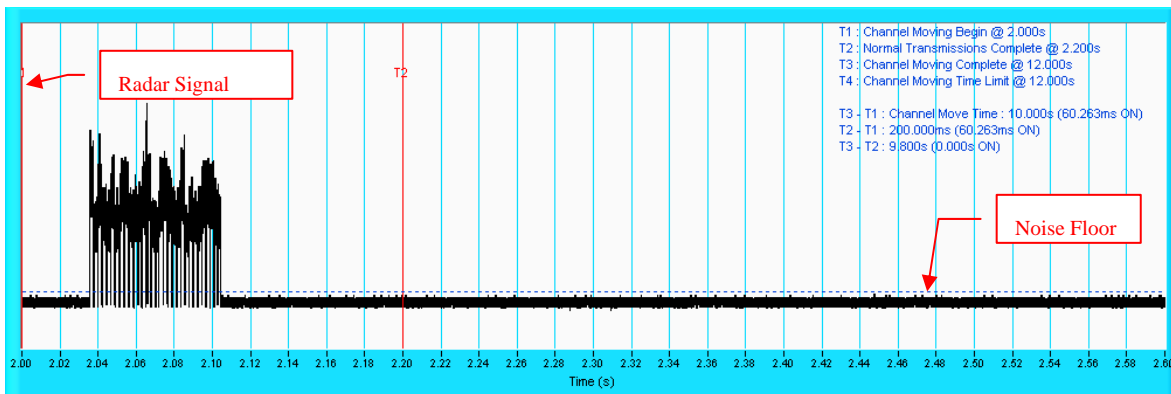

NOTE: A Zoom plot for the device vacates the channel in the required 600ms.

6.2.2 NON-OCCUPANCY PERIOD

Associate test:

During the 30 minutes observation time, UUT did not make any transmissions on a channel after a radar signal was detected on that channel by either the Channel Availability Check or the In-Service Monitoring.

- 1) EUT links up with Master at 5500MHz.

Waveform of EUT links up with Master

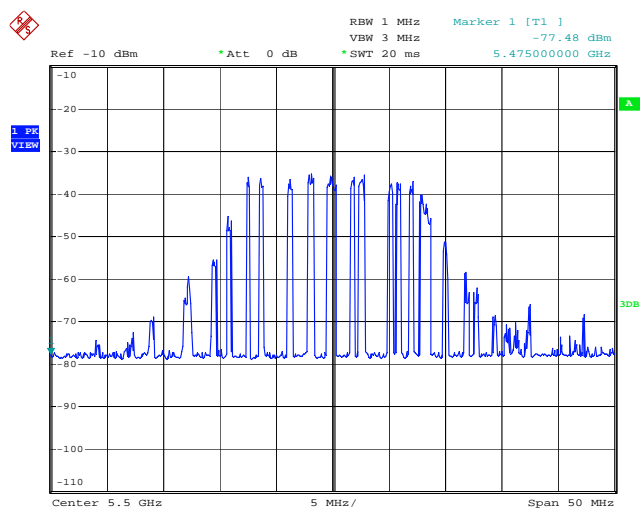

- 2) EUT receives test file from Master.

Waveform of transmission

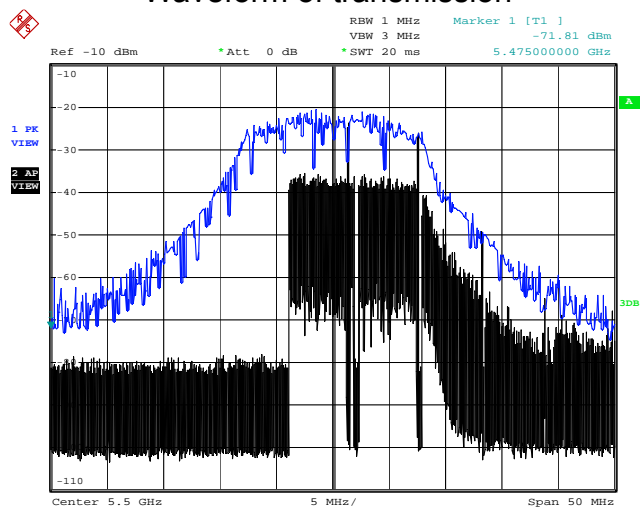

3) Radar 1 is used for DFS testing

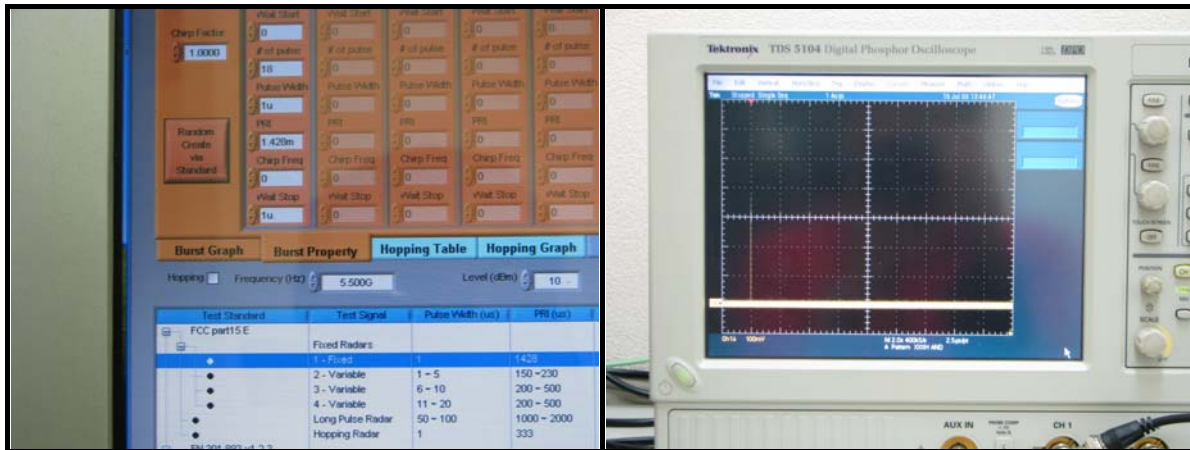

4) 5500MHz has been monitored in 30 minutes period. In this period, no any transmission occurs.

Plot of 30minutes period

802.11n 20MHz

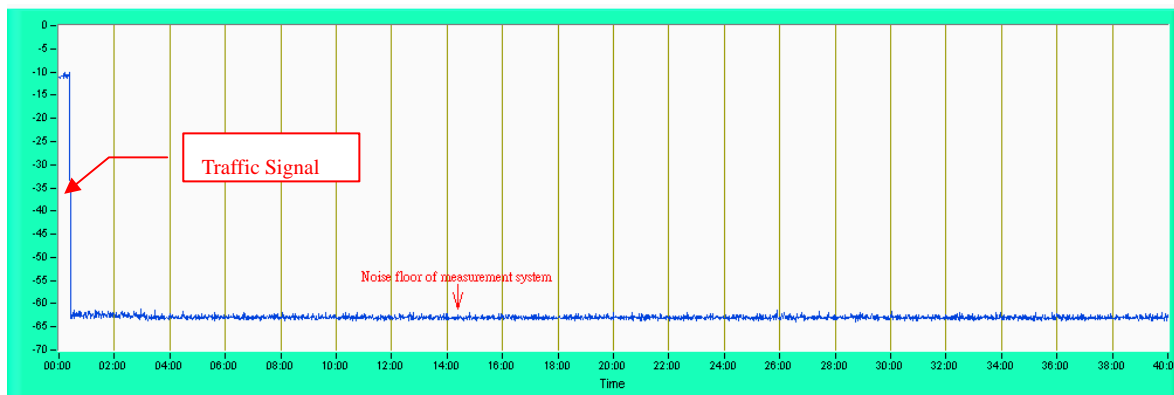

NOTE: Test setup are shown on TSup_L6ARDJ20WW.pdf



7. TESTING LABORATORIES INFORMATION

We, Bureau Veritas Consumer Products Services (H.K.) Ltd., Taoyuan Branch, were founded in 1988 to provide our best service in EMC, Radio, Telecom and Safety consultation. Our laboratories are accredited and approved according to ISO/IEC 17025.

Copies of accreditation certificates of our laboratories obtained from approval agencies can be downloaded from our web site:

www.adt.com.tw/index.5.phtml. If you have any comments, please feel free to contact us at the following:

Linko EMC/RF Lab:

Tel: 886-2-26052180

Fax: 886-2-26051924

Hsin Chu EMC/RF Lab:

Tel: 886-3-5935343

Fax: 886-3-5935342

Hwa Ya EMC/RF/Safety Telecom Lab:

Tel: 886-3-3183232

Fax: 886-3-3185050

Web Site: www.adt.com.tw

The address and road map of all our labs can be found in our web site also.

---END---