	Document		Page
	<b>Annex B to Hearing Aid Compatibility RF Emissions Test Report for the BlackBerry® Smartphone model RDH71CW</b>		1(25)
Author Data	Dates of Test	Report No	FCC ID
<b>Daoud Attayi</b>	<b>Jan. 12-19, 2011</b>	<b>RTS-2605-1102-02</b>	<b>L6ARDH70CW</b>

## **Annex B: Probe and dipole description and calibration certificates**

### **B.1 Probe, measurement chain description, specification and calibration certificate**

	Document		Page
	<b>Annex B to Hearing Aid Compatibility RF Emissions Test Report for the BlackBerry® Smartphone model RDH71CW</b>		2(25)
Author Data <b>Daoud Attayi</b>	Dates of Test <b>Jan. 12-19, 2011</b>	Report No <b>RTS-2605-1102-02</b>	FCC ID <b>L6ARDH70CW</b>

DASY Dosimetric Assessment System by Schmid & Partner Engineering AG

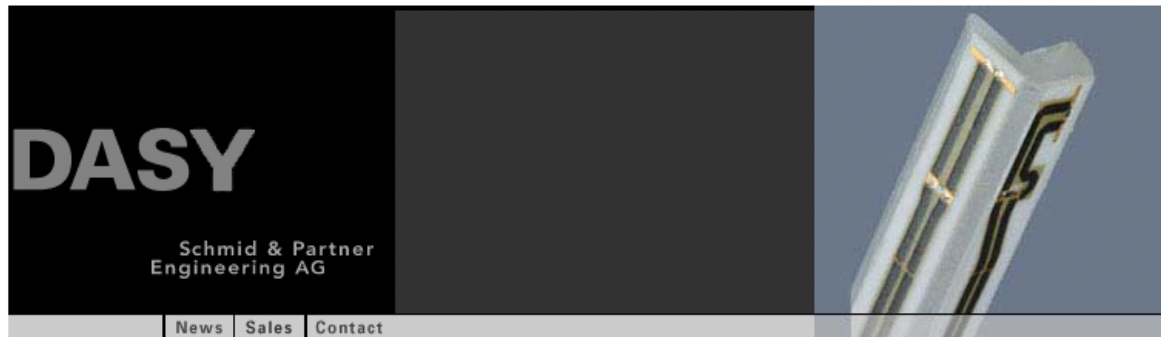

- Applications**
- Support & Downloads**
- Products**
  - DASY4 Packages
  - EASY4
  - Probes
    - ET3DV6 - Isotropic Dos-Probe
    - ES3DV3 - Isotropic Dos-Probe
    - EX3DV4 - Isotropic Dos-Probe
    - ET1DV3 - D-Probe
  - EUV3 - Universal Vector E-Probe
  - H3DV6 - Isotropic H-Probe
  - HUV4 - Universal Vector H-Probe
  - T1V3 - Temp-Probe
  - DP1 - Dummy-Probe
  - Data Acquisition System
  - Software
  - Phantoms
  - Robots
  - Validation Kits & Calibration Dipoles
    - Hearing Aid Compatibility (HAC) Ext
    - Tissue Simulating Liquids
- SPEAG Home**

### ER3DV6 ISOTROPIC E-FIELD PROBE FOR GENERAL NEAR-FIELD MEASUREMENTS

 [Download Product Flyer \(PDF, 192kB\)](#)

<b>Construction</b>	One dipole parallel, two dipoles normal to probe axis Built-in shielding against static charges PEEK enclosure material (resistant to organic solvents, e.g., glycoether)
<b>Calibration</b>	In air from 100 MHz to 3.0 GHz (absolute accuracy $\pm 6.0\%$ , $k=2$ )
<b>Frequency</b>	100 MHz to > 6 GHz; Linearity: $\pm 0.2$ dB (100 MHz to 3 GHz)
<b>Directivity</b>	$\pm 0.2$ dB in air (rotation around probe axis) $\pm 0.4$ dB in air (rotation normal to probe axis)
<b>Dynamic Range</b>	2 V/m to > 1000 V/m; Linearity: $\pm 0.2$ dB
<b>Dimensions</b>	Overall length: 330 mm (Tip: 16 mm) Tip diameter: 8 mm (Body: 12 mm) Distance from probe tip to dipole centers: 2.5 mm
<b>Application</b>	General near-field measurements up to 6 GHz Field component measurements Fast automatic scanning in phantoms

<http://www.dasy4.com/er3.htm>

	Document		Page
	<b>Annex B to Hearing Aid Compatibility RF Emissions Test Report for the BlackBerry® Smartphone model RDH71CW</b>		<b>3(25)</b>
Author Data	Dates of Test	Report No	FCC ID
<b>Daoud Attayi</b>	<b>Jan. 12-19, 2011</b>	<b>RTS-2605-1102-02</b>	<b>L6ARDH70CW</b>

DASY Dosimetric Assessment System by Schmid & Partner Engineering AG

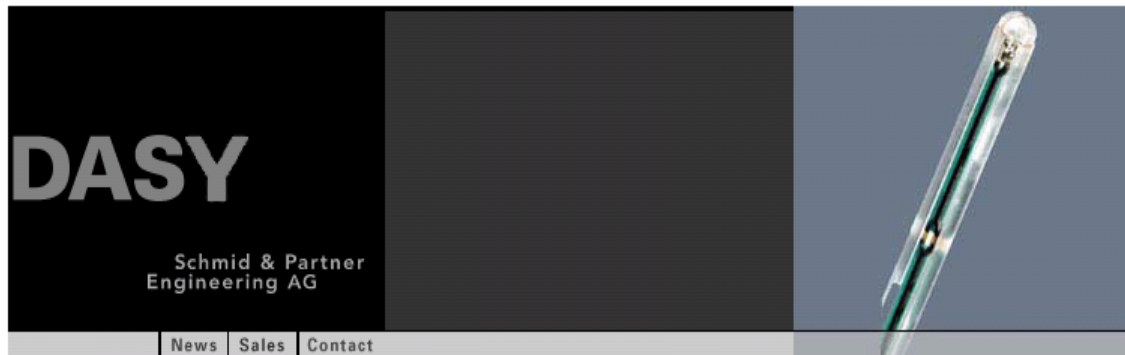

<b>Applications</b>
<b>Support &amp; Downloads</b>
<b>Products</b>
<ul style="list-style-type: none"> <li>▪ DASY4 Packages</li> <li>▪ EASY4</li> <li>▪ Probes <ul style="list-style-type: none"> <li>ET3DV6 - Isotropic Dos-Probe</li> <li>ES3DV3 - Isotropic Dos-Probe</li> <li>EX3DV4 - Isotropic Dos-Probe</li> <li>ET1DV3 - D-Probe</li> <li>ER3DV6 - Isotropic E-Probe</li> <li>EUV3 - Universal Vector E-Probe</li> </ul> </li> <li>HUV4 - Universal Vector H-Probe</li> <li>T1V3 - Temp-Probe</li> <li>DP1 - Dummy-Probe</li> <li>▪ Data Acquisition System</li> <li>▪ Software</li> <li>▪ Phantoms</li> <li>▪ Robots</li> <li>▪ Validation Kits &amp; Calibration Dipoles</li> <li>▪ Hearing Aid Compatibility (HAC) Ext</li> <li>▪ Tissue Simulating Liquids</li> </ul>
<b>SPEAG Home</b>

### H3DV6 3-DIMENSIONAL H-FIELD PROBE FOR SMALL BAND APPLICATIONS

 [Download Product Flyer \(PDF, 192kB\)](#)

<b>Construction</b>	Three concentric loop sensors with 3.8 mm loop diameters Resistively loaded detector diodes for linear response Built-in shielding against static charges PEEK enclosure material (resistant to organic solvents, e.g., glycoether)
<b>Frequency</b>	200 MHz to 3 GHz (absolute accuracy $\pm 6.0\%$ , $k=2$ ); Output linearized
<b>Directivity</b>	$\pm 0.25$ dB (spherical isotropy error)
<b>Dynamic Range</b>	10 mA/m to 2 A/m at 1 GHz
<b>E-Field Interference</b>	< 10% at 3 GHz (for plane wave)
<b>Dimensions</b>	Overall length: 330 mm (Tip: 40 mm) Tip diameter: 6 mm (Body: 12 mm) Distance from probe tip to dipole centers: 3 mm
<b>Application</b>	General magnetic near-field measurements up to 3 GHz Field component measurements Surface current measurements Measurements in air or liquids Low interaction with the measured field

<http://www.dasy4.com/h3d.htm>

	Document <b>Annex B to Hearing Aid Compatibility RF Emissions Test Report for the BlackBerry® Smartphone model RDH71CW</b>		Page <b>4(25)</b>
	Author Data <b>Daoud Attayi</b>	Dates of Test <b>Jan. 12-19, 2011</b>	Report No <b>RTS-2605-1102-02</b>

All measurements were performed to the nearest element point as per the C63.19 standard. Offset distances were entered in the DASY4 software so that the measurement was to the nearest element.

Figures 1 and 2, provided by the manufacturer, illustrate detail of the probe tip and its dimensions.

**ER3DV6 E-Field probe:** The distances from the probe tip to the closest points on the dipole sensors are 1.45mm for X and Y and 1.25mm for Z. From the probe tip to the center of the sensors is 2.5mm.

**H3DV6 H-Field probe:** The distance from the probe tip to the closest point of the X, Y and Z loop sensors is 1.1mm. From the probe tip to the center of the sensor is 3.00mm.



**E-Field Probe (ER3DV6)**

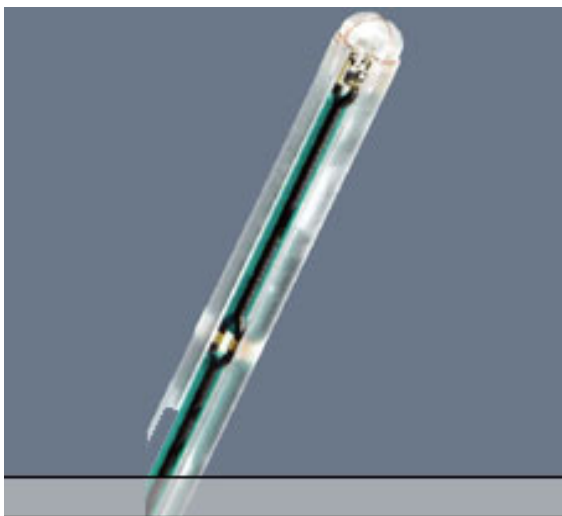
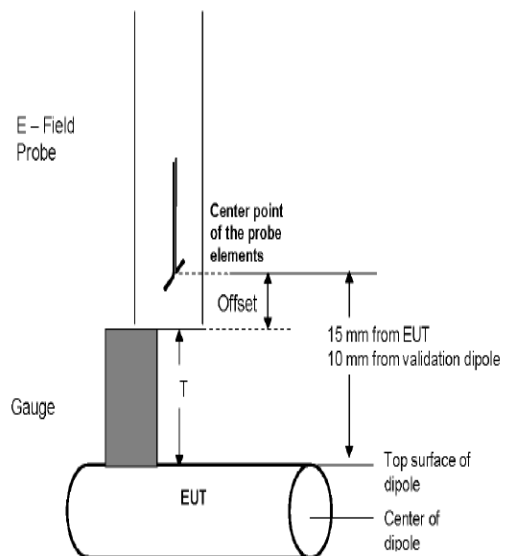

**H-Field Probe (H3DV6)**

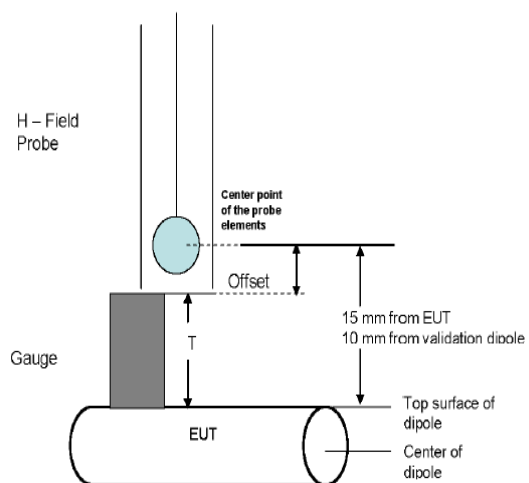

	Document		Page
	<b>Annex B to Hearing Aid Compatibility RF Emissions Test Report for the BlackBerry® Smartphone model RDH71CW</b>		5(25)
Author Data <b>Daoud Attayi</b>	Dates of Test <b>Jan. 12-19, 2011</b>	Report No <b>RTS-2605-1102-02</b>	FCC ID <b>L6ARDH70CW</b>

The following information is from the system manufacturer user manual describing the process chain:

The first step of the evaluation is a linearization of the filtered input signal to account for the compression characteristics of the detector diode. The compensation depends on the input signal, the diode type and the DC-transmission factor from the diode to the evaluation electronics. If the exciting field is pulsed, the crest factor of the signal must be known to correctly compensate for peak power. The formula for each channel can be given as:

$$V_i = U_i + U_i^2 \cdot \frac{cf}{dcp_i} \quad (20.1)$$

with  $V_i$  = compensated signal of channel i (i = x, y, z)  
 $U_i$  = input signal of channel i (i = x, y, z)  
 $cf$  = crest factor of exciting field (DASY parameter)  
 $dcp_i$  = diode compression point (DASY parameter)

From the compensated input signals the primary field data for each channel can be evaluated:

$$\text{E - fieldprobes : } E_i = \sqrt{\frac{V_i}{Norm_i \cdot ConvF}}$$

$$\text{H - fieldprobes : } H_i = \sqrt{V_i} \cdot \frac{a_{i0} + a_{i1}f + a_{i2}f^2}{f}$$

with  $V_i$  = compensated signal of channel i (i = x, y, z)  
 $Norm_i$  = sensor sensitivity of channel i (i = x, y, z)  
 $\mu V/(V/m)^2$  for E-field Probes  
 $ConvF$  = sensitivity enhancement in solution  
 $a_{ij}$  = sensor sensitivity factors for H-field probes  
 $f$  = carrier frequency [GHz]  
 $E_i$  = electric field strength of channel i in V/m  
 $H_i$  = magnetic field strength of channel i in A/m

The RSS value of the field components gives the total field strength (Hermitian magnitude):

$$E_{tot} = \sqrt{E_x^2 + E_y^2 + E_z^2} \quad (20.2)$$

The measurement / integration time per point is > 500 ms, as per the system manufacturer:

The time response of the field probes has been assessed by exposing the probe to a well-controlled field producing signals larger than HAC E- and H-fields of class M4. The signal response time is evaluated as the time required by the system to reach 90% of the expected final value after an on/off switch of the power source with an integration time of 500 ms and a probe response time of <5 ms. In the current implementation, DASY4 waits longer than 100ms after having reached the grid point before starting a measurement, i.e., the response time uncertainty is negligible.

If the device under test does not emit a CW signal, the integration time applied to measure the electric field at a specific point may introduce additional uncertainties due to the discretization. The tolerances for the different systems had the worst-case of 2.6%.

	Document		Page
	<b>Annex B to Hearing Aid Compatibility RF Emissions Test Report for the BlackBerry® Smartphone model RDH71CW</b>		<b>6(25)</b>
Author Data	Dates of Test	Report No	FCC ID
<b>Daoud Attayi</b>	<b>Jan. 12-19, 2011</b>	<b>RTS-2605-1102-02</b>	<b>L6ARDH70CW</b>

ER3DV6 SN:2285

March 8, 2010

### Other Probe Parameters

Sensor Arrangement	Rectangular
Connector Angle (°)	78.7
Mechanical Surface Detection Mode	enabled
Optical Surface Detection Mode	disabled
Probe Overall Length	337 mm
Probe Body Diameter	10 mm
Tip Length	10 mm
Tip Diameter	8.0 mm
Probe Tip to Sensor X Calibration Point	2.5 mm
Probe Tip to Sensor Y Calibration Point	2.5 mm
Probe Tip to Sensor Z Calibration Point	2.5 mm

	Document		Page
	<b>Annex B to Hearing Aid Compatibility RF Emissions Test Report for the BlackBerry® Smartphone model RDH71CW</b>		7(25)
Author Data	Dates of Test	Report No	FCC ID
<b>Daoud Attayi</b>	<b>Jan. 12-19, 2011</b>	<b>RTS-2605-1102-02</b>	<b>L6ARDH70CW</b>

**Calibration Laboratory of**  
**Schmid & Partner**  
**Engineering AG**  
 Zeughausstrasse 43, 8004 Zurich, Switzerland



**S** Schweizerischer Kalibrierdienst  
**S** Service suisse d'étalonnage  
**S** Servizio svizzero di taratura  
**S** Swiss Calibration Service



Accredited by the Swiss Accreditation Service (SAS)  
 The Swiss Accreditation Service is one of the signatories to the EA  
 Multilateral Agreement for the recognition of calibration certificates

Accreditation No.: **SCS 108**

Client **RTS (RIM Testing Services)**

Certificate No: **ER3-2285\_Mar10**

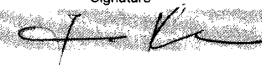
### CALIBRATION CERTIFICATE

Object	<b>ER3DV6 - SN:2285</b>		
Calibration procedure(s)	<b>QA CAL-02.v5 and QA CAL-25.v2 Calibration procedure for E-field probes optimized for close near field evaluations in air</b>		
Calibration date:	<b>March 8, 2010</b>		
<p>This calibration certificate documents the traceability to national standards, which realize the physical units of measurements (SI).          The measurements and the uncertainties with confidence probability are given on the following pages and are part of the certificate.</p> <p>All calibrations have been conducted in the closed laboratory facility: environment temperature (22 ± 3)°C and humidity &lt; 70%.</p> <p>Calibration Equipment used (M&amp;TE critical for calibration)</p>			
<b>Primary Standards</b>	<b>ID #</b>	<b>Cal Date (Certificate No.)</b>	<b>Scheduled Calibration</b>
Power meter E4419B	GB41293874	1-Apr-09 (No. 217-01030)	Apr-10
Power sensor E4412A	MY41495277	1-Apr-09 (No. 217-01030)	Apr-10
Power sensor E4412A	MY41498087	1-Apr-09 (No. 217-01030)	Apr-10
Reference 3 dB Attenuator	SN: S5054 (3c)	31-Mar-09 (No. 217-01026)	Mar-10
Reference 20 dB Attenuator	SN: S5086 (20b)	31-Mar-09 (No. 217-01028)	Mar-10
Reference 30 dB Attenuator	SN: S5129 (30b)	31-Mar-09 (No. 217-01027)	Mar-10
Reference Probe ER3DV6	SN: 2328	3-Oct-09 (No. ER3-2328_Oct09)	Oct-10
DAE4	SN: 789	23-Dec-09 (No. DAE4-789_Dec09)	Dec-10
<b>Secondary Standards</b>	<b>ID #</b>	<b>Check Date (in house)</b>	<b>Scheduled Check</b>
RF generator HP 8648C	US3642U01700	4-Aug-99 (in house check Oct-09)	In house check: Oct-11
Network Analyzer HP 8753E	US37390585	18-Oct-01 (in house check Oct-09)	In house check: Oct10
Calibrated by:	Name <b>Jeton Kastalli</b>	Function <b>Laboratory Technician</b>	Signature 
Approved by:	Name <b>Katja Pokovic</b>	Technical Manager	
			Issued: March 10, 2010
This calibration certificate shall not be reproduced except in full without written approval of the laboratory.			

Certificate No: ER3-2285\_Mar10

Page 1 of 10

	Document		Page
	<b>Annex B to Hearing Aid Compatibility RF Emissions Test Report for the BlackBerry® Smartphone model RDH71CW</b>		8(25)
Author Data <b>Daoud Attayi</b>	Dates of Test <b>Jan. 12-19, 2011</b>	Report No <b>RTS-2605-1102-02</b>	FCC ID <b>L6ARDH70CW</b>

**Calibration Laboratory of Schmid & Partner Engineering AG**  
Zeughausstrasse 43, 8004 Zurich, Switzerland



**S** Schweizerischer Kalibrierdienst  
**C** Service suisse d'étalonnage  
**S** Servizio svizzero di taratura  
**S** Swiss Calibration Service

Accredited by the Swiss Accreditation Service (SAS)  
The Swiss Accreditation Service is one of the signatories to the EA  
Multilateral Agreement for the recognition of calibration certificates

Accreditation No.: **SCS 108**

**Glossary:**

**NORM<sub>x,y,z</sub>** sensitivity in free space  
**DCP** diode compression point  
**CF** crest factor (1/duty\_cycle) of the RF signal  
**A, B, C** modulation dependent linearization parameters  
**Polarization  $\phi$**   $\phi$  rotation around probe axis  
**Polarization  $\vartheta$**   $\vartheta$  rotation around an axis that is in the plane normal to probe axis (at measurement center), i.e.,  $\vartheta = 0$  is normal to probe axis  
**Connector Angle** information used in DASY system to align probe sensor X to the robot coordinate system

**Calibration is Performed According to the Following Standards:**

- a) IEEE Std 1309-2005, "IEEE Standard for calibration of electromagnetic field sensors and probes, excluding antennas, from 9 kHz to 40 GHz", December 2005.

**Methods Applied and Interpretation of Parameters:**

- **NORM<sub>x,y,z</sub>**: Assessed for E-field polarization  $\vartheta = 0$  for XY sensors and  $\vartheta = 90$  for Z sensor ( $f \leq 900$  MHz in TEM-cell;  $f > 1800$  MHz: R22 waveguide).
- **NORM(f)<sub>x,y,z</sub>** = **NORM<sub>x,y,z</sub>** \* *frequency\_response* (see Frequency Response Chart).
- **DCP<sub>x,y,z</sub>**: DCP are numerical linearization parameters assessed based on the data of power sweep with CW signal (no uncertainty required). DCP does not depend on frequency nor media.
- **A<sub>x,y,z</sub>; B<sub>x,y,z</sub>; C<sub>x,y,z</sub>; VR<sub>x,y,z</sub>**: A, B, C are numerical linearization parameters assessed based on the data of power sweep for specific modulation signal. The parameters do not depend on frequency nor media. VR is the maximum calibration range expressed in RMS voltage across the diode.
- **Spherical isotropy (3D deviation from isotropy)**: in a locally homogeneous field realized using an open waveguide setup.
- **Sensor Offset**: The sensor offset corresponds to the offset of virtual measurement center from the probe tip (on probe axis). No tolerance required.
- **Connector Angle**: The angle is assessed using the information gained by determining the **NORM<sub>x</sub>** (no uncertainty required).



	Document		Page
	<b>Annex B to Hearing Aid Compatibility RF Emissions Test Report for the BlackBerry® Smartphone model RDH71CW</b>		<b>9(25)</b>
Author Data	Dates of Test	Report No	FCC ID
<b>Daoud Attayi</b>	<b>Jan. 12-19, 2011</b>	<b>RTS-2605-1102-02</b>	<b>L6ARDH70CW</b>

ER3DV6 SN:2285

March 8, 2010

# Probe ER3DV6

## SN:2285

Manufactured: September 20, 2002  
 Last calibrated: March 2, 2009  
 Recalibrated: March 8, 2010

Calibrated for DASY Systems

(Note: non-compatible with DASY2 system!)

	Document		Page
	<b>Annex B to Hearing Aid Compatibility RF Emissions Test Report for the BlackBerry® Smartphone model RDH71CW</b>		10(25)
Author Data	Dates of Test	Report No	FCC ID
<b>Daoud Attayi</b>	<b>Jan. 12-19, 2011</b>	<b>RTS-2605-1102-02</b>	<b>L6ARDH70CW</b>

ER3DV6 SN:2285

March 8, 2010

**DASY - Parameters of Probe: ER3DV6 SN:2285**

**Basic Calibration Parameters**

	Sensor X	Sensor Y	Sensor Z	Unc (k=2)
Norm ( $\mu\text{V}/(\text{V}/\text{m})^2$ )	1.26	1.42	1.61	$\pm 10.1\%$
DCP (mV) <sup>A</sup>	92.1	94.2	96.0	

**Modulation Calibration Parameters**

UID	Communication System Name	PAR		A dB	B dBuV	C	VR mV	Unc <sup>E</sup> (k=2)
10000	CW	0.00	X	0.00	0.00	1.00	300	$\pm 1.5\%$
			Y	0.00	0.00	1.00	300	
			Z	0.00	0.00	1.00	300	

The reported uncertainty of measurement is stated as the standard uncertainty of measurement multiplied by the coverage factor k=2, which for a normal distribution corresponds to a coverage probability of approximately 95%.

<sup>A</sup> numerical linearization parameter: uncertainty not required

<sup>E</sup> Uncertainty is determined using the maximum deviation from linear response applying recatangular distribution and is expressed for the square of the field value.

ER3DV6 SN:2285

March 8, 2010

### Frequency Response of E-Field

(TEM-Cell:ifi110 EXX, Waveguide R22)

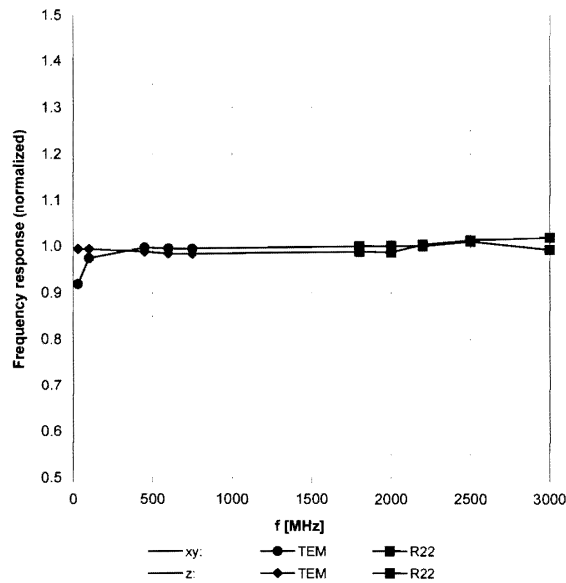

Uncertainty of Frequency Response of E-field:  $\pm 6.3\%$  (k=2)

ER3DV6 SN:2285

March 8, 2010

**Receiving Pattern ( $\phi$ ),  $\vartheta = 0^\circ$**

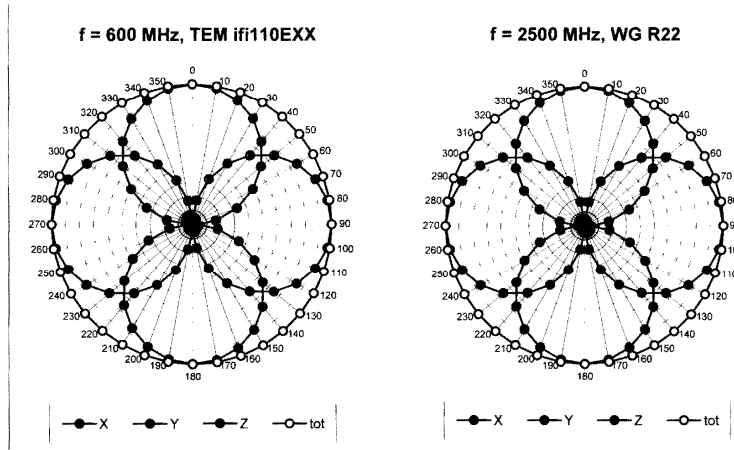

**Receiving Pattern ( $\phi$ ),  $\vartheta = 90^\circ$**

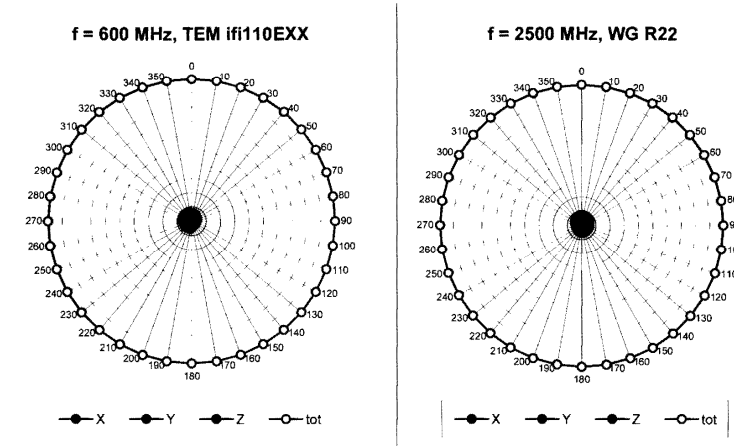

ER3DV6 SN:2285

March 8, 2010

**Receiving Pattern ( $\phi$ ),  $\vartheta = 0^\circ$**

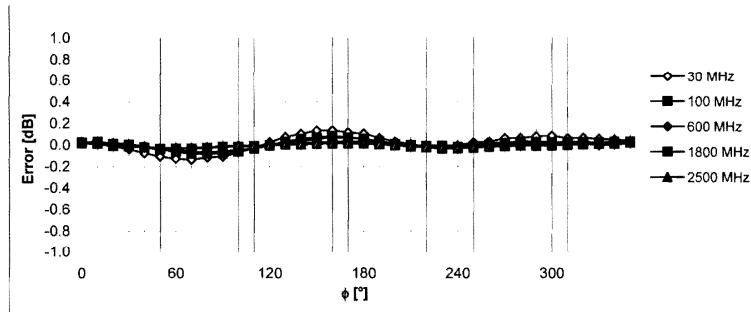

Uncertainty of Axial Isotropy Assessment:  $\pm 0.5\%$  (k=2)

**Receiving Pattern ( $\phi$ ),  $\vartheta = 90^\circ$**

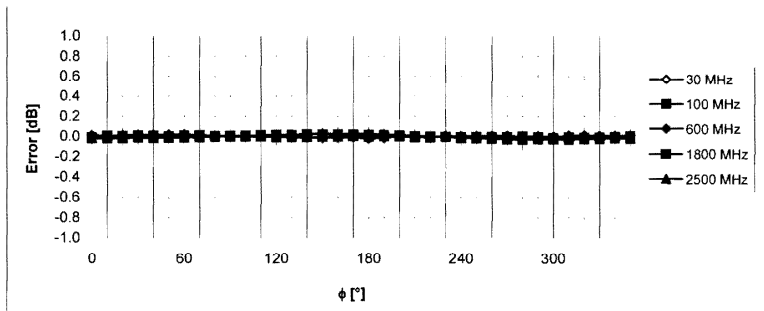

Uncertainty of Axial Isotropy Assessment:  $\pm 0.5\%$  (k=2)

ER3DV6 SN:2285

March 8, 2010

**Dynamic Range f(E-field)**  
 (Waveguide R22, f = 1800 MHz)

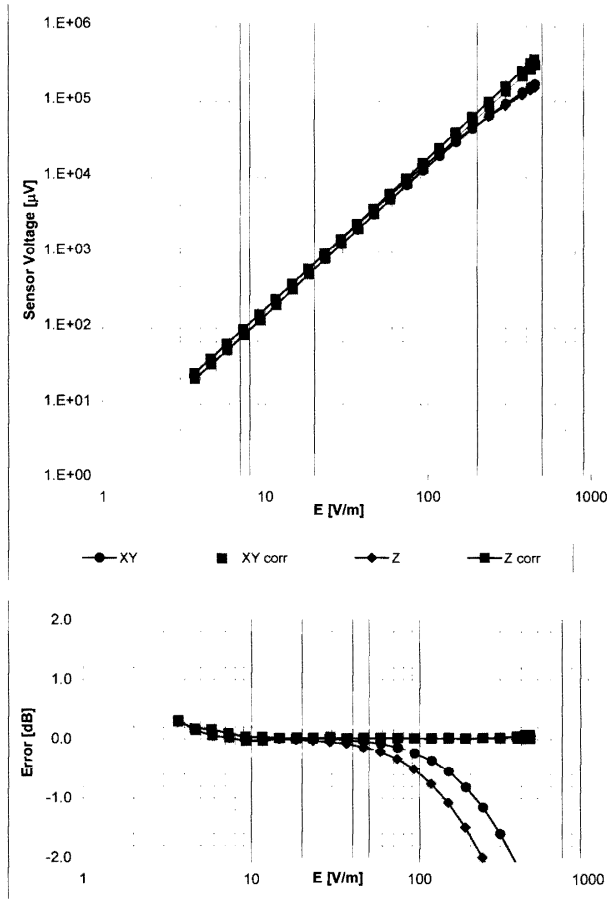

Uncertainty of Linearity Assessment:  $\pm 0.6\%$  (k=2)

ER3DV6 SN:2285

March 8, 2010

**Deviation from Isotropy in Air**  
**Error ( $\phi, \vartheta$ ),  $f = 900$  MHz**

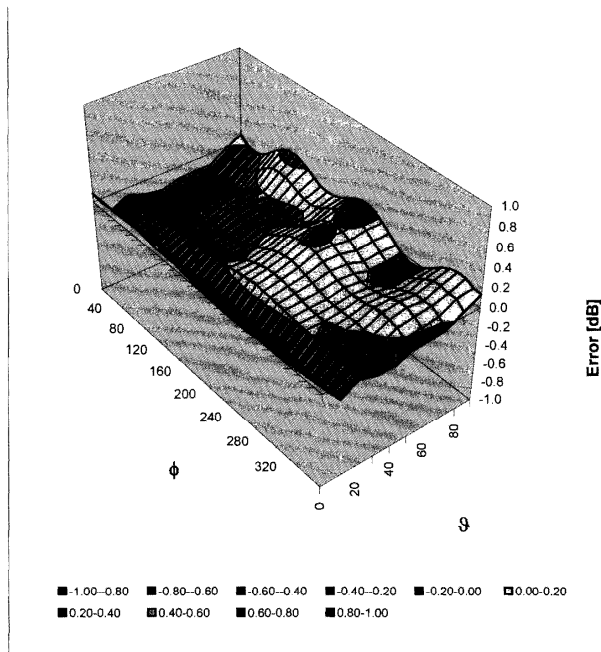

Uncertainty of Spherical Isotropy Assessment:  $\pm 2.6\%$  ( $k=2$ )

	Document		Page
	<b>Annex B to Hearing Aid Compatibility RF Emissions Test Report for the BlackBerry® Smartphone model RDH71CW</b>		16(25)
Author Data	Dates of Test	Report No	FCC ID
<b>Daoud Attayi</b>	<b>Jan. 12-19, 2011</b>	<b>RTS-2605-1102-02</b>	<b>L6ARDH70CW</b>

**Calibration Laboratory of**  
**Schmid & Partner**  
**Engineering AG**  
 Zeughausstrasse 43, 8004 Zurich, Switzerland





**S** Schweizerischer Kalibrierdienst  
**C** Service suisse d'étalonnage  
**S** Servizio svizzero di taratura  
**S** Swiss Calibration Service

Accredited by the Swiss Accreditation Service (SAS)  
 The Swiss Accreditation Service is one of the signatories to the EA  
 Multilateral Agreement for the recognition of calibration certificates

Accreditation No.: **SCS 108**

Client **RTS (RIM Testing Services)**

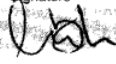
Certificate No: **H3-6168\_Mar10**

CALIBRATION CERTIFICATE																																																			
Object	<b>H3DV6 - SN:6168</b>																																																		
Calibration procedure(s)	<b>QA CAL-03.v5 and QA CAL-25.v2 Calibration procedure for H-field probes optimized for close near field evaluations in air</b>																																																		
Calibration date:	<b>March 12, 2010</b>																																																		
<p>This calibration certificate documents the traceability to national standards, which realize the physical units of measurements (SI). The measurements and the uncertainties with confidence probability are given on the following pages and are part of the certificate.</p> <p>All calibrations have been conducted in the closed laboratory facility: environment temperature (22 ± 3)°C and humidity &lt; 70%.</p> <p>Calibration Equipment used (M&amp;TE critical for calibration)</p> <table border="1"> <thead> <tr> <th>Primary Standards</th> <th>ID #</th> <th>Cal Date (Certificate No.)</th> <th>Scheduled Calibration</th> </tr> </thead> <tbody> <tr> <td>Power meter E4419B</td> <td>GB41293874</td> <td>1-Apr-09 (No. 217-01030)</td> <td>Apr-10</td> </tr> <tr> <td>Power sensor E4412A</td> <td>MY41495277</td> <td>1-Apr-09 (No. 217-01030)</td> <td>Apr-10</td> </tr> <tr> <td>Power sensor E4412A</td> <td>MY41498087</td> <td>1-Apr-09 (No. 217-01030)</td> <td>Apr-10</td> </tr> <tr> <td>Reference 3 dB Attenuator</td> <td>SN: S5054 (3c)</td> <td>31-Mar-09 (No. 217-01026)</td> <td>Mar-10</td> </tr> <tr> <td>Reference 20 dB Attenuator</td> <td>SN: S5086 (20b)</td> <td>31-Mar-09 (No. 217-01028)</td> <td>Mar-10</td> </tr> <tr> <td>Reference 30 dB Attenuator</td> <td>SN: S5129 (30b)</td> <td>31-Mar-09 (No. 217-01027)</td> <td>Mar-10</td> </tr> <tr> <td>Reference Probe H3DV6</td> <td>SN: 6182</td> <td>3-Oct-09 (No. H3-6182_Oct09)</td> <td>Oct-10</td> </tr> <tr> <td>DAE4</td> <td>SN: 789</td> <td>23-Dec-09 (No. DAE4-789_Dec09)</td> <td>Dec-10</td> </tr> </tbody> </table> <table border="1"> <thead> <tr> <th>Secondary Standards</th> <th>ID #</th> <th>Check Date (in house)</th> <th>Scheduled Check</th> </tr> </thead> <tbody> <tr> <td>RF generator HP 8648C</td> <td>US3642U01700</td> <td>4-Aug-99 (in house check Oct-09)</td> <td>In house check: Oct-11</td> </tr> <tr> <td>Network Analyzer HP 8753E</td> <td>US37390585</td> <td>18-Oct-01 (in house check Oct-09)</td> <td>In house check: Oct10</td> </tr> </tbody> </table>				Primary Standards	ID #	Cal Date (Certificate No.)	Scheduled Calibration	Power meter E4419B	GB41293874	1-Apr-09 (No. 217-01030)	Apr-10	Power sensor E4412A	MY41495277	1-Apr-09 (No. 217-01030)	Apr-10	Power sensor E4412A	MY41498087	1-Apr-09 (No. 217-01030)	Apr-10	Reference 3 dB Attenuator	SN: S5054 (3c)	31-Mar-09 (No. 217-01026)	Mar-10	Reference 20 dB Attenuator	SN: S5086 (20b)	31-Mar-09 (No. 217-01028)	Mar-10	Reference 30 dB Attenuator	SN: S5129 (30b)	31-Mar-09 (No. 217-01027)	Mar-10	Reference Probe H3DV6	SN: 6182	3-Oct-09 (No. H3-6182_Oct09)	Oct-10	DAE4	SN: 789	23-Dec-09 (No. DAE4-789_Dec09)	Dec-10	Secondary Standards	ID #	Check Date (in house)	Scheduled Check	RF generator HP 8648C	US3642U01700	4-Aug-99 (in house check Oct-09)	In house check: Oct-11	Network Analyzer HP 8753E	US37390585	18-Oct-01 (in house check Oct-09)	In house check: Oct10
Primary Standards	ID #	Cal Date (Certificate No.)	Scheduled Calibration																																																
Power meter E4419B	GB41293874	1-Apr-09 (No. 217-01030)	Apr-10																																																
Power sensor E4412A	MY41495277	1-Apr-09 (No. 217-01030)	Apr-10																																																
Power sensor E4412A	MY41498087	1-Apr-09 (No. 217-01030)	Apr-10																																																
Reference 3 dB Attenuator	SN: S5054 (3c)	31-Mar-09 (No. 217-01026)	Mar-10																																																
Reference 20 dB Attenuator	SN: S5086 (20b)	31-Mar-09 (No. 217-01028)	Mar-10																																																
Reference 30 dB Attenuator	SN: S5129 (30b)	31-Mar-09 (No. 217-01027)	Mar-10																																																
Reference Probe H3DV6	SN: 6182	3-Oct-09 (No. H3-6182_Oct09)	Oct-10																																																
DAE4	SN: 789	23-Dec-09 (No. DAE4-789_Dec09)	Dec-10																																																
Secondary Standards	ID #	Check Date (in house)	Scheduled Check																																																
RF generator HP 8648C	US3642U01700	4-Aug-99 (in house check Oct-09)	In house check: Oct-11																																																
Network Analyzer HP 8753E	US37390585	18-Oct-01 (in house check Oct-09)	In house check: Oct10																																																
Calibrated by:	Name <b>Claudio Leubler</b>	Function <b>Laboratory Technician</b>	Signature 																																																
Approved by:	Name <b>Katja Pokovic</b>	Technical Manager																																																	
			Issued: March 15, 2010																																																
This calibration certificate shall not be reproduced except in full without written approval of the laboratory.																																																			

Certificate No: H3-6168\_Mar10

Page 1 of 10



	Document		Page
	<b>Annex B to Hearing Aid Compatibility RF Emissions Test Report for the BlackBerry® Smartphone model RDH71CW</b>		17(25)
Author Data	Dates of Test	Report No	FCC ID
<b>Daoud Attayi</b>	<b>Jan. 12-19, 2011</b>	<b>RTS-2605-1102-02</b>	<b>L6ARDH70CW</b>

**Calibration Laboratory of Schmid & Partner Engineering AG**  
Zeughausstrasse 43, 8004 Zurich, Switzerland



**S** Schweizerischer Kalibrierdienst  
**C** Service suisse d'étalonnage  
**S** Servizio svizzero di taratura  
**S** Swiss Calibration Service

Accredited by the Swiss Accreditation Service (SAS)  
The Swiss Accreditation Service is one of the signatories to the EA  
Multilateral Agreement for the recognition of calibration certificates

Accreditation No.: **SCS 108**

**Glossary:**

**NORM<sub>x,y,z</sub>**: sensitivity in free space  
**DCP**: diode compression point  
**CF**: crest factor (1/duty\_cycle) of the RF signal  
**A, B, C**: modulation dependent linearization parameters  
**Polarization φ**: φ rotation around probe axis  
**Polarization ϑ**: ϑ rotation around an axis that is in the plane normal to probe axis (at measurement center), i.e., ϑ = 0 is normal to probe axis  
**Connector Angle**: information used in DASY system to align probe sensor X to the robot coordinate system

**Calibration is Performed According to the Following Standards:**

- a) IEEE Std 1309-2005, "IEEE Standard for calibration of electromagnetic field sensors and probes, excluding antennas, from 9 kHz to 40 GHz", December 2005.

**Methods Applied and Interpretation of Parameters:**

- **NORM<sub>x,y,z</sub>**: Assessed for E-field polarization ϑ = 0 for XY sensors and ϑ = 90 for Z sensor (f ≤ 900 MHz in TEM-cell; f > 1800 MHz: R22 waveguide).
- **X, Y, Z(f)\_a0a1a2** = X, Y, Z\_a0a1a2 \* frequency\_response (see Frequency Response Chart).
- **DCP<sub>x,y,z</sub>**: DCP are numerical linearization parameters assessed based on the data of power sweep with CW signal (no uncertainty required). DCP does not depend on frequency nor media.
- **A<sub>x,y,z</sub>; B<sub>x,y,z</sub>; C<sub>x,y,z</sub>; VR<sub>x,y,z</sub>**: A, B, C are numerical linearization parameters assessed based on the data of power sweep for specific modulation signal. The parameters do not depend on frequency nor media. VR is the maximum calibration range expressed in RMS voltage across the diode.
- **Spherical isotropy (3D deviation from isotropy)**: in a locally homogeneous field realized using an open waveguide setup.
- **Sensor Offset**: The sensor offset corresponds to the offset of virtual measurement center from the probe tip (on probe axis). No tolerance required.
- **Connector Angle**: The angle is assessed using the information gained by determining the X\_a0a1a2 (no uncertainty required).

	Document <b>Annex B to Hearing Aid Compatibility RF Emissions Test Report for the BlackBerry® Smartphone model RDH71CW</b>		Page <b>18(25)</b>
	Author Data <b>Daoud Attayi</b>	Dates of Test <b>Jan. 12-19, 2011</b>	Report No <b>RTS-2605-1102-02</b>

H3DV6 SN:6168

March 12, 2010

# Probe H3DV6

## SN:6168

Manufactured: July 9, 2003  
Last calibrated: March 3, 2009  
Recalibrated: March 12, 2010

Calibrated for DASY Systems

(Note: non-compatible with DASY2 system!)

	Document		Page
	<b>Annex B to Hearing Aid Compatibility RF Emissions Test Report for the BlackBerry® Smartphone model RDH71CW</b>		19(25)
Author Data <b>Daoud Attayi</b>	Dates of Test <b>Jan. 12-19, 2011</b>	Report No <b>RTS-2605-1102-02</b>	FCC ID <b>L6ARDH70CW</b>

H3DV6 SN:6168

March 12, 2010

**DASY - Parameters of Probe: H3DV6 SN:6168**

**Basic Calibration Parameters**

	Sensor X	Sensor Y	Sensor Z	Unc (k=2)
Norm (A/m / $\sqrt{\mu V}$ )	a0 2.76E-3	2.64E-3	3.14E-3	± 5.1%
Norm (A/m / $\sqrt{\mu V}$ )	a1 -1.81E-4	-8.57E-5	-2.18E-4	± 5.1%
Norm (A/m / $\sqrt{\mu V}$ )	a2 -2.18E-5	-3.81E-5	3.05E-5	± 5.1%
DCP (mV) <sup>A</sup>	81.4	94.7	83.2	

**Modulation Calibration Parameters**

UID	Communication System Name	PAR		A dB	B dBuV	C	VR mV	Unc <sup>E</sup> (k=2)
10000	CW	0.00	X	0.00	0.00	1.00	300	± 1.5 %
			Y	0.00	0.00	1.00	300	
			Z	0.00	0.00	1.00	300	

The reported uncertainty of measurement is stated as the standard uncertainty of measurement multiplied by the coverage factor k=2, which for a normal distribution corresponds to a coverage probability of approximately 95%.

<sup>A</sup> numerical linearization parameter: uncertainty not required

<sup>E</sup> Uncertainty is determined using the maximum deviation from linear response applying rectangular distribution and is expressed for the square of the field value.

H3DV6 SN:6168

March 12, 2010

### Frequency Response of H-Field

(TEM-Cell: ifi110 EXX, Waveguide R22)

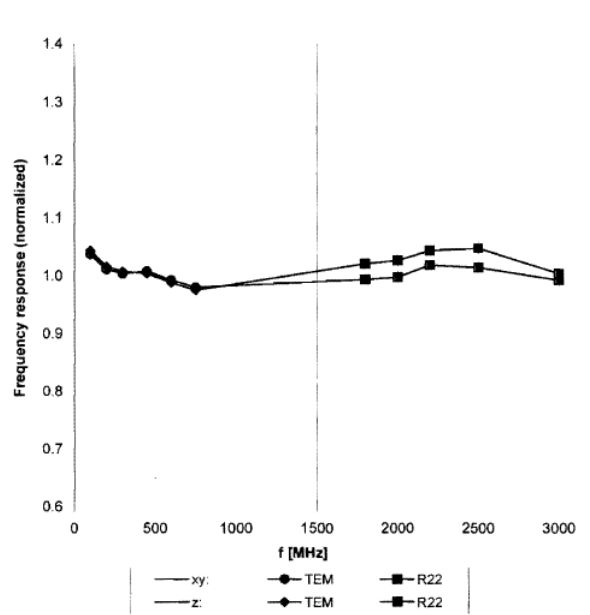

Uncertainty of Frequency Response of H-field:  $\pm 6.3\%$  (k=2)

H3DV6 SN:6168

March 12, 2010

**Receiving Pattern ( $\phi$ ),  $\vartheta = 90^\circ$**

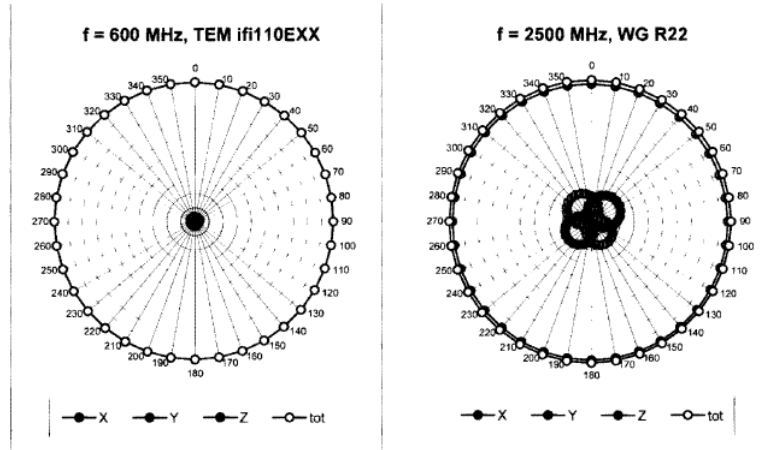

**Receiving Pattern ( $\phi$ ),  $\vartheta = 0^\circ$**

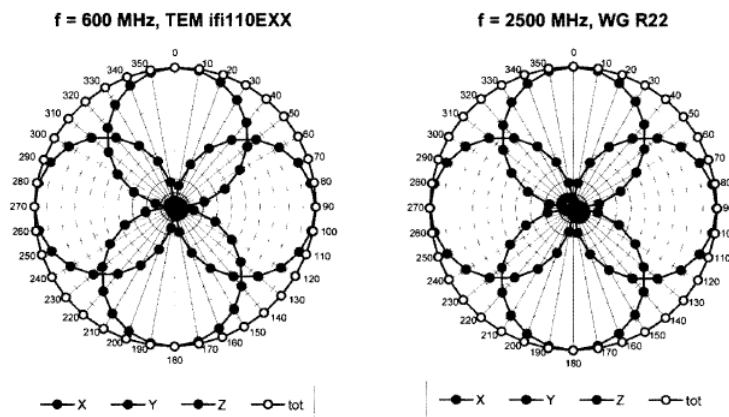

H3DV6 SN:6168

March 12, 2010

**Receiving Pattern ( $\phi$ ),  $\vartheta = 90^\circ$**

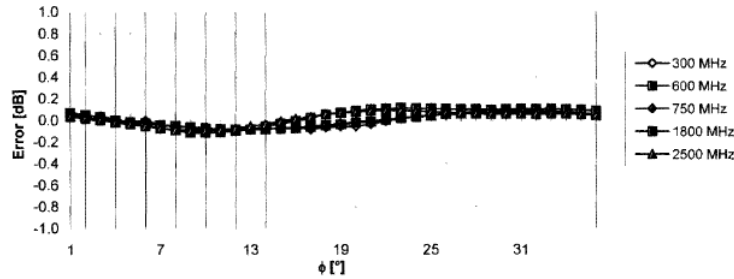

Uncertainty of Axial Isotropy Assessment:  $\pm 0.5\%$  (k=2)

**Receiving Pattern ( $\phi$ ),  $\vartheta = 0^\circ$**

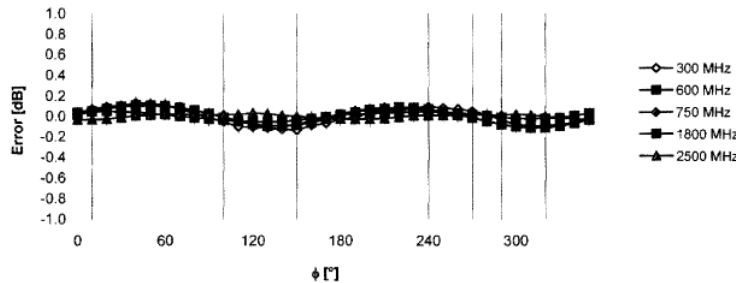

Uncertainty of Axial Isotropy Assessment:  $\pm 0.5\%$  (k=2)

H3DV6 SN:6168

March 12, 2010

**Dynamic Range f(H-field)**  
 (Waveguide R22, f = 1800 MHz)

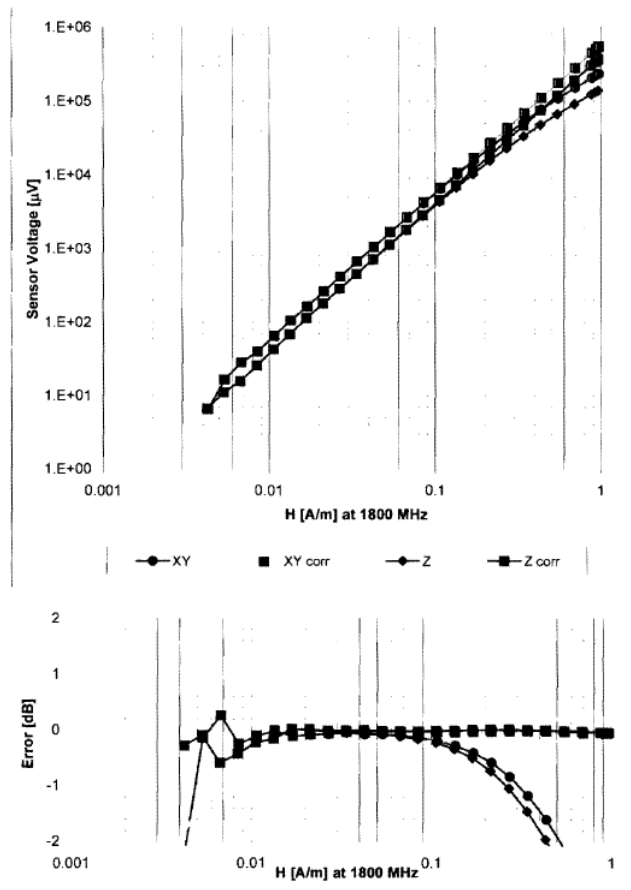

Uncertainty of Linearity Assessment: ± 0.6% (k=2)

H3DV6 SN:6168

March 12, 2010

**Deviation from Isotropy in Air**  
**Error ( $\phi, \theta$ ),  $f = 900$  MHz**

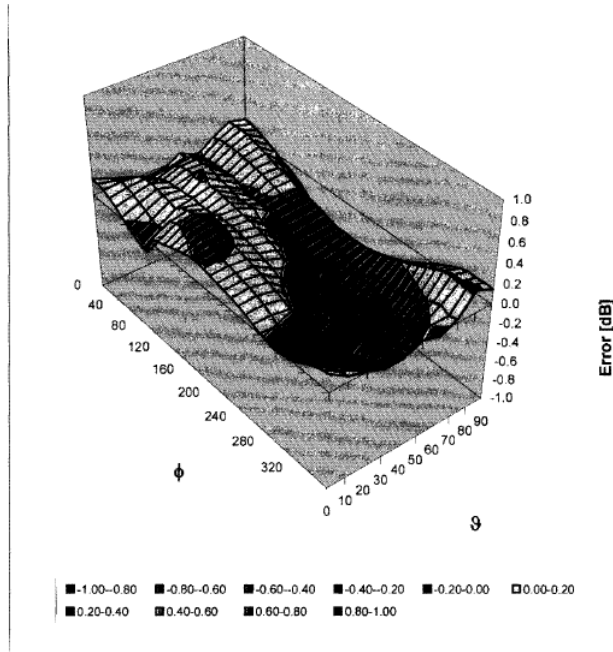

Uncertainty of Spherical Isotropy Assessment:  $\pm 2.6\%$  (k=2)



	Document		Page
	<b>Annex B to Hearing Aid Compatibility RF Emissions Test Report for the BlackBerry® Smartphone model RDH71CW</b>		25(25)
Author Data	Dates of Test	Report No	FCC ID
<b>Daoud Attayi</b>	<b>Jan. 12-19, 2011</b>	<b>RTS-2605-1102-02</b>	<b>L6ARDH70CW</b>

H3DV6 SN:6168

March 12, 2010

### Other Probe Parameters

Sensor Arrangement	Rectangular
Connector Angle (°)	-232.8
Mechanical Surface Detection Mode	enabled
Optical Surface Detection Mode	disabled
Probe Overall Length	337 mm
Probe Body Diameter	10 mm
Tip Length	20 mm
Tip Diameter	6.0 mm
Probe Tip to Sensor X Calibration Point	3 mm
Probe Tip to Sensor Y Calibration Point	3 mm
Probe Tip to Sensor Z Calibration Point	3 mm