	Document Appendix A for the BlackBerry® Smartphone Model RDU71CW/RDE71UW SAR Report Rev1			Page 1(27)
	Author Data Andrew Becker	Dates of Test Feb 7 – May 25, July 18, 2011	Test Report No RTS-3933-1105-11A RTS-2580-1106-03 Rev1	FCC ID: L6ARDU70CW L6ARDE70UW

APPENDIX A: SAR DISTRIBUTION COMPARISON FOR ACCURACY VERIFICATION

	Document Appendix A for the BlackBerry® Smartphone Model RDU71CW/RDE71UW SAR Report Rev1			Page 2(27)
	Author Data Andrew Becker	Dates of Test Feb 7 – May 25, July 18, 2011	Test Report No RTS-3933-1105-11A RTS-2580-1106-03 Rev1	FCC ID: L6ARDU70CW L6ARDE70UW

Date/Time: 2/7/2011 6:47:04 PM

Test Laboratory: RIM Testing Services

DipoleValidation_835MHz_Amb_Tem_23.3_Liq_Tem_22.3C_02_07_11

DUT: Dipole 835 MHz; Type: D835V2; Serial: D835V2 - SN:446

Communication System: CW; Frequency: 835 MHz; Duty Cycle: 1:1

Medium parameters used: $f = 835 \text{ MHz}$; $\sigma = 0.903 \text{ mho/m}$; $\epsilon_r = 42.1$; $\rho = 1000 \text{ kg/m}^3$

Phantom section: Flat Section

DASY4 Configuration:

- Probe: ET3DV6 - SN1643; ConvF(6.01, 6.01, 6.01); Calibrated: 3/9/2010
- Sensor-Surface: 4mm (Mechanical Surface Detection)
- Electronics: DAE3 Sn472; Calibrated: 5/17/2010
- Phantom: SAM 1; Type: SAM 4.0; Serial: 1076
- Measurement SW: DASY4, V4.7 Build 80; Postprocessing SW: SEMCAD, V1.8 Build 186

d=15mm, Pin=1000mW/Zoom Scan (5x5x7) 2 (5x5x7)/Cube 0: Measurement grid: $dx=7.5\text{mm}$, $dy=7.5\text{mm}$, $dz=5\text{mm}$

Reference Value = 110.6 V/m; Power Drift = -0.019 dB

Peak SAR (extrapolated) = 13.6 W/kg

SAR(1 g) = 9.38 mW/g; SAR(10 g) = 6.15 mW/g

Maximum value of SAR (measured) = 10.2 mW/g

d=15mm, Pin=1000mW/Area Scan (31x121x1): Measurement grid: $dx=15\text{mm}$, $dy=15\text{mm}$

Maximum value of SAR (interpolated) = 10.1 mW/g

Author Data
Andrew Becker

Dates of Test
Feb 7 – May 25, July 18, 2011

Test Report No
RTS-3933-1105-11A
RTS-2580-1106-03 Rev1

FCC ID:
L6ARDU70CW
L6ARDE70UW

IC ID
2503A-RDU70CW
2503A-RDE70UW

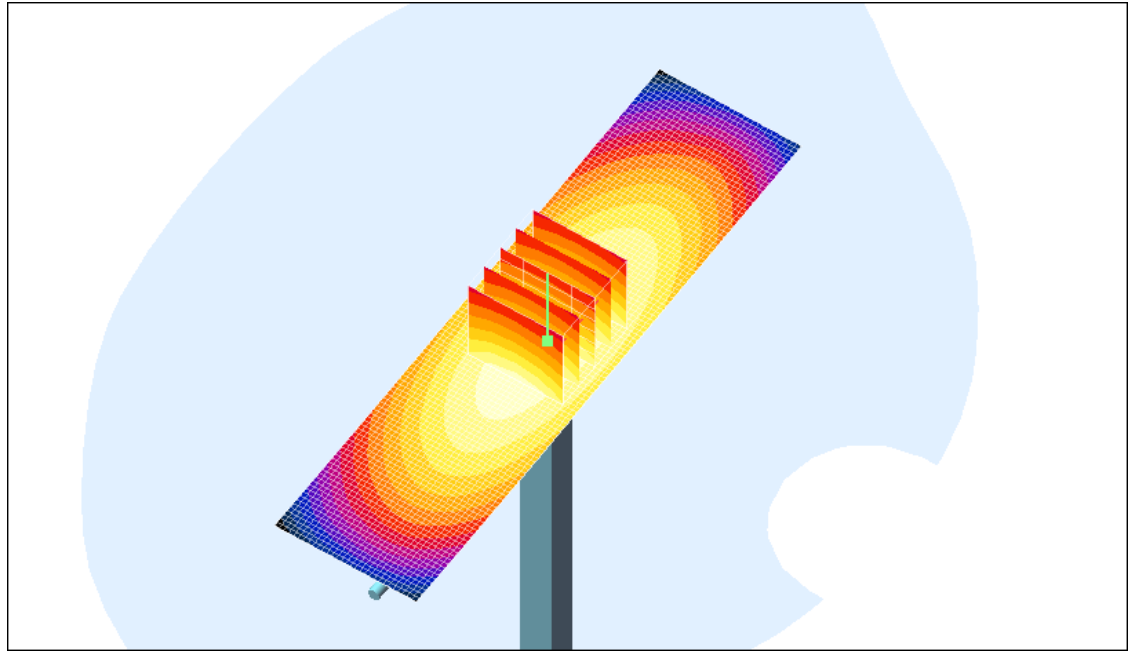
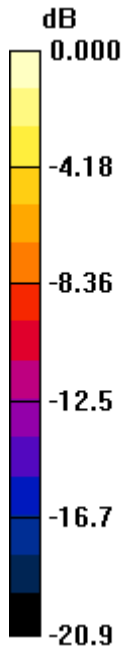

0 dB = 10.1mW/g

	Document Appendix A for the BlackBerry® Smartphone Model RDU71CW/RDE71UW SAR Report Rev1			Page 4(27)
	Author Data Andrew Becker	Dates of Test Feb 7 – May 25, July 18, 2011	Test Report No RTS-3933-1105-11A RTS-2580-1106-03 Rev1	FCC ID: L6ARDU70CW L6ARDE70UW

Date/Time: 3/7/2011 4:51:13 PM, Date/Time: 3/7/2011 4:56:00 PM

Test Laboratory: RIM Testing Services

DipoleValidation_835MHz_Amb_Tem_24.3_Liq_Tem_22.5C_03_07_11

DUT: Dipole 835 MHz; Type: D835V2; Serial: D835V2 - SN:446

Communication System: CW; Frequency: 835 MHz; Communication System PAR: 0 dB
Medium parameters used: $f = 835 \text{ MHz}$; $\sigma = 0.902 \text{ mho/m}$; $\epsilon_r = 40.495$; $\rho = 1000 \text{ kg/m}^3$
Phantom section: Flat Section
Measurement Standard: DASYS (IEEE/IEC/ANSI C63.19-2007)

DASY5 Configuration:

- Probe: ES3DV3 - SN3225; ConvF(6.47, 6.47, 6.47); Calibrated: 1/13/2011
- Sensor-Surface: 4mm (Mechanical Surface Detection)
- Electronics: DAE4 Sn881; Calibrated: 4/19/2010
- Phantom: SAM 1; Type: SAM 4.0; Serial: 1076
- Measurement SW: DASYS2, Version 52.6 (2); SEMCAD X Version 14.4.4 (2829)

Configuration/d=15mm, Pin=1000mW/Area Scan (31x121x1): Measurement grid: dx=15mm, dy=15mm
Maximum value of SAR (interpolated) = 10.049 mW/g

Configuration/d=15mm, Pin=1000mW/Zoom Scan (5x5x7) 2 (7x7x7)/Cube 0: Measurement grid: dx=5mm, dy=5mm, dz=5mm
Reference Value = 106.0 V/m; Power Drift = 0.04 dB
Peak SAR (extrapolated) = 14.251 W/kg
SAR(1 g) = 9.47 mW/g; SAR(10 g) = 6.18 mW/g
Maximum value of SAR (measured) = 10.221 mW/g

Author Data
Andrew Becker

Dates of Test
Feb 7 – May 25, July 18, 2011

Test Report No
RTS-3933-1105-11A
RTS-2580-1106-03 Rev1

FCC ID:
L6ARDU70CW
L6ARDE70UW

IC ID
2503A-RDU70CW
2503A-RDE70UW

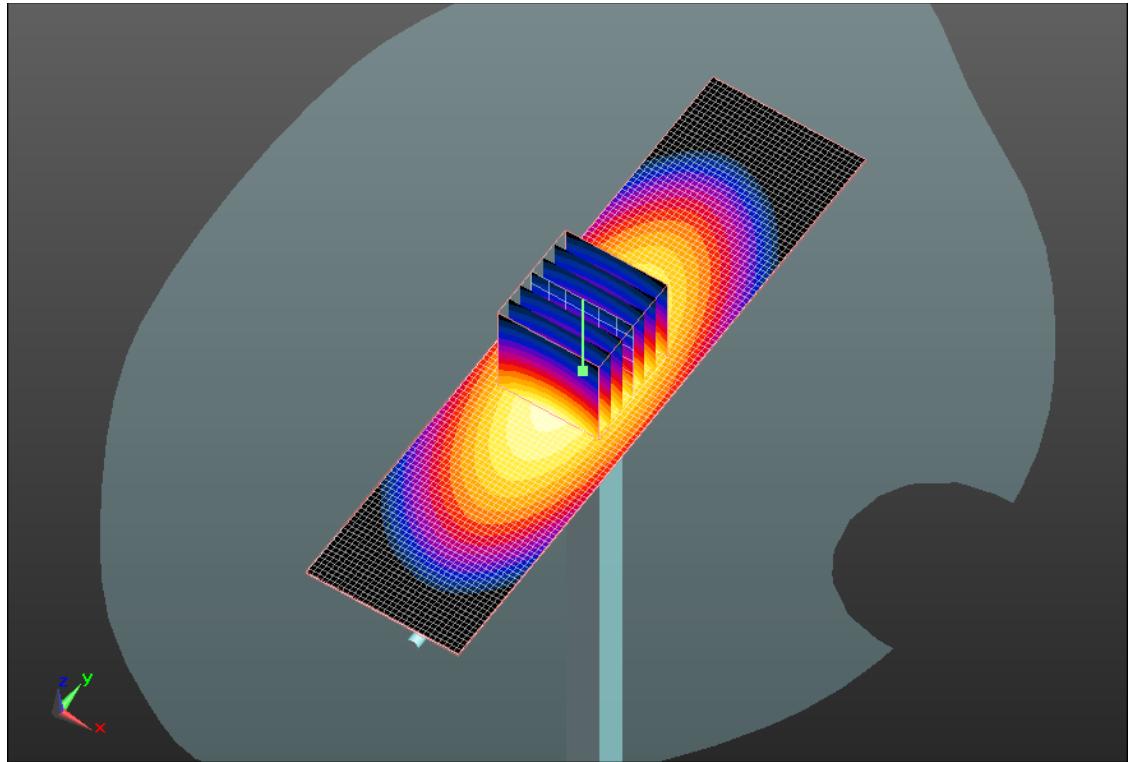
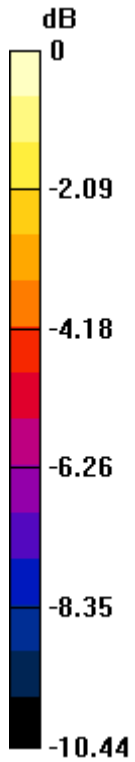

0 dB = 10.220mW/g

	Document Appendix A for the BlackBerry® Smartphone Model RDU71CW/RDE71UW SAR Report Rev1			Page 6(27)
	Author Data Andrew Becker	Dates of Test Feb 7 – May 25, July 18, 2011	Test Report No RTS-3933-1105-11A RTS-2580-1106-03 Rev1	FCC ID: L6ARDU70CW L6ARDE70UW

Date/Time: 4/20/2011 2:37:03 PM, Date/Time: 4/20/2011 2:44:45 PM

Test Laboratory: RIM Testing Services

DipoleValidation_835MHz_Amb_Tem_23.9_Liq_Tem_22.1C_04_20_11

DUT: Dipole 835 MHz; Type: D835V2; Serial: D835V2 - SN:446

Communication System: CW; Frequency: 835 MHz; Communication System PAR: 0 dB
Medium parameters used: $f = 835 \text{ MHz}$; $\sigma = 0.875 \text{ mho/m}$; $\epsilon_r = 40.074$; $\rho = 1000 \text{ kg/m}^3$
Phantom section: Flat Section
Measurement Standard: DASYS (IEEE/IEC/ANSI C63.19-2007)

DASY5 Configuration:

- Probe: ES3DV3 - SN3225; ConvF(6.47, 6.47, 6.47); Calibrated: 1/13/2011
- Sensor-Surface: 4mm (Mechanical Surface Detection)
- Electronics: DAE3 Sn473; Calibrated: 1/21/2011
- Phantom: SAM 1; Type: SAM 4.0; Serial: 1076
- Measurement SW: DASYS2, Version 52.6 (2); SEMCAD X Version 14.4.4 (2829)

Configuration/d=15mm, Pin=1000mW/Area Scan (31x121x1): Measurement grid: dx=15mm, dy=15mm
Maximum value of SAR (interpolated) = 9.747 mW/g

Configuration/d=15mm, Pin=1000mW/Zoom Scan (5x5x7) 2 (5x5x7)/Cube 0: Measurement grid: dx=7.5mm, dy=7.5mm, dz=5mm
Reference Value = 106.7 V/m; Power Drift = -0.00087 dB
Peak SAR (extrapolated) = 13.589 W/kg
SAR(1 g) = 9.1 mW/g; SAR(10 g) = 5.97 mW/g
Maximum value of SAR (measured) = 9.810 mW/g

Author Data
Andrew Becker

Dates of Test
Feb 7 – May 25, July 18, 2011

Test Report No
RTS-3933-1105-11A
RTS-2580-1106-03 Rev1

FCC ID:
L6ARDU70CW
L6ARDE70UW

IC ID
2503A-RDU70CW
2503A-RDE70UW

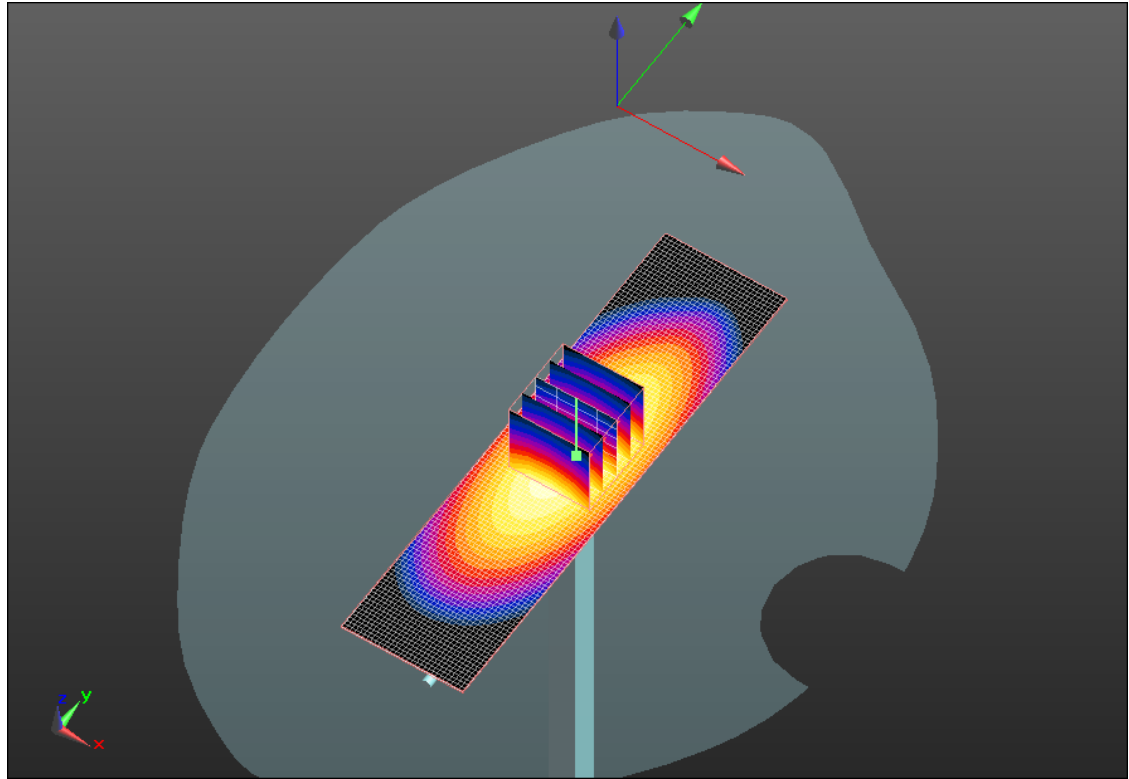
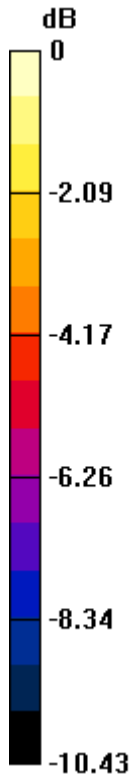

0 dB = 9.810mW/g

	Document Appendix A for the BlackBerry® Smartphone Model RDU71CW/RDE71UW SAR Report Rev1			Page 8(27)
	Author Data Andrew Becker	Dates of Test Feb 7 – May 25, July 18, 2011	Test Report No RTS-3933-1105-11A RTS-2580-1106-03 Rev1	FCC ID: L6ARDU70CW L6ARDE70UW

Date/Time: 2/23/2011 10:49:48 AM, Date/Time: 2/23/2011 10:57:12 AM

Test Laboratory: RIM Testing Services

DipoleValidation_1900MHz_Amb_Tem_23.4_Liq_Tem_22.2_02_23_11

DUT: Dipole 1900 MHz; Type: D1900V2; Serial: D1900V2 - SN:545

Communication System: CW; Frequency: 1900 MHz; Communication System PAR: 0 dB
Medium parameters used: $f = 1900$ MHz; $\sigma = 1.377$ mho/m; $\epsilon_r = 38.23$; $\rho = 1000$ kg/m³
Phantom section: Flat Section
Measurement Standard: DASYS (IEEE/IEC/ANSI C63.19-2007)

DASY5 Configuration:

- Probe: ET3DV6 - SN1643; ConvF(4.99, 4.99, 4.99); Calibrated: 3/9/2010
- Sensor-Surface: 4mm (Mechanical Surface Detection)
- Electronics: DAE3 Sn472; Calibrated: 5/17/2010
- Phantom: SAM 1; Type: SAM 4.0; Serial: 1076
- Measurement SW: DASYS2, Version 52.6 (2); SEMCAD X Version 14.4.4 (2829)

Configuration/d=15mm, Pin=1000mW/Area Scan (31x61x1): Measurement grid: dx=15mm, dy=15mm
Maximum value of SAR (interpolated) = 43.348 mW/g

Configuration/d=15mm, Pin=1000mW/Zoom Scan (5x5x7) 2 (5x5x7)/Cube 0: Measurement grid: dx=7.5mm, dy=7.5mm, dz=5mm
Reference Value = 186.9 V/m; Power Drift = -0.07 dB
Peak SAR (extrapolated) = 63.383 W/kg
SAR(1 g) = 37.6 mW/g; SAR(10 g) = 20 mW/g
Maximum value of SAR (measured) = 42.152 mW/g

Author Data
Andrew Becker

Dates of Test
Feb 7 – May 25, July 18, 2011

Test Report No
RTS-3933-1105-11A
RTS-2580-1106-03 Rev1

FCC ID:
L6ARDU70CW
L6ARDE70UW

IC ID
2503A-RDU70CW
2503A-RDE70UW

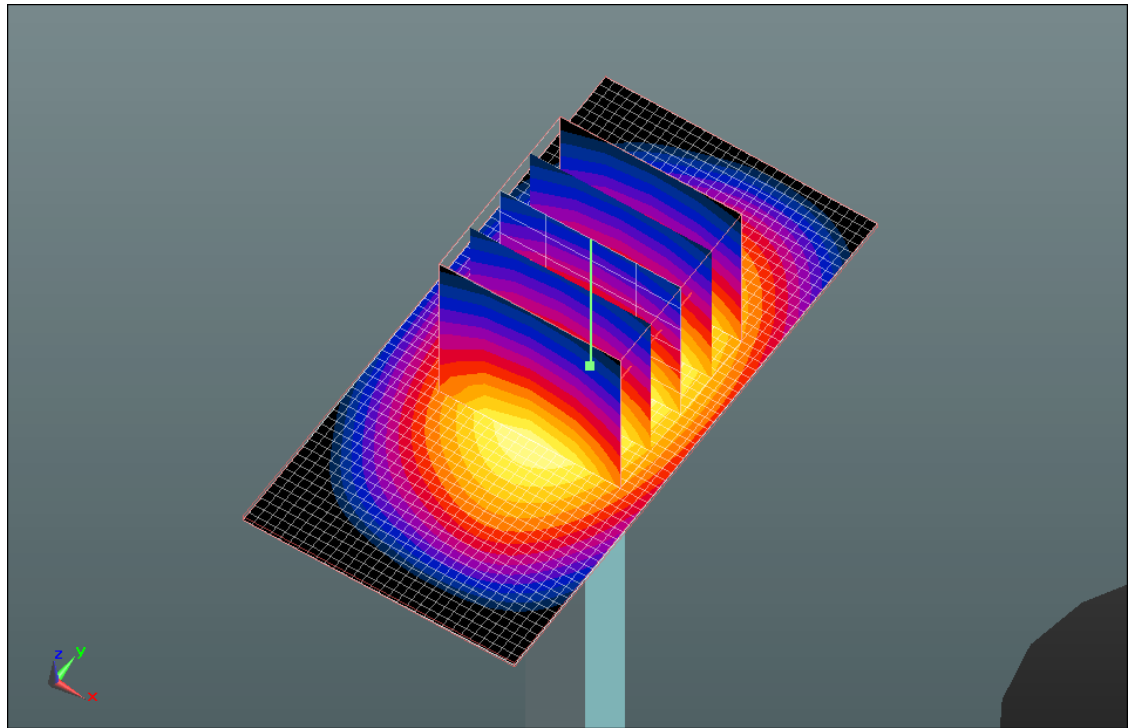
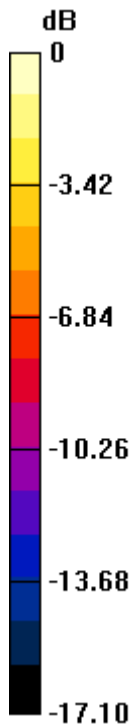

0 dB = 42.150mW/g

	Document Appendix A for the BlackBerry® Smartphone Model RDU71CW/RDE71UW SAR Report Rev1			Page 10(27)
	Author Data Andrew Becker	Dates of Test Feb 7 – May 25, July 18, 2011	Test Report No RTS-3933-1105-11A RTS-2580-1106-03 Rev1	FCC ID: L6ARDU70CW L6ARDE70UW

Date/Time: 2/24/2011 7:30:22 PM, Date/Time: 2/24/2011 7:27:48 PM

Test Laboratory: RIM Testing Services

DipoleValidation_1900MHz_Amb_Tem_23.5_Liq_Tem_22.2_02_24_11

DUT: Dipole 1900 MHz; Type: D1900V2; Serial: D1900V2 - SN:545

Communication System: CW; Frequency: 1900 MHz; Communication System PAR: 0 dB
Medium parameters used: $f = 1900$ MHz; $\sigma = 1.332$ mho/m; $\epsilon_r = 38.43$; $\rho = 1000$ kg/m³
Phantom section: Flat Section
Measurement Standard: DASYS (IEEE/IEC/ANSI C63.19-2007)

DASY5 Configuration:

- Probe: ET3DV6 - SN1643; ConvF(4.99, 4.99, 4.99); Calibrated: 3/9/2010
- Sensor-Surface: 4mm (Mechanical Surface Detection)
- Electronics: DAE3 Sn472; Calibrated: 5/17/2010
- Phantom: SAM 1; Type: SAM 4.0; Serial: 1076
- Measurement SW: DASYS2, Version 52.6 (2); SEMCAD X Version 14.4.4 (2829)

Configuration/d=15mm, Pin=1000mW/Zoom Scan (5x5x7) 2 (7x7x7)/Cube

0: Measurement grid: dx=5mm, dy=5mm, dz=5mm
Reference Value = 193.0 V/m; Power Drift = -0.03 dB
Peak SAR (extrapolated) = 67.533 W/kg
SAR(1 g) = 39.1 mW/g; SAR(10 g) = 20.7 mW/g
Maximum value of SAR (measured) = 44.617 mW/g

Configuration/d=15mm, Pin=1000mW/Area Scan (31x61x1): Measurement grid: dx=15mm, dy=15mm
Maximum value of SAR (interpolated) = 44.826 mW/g

Author Data
Andrew Becker

Dates of Test
**Feb 7 – May 25, July 18,
2011**

Test Report No
RTS-3933-1105-11A
RTS-2580-1106-03 Rev1

FCC ID:
L6ARDU70CW
L6ARDE70UW

IC ID
2503A-RDU70CW
2503A-RDE70UW

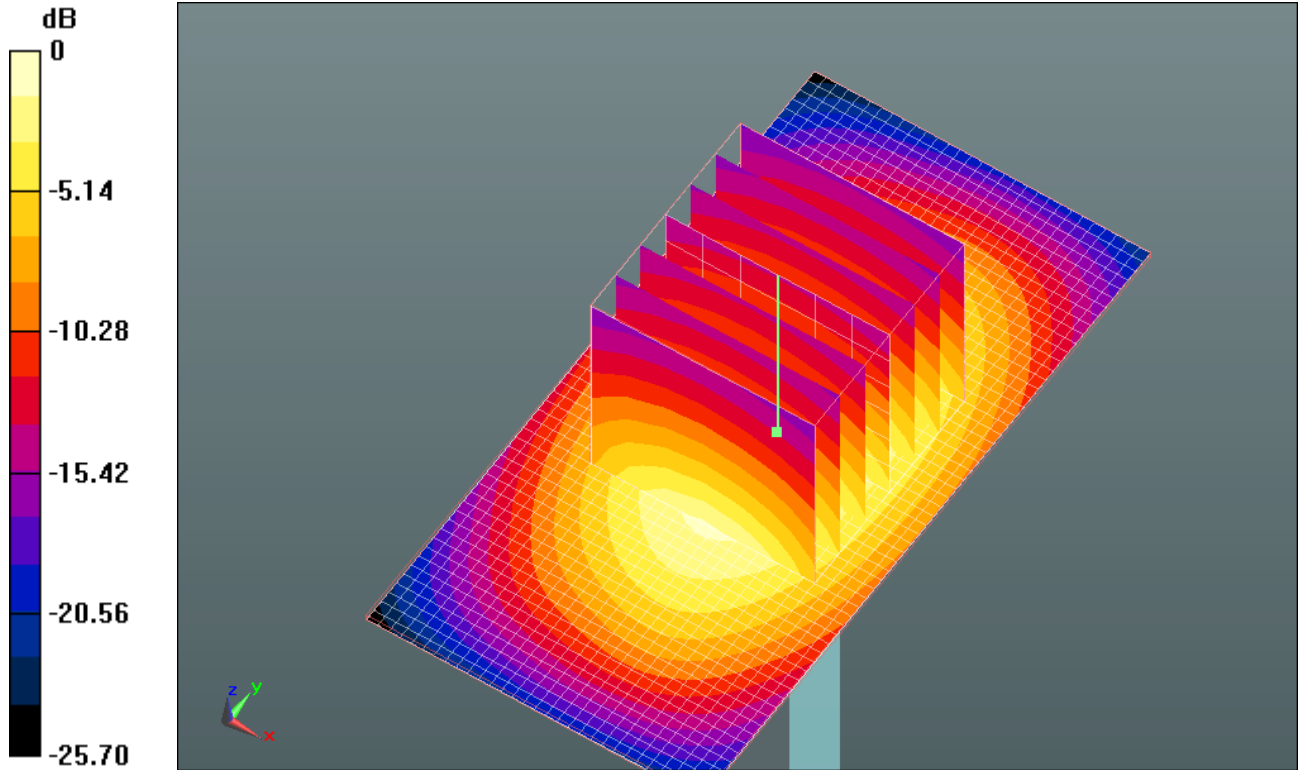

0 dB = 44.830mW/g

	Document Appendix A for the BlackBerry® Smartphone Model RDU71CW/RDE71UW SAR Report Rev1			Page 12(27)
	Author Data Andrew Becker	Dates of Test Feb 7 – May 25, July 18, 2011	Test Report No RTS-3933-1105-11A RTS-2580-1106-03 Rev1	FCC ID: L6ARDU70CW L6ARDE70UW

Date/Time: 2/28/2011 5:38:18 PM, Date/Time: 2/28/2011 5:35:41 PM

Test Laboratory: RIM Testing Services

DipoleValidation_1900MHz_Amb_Tem_23.6_Liq_Tem_22.2_02_28_11

DUT: Dipole 1900 MHz; Type: D1900V2; Serial: D1900V2 - SN:545

Communication System: CW; Frequency: 1900 MHz; Communication System PAR: 0 dB
Medium parameters used: $f = 1900$ MHz; $\sigma = 1.378$ mho/m; $\epsilon_r = 39.819$; $\rho = 1000$ kg/m³
Phantom section: Flat Section
Measurement Standard: DASYS (IEEE/IEC/ANSI C63.19-2007)

DASY5 Configuration:

- Probe: ES3DV3 - SN3225; ConvF(5.26, 5.26, 5.26); Calibrated: 1/13/2011
- Sensor-Surface: 4mm (Mechanical Surface Detection)
- Electronics: DAE4 Sn881; Calibrated: 4/19/2010
- Phantom: SAM 1; Type: SAM 4.0; Serial: 1076
- Measurement SW: DASYS2, Version 52.6 (2); SEMCAD X Version 14.4.4 (2829)

Configuration/d=15mm, Pin=1000mW/Zoom Scan (5x5x7) 2 (5x5x7)/Cube

0: Measurement grid: dx=7.5mm, dy=7.5mm, dz=5mm
Reference Value = 179.4 V/m; Power Drift = -0.12 dB
Peak SAR (extrapolated) = 72.198 W/kg
SAR(1 g) = 39.8 mW/g; SAR(10 g) = 20.9 mW/g
Maximum value of SAR (measured) = 44.371 mW/g

Configuration/d=15mm, Pin=1000mW/Area Scan (31x61x1): Measurement

grid: dx=15mm, dy=15mm
Maximum value of SAR (interpolated) = 45.293 mW/g

Author Data
Andrew Becker

Dates of Test
Feb 7 – May 25, July 18, 2011

Test Report No
RTS-3933-1105-11A
RTS-2580-1106-03 Rev1

FCC ID:
L6ARDU70CW
L6ARDE70UW

IC ID
2503A-RDU70CW
2503A-RDE70UW

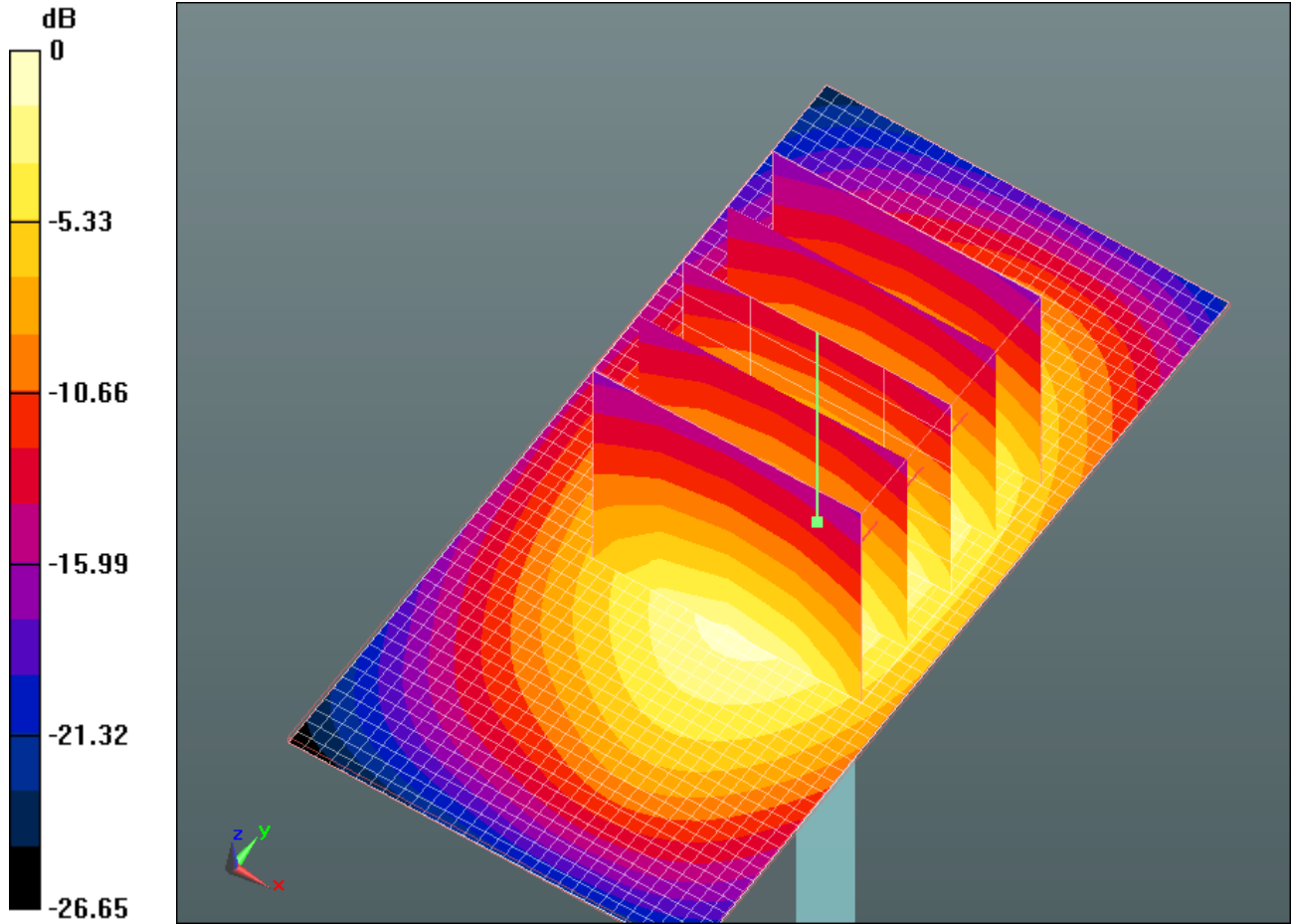

0 dB = 45.290mW/g

	Document Appendix A for the BlackBerry® Smartphone Model RDU71CW/RDE71UW SAR Report Rev1			Page 14(27)
	Author Data Andrew Becker	Dates of Test Feb 7 – May 25, July 18, 2011	Test Report No RTS-3933-1105-11A RTS-2580-1106-03 Rev1	FCC ID: L6ARDU70CW L6ARDE70UW

Date/Time: 4/18/2011 1:49:16 PM, Date/Time: 4/18/2011 1:51:52 PM

Test Laboratory: RIM Testing Services

DipoleValidation_1900MHz_Amb_Tem_23.8_Liq_Tem_22.4_04_18_11

DUT: Dipole 1900 MHz; Type: D1900V2; Serial: D1900V2 - SN:545

Communication System: CW; Frequency: 1900 MHz; Communication System PAR: 0 dB
Medium parameters used: $f = 1900$ MHz; $\sigma = 1.382$ mho/m; $\epsilon_r = 38.207$; $\rho = 1000$ kg/m³
Phantom section: Flat Section
Measurement Standard: DASYS (IEEE/IEC/ANSI C63.19-2007)

DASY5 Configuration:

- Probe: ES3DV3 - SN3225; ConvF(5.26, 5.26, 5.26); Calibrated: 1/13/2011
- Sensor-Surface: 4mm (Mechanical Surface Detection)
- Electronics: DAE3 Sn473; Calibrated: 1/21/2011
- Phantom: SAM 1; Type: SAM 4.0; Serial: 1076
- Measurement SW: DASYS2, Version 52.6 (2); SEMCAD X Version 14.4.4 (2829)

Configuration/d=15mm, Pin=1000mW/Area Scan (31x61x1): Measurement grid: dx=15mm, dy=15mm
Maximum value of SAR (interpolated) = 43.465 mW/g

Configuration/d=15mm, Pin=1000mW/Zoom Scan (5x5x7) 2 (7x7x7)/Cube 0: Measurement grid: dx=5mm, dy=5mm, dz=5mm
Reference Value = 166.6 V/m; Power Drift = 0.04 dB
Peak SAR (extrapolated) = 68.326 W/kg
SAR(1 g) = 37.5 mW/g; SAR(10 g) = 19.7 mW/g
Maximum value of SAR (measured) = 41.979 mW/g

Author Data
Andrew Becker

Dates of Test
Feb 7 – May 25, July 18, 2011

Test Report No
RTS-3933-1105-11A
RTS-2580-1106-03 Rev1

FCC ID:
L6ARDU70CW
L6ARDE70UW

IC ID
2503A-RDU70CW
2503A-RDE70UW

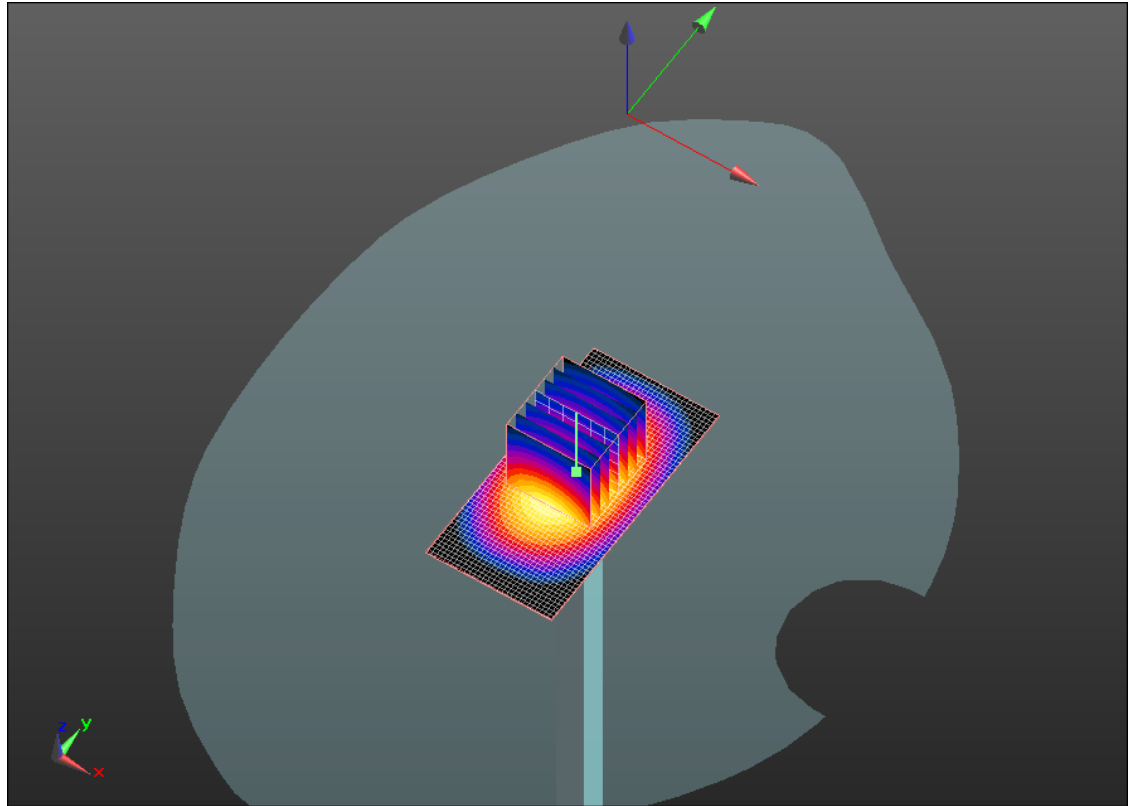
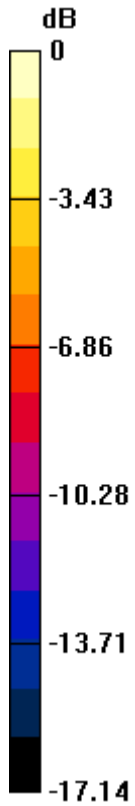

0 dB = 41.980mW/g

	Document Appendix A for the BlackBerry® Smartphone Model RDU71CW/RDE71UW SAR Report Rev1			Page 16(27)
	Author Data Andrew Becker	Dates of Test Feb 7 – May 25, July 18, 2011	Test Report No RTS-3933-1105-11A RTS-2580-1106-03 Rev1	FCC ID: L6ARDU70CW L6ARDE70UW

Date/Time: 3/3/2011 5:42:02 PM, Date/Time: 3/3/2011 5:39:37 PM

Test Laboratory: RIM Testing Services

DipoleValidation_2450MHz_Amb_Tem_23.4_Liq_Tem_21.8C

DUT: Dipole 2450 MHz; Type: D2450V2; Serial: D2450V2 - SN:747

Communication System: CW; Frequency: 2450 MHz; Communication System PAR: 0 dB
Medium parameters used: $f = 2450$ MHz; $\sigma = 1.855$ mho/m; $\epsilon_r = 37.492$; $\rho = 1000$ kg/m³
Phantom section: Flat Section
Measurement Standard: DASYS (IEEE/IEC/ANSI C63.19-2007)

DASY5 Configuration:

- Probe: ES3DV3 - SN3225; ConvF(4.6, 4.6, 4.6); Calibrated: 1/13/2011
- Sensor-Surface: 4mm (Mechanical Surface Detection)
- Electronics: DAE4 Sn881; Calibrated: 4/19/2010
- Phantom: SAM 1; Type: SAM 4.0; Serial: 1076
- Measurement SW: DASYS2, Version 52.6 (2); SEMCAD X Version 14.4.4 (2829)

Configuration/d=15mm, Pin=1000mW/Zoom Scan (5x5x7) 2 (5x5x7)/Cube

0: Measurement grid: dx=7.5mm, dy=7.5mm, dz=5mm
Reference Value = 182.0 V/m; Power Drift = -0.02 dB
Peak SAR (extrapolated) = 113.6 W/kg
SAR(1 g) = 53.4 mW/g; SAR(10 g) = 24.5 mW/g
Maximum value of SAR (measured) = 60.590 mW/g

Configuration/d=15mm, Pin=1000mW/Area Scan (31x41x1): Measurement grid: dx=15mm, dy=15mm
Maximum value of SAR (interpolated) = 64.201 mW/g

Author Data
Andrew Becker

Dates of Test
Feb 7 – May 25, July 18, 2011

Test Report No
RTS-3933-1105-11A
RTS-2580-1106-03 Rev1

FCC ID:
L6ARDU70CW
L6ARDE70UW

IC ID
2503A-RDU70CW
2503A-RDE70UW

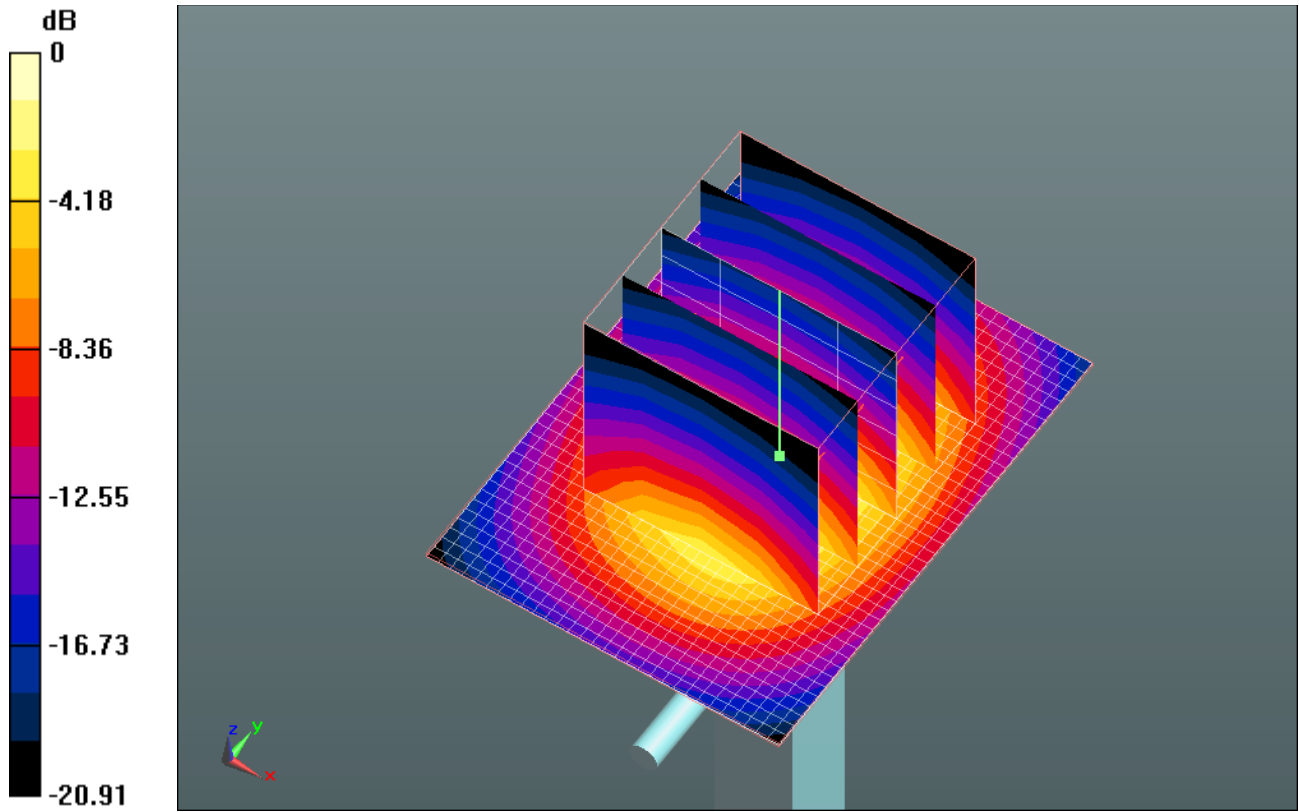

0 dB = 64.200mW/g

	Document Appendix A for the BlackBerry® Smartphone Model RDU71CW/RDE71UW SAR Report Rev1			Page 18(27)
	Author Data Andrew Becker	Dates of Test Feb 7 – May 25, July 18, 2011	Test Report No RTS-3933-1105-11A RTS-2580-1106-03 Rev1	FCC ID: L6ARDU70CW L6ARDE70UW

Date/Time: 5/24/2011 1:52:36 PM, Date/Time: 5/24/2011 1:55:21 PM

Test Laboratory: RIM Testing Services

Dipole Validation-5200 MHz_amb_temp_24C_liq_temp_23

DUT: Dipole D5GHzV2; Type: D5GHzV2; Serial: D5GHzV2 - SN:1033

Communication System: CW; Communication System Band: D5GHz (5000.0 - 6000.0 MHz); Frequency: 5200 MHz; Communication System PAR: 0 dB
Medium parameters used: $f = 5200$ MHz; $\sigma = 4.825$ mho/m; $\epsilon_r = 35.231$; $\rho = 1000$ kg/m³
Phantom section: Flat Section
Measurement Standard: DASYS (IEEE/IEC/ANSI C63.19-2007)

DASY5 Configuration:

- Probe: EX3DV4 - SN3548; ConvF(5.01, 5.01, 5.01); Calibrated: 1/20/2011
- Sensor-Surface: 2mm (Mechanical Surface Detection)
- Electronics: DAE3 Sn473; Calibrated: 1/21/2011
- Phantom: SAM 1; Type: SAM 4.0; Serial: 1076
- Measurement SW: DASYS2, Version 52.6 (2); SEMCAD X Version 14.4.4 (2829)

System Performance Check with D5GHzV2 Dipole (graded grid)/d=10mm, Pin=1000 mW, f=5200 MHz/Area Scan (41x51x1): Measurement grid: dx=10mm, dy=10mm
Maximum value of SAR (interpolated) = 196.4 mW/g

System Performance Check with D5GHzV2 Dipole (graded grid)/d=10mm, Pin=1000 mW, f=5200 MHz/Zoom Scan (4x4x2.5mm, graded), dist=2mm (9x9x5)/Cube 0: Measurement grid: dx=4mm, dy=4mm, dz=2.5mm
Reference Value = 206.3 V/m; Power Drift = -0.08 dB
Peak SAR (extrapolated) = 316.8 W/kg
SAR(1 g) = 84.4 mW/g; SAR(10 g) = 24.4 mW/g
Maximum value of SAR (measured) = 178.8 mW/g

Author Data
Andrew Becker

Dates of Test
Feb 7 – May 25, July 18, 2011

Test Report No
RTS-3933-1105-11A
RTS-2580-1106-03 Rev1

FCC ID:
L6ARDU70CW
L6ARDE70UW

IC ID
2503A-RDU70CW
2503A-RDE70UW

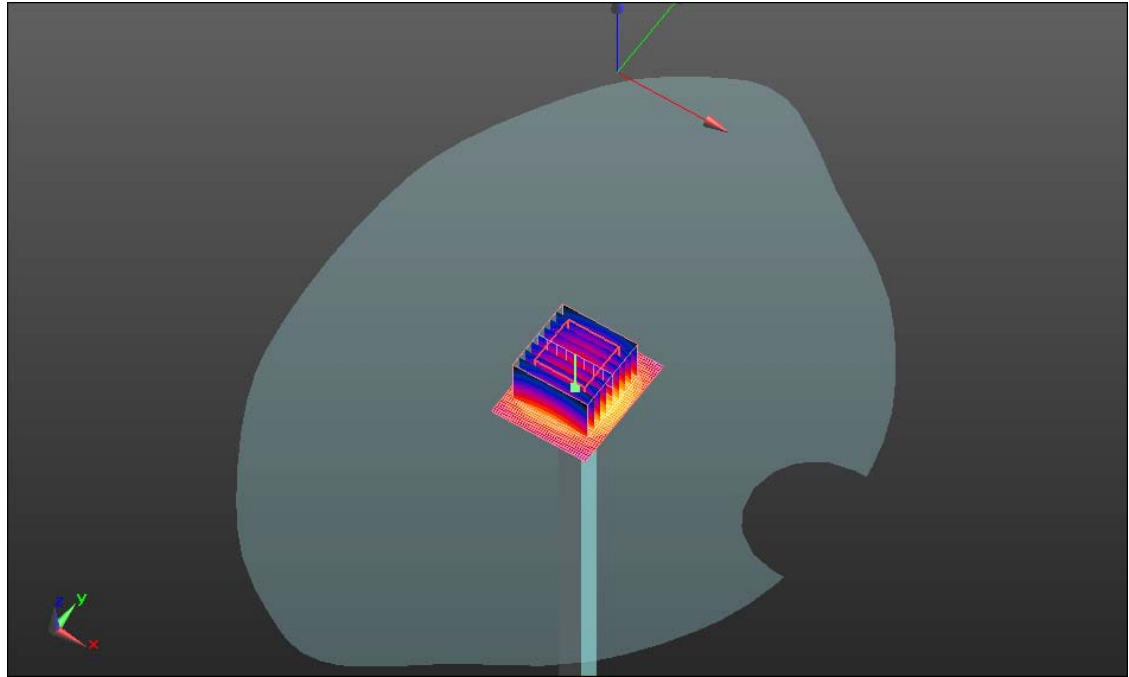
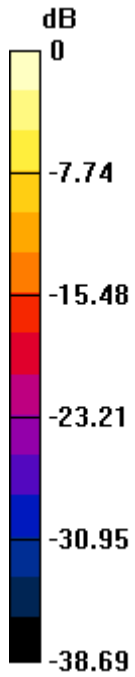

0 dB = 178.8mW/g

	Document Appendix A for the BlackBerry® Smartphone Model RDU71CW/RDE71UW SAR Report Rev1			Page 20(27)
	Author Data Andrew Becker	Dates of Test Feb 7 – May 25, July 18, 2011	Test Report No RTS-3933-1105-11A RTS-2580-1106-03 Rev1	FCC ID: L6ARDU70CW L6ARDE70UW

Date/Time: 5/24/2011 2:20:44 PM, Date/Time: 5/24/2011 2:29:40 PM

Test Laboratory: RIM Testing Services

Dipole Validation-5500 MHz_amb_temp_23.7C_liq_temp_22.8C

DUT: Dipole D5GHzV2; Type: D5GHzV2; Serial: D5GHzV2 - SN:1033

Communication System: CW-5GHz; Frequency: 5500 MHz; Communication System

PAR: 0 dB

Medium parameters used: $f = 5500$ MHz; $\sigma = 5.027$ mho/m; $\epsilon_r = 34.692$; $\rho = 1000$ kg/m³

Phantom section: Flat Section

Measurement Standard: DASYS (IEEE/IEC/ANSI C63.19-2007)

DASY5 Configuration:

- Probe: EX3DV4 - SN3548; ConvF(4.63, 4.63, 4.63); Calibrated: 1/20/2011
- Sensor-Surface: 2mm (Mechanical Surface Detection)
- Electronics: DAE3 Sn473; Calibrated: 1/21/2011
- Phantom: SAM 1; Type: SAM 4.0; Serial: 1076
- Measurement SW: DASYS2, Version 52.6 (2); SEMCAD X Version 14.4.4 (2829)

System Performance Check with D5GHzV2 Dipole (graded grid)/d=10mm, Pin=100mW, f=5500 MHz/Area Scan (91x91x1): Measurement grid: dx=10mm, dy=10mm

Maximum value of SAR (interpolated) = 183.7 mW/g

System Performance Check with D5GHzV2 Dipole (graded grid)/d=10mm, Pin=100mW, f=5500 MHz/Zoom Scan (4x4x2.5mm, graded), dist=2mm (7x7x5)/Cube 0: Measurement grid: dx=4mm, dy=4mm, dz=2.5mm

Reference Value = 205.5 V/m; Power Drift = 0.0059 dB

Peak SAR (extrapolated) = 324.3 W/kg

SAR(1 g) = 87.4 mW/g; SAR(10 g) = 25.1 mW/g

Maximum value of SAR (measured) = 183.0 mW/g

Author Data
Andrew Becker

Dates of Test
Feb 7 – May 25, July 18, 2011

Test Report No
RTS-3933-1105-11A
RTS-2580-1106-03 Rev1

FCC ID:
L6ARDU70CW
L6ARDE70UW

IC ID
2503A-RDU70CW
2503A-RDE70UW

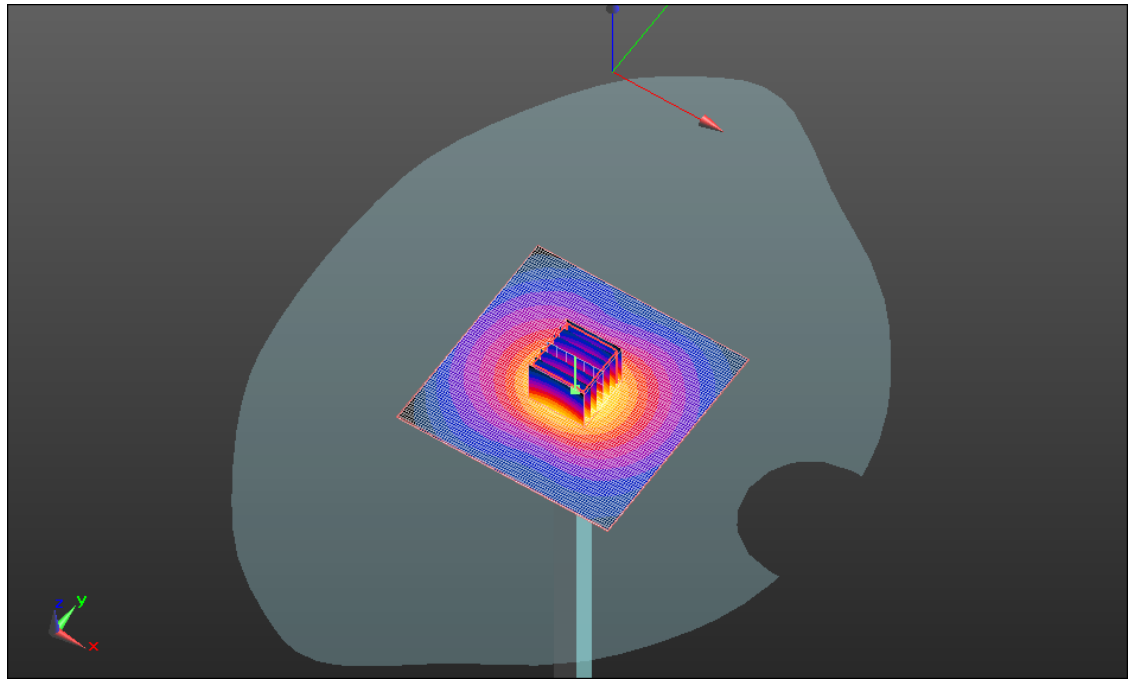
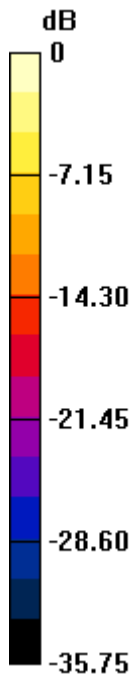

0 dB = 183.0mW/g

	Document Appendix A for the BlackBerry® Smartphone Model RDU71CW/RDE71UW SAR Report Rev1			Page 22(27)
	Author Data Andrew Becker	Dates of Test Feb 7 – May 25, July 18, 2011	Test Report No RTS-3933-1105-11A RTS-2580-1106-03 Rev1	FCC ID: L6ARDU70CW L6ARDE70UW

Date/Time: 5/24/2011 3:19:36 PM, Date/Time: 5/24/2011 3:26:44 PM

Test Laboratory: RIM Testing Services

Dipole Validation-5800 MHz_amb_temp_23.8C_liq_temp_22.9C

DUT: Dipole D5GHzV2; Type: D5GHzV2; Serial: D5GHzV2 - SN:1033

Communication System: CW-5GHz; Frequency: 5800 MHz; Communication System

PAR: 0 dB

Medium parameters used: $f = 5800$ MHz; $\sigma = 5.46$ mho/m; $\epsilon_r = 34.687$; $\rho = 1000$ kg/m³

Phantom section: Flat Section

Measurement Standard: DASYS (IEEE/IEC/ANSI C63.19-2007)

DASY5 Configuration:

- Probe: EX3DV4 - SN3548; ConvF(4.42, 4.42, 4.42); Calibrated: 1/20/2011
- Sensor-Surface: 2mm (Mechanical Surface Detection)
- Electronics: DAE3 Sn473; Calibrated: 1/21/2011
- Phantom: SAM 1; Type: SAM 4.0; Serial: 1076
- Measurement SW: DASYS2, Version 52.6 (2); SEMCAD X Version 14.4.4 (2829)

System Performance Check with D5GHzV2 Dipole (graded grid)/d=10mm, Pin=100mW, f=5800 MHz/Area Scan (41x51x1): Measurement grid: dx=10mm, dy=10mm

Maximum value of SAR (interpolated) = 201.1 mW/g

System Performance Check with D5GHzV2 Dipole (graded grid)/d=10mm, Pin=100mW, f=5800 MHz/Zoom Scan (4x4x2.5mm, graded), dist=2mm (7x7x5)/Cube 0: Measurement grid: dx=4mm, dy=4mm, dz=2.5mm

Reference Value = 194.6 V/m; Power Drift = -0.07 dB

Peak SAR (extrapolated) = 317.7 W/kg

SAR(1 g) = 81.9 mW/g; SAR(10 g) = 23.4 mW/g

Maximum value of SAR (measured) = 172.1 mW/g

	Document Appendix A for the BlackBerry® Smartphone Model RDU71CW/RDE71UW SAR Report Rev1			Page 23(27)
	Author Data Andrew Becker	Dates of Test Feb 7 – May 25, July 18, 2011	Test Report No RTS-3933-1105-11A RTS-2580-1106-03 Rev1	FCC ID: L6ARDU70CW L6ARDE70UW

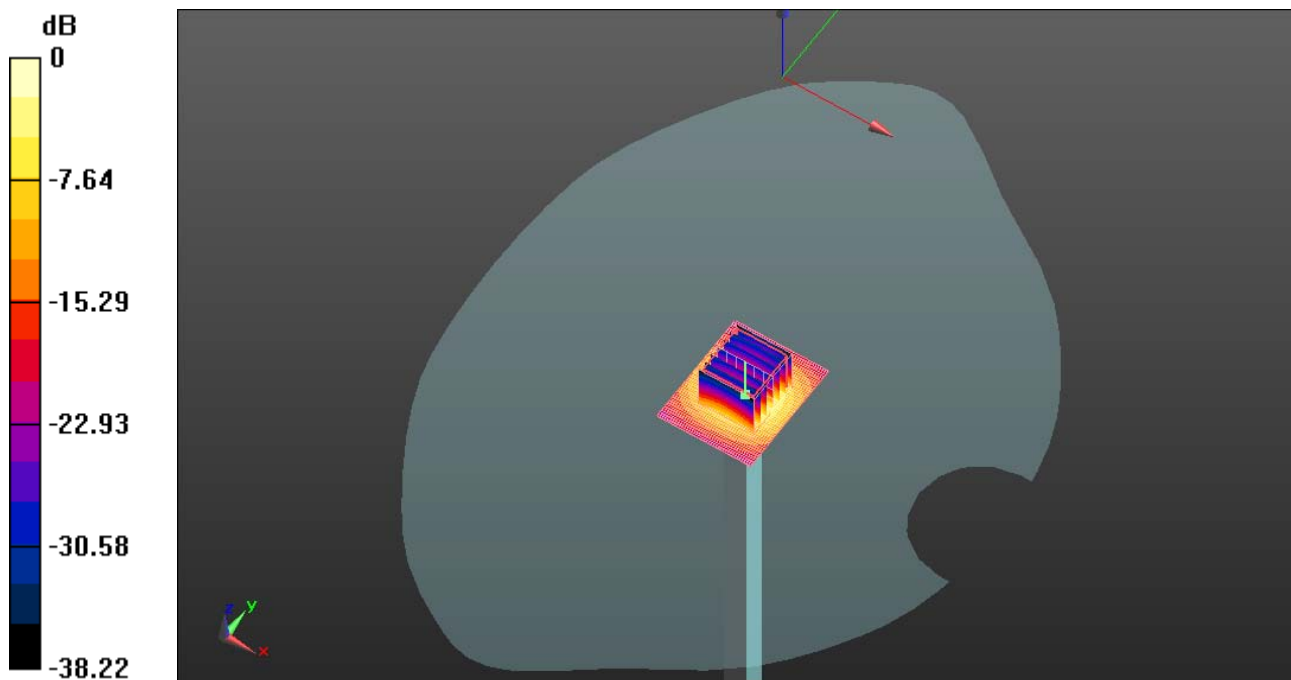

0 dB = 172.1mW/g

	Document Appendix A for the BlackBerry® Smartphone Model RDU71CW/RDE71UW SAR Report Rev1			Page 24(27)
	Author Data Andrew Becker	Dates of Test Feb 7 – May 25, July 18, 2011	Test Report No RTS-3933-1105-11A RTS-2580-1106-03 Rev1	FCC ID: L6ARDU70CW L6ARDE70UW

Date/Time: 4/27/2011 10:04:33 PM, Date/Time: 4/27/2011 10:07:10 PM

Test Laboratory: RIM Testing Services

DipoleValidation_1900MHz_Amb_Tem_23.5_Liq_Tem_22.3_04_27_11

DUT: Dipole 1900 MHz; Type: D1900V2; Serial: D1900V2 - SN:545

Communication System: CW; Frequency: 1900 MHz; Communication System PAR: 0 dB
Medium parameters used: $f = 1900$ MHz; $\sigma = 1.382$ mho/m; $\epsilon_r = 38.207$; $\rho = 1000$ kg/m³
Phantom section: Flat Section
Measurement Standard: DASYS (IEEE/IEC/ANSI C63.19-2007)

DASY5 Configuration:

- Probe: ES3DV3 - SN3225; ConvF(5.26, 5.26, 5.26); Calibrated: 1/13/2011
- Sensor-Surface: 4mm (Mechanical Surface Detection)
- Electronics: DAE3 Sn473; Calibrated: 1/21/2011
- Phantom: SAM 1; Type: SAM 4.0; Serial: 1076
- Measurement SW: DASYS2, Version 52.6 (2); SEMCAD X Version 14.4.4 (2829)

Configuration/d=15mm, Pin=1000mW/Area Scan (31x61x1): Measurement grid: dx=15mm, dy=15mm
Maximum value of SAR (interpolated) = 43.502 mW/g

Configuration/d=15mm, Pin=1000mW/Zoom Scan (5x5x7) 2 (7x7x7)/Cube 0: Measurement grid: dx=5mm, dy=5mm, dz=5mm
Reference Value = 175.9 V/m; Power Drift = -0.03 dB
Peak SAR (extrapolated) = 69.471 W/kg
SAR(1 g) = 37.8 mW/g; SAR(10 g) = 19.7 mW/g
Maximum value of SAR (measured) = 42.644 mW/g

Author Data
Andrew Becker

Dates of Test
Feb 7 – May 25, July 18, 2011

Test Report No
RTS-3933-1105-11A
RTS-2580-1106-03 Rev1

FCC ID:
L6ARDU70CW
L6ARDE70UW

IC ID
2503A-RDU70CW
2503A-RDE70UW

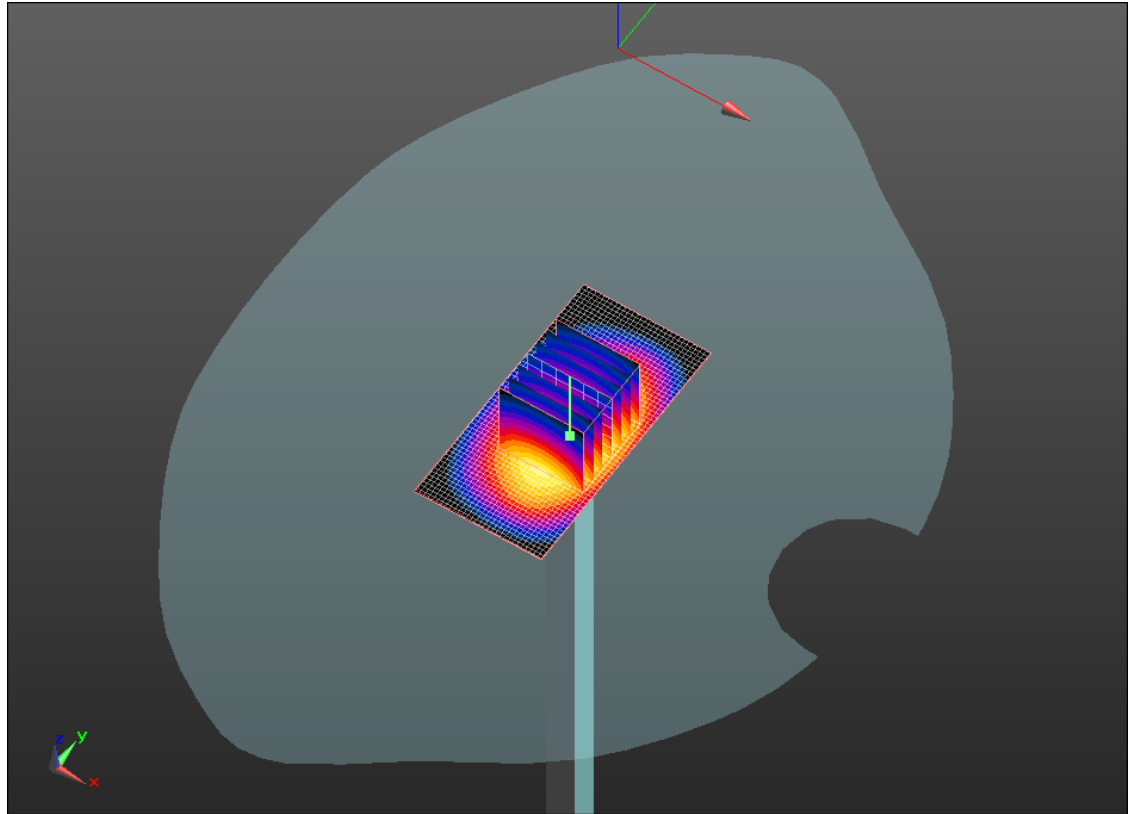
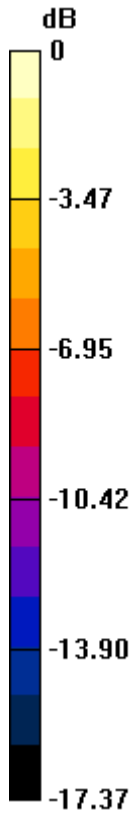

0 dB = 42.640mW/g

	Document Appendix A for the BlackBerry® Smartphone Model RDU71CW/RDE71UW SAR Report Rev1			Page 26(27)
	Author Data Andrew Becker	Dates of Test Feb 7 – May 25, July 18, 2011	Test Report No RTS-3933-1105-11A RTS-2580-1106-03 Rev1	FCC ID: L6ARDU70CW L6ARDE70UW

Date/Time: 7/18/2011 5:33:38 PM, Date/Time: 7/18/2011 5:36:30 PM

Test Laboratory: RIM Testing Services

DipoleValidation_1900MHz_Amb_Tem_23.0_Liq_Tem_22.4_07_18_11

DUT: Dipole 1900 MHz; Type: D1900V2; Serial: D1900V2 - SN:545

Communication System: CW; Frequency: 1900 MHz; Duty Cycle: 1:1

Medium parameters used: $f = 1900$ MHz; $\sigma = 1.421$ mho/m; $\epsilon_r = 40.772$; $\rho = 1000$ kg/m³

Phantom section: Flat Section

Measurement Standard: DASYS (IEEE/IEC/ANSI C63.19-2007)

DASY4 Configuration:

- Probe: ES3DV3 - SN3225; ConvF(5.26, 5.26, 5.26); Calibrated: 1/13/2011
- Sensor-Surface: 4mm (Mechanical Surface Detection)
- Electronics: DAE3 Sn472; Calibrated: 3/7/2011
- Phantom: SAM 1; Type: SAM 4.0; Serial: 1076
- ; SEMCAD X Version 14.4.4 (2829)

Configuration/d=15mm, Pin=1000mW/Area Scan (31x61x1): Measurement grid: dx=15mm, dy=15mm

Maximum value of SAR (interpolated) = 44.504 mW/g

Configuration/d=15mm, Pin=1000mW/Zoom Scan (5x5x7) 2 (7x7x7)/Cube

0: Measurement grid: dx=5mm, dy=5mm, dz=5mm

Reference Value = 179.4 V/m; Power Drift = -0.0052 dB

Peak SAR (extrapolated) = 71.945 W/kg

SAR(1 g) = 39.1 mW/g; SAR(10 g) = 20.4 mW/g

Maximum value of SAR (measured) = 43.460 mW/g

Author Data
Andrew Becker

Dates of Test
Feb 7 – May 25, July 18, 2011

Test Report No
RTS-3933-1105-11A
RTS-2580-1106-03 Rev1

FCC ID:
L6ARDU70CW
L6ARDE70UW

IC ID
2503A-RDU70CW
2503A-RDE70UW

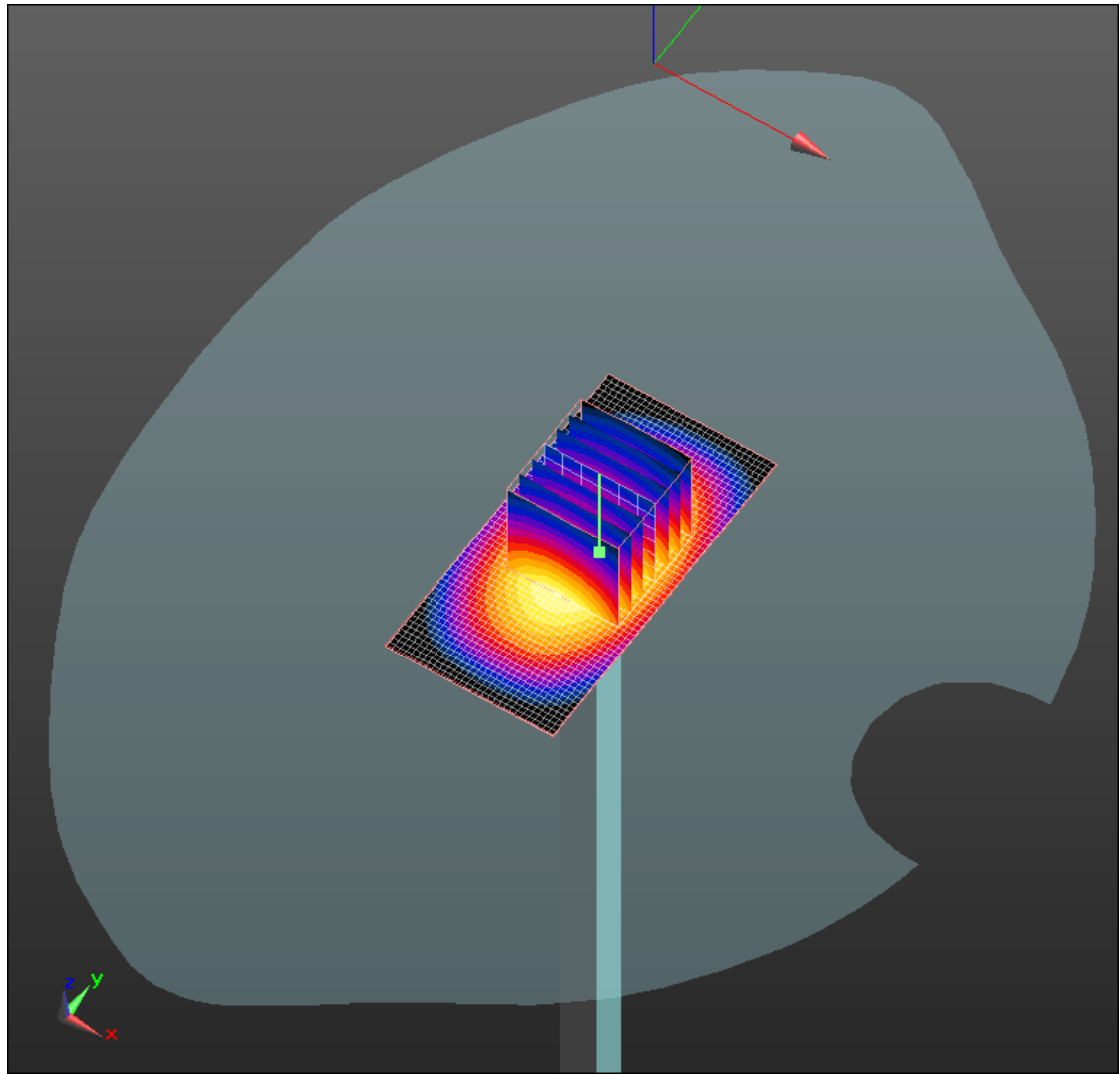
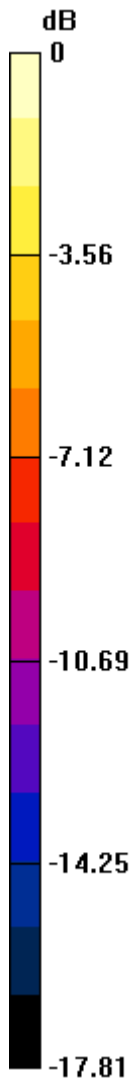

0 dB = 43.460mW/g