

## TEST REPORT

Test report no.: 1-3314-01-33/11-A



### Testing laboratory

**CETECOM ICT Services GmbH**  
 Untertuerkheimer Strasse 6 – 10  
 66117 Saarbruecken / Germany  
 Phone: + 49 681 5 98 - 0  
 Fax: + 49 681 5 98 - 9075  
 Internet: <http://www.cetecom.com>  
 e-mail: [ict@cetecom.com](mailto:ict@cetecom.com)

**Accredited test laboratory:**  
 The test laboratory (area of testing) is accredited according to DIN EN ISO/IEC 17025  
 DAR registration number: D-PL-12076-01-01

Area of Testing: Radio/Satellite Communications

### Applicant

**Research In Motion Limited**  
 305 Phillip Street  
 Waterloo, ON N2L 3W8 / Canada  
 Phone: +1-519-888-7465  
 Fax: +1-519-888-6906  
 Contact: Masud Attayi  
 e-mail: [mattayi@rim.com](mailto:mattayi@rim.com)  
 Phone: +1-519-888-7465

### Manufacturer

**Research In Motion Limited**  
 305 Phillip Street  
 Waterloo, ON N2L 3W8 / Canada

### Test standard/s

47 CFR Part 22	Title 47 of the Code of Federal Regulations; Chapter I Part 22 - Public mobile services
47 CFR Part 24	Title 47 of the Code of Federal Regulations; Chapter I Part 24 - Personal communications services
47 CFR Part 27	Title 47 of the Code of Federal Regulations; Chapter I Part 27—Miscellaneous Wireless Communications Services
RSS - 132 Issue 2	Spectrum Management and Telecommunications Policy - Radio Standards Specifications Cellular Telephones Employing New Technologies Operating in the Bands 824-849 MHz and 869-894 MHz

For further applied test standards please refer to section 3 of this test report.

### Test item

<b>Kind of test item:</b>	<b>Mobile phone with GSM / GPRS / Edge, WCDMA / HSDPA, Bluetooth® 2.1 EDR, WLAN b / g / n – HT20, NFC, GPS</b>
<b>Model name:</b>	<b>RDC71UW</b>
<b>FCC ID:</b>	<b>L6ARDC70UW</b>
<b>IC:</b>	<b>2503A-RDC70UW</b>
<b>Frequency:</b>	<b>824.2 – 848.8 MHz, 1850.2 – 1909.8 MHz</b>
<b>Power supply:</b>	<b>3.7 V DC by battery EM1 + charger PSM04R-050CHW2</b>
<b>Temperature range:</b>	<b>-/-</b>

This test report is electronically signed and valid without handwriting signature. For verification of the electronic signatures, the public keys can be requested at the testing laboratory.

**Test performed:**

**Test report authorised:**

Jakob Reschke

Andreas Keller

## 1 Table of contents

1	Table of contents.....	2
2	General information .....	3
2.1	Notes.....	3
2.2	Application details.....	3
3	Test standard/s .....	3
4	Test environment.....	3
5	Test item.....	4
6	Test laboratories sub-contracted .....	4
7	Summary of measurement results .....	5
7.1	GSM 850.....	5
7.2	PCS 1900 .....	5
7.3	UMTS band II.....	6
7.4	UMTS band V.....	6
8	RF measurement testing .....	7
8.1	Description of test setup .....	7
8.1.1	Radiated measurements.....	7
8.1.2	Conducted measurements.....	8
8.2	Results GSM 850 .....	9
8.2.1	RF output power .....	9
8.3	Results PCS 1900 .....	11
8.3.1	RF output power .....	11
8.4	Results UMTS band II.....	13
8.4.1	RF output power .....	13
8.4.2	Spurious emissions radiated .....	15
8.5	Results UMTS band V .....	42
8.5.1	RF output power .....	42
8.5.2	Spurious emissions radiated .....	44
9	Test equipment and ancillaries used for tests .....	62
Annex A	Document history .....	64
Annex B	Further information.....	64

## 2 General information

### 2.1 Notes

The test results of this test report relate exclusively to the test item specified in this test report. CETECOM ICT Services GmbH does not assume responsibility for any conclusions and generalisations drawn from the test results with regard to other specimens or samples of the type of the equipment represented by the test item. The test report may only be reproduced or published in full. Reproduction or publication of extracts from the report requires the prior written approval of CETECOM ICT Services GmbH.

This test report is electronically signed and valid without handwriting signature. For verification of the electronic signatures, the public keys can be requested at the testing laboratory.

### 2.2 Application details

Date of receipt of order:	2011-04-15
Date of receipt of test item:	2011-06-27
Start of test:	2011-06-28
End of test:	2011-06-28
Person(s) present during the test:	-/-

## 3 Test standard/s

Test standard	Version	Test standard description
47 CFR Part 22	2009-10	Title 47 of the Code of Federal Regulations; Chapter I Part 22 - Public mobile services
47 CFR Part 24	2009-10	Title 47 of the Code of Federal Regulations; Chapter I Part 24 - Personal communications services
47 CFR Part 27	2008-10	Title 47 of the Code of Federal Regulations; Chapter I Part 27—Miscellaneous Wireless Communications Services
RSS - 132 Issue 2	2005-09	Spectrum Management and Telecommunications Policy - Radio Standards Specifications Cellular Telephones Employing New Technologies Operating in the Bands 824-849 MHz and 869-894 MHz
RSS - 133 Issue 5	2009-02	Spectrum Management and Telecommunications Policy - Radio Standards Specifications 2 GHz Personal Communication Services

## 4 Test environment

Temperature:	$T_{nom}$	+26 °C during room temperature tests
	$T_{max}$	-/- °C during high temperature test
	$T_{min}$	-/- °C during low temperature test
Relative humidity content:		58 %
Air pressure:		not relevant for this kind of testing
Power supply:	$V_{nom}$	3.7 V DC by battery EM1 +
	$V_{max}$	charger PSM04R-050CHW2
	$V_{min}$	-/- V
		-/- V

**5 Test item**

Kind of test item	:	Mobile phone with GSM / GPRS / Edge, WCDMA / HSDPA, Bluetooth® 2.1 EDR, WLAN b / g / n – HT20, NFC, GPS
Type identification	:	RDC71UW
S/N serial number	:	IMEI: 004402240770671 PIN: 279C8499 CER-33223-001
HW hardware status	:	Rev. 1
SW software status	:	8.0.0.233
Frequency band [MHz]	:	824.2 – 848.8 MHz, 1850.2 – 1909.8 MHz
Type of modulation	:	GMSK; 8-PSK, GMSK, 16 QAM
Antenna	:	Integrated PCB antenna
Power supply	:	3.7 V DC by battery EM1 + charger PSM04R-050CHW2
Temperature range	:	No information available!

**6 Test laboratories sub-contracted**

None

## 7 Summary of measurement results

- No deviations from the technical specifications were ascertained
- There were deviations from the technical specifications ascertained

TC identifier	Description	verdict	date	Remark
RF-Testing	CFR Part 22, 24, 27 RSS 132, 133	PASSED	2011-07-19	Delta tests according to customer test plan!

### 7.1 GSM 850

Test Case	temperature conditions	power source voltages	Pass	Fail	NA	NP	Remark
RF Output Power	Nominal	Nominal	<input checked="" type="checkbox"/>	<input type="checkbox"/>	<input type="checkbox"/>	<input type="checkbox"/>	-/-
Frequency Stability	Nominal	Nominal	<input type="checkbox"/>	<input type="checkbox"/>	<input type="checkbox"/>	<input checked="" type="checkbox"/>	-/-
Spurious Emissions Radiated	Nominal	Nominal	<input type="checkbox"/>	<input type="checkbox"/>	<input type="checkbox"/>	<input checked="" type="checkbox"/>	-/-
Spurious Emissions Conducted	Nominal	Nominal	<input type="checkbox"/>	<input type="checkbox"/>	<input type="checkbox"/>	<input checked="" type="checkbox"/>	-/-
Block Edge Compliance	Nominal	Nominal	<input type="checkbox"/>	<input type="checkbox"/>	<input type="checkbox"/>	<input checked="" type="checkbox"/>	-/-
Occupied Bandwidth	Nominal	Nominal	<input type="checkbox"/>	<input type="checkbox"/>	<input type="checkbox"/>	<input checked="" type="checkbox"/>	-/-

**Note:** NA = Not applicable; NP = Not performed

### 7.2 PCS 1900

Test Case	temperature conditions	power source voltages	Pass	Fail	NA	NP	Remark
RF Output Power	Nominal	Nominal	<input checked="" type="checkbox"/>	<input type="checkbox"/>	<input type="checkbox"/>	<input type="checkbox"/>	-/-
Frequency Stability	Nominal	Nominal	<input type="checkbox"/>	<input type="checkbox"/>	<input type="checkbox"/>	<input checked="" type="checkbox"/>	-/-
Spurious Emissions Radiated	Nominal	Nominal	<input type="checkbox"/>	<input type="checkbox"/>	<input type="checkbox"/>	<input checked="" type="checkbox"/>	-/-
Spurious Emissions Conducted	Nominal	Nominal	<input type="checkbox"/>	<input type="checkbox"/>	<input type="checkbox"/>	<input checked="" type="checkbox"/>	-/-
Block Edge Compliance	Nominal	Nominal	<input type="checkbox"/>	<input type="checkbox"/>	<input type="checkbox"/>	<input checked="" type="checkbox"/>	-/-
Occupied Bandwidth	Nominal	Nominal	<input type="checkbox"/>	<input type="checkbox"/>	<input type="checkbox"/>	<input checked="" type="checkbox"/>	-/-

**Note:** NA = Not applicable; NP = Not performed

### 7.3 UMTS band II

Test Case	temperature conditions	power source voltages	Pass	Fail	NA	NP	Remark
RF Output Power	Nominal	Nominal	<input checked="" type="checkbox"/>	<input type="checkbox"/>	<input type="checkbox"/>	<input type="checkbox"/>	-/-
Frequency Stability	Nominal	Nominal	<input type="checkbox"/>	<input type="checkbox"/>	<input type="checkbox"/>	<input checked="" type="checkbox"/>	-/-
Spurious Emissions Radiated	Nominal	Nominal	<input checked="" type="checkbox"/>	<input type="checkbox"/>	<input type="checkbox"/>	<input type="checkbox"/>	-/-
Spurious Emissions Conducted	Nominal	Nominal	<input type="checkbox"/>	<input type="checkbox"/>	<input type="checkbox"/>	<input checked="" type="checkbox"/>	-/-
Block Edge Compliance	Nominal	Nominal	<input type="checkbox"/>	<input type="checkbox"/>	<input type="checkbox"/>	<input checked="" type="checkbox"/>	-/-
Occupied Bandwidth	Nominal	Nominal	<input type="checkbox"/>	<input type="checkbox"/>	<input type="checkbox"/>	<input checked="" type="checkbox"/>	-/-

**Note:** NA = Not applicable; NP = Not performed

### 7.4 UMTS band V

Test Case	temperature conditions	power source voltages	Pass	Fail	NA	NP	Remark
RF Output Power	Nominal	Nominal	<input checked="" type="checkbox"/>	<input type="checkbox"/>	<input type="checkbox"/>	<input type="checkbox"/>	-/-
Frequency Stability	Nominal	Nominal	<input type="checkbox"/>	<input type="checkbox"/>	<input type="checkbox"/>	<input checked="" type="checkbox"/>	-/-
Spurious Emissions Radiated	Nominal	Nominal	<input checked="" type="checkbox"/>	<input type="checkbox"/>	<input type="checkbox"/>	<input type="checkbox"/>	-/-
Spurious Emissions Conducted	Nominal	Nominal	<input type="checkbox"/>	<input type="checkbox"/>	<input type="checkbox"/>	<input checked="" type="checkbox"/>	-/-
Block Edge Compliance	Nominal	Nominal	<input type="checkbox"/>	<input type="checkbox"/>	<input type="checkbox"/>	<input checked="" type="checkbox"/>	-/-
Occupied Bandwidth	Nominal	Nominal	<input type="checkbox"/>	<input type="checkbox"/>	<input type="checkbox"/>	<input checked="" type="checkbox"/>	-/-

**Note:** NA = Not applicable; NP = Not performed

## 8 RF measurement testing

### 8.1 Description of test setup

For the spurious measurements we use the substitution method according TIA/EIA 603.

#### 8.1.1 Radiated measurements

The radiated emissions from the EUT are performed in a semi anechoic chamber. The EUT is placed on a conductive turntable and powered with nominal voltage. The signalling is performed either from outside the chamber with a signalling unit (AP or other) by air link using a signalling antenna or directly by special test software from the customer.

Semi anechoic chamber

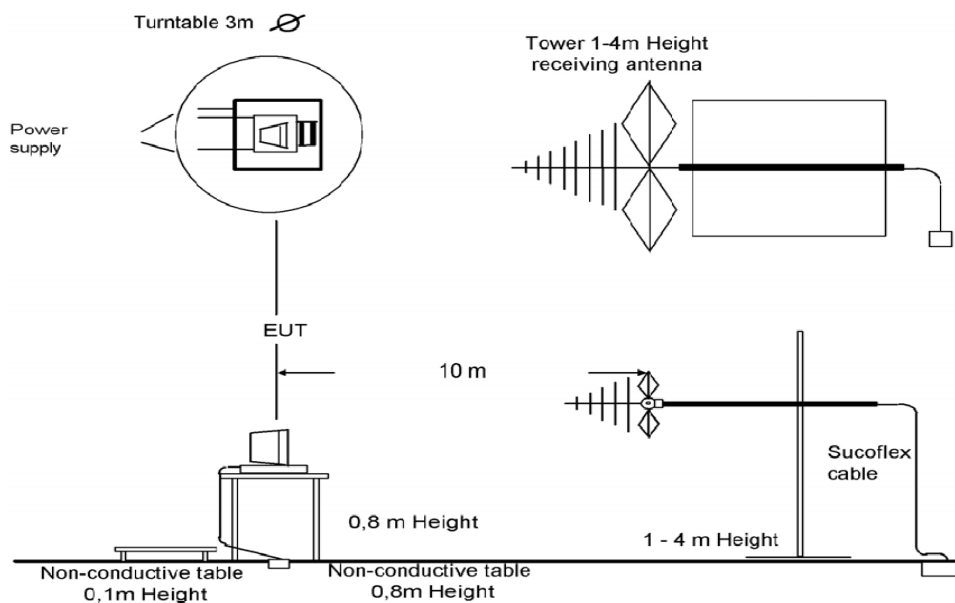

Picture 1: Diagram radiated measurements

9 kHz - 30 MHz:	active loop antenna
30 MHz – 1 GHz:	tri-log antenna
> 1 GHz:	horn antenna

### 8.1.2 Conducted measurements

The EUT's RF signal is coupled out by the antenna connector which is supplied by the manufacturer. The signal is first 10dB attenuated before it is power divided (~6dB loss per branch). One of the signal paths is connected to the signalling unit (AP or other), the other one is connected to the spectrum analyzer. The specific losses for both signal paths are first checked within a calibration. The measurement readings on the signalling unit/spectrum analyzer are corrected by the specific test set-up loss. The attenuator, power divider, signalling unit and the spectrum analyzer are impedance matched on 50 Ohm. If special software is used, there is no power divider necessary.

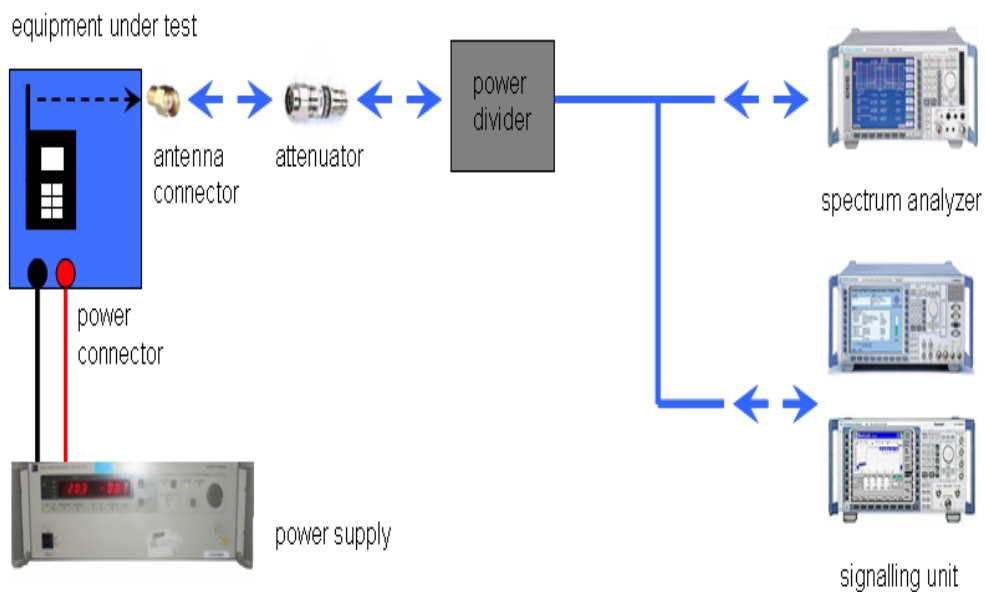

Picture 2: Diagram conducted measurements

The term measuring receiver refers to either a selective voltmeter or a spectrum analyser.

Frequency being measured f	Measuring receiver bandwidth 6 dB	Spectrum analyser bandwidth 3dB
$f < 150 \text{ kHz}$	200 Hz or	300 Hz
$150 \text{ kHz} \leq f < 25 \text{ MHz}$	9 kHz or	10 kHz
$25 \text{ MHz} \leq f < 1000 \text{ MHz}$	120 kHz or	100 kHz
$1000 \text{ MHz} \leq f$		1 MHz
NOTE: Specific requirements in CEPT/ERC/Recommendation 70-03 [2] shall be applied where applicable.		



## 8.2 Results GSM 850

All GSM-band measurements are done in GSM mode only (circuit switched).

All relevant tests have been repeated using 8-PSK modulation if EDGE mode is supported. All tests were performed with one timeslot in uplink activated and one timeslot in downlink activated. For each mode the highest output power was determined and used.

### 8.2.1 RF output power

#### Description:

This paragraph contains average power, peak output power and ERP measurements for the mobile station. In all cases, the peak output power is within the required mask (this mask is specified in the JTC standards, TIA PN3389 Vol. 1 Chap 7, and is no FCC requirement).

#### Measurement:

The mobile was set up for the maximum output power with pseudo random data modulation.

Measurement parameters	
Detector:	Peak and RMS (Power in Burst)
Sweep time:	Auto
Video bandwidth:	1 MHz
Resolution bandwidth:	1 MHz
Span:	Zero Span
Trace-Mode:	Max Hold

#### Limits:

FCC	IC
CFR Part 22.9.1.3 CFR Part 2.1046	RSS 132, Issue 2, Section 4.4 and 6.4
Nominal Peak Output Power	
+38.45 dBm	
In measuring transmissions in this band using an average power technique, the peak-to-average ratio (PAR) of the transmission may not exceed 13 dB.	

**Results:**

Output Power (radiated) GMSK mode	
Frequency (MHz)	Peak Output Power (dBm) - ERP
824.2	27.80
836.4	30.20
848.8	32.30
Measurement uncertainty	± 2.0 dB

Output Power (radiated) 8-PSK mode	
Frequency (MHz)	Peak Output Power (dBm) - ERP
824.2	24.40
836.4	25.50
848.8	27.10
Measurement uncertainty	± 2.0 dB

**Result:** [The result of the measurement is passed.](#)

### 8.3 Results PCS 1900

All GSM-band measurements are done in GSM mode only (circuit switched). All relevant tests have been repeated using 8-PSK modulation if EDGE mode is supported. All tests were performed with one timeslot in uplink activated and one timeslot in downlink activated. For each mode the highest output power was determined and used.

#### 8.3.1 RF output power

**Description:**

This paragraph contains average power, peak output power and EIRP measurements for the mobile station. In all cases, the peak output power is within the required mask (this mask is specified in the JTC standards, TIA PN3389 Vol. 1 Chap 7, and is no FCC requirement).

**Measurement:**

The mobile was set up for the maximum output power with pseudo random data modulation.

Measurement parameters	
Detector:	Peak and RMS (Power in Burst)
Sweep time:	Auto
Video bandwidth:	1 MHz
Resolution bandwidth:	1 MHz
Span:	Zero Span
Trace-Mode:	Max Hold

**Limits:**

FCC	IC
CFR Part 24.232 CFR Part 2.1046	RSS 133, Issue 5, Section 6.4
Nominal Peak Output Power	
+33.00 dBm	
In measuring transmissions in this band using an average power technique, the peak-to-average ratio (PAR) of the transmission may not exceed 13 dB.	

**Results:**

Output Power (radiated) 8-PSK mode	
Frequency (MHz)	Peak Output Power (dBm) - EIRP
1850.2	32.20
1880.0	32.40
1909.8	32.10
Measurement uncertainty	± 2.0 dB

**Result:** [The result of the measurement is passed.](#)

## 8.4 Results UMTS band II

All UMTS-band measurements are done in WCDMA mode only.

The connection was established with the following setup: WCDMA CS-RMC, Max Power (All Bit up)

### 8.4.1 RF output power

#### Description:

This paragraph contains average power, peak output power and EIRP measurements for the mobile station. In all cases, the peak output power is within the required mask (this mask is specified in the JTC standards, TIA PN3389 Vol. 1 Chap 7, and is no FCC requirement).

#### Measurement:

The mobile was set up for the maximum output power with pseudo random data modulation.

To determine the Peak-To-Average Power Ratio (PAPR) the measurement was performed with the Power Complementary Cumulative Distribution Function (CCDF).

Measurement parameters	
Detector:	Peak and RMS (Power in Burst)
Sweep time:	Auto
Video bandwidth:	10 MHz
Resolution bandwidth:	10 MHz
Span:	Zero Span
Trace-Mode:	Max Hold

#### Limits:

FCC	IC
CFR Part 24.232 CFR Part 2.1046	RSS 133, Issue 5, Section 6.4
Nominal Peak Output Power	
+33.00 dBm	
In measuring transmissions in this band using an average power technique, the peak-to-average ratio (PAR) of the transmission may not exceed 13 dB.	

**Results:**

Output Power (radiated) WCDMA mode - CS	
Frequency (MHz)	Peak Output Power (dBm) - EIRP
1852.4	29.50
1880.0	28.45
1907.6	27.50
Measurement uncertainty	± 2.0 dB

**Result:** [The result of the measurement is passed.](#)

## 8.4.2 Spurious emissions radiated

### Description:

The following steps outline the procedure used to measure the radiated emissions from the mobile station. The site is constructed in accordance with ANSI C63.4:2009 requirements and is recognized by the FCC to be in compliance for a 3 and a 10 meter site. The spectrum was scanned from 30 MHz to the 10th harmonic of the highest frequency generated within the equipment, which is the transmitted carrier that can be as high as 1910 MHz. This was rounded up to 20 GHz. The resolution bandwidth is set as outlined in Part 24.238. The spectrum was scanned with the mobile station transmitting at carrier frequencies that pertain to low, mid and high channels of the UMTS band II.

The final open field emission (here 10m semi-anechoic chamber listed by FCC) test procedure is as follows:

- a) The test item was placed on a 0.8 meter high non-conductive stand at a 3 meter test distance from the receive antenna.
- b) The antenna output was terminated in a 50 ohm load (if possible).
- c) A double ridged wave guide antenna was placed on an adjustable height antenna mast 3 meters from the test item for emission measurements.
- d) Detected emissions were maximized at each frequency by rotating the test item and adjusting the receive antenna height and polarization. The maximum meter reading was recorded. The radiated emission measurements of the harmonics of the transmit frequency through the 10th harmonic were measured with peak detector and 1 MHz bandwidth. If the harmonic could not be detected above the noise floor, the ambient level was recorded. The equivalent power into a dipole antenna was calculated from the field intensity levels measured at 3 meters.
- e) Now each detected emissions were substituted by the substitution method, in accordance with the TIA/EIA 603 .

### Measurement:

Measurement parameters	
Detector:	Peak
Sweep time:	2 sec.
Video bandwidth:	Below 1 GHz: 120 kHz Above 1 GHz: 1 MHz
Resolution bandwidth:	Below 1 GHz: 120 kHz Above 1 GHz: 1 MHz
Span:	100 MHz Steps
Trace-Mode:	Max Hold

### Limits:

FCC	IC
CFR Part 24.238 CFR Part 2.1053	RSS 133, Issue 5, Section 6.5
Spurious Emissions Radiated	
Attenuation $\geq 43 + 10\log(P)$ (P, Power in Watts)	
-13 dBm	

**Results:**

Radiated emissions measurements were made only at the upper, center, and lower carrier frequencies of the UMTS band II (1852.4 MHz, 1880.0 MHz and 1907.6 MHz). It was decided that measurements at these three carrier frequencies would be sufficient to demonstrate compliance with emissions limits because it was seen that all the significant spurs occur well outside the band and no radiation was seen from a carrier in one block of the UMTS band II into any of the other blocks. The equipment must still, however, meet emissions requirements with the carrier at all frequencies over which it is capable of operating and it is the manufacturer's responsibility to verify this.

The final open field radiated levels are presented on the next pages. All measurements were done in horizontal and vertical polarization; the plots show the worst case. The plots show only the middle channel. If spurious were detected, the lowest and highest channel were checked too. The found values are stated in the table below.

As can be seen from this data, the emissions from the test item were within the specification limit.

**Voice:**

Spurious Emission Level (dBm)								
Harmonic	Ch. 9262 Freq. (MHz)	Level [dBm]	Harmonic	Ch. 9400 Freq. (MHz)	Level [dBm]	Harmonic	Ch. 9538 Freq. (MHz)	Level [dBm]
2	3704.8	-43.09	2	3760.0	-39.63	2	3815.2	-32.02
3	5557.2	-	3	5640.0	-	3	5722.8	-
4	7409.6	-	4	7520.0	-	4	7630.4	-
5	9262.0	-	5	9400.0	-	5	9538.0	-
6	11114.4	-	6	11280.0	-	6	11445.6	-
7	12966.8	-	7	13160.0	-	7	13353.2	-
8	14819.2	-	8	15040.0	-	8	15260.8	-
9	16671.6	-	9	16920.0	-	9	17168.4	-
10	18524.0	-	10	18800.0	-	10	19076.0	-
Measurement uncertainty					± 3dB			

**Result:** The result of the measurement is passed.



**HSUPA:**

Spurious Emission Level (dBm)								
Harmonic	Ch. 9262 Freq. (MHz)	Level [dBm]	Harmonic	Ch. 9400 Freq. (MHz)	Level [dBm]	Harmonic	Ch. 9538 Freq. (MHz)	Level [dBm]
2	3704.8	-44.28	2	3760.0	-40.08	2	3815.2	-33.95
3	5557.2	-	3	5640.0	-	3	5722.8	-
4	7409.6	-	4	7520.0	-	4	7630.4	-
5	9262.0	-	5	9400.0	-	5	9538.0	-
6	11114.4	-	6	11280.0	-	6	11445.6	-
7	12966.8	-	7	13160.0	-	7	13353.2	-
8	14819.2	-	8	15040.0	-	8	15260.8	-
9	16671.6	-	9	16920.0	-	9	17168.4	-
10	18524.0	-	10	18800.0	-	10	19076.0	-
Measurement uncertainty					± 3dB			

**Result:** [The result of the measurement is passed.](#)

**CS**

**Plot 1: Channel 9262 (Traffic mode up to 30 MHz)**

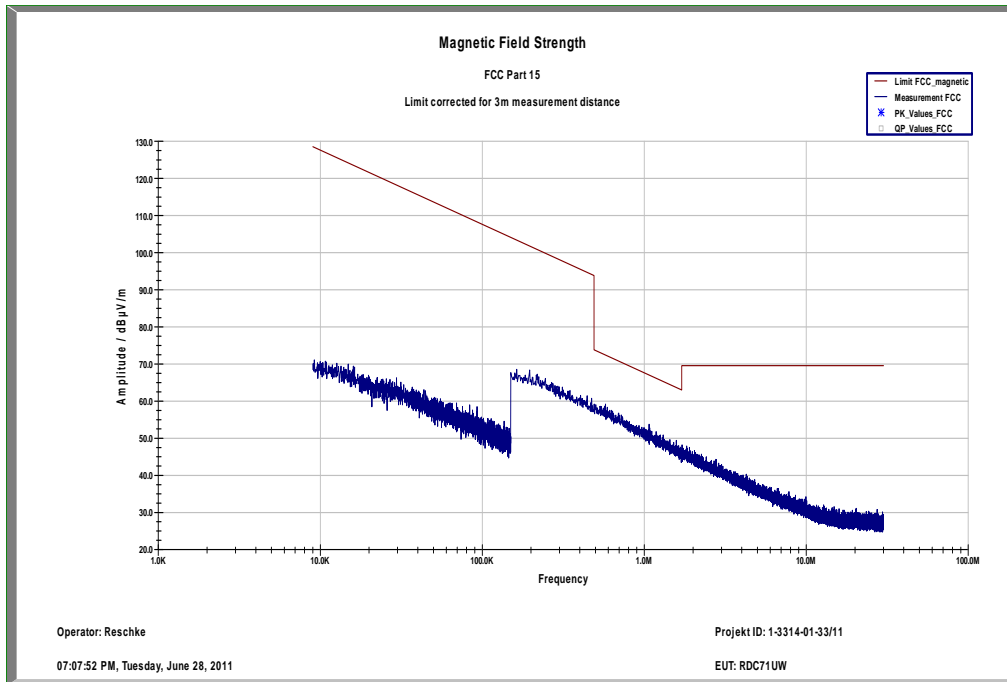

**Plot 2: Channel 9262 (30 MHz - 1 GHz) – vertical**

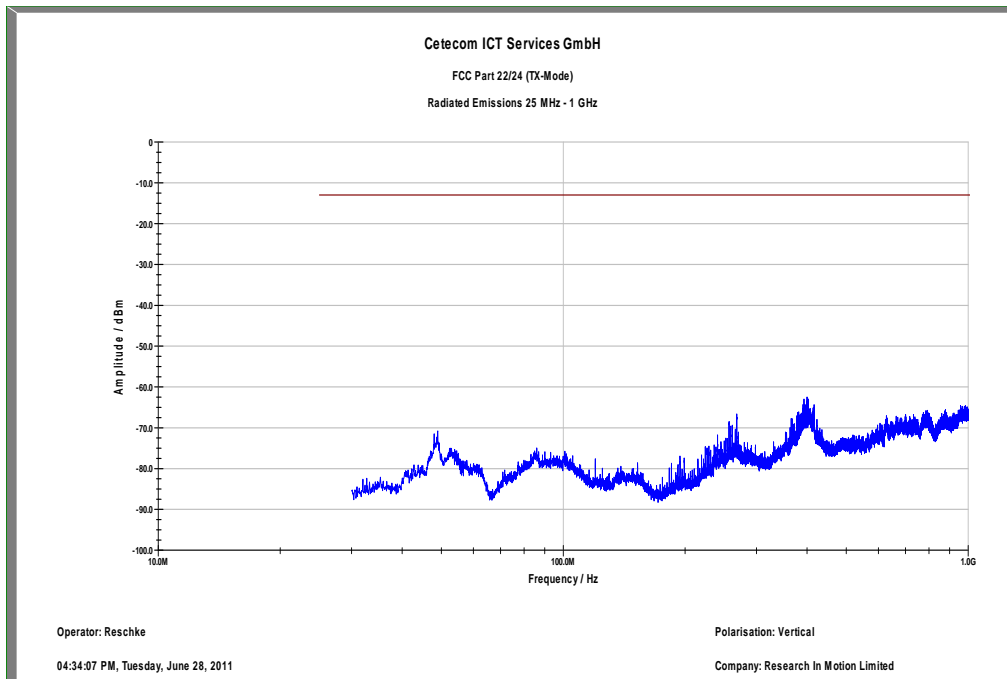

Plot 3: Channel 9262 (1 GHz – 12.75 GHz) – vertical

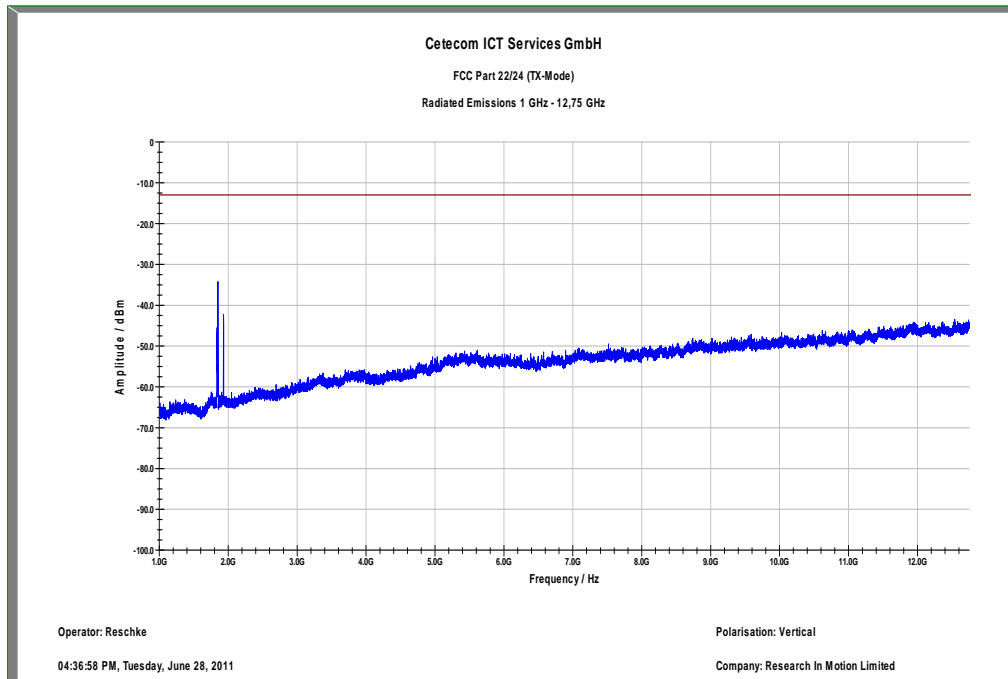

Carrier notched with 1.9 GHz rejection filter

Plot 4: Channel 9262 (12 GHz - 18 GHz) – vertical/horizontal (max hold)

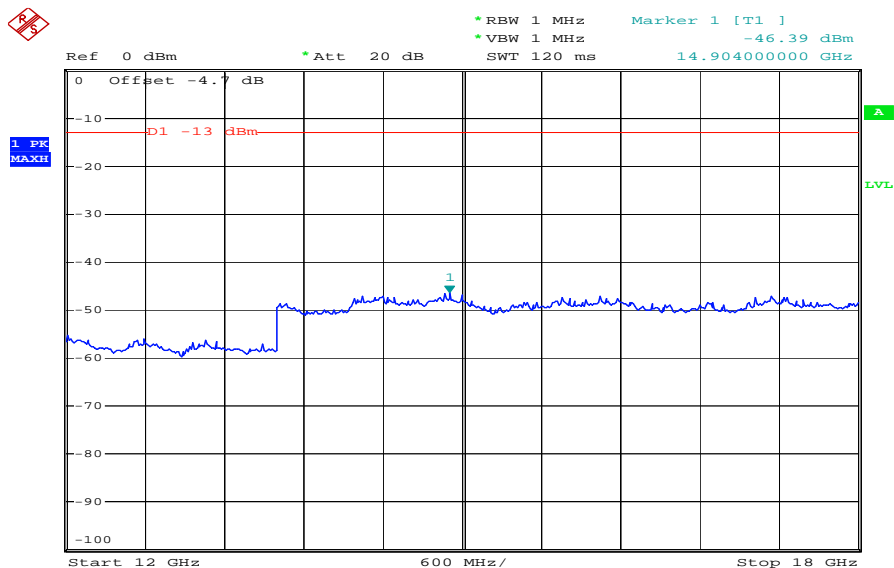

Date: 29.JUN.2011 14:58:10

Plot 5: Channel 9262 (18 GHz - 25 GHz) – vertical/horizontal (max hold)

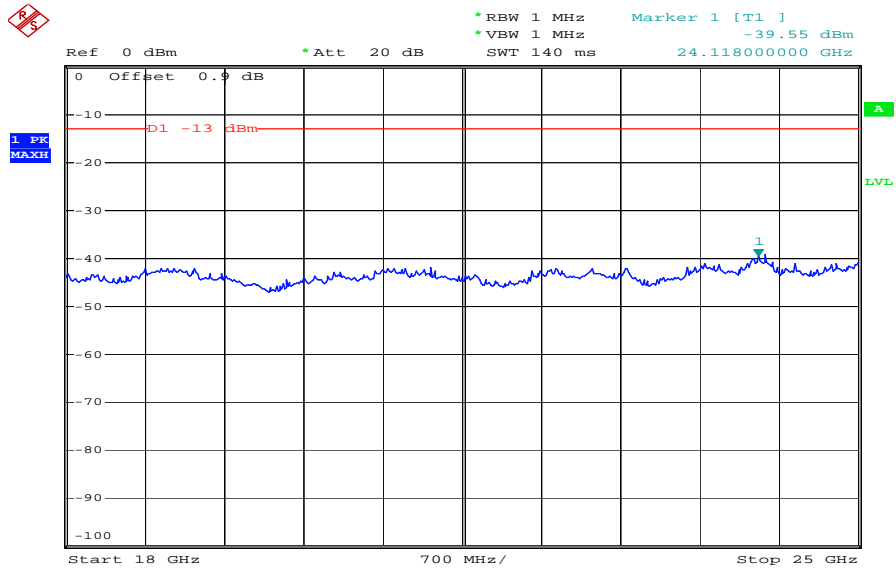

Date: 29.JUN.2011 15:04:53

Plot 6: Channel 9262 (30 MHz - 1 GHz) – horizontal

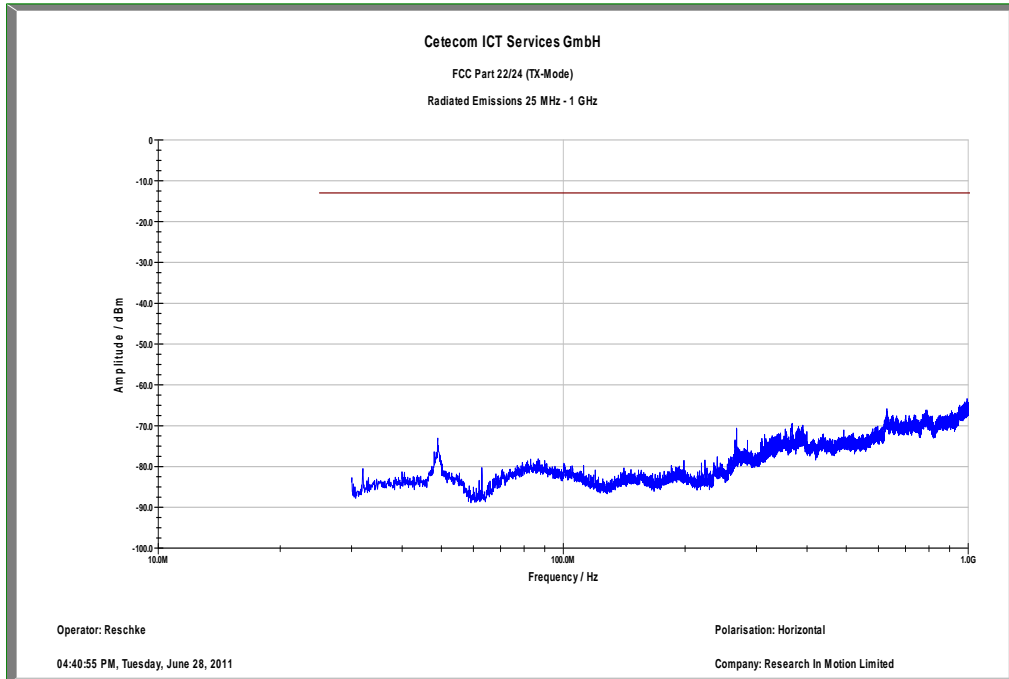

Plot 7: Channel 9262 (1 GHz – 12.75 GHz) – horizontal

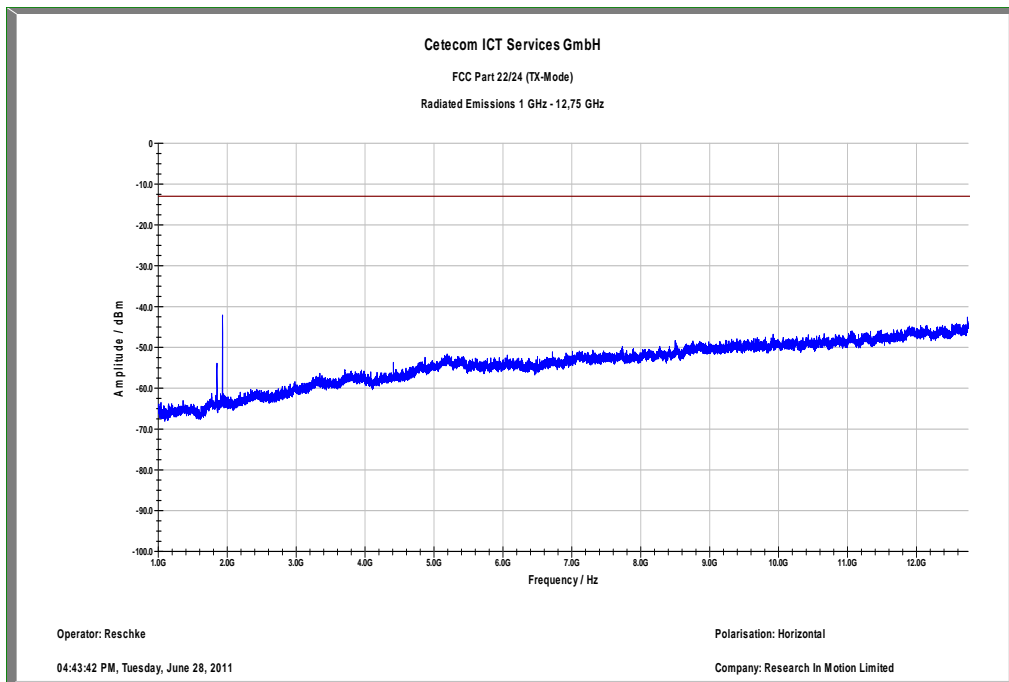

*Carrier notched with 1.9 GHz rejection filter*

Plot 8: Channel 9400 (Traffic mode up to 30 MHz)

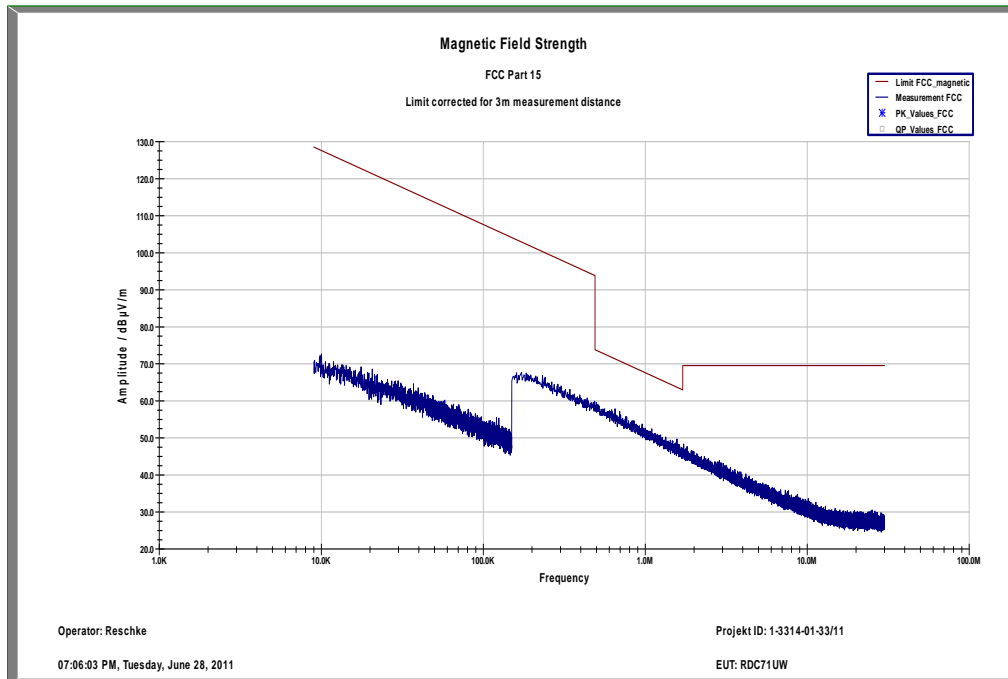

Plot 9: Channel 9400 (30 MHz - 1 GHz) – vertical

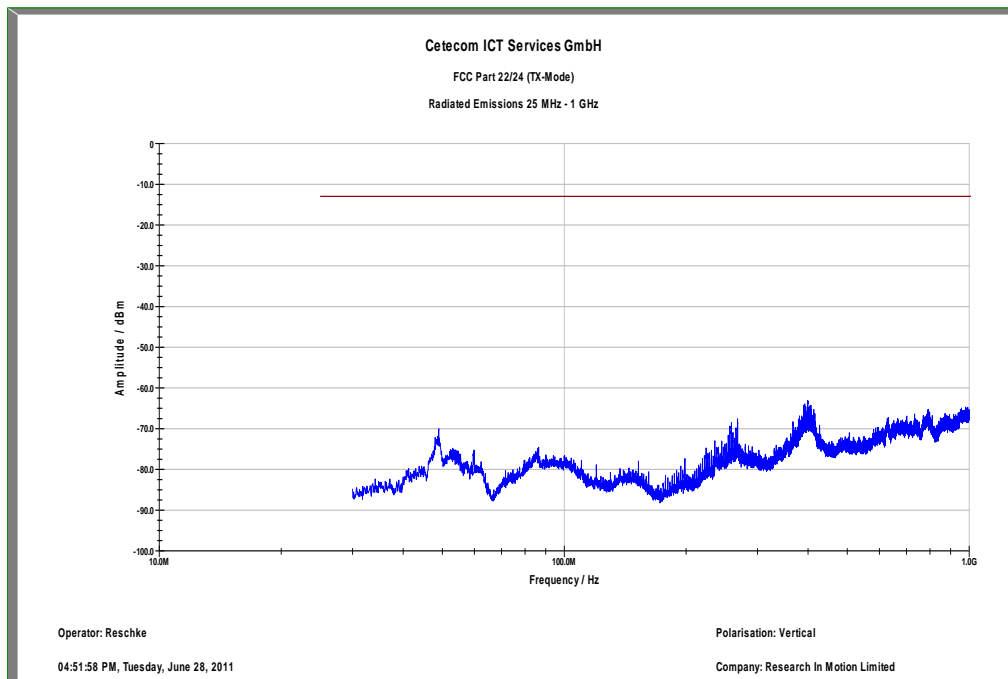

Plot 10: Channel 9400 (1 GHz – 12.75 GHz) – vertical

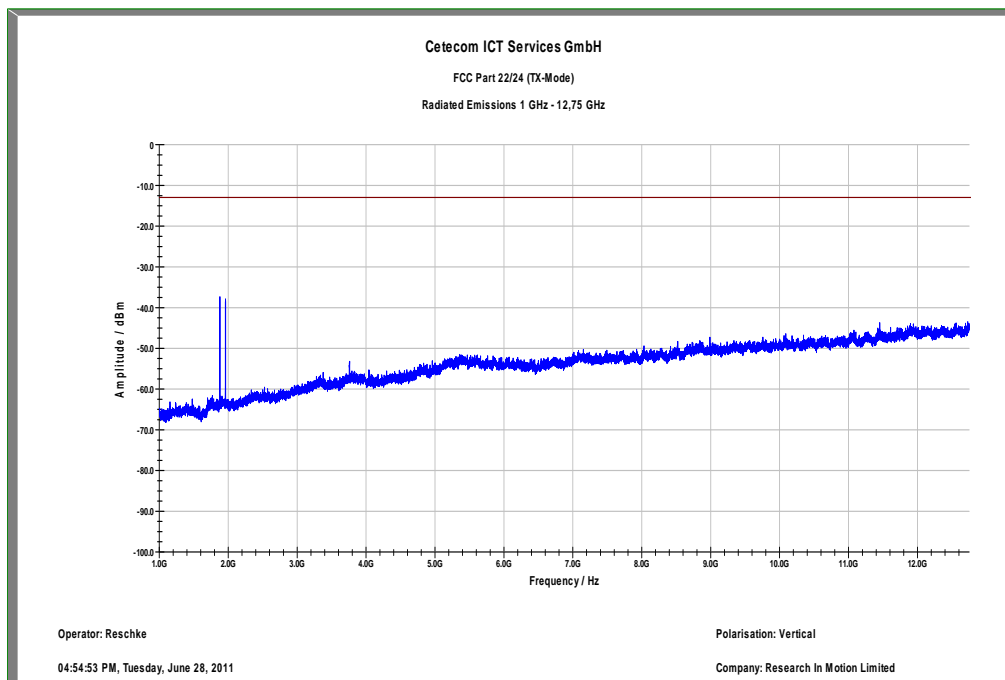

Carrier notched with 1.9 GHz rejection filter

Plot 11: Channel 9400 (12 GHz - 18 GHz) – vertical/horizontal (max hold)

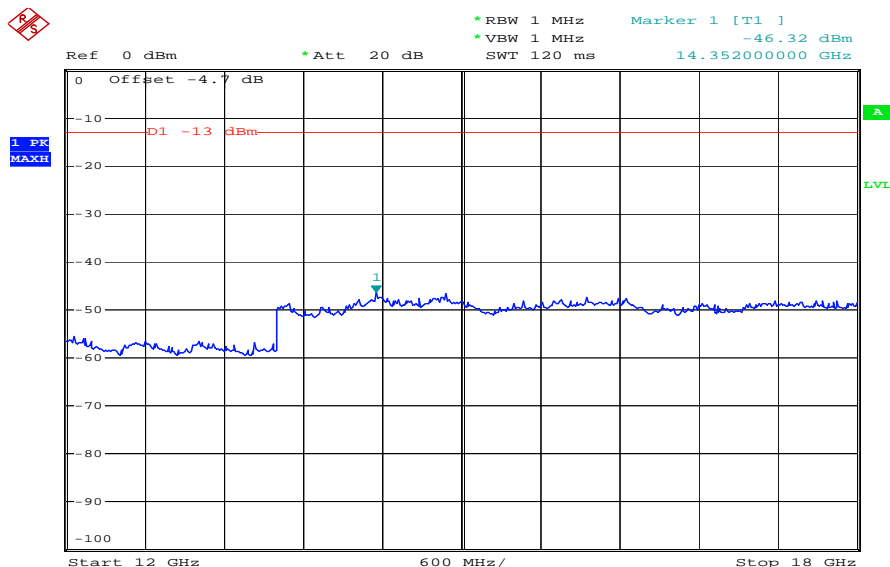

Date: 29.JUN.2011 15:02:10

Plot 12: Channel 9400 (18 GHz - 25 GHz) – vertical/horizontal (max hold)

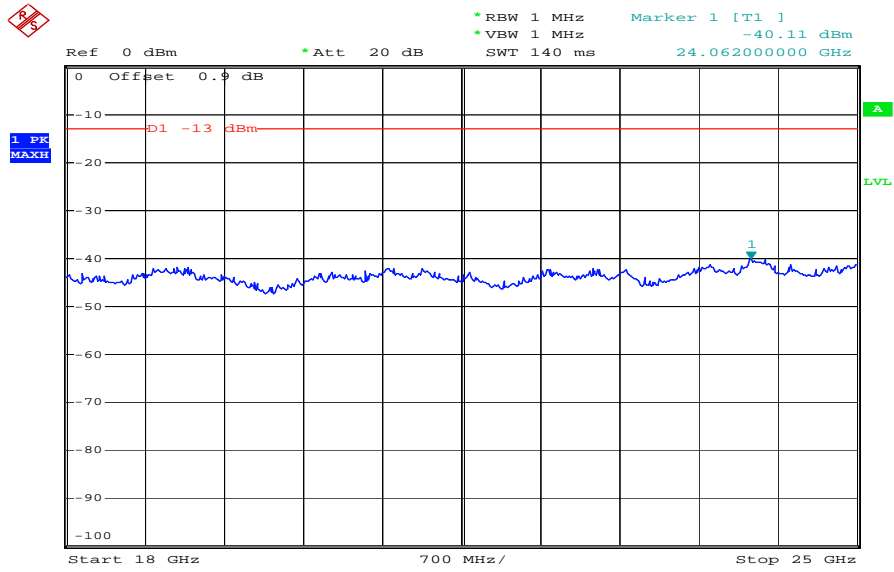

Date: 29.JUN.2011 15:05:36



Plot 13: Channel 9400 (30 MHz - 1 GHz) – horizontal

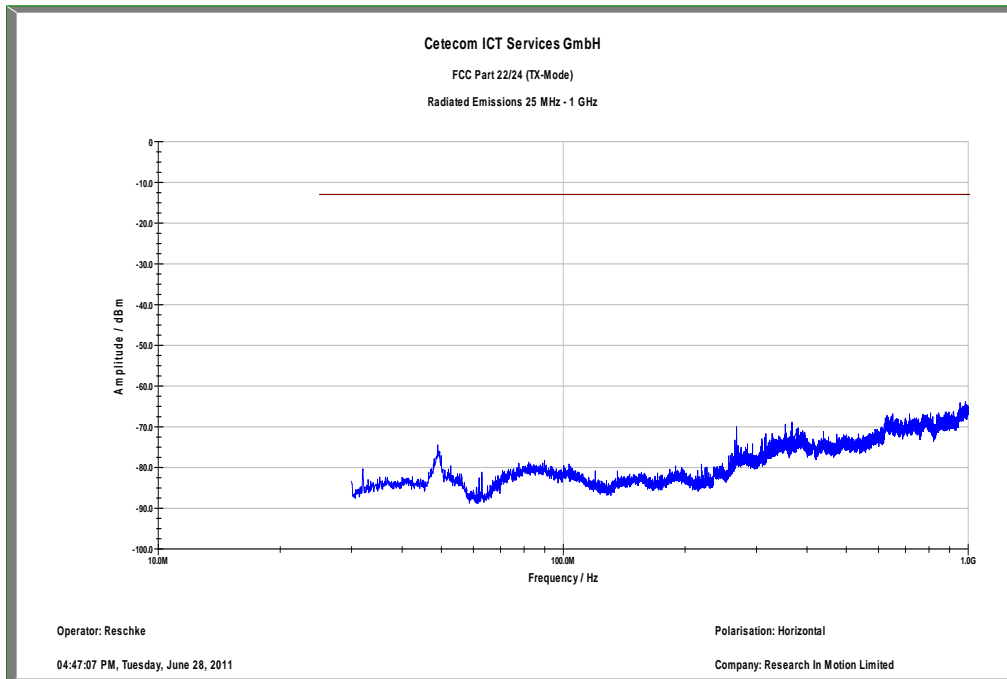

Plot 14: Channel 9400 (1 GHz – 12.75 GHz) – horizontal

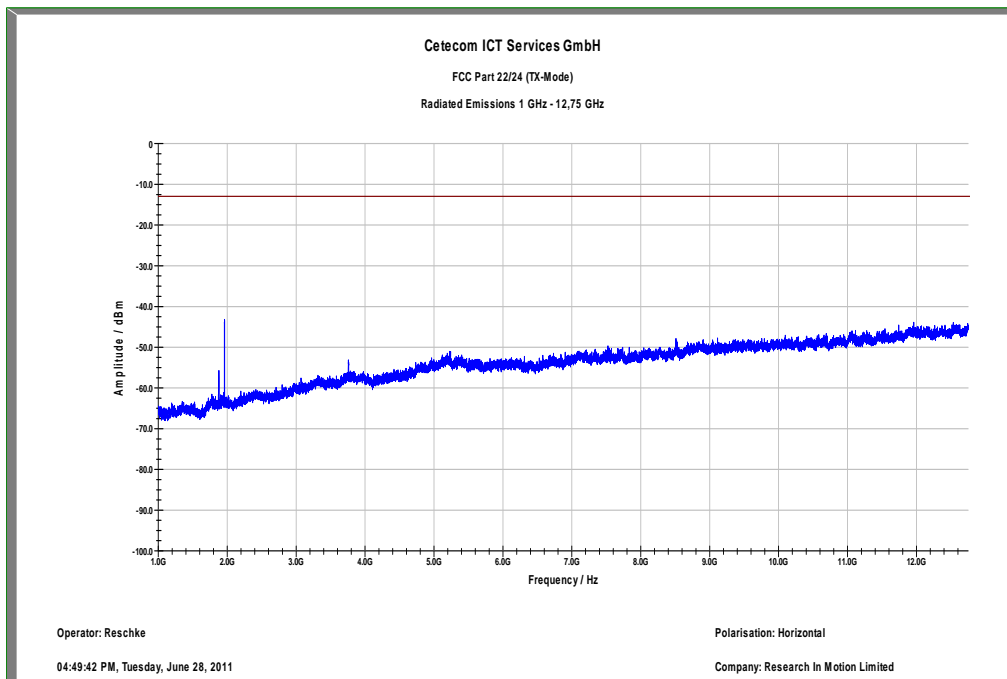

*Carrier notched with 1.9 GHz rejection filter*

Plot 15: Channel 9538 (Traffic mode up to 30 MHz)

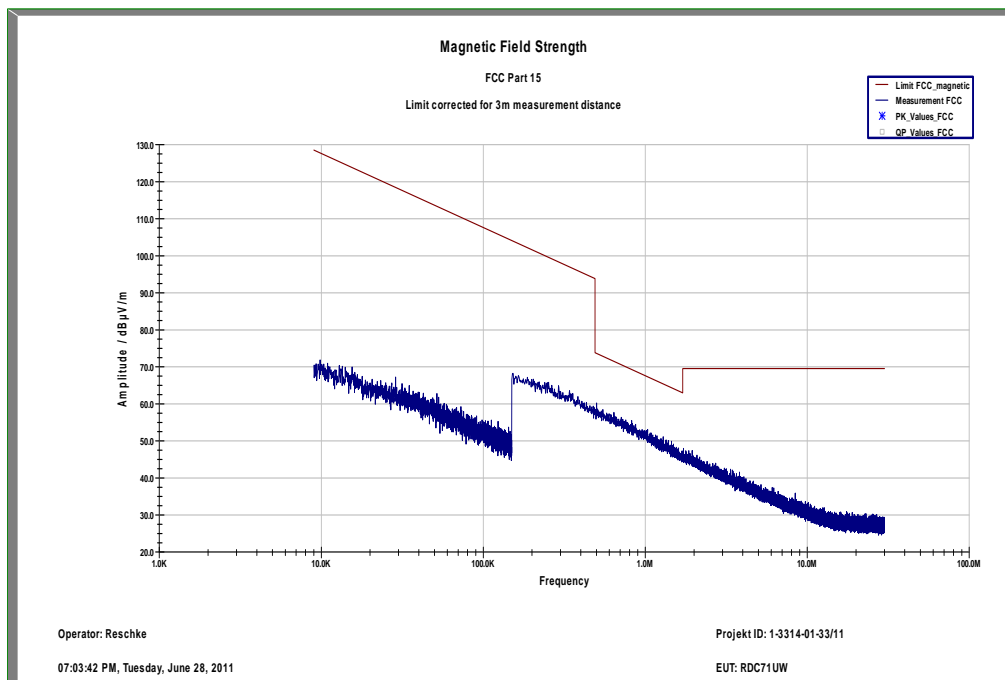

Plot 16: Channel 9538 (30 MHz - 1 GHz) – vertical

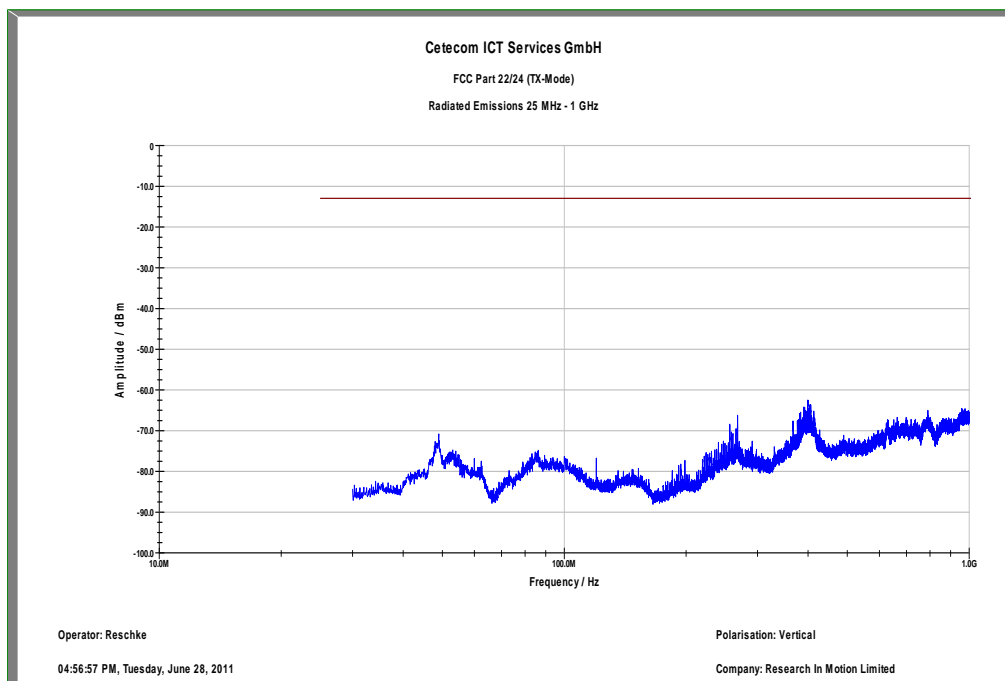

Plot 17: Channel 9538 (1 GHz – 12.75 GHz) – vertical

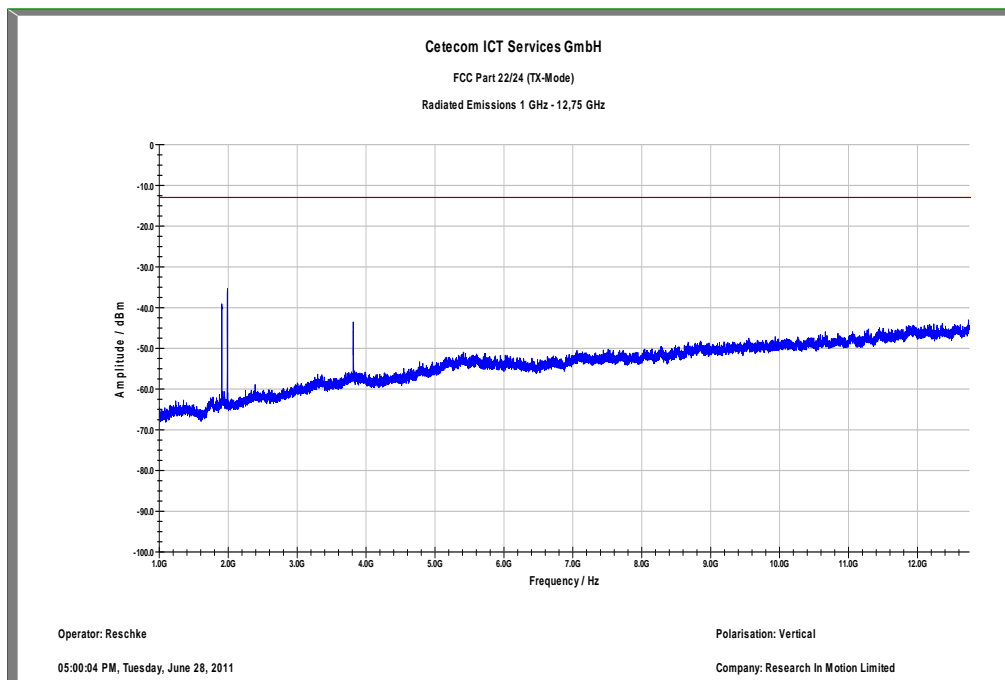

Carrier notched with 1.9 GHz rejection filter

Plot 18: Channel 9538 (12 GHz - 18 GHz) – vertical/horizontal (max hold)

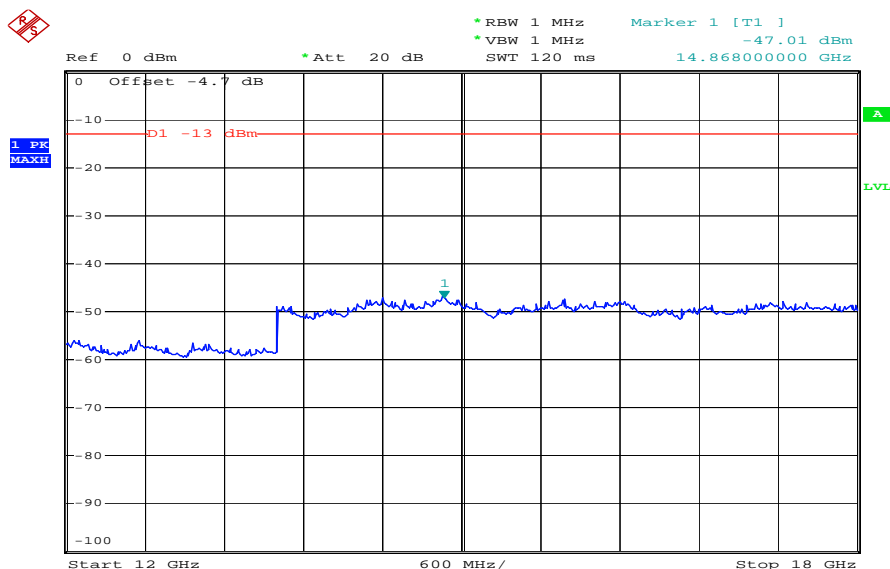

Date: 29 JUN 2011 15:02:42

Plot 19: Channel 9538 (18 GHz - 25 GHz) – vertical/horizontal (max hold)

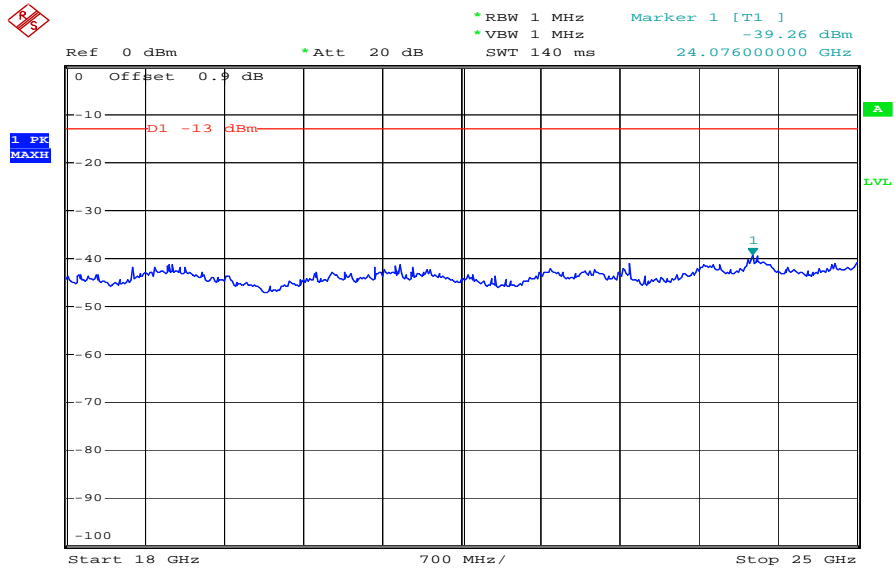

Date: 29.JUN.2011 15:06:23

Plot 20: Channel 9538 (30 MHz - 1 GHz) – horizontal

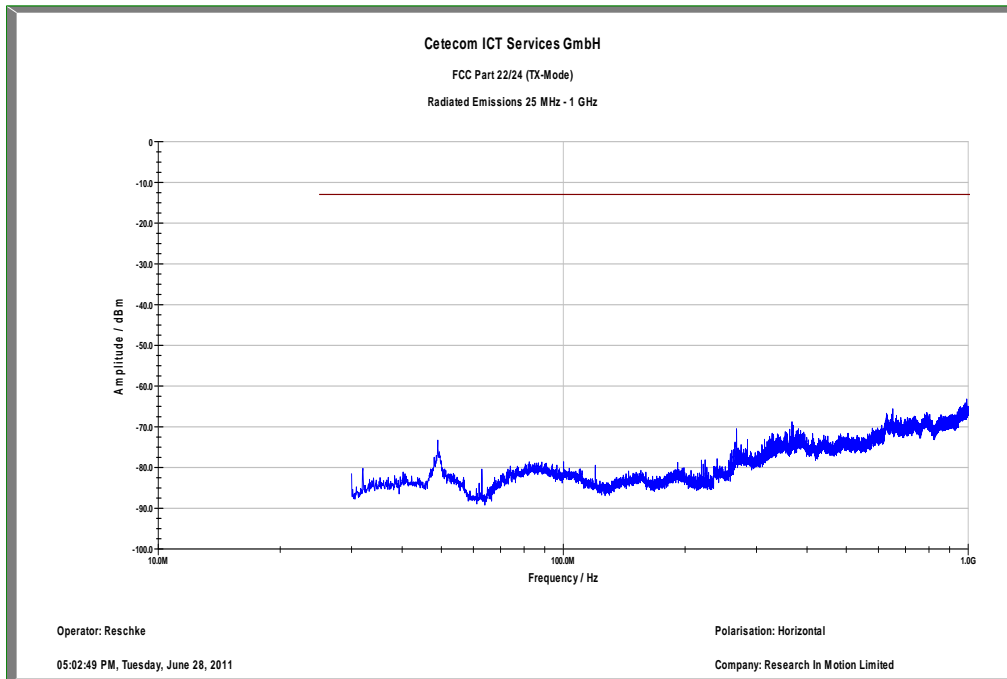

Plot 21: Channel 9538 (1 GHz – 12.75 GHz) – horizontal

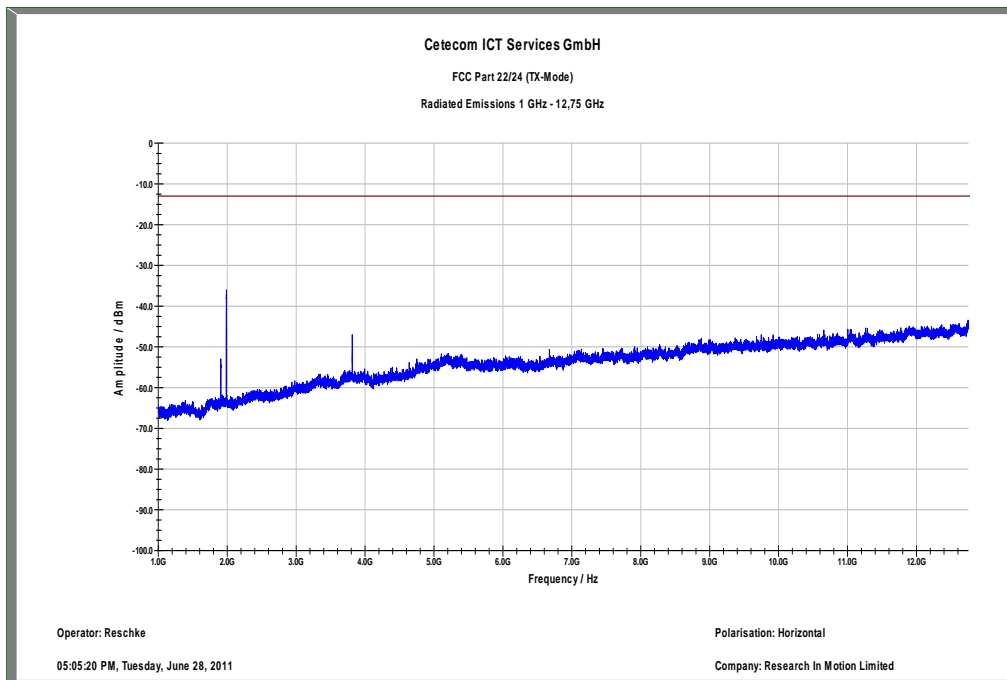

*Carrier notched with 1.9 GHz rejection filter*

**HSUPA**

**Plot 1: Channel 9262 (Traffic mode up to 30 MHz)**

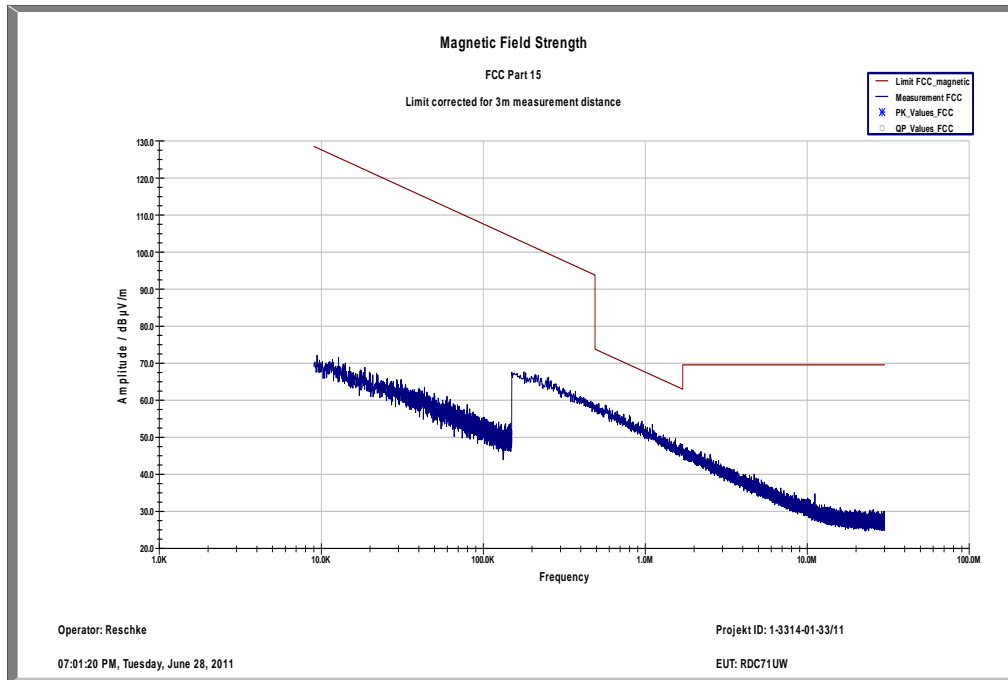

**Plot 2: Channel 9262 (30 MHz - 1 GHz) – vertical**

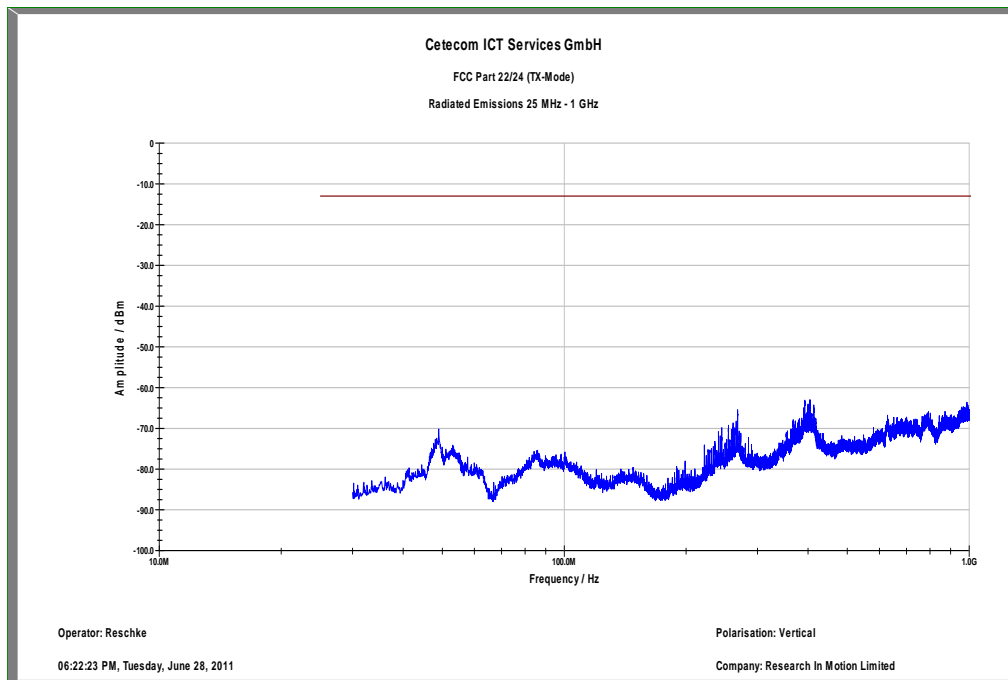

Plot 3: Channel 9262 (1 GHz – 12.75 GHz) – vertical

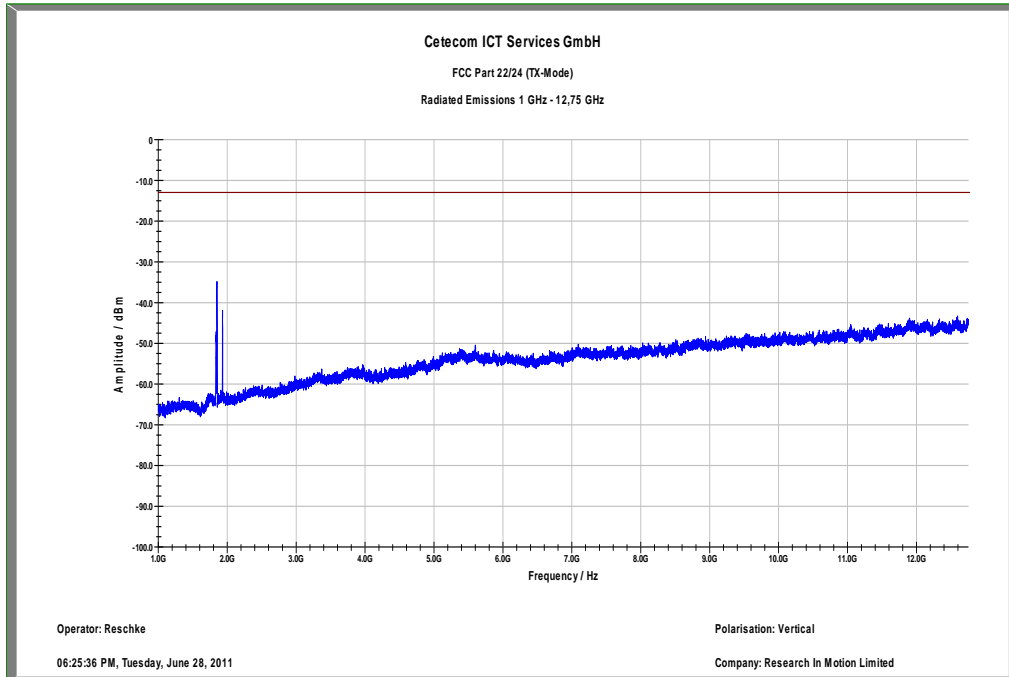

Carrier notched with 1.9 GHz rejection filter

Plot 4: Channel 9262 (12 GHz - 18 GHz) – vertical/horizontal (max hold)

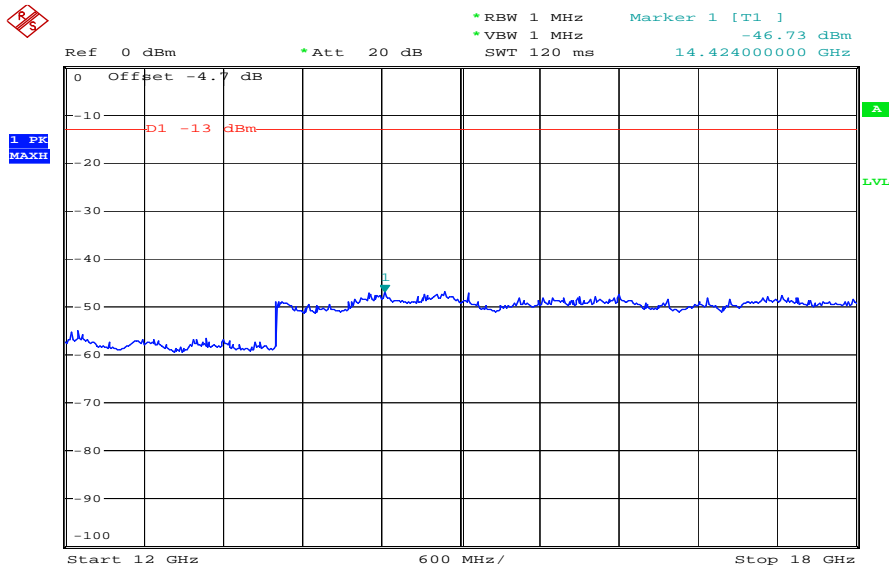

Date: 29.JUN.2011 15:36:30

Plot 5: Channel 9262 (18 GHz - 25 GHz) – vertical/horizontal (max hold)

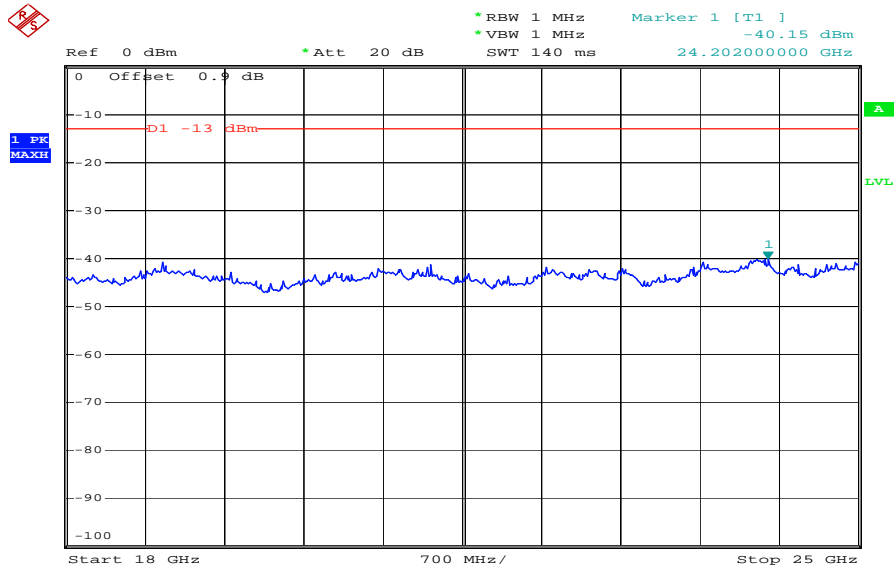

Date: 29.JUN.2011 15:27:50



Plot 6: Channel 9262 (30 MHz - 1 GHz) – horizontal

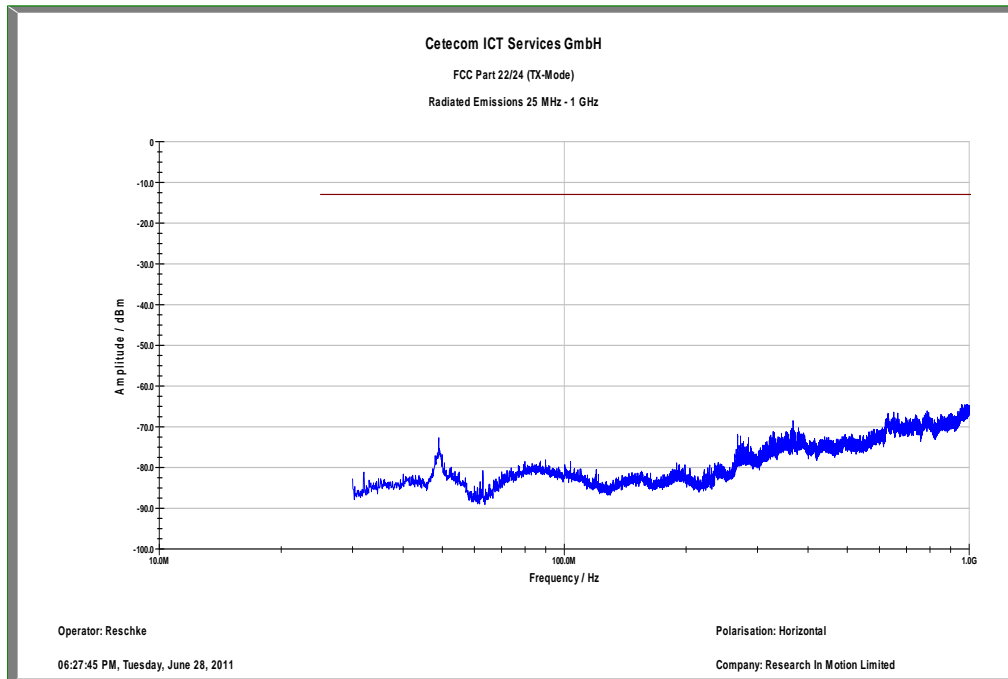

Plot 7: Channel 9262 (1 GHz – 12.75 GHz) – horizontal

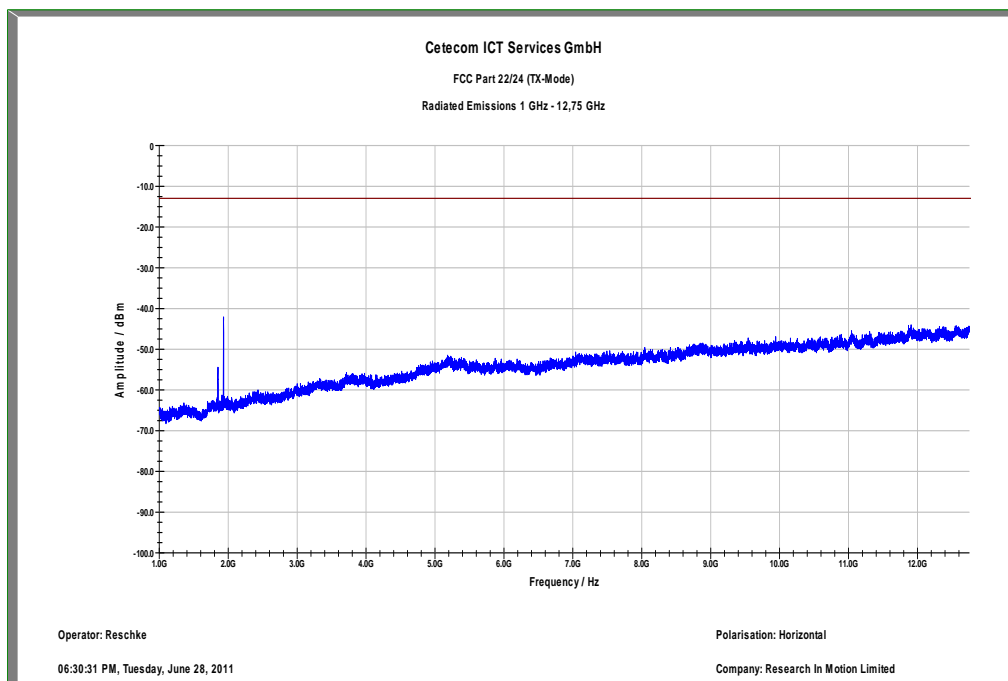

*Carrier notched with 1.9 GHz rejection filter*

Plot 8: Channel 9400 (Traffic mode up to 30 MHz)

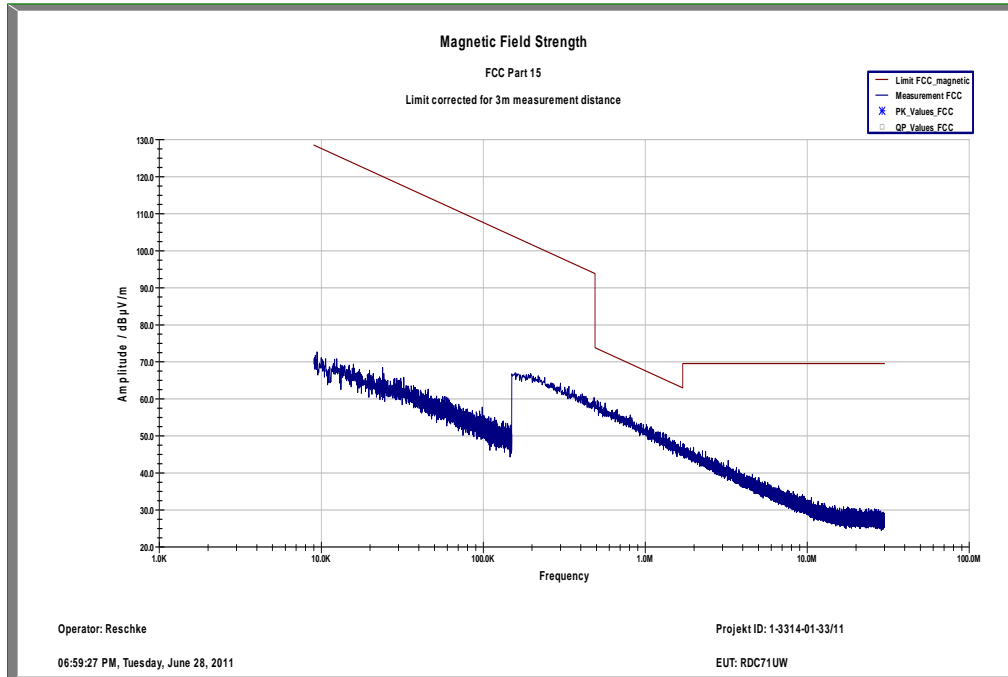

Plot 9: Channel 9400 (30 MHz - 1 GHz) – vertical

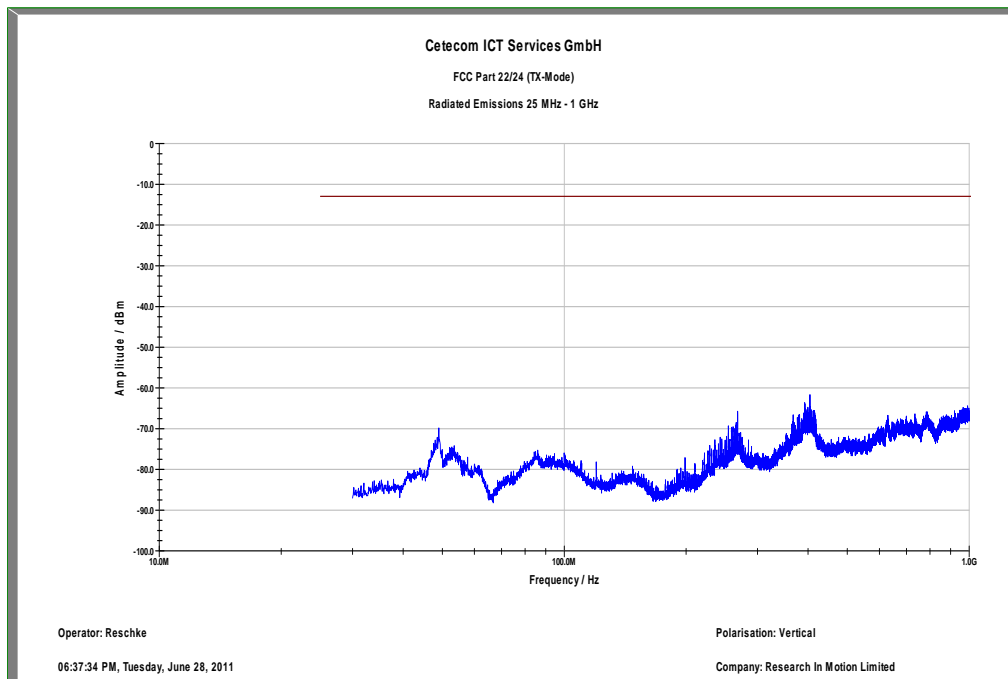

Plot 10: Channel 9400 (1 GHz – 12.75 GHz) – vertical

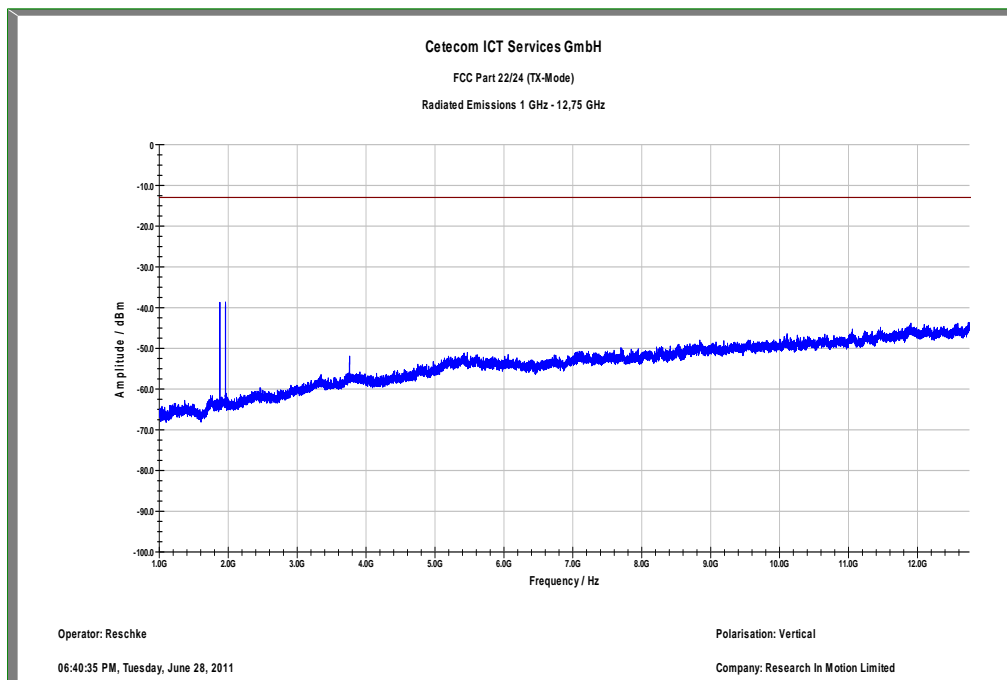

Carrier notched with 1.9 GHz rejection filter

Plot 11: Channel 9400 (12 GHz - 18 GHz) – vertical/horizontal (max hold)

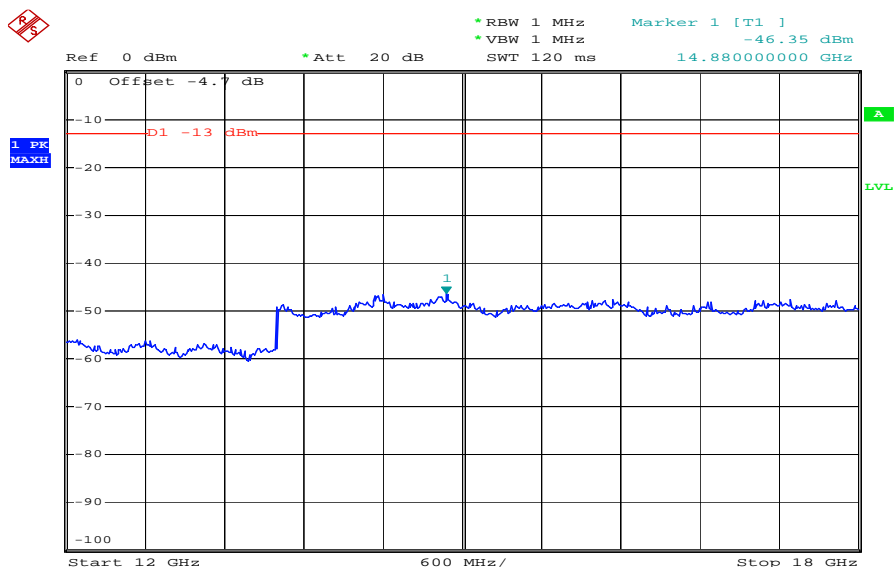

Date: 29.JUN.2011 15:35:37

Plot 12: Channel 9400 (18 GHz - 25 GHz) – vertical/horizontal (max hold)

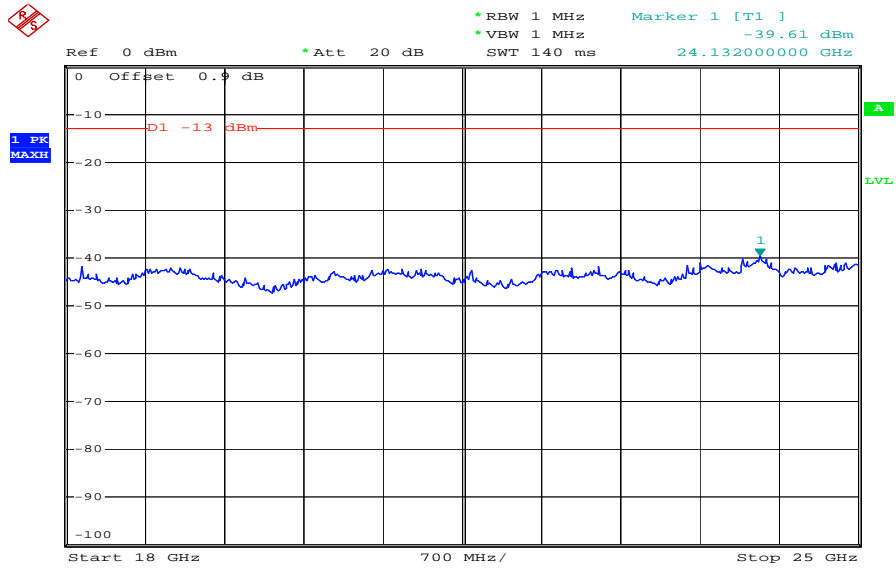

Date: 29.JUN.2011 15:28:35

Plot 13: Channel 9400 (30 MHz - 1 GHz) – horizontal

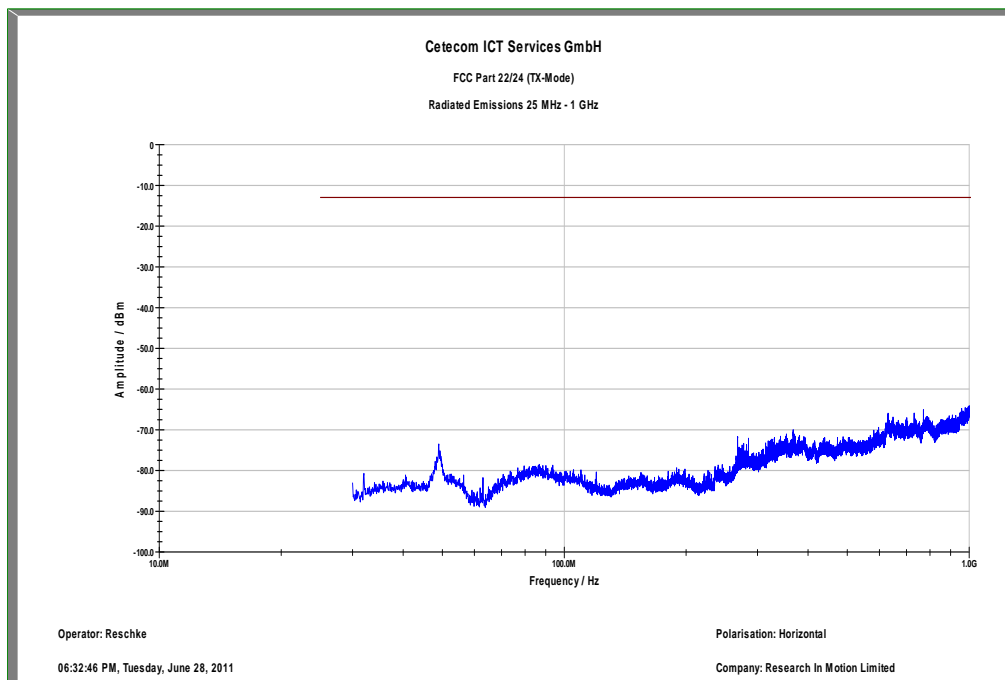

Plot 14: Channel 9400 (1 GHz – 12.75 GHz) – horizontal

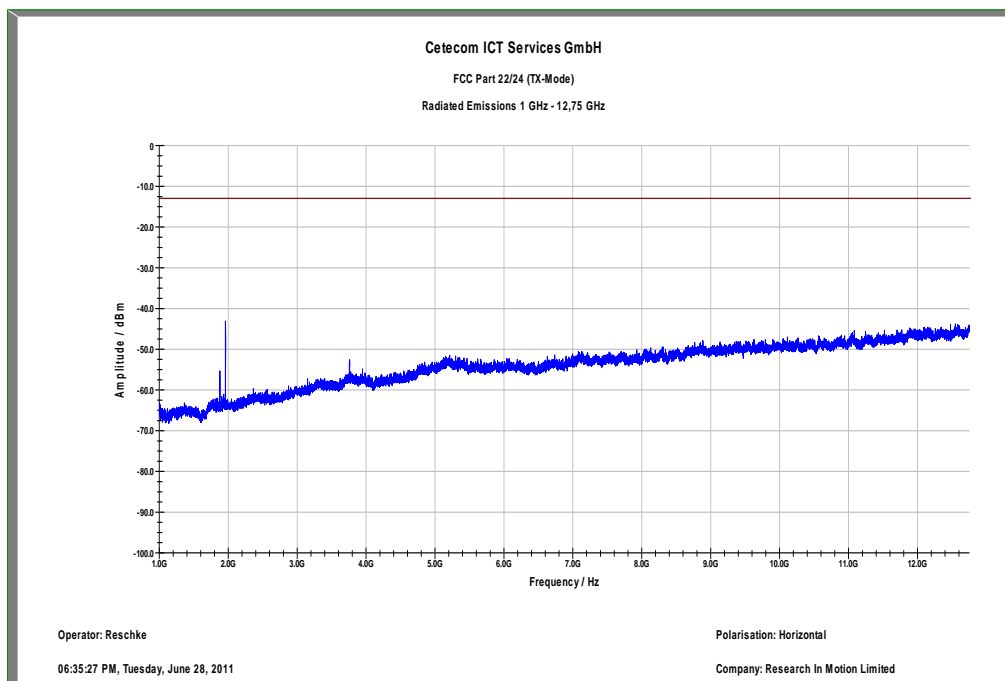

*Carrier notched with 1.9 GHz rejection filter*

Plot 15: Channel 9538 (Traffic mode up to 30 MHz)

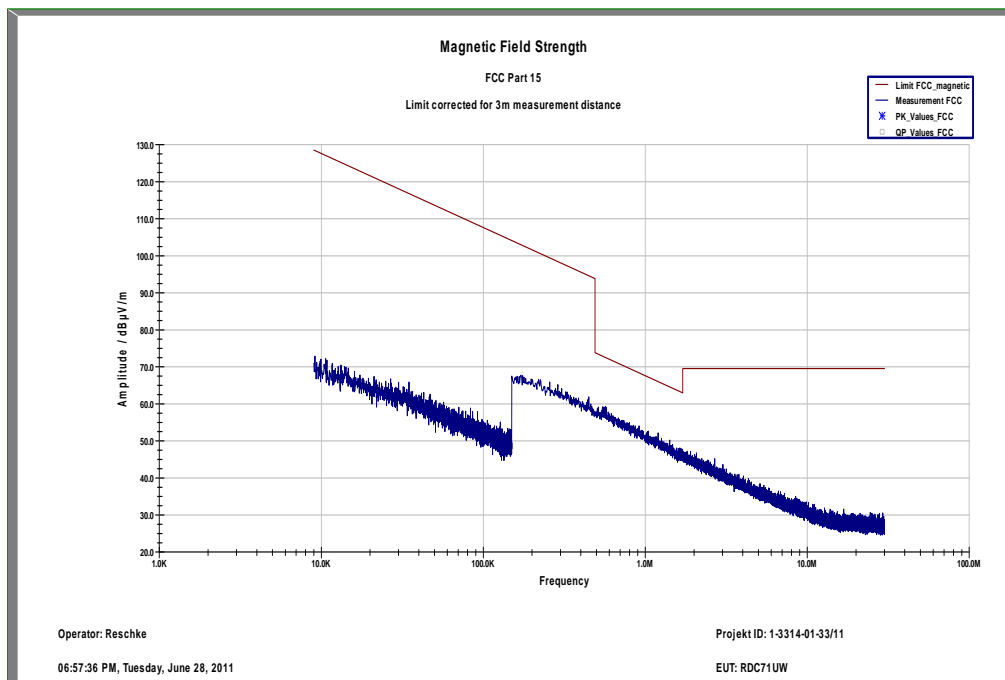

Plot 16: Channel 9538 (30 MHz - 1 GHz) – vertical

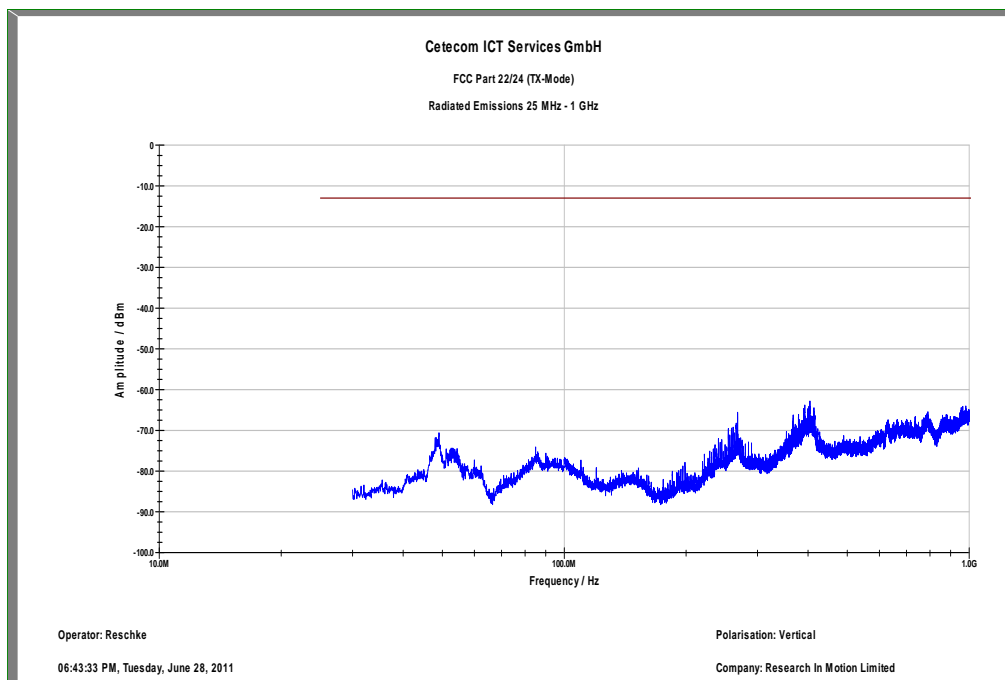

Plot 17: Channel 9538 (1 GHz – 12.75 GHz) – vertical

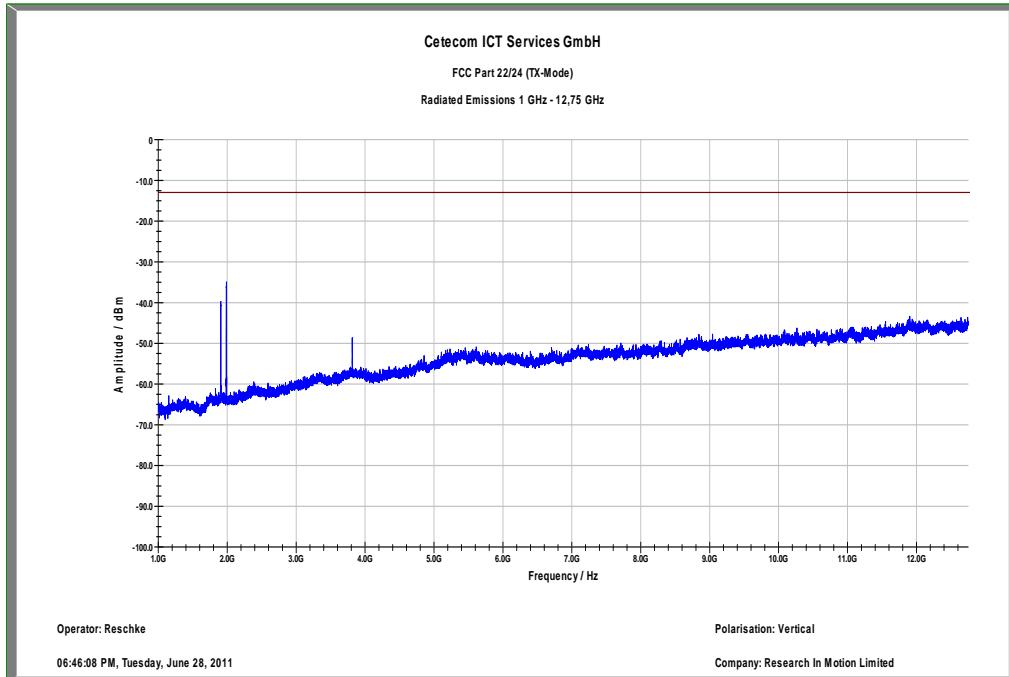

Carrier notched with 1.9 GHz rejection filter

Plot 18: Channel 9538 (12 GHz - 18 GHz) – vertical/horizontal (max hold)

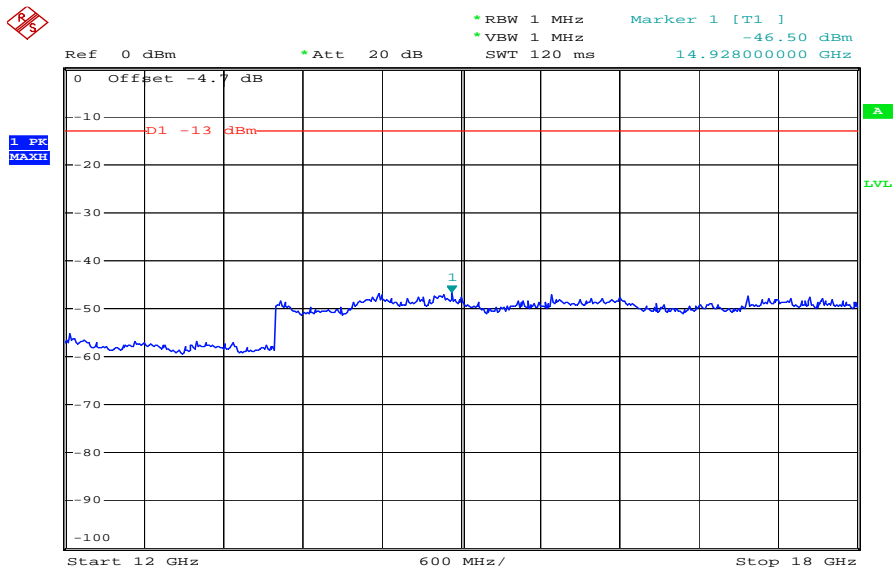

Date: 29.JUN.2011 15:31:38

Plot 19: Channel 9538 (18 GHz - 25 GHz) – vertical/horizontal (max hold)

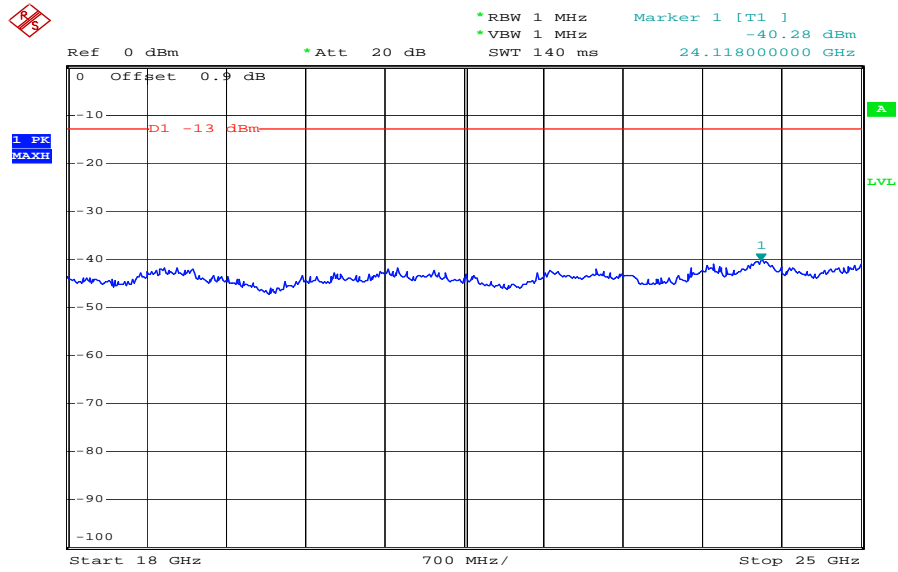

Date: 29.JUN.2011 15:29:14



Plot 20: Channel 9538 (30 MHz - 1 GHz) – horizontal

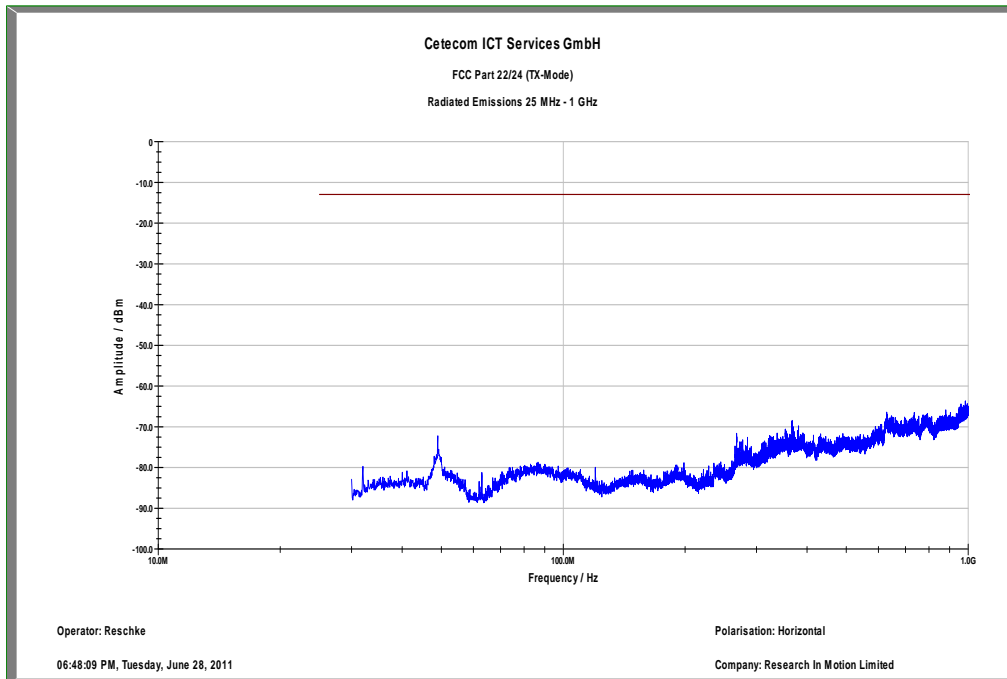

Plot 21: Channel 9538 (1 GHz – 12.75 GHz) – horizontal

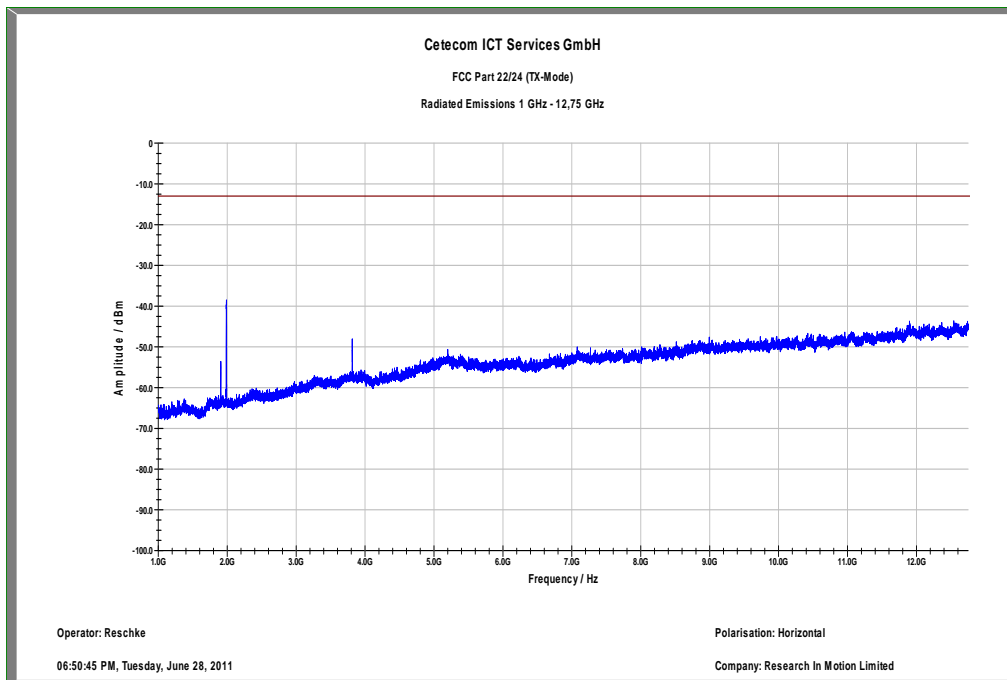

*Carrier notched with 1.9 GHz rejection filter*

## 8.5 Results UMTS band V

All UMTS-band measurements are done in WCDMA mode only.

The connection was established with the following setup: WCDMA CS-RMC, Max Power (All Bit up)

### 8.5.1 RF output power

#### Description:

This paragraph contains average power, peak output power and ERP measurements for the mobile station. In all cases, the peak output power is within the required mask (this mask is specified in the JTC standards, TIA PN3389 Vol. 1 Chap 7, and is no FCC requirement).

#### Measurement:

The mobile was set up for the maximum output power with pseudo random data modulation.

To determine the Peak-To-Average Power Ratio (PAPR) the measurement was performed with the Power Complementary Cumulative Distribution Function (CCDF).

Measurement parameters	
Detector:	RMS (Power in Burst)
Sweep time:	Auto
Video bandwidth:	10 MHz
Resolution bandwidth:	10 MHz
Span:	Zero Span
Trace-Mode:	Max Hold

#### Limits:

FCC	IC
CFR Part 22.9.1.3 CFR Part 2.1046	RSS 132, Issue 2, Section 4.4 and 6.4
Nominal Peak Output Power	
+38.45 dBm	
In measuring transmissions in this band using an average power technique, the peak-to-average ratio (PAR) of the transmission may not exceed 13 dB.	

**Results:**

Output Power (radiated) WCDMA mode - CS	
Frequency (MHz)	Peak Output Power (dBm) - ERP
826.4	22.90
836.0	24.60
846.6	25.70
Measurement uncertainty	± 2.0 dB

**Result:** The result of the measurement is passed.

## 8.5.2 Spurious emissions radiated

### Description:

The following steps outline the procedure used to measure the radiated emissions from the mobile station. The site is constructed in accordance with ANSI C63.4:2009 requirements and is recognized by the FCC to be in compliance for a 3 and a 10 meter site. The spectrum was scanned from 30 MHz to the 10th harmonic of the highest frequency generated within the equipment, which is the transmitted carrier that can be as high as 846.6 MHz. This was rounded up to 12 GHz. The resolution bandwidth is set as outlined in Part 22.917. The spectrum was scanned with the mobile station transmitting at carrier frequencies that pertain to low, mid and high channels of the UMTS band V.

The final open field emission (here 10m semi-anechoic chamber listed by FCC) test procedure is as follows:

- a) The test item was placed on a 0.8 meter high non-conductive stand at a 3 meter test distance from the receive antenna.
- b) The antenna output was terminated in a 50 ohm load (if possible).
- c) A double ridged wave guide antenna was placed on an adjustable height antenna mast 3 meters from the test item for emission measurements.
- d) Detected emissions were maximized at each frequency by rotating the test item and adjusting the receive antenna height and polarization. The maximum meter reading was recorded. The radiated emission measurements of the harmonics of the transmit frequency through the 10th harmonic were measured with peak detector and 1 MHz bandwidth. If the harmonic could not be detected above the noise floor, the ambient level was recorded. The equivalent power into a dipole antenna was calculated from the field intensity levels measured at 3 meters.
- e) Now each detected emissions were substituted by the substitution method, in accordance with the TIA/EIA 603 .

### Measurement:

Measurement parameters	
Detector:	Peak
Sweep time:	2 sec.
Video bandwidth:	Below 1 GHz: 120 kHz Above 1 GHz: 1 MHz
Resolution bandwidth:	Below 1 GHz: 120 kHz Above 1 GHz: 1 MHz
Span:	100 MHz Steps
Trace-Mode:	Max Hold

### Limits:

FCC	IC
CFR Part 22.917 CFR Part 2.1053	RSS 132, Issue 2, Section 4.5 and 6.5
Spurious Emissions Radiated	
Attenuation $\geq 43 + 10\log(P)$ (P, Power in Watts)	
-13 dBm	

**Results:**

Radiated emissions measurements were made only at the upper, center, and lower carrier frequencies of the UMTS band V (826.4 MHz, 836.0 MHz and 846.6 MHz). It was decided that measurements at these three carrier frequencies would be sufficient to demonstrate compliance with emissions limits because it was seen that all the significant spurs occur well outside the band and no radiation was seen from a carrier in one block of the UMTS band V into any of the other blocks. The equipment must still, however, meet emissions requirements with the carrier at all frequencies over which it is capable of operating and it is the manufacturer's responsibility to verify this.

The final open field radiated levels are presented on the next pages. All measurements were done in horizontal and vertical polarization; the plots show the worst case. The plots show only the middle channel. If spurious were detected, the lowest and highest channel were checked too. The found values are stated in the table below.

As can be seen from this data, the emissions from the test item were within the specification limit.

Spurious Emission Level (dBm)								
Harmonic	Ch. 4132 Freq. (MHz)	Level [dBm]	Harmonic	Ch. 4180 Freq. (MHz)	Level [dBm]	Harmonic	Ch. 4233 Freq. (MHz)	Level [dBm]
2	1652.8	-	2	1672.0	-	2	1693.2	-
3	2479.2	-	3	2508.0	-	3	2539.8	-
4	3305.6	-	4	3344.0	-	4	3386.4	-
5	4132.0	-	5	4180.0	-	5	4233.0	-
6	4958.4	-	6	5016.0	-	6	5079.6	-
7	5784.8	-	7	5852.0	-	7	5926.2	-
8	6611.2	-	8	6688.0	-	8	6772.8	-
9	7437.6	-	9	7524.0	-	9	7619.4	-
10	8264.0	-	10	8360.0	-	10	8466.0	-
Measurement uncertainty					± 3dB			

**Result:** The result of the measurement is passed.

**CS**

**Plot 1: Channel 4132 (Traffic mode up to 30 MHz)**

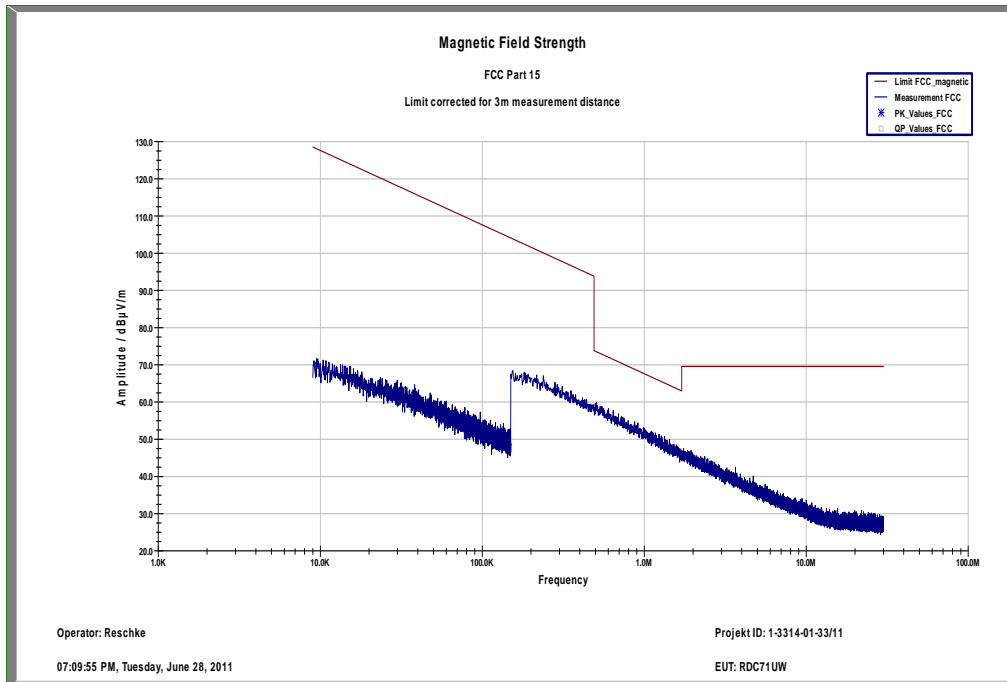

**Plot 2: Channel 4132 (30 MHz - 1 GHz) – vertical**

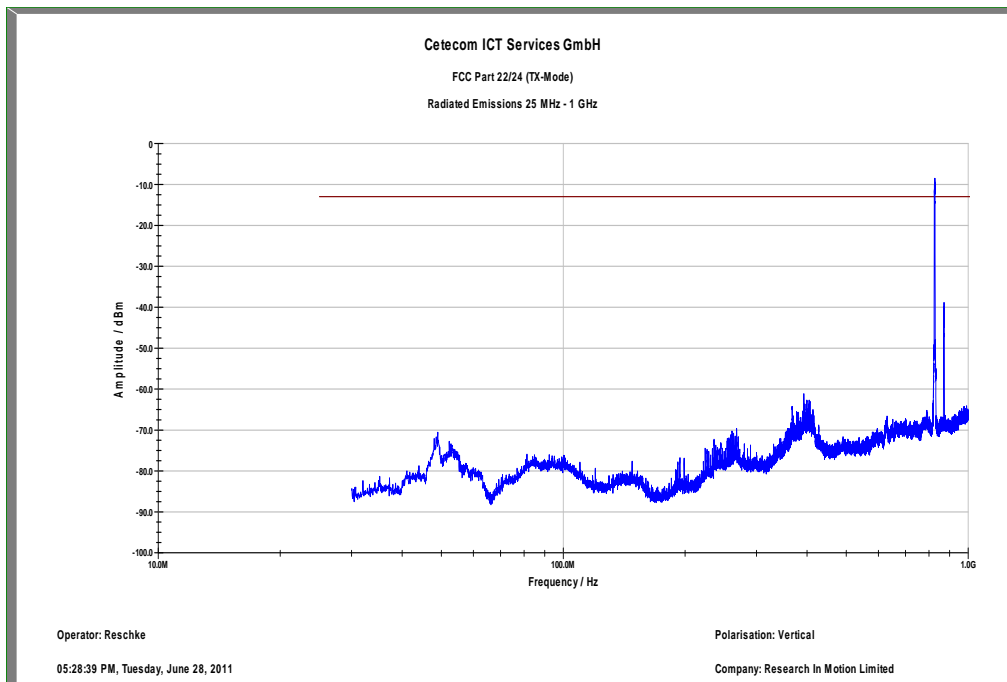

Plot 3: Channel 4132 (1 GHz – 12.75 GHz) – vertical

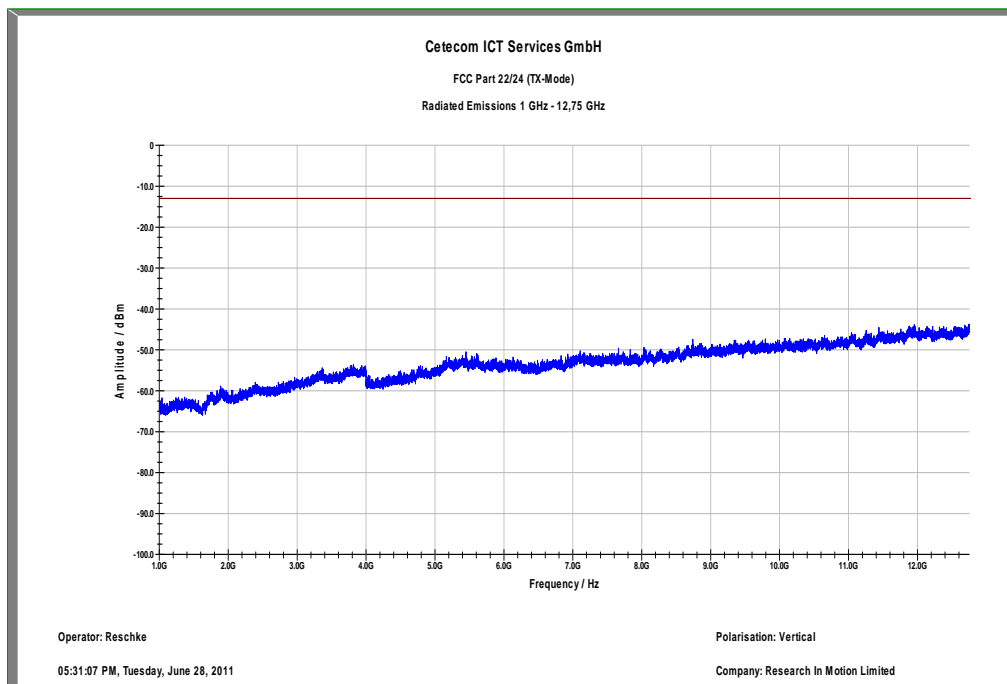

Plot 4: Channel 4132 (30 MHz - 1 GHz) – horizontal

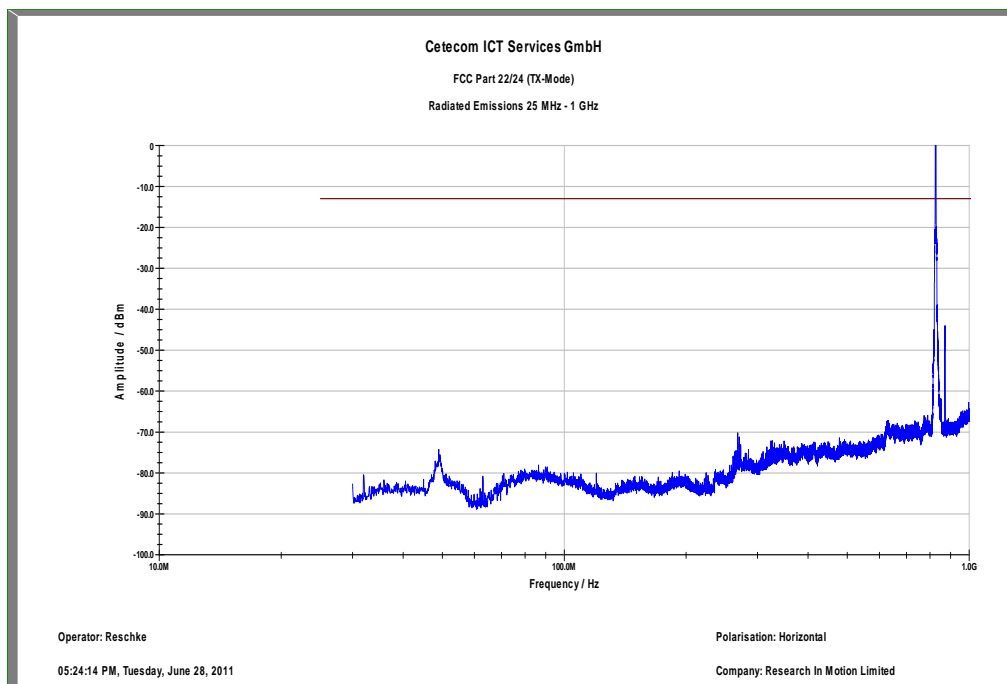

Plot 5: Channel 4132 (1 GHz – 12.75 GHz) – horizontal

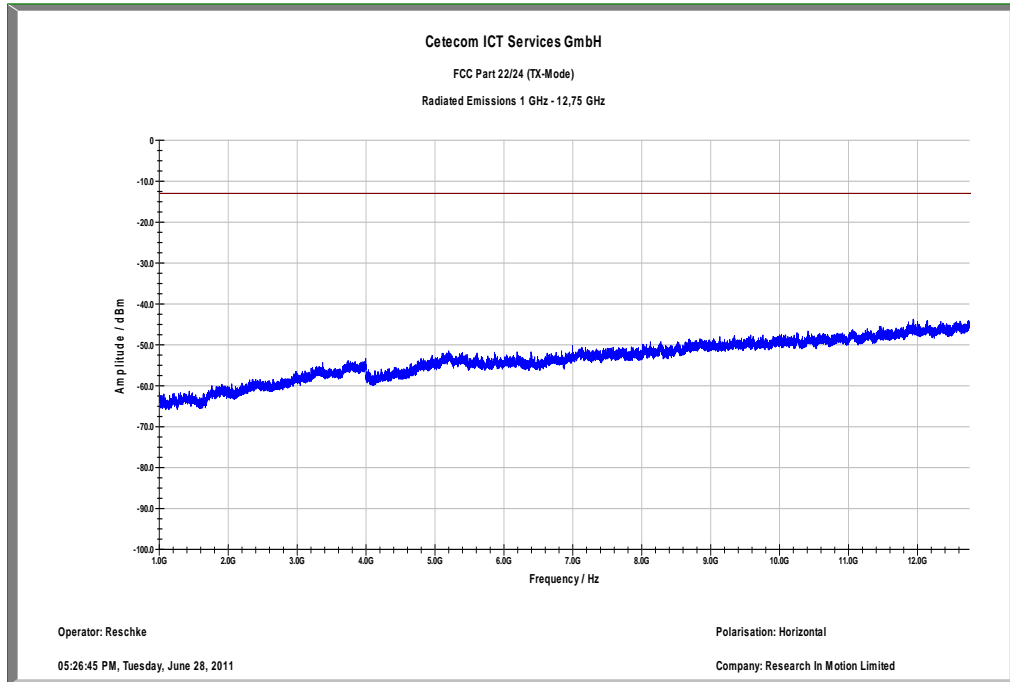



Plot 6: Channel 4180 (Traffic mode up to 30 MHz)

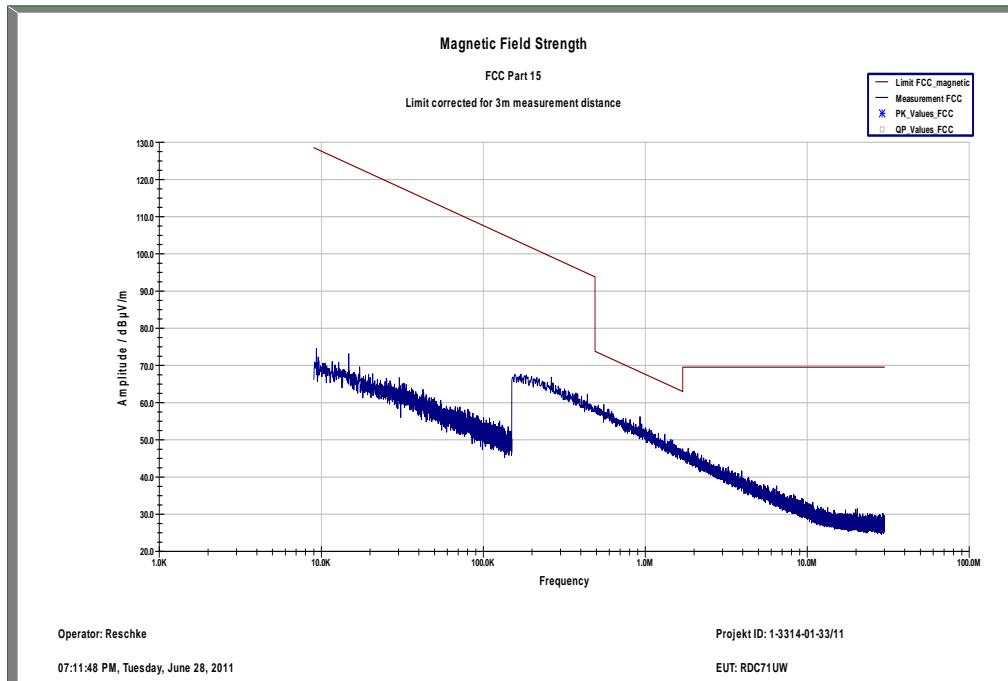

Plot 7: Channel 4180 (30 MHz - 1 GHz) – vertical

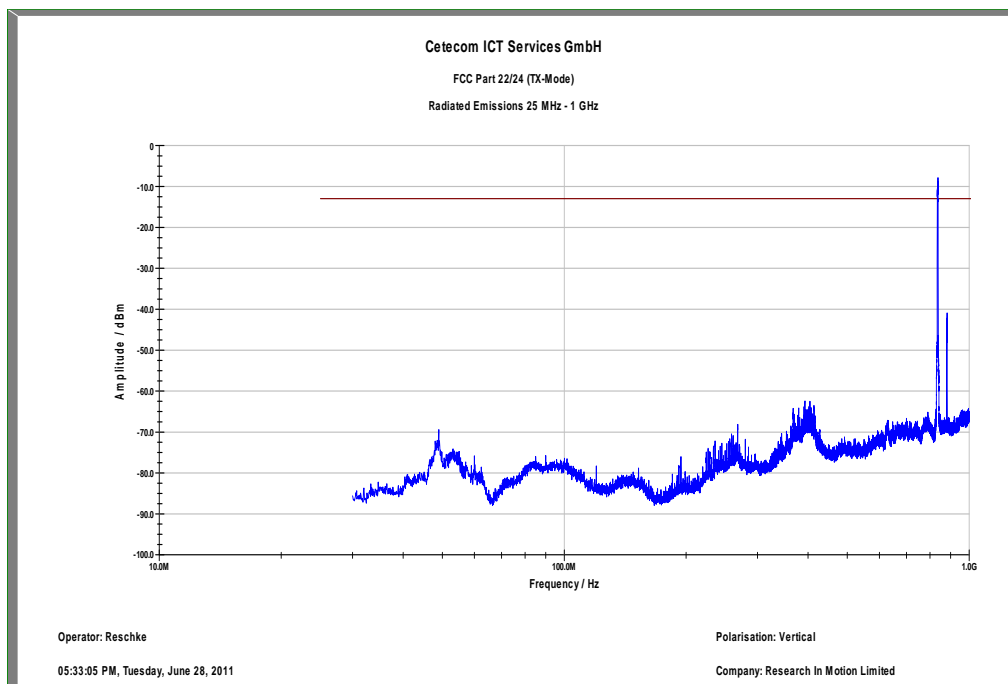

Plot 8: Channel 4180 (1 GHz – 12.75 GHz) – vertical

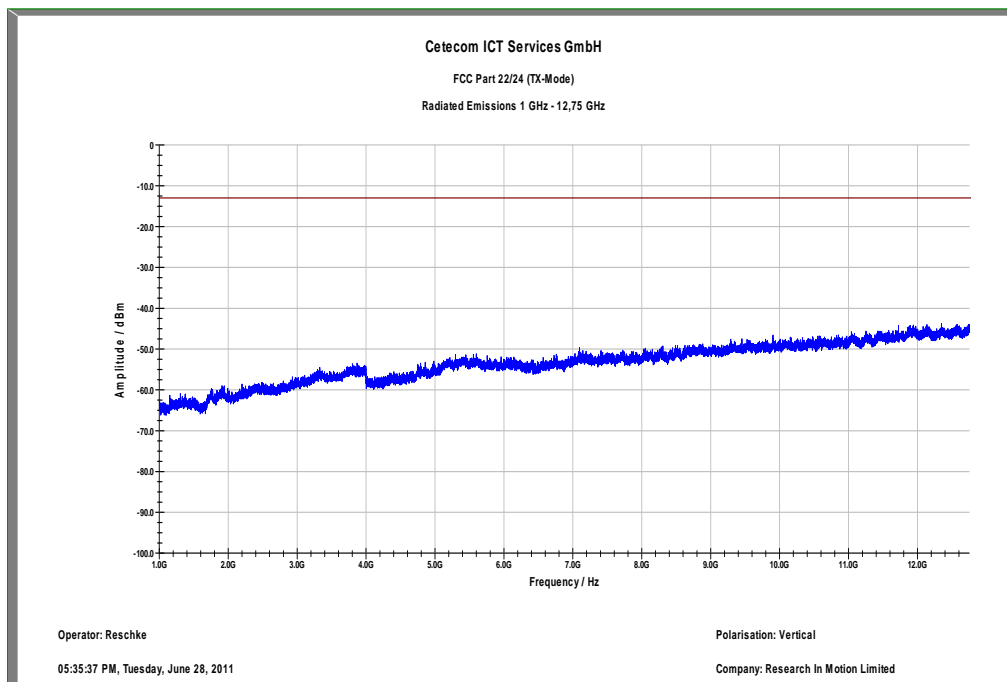

Plot 9: Channel 4180 (30 MHz - 1 GHz) – horizontal

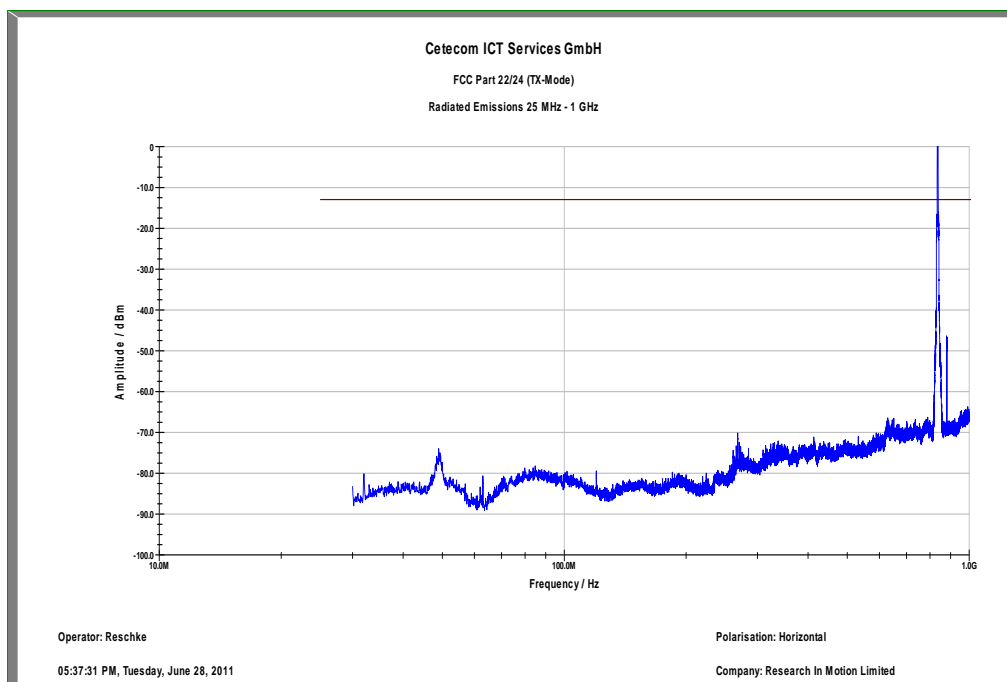

Plot 10: Channel 4180 (1 GHz – 12.75 GHz) – horizontal

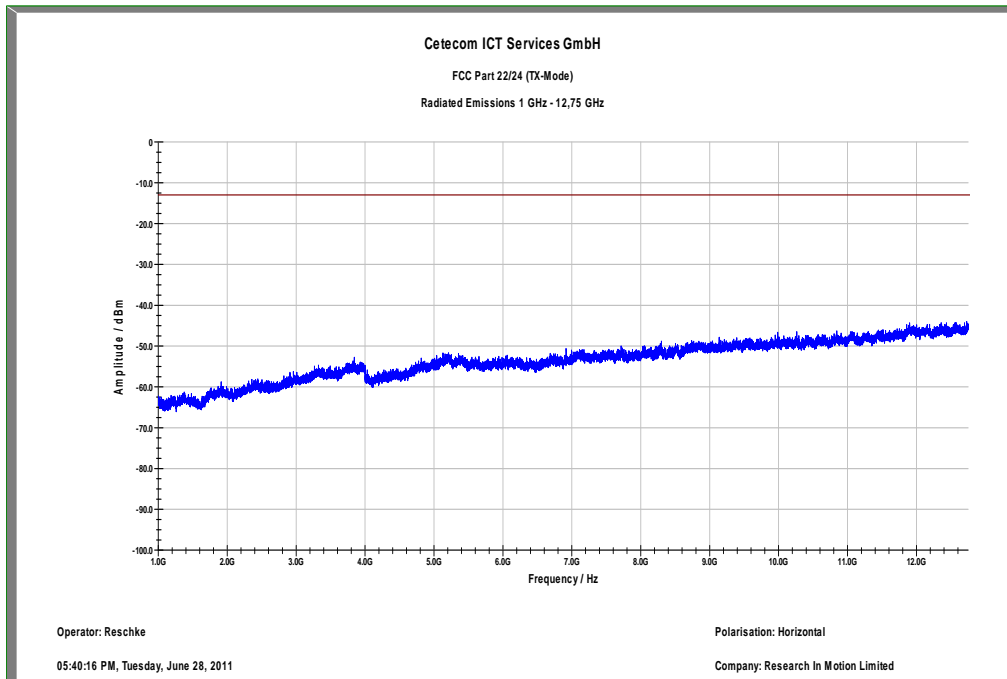

Plot 11: Channel 4233 (Traffic mode up to 30 MHz)

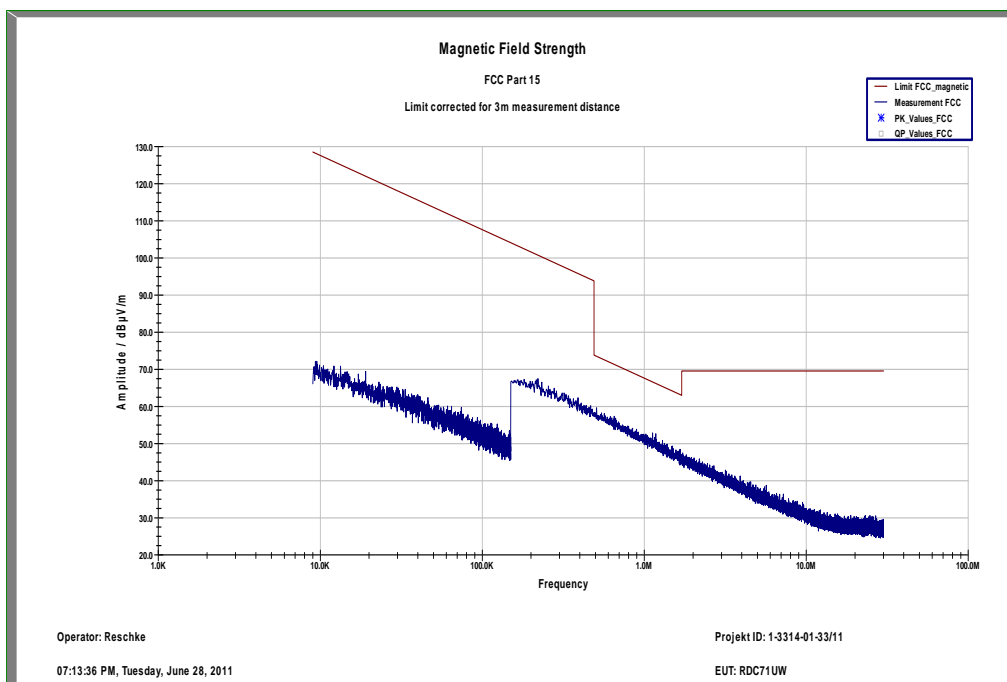

Plot 12: Channel 4233 (30 MHz - 1 GHz) – vertical

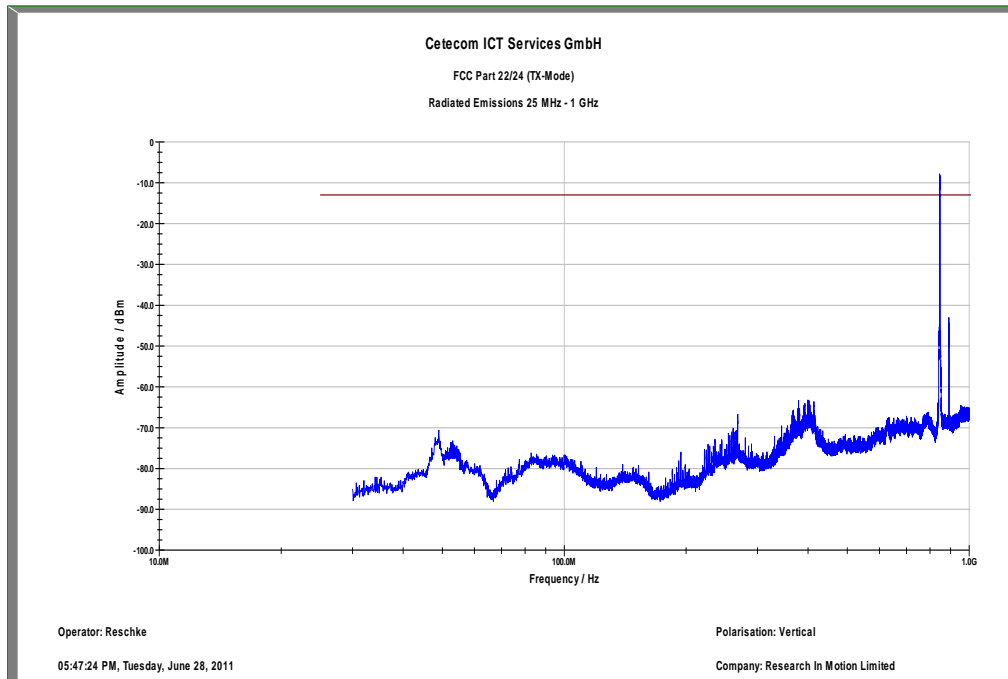

Plot 13: Channel 4233 (1 GHz – 12.75 GHz) – vertical

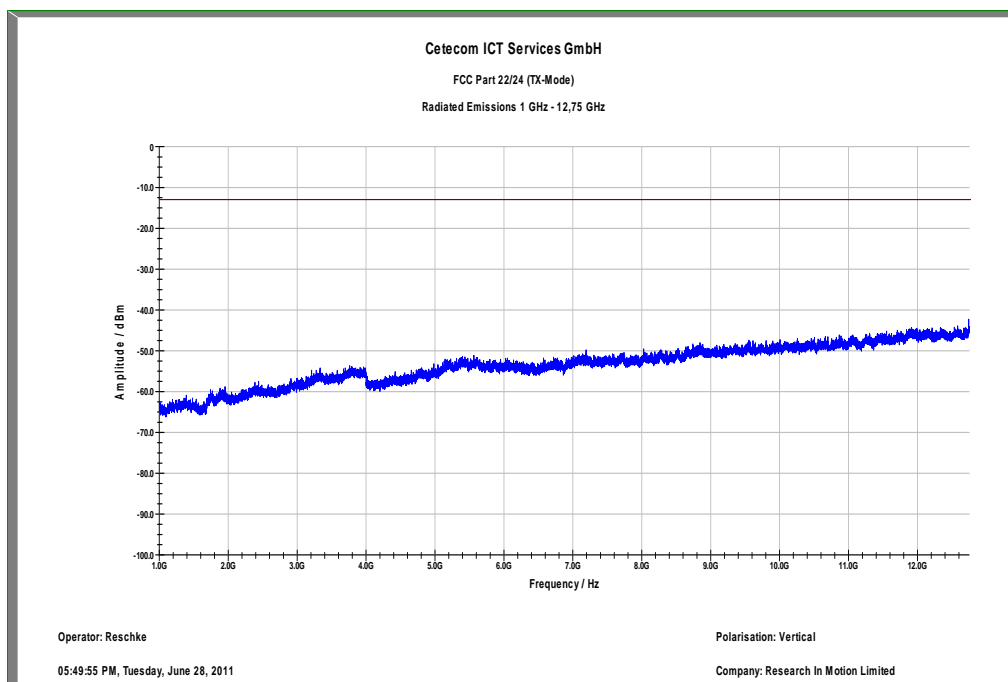

Plot 14: Channel 4233 (30 MHz - 1 GHz) – horizontal

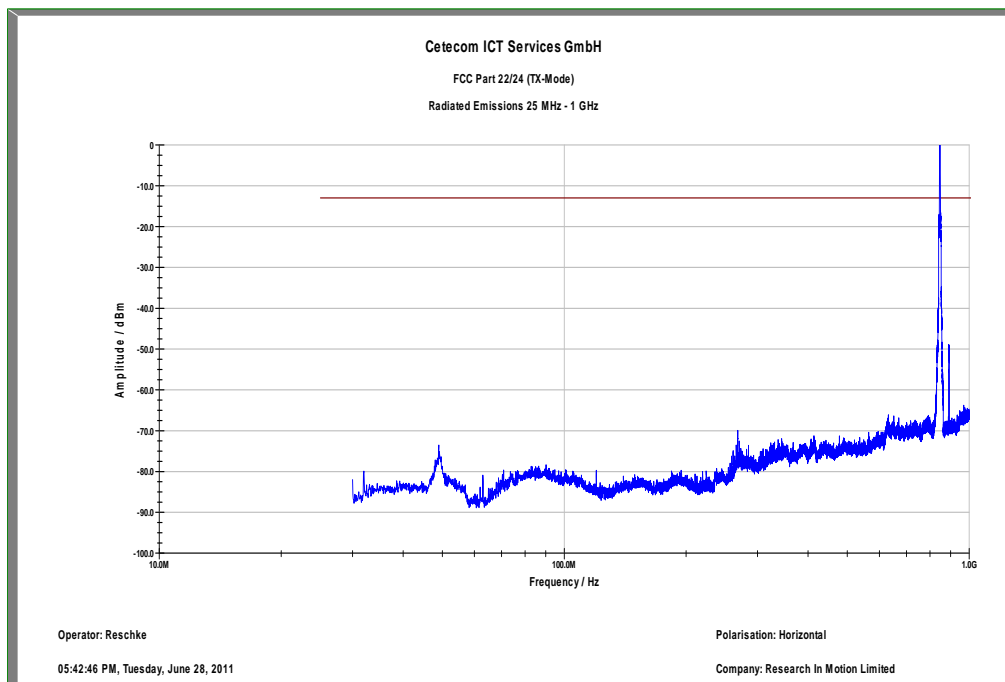

Plot 15: Channel 4233 (1 GHz – 12.75 GHz) – horizontal

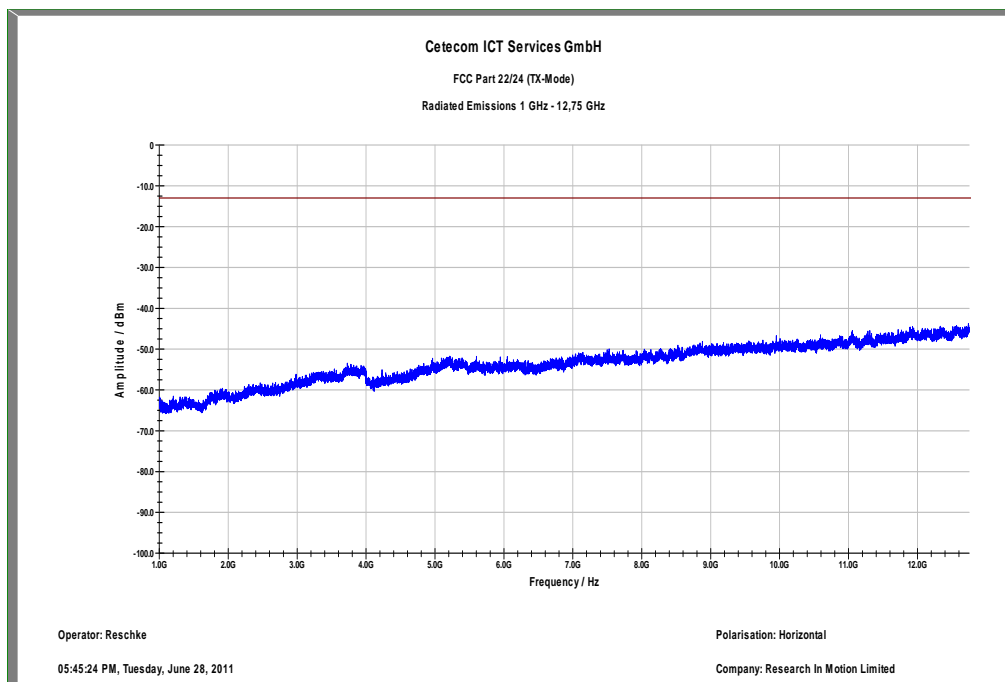

**HSUPA**

**Plot 1: Channel 4132 (Traffic mode up to 30 MHz)**

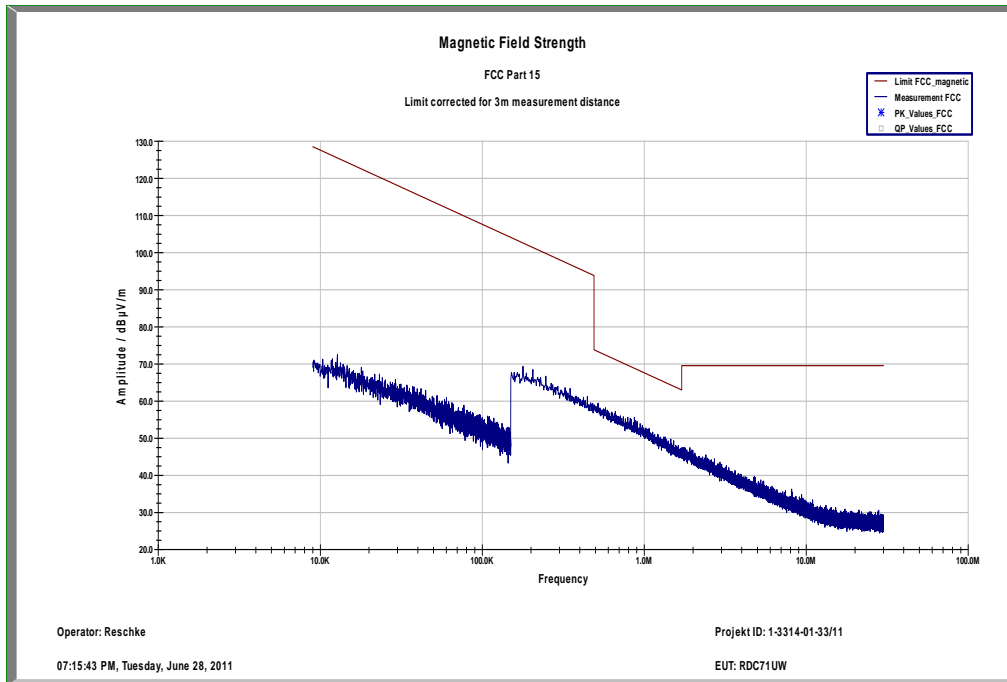

**Plot 2: Channel 4132 (30 MHz - 1 GHz) – vertical**

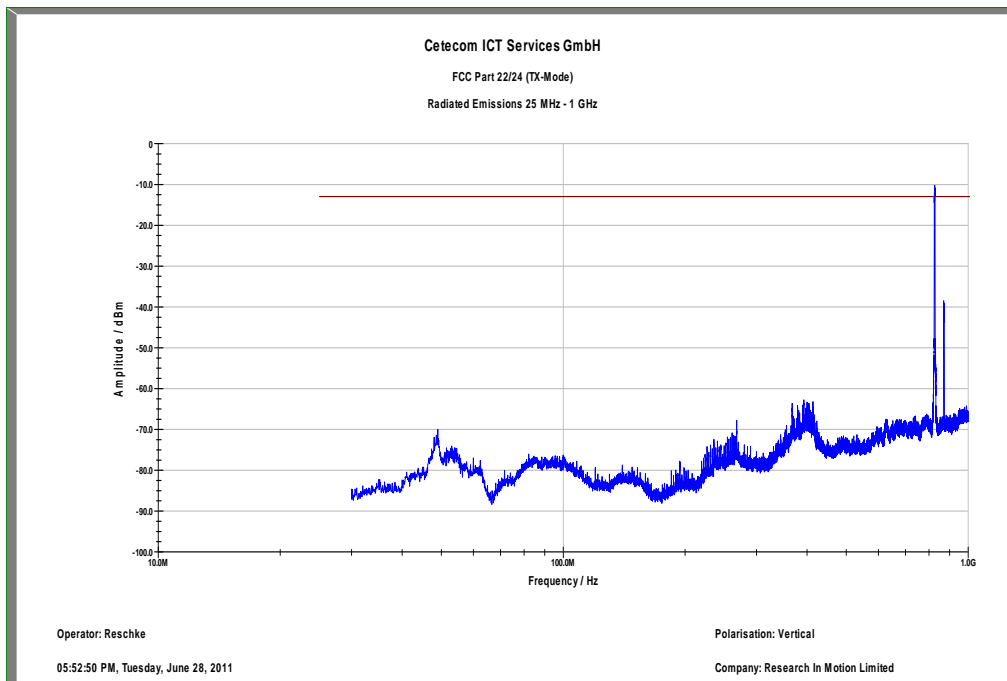

Plot 3: Channel 4132 (1 GHz – 12.75 GHz) – vertical

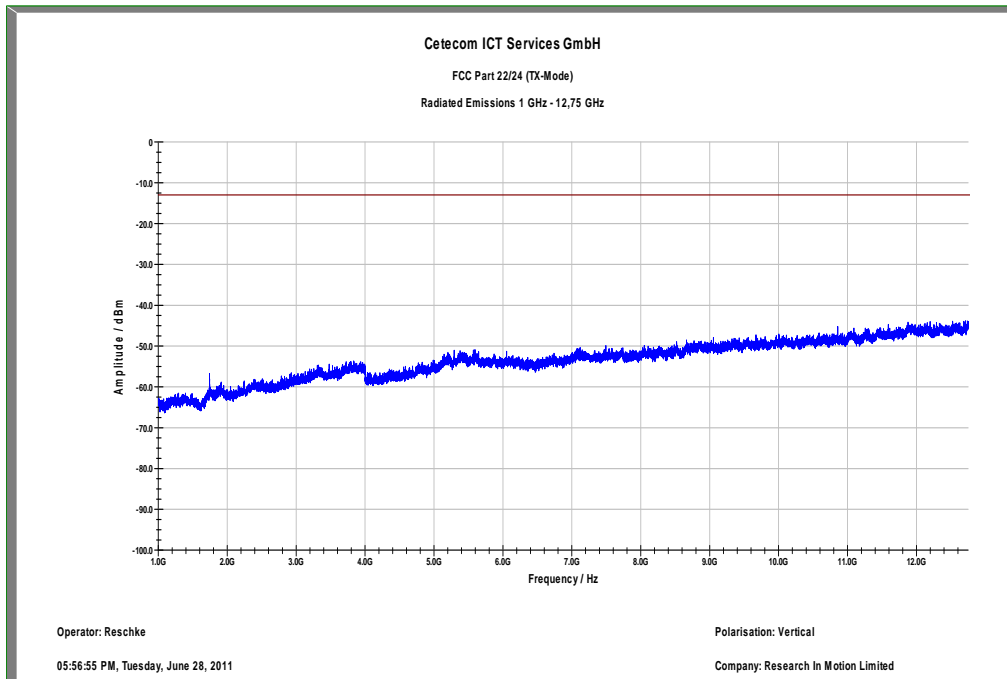

Plot 4: Channel 4132 (30 MHz - 1 GHz) – horizontal

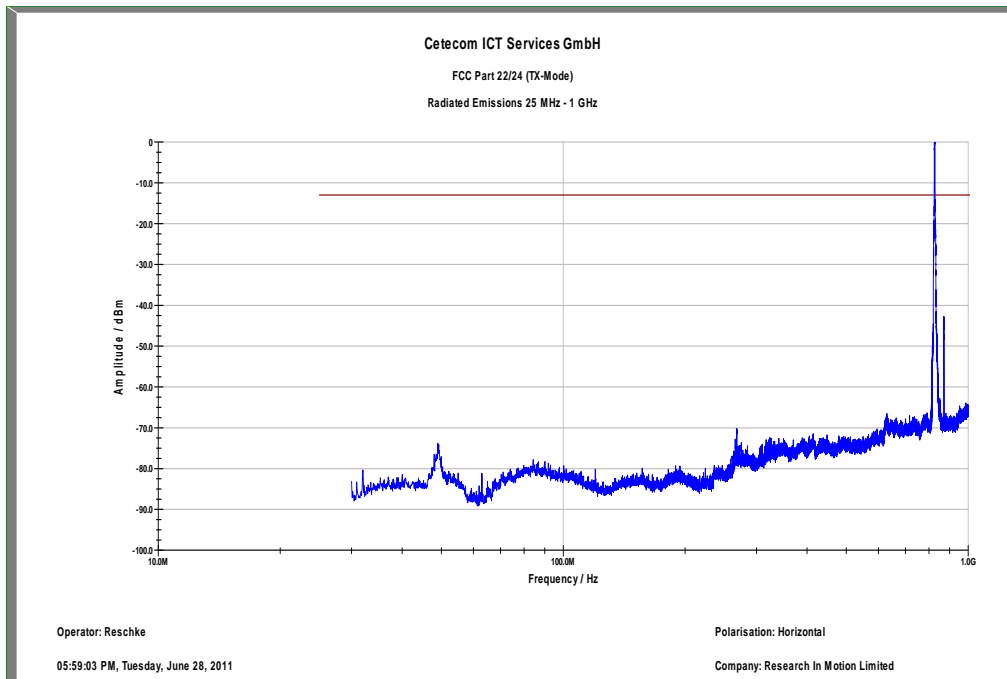

Plot 5: Channel 4132 (1 GHz – 12.75 GHz) – horizontal

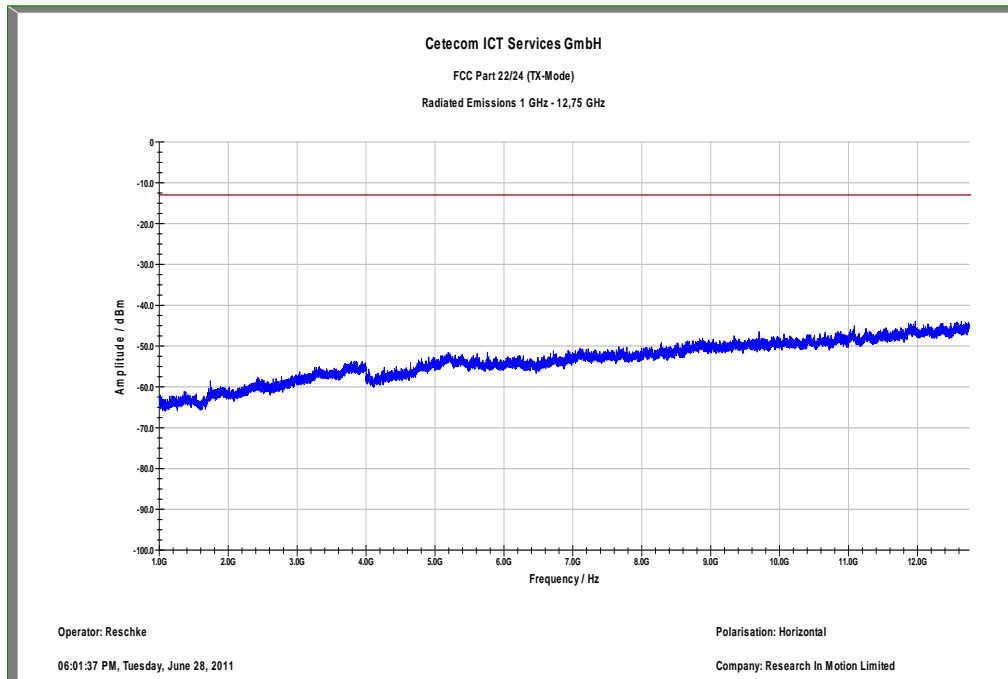

Plot 6: Channel 4180 (Traffic mode up to 30 MHz)

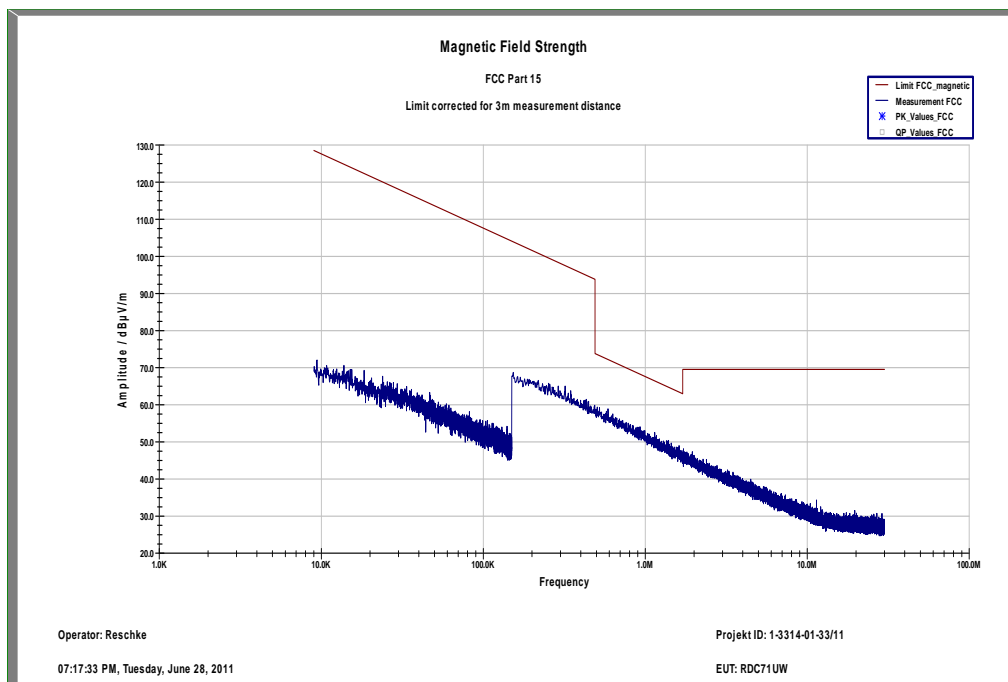



Plot 7: Channel 4180 (30 MHz - 1 GHz) – vertical

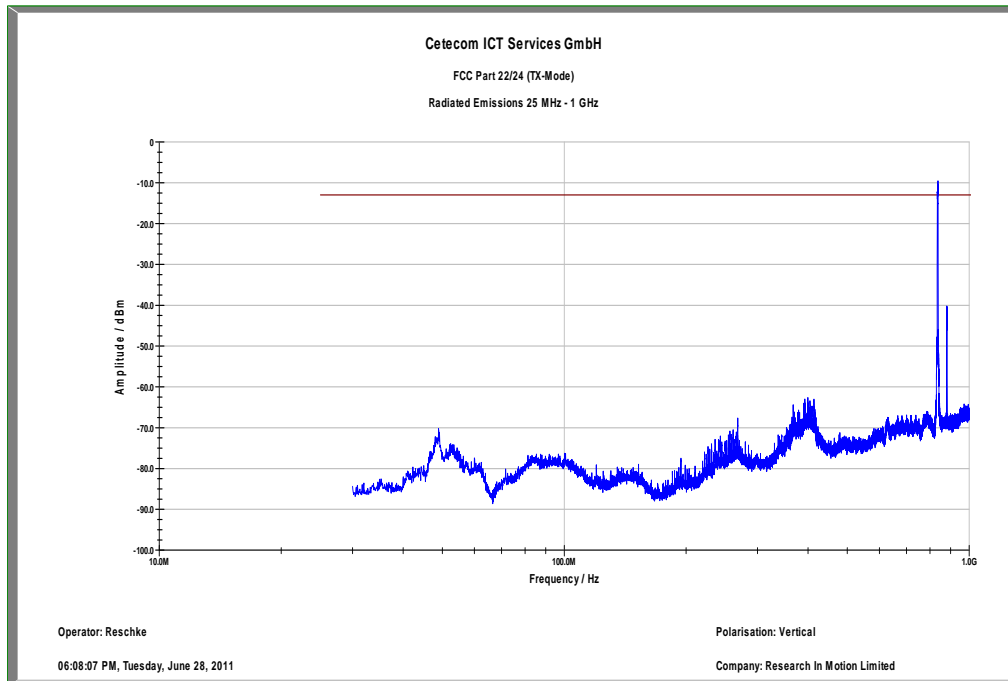

Plot 8: Channel 4180 (1 GHz – 12.75 GHz) – vertical

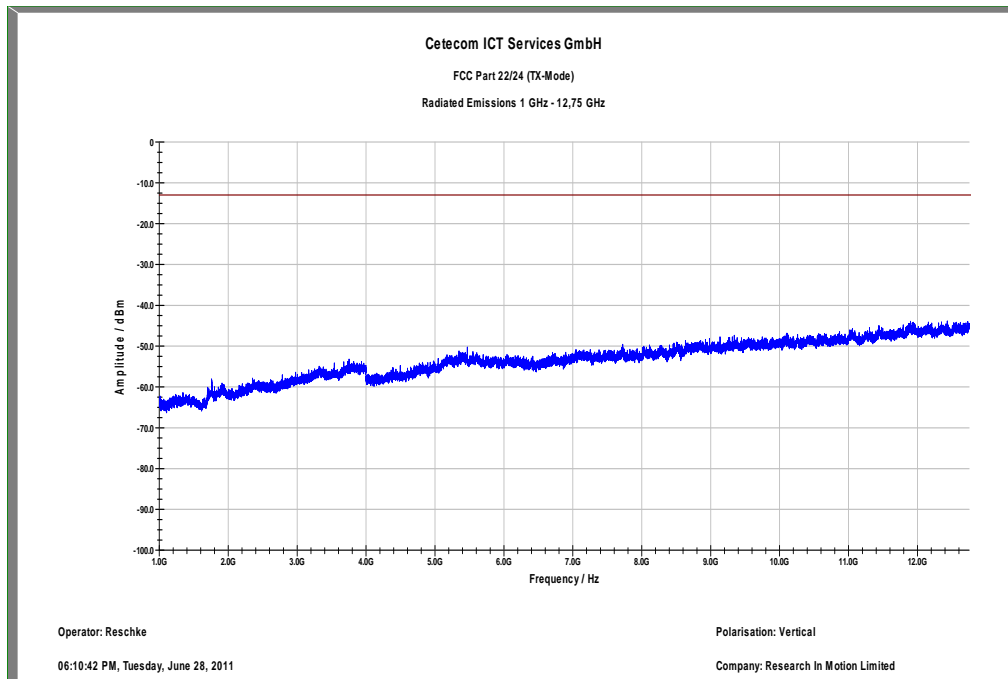

Plot 9: Channel 4180 (30 MHz - 1 GHz) – horizontal

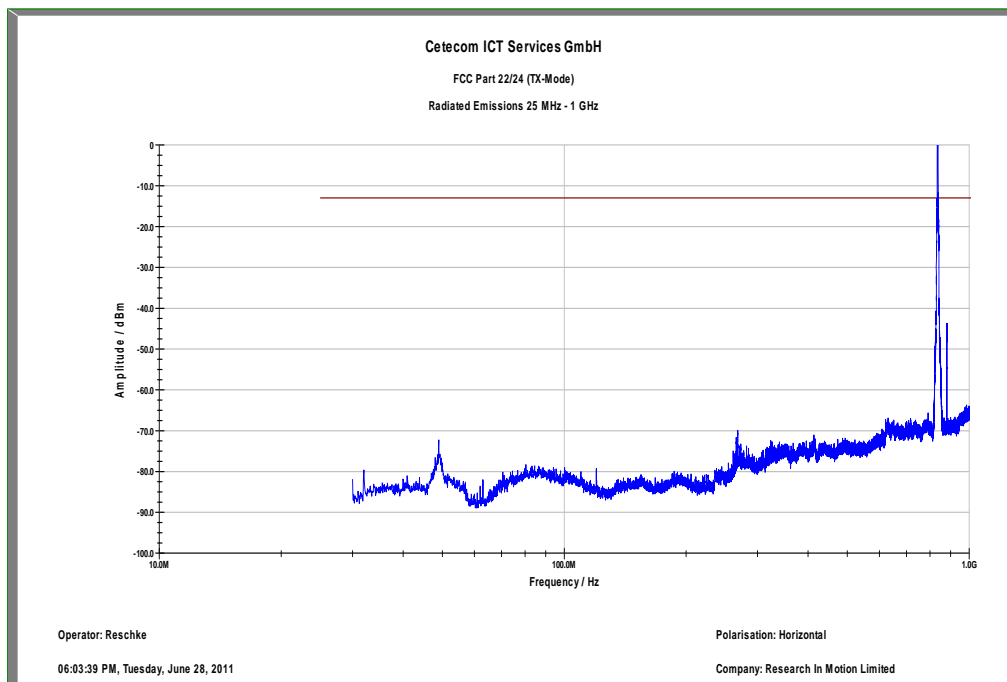

Plot 10: Channel 4180 (1 GHz – 12.75 GHz) – horizontal

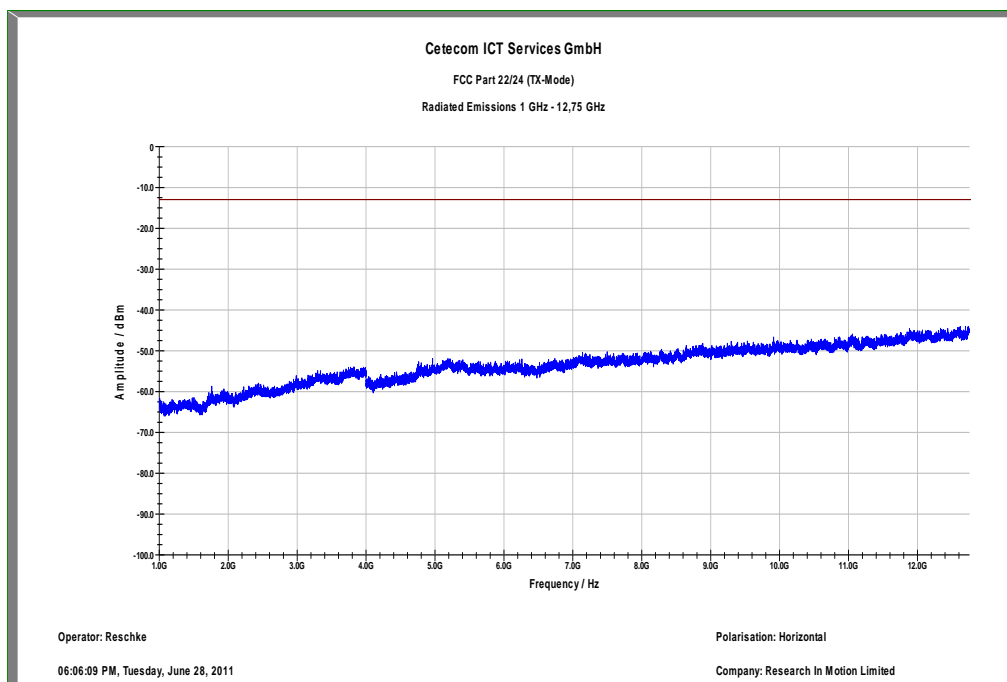

Plot 11: Channel 4233 (Traffic mode up to 30 MHz)

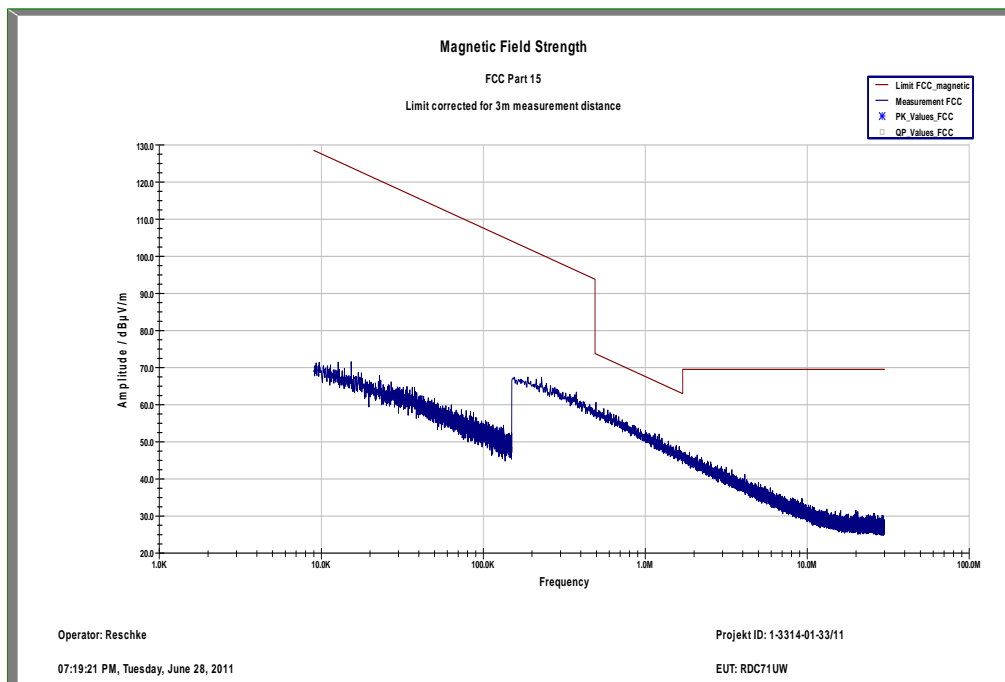

Plot 12: Channel 4233 (30 MHz - 1 GHz) – vertical

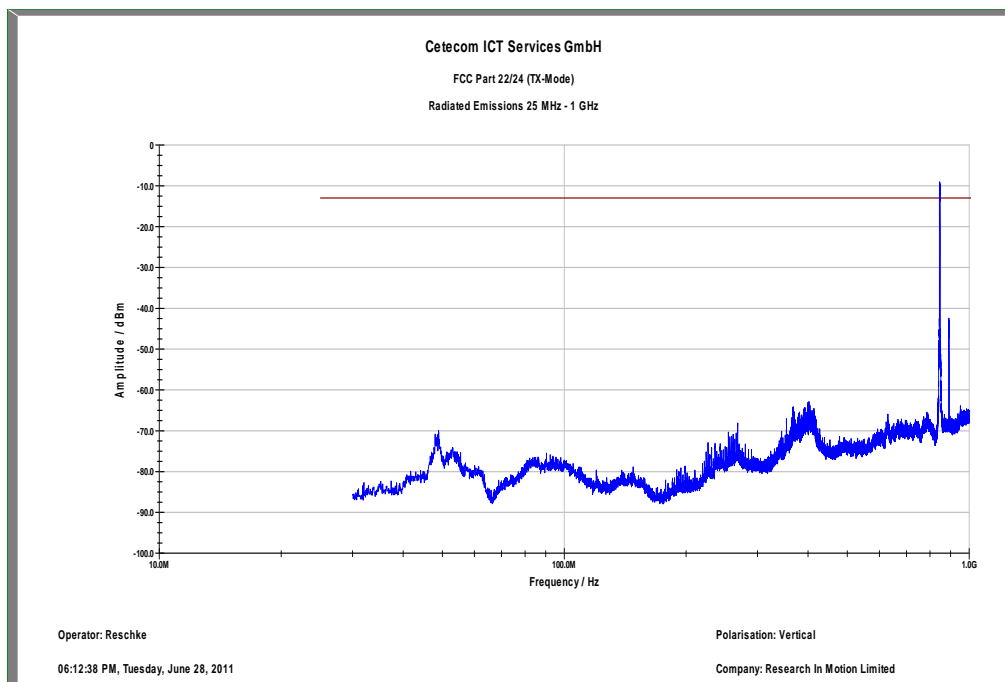

Plot 13: Channel 4233 (1 GHz – 12.75 GHz) – vertical

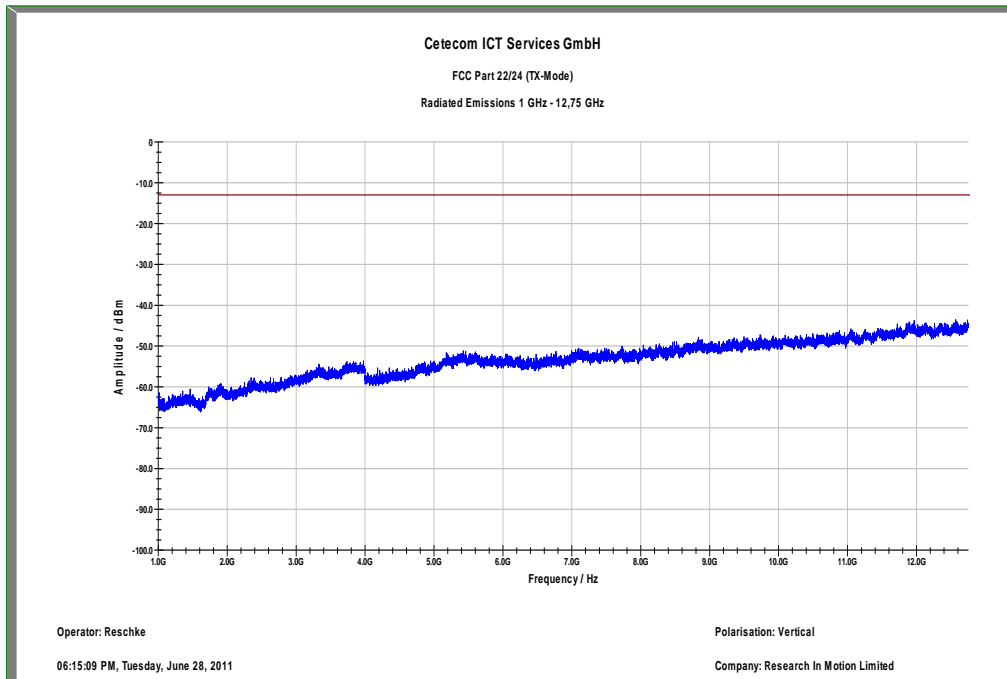

Plot 14: Channel 4233 (30 MHz - 1 GHz) – horizontal

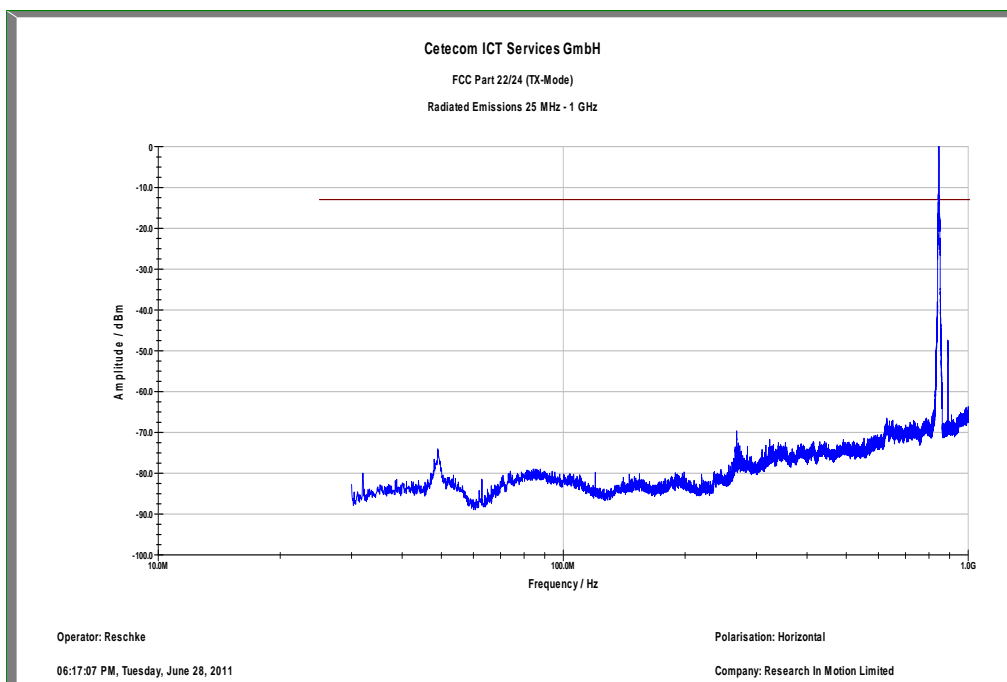

Plot 15: Channel 4233 (1 GHz – 12.75 GHz) – horizontal

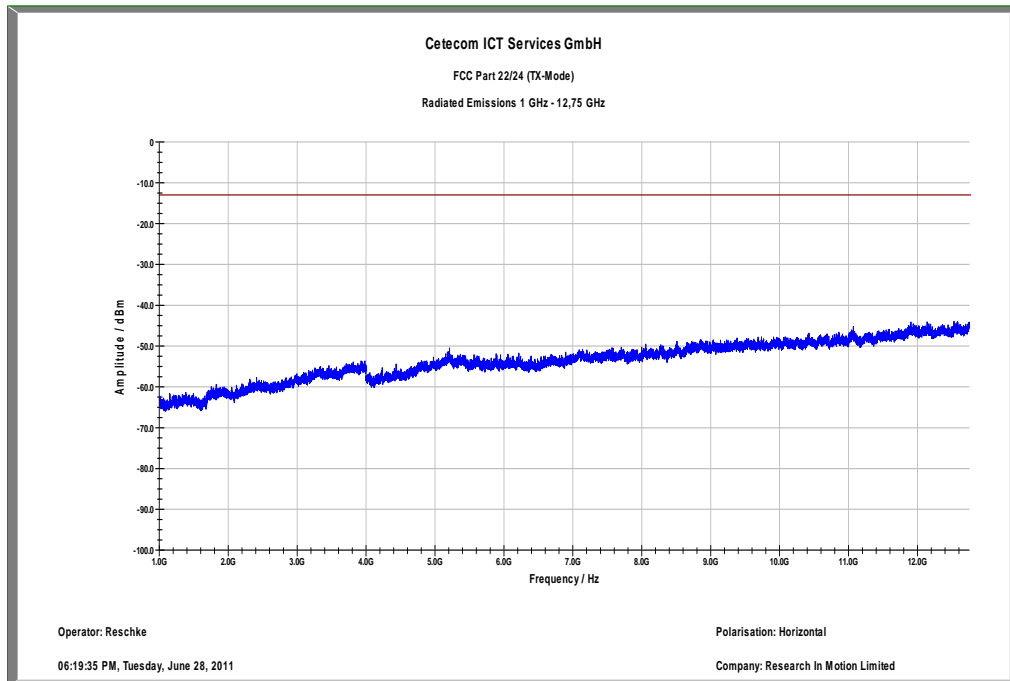

## 9 Test equipment and ancillaries used for tests

Typically, the calibrations of the test apparatus are commissioned to and performed by an accredited calibration laboratory. The calibration intervals are determined in accordance with the DIN EN ISO/IEC 17025. In addition to the external calibrations, the laboratory executes comparison measurements with other calibrated test systems or effective verifications. Weekly chamber inspections and range calibrations are performed. Where possible, rf-generating and signalling equipment as well as measuring receivers and analyzers are connected to an external high-precision 10 MHz reference (GPS-based or rubidium frequency standard).

In order to simplify the identification of the equipment used at some special tests, some items of test equipment and ancillaries can be provided with an identifier or number in the equipment list below (Labor/Item).

No.	Lab / Item	Equipment	Type	Manufact.	Serial No.	INV. No Cetecom	Kind of Calibration	Last Calibration	Next Calibration
1	n. a.	Isolating Transformer	RT5A	Grundig	8041	300001626	g		
2	n. a.	DC power supply, 60Vdc, 50A, 1200 W	6032A	HP Meßtechnik	2818A03450	300001040	Ve	08.01.2009	08.01.2012
3	n. a.	Coaxial Attenuator 30dB/500W	8325	Bird	1530	300001595	ev		
4	n. a.	Double-Ridged Waveguide Horn Antenna 1-18.0GHz	3115	EMCO	8812-3088	300001032	viKI!	05.03.2009	05.09.2011
5	n. a.	Active Loop Antenna	6502	EMCO	2210	300001015	ne		
6	n. a.	Anechoic chamber	FAC 3/5m	MWB / TDK	87400/02	300000996		23.03.2009	
7	Spec.A. 2_2e	System rack for EMI measurement solution	85900	HP I.V.	*	300000222	ne		
8	9	Artificial Mains 9 kHz to 30 MHz	ESH3-Z5	R&S	828576/020	300001210	Ve	06.01.2010	06.01.2012
9	n. a.	Relais Matrix	3488A	HP Meßtechnik	2719A15013	300001156	ne		
10	n. a.	Relais Matrix	PSU	R&S	890167/024	300001168	ne		
11	n. a.	Isolating Transformer	RT5A	Grundig	9242	300001263	ne		
12	n. a.	Three-Way Power Splitter, 50 Ohm	11850C	HP Meßtechnik		300000997	ne		
13	n. a.	Switch / Control Unit	3488A	HP	2605e08770	300001443	ne		
14	n. a.	Amplifier	js42-00502650-28-5a	Parzich GMBH	928979	300003143	ne		
15	n. a.	Band Reject filter	WRCG1855/1910-1835/1925-40/8SS	Wainwright	7	300003350	ev		
16	n. a.	Band Reject filter	WRCG2400/2483-2375/2505-50/10SS	Wainwright	11	300003351	ev		
17	n. a.	TILE-Software Emission	Quantum Change, Modell TILE-ICS/FULL	EMCO	none	300003451	ne		
18	n. a.	Highpass Filter	WHKX2.9/18G-12SS	Wainwright	1	300003492	ev		
19	n. a.	Highpass Filter	WHK1.1/15G-10SS	Wainwright	3	300003255	ev		
20	n. a.	Highpass Filter	WHKX7.0/18G-8SS	Wainwright	18	300003789	ne		
21	n. a.	PSA Spectrum Analyzer 3 Hz - 26.5 GHz	E4440A	Agilent Technologies	MY48250080	300003812	k	08.09.2010	08.09.2012
22	n. a.	MXG Microwave Analog Signal Generator	N5183A	Agilent Technologies	MY47420220	300003813	k	13.09.2010	13.09.2012
23	n. a.	RF Filter Section 9kHz - 1GHz	N9039A	Agilent Technologies	MY48260003	300003825	viKI!	08.09.2010	08.09.2012
24	n. a.	TRILOG Broadband Test-Antenna 30 MHz - 3	VULB9163	Schwarzbeck	371	300003854	viKI!	17.12.2008	17.12.2011

		GHz							
25	n. a.	Signal Analyzer 20Hz-26,5GHz- 150 to + 30 DBM	FSIQ26	R&S	835111/0004	300002678	Ve	04.11.2010	04.11.2012
26	11b	Microwave System Amplifier, 0.5- 26.5 GHz; 25 dB gain	83017A	HP Meßtechnik	00419	300002268	ev	10.03.2011	
27	A026	Std. Gain Horn Antenna 12.4 to 18.0 GHz	639	Narda		300000787	ne		
28	A029	Std. Gain Horn Antenna 18.0 to 26.5 GHz	638	Narda		300002442	ne		
29	n. a.	Universal Communication Tester	CMU200	R&S	832221/055	300002862	k	20.03.2008	
30	n. a.	Universal Communication Tester	CMU200	R&S	103992	300003231	vkI!	30.06.2010	30.06.2012
31	n. a.	Universal Communication Tester	CMU200	R&S	106240	300003321	vkI!	14.09.2010	14.09.2012

**Agenda:** Kind of Calibration

k calibration / calibrated  
 ne not required (k, ev, izw, zw not required)  
 ev periodic self verification  
 Ve long-term stability recognized  
 vkI! Attention: extended calibration interval  
 NK! Attention: not calibrated

EK limited calibration  
 zw cyclical maintenance (external cyclical maintenance)  
 izw internal cyclical maintenance  
 g blocked for accredited testing  
 \*) next calibration ordered / currently in progress

**Annex A Document history**

Version	Applied changes	Date of release
1.0	Initial release	2011-06-30
-A	Average output power values changed to peak power values	2011-07-19

**Annex B Further information****Glossary**

DUT	-	Device under Test
EMC	-	Electromagnetic Compatibility
EUT	-	Equipment under Test
FCC	-	Federal Communication Commission
FCC ID	-	Company Identifier at FCC
HW	-	Hardware
IC	-	Industry Canada
Inv. No.	-	Inventory number
N/A	-	not applicable
S/N	-	Serial Number
SW	-	Software