

EMI Test Report

Tested in accordance with
Federal Communications Commission (FCC)
Personal Communications Services
CFR 47 Parts 2, 22, 24 and 27
&
Industry Canada (IC) RSS- Gen, 132, 133 and 139



A division of Research In Motion Limited

REPORT NO: RTS-2579-1107-62A

PRODUCT MODEL NO:	RDD71UW, RDC71UW
TYPE NAME:	BlackBerry® smartphone
FCC ID:	L6ARDD70UW, L6ARDC70UW
IC:	2503A-RDD70UW, 2503A-RDC70UW
EMISSION DESIGNATOR (GSM):	248KGXW
EMISSION DESIGNATOR (EDGE):	245KG7W
EMISSION DESIGNATOR (WCDMA):	4M22F9W

DATE: July 12, 2011

		EMI Test Report for the BlackBerry® smartphone Model RDD71UW, RDC71UW
Test Report No. RTS-2579-1107-62A	Dates of Test June 14 to July 11, 2011	FCC ID: L6ARDD70UW, L6ARDC70UW IC: 2503A-RDD70UW, 2503A-RDC70UW

Statement of Performance:

The BlackBerry® smartphone, model RDD71UW, part number CER-39234-001 Rev4 and accessories performs within the requirements of the test standards when configured and operated per RIM's instructions.

The BlackBerry® smartphone, model RDC71UW, part number CER-30954-001 Rev2 and accessories performs within the requirements of the test standards when configured and operated per RIM's instructions.

Declaration:

We hereby certify that:

The test data reported herein is an accurate record of the performance of the sample(s) tested. The test results are valid for the tested unit (s) only. The test equipment used was suitable for the tests performed and within manufacturer's published specifications and operating parameters. The test methods were consistent with the methods described in the relevant standards.

Documented by:



Nielven Jay Olis
Regulatory Compliance Associate
Date: 14 July 2011

Reviewed by:



Savtej S. Sandhu
Regulatory Compliance Specialist
Date: 18 July 2011

Reviewed and Approved by:



Masud S. Attayi, P.Eng.
Manager, Regulatory Compliance
Date: 19 July 2011



		EMI Test Report for the BlackBerry® smartphone Model RDD71UW, RDC71UW
Test Report No. RTS-2579-1107-62A	Dates of Test June 14 to July 11, 2011	FCC ID: L6ARDD70UW, L6ARDC70UW IC: 2503A-RDD70UW, 2503A-RDC70UW

Table of Contents

A)	Scope	5
B)	Associated Documents	5
C)	Product Identification	6
D)	Support Equipment Used for the Testing of the EUT	7
E)	Test Voltage	7
F)	Test Results Chart.....	8
G)	Summary of Results	10
H)	Compliance Test Equipment Used	14
APPENDIX 1A – GSM CONDUCTED RF EMISSIONS TEST DATA/PLOTS.....		16
APPENDIX 1B – UMTS 4 CONDUCTED RF EMISSIONS TEST DATA/PLOTS.....		33
APPENDIX 2A – GSM CONDUCTED RF OUTPUT POWER TEST DATA.....		43
APPENDIX 2B – UMTS 4 CONDUCTED RF OUTPUT POWER TEST DATA.....		45

		EMI Test Report for the BlackBerry® smartphone Model RDD71UW, RDC71UW
Test Report No. RTS-2579-1107-62A	Dates of Test June 14 to July 11, 2011	FCC ID: L6ARDD70UW, L6ARDC70UW IC: 2503A-RDD70UW, 2503A-RDC70UW

APPENDIX 3A – GSM FREQUENCY STABILITY TEST DATA 47

APPENDIX 3B – UMTS 4 FREQUENCY STABILITY TEST DATA 59

APPENDIX 4A – GSM RADIATED EMISSIONS TEST DATA..... 67

APPENDIX 4B – UMTS 4 RADIATED EMISSIONS TEST DATA..... 74

		EMI Test Report for the BlackBerry® smartphone Model RDD71UW, RDC71UW
Test Report No. RTS-2579-1107-62A	Dates of Test June 14 to July 11, 2011	FCC ID: L6ARDD70UW, L6ARDC70UW IC: 2503A-RDD70UW, 2503A-RDC70UW

A) Scope

This report details the results of compliance tests which were performed in accordance to the requirements of:

- FCC CFR 47 Part 2, Oct, 2010
- FCC CFR 47 Part 22, Subpart H, Cellular Radiotelephone Services, Oct., 2010
- FCC CFR 47 Part 24 Subpart E, Broadband PCS, Oct., 2010
- FCC CFR 47 Part 27, Subpart C, Technical Standards, Oct, 2010 (Model: RDD71UW only)
- Industry Canada, RSS-132 Issue 2, September 2005, Cellular Telephones Employing New Technologies Operating in the Bands 824-849 MHz and 869-894 MHz.
- Industry Canada, RSS-133 Issue 5, February 2009, 2 GHz Personal Communications Services.
- Industry Canada, RSS-GEN Issue 3, December 2010, General Requirements and Information for the Certification of Radiocommunication Equipment
- Industry Canada, RSS-139 Issue 2, February 2009, Advanced Wireless Services Equipment Operating in the Bands 1710-1755 MHz and 2110-2155 MHz. (Model: RDD71UW only)

B) Associated Documents

1. RDD71UW_HW_Declaration CER-39234-001_Rev4
2. BlackBerrySystemSimilarity_ RDD71UW_RDC71UW
3. MultiSourceDeclaration_ RDD71UW_b1069
4. Test Report: 1-3314-01-02_11-C
5. Test Report: 1-3314-01-06_11-A
6. Test Report: 1-3314-01-33_11-A
7. Test Report: RTS-2579-1107-62B

		EMI Test Report for the BlackBerry® smartphone Model RDD71UW, RDC71UW
Test Report No. RTS-2579-1107-62A	Dates of Test June 14 to July 11, 2011	FCC ID: L6ARDD70UW, L6ARDC70UW IC: 2503A-RDD70UW, 2503A-RDC70UW

C) Product Identification

Manufactured by Research In Motion Limited whose headquarters is located at:
295 Phillip Street
Waterloo, Ontario
Canada, N2L 3W8
Phone: 519 888 7465
Fax: 519 888 6906

The equipment under test (EUT) was tested at the following locations:

RIM Testing Services EMI test facilities	
305 Phillip Street	440 Phillip Street
Waterloo, Ontario	Waterloo, Ontario,
Canada, N2L 3W8	Canada , N2L 5R9
Phone: 519 888 7465	Phone: 519 888 7465
Fax: 519 888 6906	Fax: 519 888 6906

The testing was performed from June 14 to July 11, 2011.

The sample EUT included:

		EMI Test Report for the BlackBerry® smartphone Model RDD71UW, RDC71UW	
Test Report No. RTS-2579-1107-62A	Dates of Test June 14 to July 11, 2011	FCC ID: L6ARDD70UW, L6ARDC70UW IC: 2503A-RDD70UW, 2503A-RDC70UW	

Sample	Model	CER NUMBER	PIN	Software Information
1	RDD71UW	CER-39234-001 Rev3	279CCF51	V7.0.0.118 (Platform: 8.0.0.233) Bundle 887
2	RDD71UW	CER-39234-001 Rev4	27AE9E1E	V7.0.0.169 (Platform: 8.0.0.267) Bundle 1069
3	RDD71UW	CER-39234-001 Rev4	29AE9E19	V7.0.0.118 (Platform: 8.0.0.233) Bundle 887
4	RDC71UW	CER-30954-001Rev2	27B92646	V7.0.0.169 (Platform: 8.0.0.267) Bundle 1069

RF Conducted Emissions testing was performed on samples 1 and 3.
RF Radiated Emissions testing was performed on samples 2 and 4.

Only the characteristics that have been affected by the changes from Model RDD71UW Rev3 to RDD71UW Rev4 were retested. For more information see document:
RDD71UW_HW_Declaration CER-39234-001_ Rev4

Only the characteristics that have been affected by the changes from Model RDD71UW to RDC71UW were retested. For more information see document:
BlackBerrySystemSimilarity_RDD71UW_RDC71UW

To view the differences between Bundle 887 to 1069, see document:
MultiSourceDeclaration_ RDD71UW_b1069

D) Support Equipment Used for the Testing of the EUT

No support equipment required; for list of equipment refer to section H, Compliance Test Equipment Used.

E) Test Voltage

The ac input voltage was 120 volts, 60 Hz where applicable. This configuration was per RIM's specifications.

Test Report No.
 RTS-2579-1107-62A

Dates of Test
 June 14 to July 11, 2011

FCC ID: L6ARDD70UW, L6ARDC70UW
IC: 2503A-RDD70UW, 2503A-RDC70UW

F) Test Results Chart

SPECIFICATION		TEST TYPE	RESULT	TEST DATA APPENDIX
FCC CFR 47	IC			
Part 2.1051 Part 22.917 Part 22.901	RSS-GEN, 4.9	GSM 850 Conducted Spurious Emissions	Pass	1A
Part 2.1051 Part 24.238(a)	RSS-GEN, 4.9	PCS 1900 Conducted Spurious Emissions	Pass	1A
Part 2.202 Part 22.917	RSS-GEN, 4.6	GSM 850 Occupied Bandwidth and Channel Mask	Pass	1A
Part 2.202 Part 24.238	RSS-GEN, 4.6	PCS 1900 Occupied Bandwidth and Channel Mask	Pass	1A
Part 2.1046(a)	RSS-133, 6.4 RSS-132, 4.4	GSM Conducted RF Output Power	Pass	2A
Part 2.1055(a)(d) Part 22.917	RSS-132, 4.3	GSM 850 Frequency Stability vs. Temperature and Voltage	Pass	3A
Part 2.1055(a)(d) Part 24.235	RSS-132, 4.3	PCS 1900 Frequency Stability vs. Temperature and Voltage	Pass	3A
Part 24, Subpart E	RSS-GEN, 4.8	GSM 1900 EIRP	Pass	4A
Part 22, Subpart H	RSS-GEN, 4.8	GSM 850 ERP	See test report: 1-3314-01-02_11-C	-
Part 22, Subpart H Part 24, Subpart E	RSS-GEN, 4.9	GSM Radiated Spurious/Harmonic Emissions	See test report: 1-3314-01-02_11-C	-
Part 27.53	RSS-139, 6.5	WCDMA UMTS Band 4 Conducted Spurious Emissions	Pass	1B
Part 2.202 Part 27.53	RSS-GEN, 2.3	WCDMA UMTS Band 4 Occupied Bandwidth and Channel Mask	Pass	1B
Part 2.1046(a)	RSS-139, 6.4	WCDMA UMTS Band 4 Conducted RF Output Power	Pass	2B
Part 2.1055(a)(d) Part 27.54	RSS-139, 6.3	WCDMA UMTS Band 4 Frequency Stability vs. Temperature and Voltage	Pass	3B
Part 27.53	RSS-139, 6.5	WCDMA UMTS Band 4 Radiated Spurious/Harmonic Emissions	Pass	4B
Part 27.50	RSS-139, 6.4	WCDMA UMTS Band 4 EIRP	Pass	4B

**Test Report No.**
RTS-2579-1107-62A**Dates of Test**
June 14 to July 11, 2011**FCC ID:** L6ARDD70UW, L6ARDC70UW
IC: 2503A-RDD70UW, 2503A-RDC70UW**Test Results Chart cont'd**

Part 2.1051 Part 22.917 Part 22.901(d)	RSS-GEN, 4.9	UMTS Band 5 Conducted Spurious Emissions	See test report: RTS-2579-1107-62B	-
Part 2.1051 Part 24.238(a)	RSS-GEN, 4.9	UMTS Band 2 Conducted Spurious Emissions	See test report: RTS-2579-1107-62B	-
Part 2.202 Part 22.917	RSS-GEN, 4.6	UMTS Band 5 Occupied Bandwidth and Channel Mask	See test report: RTS-2579-1107-62B	-
Part 2.202 Part 24.238	RSS-GEN, 4.6	UMTS Band 2 Occupied Bandwidth and Channel Mask	See test report: RTS-2579-1107-62B	-
Part 2.1046(a)	RSS-133, 6.4 RSS-132, 4.4	UMTS Band 2 and 5 Conducted RF Output Power	See test report: RTS-2579-1107-62B	-
Part 2.1055(a)(d) Part 22.917	RSS-132, 4.3	UMTS Band 5 Frequency Stability vs. Temperature and Voltage	See test report: RTS-2579-1107-62B	-
Part 2.1055(a)(d) Part 24.235	RSS-GEN, 4.7	UMTS Band 2 Frequency Stability vs. Temperature and Voltage	See test report: RTS-2579-1107-62B	-
Part 22, Subpart H	RSS-GEN, 4.9	UMTS Band 5 Radiated Spurious/Harmonic Emissions, ERP	See test report: 1-3314-01-33_11-A	-
Part 24, Subpart E	RSS-GEN, 4.9	UMTS Band 2 Radiated Spurious/Harmonic Emissions, EIRP	See test report: 1-3314-01-33_11-A	-

		EMI Test Report for the BlackBerry® smartphone Model RDD71UW, RDC71UW
Test Report No. RTS-2579-1107-62A	Dates of Test June 14 to July 11, 2011	FCC ID: L6ARDD70UW, L6ARDC70UW IC: 2503A-RDD70UW, 2503A-RDC70UW

g) Summary of Results

1) Conducted Emission Measurements

The following test configurations were measured for model RDD71UW:

a) The BlackBerry® smartphone met the requirements of the Tx Conducted Spurious Emissions requirements in the GSM850 as per 47 CFR 2.1051, CFR 22.917, CFR 22.901(d) and RSS-GEN, 4.9. The EUT was measured on the low, middle and high channels. The frequency range investigated was from 10 MHz to 10 GHz.

See APPENDIX 1A for test data.

The BlackBerry® smartphone met the requirements of the Tx Conducted Spurious Emissions requirements in the PCS1900 as per 47 CFR 2.1051, CFR 24.238(a) and RSS-GEN, 4.9. The EUT was on the low, middle and high channels. The frequency range investigated was from 10 MHz to 20 GHz.

See APPENDIX 1A for test data

b) The BlackBerry® smartphone met the requirements of the Occupied Bandwidth and channel mask requirements in the GSM850 as per 47 CFR 2.202, CFR 22.917 and RSS-GEN, 4.6. The EUT was measured in GSM and EDGE mode on the low, middle and high channels. The worst case occupied bandwidth was 247 kHz on low channel in GSM mode, and 245 kHz on low, middle and high channel in EDGE mode.

See APPENDIX 1A for test data.

The BlackBerry® smartphone met the requirements of the Occupied Bandwidth and channel mask requirements in the PCS1900 as per 47 CFR 2.202, CFR 24.238 and RSS-GEN, 4.6. The EUT was measured in GSM and EDGE mode on the low, middle and high channels. The worst case occupied bandwidth was 248 kHz on high channel in GSM, and 245 kHz on low, middle and high channel in EDGE mode.

See APPENDIX 1A for test data.

c) The BlackBerry® smartphone met the requirements of the Tx Conducted RF output Power requirements in the GSM850 as per 47 CFR 2.1046, and RSS-GEN, 4.4. The EUT was measured on the low, middle and high channels.

See APPENDIX 2A for test data.

The BlackBerry® smartphone met the requirements of the Tx Conducted RF output Power requirements in the PCS1900 as per 47 CFR 2.1046, and RSS-GEN, 6.4. The EUT was on the low, middle and high channels.

See APPENDIX 2A for test data

		EMI Test Report for the BlackBerry® smartphone Model RDD71UW, RDC71UW
Test Report No. RTS-2579-1107-62A	Dates of Test June 14 to July 11, 2011	FCC ID: L6ARDD70UW, L6ARDC70UW IC: 2503A-RDD70UW, 2503A-RDC70UW

d) The BlackBerry® smartphone met the requirements of the Frequency Stability requirements in the GSM850 as per 47 CFR 2.1055, CFR 22.917 and RSS-GEN, 4.3. The EUT was measured in GSM850 mode on the low, middle and high channels.

See APPENDIX 3A for test data.

The BlackBerry® smartphone met the requirements of the Frequency Stability requirements in the PCS1900 as per 47 CFR 2.1055, CFR 24.235 and RSS-GEN, 4.7. The EUT was measured in PCS1900 mode on the low, middle and high channels.

See APPENDIX 3A for test data.

e) The BlackBerry® smartphone met the requirements of the Conducted Spurious Emissions in the UMTS band 4 as per 47 CFR 27.53 and RSS-139, 6.5. The EUT was measured on the low, middle and high channels. The frequency range investigated was from 10 MHz to 20 GHz.

See APPENDIX 1B for the test data.

f) The BlackBerry® smartphone met the requirements of the Occupied Bandwidth in the UMTS band 4 as per 47 CFR 2.202, CFR 27.53 and RSS-139, 2.3. The low, middle and high channels were measured. The worst case occupied bandwidth was 4.200 MHz on middle channel in Loopback and 4.217 MHz on low and high channel in HSUPA mode.

See APPENDIX 1B for the test data.

g) The BlackBerry® smartphone met the requirements of the Conducted RF Output Power for the UMTS band 4 as per 47 CFR 2.1046(a), RSS-139, 6.4 and RSS-132, 4.4. The low, middle and high channels were measured.

See APPENDIX 2B for test data.

h) The BlackBerry® smartphone met the requirements of the Frequency Stability vs. Temperature and Voltage for UMTS band 4 as per 47 CFR 2.1055(a)(d), CFR 27.54 and RSS-139, 6.3. The maximum frequency error measured was less than 0.1 ppm. The temperature range was from -30°C to +60°C in 10° temperature steps. The BlackBerry® smartphone was measured on low, middle and high channels at each temperature step. The BlackBerry® smartphone was measured at low (3.6 volts), nominal (3.7 volts) and high (4.2 volts) dc input voltage at each temperature step and channel at maximum output power.

See APPENDIX 3B for test data.

		EMI Test Report for the BlackBerry® smartphone Model RDD71UW, RDC71UW
Test Report No. RTS-2579-1107-62A	Dates of Test June 14 to July 11, 2011	FCC ID: L6ARDD70UW, L6ARDC70UW IC: 2503A-RDD70UW, 2503A-RDC70UW

2) Radiated Emission Measurements

The radiated spurious emissions/harmonics and ERP/EIRP were measured for PCS 1900 and UMTS 4. The results are within the limits. The BlackBerry® smartphone was placed on a nonconductive styrofoam table, 100 cm high that was positioned on a remotely controlled turntable. The test distance used between the BlackBerry® smartphone and the receiving antenna was three metres. Then the emissions were maximized by elevating the antenna in the range of 1 to 4 metres. The turntable was rotated to determine the azimuth of the peak emissions. Both the horizontal and vertical polarizations of the emissions were measured. The maximum emissions level was recorded. The BlackBerry® smartphone was then substituted with an antenna placed in the same location as the BlackBerry® smartphone. A Dipole antenna was used for the ERP measurements and a Horn antenna was used for EIRP measurements. The substitution antenna was connected into a signal generator that was set to the test frequency.

The emissions were maximized by elevating the antenna in the range of 1 to 4 metres. The signal generator output was then adjusted to match the BlackBerry® smartphone output reading. The signal generator output was recorded. Both the horizontal and vertical polarizations of the emissions were measured.

The following measurements were done in a semi-anechoic chamber (SAC) below 1 GHz and a Semi-anechoic Chamber ((SAC) with floor absorber) above 1 GHz. The SAC's FCC registration number is **778487** and the Industry Canada (IC) file number is **2503B-1**. The SAC with floor absorber's FCC registration number is **959115** and the IC file number is **2503C-1**. The BlackBerry® smartphone was measured on the low, middle and high channels.

The following test configurations were measured for model RDD71UW:

The highest EIRP in the PCS band call mode measured was 32.47 dBm (1.77 W) at 1909.80 MHz (channel 810).

The highest EIRP in the PCS band EDGE mode measured was 30.70 dBm (1.18 W) at 1880.0 MHz (channel 661).

The highest ERP in the UMTS band 4, Call Service mode was 23.91 dBm (0.25 W) at 1752.6 MHz (channel 1513).

The highest ERP in the UMTS band 4, HSUPA mode was 24.70 dBm (0.30 W) at 1752.6 MHz (channel 1513).

		EMI Test Report for the BlackBerry® smartphone Model RDD71UW, RDC71UW
Test Report No. RTS-2579-1107-62A	Dates of Test June 14 to July 11, 2011	FCC ID: L6ARDD70UW, L6ARDC70UW IC: 2503A-RDD70UW, 2503A-RDC70UW

The radiated carrier harmonics were measured up to the 10th harmonic for low, middle and high channels in the UMTS band 4 and was measured in Call, and HSUPA modes. Both the horizontal and vertical polarizations were measured.

The margins in the UMTS band 4 for harmonic emissions were greater than 25 dB below the accepted limits for all test frequencies.

The following test configurations were measured for model RDC71UW:

The highest EIRP in the PCS band call mode measured was 32.68 dBm (1.85 W) at 1909.80 MHz (channel 810).

The highest EIRP in the PCS band EDGE mode measured was 31.03 dBm (1.27 W) at 1909.80 MHz (channel 810).

The radiated spurious emission and carrier harmonics were measured up to the 10th harmonic for low, middle, and high channels in the GSM850 and PCS 1900 bands. Each band was measured in GSM and EDGE mode, with both the horizontal and vertical polarizations.

The margins in the GSM850 and PCS 1900 for harmonic emissions were greater than 25 dB below the accepted limits for all test frequencies.

b) Co-Location Measurements

The following test configurations were measured for model RDD71UW:

See Test Report: 1-3314-01-06_11-A

Sample Calculation:

Corrected Signal Level (CSL) is calculated as follows:

$$\text{CSL (dBm)} = \text{Measured Level (dB}\mu\text{V)} - \text{Antenna Gain (dBi)} + \text{Free Space Loss (dB)} - 107 \text{ (dB)} + \text{Cable Loss (dB)} - \text{Preamp (dB)} + \text{Filter Loss (dB)} - 2.15 \text{ (dB)}$$

To view the test data see APPENDIX 4A and 4B.

Measurement Uncertainty ±4.6 dB

**Test Report No.**
RTS-2579-1107-62A**Dates of Test**
June 14 to July 11, 2011**FCC ID:** L6ARDD70UW, L6ARDC70UW
IC: 2503A-RDD70UW, 2503A-RDC70UW**H) Compliance Test Equipment Used**

<u>UNIT</u>	<u>MANUFACTURER</u>	<u>MODEL</u>	<u>SERIAL NUMBER</u>	<u>CAL DUE DATE</u> (YY MM DD)	<u>USE</u>
Preamplifier	Sonoma	310N/11909A	185831	11-11-24	Radiated Emissions
Preamplifier system	TDK RF Solutions	PA-02	080010	11-11-24	Radiated Emissions
Preamplifier	Rohde & Schwarz	TS-ANA4-SP	001	11-12-01	Radiated Emissions
Preamplifier	Rohde & Schwarz	TS-ANA-SP	001	11-12-01	Radiated Emissions
Hybrid Log Antenna	EMC Automation	HLP-3003C	017401	12-01-04	Radiated Emissions
Horn Antenna	EMC Automation	HRN-0118	030101	12-07-20	Radiated Emissions
Horn Antenna	EMC Automation	HRN-0118	030201	12-09-22	Radiated Emissions
Horn Antenna	Emco	3117	47563	11-07-15	Radiated Emissions
Horn Antenna	CMT	LHA 0180	R52734-001	12-01-21	Radiated Emissions
Dipole Antenna	Schwarzbeck	UHAP	973	12-02-21	Radiated Emissions
Dipole Antenna	Schwarzbeck	UHAP	974	13-02-21	Radiated Emissions
Universal Radio Communication Tester	Rohde & Schwarz	CMU 200	837493/073	11-10-01	Radiated Emissions
Universal Radio Communication Tester	Rohde & Schwarz	CMU 200	112394	11-10-01	Radiated Emissions
Universal Radio Communication Tester	Rohde & Schwarz	CMU 200	102204	11-11-30	RF Conducted Emissions
EMI Receiver	Rohde & Schwarz	ESIB-40	100255	11-11-28	Radiated Emissions
EMI Receiver	Rohde & Schwarz	ESU-40	100162	11-11-30	Radiated Emissions
Spectrum Analyzer	HP	8563E	3745A08112	11-09-30	RF Conducted Emissions
DC Power Supply	HP	6632B	US37472178	11-11-19	RF Conducted Emissions
Environment Monitor	Omega	iTHX-SD	0380561	11-10-13	Radiated Emissions

		EMI Test Report for the BlackBerry® smartphone Model RDD71UW, RDC71UW
Test Report No. RTS-2579-1107-62A	Dates of Test June 14 to July 11, 2011	FCC ID: L6ARDD70UW, L6ARDC70UW IC: 2503A-RDD70UW, 2503A-RDC70UW

Compliance Test Equipment Used cont'd

<u>UNIT</u>	<u>MANUFACTURER</u>	<u>MODEL</u>	<u>SERIAL NUMBER</u>	<u>CAL DUE DATE</u> (YY MM DD)	<u>USE</u>
Environment Monitor	Omega	iTHX-SD	0340060	11-10-13	RF Conducted Emissions
Environment Monitor	Omega	iTHX-SD	0380567	11-10-13	Radiated Emissions
Signal Generator	Agilent	E8257D	MY45140527	11-11-05	Radiated Emissions
Signal Generator	Agilent	83630B	3844A00927	12-10-28	Radiated Emissions

APPENDIX 1A – GSM CONDUCTED RF EMISSIONS TEST DATA/PLOTS

	EMI Test Report for the BlackBerry® smartphone Model RDD71UW, RDC71UW	
	APPENDIX 1A	
Test Report No. RTS-2579-1107-62A	Dates of Test June 14 to July 11, 2011	FCC ID: L6ARDD70UW, L6ARDC70UW IC: 2503A-RDD70UW, 2503A-RDC70UW

GSM Conducted RF Emission Test Data

The following test configurations were measured for model RDD71UW:

This appendix contains measurement data pertaining to conducted spurious emissions, -26 dBc bandwidth, 99% power bandwidth and the channel mask on BlackBerry® smartphone.

Test Setup Diagram

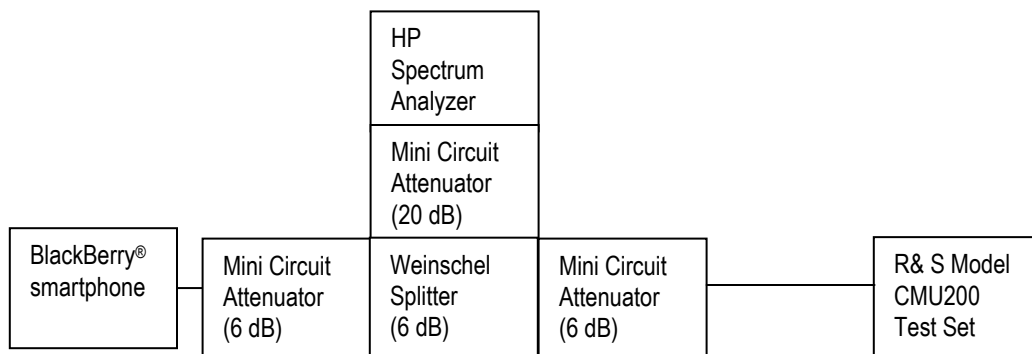

Date of Test: July 6, 2011

The environmental test conditions were:

Temperature: 23 °C

Relative Humidity: 37 %

The following measurements were performed by Maurice Battler.

	EMI Test Report for the BlackBerry® smartphone Model RDD71UW, RDC71UW	
	APPENDIX 1A	
Test Report No. RTS-2579-1107-62A	Dates of Test June 14 to July 11, 2011	FCC ID: L6ARDD70UW, L6ARDC70UW IC: 2503A-RDD70UW, 2503A-RDC70UW

GSM Conducted RF Emission Test Data cont'd

The conducted spurious emissions – As per 47 CFR 2.1051, CFR 24.238(a), RSS-GEN, 4.9, CFR 22 Subpart H and RSS-132 were measured from 10 MHz to 20 GHz. The EUT emissions were in the noise floor.

See figures 1-1a to 1-12a for the plots of the conducted spurious emissions.

–26 dBc Bandwidth and Occupied Bandwidth (99%)

For each carrier frequency of low, middle and high, the modulation spectrum was measured by both methods of 99% power bandwidth and –26 dBc bandwidth.

The resolution bandwidth required for out-of-band emissions in the 1 MHz bands immediately outside and adjacent to the frequency block, was determined to be at least 1% of the emission bandwidth.

The worst case –26dBc bandwidth for the GSM850 band was measured to be 277 kHz, and for the PCS1900 band was measured to be 275 kHz as shown below. This results in a 3.0 kHz resolution bandwidth.

On any frequency outside the frequency block and outside the adjacent 1 MHz bands, a resolution bandwidth of at least 1 MHz was applied.

Test Data for 850 band and 1900 band selected Frequencies in GSM mode.

850 band Frequency (MHz)	-26dBc Bandwidth (kHz)	99% Occupied Bandwidth (kHz)
824.2	277	247.0
837.6	270	245.0
848.8	272	245.0

1900 band Frequency (MHz)	-26dBc Bandwidth (kHz)	99% Occupied Bandwidth (kHz)
1850.2	275	247.0
1880.0	270	245.0
1909.8	268	248.0

Measurement Plots for 850 and 1900 in GSM mode

Refer to the following measurement plots for more detail.

See Figures 1-13a to 1-24a for the plots of 26dBc/99% Occupied Bandwidth.

The RF power output was at maximum for all the recorded measurements shown below.

	EMI Test Report for the BlackBerry® smartphone Model RDD71UW, RDC71UW	
	APPENDIX 1A	
Test Report No. RTS-2579-1107-62A	Dates of Test June 14 to July 11, 2011	FCC ID: L6ARDD70UW, L6ARDC70UW IC: 2503A-RDD70UW, 2503A-RDC70UW

GSM Conducted RF Emission Test Data cont'd

Test Data for 850 and 1900 bands selected Frequencies in EDGE mode.

850 band Frequency (MHz)	99% Occupied Bandwidth (kHz)
824.2	245.0
837.6	245.0
848.8	245.0

1900 band Frequency (MHz)	99% Occupied Bandwidth (kHz)
1850.2	245.0
1880.0	245.0
1909.8	245.0

Measurement Plots for 850 and 1900 bands in EDGE mode

Refer to the following measurement plots for more detail.

See Figures 1-1a to 1-12a for the plots of the conducted spurious emissions.

See Figures 1-13a to 1-24a for the plots of 26dBc/99% Occupied Bandwidth.

See Figures 1-25a to 1-28a for the plots of the Channel mask.

See Figures 1-29a to 1-34a for the plots of the 99% Occupied Bandwidth EDGE results.

See Figures 1-35a to 1-38a for the plots of channel mask EDGE results.

See Figures 1-39a to 1-50a for the plots of the conducted spurious emissions EDGE results

The RF power output was at maximum for all the recorded measurements shown below.

	EMI Test Report for the BlackBerry® smartphone Model RDD71UW, RDC71UW	
	APPENDIX 1A	
Test Report No. RTS-2579-1107-62A	Dates of Test June 14 to July 11, 2011	FCC ID: L6ARDD70UW, L6ARDC70UW IC: 2503A-RDD70UW, 2503A-RDC70UW

GSM Conducted RF Emission Test Data cont'd

Figure 1-1a: GSM850 band, Spurious Conducted Emissions, Low channel

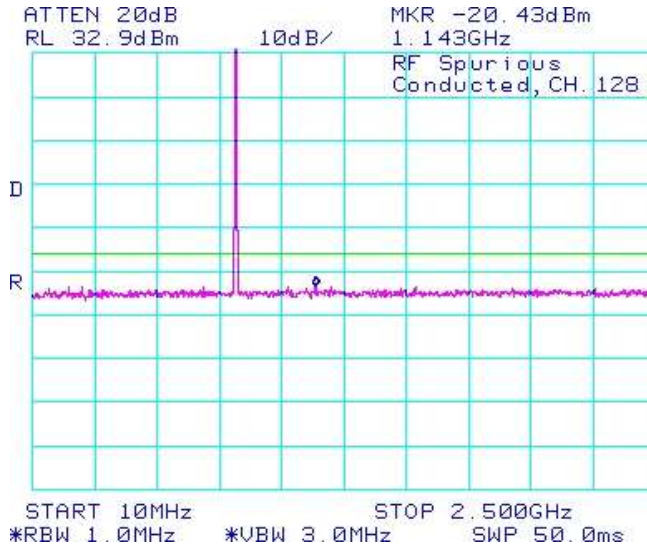

Figure 1-2a: GSM850 band, Spurious Conducted Emissions, Low channel

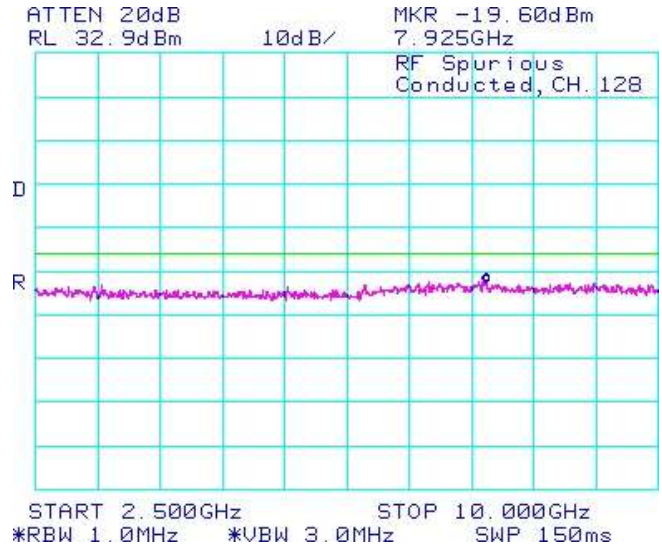

Figure 1-3a: GSM850 band, Spurious Conducted Emissions, Middle Channel

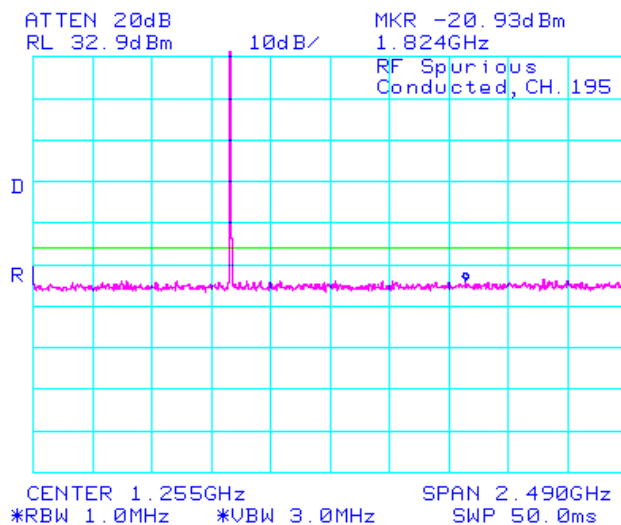
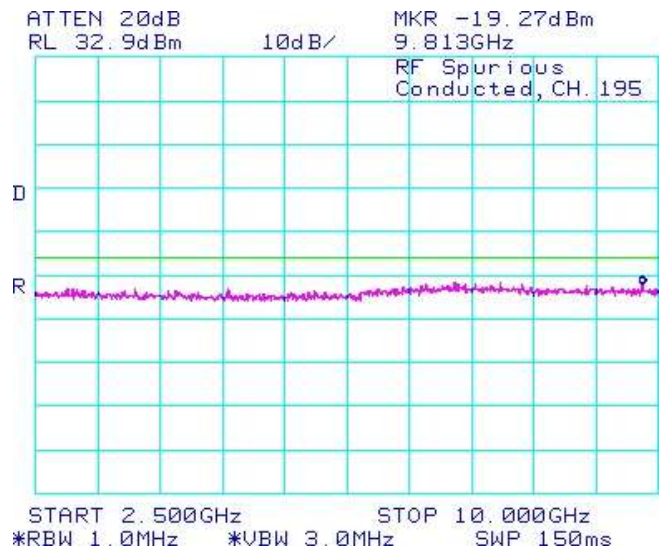



Figure 1-4a: GSM850 band, Spurious Conducted Emissions, Middle Channel



	EMI Test Report for the BlackBerry® smartphone Model RDD71UW, RDC71UW APPENDIX 1A	
	Test Report No. RTS-2579-1107-62A	Dates of Test June 14 to July 11, 2011

GSM Conducted RF Emission Test Data cont'd

Figure 1-5a: GSM850 band, Spurious Conducted Emissions, High Channel

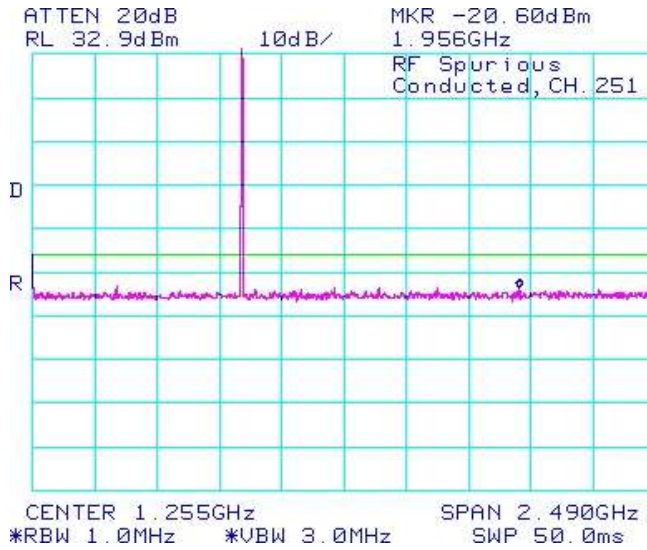

Figure 1-6a: GSM850 band, Spurious Conducted Emissions, High Channel

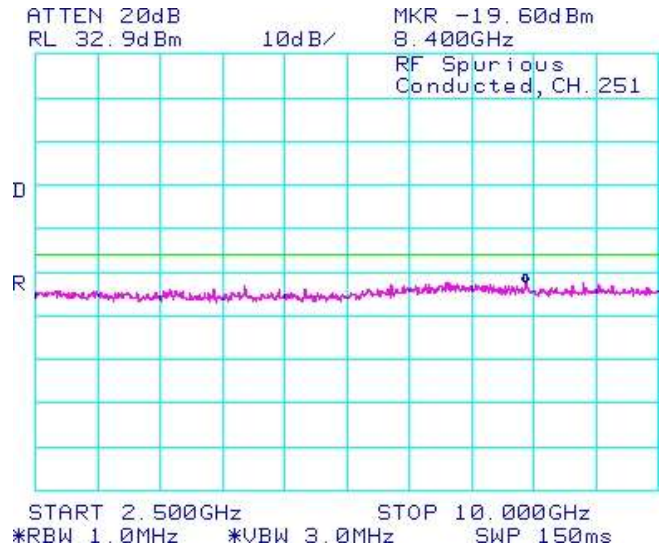

Figure 1-7a: PCS1900 band, Spurious Conducted Emissions, Low Channel

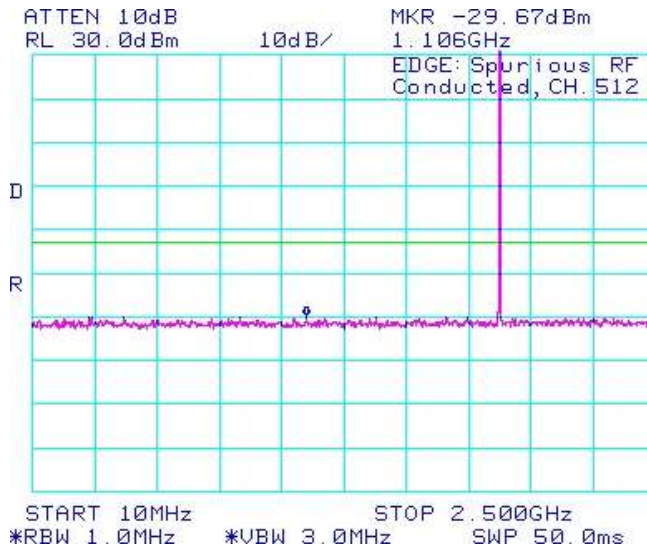
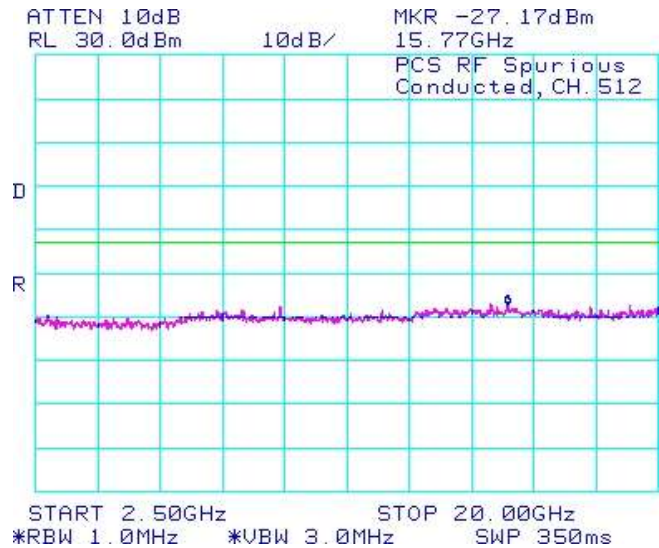



Figure 1-8a: PCS1900 band, Spurious Conducted Emissions, Low Channel



	EMI Test Report for the BlackBerry® smartphone Model RDD71UW, RDC71UW APPENDIX 1A	
	Test Report No. RTS-2579-1107-62A	Dates of Test June 14 to July 11, 2011

GSM Conducted RF Emission Test Data cont'd

Figure 1-9a: PCS1900 band, Spurious Conducted Emissions, Middle Channel

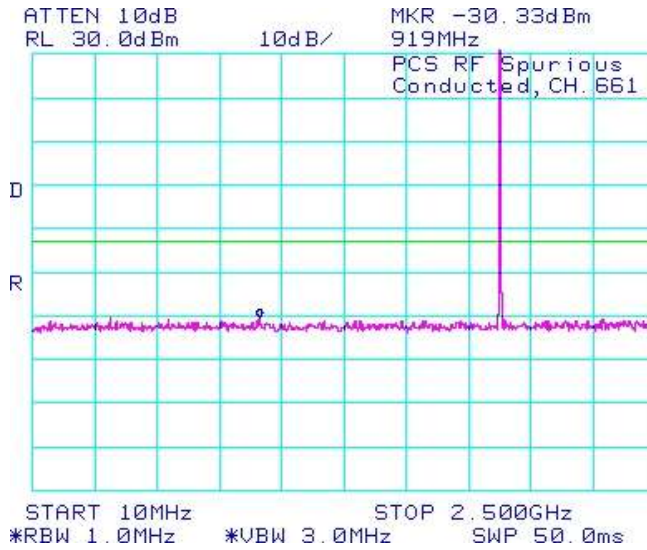

Figure 1-10a: PCS1900 band, Spurious Conducted Emissions, Middle Channel

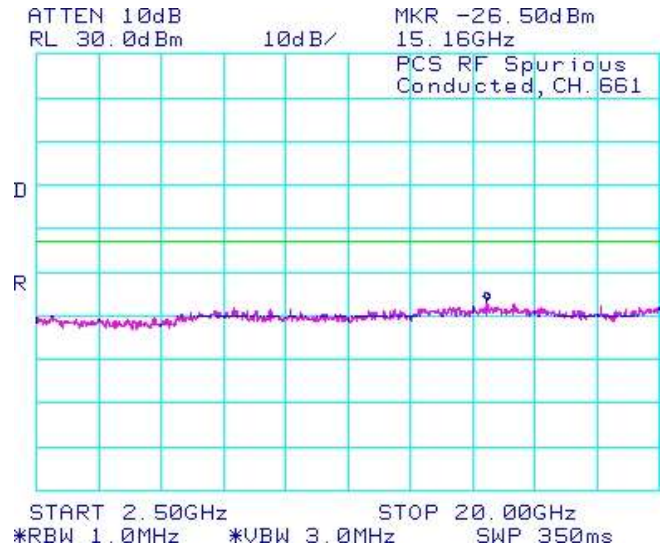

Figure 1-11a: PCS1900 band, Spurious Conducted Emissions, High Channel

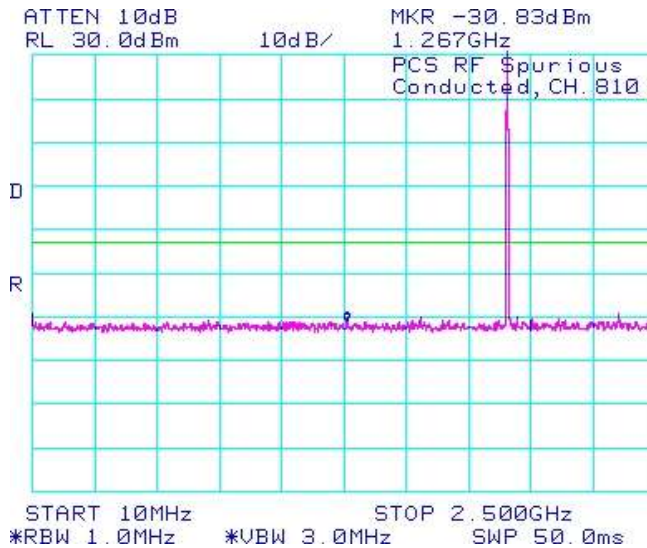
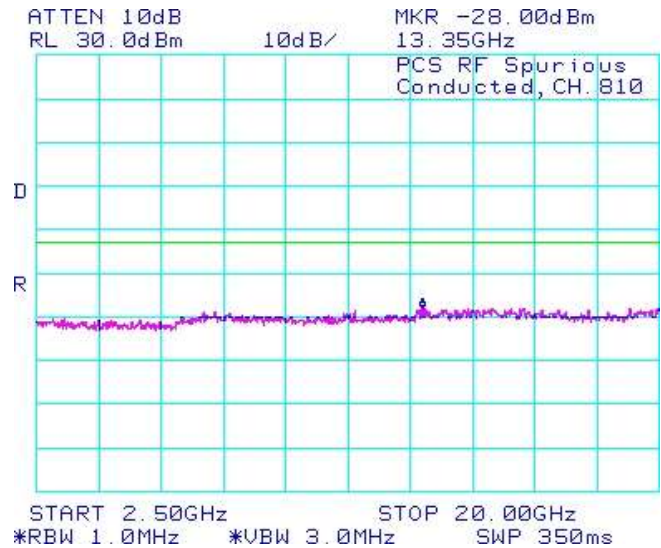



Figure 1-12a: PCS1900 band, Spurious Conducted Emissions, High Channel



	EMI Test Report for the BlackBerry® smartphone Model RDD71UW, RDC71UW APPENDIX 1A	
	Test Report No. RTS-2579-1107-62A	Dates of Test June 14 to July 11, 2011

GSM Conducted RF Emission Test Data cont'd

Figure 1-13a: -26dBc bandwidth, GSM850 band Low Channel in GSM mode

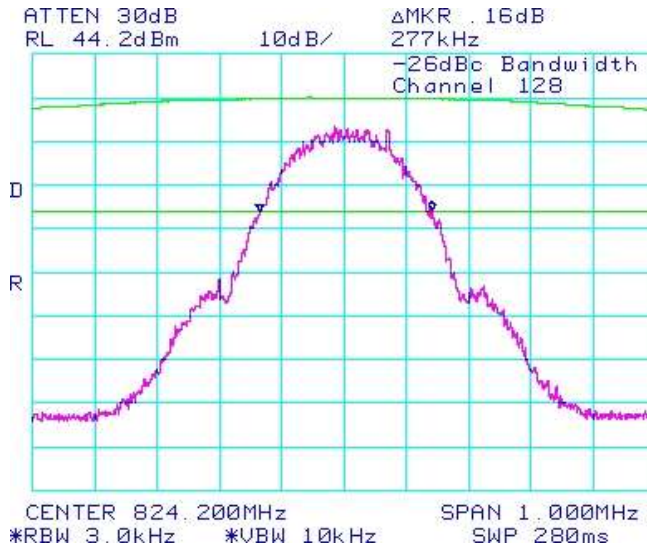

Figure 1-14a: Occupied Bandwidth, GSM850 band Low Channel in GSM mode

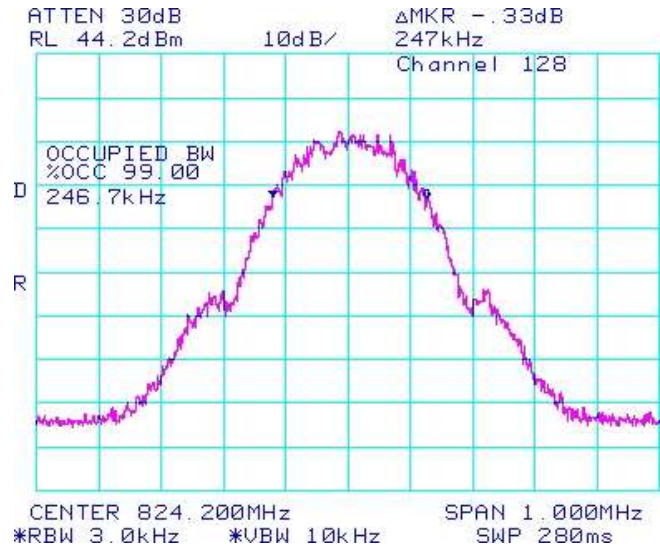

Figure 1-15a: -26dBc bandwidth, GSM850 band Middle Channel in GSM mode

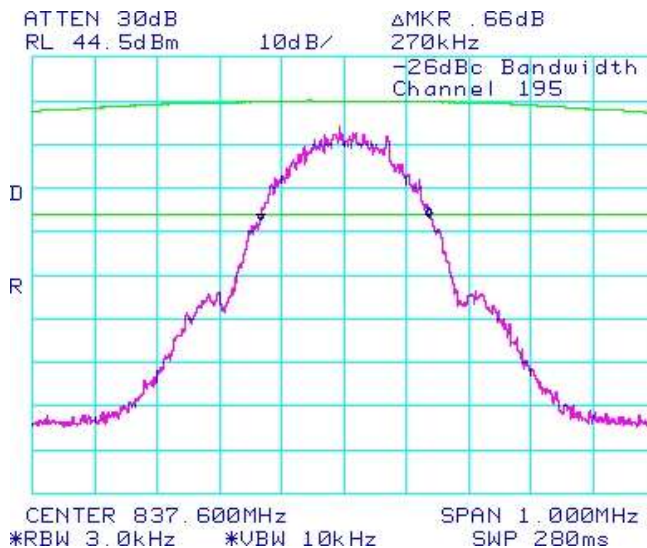
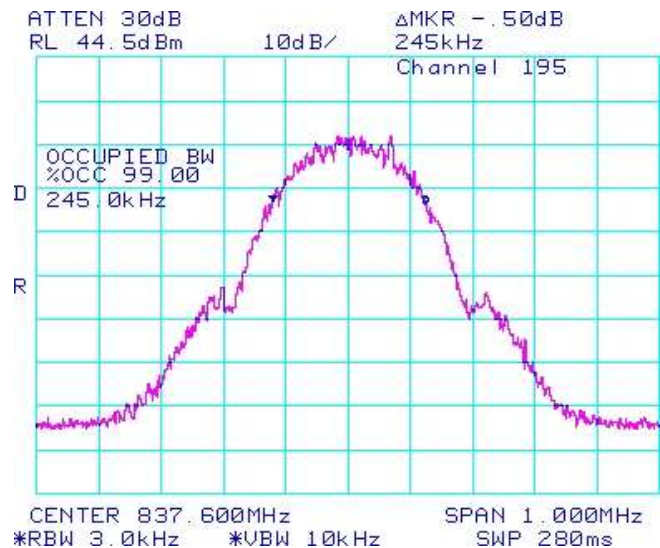



Figure 1-16a: Occupied Bandwidth, GSM850 band Middle Channel in GSM mode



	EMI Test Report for the BlackBerry® smartphone Model RDD71UW, RDC71UW APPENDIX 1A	
	Test Report No. RTS-2579-1107-62A	Dates of Test June 14 to July 11, 2011

GSM Conducted RF Emission Test Data cont'd

Figure 1-17a: -26dBc bandwidth, GSM850 band High Channel in GSM mode

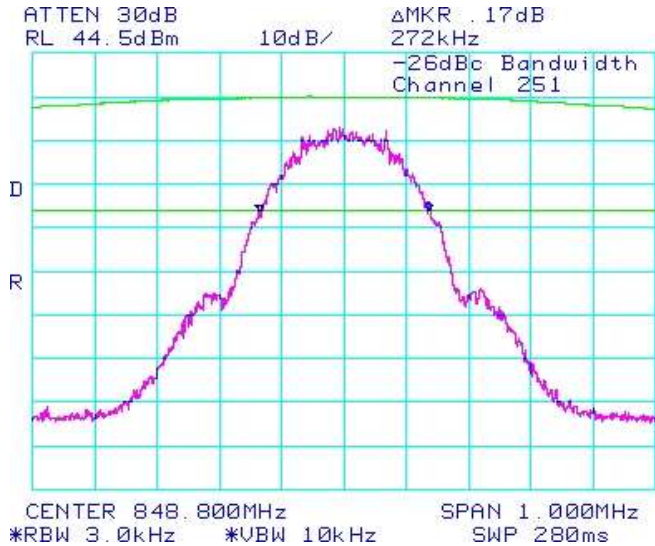

Figure 1-18a: Occupied Bandwidth, GSM850 band High Channel in GSM mode

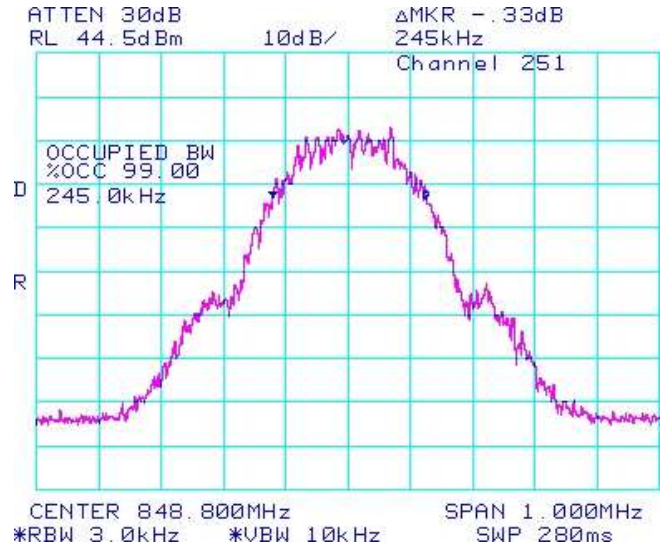

Figure 1-19a: -26dBc bandwidth, PCS1900 Low Channel in GSM mode

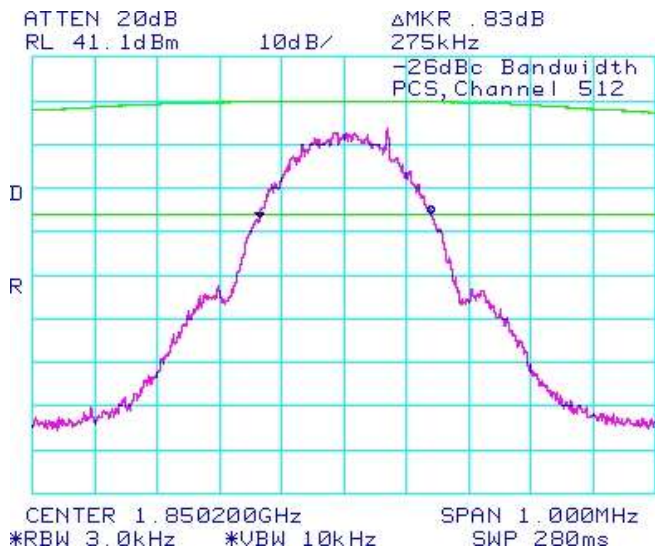
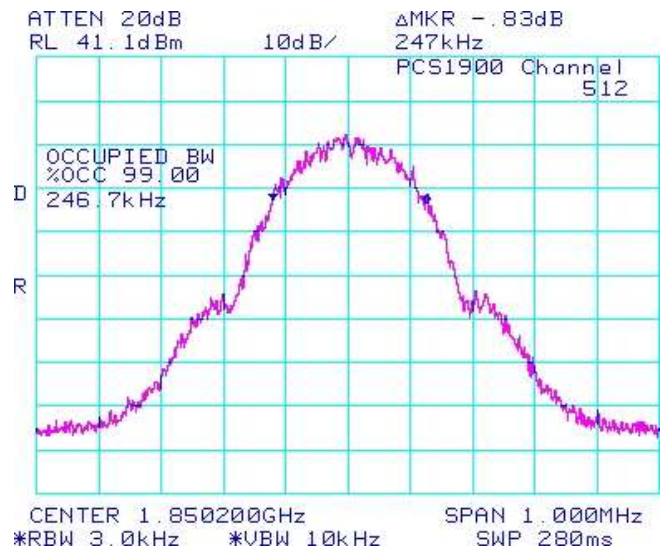



Figure 1-20a: Occupied Bandwidth, PCS1900 Low Channel in GSM mode



	EMI Test Report for the BlackBerry® smartphone Model RDD71UW, RDC71UW APPENDIX 1A	
	Test Report No. RTS-2579-1107-62A	Dates of Test June 14 to July 11, 2011

GSM Conducted RF Emission Test Data cont'd

Figure 1-21a: -26dBc bandwidth, PCS1900 Middle Channel in GSM mode

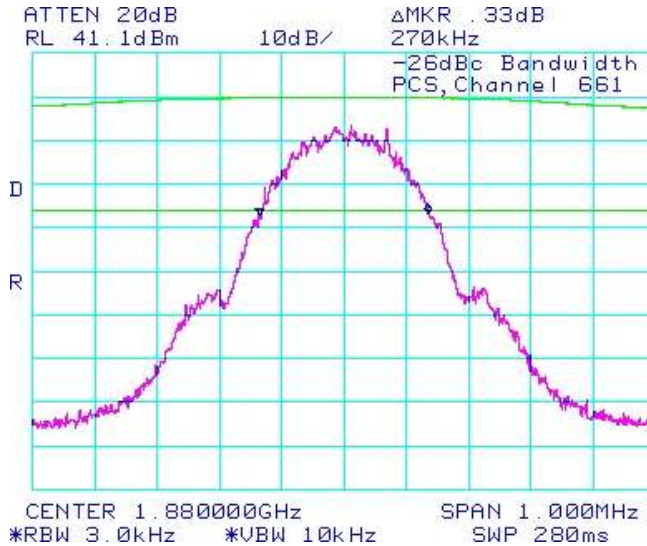

Figure 1-22a: Occupied Bandwidth, PCS1900 Middle Channel in GSM mode

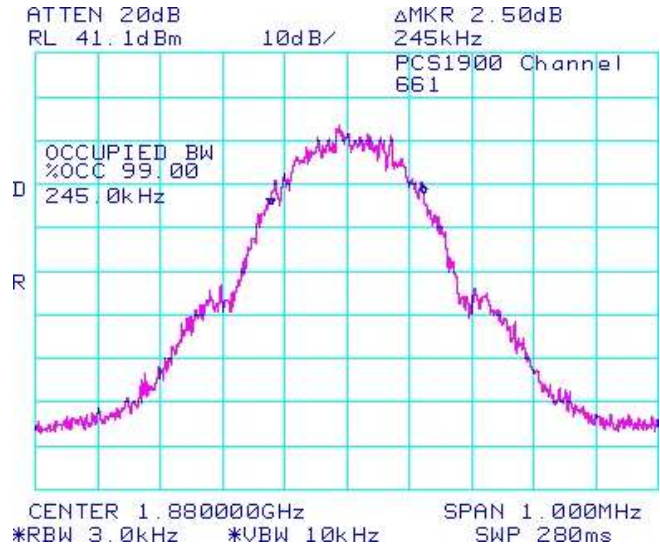

Figure 1-23a: -26dBc bandwidth, PCS1900 High Channel in GSM mode

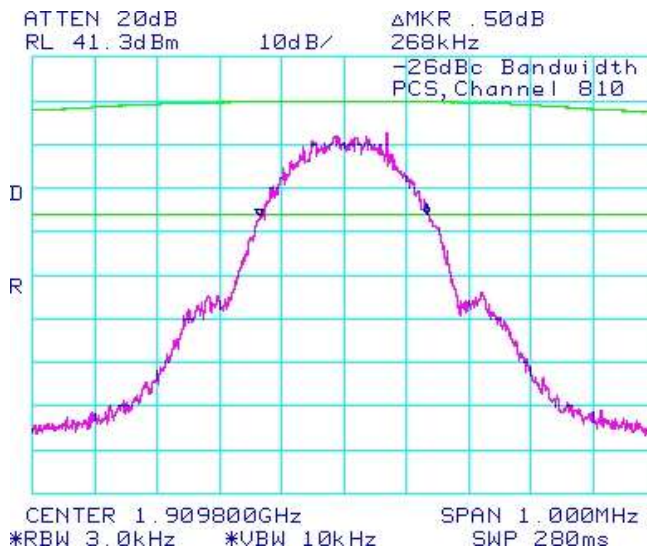
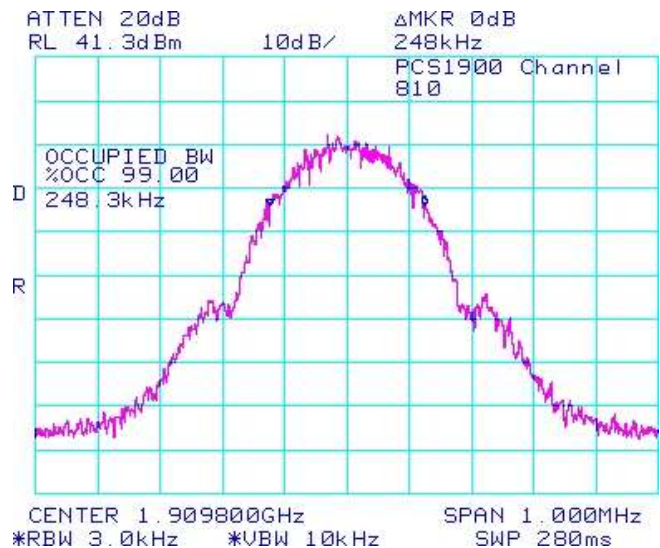



Figure 1-24a: Occupied Bandwidth, PCS1900 High Channel in GSM mode



	EMI Test Report for the BlackBerry® smartphone Model RDD71UW, RDC71UW APPENDIX 1A	
	Test Report No. RTS-2579-1107-62A	Dates of Test June 14 to July 11, 2011

GSM Conducted RF Emission Test Data cont'd

Figure 1-25a: GSM850 band, Low Channel Mask in GSM mode

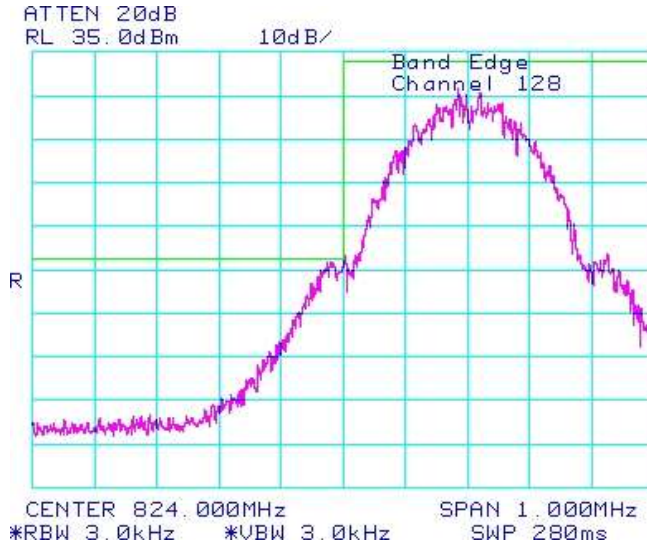

Figure 1-26a: GSM850 band High Channel Mask in GSM mode

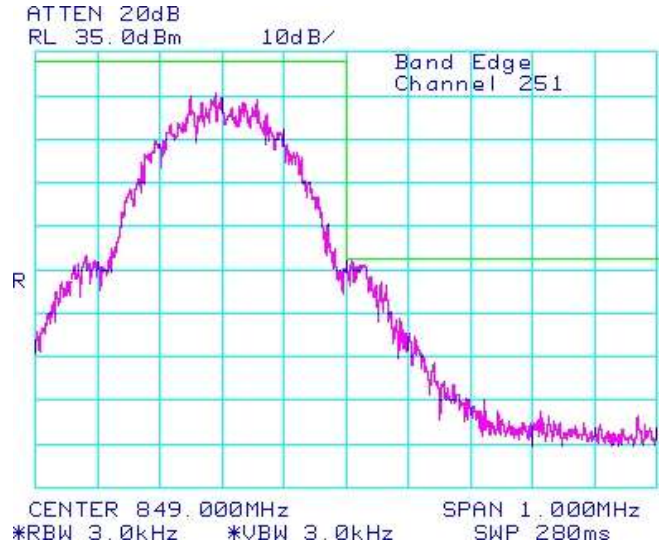

Figure 1-27a: PCS1900, Low Channel Mask in GSM mode

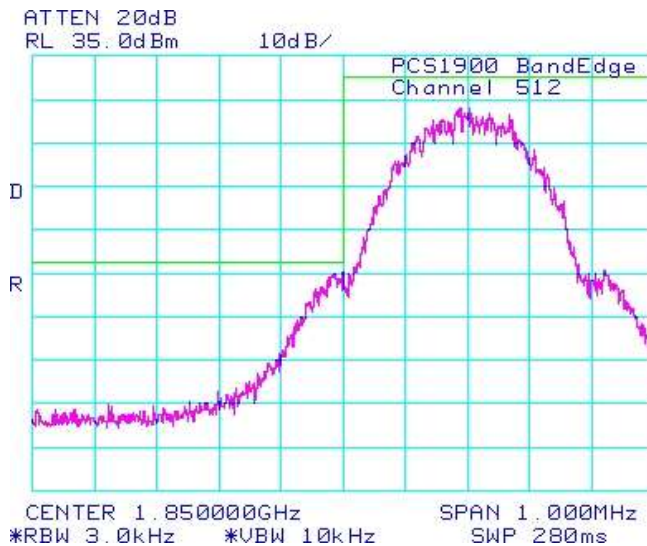
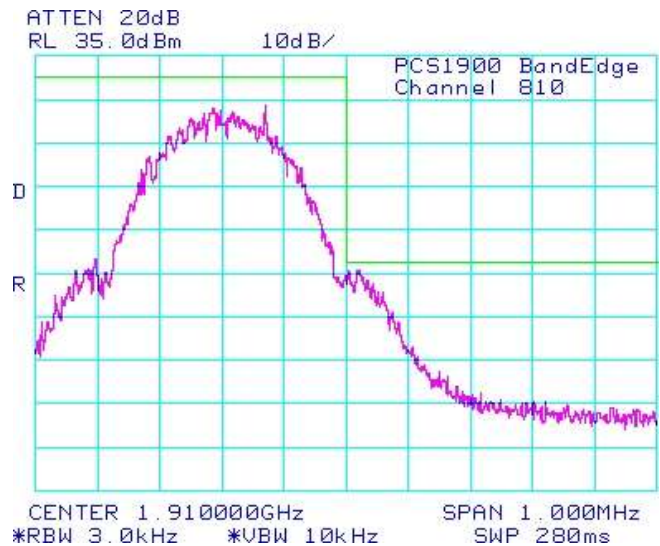



Figure 1-28a: PCS1900, High Channel Mask in GSM mode



	EMI Test Report for the BlackBerry® smartphone Model RDD71UW, RDC71UW APPENDIX 1A	
	Test Report No. RTS-2579-1107-62A	Dates of Test June 14 to July 11, 2011

GSM Conducted RF Emission Test Data cont'd

Figure 1-29a: Occupied Bandwidth, GSM850 Band, Low Channel in EDGE mode

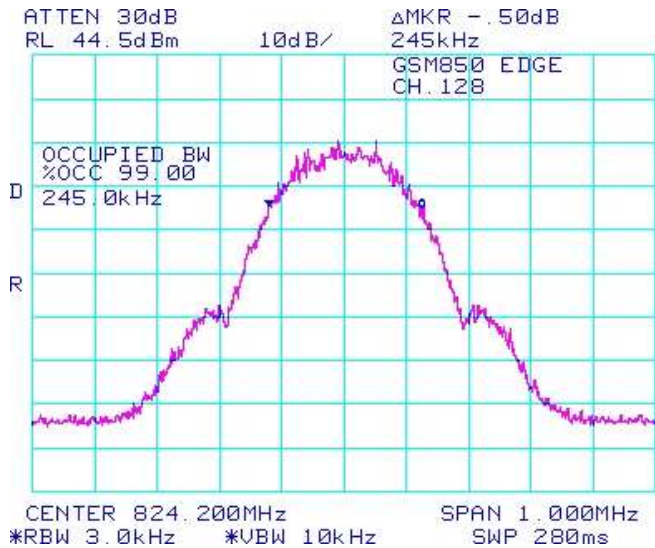

Figure 1-30a: Occupied Bandwidth, GSM850 Band, Middle Channel in EDGE mode

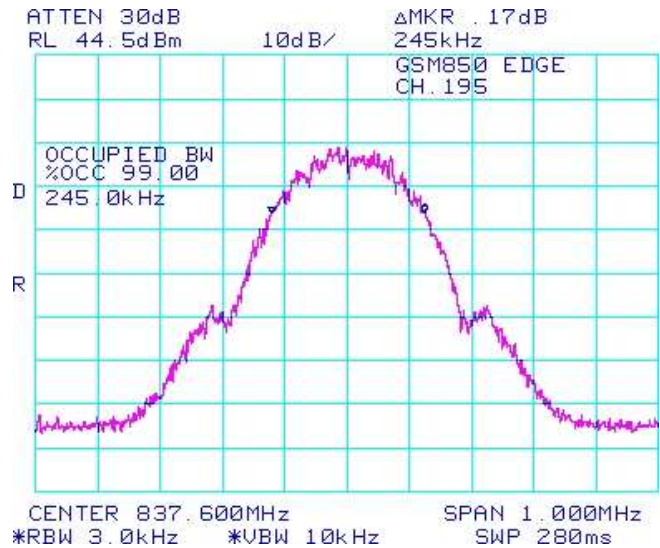

Figure 1-31a: Occupied Bandwidth, GSM850 band, High Channel in EDGE mode

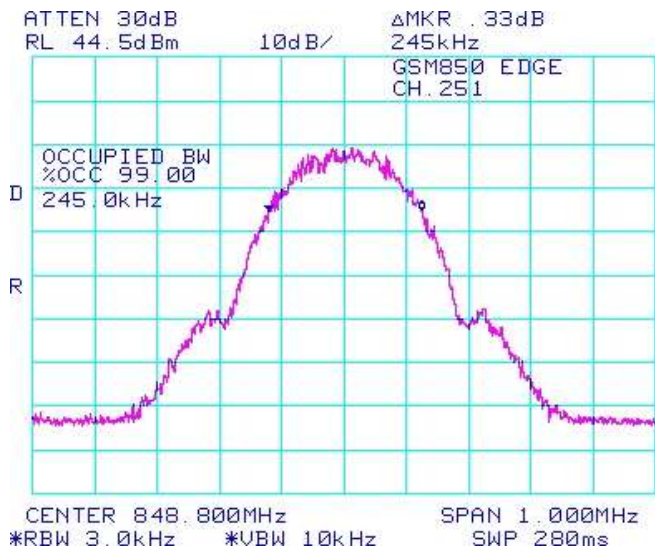
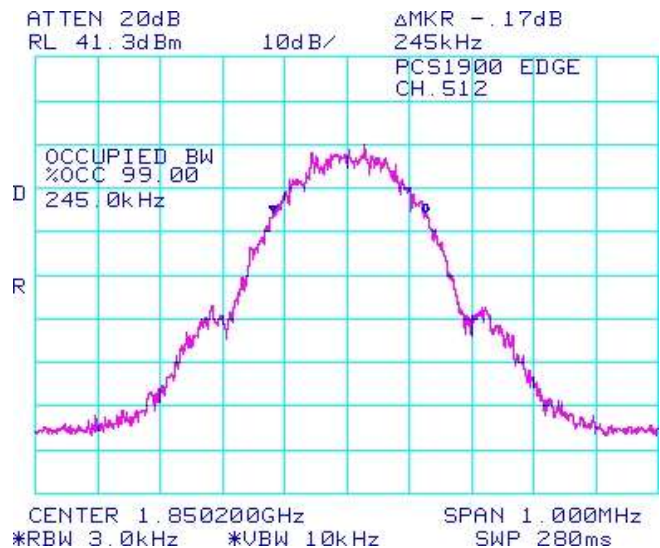



Figure 1-32a: Occupied Bandwidth, PCS1900 Band, Low Channel in EDGE mode



	EMI Test Report for the BlackBerry® smartphone Model RDD71UW, RDC71UW APPENDIX 1A	
	Test Report No. RTS-2579-1107-62A	Dates of Test June 14 to July 11, 2011

GSM Conducted RF Emission Test Data cont'd

Figure 1-33a: Occupied Bandwidth, PCS1900 Band, Middle Channel in EDGE mode

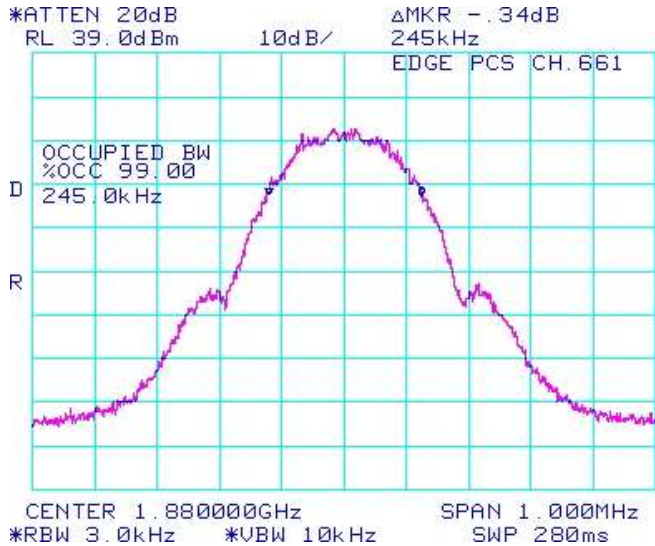

Figure 1-34a: Occupied Bandwidth, PCS1900 Band, High Channel in EDGE mode

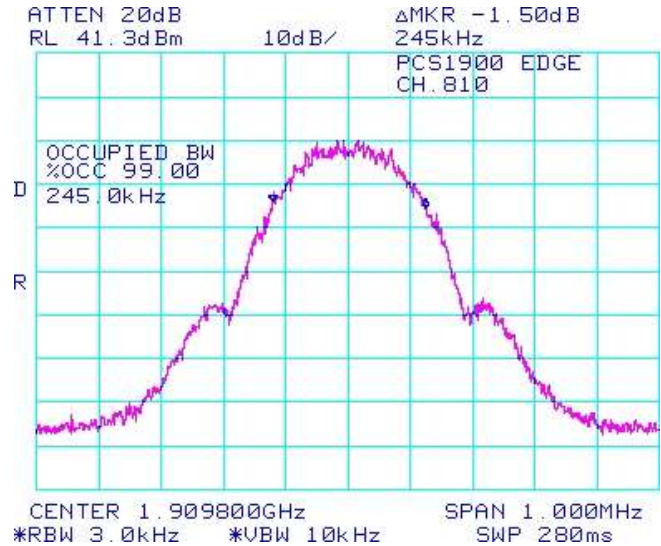

Figure 1-35a: GSM850 Band, Low Channel Mask in EDGE mode

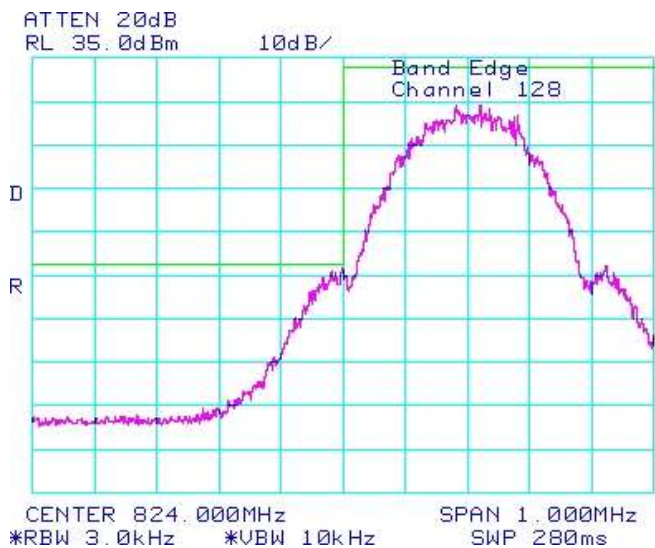
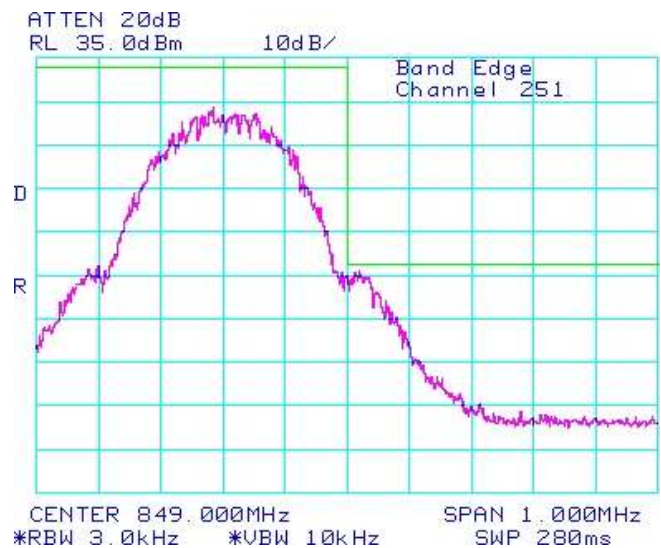



Figure 1-36a: GSM850 Band, High Channel Mask in EDGE mode



	EMI Test Report for the BlackBerry® smartphone Model RDD71UW, RDC71UW APPENDIX 1A	
	Test Report No. RTS-2579-1107-62A	Dates of Test June 14 to July 11, 2011

GSM Conducted RF Emission Test Data cont'd

Figure 1-37a: PCS1900 Band, Low Channel Mask in EDGE mode

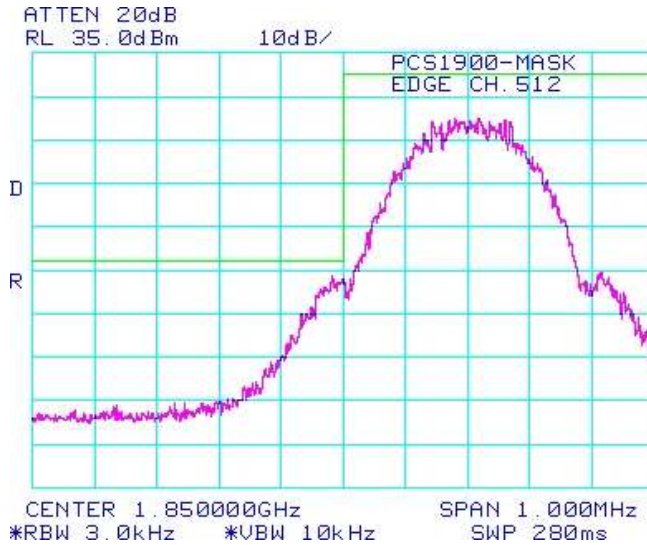
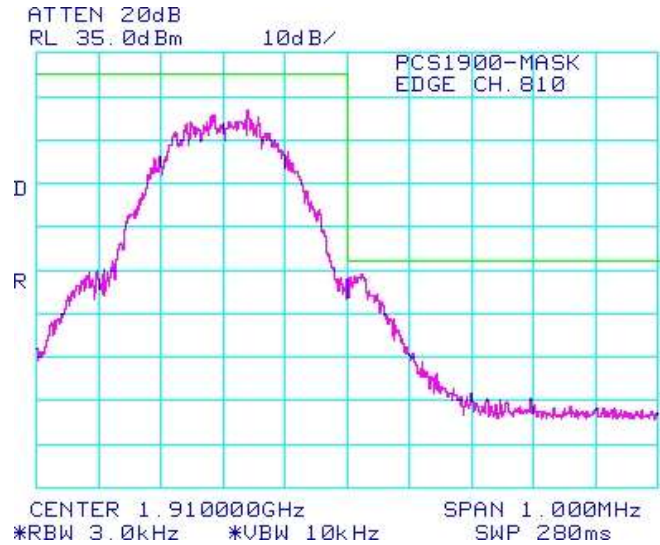



Figure 1-38a: PCS1900 Band, High Channel Mask in EDGE mode



	EMI Test Report for the BlackBerry® smartphone Model RDD71UW, RDC71UW	
	APPENDIX 1A	
Test Report No. RTS-2579-1107-62A	Dates of Test June 14 to July 11, 2011	FCC ID: L6ARDD70UW, L6ARDC70UW IC: 2503A-RDD70UW, 2503A-RDC70UW

GSM Conducted RF Emission Test Data cont'd

Figure 1-39a: GSM850 band, Spurious Conducted Emissions, Low channel in Edge Mode

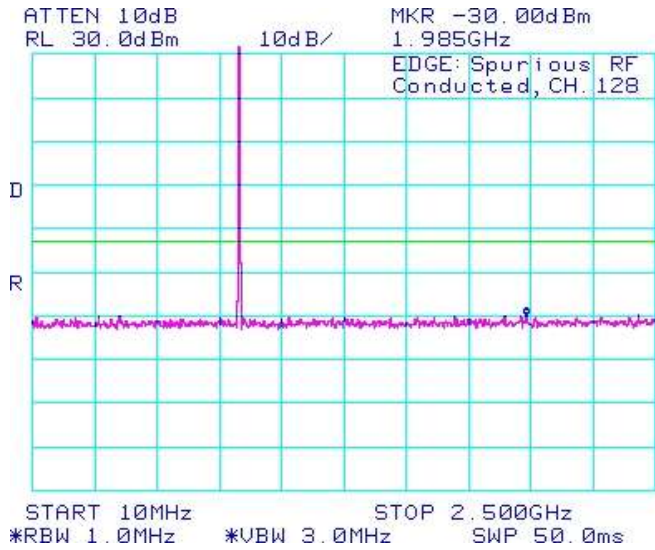

Figure 1-40a: GSM850 band, Spurious Conducted Emissions, Low channel in Edge Mode

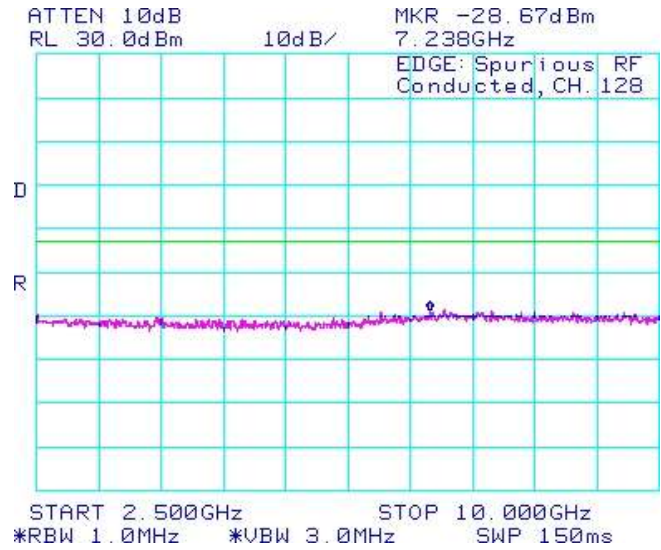

Figure 1-41a: GSM850 band, Spurious Conducted Emissions, Middle channel in Edge Mode

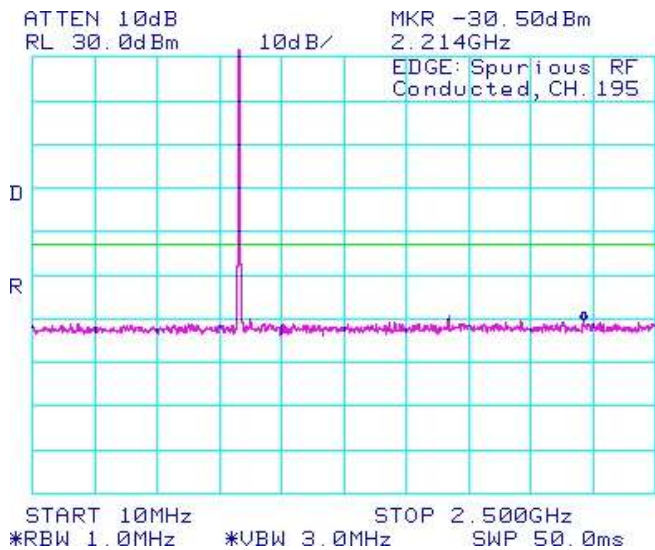
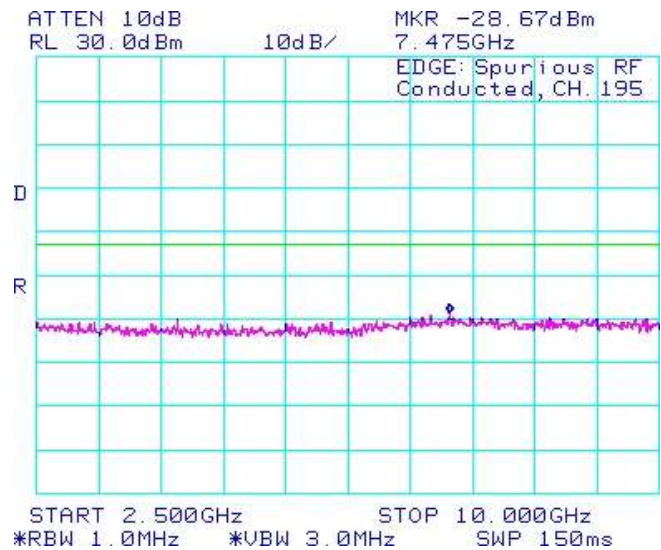



Figure 1-42a: GSM850 band, Spurious Conducted Emissions, Middle channel in Edge Mode



	EMI Test Report for the BlackBerry® smartphone Model RDD71UW, RDC71UW	
	APPENDIX 1A	
Test Report No. RTS-2579-1107-62A	Dates of Test June 14 to July 11, 2011	FCC ID: L6ARDD70UW, L6ARDC70UW IC: 2503A-RDD70UW, 2503A-RDC70UW

GSM Conducted RF Emission Test Data cont'd

Figure 1-43a: GSM850 band, Spurious Conducted Emissions, High channel in Edge Mode

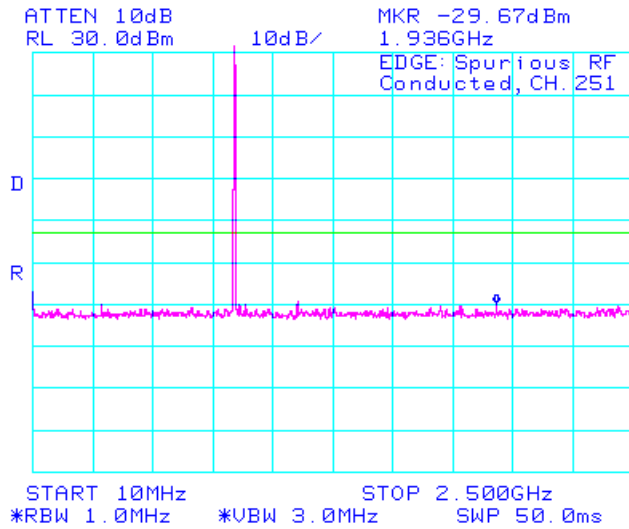

Figure 1-44a: GSM850 band, Spurious Conducted Emissions, High channel in Edge Mode

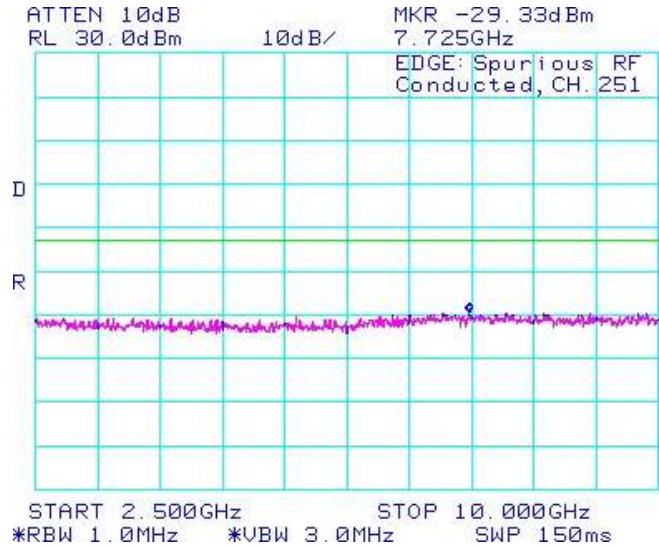

Figure 1-45a: PCS1900 band, Spurious Conducted Emissions, Low channel in Edge Mode

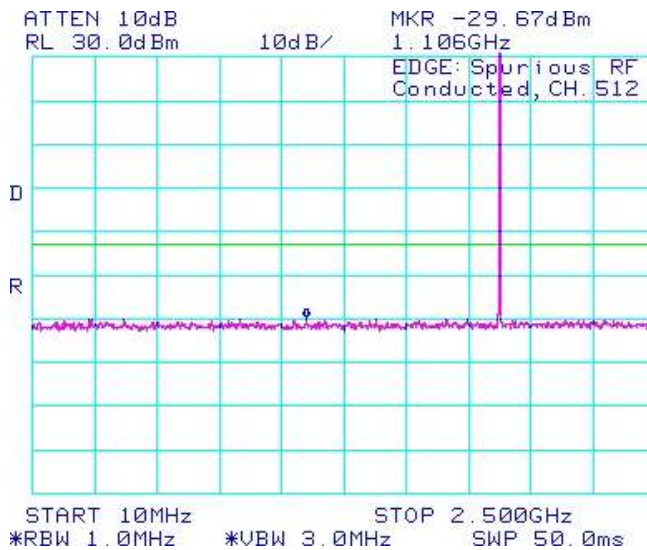
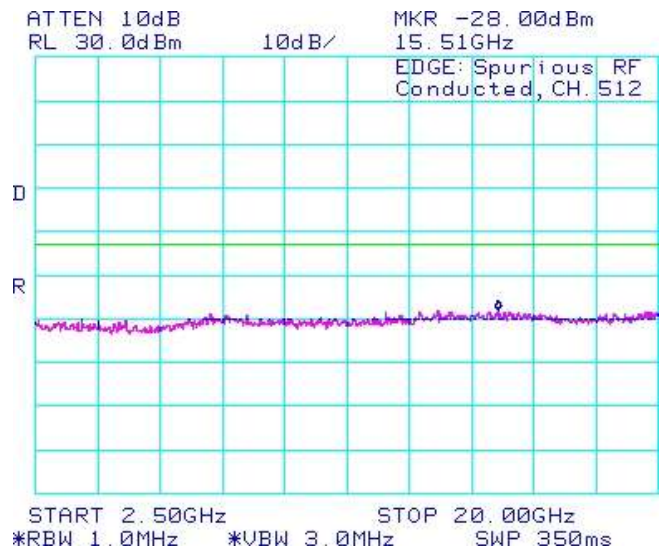



Figure 1-46a: PCS1900 band, Spurious Conducted Emissions, Low channel in Edge Mode



	EMI Test Report for the BlackBerry® smartphone Model RDD71UW, RDC71UW	
	APPENDIX 1A	
Test Report No. RTS-2579-1107-62A	Dates of Test June 14 to July 11, 2011	FCC ID: L6ARDD70UW, L6ARDC70UW IC: 2503A-RDD70UW, 2503A-RDC70UW

GSM Conducted RF Emission Test Data cont'd

Figure 1-47a: PCS1900 band, Spurious Conducted Emissions, Middle channel in Edge Mode

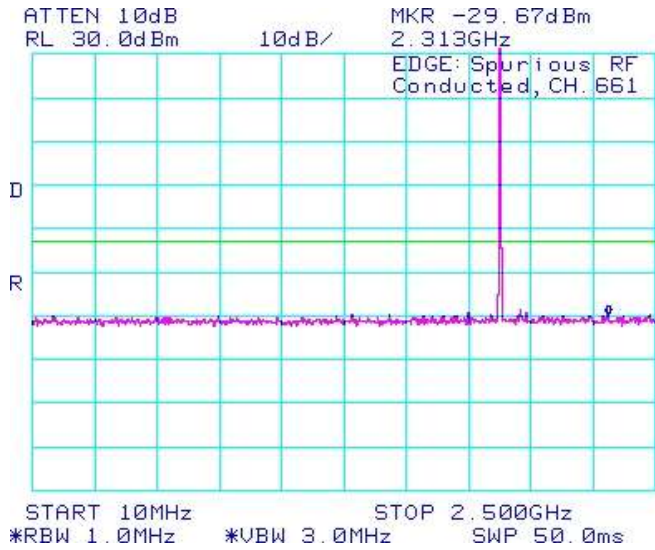

Figure 1-48a: PCS1900 band, Spurious Conducted Emissions, Middle channel in Edge Mode

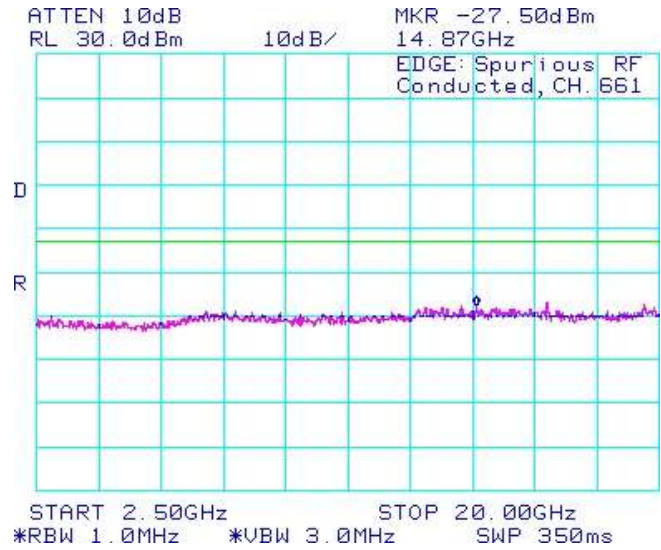

Figure 1-49a: PCS1900 band, Spurious Conducted Emissions, High channel in Edge Mode

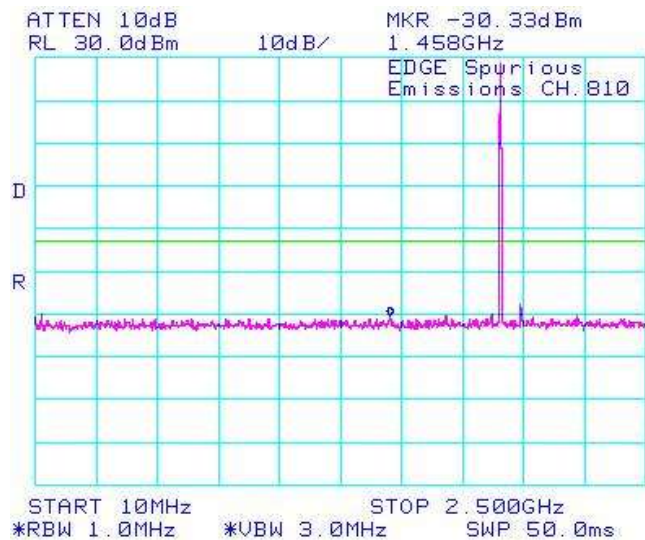
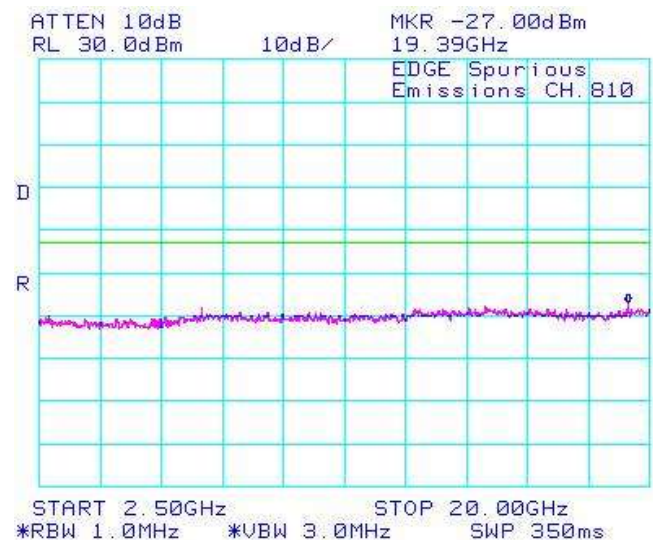



Figure 1-50a: PCS1900 band, Spurious Conducted Emissions, High channel in Edge Mode



APPENDIX 1B – UMTS 4 CONDUCTED RF EMISSIONS TEST DATA/PLOTS

	EMI Test Report for the BlackBerry® smartphone Model RDD71UW, RDC71UW APPENDIX 1B	
	Test Report No. RTS-2579-1107-62A	Dates of Test June 14 to July 11, 2011

UMTS Conducted RF Emission Test Data cont'd

The conducted spurious emissions – As per 47 CFR 2.1051, CFR 24.238(a), CFR 4.202, CFR 22 Subpart H, RSS-132 and RSS - 133 were measured from 10 MHz to 20 GHz.

See figures 1-1c to 1-11c for the plots of the conducted spurious emissions.

Date of Test: May 12, 2011

Test Data UMTS Band 4 selected Frequencies in Call mode

UMTS band 4 Frequency (MHz)	26dBc Occupied Bandwidth (MHz)	99% Occupied Bandwidth (MHz)
1712.400	4.733	4.192
1732.600	4.725	4.200
1752.600	4.700	4.183

Test Data for UMTS band 4 selected Frequencies in Call mode

Refer to the following measurement plots for more detail.

See Figures 1-1c to 1-6c for the plots of the conducted spurious emissions.

See Figures 1-7c to 1-9c for the plots of 99% Occupied Bandwidth.

See Figures 1-10c to 1-11c for the plots of the Channel mask.

The RF power output was at maximum for all the recorded measurements shown below.

Test Report No.
 RTS-2579-1107-62A

Dates of Test
 June 14 to July 11, 2011

FCC ID: L6ARDD70UW, L6ARDC70UW
IC: 2503A-RDD70UW, 2503A-RDC70UW

UMTS Conducted RF Emission Test Data cont'd

Figure 1-1c: Band 4, Spurious Conducted Emissions, Low channel

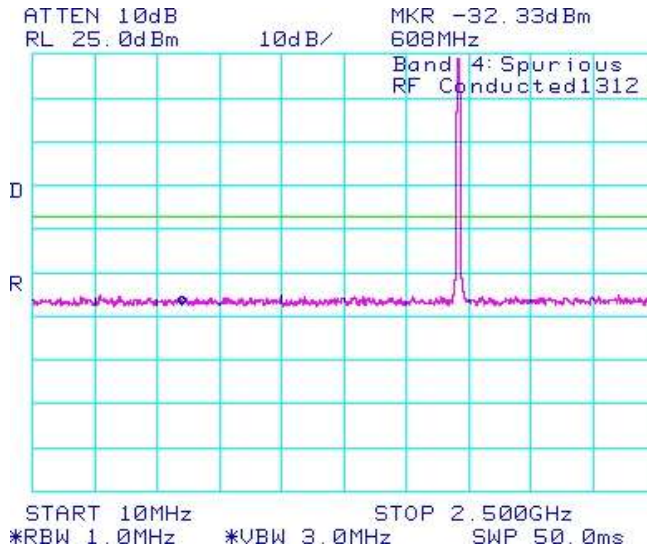

Figure 1-2c: Band 4, Spurious Conducted Emissions, Low channel

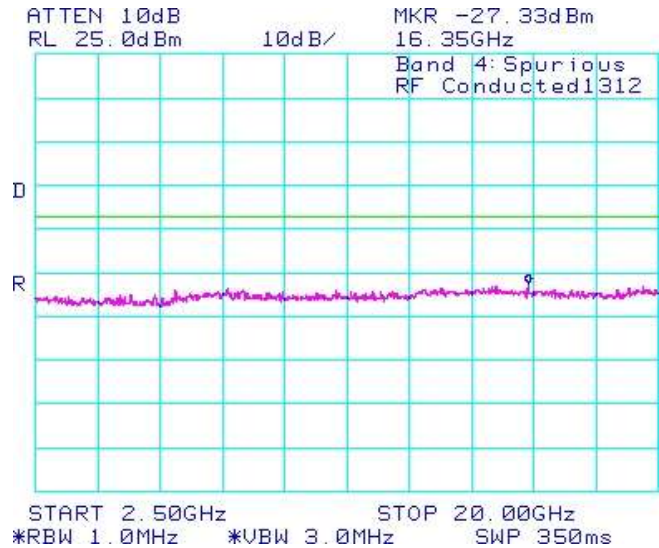

Figure 1-3c: Band 4, Spurious Conducted Emissions, Middle channel

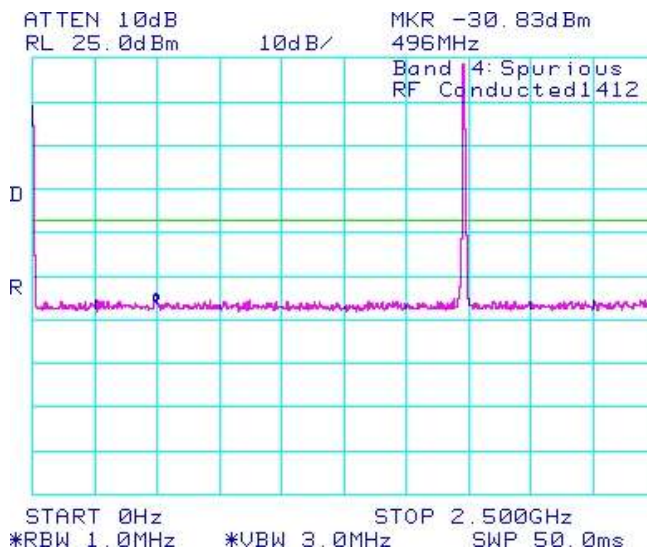
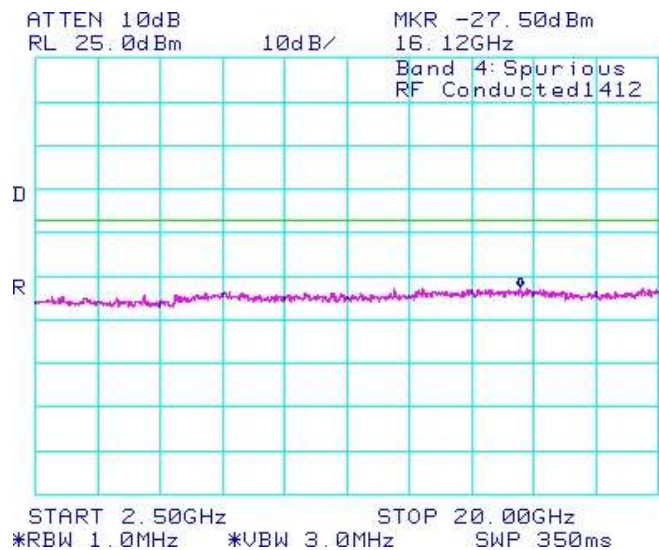

Figure 1-4c: Band 4, Spurious Conducted Emissions, Middle channel



Test Report No.
RTS-2579-1107-62A

Dates of Test
June 14 to July 11, 2011

FCC ID: L6ARDD70UW, L6ARDC70UW
IC: 2503A-RDD70UW, 2503A-RDC70UW

UMTS Conducted RF Emission Test Data cont'd

Figure 1-5c: Band 4, Spurious Conducted Emissions, High channel

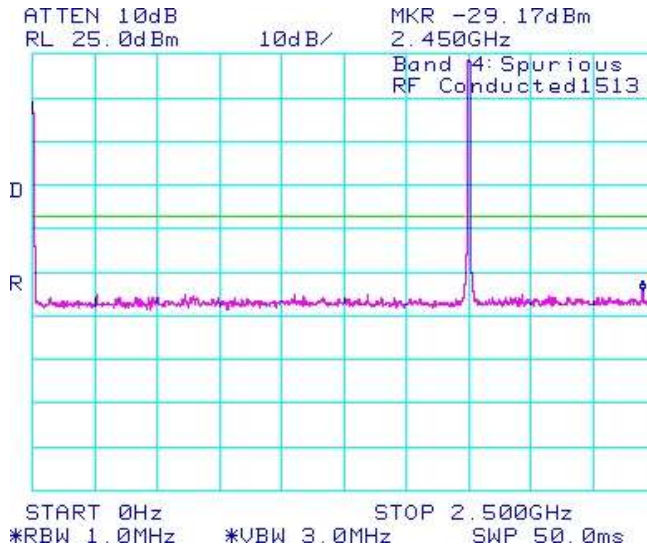

Figure 1-6c: Band 4, Spurious Conducted Emissions, High channel

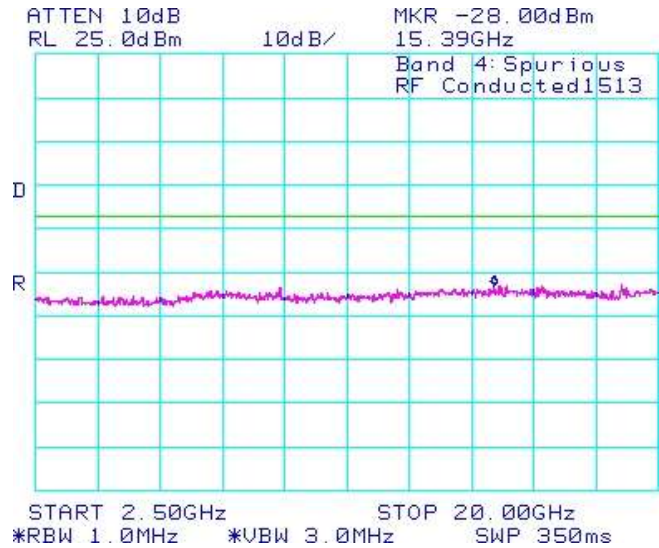

Figure 1-7c: Occupied Bandwidth, Band 4 Low Channel

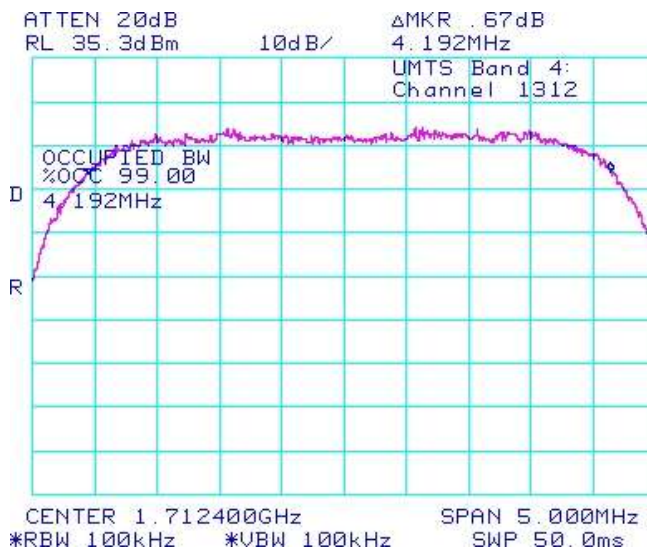
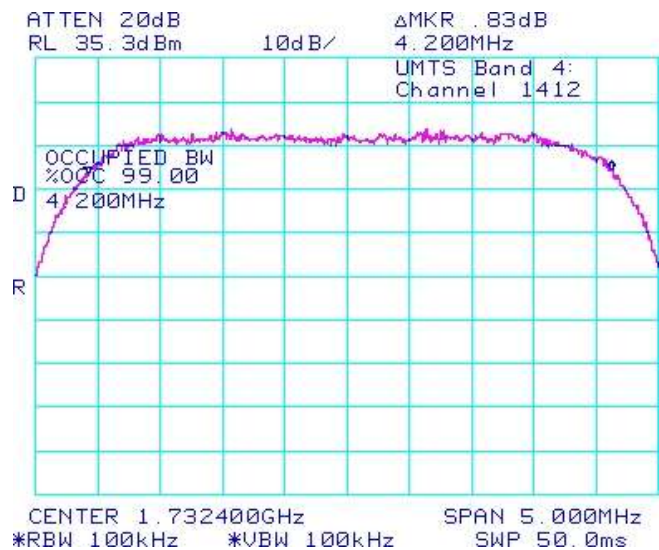

Figure 1-8c: Occupied Bandwidth, Band 4 Middle Channel



Test Report No.
 RTS-2579-1107-62A

Dates of Test
 June 14 to July 11, 2011

FCC ID: L6ARDD70UW, L6ARDC70UW
IC: 2503A-RDD70UW, 2503A-RDC70UW

UMTS Conducted RF Emission Test Data cont'd

Figure 1-9c: Occupied Bandwidth, Band 4 High Channel

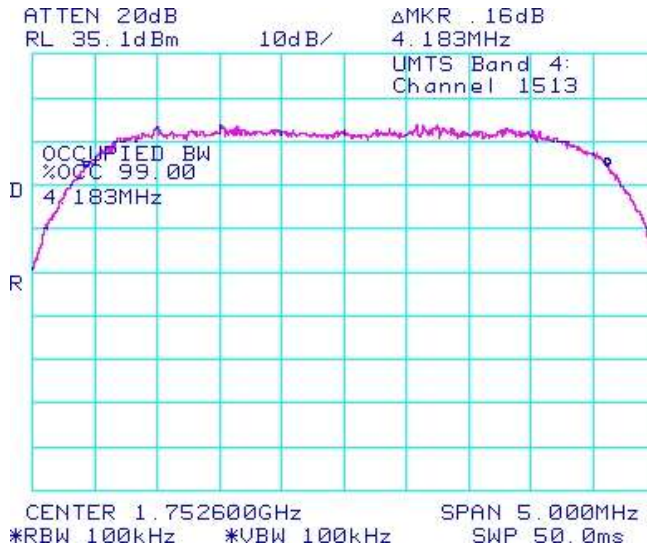

Figure 1-10c: Band 4 Low Channel Mask

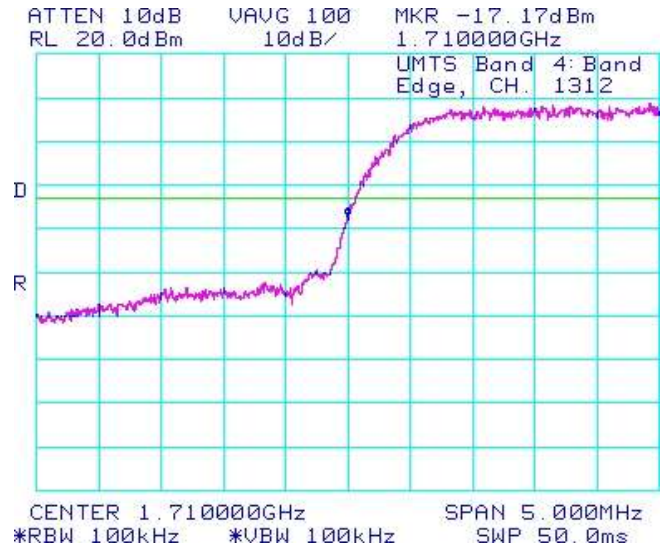
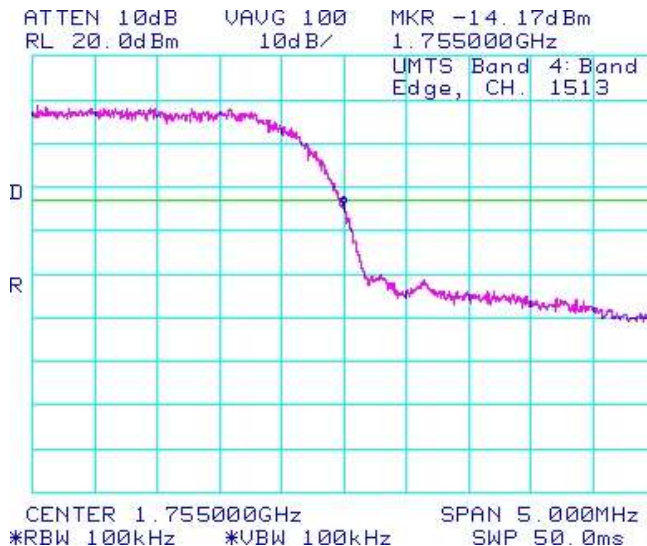

Figure 1-11c: Band 4 High Channel Mask



Test Report No.
 RTS-2579-1107-62A

Dates of Test
 June 14 to July 11, 2011

FCC ID: L6ARDD70UW, L6ARDC70UW
IC: 2503A-RDD70UW, 2503A-RDC70UW

UMTS Conducted RF Emission Test Data cont'd

Figure 1-12c: Band 4 , Spurious Conducted Emissions, Low channel

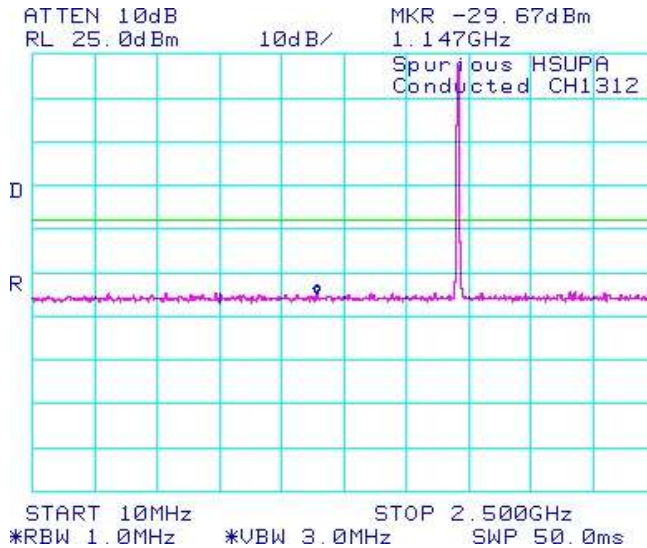

Figure 1-13c: Band 4 , Spurious Conducted Emissions, Low channel

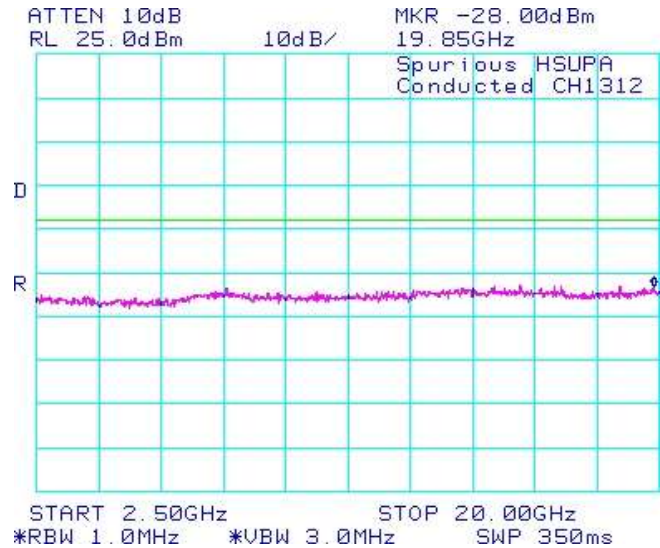

Figure 1-14c: Band 4 , Spurious Conducted Emissions, Middle channel

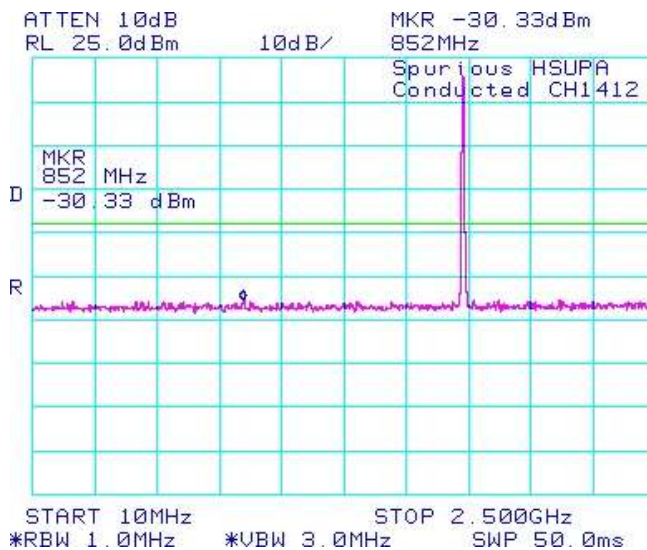
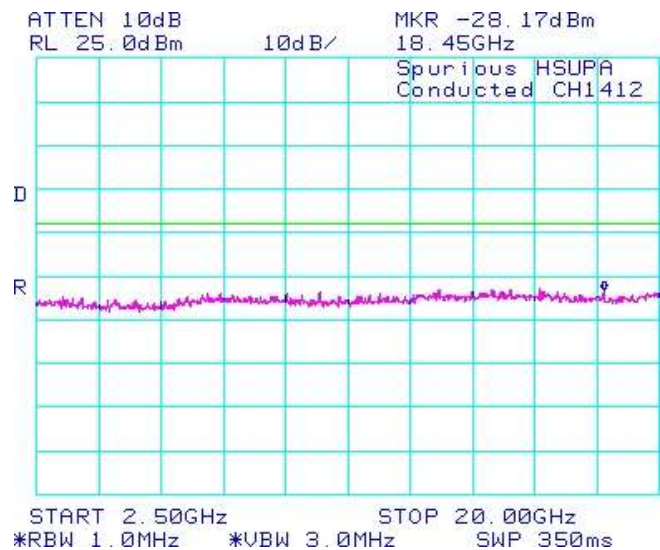



Figure 1-15c: Band 4 , Spurious Conducted Emissions, Middle channel



	EMI Test Report for the BlackBerry® smartphone Model RDD71UW, RDC71UW APPENDIX 1B	
	Test Report No. RTS-2579-1107-62A	Dates of Test June 14 to July 11, 2011

UMTS Conducted RF Emission Test Data cont'd

Figure 1-16c: Band 4 , Spurious Conducted Emissions, High Channel

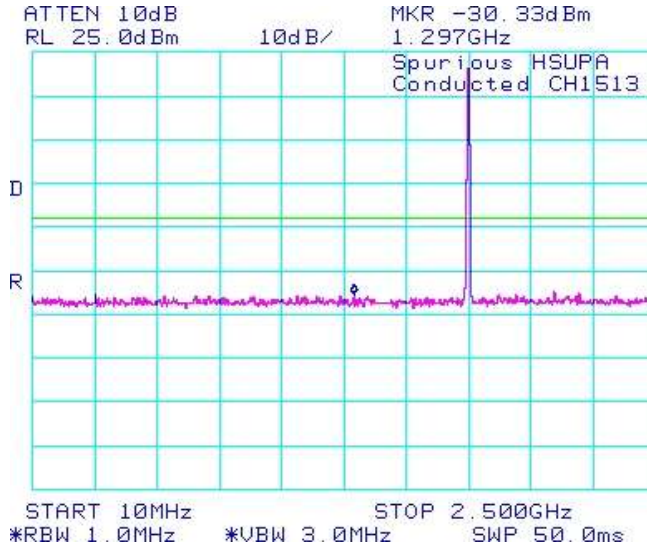

Figure 1-17c: Band 4 , Spurious Conducted Emissions, High Channel

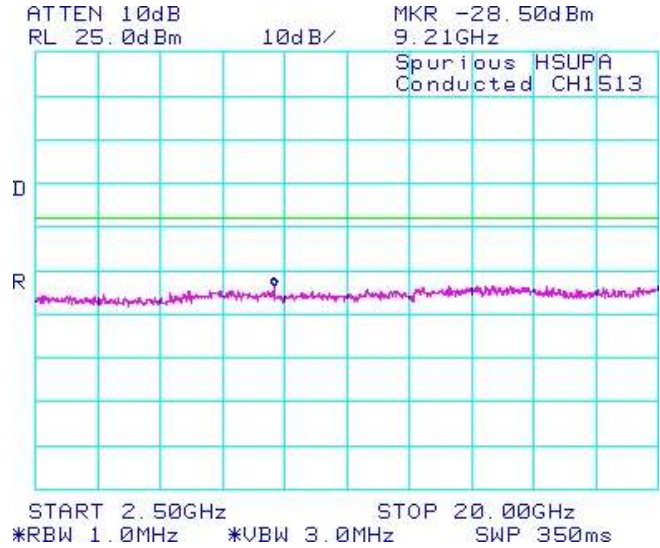

Figure 1-18c: Occupied Bandwidth, Band 4 Low Channel

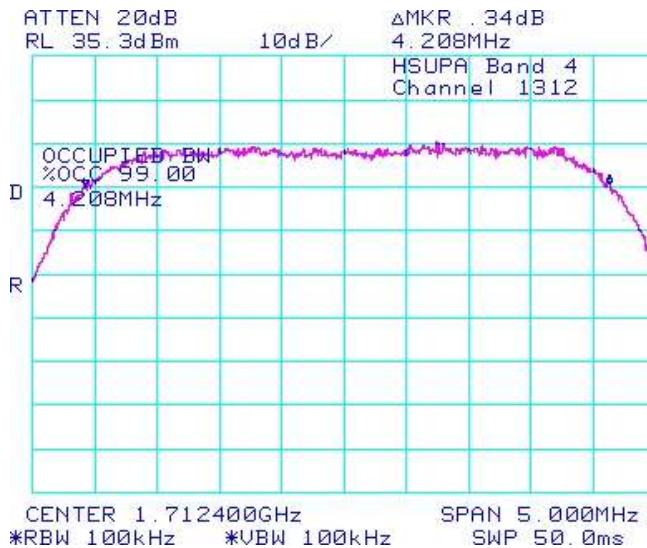
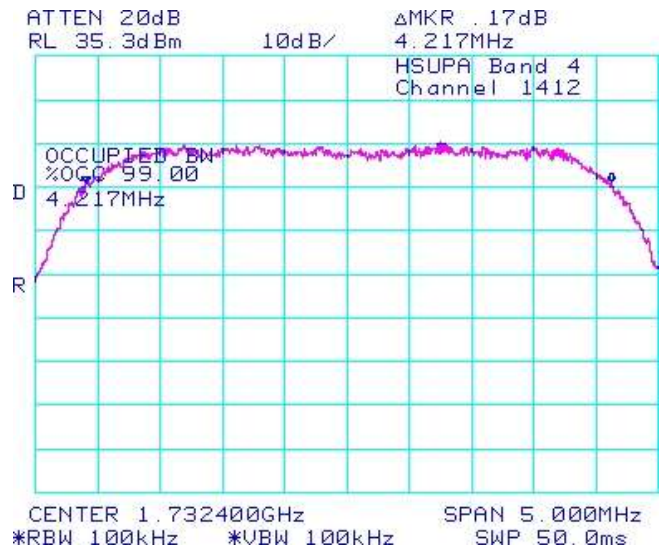

Figure 1-19c: Occupied Bandwidth, Band 4 Middle Channel



UMTS Conducted RF Emission Test Data cont'd

Test Report No.
 RTS-2579-1107-62A

Dates of Test
 June 14 to July 11, 2011

FCC ID: L6ARDD70UW, L6ARDC70UW
IC: 2503A-RDD70UW, 2503A-RDC70UW

Figure 1-20c: Occupied Bandwidth, Band 4 High Channel

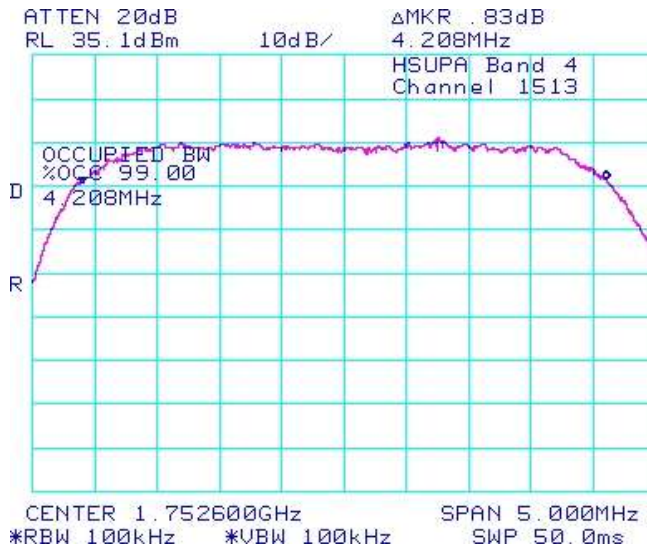

Figure 1-21c: Band 4, Low Channel Mask

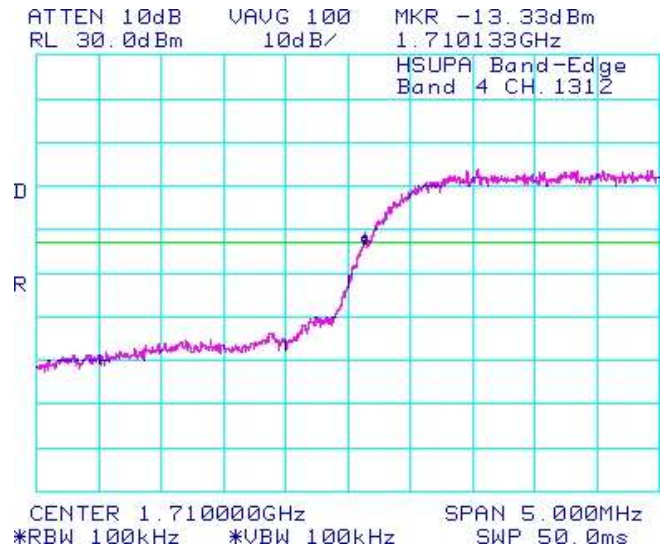
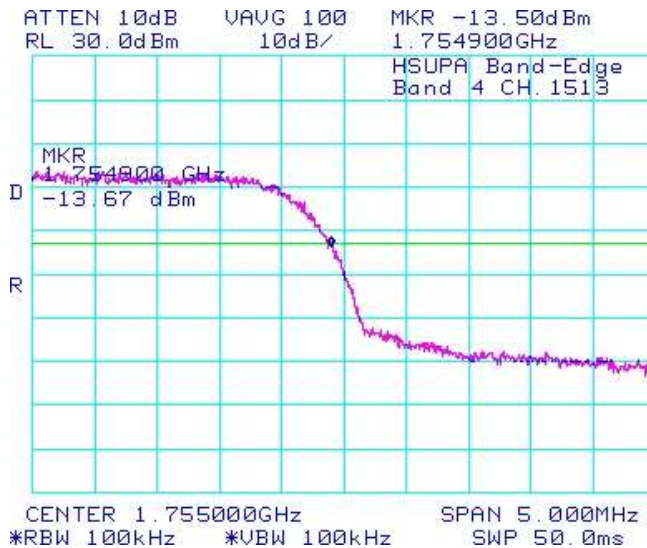



Figure 1-22c: Band 4, High Channel Mask



APPENDIX 2A – GSM CONDUCTED RF OUTPUT POWER TEST DATA

APPENDIX 2B – UMTS 4 CONDUCTED RF OUTPUT POWER TEST DATA

APPENDIX 3A – GSM FREQUENCY STABILITY TEST DATA

	EMI Test Report for the BlackBerry® smartphone Model RDD71UW, RDC71UW APPENDIX 3A	
	Test Report No. RTS-2579-1107-62A	Dates of Test June 14 to July 11, 2011

GSM Frequency Stability Test Data

The following test configurations were measured for model RDD71UW:

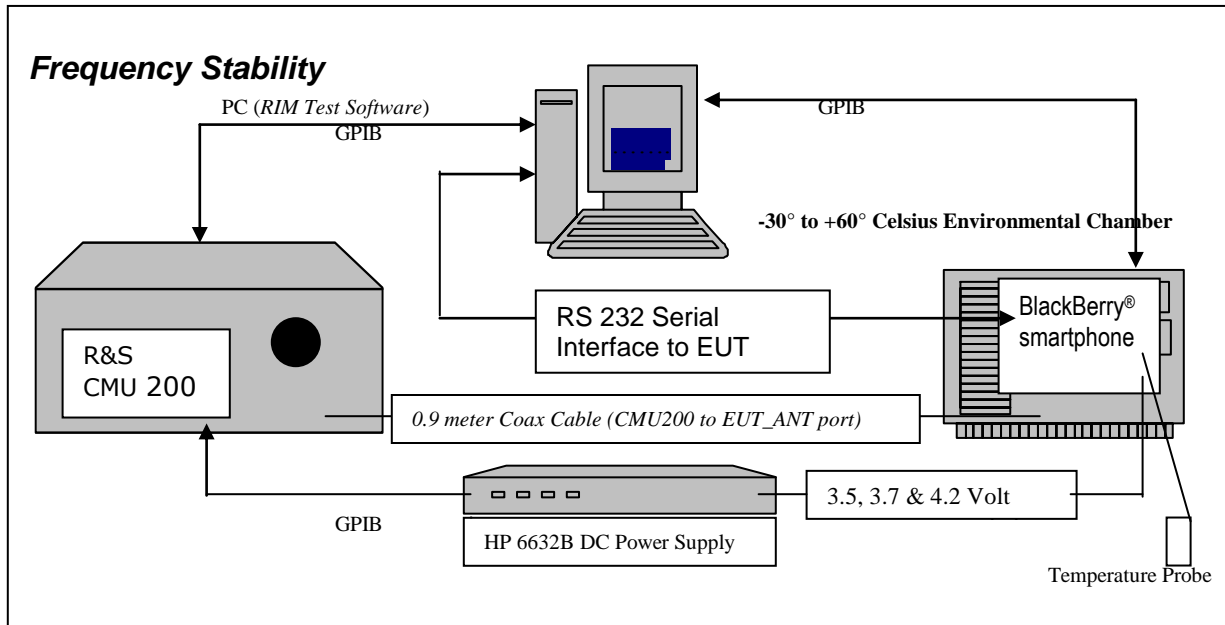

The measurements were performed by Maurice Battler.

CFR 47 Chapter 1 - Federal Communications Commission Rules

Part 2 Required Measurements

2.995 Frequency Stability - Procedures

(a,b) Frequency Stability - Temperature Variation

(d) Frequency Stability - Voltage Variation

24.235/22.917 Frequency Stability.

The frequency stability shall be sufficient to ensure that the fundamental emission stays within the authorized frequency block.

The EUT meets the requirements as stated in CFR 47 chapter 1, Section 24.235, CFR 47 chapter 1, Section 22.917 RSS-132, 4.3 Frequency Stability, and RSS-133, 6.3 Frequency Stability.

Frequency Stability measurement devices were configured as presented in the block diagram recording frequency, power, data, temperatures, and stepped voltages controlled via a GPIB interface linked to the Environmental chamber, a DC power supply, and the Communications Test Set. A 0.9-metre coax cable was calibrated to characterize the insertion loss for the transmitted frequencies between the RF input/output of the CMU 200 and the EUT antenna port.

Calibration for the Cable Loss was performed in the RF Laboratory using the Agilent power meter and Agilent Signal Generator.

This report shall **NOT** be reproduced except in full without the written consent of RIM Testing Services
- A division of Research in Motion Limited.

	EMI Test Report for the BlackBerry® smartphone Model RDD71UW, RDC71UW	
	APPENDIX 3A	
Test Report No. RTS-2579-1107-62A	Dates of Test June 14 to July 11, 2011	FCC ID: L6ARDD70UW, L6ARDC70UW IC: 2503A-RDD70UW, 2503A-RDC70UW

Procedure:

The EUT was placed in the Temperature chamber and connected to CMU 200 outside as shown in the figure above. Dry air was pumped inside the temperature chamber to maintain a backpressure during the test. The EUT was kept in the off condition at all times except when the measurements were to be made.

The chamber was switched on and the temperature was set to -30°C. After the chamber stabilized at -30 °C there was a soak period of one hour to alleviate moisture in the chamber, the EUT voltage was enabled. The system software recorded the frequency, power, and associated measurements.

A Computer system controlled the automated software. This application was given the command of activating all machines intrinsic to the temperature and voltage tests controlling the CMU 200 via the GPIB Bus. The Environmental Chamber was instructed through an RS-232 serial line. The EUT dialogue was passed through a serial connection.

The EUT repetitively transmitted 100 bursts for each set of programmed parameters recording temperature, voltage settings, and systematically selected frequencies. The power supply was cycled from minimum voltage 3.6 volts, to 3.7 volts to 4.2 volts maximum voltage. The frequency error was measured at a maximum output power and recorded by the automated system test software.

The EUT output power and frequency was measured at 3.6 volts, 3.7 volts and 4.2 volts. The transmit frequency was varied in 3 steps consisting of 824.2, 836.4, and 848.8 MHz for the GSM850 band, 1850.2, 1880.0 and 1909.8 MHz for the PCS1900 band. This frequency was recorded in MHz and deviation from nominal, in Parts Per Million. After the initial one-hour soak at the beginning of the tests, a period of thirty minutes soak was initialized between each ascending temperature step, before proceeding to the next measurement test cycle.

	EMI Test Report for the BlackBerry® smartphone Model RDD71UW, RDC71UW	
	APPENDIX 3A	
Test Report No. RTS-2579-1107-62A	Dates of Test June 14 to July 11, 2011	FCC ID: L6ARDD70UW, L6ARDC70UW IC: 2503A-RDD70UW, 2503A-RDC70UW

PROCEDURE:

The test system software for commencing the Frequency Stability Tests carried through the following cycle.

1. Switch on the HP 6632B power supply; CMU 200 Communications test Set, and Environmental Chamber.
2. Start test program
3. Set the Temperature to -30°C and maintain a period of one- hour soak time, with the EUT supply voltage disabled.
4. Set power supply voltage to 3.6 volts.
5. Set up CMU 200 Radio Communication Tester.
6. Command the CMU 200 to switch to the low channel.
7. Enable the voltage to the EUT, and connect a link to the CMU 200 test set.
8. EUT is commanded to Transmit 100 Bursts.
9. Software logs the following data from the CMU 200, power supply and temperature chamber: Traffic Channel Number, Traffic Channel Frequency, Power Level, Chamber Temperature, Supply Voltage, Power and Frequency Error.
10. The CMU 200 commands the EUT to change frequency to the middle channel and high channel and repeats steps 7 to 9.
11. Repeat steps 5 to 10 changing the supply voltage to 3.7 Volts
12. Increase temperature by 10°C and soak for 1/2 hour.
13. Repeat steps 4 - 12 for temperatures -30°C to 60°C .
14. Repeat steps 5 to 10 changing the supply voltage to 4.2 volts

Procedure 5 to 10 was repeated at room temperature (20°C) with the power supply voltage set to 3.6, 3.7 and 4.2 volts.

The maximum frequency error in the GSM850 band measured was **0.3051PPM**.
The maximum frequency error in the PCS1900 band measured was **0.0429PPM**.

Test Report No.
RTS-2579-1107-62A

Dates of Test
June 14 to July 11, 2011

FCC ID: L6ARDD70UW, L6ARDC70UW
IC: 2503A-RDD70UW, 2503A-RDC70UW

GSM850 Channel results: channels 128, 189 and 251 @ 20°C maximum transmitted power

Traffic Channel Number	GSM850 Frequency (MHz)	Voltage (Volts)	Temperature (Celsius)	Frequency Error (Hz)	PPM
128	824.20	3.6	20	18	0.0218
189	836.40	3.6	20	20	0.0239
251	848.60	3.6	20	13	0.0153

Traffic Channel Number	GSM850 Frequency (MHz)	Voltage (Volts)	Temperature (Celsius)	Frequency Error (Hz)	PPM
128	824.20	3.7	20	10	0.0121
189	836.40	3.7	20	13	0.0155
251	848.60	3.7	20	6	0.0071

Traffic Channel Number	GSM850 Frequency (MHz)	Voltage (Volts)	Temperature (Celsius)	Frequency Error (Hz)	PPM
128	824.20	4.2	20	7	0.0085
189	836.40	4.2	20	10	0.0120
251	848.60	4.2	20	-4	-0.0047



Test Report No. RTS-2579-1107-62A	Dates of Test June 14 to July 11, 2011	FCC ID: L6ARDD70UW, L6ARDC70UW IC: 2503A-RDD70UW, 2503A-RDC70UW
---	--	--

GSM850 Results: channel 128 @ maximum transmitted power

Traffic Channel Number	Frequency (MHz)	Voltage (Volts)	Temperature (Celsius)	Frequency Error (Hz)	PPM
128	824.20	3.6	-30	33	0.0400
128	824.20	3.6	-20	39	0.0473
128	824.20	3.6	-10	26	0.0315
128	824.20	3.6	0	35	-0.0352
128	824.20	3.6	10	30	0.0364
128	824.20	3.6	20	18	0.0218
128	824.20	3.6	30	-13	-0.0158
128	824.20	3.6	40	-6	-0.0073
128	824.20	3.6	50	-13	-0.0158
128	824.20	3.6	60	-29	0.0643

Traffic Channel Number	Frequency (MHz)	Voltage (Volts)	Temperature (Celsius)	Frequency Error (Hz)	PPM
128	824.20	3.7	-30	39	0.0473
128	824.20	3.7	-20	49	0.0595
128	824.20	3.7	-10	20	0.0243
128	824.20	3.7	0	33	0.0400
128	824.20	3.7	10	29	0.0352
128	824.20	3.7	20	10	0.0121
128	824.20	3.7	30	-21	-0.0255
128	824.20	3.7	40	-16	-0.0194
128	824.20	3.7	50	-19	-0.0231
128	824.20	3.7	60	-39	0.0667

Traffic Channel Number	Frequency (MHz)	Voltage (Volts)	Temperature (Celsius)	Frequency Error (Hz)	PPM
128	824.20	4.2	-30	44	0.0534
128	824.20	4.2	-20	55	0.0667
128	824.20	4.2	-10	21	0.0255
128	824.20	4.2	0	39	0.0473
128	824.20	4.2	10	33	0.0400
128	824.20	4.2	20	7	0.0085
128	824.20	4.2	30	-27	-0.0328
128	824.20	4.2	40	-25	-0.0303
128	824.20	4.2	50	-35	-0.0425
128	824.20	4.2	60	-11	0.0643

Test Report No. RTS-2579-1107-62A	Dates of Test June 14 to July 11, 2011	FCC ID: L6ARDD70UW, L6ARDC70UW IC: 2503A-RDD70UW, 2503A-RDC70UW
---	--	--

GSM850 Results: channel 189 @ maximum transmitted power

Traffic Channel Number	Frequency (MHz)	Voltage (Volts)	Temperature (Celsius)	Frequency Error (Hz)	PPM
189	836.40	3.6	-30	19	0.0227
189	836.40	3.6	-20	53	0.0634
189	836.40	3.6	-10	41	0.0490
189	836.40	3.6	0	22	-0.0335
189	836.40	3.6	10	10	0.0120
189	836.40	3.6	20	20	0.0239
189	836.40	3.6	30	-21	-0.0251
189	836.40	3.6	40	-22	-0.0263
189	836.40	3.6	50	12	0.0143
189	836.40	3.6	60	-28	-0.0335

Traffic Channel Number	Frequency (MHz)	Voltage (Volts)	Temperature (Celsius)	Frequency Error (Hz)	PPM
189	836.40	3.7	-30	61	0.0729
189	836.40	3.7	-20	45	0.0538
189	836.40	3.7	-10	38	0.0454
189	836.40	3.7	0	15	0.0179
189	836.40	3.7	10	56	0.0670
189	836.40	3.7	20	13	0.0155
189	836.40	3.7	30	-25	-0.0299
189	836.40	3.7	40	-26	-0.0311
189	836.40	3.7	50	-43	-0.0514
189	836.40	3.7	60	-32	-0.0383

Traffic Channel Number	Frequency (MHz)	Voltage (Volts)	Temperature (Celsius)	Frequency Error (Hz)	PPM
189	836.40	4.2	-30	34	0.0407
189	836.40	4.2	-20	31	0.0371
189	836.40	4.2	-10	32	0.0383
189	836.40	4.2	0	49	0.0586
189	836.40	4.2	10	46	0.0550
189	836.40	4.2	20	10	0.0120
189	836.40	4.2	30	-28	-0.0335
189	836.40	4.2	40	-28	-0.0335
189	836.40	4.2	50	-42	-0.0502
189	836.40	4.2	60	-30	-0.0359

Test Report No. RTS-2579-1107-62A	Dates of Test June 14 to July 11, 2011	FCC ID: L6ARDD70UW, L6ARDC70UW IC: 2503A-RDD70UW, 2503A-RDC70UW
---	--	--

GSM850 Results: channel 251 @ maximum transmitted power

Traffic Channel Number	Frequency (MHz)	Voltage (Volts)	Temperature (Celsius)	Frequency Error (Hz)	PPM
251	848.8	3.6	-30	21	0.0247
251	848.8	3.6	-20	52	0.0613
251	848.8	3.6	-10	33	0.0389
251	848.8	3.6	0	21	-0.0424
251	848.8	3.6	10	9	0.0106
251	848.8	3.6	20	13	0.0153
251	848.8	3.6	30	-29	-0.0342
251	848.8	3.6	40	-30	-0.0353
251	848.8	3.6	50	-6	-0.0071
251	848.8	3.6	60	-36	-0.0424

Traffic Channel Number	Frequency (MHz)	Voltage (Volts)	Temperature (Celsius)	Frequency Error (Hz)	PPM
251	848.8	3.7	-30	30	0.0353
251	848.8	3.7	-20	55	0.0648
251	848.8	3.7	-10	25	0.0295
251	848.8	3.7	0	21	0.0247
251	848.8	3.7	10	7	0.0082
251	848.8	3.7	20	6	0.0071
251	848.8	3.7	30	-34	-0.0401
251	848.8	3.7	40	-39	-0.0459
251	848.8	3.7	50	-12	-0.0141
251	848.8	3.7	60	-46	-0.0542

Traffic Channel Number	Frequency (MHz)	Voltage (Volts)	Temperature (Celsius)	Frequency Error (Hz)	PPM
251	848.8	4.2	-30	35	0.0412
251	848.8	4.2	-20	15	0.0177
251	848.8	4.2	-10	27	0.0318
251	848.8	4.2	0	259	0.3051
251	848.8	4.2	10	12	0.0141
251	848.8	4.2	20	-4	-0.0047
251	848.8	4.2	30	-39	-0.0459
251	848.8	4.2	40	-44	-0.0518
251	848.8	4.2	50	-19	-0.0224
251	848.8	4.2	60	-14	-0.0165

Test Report No. RTS-2579-1107-62A	Dates of Test June 14 to July 11, 2011	FCC ID: L6ARDD70UW, L6ARDC70UW IC: 2503A-RDD70UW, 2503A-RDC70UW
---	--	--

PCS Channel results: channels 512, 661, & 810 @ 20°C maximum transmitted power

Traffic Channel Number	PCS Frequency (MHz)	Voltage (Volts)	Temperature (Celsius)	Frequency Error (Hz)	PPM
512	1850.20	3.6	20	-35	-0.0189
661	1880.00	3.6	20	-29	-0.0154
810	1909.80	3.6	20	-34	-0.0178

Traffic Channel Number	PCS Frequency (MHz)	Voltage (Volts)	Temperature (Celsius)	Frequency Error (Hz)	PPM
512	1850.20	3.7	20	-34	-0.0184
661	1880.00	3.7	20	-25	-0.0133
810	1909.80	3.7	20	-36	-0.0189

Traffic Channel Number	PCS Frequency (MHz)	Voltage (Volts)	Temperature (Celsius)	Frequency Error (Hz)	PPM
512	1850.20	4.2	20	-34	-0.0184
661	1880.00	4.2	20	-28	-0.0149
810	1909.80	4.2	20	-34	-0.0178

Test Report No.
RTS-2579-1107-62A

Dates of Test
June 14 to July 11, 2011

FCC ID: L6ARDD70UW, L6ARDC70UW
IC: 2503A-RDD70UW, 2503A-RDC70UW

PCS1900 Results: channel 512 @ maximum transmitted power

Traffic Channel Number	Frequency (MHz)	Voltage (Volts)	Temperature (Celsius)	Frequency Error (Hz)	PPM
512	1850.20	3.6	-30	-11	-0.0059
512	1850.20	3.6	-20	-38	-0.0205
512	1850.20	3.6	-10	33	0.0178
512	1850.20	3.6	0	20	-0.0297
512	1850.20	3.6	10	25	0.0135
512	1850.20	3.6	20	-35	-0.0189
512	1850.20	3.6	30	-37	-0.0200
512	1850.20	3.6	40	-47	-0.0254
512	1850.20	3.6	50	-73	-0.0395
512	1850.20	3.6	60	-55	-0.0297

Traffic Channel Number	Frequency (MHz)	Voltage (Volts)	Temperature (Celsius)	Frequency Error (Hz)	PPM
512	1850.20	3.7	-30	16	0.0086
512	1850.20	3.7	-20	-31	-0.0168
512	1850.20	3.7	-10	48	0.0259
512	1850.20	3.7	0	21	0.0114
512	1850.20	3.7	10	13	0.0070
512	1850.20	3.7	20	-34	-0.0184
512	1850.20	3.7	30	-40	-0.0216
512	1850.20	3.7	40	-53	-0.0286
512	1850.20	3.7	50	-30	-0.0162
512	1850.20	3.7	60	-71	-0.0384

Traffic Channel Number	Frequency (MHz)	Voltage (Volts)	Temperature (Celsius)	Frequency Error (Hz)	PPM
512	1850.20	4.2	-30	18	0.0097
512	1850.20	4.2	-20	-26	-0.0141
512	1850.20	4.2	-10	61	0.0330
512	1850.20	4.2	0	22	0.0119
512	1850.20	4.2	10	11	0.0059
512	1850.20	4.2	20	-34	-0.0184
512	1850.20	4.2	30	-44	-0.0238
512	1850.20	4.2	40	-63	-0.0341
512	1850.20	4.2	50	-50	-0.0270
512	1850.20	4.2	60	-40	-0.0216

Test Report No. RTS-2579-1107-62A	Dates of Test June 14 to July 11, 2011	FCC ID: L6ARDD70UW, L6ARDC70UW IC: 2503A-RDD70UW, 2503A-RDC70UW
---	--	--

PCS1900 Results: channel 661 @ maximum transmitted power

Traffic Channel Number	Frequency (MHz)	Voltage (Volts)	Temperature (Celsius)	Frequency Error (Hz)	PPM
661	1880.00	3.6	-30	14	0.0074
661	1880.00	3.6	-20	37	0.0197
661	1880.00	3.6	-10	20	0.0106
661	1880.00	3.6	0	36	-0.0362
661	1880.00	3.6	10	20	0.0106
661	1880.00	3.6	20	-29	-0.0154
661	1880.00	3.6	30	-60	-0.0319
661	1880.00	3.6	40	-42	-0.0223
661	1880.00	3.6	50	-44	-0.0234
661	1880.00	3.6	60	-68	-0.0362

Traffic Channel Number	Frequency (MHz)	Voltage (Volts)	Temperature (Celsius)	Frequency Error (Hz)	PPM
661	1880.00	3.7	-30	10	0.0053
661	1880.00	3.7	-20	32	0.0170
661	1880.00	3.7	-10	20	0.0106
661	1880.00	3.7	0	39	0.0207
661	1880.00	3.7	10	21	0.0112
661	1880.00	3.7	20	-25	-0.0133
661	1880.00	3.7	30	-53	-0.0282
661	1880.00	3.7	40	-37	-0.0197
661	1880.00	3.7	50	-30	-0.0160
661	1880.00	3.7	60	-55	-0.0293

Traffic Channel Number	Frequency (MHz)	Voltage (Volts)	Temperature (Celsius)	Frequency Error (Hz)	PPM
661	1880.00	4.2	-30	-12	-0.0064
661	1880.00	4.2	-20	17	0.0090
661	1880.00	4.2	-10	-14	-0.0074
661	1880.00	4.2	0	32	0.0170
661	1880.00	4.2	10	18	0.0096
661	1880.00	4.2	20	-28	-0.0149
661	1880.00	4.2	30	-49	-0.0261
661	1880.00	4.2	40	-71	-0.0378
661	1880.00	4.2	50	-72	-0.0383
661	1880.00	4.2	60	-80	-0.0426

Test Report No. RTS-2579-1107-62A	Dates of Test June 14 to July 11, 2011	FCC ID: L6ARDD70UW, L6ARDC70UW IC: 2503A-RDD70UW, 2503A-RDC70UW
---	--	--

PCS1900 Results: channel 810 @ maximum transmitted power

Traffic Channel Number	Frequency (MHz)	Voltage (Volts)	Temperature (Celsius)	Frequency Error (Hz)	20BPPM
810	1909.80	3.6	-30	14	0.0073
810	1909.80	3.6	-20	46	0.0241
810	1909.80	3.6	-10	22	0.0115
810	1909.80	3.6	0	32	-0.0429
810	1909.80	3.6	10	13	0.0068
810	1909.80	3.6	20	-34	-0.0178
810	1909.80	3.6	30	-67	-0.0351
810	1909.80	3.6	40	-55	-0.0288
810	1909.80	3.6	50	-57	-0.0298
810	1909.80	3.6	60	-82	-0.0429

Traffic Channel Number	Frequency (MHz)	Voltage (Volts)	Temperature (Celsius)	Frequency Error (Hz)	PPM
810	1909.80	3.7	-30	17	0.0089
810	1909.80	3.7	-20	58	0.0304
810	1909.80	3.7	-10	28	0.0147
810	1909.80	3.7	0	34	0.0178
810	1909.80	3.7	10	12	0.0063
810	1909.80	3.7	20	-36	-0.0189
810	1909.80	3.7	30	-69	-0.0361
810	1909.80	3.7	40	-58	-0.0304
810	1909.80	3.7	50	-71	-0.0372
810	1909.80	3.7	60	-33	-0.0173

Traffic Channel Number	Frequency (MHz)	Voltage (Volts)	Temperature (Celsius)	Frequency Error (Hz)	PPM
810	1909.80	4.2	-30	14	0.0073
810	1909.80	4.2	-20	60	0.0314
810	1909.80	4.2	-10	36	0.0189
810	1909.80	4.2	0	43	0.0225
810	1909.80	4.2	10	14	0.0073
810	1909.80	4.2	20	-34	-0.0178
810	1909.80	4.2	30	-72	-0.0377
810	1909.80	4.2	40	-64	-0.0335
810	1909.80	4.2	50	-79	-0.0414
810	1909.80	4.2	60	-53	-0.0278

APPENDIX 3B – UMTS 4 FREQUENCY STABILITY TEST DATA

	EMI Test Report for the BlackBerry® smartphone Model RDD71UW, RDC71UW APPENDIX 3B	
	Test Report No. RTS-2579-1107-62A	Dates of Test June 14 to July 11, 2011

UMTS Frequency Stability Test Data

The following test configurations were measured for model RDD71UW:

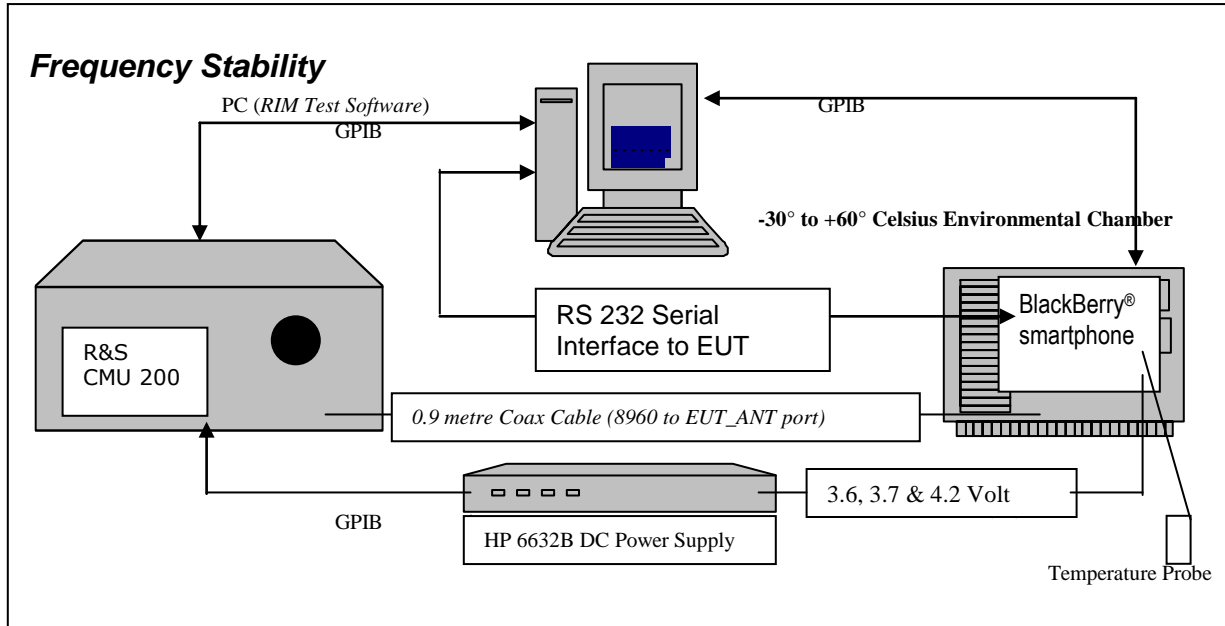

The following measurements were performed by Maurice Battler.

CFR 47 Chapter 1 - Federal Communications Commission Rules

Part 2 Required Measurements

2.1055 Frequency Stability - Procedures

(a,b) Frequency Stability - Temperature Variation

(d) Frequency Stability - Voltage Variation

24.235 *Frequency Stability.*

The frequency stability shall be sufficient to ensure that the fundamental emission stays within the authorized frequency block.

The EUT meets the requirements as stated in CFR 47 chapter 1, Section 27.54, CFR 47 and RSS-139, 6.3 Frequency Stability.

Frequency Stability measurement devices were configured as presented in the block diagram recording frequency, power, data, temperatures, and stepped voltages controlled via a GPIB interface linked to the Environmental chamber, a DC power supply, and the Communications Test Set. A 0.9-metre coax cable was calibrated to characterize the insertion loss for the transmitted frequencies between the RF input/output of the CMU 200 and the EUT antenna port.

	EMI Test Report for the BlackBerry® smartphone Model RDD71UW, RDC71UW APPENDIX 3B	
	Test Report No. RTS-2579-1107-62A	Dates of Test June 14 to July 11, 2011

Procedure:

The EUT was placed in the Temperature chamber and connected to CMU 200 outside as shown in the figure above. Dry air was pumped inside the temperature chamber to maintain a backpressure during the test. The EUT was kept in the off condition at all times except when the following measurements were to be made.

The chamber was switched on and the temperature was set to -30°C. After the chamber stabilized at -30 °C there was a soak period of one hour to alleviate moisture in the chamber, the EUT voltage was enabled. The system software recorded the frequency, power, and associated measurements.

A Computer system controlled the automated software. This application was given the command of activating all machines intrinsic to the temperature and voltage tests controlling the CMU 200 via the GPIB Bus. The Environmental Chamber was instructed through an RS-232 serial line. The EUT dialogue was passed through a serial connection.

The EUT repetitively transmitted 100 bursts for each set of programmed parameters recording temperature, voltage settings, and systematically selected frequencies. The power supply was cycled from minimum voltage 3.6 volts, to 3.7 volts to 4.2 volts maximum voltage. The frequency error was measured at a maximum output power and recorded by the automated system test software.

The EUT output power and frequency was measured at 3.6 volts, 3.7 volts and 4.2 volts. The transmit frequency was varied in 3 steps consisting of 1852.4, 1880.0 and 1907.6 MHz for the UMTS band 2. This frequency was recorded in MHz and deviation from nominal, in Parts Per Million.

After the initial one-hour soak at the beginning of the tests, a period of thirty minutes soak was initialized between each ascending temperature step, before proceeding to the next measurement test cycle.

	EMI Test Report for the BlackBerry® smartphone Model RDD71UW, RDC71UW	
	APPENDIX 3B	
Test Report No. RTS-2579-1107-62A	Dates of Test June 14 to July 11, 2011	FCC ID: L6ARDD70UW, L6ARDC70UW IC: 2503A-RDD70UW, 2503A-RDC70UW

PROCEDURE:

The test system software for commencing the Frequency Stability Tests carried through the following cycle.

1. Switch on the HP 6632B power supply; CMU 200 Communications test Set, and Environmental Chamber.
2. Start test program
3. Set the Temperature to -30°C and maintain a period of one- hour soak time, with the EUT supply voltage disabled.
4. Set power supply voltage to 3.6 volts.
5. Set up CMU 200 Radio Communication Tester.
6. Command the CMU 200 to switch to the low channel.
7. Enable the voltage to the EUT, and connect a link to the CMU 200 test set.
8. EUT is commanded to Transmit 100 Bursts.
9. Software logs the following data from the CMU 200, power supply and temperature chamber: Traffic Channel Number, Traffic Channel Frequency, Power Level, Chamber Temperature, Supply Voltage, Power and Frequency Error.
10. The CMU 200 commands the EUT to change frequency to the middle channel and high channel and repeats steps 7 to 9.
11. Repeat steps 5 to 10 changing the supply voltage to 3.7 Volts
12. Increase temperature by 10°C and soak for 1/2 hour.
13. Repeat steps 4 - 12 for temperatures -30°C to 60°C .
14. Repeat steps 5 to 10 changing the supply voltage to 4.2 volts

Procedure 5 to 10 was repeated at room temperature (20°C) with the power supply voltage set to 3.6, 3.7 and 4.2 volts

The maximum frequency error in the UMTS band 4 measured was **0.0327 PPM**.

Test Report No. RTS-2579-1107-62A	Dates of Test June 14 to July 11, 2011	FCC ID: L6ARDD70UW, L6ARDC70UW IC: 2503A-RDD70UW, 2503A-RDC70UW
---	--	--

UMTS Band 4 Channel results: channels 1312, 1412 and 1513 @ 20°C maximum transmitted power

Traffic Channel Number	UMTS band 4 Frequency (MHz)	Voltage (Volts)	Temperature (Celsius)	Frequency Error (Hz)	PPM
1312	1712.4	3.6	20	34	0.0199
1412	1732.4	3.6	20	26	0.0150
1513	1752.6	3.6	20	32	0.0183

Traffic Channel Number	UMTS band 4 Frequency (MHz)	Voltage (Volts)	Temperature (Celsius)	Frequency Error (Hz)	PPM
1312	1712.4	3.7	20	32	0.0187
1412	1732.4	3.7	20	24	0.0139
1513	1752.6	3.7	20	31	0.0177

Traffic Channel Number	UMTS band 4 Frequency (MHz)	Voltage (Volts)	Temperature (Celsius)	Frequency Error (Hz)	PPM
1312	1712.4	4.2	20	31	0.0181
1412	1732.4	4.2	20	27	0.0156
1513	1752.6	4.2	20	32	0.0183

Test Report No.
RTS-2579-1107-62A

Dates of Test
June 14 to July 11, 2011

FCC ID: L6ARDD70UW, L6ARDC70UW
IC: 2503A-RDD70UW, 2503A-RDC70UW

UMTS band 4 Results: channel 1312 @ maximum transmitted power

Traffic Channel Number	Frequency (MHz)	Voltage (Volts)	Temperature (Celsius)	Frequency Error (Hz)	PPM
1312	1712.4	3.6	-30	31	0.0181
1312	1712.4	3.6	-20	34	0.0199
1312	1712.4	3.6	-10	29	0.0169
1312	1712.4	3.6	0	32	0.0187
1312	1712.4	3.6	10	56	0.0327
1312	1712.4	3.6	20	34	0.0199
1312	1712.4	3.6	30	30	0.0175
1312	1712.4	3.6	40	50	0.0292
1312	1712.4	3.6	50	33	0.0193
1312	1712.4	3.6	60	32	0.0187

Traffic Channel Number	Frequency (MHz)	Voltage (Volts)	Temperature (Celsius)	Frequency Error (Hz)	PPM
1312	1712.4	3.7	-30	30	0.0175
1312	1712.4	3.7	-20	34	0.0199
1312	1712.4	3.7	-10	30	0.0175
1312	1712.4	3.7	0	32	0.0187
1312	1712.4	3.7	10	35	0.0204
1312	1712.4	3.7	20	32	0.0187
1312	1712.4	3.7	30	28	0.0164
1312	1712.4	3.7	40	31	0.0181
1312	1712.4	3.7	50	33	0.0193
1312	1712.4	3.7	60	12	0.0070

Traffic Channel Number	Frequency (MHz)	Voltage (Volts)	Temperature (Celsius)	Frequency Error (Hz)	PPM
1312	1712.4	4.2	-30	32	0.0175
1312	1712.4	4.2	-20	35	0.0204
1312	1712.4	4.2	-10	30	0.0175
1312	1712.4	4.2	0	32	0.0187
1312	1712.4	4.2	10	32	0.0187
1312	1712.4	4.2	20	31	0.0181
1312	1712.4	4.2	30	31	0.0181
1312	1712.4	4.2	40	31	0.0181
1312	1712.4	4.2	50	31	0.0181
1312	1712.4	4.2	60	30	0.0175

Test Report No. RTS-2579-1107-62A	Dates of Test June 14 to July 11, 2011	FCC ID: L6ARDD70UW, L6ARDC70UW IC: 2503A-RDD70UW, 2503A-RDC70UW
---	--	--

UMTS band 4 Results: channel 1412 @ maximum transmitted power

Traffic Channel Number	Frequency (MHz)	Voltage (Volts)	Temperature (Celsius)	Frequency Error (Hz)	PPM
1412	1732.4	3.6	-30	27	0.0156
1412	1732.4	3.6	-20	27	0.0156
1412	1732.4	3.6	-10	26	0.0150
1412	1732.4	3.6	0	26	0.0150
1412	1732.4	3.6	10	52	0.0300
1412	1732.4	3.6	20	26	0.0150
1412	1732.4	3.6	30	24	0.0139
1412	1732.4	3.6	40	27	0.0156
1412	1732.4	3.6	50	27	0.0156
1412	1732.4	3.6	60	25	0.0144

Traffic Channel Number	Frequency (MHz)	Voltage (Volts)	Temperature (Celsius)	Frequency Error (Hz)	PPM
1412	1732.4	3.7	-30	28	0.0162
1412	1732.4	3.7	-20	27	0.0156
1412	1732.4	3.7	-10	24	0.0139
1412	1732.4	3.7	0	27	0.0156
1412	1732.4	3.7	10	52	0.0300
1412	1732.4	3.7	20	24	0.0139
1412	1732.4	3.7	30	29	0.0167
1412	1732.4	3.7	40	27	0.0156
1412	1732.4	3.7	50	28	0.0162
1412	1732.4	3.7	60	11	0.0063

Traffic Channel Number	Frequency (MHz)	Voltage (Volts)	Temperature (Celsius)	Frequency Error (Hz)	PPM
1412	1732.4	4.2	-30	27	0.0156
1412	1732.4	4.2	-20	27	0.0156
1412	1732.4	4.2	-10	24	0.0139
1412	1732.4	4.2	0	25	0.0144
1412	1732.4	4.2	10	53	0.0306
1412	1732.4	4.2	20	27	0.0156
1412	1732.4	4.2	30	27	0.0156
1412	1732.4	4.2	40	28	0.0162
1412	1732.4	4.2	50	26	0.0150
1412	1732.4	4.2	60	28	0.0162

Test Report No.
RTS-2579-1107-62A

Dates of Test
June 14 to July 11, 2011

FCC ID: L6ARDD70UW, L6ARDC70UW
IC: 2503A-RDD70UW, 2503A-RDC70UW

UMTS band 4 Results: channel 1513 @ maximum transmitted power

Traffic Channel Number	Frequency (MHz)	Voltage (Volts)	Temperature (Celsius)	Frequency Error (Hz)	PPM
1513	1752.6	3.6	-30	34	0.0194
1513	1752.6	3.6	-20	33	0.0188
1513	1752.6	3.6	-10	29	0.0165
1513	1752.6	3.6	0	31	0.0177
1513	1752.6	3.6	10	55	0.0314
1513	1752.6	3.6	20	32	0.0183
1513	1752.6	3.6	30	31	0.0177
1513	1752.6	3.6	40	34	0.0194
1513	1752.6	3.6	50	32	0.0183
1513	1752.6	3.6	60	30	0.0171

Traffic Channel Number	Frequency (MHz)	Voltage (Volts)	Temperature (Celsius)	Frequency Error (Hz)	PPM
1513	1752.6	3.7	-30	32	0.0183
1513	1752.6	3.7	-20	27	0.0154
1513	1752.6	3.7	-10	32	0.0183
1513	1752.6	3.7	0	29	0.0165
1513	1752.6	3.7	10	30	0.0171
1513	1752.6	3.7	20	31	0.0177
1513	1752.6	3.7	30	33	0.0188
1513	1752.6	3.7	40	36	0.0205
1513	1752.6	3.7	50	34	0.0194
1513	1752.6	3.7	60	12	0.0068

Traffic Channel Number	Frequency (MHz)	Voltage (Volts)	Temperature (Celsius)	Frequency Error (Hz)	PPM
1513	1752.6	4.2	-30	34	0.0194
1513	1752.6	4.2	-20	30	0.0171
1513	1752.6	4.2	-10	33	0.0188
1513	1752.6	4.2	0	34	0.0194
1513	1752.6	4.2	10	28	0.0160
1513	1752.6	4.2	20	32	0.0183
1513	1752.6	4.2	30	32	0.0183
1513	1752.6	4.2	40	31	0.0177
1513	1752.6	4.2	50	33	0.0188
1513	1752.6	4.2	60	31	0.0177

APPENDIX 4A – GSM RADIATED EMISSIONS TEST DATA

Test Report No. RTS-2579-1107-62A	Dates of Test June 14 to July 11, 2011	FCC ID: L6ARDD70UW, L6ARDC70UW IC: 2503A-RDD70UW, 2503A-RDC70UW
---	--	--

Radiated Power Test Data Results

The following test configurations were measured for RDD71UW:

Date of test: July 4, 2011

The following measurements were performed by Shuo Wang.
 The environmental tests conditions were: Temperature: 25.0 °C
 Relative Humidity: 40.3%

The BlackBerry® smartphone was in standalone, USB up position.
 Test distance is 3.0 metres.

PCS1900 Band Call Mode

EUT								Substitution Method					
EUT				Receive Antenna		Spectrum Analyzer		Tracking Generator					
Type	Ch	Frequency (MHz)	Band	Type	Pol.	Reading (dBuV)	Max (V,H) dBuV	Pol. Tx-Rx	Reading (dBm)	Corrected Reading (relative to Isotropic Radiator)		Limit (dBm)	Diff to Limit (dB)
										(dBm)	(W)		
F0	512	1850.20	1900	Horn	V	91.24	91.24	V-V	-2.57	32.30	1.70	33.00	0.70
F0	512	1850.20	1900	Horn	H	85.7		H-H	-2.51				
F0	661	1880.00	1900	Horn	V	91.01	91.01	V-V	-2.68	32.44	1.75	33.00	0.56
F0	661	1880.00	1900	Horn	H	85.42		H-H	-2.46				
F0	810	1909.80	1900	Horn	V	91.17	91.17	V-V	-1.62	32.47	1.77	33.00	0.53
F0	810	1909.80	1900	Horn	H	84.66		H-H	-1.48				

PCS1900 Band EDGE Mode

EUT								Substitution Method					
EUT				Receive Antenna		Spectrum Analyzer		Tracking Generator					
Type	Ch	Frequency (MHz)	Band	Type	Pol.	Reading (dBuV)	Max (V,H) dBuV	Pol. Tx-Rx	Reading (dBm)	Corrected Reading (relative to Isotropic Radiator)		Limit (dBm)	Diff to Limit (dB)
										(dBm)	(W)		
F0	512	1850.20	1900	Horn	V	89.44	89.44	V-V	-4.37	30.44	1.11	33.00	2.56
F0	512	1850.20	1900	Horn	H	82.29		H-H	-4.42				
F0	661	1880.00	1900	Horn	V	89.27	89.27	V-V	-4.42	30.70	1.18	33.00	2.30
F0	661	1880.00	1900	Horn	H	82.68		H-H	-4.2				
F0	810	1909.80	1900	Horn	V	88.54	88.54	V-V	-4.25	29.84	0.96	33.00	3.16
F0	810	1909.80	1900	Horn	H	81.13		H-H	-4.11				

Test Report No. RTS-2579-1107-62A	Dates of Test June 14 to July 11, 2011	FCC ID: L6ARDD70UW, L6ARDC70UW IC: 2503A-RDD70UW, 2503A-RDC70UW
---	--	--

Radiated Power Test Data Results

The following test configurations were measured for RDC71UW:

Date of test: June 24, 2011

The following measurements were performed by Adam Rusinek.

The environmental tests conditions were: Temperature: 25.1 °C

Relative Humidity: 41.4%

The BlackBerry® smartphone was in standalone, USB up position.

Test distance is 3.0 metres.

PCS1900 Band Call Mode

EUT							Substitution Method		Tracking Generator		Limit (dBm)	Diff to Limit (dB)	
Type	Ch	Frequency (MHz)	Band	Receive Antenna Type	Receive Antenna Pol.	Spectrum Analyzer Reading (dBuV)	Max (V,H) dBuV	Pol. Tx-Rx	Reading (dBm)	Corrected Reading (relative to Isotropic Radiator)			
										(dBm)	(W)		
F0	512	1850.20	1900	Horn	V	91.79	91.79	V-V	-2.15	32.66	1.85	33.00	0.34
F0	512	1850.20	1900	Horn	H	85.87		H-H	-2.21				
F0	661	1880.00	1900	Horn	V	91.09	91.09	V-V	-2.85	32.47	1.77	33.00	0.53
F0	661	1880.00	1900	Horn	H	86.11		H-H	-2.43				
F0	810	1909.80	1900	Horn	V	91.41	91.41	V-V	-1.47	32.68	1.85	33.00	0.32
F0	810	1909.80	1900	Horn	H	86.24		H-H	-1.27				

PCS1900 Band EDGE Mode

EUT							Substitution Method		Tracking Generator		Limit (dBm)	Diff to Limit (dB)	
Type	Ch	Frequency (MHz)	Band	Receive Antenna Type	Receive Antenna Pol.	Spectrum Analyzer Reading (dBuV)	Max (V,H) dBuV	Pol. Tx-Rx	Reading (dBm)	Corrected Reading (relative to Isotropic Radiator)			
										(dBm)	(W)		
F0	512	1850.20	1900	Horn	V	89.43	89.43	V-V	-4.51	30.30	1.07	33.00	2.70
F0	512	1850.20	1900	Horn	H	84.94		H-H	-4.57				
F0	661	1880.00	1900	Horn	V	89.11	89.11	V-V	-4.70	30.49	1.12	33.00	2.51
F0	661	1880.00	1900	Horn	H	85.34		H-H	-4.41				
F0	810	1909.80	1900	Horn	V	89.76	89.76	V-V	-3.12	31.03	1.27	33.00	1.97
F0	810	1909.80	1900	Horn	H	86.07		H-H	-2.92				

	EMI Test Report for the BlackBerry® smartphone Model RDD71UW, RDC71UW APPENDIX 4A	
	Test Report No. RTS-2579-1107-62A	Dates of Test June 14 to July 11, 2011

Radiated Emissions Test Data Results cont'd

GSM850 Call Mode

The following test configurations were measured for RDC71UW:

Date of Test: July 6, 2011

The following measurements were performed by Quan(Jerry) Ma.

The environmental test conditions were: Temperature: 25.1 °C
Relative Humidity: 36.1 %

Test Distance was 3.0 metres with a height of 1.0 metres, and a frequency range of 30 MHz to 1000 MHz.

The BlackBerry® smartphone was in standalone, USB Up position.

The measurements were performed in GSM850 Call Tx mode, channel 190.

All emissions had a test margin greater than 25.0 dB.

Date of Test: July 5, 2011

The following measurements were performed by Adam Rusinek.

The environmental test conditions were: Temperature: 25.1 °C
Relative Humidity: 46.1 %

Test Distance was 3.0 metres with a height of 1metre, and a frequency range of 1 GHz to 9 GHz.

The BlackBerry® smartphone was in standalone, USB Up position.

The measurements were performed in GSM850 Call Tx mode, channel 190.

All other emissions had a test margin greater than 25.0 dB

	EMI Test Report for the BlackBerry® smartphone Model RDD71UW, RDC71UW APPENDIX 4A	
	Test Report No. RTS-2579-1107-62A	Dates of Test June 14 to July 11, 2011

Radiated Emissions Test Data Results cont'd

GSM850 EDGE Mode

Date of Test: July 6, 2011

The following measurements were performed by Quan(Jerry) Ma.

The environmental test conditions were: Temperature: 25.1 °C
Relative Humidity: 36.1 %

Test Distance was 3.0 metres with a height of 1.0 metres, and a frequency range of 30 MHz to 1000 MHz.

The BlackBerry® smartphone was in standalone, USB Up position.

The measurements were performed in GSM850 EDGE Tx mode, channel 190.

All emissions had a test margin greater than 25.0 dB.

Date of Test: July 5, 2011

The following measurements were performed by Adam Rusinek

The environmental test conditions were: Temperature: 25.1 °C
Relative Humidity: 46.1 %

Test Distance was 3.0 metres with a height of 1-4 metres, and a frequency range of 1 GHz to 9 GHz.

The BlackBerry® smartphone was in standalone, USB up position.

The measurements were performed in GSM850 EDGE Tx mode, channel 190.

All other emissions had a test margin greater than 25.0 dB

	EMI Test Report for the BlackBerry® smartphone Model RDD71UW, RDC71UW APPENDIX 4A	
	Test Report No. RTS-2579-1107-62A	Dates of Test June 14 to July 11, 2011

Radiated Emissions Test Data Results cont'd

PCS1900 GSM Mode

Date of Test: July 6, 2011

The following measurements were performed by Quan(Jerry) Ma

The environmental test conditions were: Temperature: 25.1 °C
Relative Humidity: 36.1 %

Test Distance was 3.0 metres with a height of 1-4 meters, and a frequency range of 30 - 1000 MHz.

The BlackBerry® smartphone was in standalone, USB up position.

The measurements were performed in PCS1900 Call Tx mode, channel 661.

All emissions had a test margin greater than 25.0 dB.

Date of Test: July 5, 2011

The following measurements were performed by Adam Rusinek.

The environmental test conditions were: Temperature: 24.5 °C
Relative Humidity: 48.2 %

Test Distance was 3.0 metres with a height of 1.0 metres, and a frequency range of 1 GHz to 20 GHz.

The BlackBerry® smartphone was in standalone, USB up position.

The measurements were performed in PCS1900, channel 661.

All emissions had a test margin greater than 25.0 dB.

	EMI Test Report for the BlackBerry® smartphone Model RDD71UW, RDC71UW APPENDIX 4A	
	Test Report No. RTS-2579-1107-62A	Dates of Test June 14 to July 11, 2011

Radiated Emissions Test Data Results cont'd

PCS1900 EDGE Mode

Date of Test: July 6, 2011

The following measurements were performed by Quan(Jerry) Ma

The environmental test conditions were: Temperature: 25.1 °C
Relative Humidity: 36.1 %

Test Distance was 3.0 metres with a height of 1-4 meters, and a frequency range of 30 - 1000 MHz.

The BlackBerry® smartphone was in standalone, USB up position.

The measurements were performed in PCS EDGE 1900 Call Tx mode, channel 661.

All emissions had a test margin greater than 25.0 dB.

Date of Test: July 5, 2011

The following measurements were performed by Adam Rusinek.

The environmental test conditions were: Temperature: 24.5 °C
Relative Humidity: 48.2 %

Test Distance was 3.0 metres with a height of 1.0 metres, and a frequency range of 1 GHz to 20 GHz.

The BlackBerry® smartphone was in standalone, USB up position.

The measurements were performed in PCS EDGE1900, channel 661.

All emissions had a test margin greater than 25.0 dB.

APPENDIX 4B – UMTS 4 RADIATED EMISSIONS TEST DATA

Test Report No. RTS-2579-1107-62A	Dates of Test June 14 to July 11, 2011	FCC ID: L6ARDD70UW, L6ARDC70UW IC: 2503A-RDD70UW, 2503A-RDC70UW
---	--	--

Radiated Power Test Data Results

The following test configurations were measured for model RDD71UW:

Date of Test: June 28, 2011

The following measurements were performed by Quan (Jerry) Ma.

The environmental tests conditions were: Temperature: 23.4°C
 Relative Humidity: 44.2%

The BlackBerry® smartphone was in standalone, USB down position.
 Test distance is 3.0 metres

UMTS band 4 Call Service Mode

EUT				Rx Antenna		Spectrum Analyzer		Substitution Method					
Type	Ch	Frequency (MHz)	Band	Type	Pol.	Reading (dBuV)	Max (V,H) (dBuV)	Tracking Generator		Corrected Reading (relative to Dipole)		Limit (dBm)	Diff. To Limit (dB)
								Pol. Tx-Rx	Reading (dBm)	(dBm)	(W)		
F0	1312	1712.40	4	Horn	V	77.75	84.13	V-V	-16.91	23.15	0.21	33	-9.9
F0	1312	1712.40	4	Horn	H	84.13		H-H	-16.71				
F0	1413	1732.60	4	Horn	V	77.38	84.08	V-V	-16.80	23.60	0.23	33	-9.4
F0	1413	1732.60	4	Horn	H	84.08		H-H	-16.56				
F0	1513	1752.60	4	Horn	V	76.62	83.44	V-V	-16.94	23.91	0.25	33	-9.1
F0	1513	1752.60	4	Horn	H	83.44		H-H	-15.99				

UMTS band 4 HSUPA Mode

EUT				Rx Antenna		Spectrum Analyzer		Substitution Method					
Type	Ch	Frequency (MHz)	Band	Type	Pol.	Reading (dBuV)	Max (V,H) (dBuV)	Tracking Generator		Corrected Reading (relative to Dipole)		Limit (dBm)	Diff. To Limit (dB)
								Pol. Tx-Rx	Reading (dBm)	(dBm)	(W)		
F0	1312	1712.40	4	Horn	V	78.77	84.85	V-V	-16.23	23.87	0.24	33	-9.1
F0	1312	1712.40	4	Horn	H	84.85		H-H	-15.99				
F0	1413	1732.60	4	Horn	V	78.34	85.02	V-V	-15.79	24.59	0.29	33	-8.4
F0	1413	1732.60	4	Horn	H	85.02		H-H	-15.57				
F0	1513	1752.60	4	Horn	V	77.5	84.21	V-V	-16.16	24.70	0.30	33	-8.3
F0	1513	1752.60	4	Horn	H	84.21		H-H	-15.20				

	EMI Test Report for the BlackBerry® smartphone Model RDD71UW, RDC71UW APPENDIX 4B	
	Test Report No. RTS-2579-1107-62A	Dates of Test June 14 to July 11, 2011

Radiated Emissions Test Data Results cont'd
UMTS band 4 Call Service Mode

Date of Test: June 27, 2011

The following measurements were performed by Quan (Jerry) Ma

The environmental test conditions were: Temperature: 23.9 °C
Relative Humidity: 38.6 %

Test Distance was 3.0 metres with a height of 1-4 metres, and a frequency range of 30MHz to 1000MHz.

The BlackBerry® smartphone was in standalone, horizontal down position.

The following measurements were performed in UMTS band 4 Call mode on channels 1312, 1413, 1513.

All emissions had a test margin greater than 25.0 dB.

Date of Test: July 4, 2011

The following measurements were performed by Shuo Wang

The environmental test conditions were: Temperature: 24.5 °C
Relative Humidity: 43.3%

Test Distance was 3.0 metres with a height of 1-4 meters, and a frequency range of 1-20GHz.

The BlackBerry® smartphone was in standalone, vertical position.

The following measurements were performed in UMTS band 4 Call mode on channels 1312, 1413, 1513.

All emissions had a test margin greater than 25.0 dB.

	EMI Test Report for the BlackBerry® smartphone Model RDD71UW, RDC71UW APPENDIX 4B	
	Test Report No. RTS-2579-1107-62A	Dates of Test June 14 to July 11, 2011

Radiated Emissions Test Data Results cont'd
UMTS band 4 HSUPA Mode

Date of Test: June 27, 2011

The following measurements were performed by Quan(Jerry) Ma

The environmental test conditions were: Temperature: 23.9 °C
Relative Humidity: 38.6 %

Test Distance was 3.0 metres with a height of 1-4 metres, and a frequency range of 30MHz to 1000MHz.

The BlackBerry® smartphone was in standalone, horizontal down position.

The following measurements were performed in UMTS band 4 HSUPA mode on channels 1312, 1413, 1513.

All emissions had a test margin greater than 25.0 dB.

Date of Test: July 4, 2011

The following measurements were performed by Adam Rusinek

The environmental test conditions were: Temperature: 25.1 °C
Relative Humidity: 42.4 %

Test Distance was 3.0 metres with a height of 1-4 meters, and a frequency range of 1-20GHz.

The BlackBerry® smartphone was in standalone, vertical position.

The following measurements were performed in UMTS band 4 HSUPA mode on channels 1312, 1413, 1513.

All emissions had a test margin greater than 25.0 dB.