

# EMI Test Report

Tested in accordance with  
Federal Communications Commission (FCC)  
Personal Communications Services  
CFR 47 Parts 2, 22, 24 and 27  
&  
Industry Canada (IC) RSS-132, 133 and 139




**A division of Research In Motion Limited**

**REPORT NO:** RTS-2474-1002-50

<b>PRODUCT MODEL NO:</b>	RCX71UW
<b>TYPE NAME:</b>	BlackBerry® smartphone
<b>FCC ID:</b>	L6ARCX70UW
<b>IC:</b>	2503A-RCX70UW
<b>EMISSION DESIGNATOR (GSM):</b>	247KGXW
<b>EMISSION DESIGNATOR (EDGE):</b>	245KG7W
<b>EMISSION DESIGNATOR (WCDMA):</b>	4M18F9W

**DATE:** 22 March 2010

		EMI Test Report for the BlackBerry® smartphone Model RCX71UW
Test Report No. RTS-2474-1002-50	Dates of Test January 29 to February 23, 2010	Author Data Fahd Faisal

**Statement of Performance:**

The BlackBerry® smartphone, model RCX71UW, part number CER-25285-001 Rev 2 and accessories performs within the requirements of the test standards when configured and operated per RIM's instructions.


**Declaration:**

We hereby certify that:

The test data reported herein is an accurate record of the performance of the sample(s) tested. The test results are valid for the tested unit (s) only. The test equipment used was suitable for the tests performed and within manufacturer's published specifications and operating parameters. The test methods were consistent with the methods described in the relevant standards.

Documented by:

Reviewed by:





\_\_\_\_\_  
Fahd Faisal  
Regulatory Compliance Associate  
Date: 22 March 2010

\_\_\_\_\_  
Michael Cino  
Regulatory Compliance Associate  
Date: 23 March 2010

Reviewed and Approved by:




\_\_\_\_\_  
Masud S. Attayi, P.Eng.  
Manager, Regulatory Compliance  
Date: 26 March 2010

		EMI Test Report for the BlackBerry® smartphone Model RCX71UW
Test Report No. RTS-2474-1002-50	Dates of Test January 29 to February 23, 2010	Author Data Fahd Faisal

## Table of Contents

A)	Scope .....	4
B)	Associated Documents.....	4
C)	Product Identification .....	4
D)	Support Equipment Used for the Testing of the EUT .....	5
E)	Test Voltage .....	5
F)	Summary of Results .....	6
G)	Compliance Test Equipment Used .....	11
APPENDIX 1A – GSM CONDUCTED RF EMISSIONS TEST DATA/PLOTS.....		13
APPENDIX 1B – WCDMA CONDUCTED RF EMISSIONS TEST DATA/PLOTS.....		27
APPENDIX 2A – GSM CONDUCTED RF OUTPUT POWER TEST DATA.....		34
APPENDIX 2B – WCDMA CONDUCTED RF OUTPUT POWER TEST DATA .....		36
APPENDIX 3B – WCDMA FREQUENCY STABILITY TEST DATA.....		50
APPENDIX 4A – GSM RADIATED EMISSIONS TEST DATA.....		58
APPENDIX 4B – UMTS RADIATED EMISSIONS TEST DATA.....		65

		EMI Test Report for the BlackBerry® smartphone Model RCX71UW
Test Report No. RTS-2474-1002-50	Dates of Test January 29 to February 23, 2010	Author Data Fahd Faisal

## A) Scope

This report details the results of compliance tests which were performed in accordance to the requirements of:

- FCC CFR 47 Part 2, October 2009
- FCC CFR 47 Part 22, Subpart H, Cellular Radiotelephone Services, October 2009
- FCC CFR 47 Part 24 Subpart E, Broadband PCS, October 2009
- FCC CFR 47 Part 27 Subpart C, Technical Standards, October 2009
- Industry Canada, RSS-132 Issue 2, September 2005, Cellular Telephones Employing New Technologies Operating in the Bands 824-849 MHz and 869-894 MHz.
- Industry Canada, RSS-133 Issue 5, February 2009, 2 GHz Personal Communications Services.
- Industry Canada, RSS-139 Issue 2, February 2009, Advanced Wireless Services Equipment Operating in the Bands 1710 – 1755 and 2110 – 2155 MHz

## B) Associated Documents

1. HW\_Declaration\_CER-25285-001-Rev 2

## C) Product Identification

Manufactured by Research In Motion Limited whose headquarters is located at:

295 Phillip Street  
Waterloo, Ontario  
Canada, N2L 3W8  
Phone: 519 888 7465  
Fax: 519 888 6906


The equipment under test (EUT) was tested at the following locations:

RIM Testing Services EMI test facilities

305 Phillip Street  
Waterloo, Ontario  
Canada, N2L 3W8  
Phone: 519 888 7465  
Fax: 519 888 6906

440 Phillip Street  
Waterloo, Ontario,  
Canada , N2L 5R9  
Phone: 519 888 7465  
Fax: 519 888 6906

The testing was performed from January 29 to February 23, 2010.

		EMI Test Report for the BlackBerry® smartphone Model RCX71UW	
Test Report No. RTS-2474-1002-50	Dates of Test January 29 to February 23, 2010		Author Data Fahd Faisal

The sample EUT included:

SAMPLE	MODEL	CER NUMBER	PIN
1	RCX71UW	CER-25285-001 Rev 1	21BE04F2
2	RCX71UW	CER-25285-001 Rev 2	21BDDF4A
3	RCX71UW	CER-25285-001 Rev 2	21D067C1
4	RCX71UW	CER-25285-001 Rev 2	21D06B49

RF Conducted Emissions testing was performed on samples 1 and 2.  
RF Radiated Emissions testing was performed on samples 3 and 4.

To view the differences between CER-25285-001 Rev 1 and CER-25285-001 Rev 2, see document number HW\_Declaration\_CER-25285-001-Rev 2.


Only the measurements that may have been impacted by the changes from Rev 1 to Rev 2 were re-measured.

#### **D) Support Equipment Used for the Testing of the EUT**

No support equipment required; for list of equipment refer to section G, Compliance Test Equipment Used.


#### **E) Test Voltage**

The ac input voltage was 120 volts, 60 Hz where applicable. This configuration was per RIM's specifications.

		EMI Test Report for the BlackBerry® smartphone Model RCX71UW	
Test Report No. RTS-2474-1002-50	Dates of Test January 29 to February 23, 2010		Author Data Fahd Faisal

## F) Summary of Results


SPECIFICATION		TEST TYPE	RESULT	TEST DATA APPENDIX
FCC CFR 47	IC			
Part 2.1051 Part 22.917 Part 22.901	RSS-GEN, 4.9	GSM 850 Conducted Spurious Emissions	Pass	1A
Part 2.1051 Part 24.238(a)	RSS-GEN, 4.9	GSM PCS Conducted Spurious Emissions	Pass	1A
Part 2.202 Part 22.917	RSS-GEN, 4.6	GSM 850 Occupied Bandwidth and Channel Mask	Pass	1A
Part 2.202 Part 24.238	RSS-GEN, 4.6	GSM PCS Occupied Bandwidth and Channel Mask	Pass	1A
Part 2.1046(a)	RSS-133, 6.4 RSS-132, 4.4	GSM Conducted RF Output Power	Pass	2A
Part 2.1055(a)(d) Part 22.917	RSS-132, 4.3	GSM 850 Frequency Stability vs. Temperature and Voltage	Pass	3A
Part 2.1055(a)(d) Part 24.235	RSS-132, 4.3	GSM PCS Frequency Stability vs. Temperature and Voltage	Pass	3A
Part 22, Subpart H, Part 24, Subpart E	RSS-GEN, 4.9	GSM ERP, EIRP	Pass	4A
Part 22, Subpart H Part 24, Subpart E	RSS-GEN, 4.9	GSM Radiated Spurious/Harmonic Emissions	Pass	4A
Part 27.53	RSS-139, 6.5	WCDMA UMTS1700 Conducted Spurious Emissions	Pass	1B
Part 2.202 Part 27.53	RSS-GEN, 2.3	WCDMA UMTS1700 Occupied Bandwidth and Channel Mask	Pass	1B
Part 2.1046(a)	RSS-139, 6.4	WCDMA UMTS1700 Conducted RF Output Power	Pass	2B
Part 2.1055(a)(d) Part 27.54	RSS-139, 6.3	WCDMA UMTS1700 Frequency Stability vs. Temperature and Voltage	Pass	3B
Part 27.53	RSS-139, 6.5	WCDMA UMTS1700 Radiated Spurious/Harmonic Emissions	Pass	4B
Part 27.50	RSS-139, 6.4	WCDMA UMTS1700 EIRP	Pass	4B

		EMI Test Report for the BlackBerry® smartphone Model RCX71UW
Test Report No. RTS-2474-1002-50	Dates of Test January 29 to February 23, 2010	Author Data Fahd Faisal

## Summary of Results cont'd

- 1) The BlackBerry® smartphone met the requirements of the Tx Conducted Spurious Emissions requirements in the GSM850 as per 47 CFR 2.1051, CFR 22.917, CFR 22.901(d) and RSS-GEN, 4.9. The EUT was measured on the low, middle and high channels. The frequency range investigated was from 10 MHz to 10 GHz.  
See APPENDIX 1A for test data.
- 2) The BlackBerry® smartphone met the requirements of the Tx Conducted Spurious Emissions requirements in the PCS1900 as per 47 CFR 2.1051, CFR 24.238(a) and RSS-GEN, 4.9. The EUT was on the low, middle and high channels. The frequency range investigated was from 10 MHz to 20 GHz.  
See APPENDIX 1A for test data
- 3) The BlackBerry® smartphone met the requirements of the Occupied Bandwidth and channel mask requirements in the GSM850 as per 47 CFR 2.202, CFR 22.917 and RSS-GEN, 4.6. The EUT was measured in GSM and EDGE mode on the low, middle and high channels.  
See APPENDIX 1A for test data.
- 4) The BlackBerry® smartphone met the requirements of the Occupied Bandwidth and channel mask requirements in the PCS1900 as per 47 CFR 2.202, CFR 24.238 and RSS-GEN, 4.6. The EUT was measured in GSM and EDGE mode on the low, middle and high channels.  
See APPENDIX 1A for test data.
- 5) The BlackBerry® smartphone met the requirements of the Conducted RF Output Power requirements for the GSM850 and PCS1900 as per 47 CFR 2.1046(a), RSS 133, 6.4 and RSS 132, 4.4. The EUT was measured in GSM and EDGE mode on the low, middle and high channels.  
See APPENDIX 2A for the test data.
- 6) The BlackBerry® smartphone met the requirements of the Frequency Stability vs. Temperature and Voltage requirements for the PCS1900 band as per 47 CFR 2.1055(a), 2.1055(d), 24.235 and RSS-132, 4.3. The temperature range was from -30°C to +60°C in 10° temperature steps. The EUT was measured on low, middle and high channels at each temperature step. The EUT was measured at low (3.6 volts), nominal (3.7 volts) and high (4.2 volts) dc input voltage at each temperature step and channel at maximum output power.  
See APPENDIX 3A for the test data.
- 7) The BlackBerry® smartphone met the requirements of the Conducted Spurious Emissions in the UMTS1700 band as per 47 CFR 27.53 and RSS-139, 6.5. The EUT was measured on the low, middle and high channels. The frequency range investigated was from 10 MHz to 20 GHz.


This report shall NOT be reproduced except in full without the written consent of RIM Testing Services  
- A division of Research in Motion Limited.

		EMI Test Report for the BlackBerry® smartphone Model RCX71UW	
Test Report No. RTS-2474-1002-50	Dates of Test January 29 to February 23, 2010		Author Data Fahd Faisal

See APPENDIX 1B for the test data.

- 8) The BlackBerry® smartphone met the requirements of the Occupied Bandwidth in the UMTS1700 band as per 47 CFR 2.202, CFR 27.53 and RSS-139, 2.3. The low, middle and high channels were measured.  
See APPENDIX 1B for the test data.
- 9) The BlackBerry® smartphone met the requirements of the Conducted RF Output Power for the UMTS1700 band as per 47 CFR 2.1046(a), RSS-139, 6.4 and RSS-132, 4.4. The low, middle and high channels were measured.  
See APPENDIX 2B for the test data.
- 10) The BlackBerry® smartphone met the requirements of the Frequency Stability vs. Temperature and Voltage for UMTS1700 band as per 47 CFR 2.1055(a)(d), CFR 27.54 and RSS-139, 6.3. The maximum frequency error measured was less than 0.1 ppm. The temperature range was from -30°C to +60°C in 10° temperature steps. The BlackBerry® smartphone was measured on low, middle and high channels at each temperature step. The BlackBerry® smartphone was measured at low (3.6 volts), nominal (3.7 volts) and high (4.2 volts) dc input voltage at each temperature step and channel at maximum output power.  
See APPENDIX 3B for the test data.
- 11) The radiated spurious emissions/harmonics and ERP/EIRP were measured for GSM 850, PCS 1900, and UMTS 1700 bands (WCDMA band 4). The results are within the limits. The BlackBerry® smartphone was placed on a nonconductive styrofoam table, 100 cm high that was positioned on a remotely controlled turntable. The test distance used between the BlackBerry® smartphone and the receiving antenna was three metres. Then the emissions were maximized by elevating the antenna in the range of 1 to 4 metres. The turntable was rotated to determine the azimuth of the peak emissions. Both the horizontal and vertical polarizations of the emissions were measured. The maximum emissions level was recorded. The BlackBerry® smartphone was then substituted with an antenna placed in the same location as the BlackBerry® smartphone. A Dipole antenna was used for the ERP measurements and a Horn antenna was used for EIRP measurements. The substitution antenna was connected into a signal generator that was set to the test frequency.



	EMI Test Report for the BlackBerry® smartphone Model RCX71UW	
Test Report No. RTS-2474-1002-50	Dates of Test January 29 to February 23, 2010	Author Data Fahd Faisal

The emissions were maximized by elevating the antenna in the range of 1 to 4 metres. The signal generator output was then adjusted to match the BlackBerry® smartphone output reading. The signal generator output was recorded. Both the horizontal and vertical polarizations of the emissions were measured.

The following measurements were done in a semi-anechoic chamber (SAC) below 1 GHz and a fully-anechoic room (FAR) above 1 GHz. The SAC's FCC registration number is **778487** and the Industry Canada (IC) file number is **2503B-1**. The FAR's FCC registration number is **959115** and the IC file number is **2503C-1**. The BlackBerry® smartphone was measured on the low, middle and high channels.

The ERP in the 850 band, GSM mode was measured on BlackBerry® smartphone. The highest ERP measured was 30.39 dBm (1.09 W) at 848.80 MHz (channel 251).

The ERP in the 850 band, EDGE mode was measured on BlackBerry® smartphone. The highest ERP measured was 28.56 dBm (0.72 W) at 848.80 MHz (channel 251).

The EIRP in the PCS band, GSM mode was measured on BlackBerry® smartphone. The highest ERP measured was 31.48 dBm (1.41 W) at 1880.00 MHz (channel 661).


The EIRP in the PCS band, EDGE mode was measured on BlackBerry® smartphone. The highest ERP measured was 28.62 dBm (0.73 W) at 1909.80 MHz (channel 810).

The ERP in the 1700 band, UMTS mode was measured on BlackBerry® smartphone. The highest ERP measured was 21.47 dBm (0.14 W) at 1752.60 MHz (channel 1513).

The radiated spurious emission and carrier harmonics were measured up to the 10<sup>th</sup> harmonic for low, middle and high channels in the GSM850 and PCS bands. Each band was measured in GSM and EDGE mode. Both the horizontal and vertical polarizations were measured.

The test margins in the GSM850 and PCS1900 bands for both GSM mode and EDGE mode band harmonic emissions were greater than 25 dB below the accepted limits for all tested frequencies.

The radiated spurious emission and carrier harmonics were measured up to the 10<sup>th</sup> harmonic for low, middle and high channels in the UMTS1700 band. Both the horizontal and vertical polarizations were measured.

		EMI Test Report for the BlackBerry® smartphone Model RCX71UW	
Test Report No. RTS-2474-1002-50	Dates of Test January 29 to February 23, 2010		Author Data Fahd Faisal

The test margin in the UMTS1700 band harmonic emissions were greater than 25 dB below the accepted limits for all tested frequencies.

### Co-Location Measurements

The radiated emissions were measured up to 18 GHz for middle channels for simultaneous transmission in the following test configuration combinations: GSM850/Bluetooth/802.11b, PCS1900/Bluetooth/802.11g and UMTS 1700 band/Bluetooth/802.11b.

Both the horizontal and vertical polarizations were measured. The emissions due to different simultaneous transmission did not increase the amplitude of any emissions nor did it produce any new inter-modulation products as a result of mixing.

### **Sample Calculation:**

Field Strength (dBμV/M) is calculated as follows:

$$FS = \text{Measured Level (dB}\mu\text{V)} + \text{A.F. (dB/m)} + \text{Cable Loss (dB)} - \text{Preamp (dB)} + \text{Filter Loss (dB)}$$

To view the test data see APPENDIX 4A and 4B.

### **Measurement Uncertainty ±4.6 dB**


Test Report No.  
 RTS-2474-1002-50

 Dates of Test  
 January 29 to February 23, 2010

 Author Data  
 Fahd Faisal

## g) Compliance Test Equipment Used


<u>UNIT</u>	<u>MANUFACTURER</u>	<u>MODEL</u>	<u>SERIAL NUMBER</u>	<u>CAL DUE DATE</u> (YY MM DD)	<u>USE</u>
Preamplifier	Sonoma	310N/11909A	185831	10-11-14	Radiated Emissions
Preamplifier system	TDK RF Solutions	PA-02	080010	10-11-06	Radiated Emissions
Preamplifier	Rohde & Schwarz	TS-ANA4-SP	001	11-02-17	Radiated Emissions
Preamplifier	Rohde & Schwarz	TS-ANA-SP	001	11-02-19	Radiated Emissions
Hybrid Log Antenna	EMC Automation	HLP-3003C	017301	11-02-02	Radiated Emissions
Hybrid Log Antenna	EMC Automation	HLP-3003C	017401	10-09-26	Radiated Emissions
Horn Antenna	EMC Automation	HRN-0118	030101	10-07-22	Radiated Emissions
Horn Antenna	EMC Automation	HRN-0118	030201	11-03-12	Radiated Emissions
Horn Antenna	Emco	3117	47563	11-07-15	Radiated Emissions
Horn Antenna	CMT	LHA 0180	R52734-001	12-01-21	Radiated Emissions
Preamplifier	TDK RF Solutions	18-26	030002	10-11-06	Radiated Emissions
Dipole Antenna	Schwarzbeck	UHAP	1018	11-03-12	Radiated Emissions
Dipole Antenna	Schwarzbeck	UHAP	974	10-10-16	Radiated Emissions
Universal Radio Communication Tester	Rohde & Schwarz	CMU 200	837493/073	10-11-30	Radiated Emissions
Universal Radio Communication Tester	Rohde & Schwarz	CMU 200	112394	10-11-30	Radiated Emissions
Universal Radio Communication Tester	Rohde & Schwarz	CMU 200	102204	10-11-25	RF Conducted Emissions
EMI Receiver	Rohde & Schwarz	ESIB-40	100255	10-11-30	Radiated Emissions
EMI Receiver	Rohde & Schwarz	ESU-40	100162	10-11-29	Radiated Emissions
Spectrum Analyzer	HP	8563E	3745A08112	11-09-30	RF Conducted Emissions
DC Power Supply	HP	6632B	US37472178	10-06-23	RF Conducted Emissions
Environment Monitor	Control Company	1870	230355190	11-01-08	Radiated Emissions

		EMI Test Report for the BlackBerry® smartphone Model RCX71UW	
Test Report No. RTS-2474-1002-50	Dates of Test January 29 to February 23, 2010		Author Data Fahd Faisal

### Compliance Test Equipment Used cont'd

<u>UNIT</u>	<u>MANUFACTURER</u>	<u>MODEL</u>	<u>SERIAL NUMBER</u>	<u>CAL DUE DATE</u> (YY MM DD)	<u>USE</u>
Environment Monitor	Control Company	1870	230355189	11-01-08	RF Conducted Emissions
Environment Monitor	Control Company	1870	80117164	11-01-08	Radiated Emissions
Temperature Probe	Control Company	15-077-21	51129471	10-05-01	Frequency Stability
Environmental Chamber	ESPEC Corp.	SH-240S1	91007118	N/R	Frequency Stability
Signal Generator	Agilent	E8257D	MY45140527	11-11-05	Radiated Emissions
Signal Generator	Agilent	83630B	3844A00927	10-10-31	Radiated Emissions

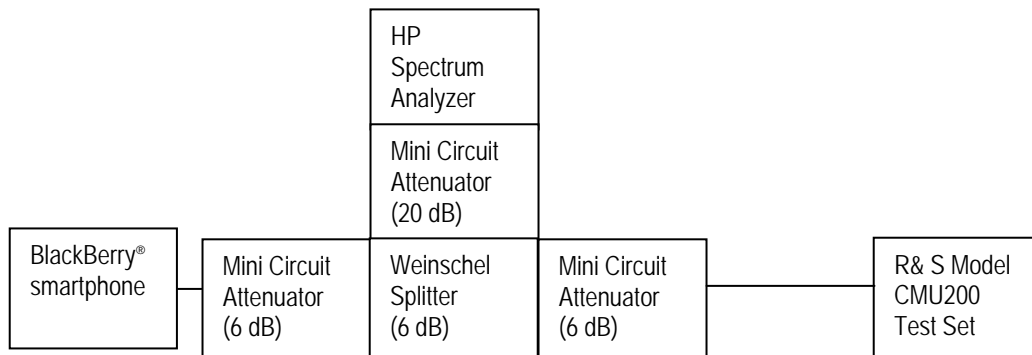
## APPENDIX 1A – GSM CONDUCTED RF EMISSIONS TEST DATA/PLOTS

	EMI Test Report for the BlackBerry® smartphone Model RCX71UW	
	<b>APPENDIX 1A</b>	
Test Report No. RTS-2474-1002-50	Dates of Test January 29 to February 23, 2010	Author Data Fahd Faisal

### GSM Conducted RF Emission Test Data

This appendix contains measurement data pertaining to conducted spurious emissions, -26 dBc bandwidth, 99% power bandwidth and the channel mask for the BlackBerry® smartphone.

### Test Setup Diagram




Date of Test: January 29, 2010

The environmental test conditions were:

Temperature: 24 °C  
 Pressure: 1024 mb  
 Relative Humidity: 21 %

The following measurements were performed by Maurice Battler.

	EMI Test Report for the BlackBerry® smartphone Model RCX71UW	
	<b>APPENDIX 1A</b>	
Test Report No. RTS-2474-1002-50	Dates of Test January 29 to February 23, 2010	Author Data Fahd Faisal

### GSM Conducted RF Emission Test Data cont'd

**The conducted spurious emissions** – As per 47 CFR 2.1051, CFR 24.238(a), RSS-GEN, 4.9, CFR 22 Subpart H and RSS-132 were measured from 10 MHz to 20 GHz. The EUT emissions were in the noise floor.

See figures 1-1a to 1-12a for the plots of the conducted spurious emissions.

#### **–26 dBc Bandwidth and Occupied Bandwidth (99%)**

For each carrier frequency of low, middle and high, the modulation spectrum was measured by both methods of 99% power bandwidth and –26 dBc bandwidth.

The resolution bandwidth required for out-of-band emissions in the 1 MHz bands immediately outside and adjacent to the frequency block, was determined to be at least 1% of the emission bandwidth.

The worst case –26dBc bandwidth for the GSM850 band was measured to be 277 kHz, and for the PCS1900 band was measured to be 270 kHz as shown below. This results in a 3.0 kHz resolution bandwidth.

On any frequency outside the frequency block and outside the adjacent 1 MHz bands, a resolution bandwidth of at least 1 MHz was employed.

*Test Data for 850 band and 1900 band selected Frequencies in GSM mode.*

850 band Frequency (MHz)	-26dBc Bandwidth (kHz)	99% Occupied Bandwidth (kHz)
824.2	272	243.3
837.6	277	246.7
848.8	270	245.0

1900 band Frequency (MHz)	-26dBc Bandwidth (kHz)	99% Occupied Bandwidth (kHz)
1850.2	268	241.7
1880.0	268	245.0
1909.8	270	245.0


#### **Measurement Plots for 850 and 1900 in GSM mode**

Refer to the following measurement plots for more detail.

See Figures 1-13a to 1-24a for the plots of the –26dBc Bandwidth and 99% Occupied Bandwidth.

See Figures 1-25a to 1-28a for plots of the channel mask results.

The RF power output was at maximum for all the recorded measurements shown below.

	EMI Test Report for the BlackBerry® smartphone Model RCX71UW	
	<b>APPENDIX 1A</b>	
Test Report No. RTS-2474-1002-50	Dates of Test January 29 to February 23, 2010	Author Data Fahd Faisal

GSM Conducted RF Emission Test Data cont'd

*Test Data for 850 and 1900 bands selected Frequencies in EDGE mode.*

850 band Frequency (MHz)	99% Occupied Bandwidth (kHz)
824.2	243.3
837.6	243.3
848.8	241.7

1900 band Frequency (MHz)	99% Occupied Bandwidth (kHz)
1850.2	241.7
1880.0	241.7
1909.8	245.0

***Measurement Plots for 850 and 1900 bands in EDGE mode***


Refer to the following measurement plots for more detail.

See Figures 1-29a to 1-34a for the plots of the 99% Occupied Bandwidth.

See Figures 1-35a to 1-38a for the plots of channel mask EDGE results.

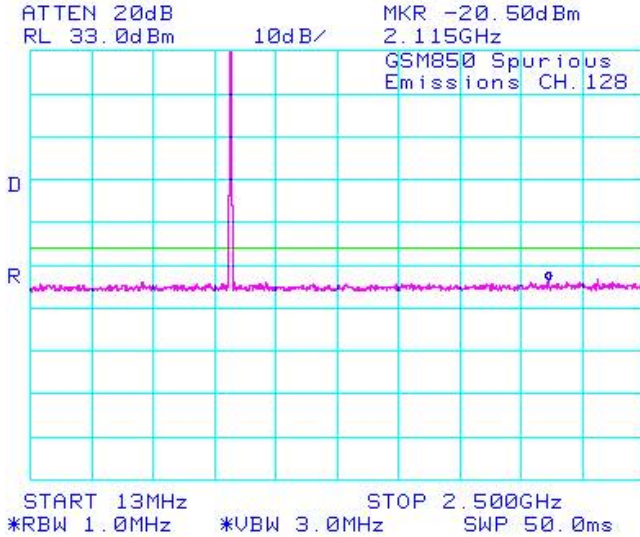
The RF power output was at maximum for all the recorded measurements shown below.



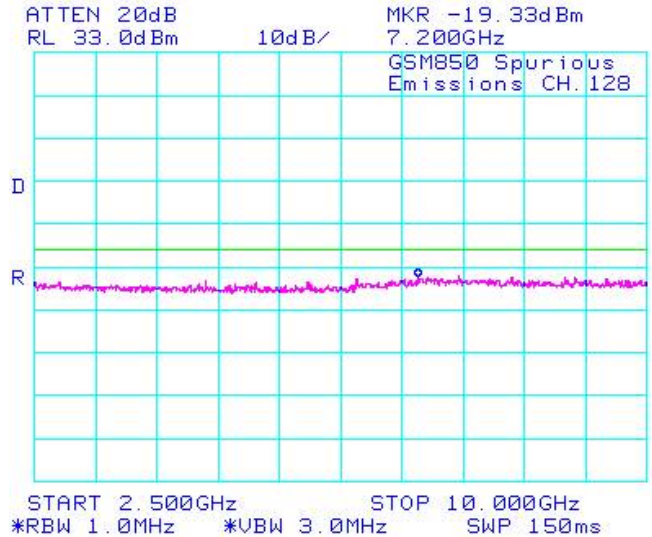
		EMI Test Report for the BlackBerry® smartphone Model RCX71UW <b>APPENDIX 1A</b>	
Test Report No. RTS-2474-1002-50	Dates of Test January 29 to February 23, 2010	Author Data Fahd Faisal	

GSM Conducted RF Emission Test Data cont'd

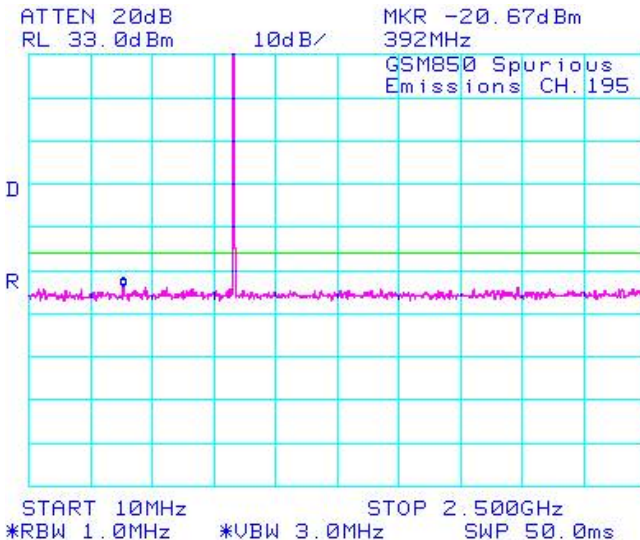
**Figure 1-1a: GSM850 band, Spurious Conducted Emissions, Low channel**



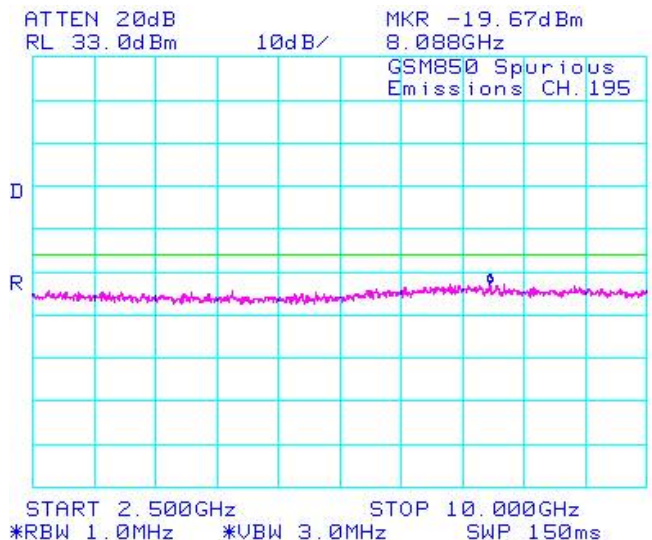
**Figure 1-2a: GSM850 band, Spurious Conducted Emissions, Low channel**




**Figure 1-3a: GSM850 band, Spurious Conducted Emissions, Middle Channel**



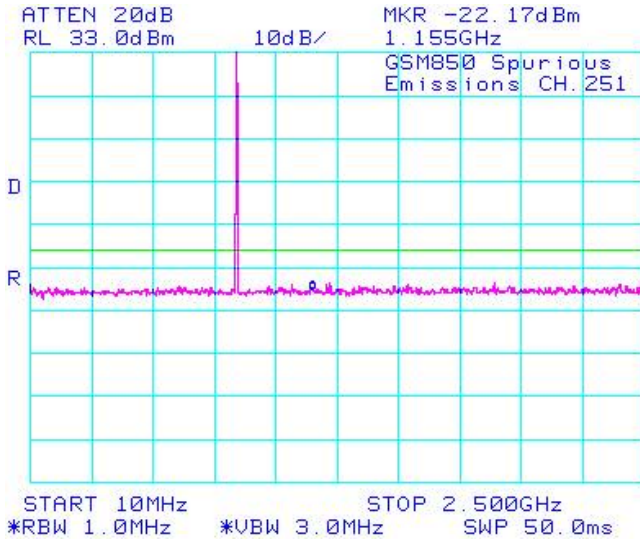
**Figure 1-4a: GSM850 band, Spurious Conducted Emissions, Middle Channel**



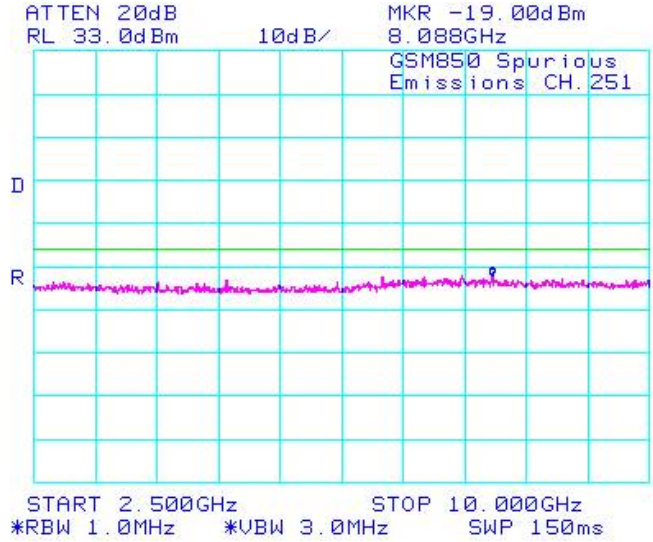
	EMI Test Report for the BlackBerry® smartphone Model RCX71UW	
	<b>APPENDIX 1A</b>	
Test Report No. RTS-2474-1002-50	Dates of Test January 29 to February 23, 2010	Author Data Fahd Faisal

### GSM Conducted RF Emission Test Data cont'd

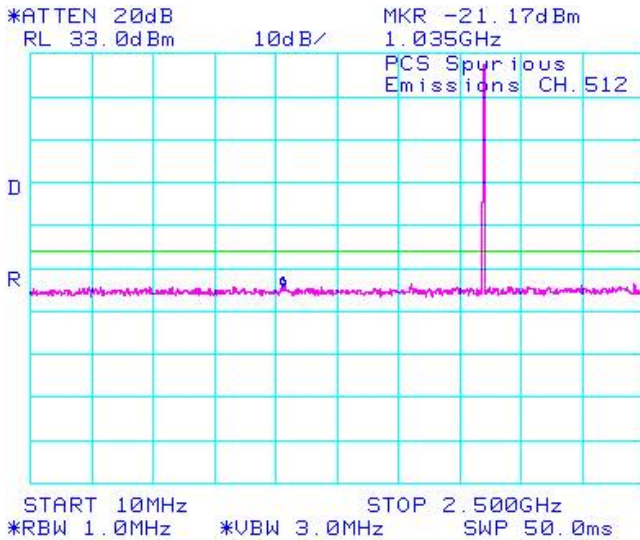
**Figure 1-5a: GSM850 band, Spurious Conducted Emissions, High Channel**



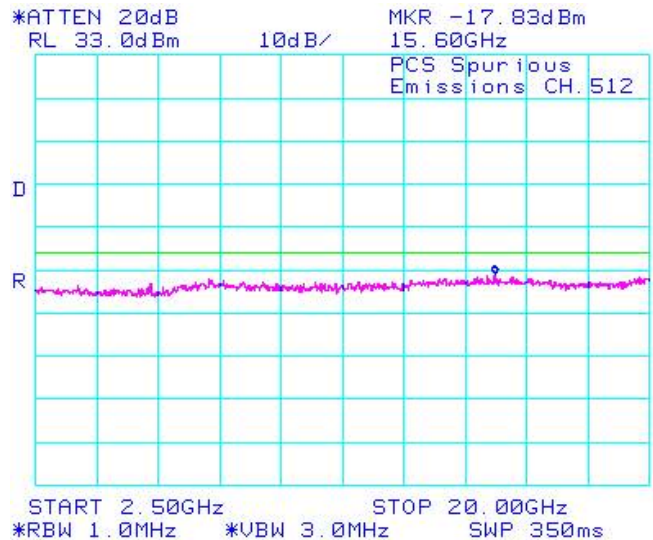
**Figure 1-6a: GSM850 band, Spurious Conducted Emissions, High Channel**




**Figure 1-7a: PCS1900 band, Spurious Conducted Emissions, Low Channel**



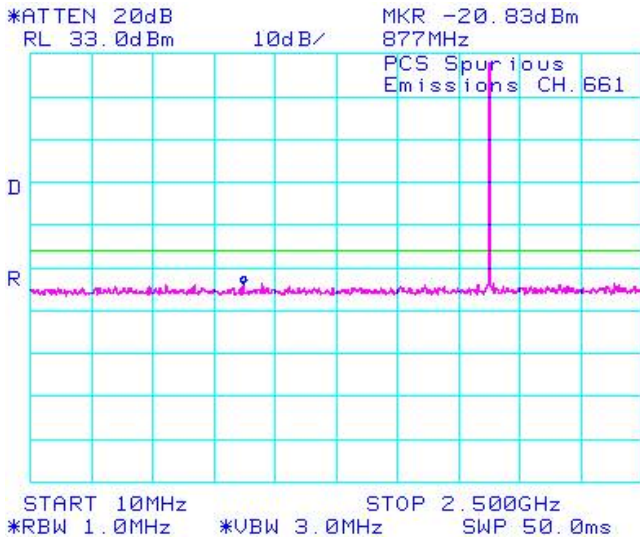
**Figure 1-8a: PCS1900 band, Spurious Conducted Emissions, Low Channel**



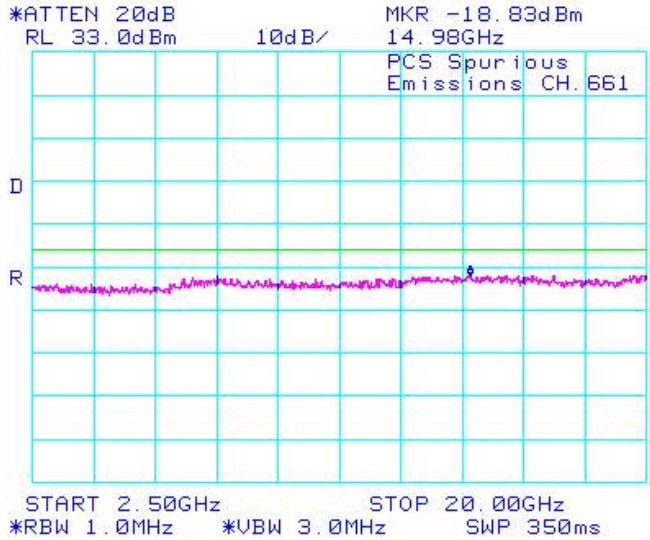
	EMI Test Report for the BlackBerry® smartphone Model RCX71UW	
	<b>APPENDIX 1A</b>	
Test Report No. RTS-2474-1002-50	Dates of Test January 29 to February 23, 2010	Author Data Fahd Faisal

### GSM Conducted RF Emission Test Data cont'd

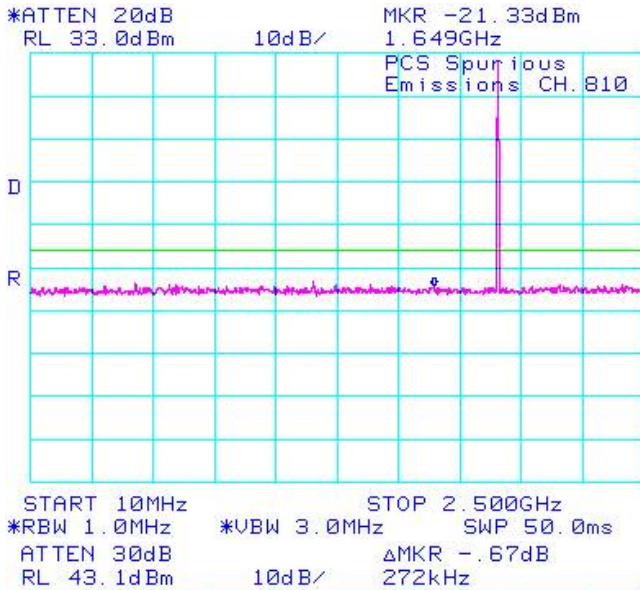
**Figure 1-9a: PCS1900 band, Spurious Conducted Emissions, Middle Channel**



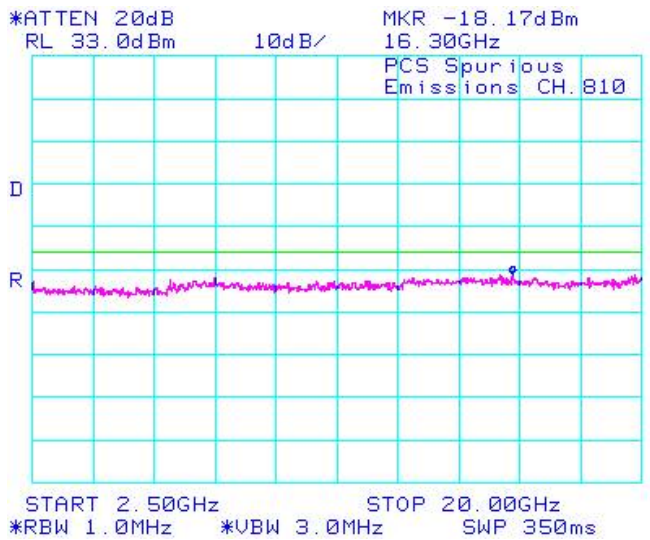
**Figure 1-10a: PCS1900 band, Spurious Conducted Emissions, Middle Channel**



**Figure 1-11a: PCS1900 band, Spurious Conducted Emissions, High Channel**

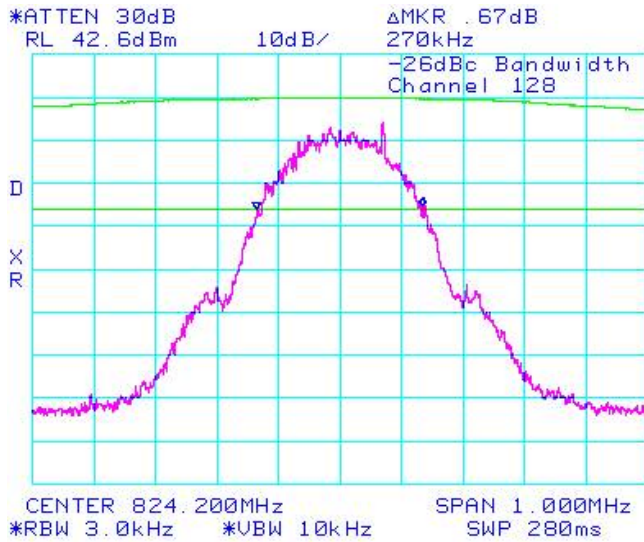


**Figure 1-12a: PCS1900 band, Spurious Conducted Emissions, High Channel**

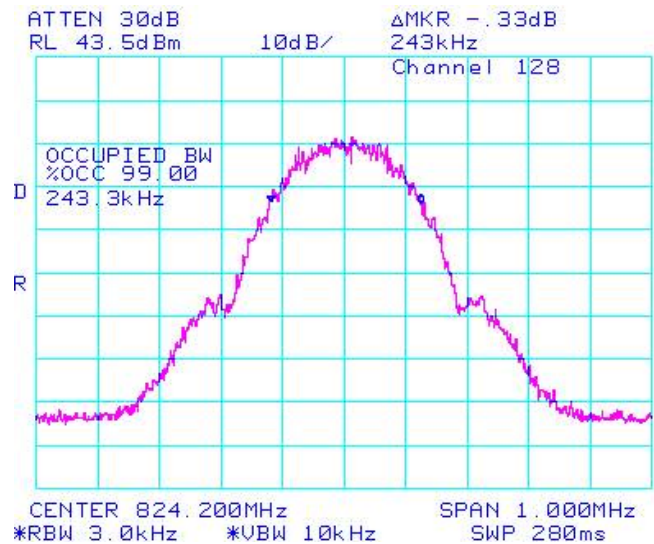


**GSM Conducted RF Emission Test Data cont'd**

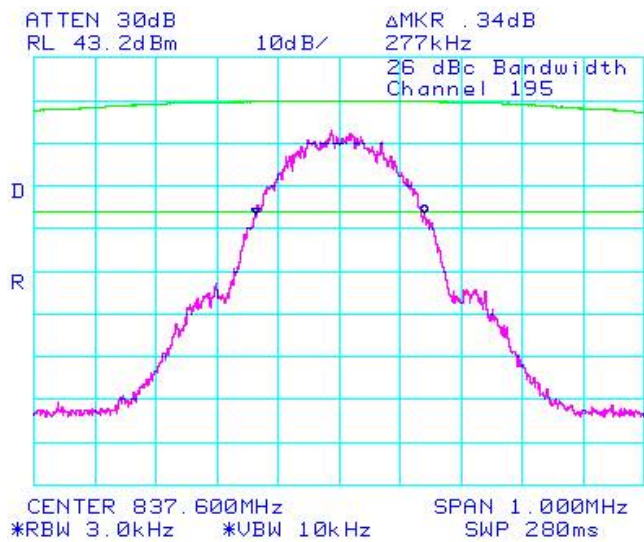
**Figure 1-13a: -26dBc bandwidth, GSM850 band Low Channel in GSM mode**



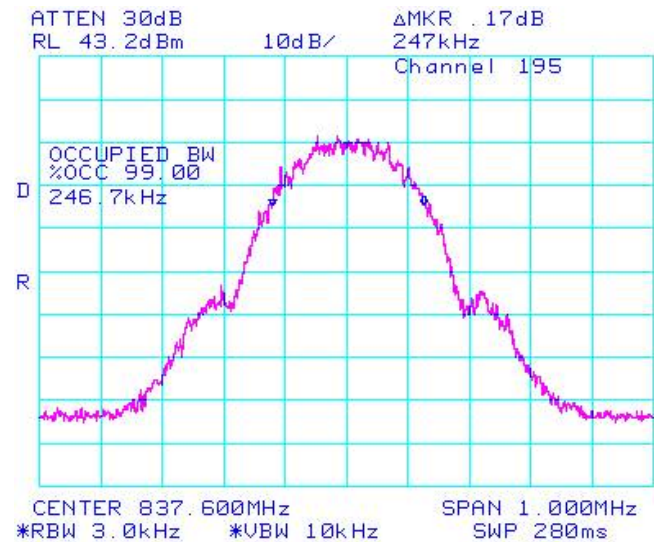
**Figure 1-14a: Occupied Bandwidth, GSM850 band Low Channel in GSM mode**




**Figure 1-15a: -26dBc bandwidth, GSM850 band Middle Channel in GSM mode**



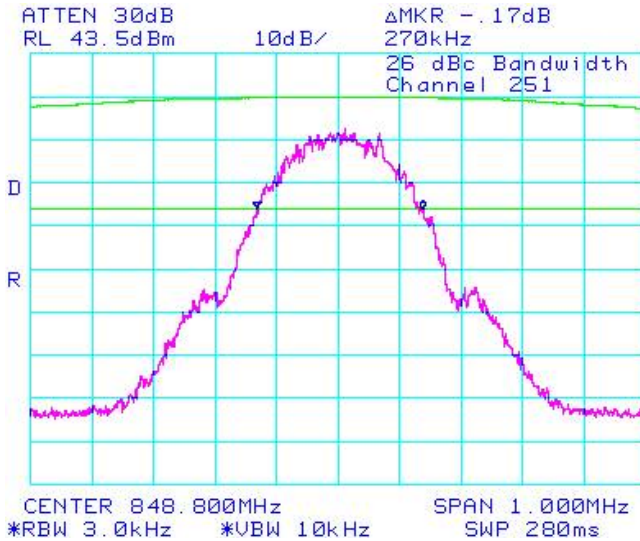
**Figure 1-16a: Occupied Bandwidth, GSM850 band Middle Channel in GSM mode**



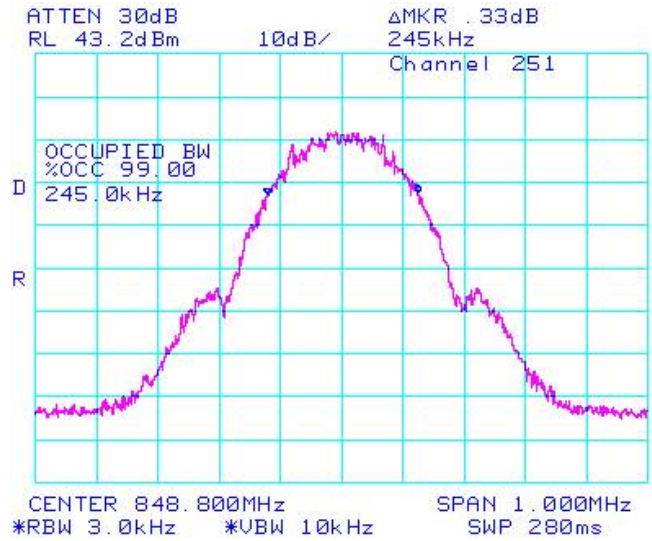
	EMI Test Report for the BlackBerry® smartphone Model RCX71UW	
	<b>APPENDIX 1A</b>	
Test Report No. RTS-2474-1002-50	Dates of Test January 29 to February 23, 2010	Author Data Fahd Faisal

### GSM Conducted RF Emission Test Data cont'd

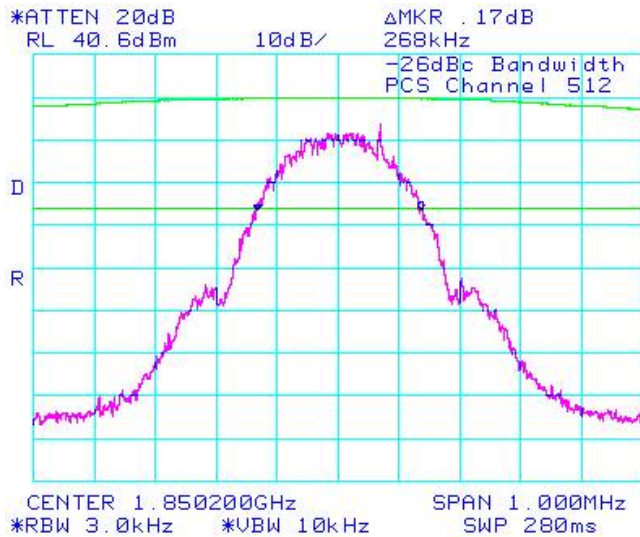
**Figure 1-17a: -26dBc bandwidth, GSM850 band High Channel in GSM mode**



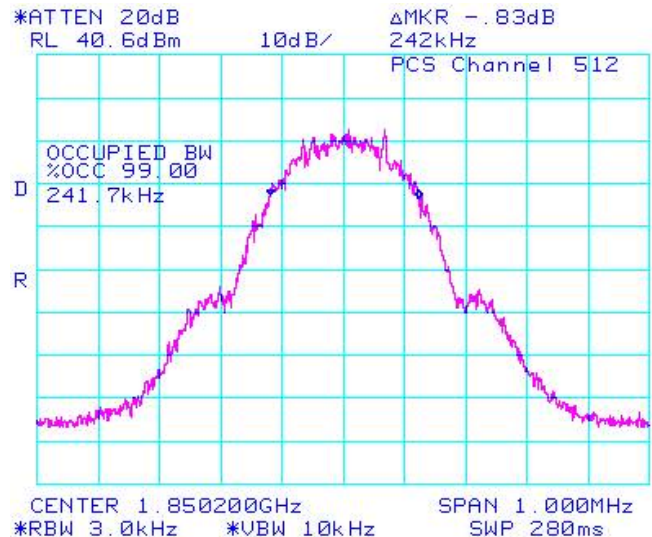
**Figure 1-18a: Occupied Bandwidth, GSM850 band High Channel in GSM mode**



**Figure 1-19a: -26dBc bandwidth, PCS1900 Low Channel in GSM mode**

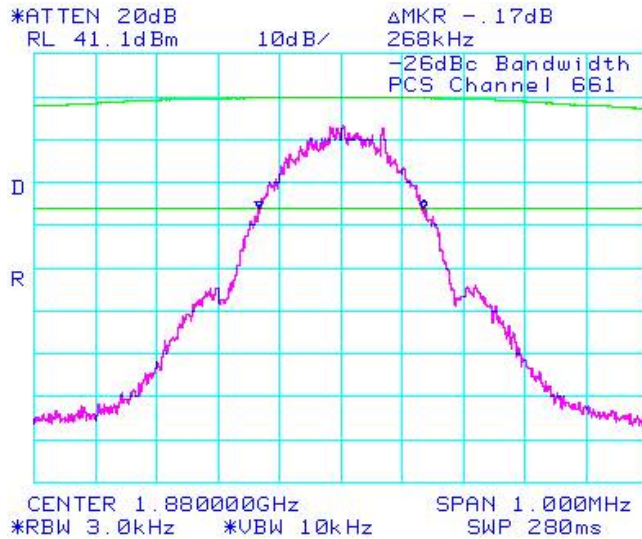


**Figure 1-20a: Occupied Bandwidth, PCS1900 Low Channel in GSM mode**

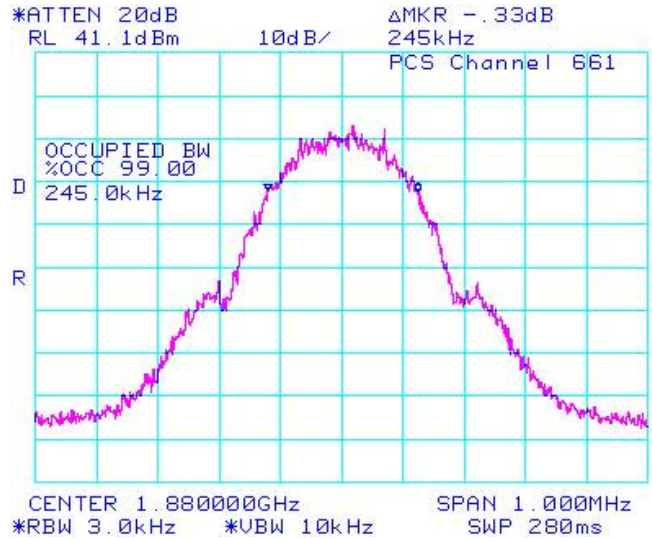


GSM Conducted RF Emission Test Data cont'd

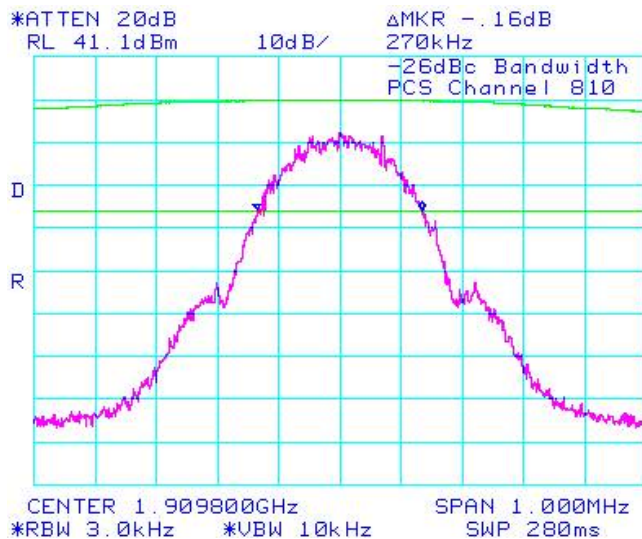
**Figure 1-21a: -26dBc bandwidth, PCS1900  
 Middle Channel in GSM mode**



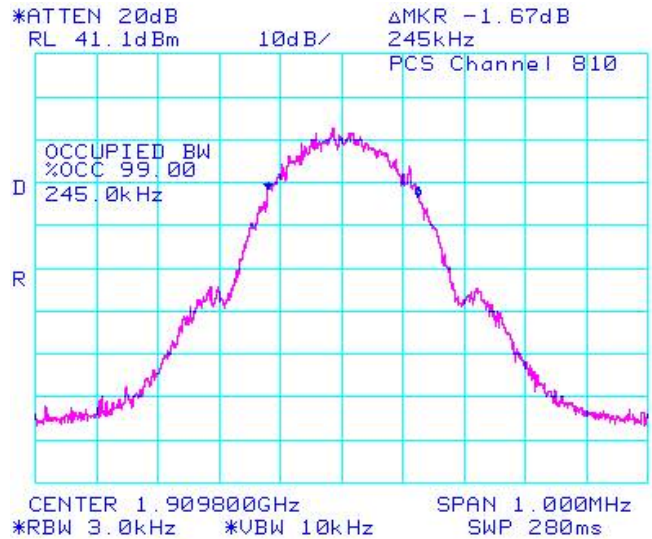
**Figure 1-22a: Occupied Bandwidth, PCS1900  
 Middle Channel in GSM mode**



**Figure 1-23a: -26dBc bandwidth, PCS1900  
 High Channel in GSM mode**

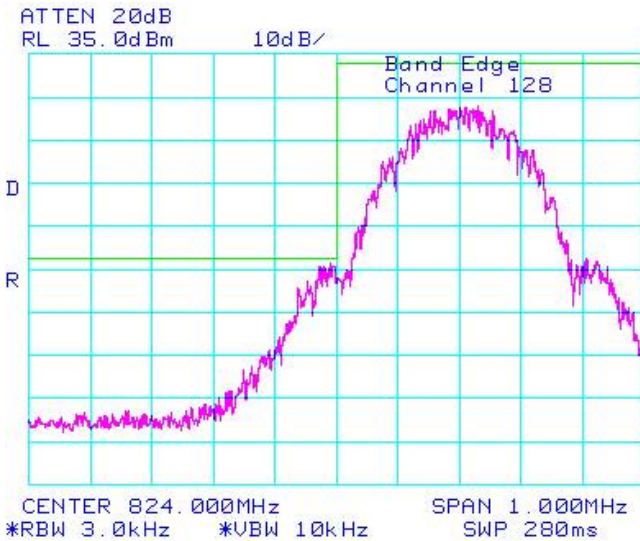


**Figure 1-24a: Occupied Bandwidth, PCS1900  
 High Channel in GSM mode**

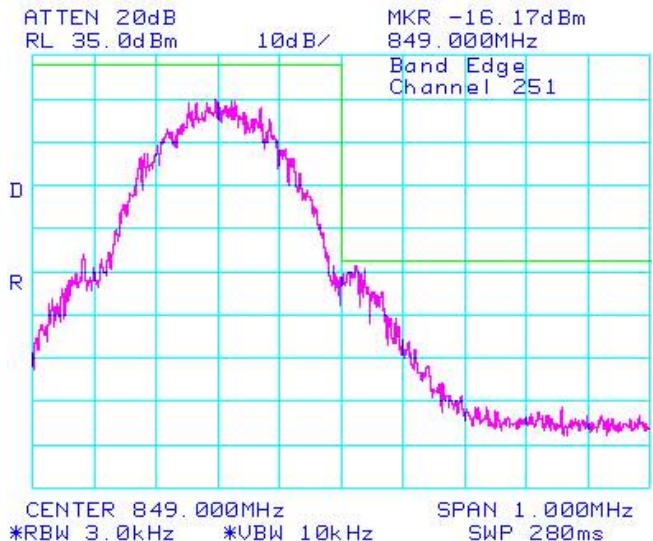


GSM Conducted RF Emission Test Data cont'd

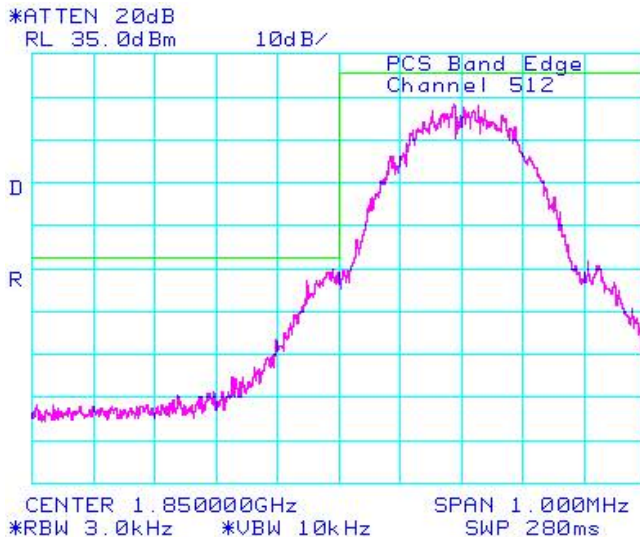
**Figure 1-25a: GSM850 band, Low Channel Mask in GSM mode**



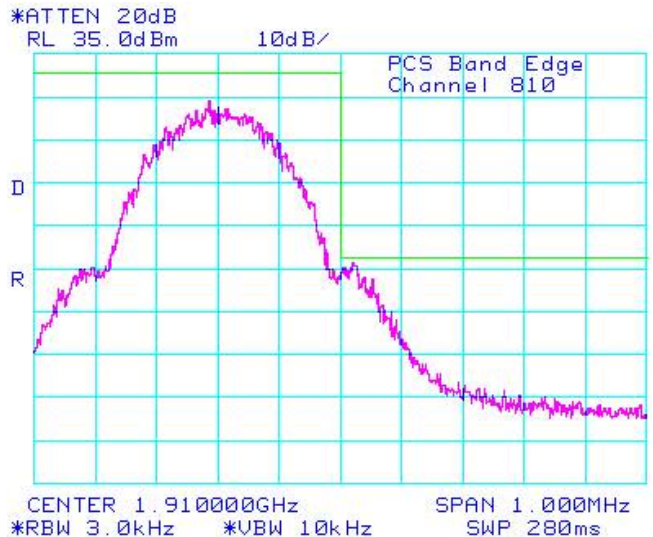
**Figure 1-26a: GSM850 band High Channel Mask in GSM mode**




**Figure 1-27a: PCS1900, Low Channel Mask in GSM mode**



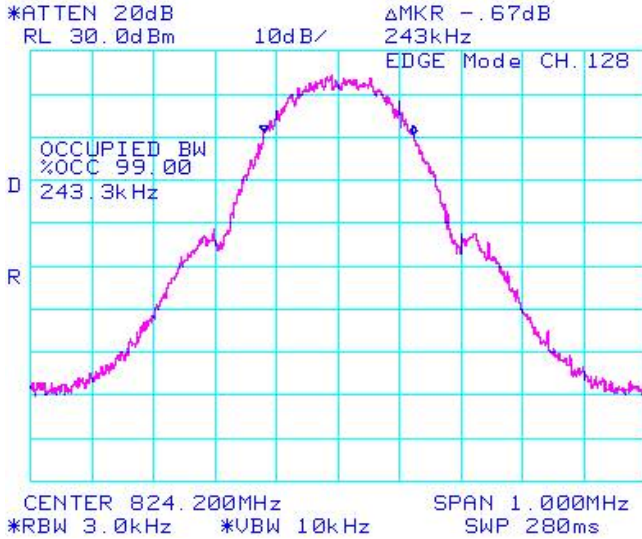
**Figure 1-28a: PCS1900, High Channel Mask in GSM mode**



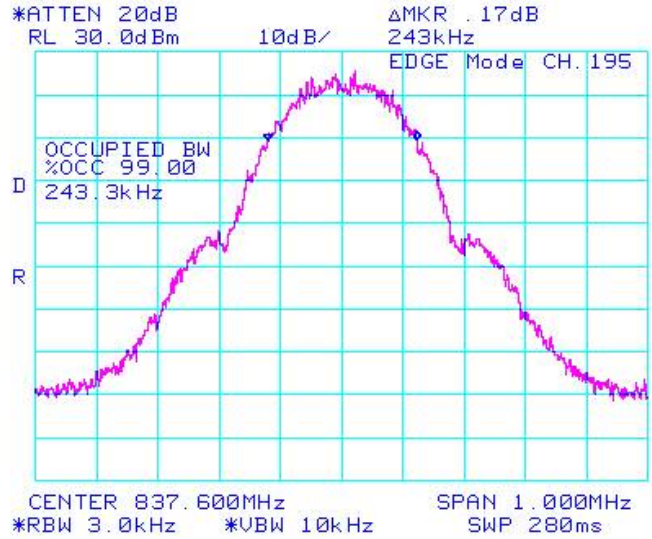
	EMI Test Report for the BlackBerry® smartphone Model RCX71UW	
	<b>APPENDIX 1A</b>	
Test Report No. RTS-2474-1002-50	Dates of Test January 29 to February 23, 2010	Author Data Fahd Faisal

### GSM Conducted RF Emission Test Data cont'd

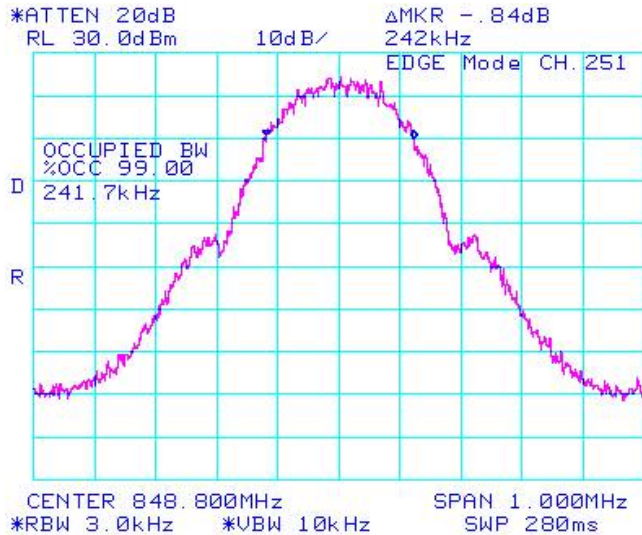
**Figure 1-29a: Occupied Bandwidth, GSM850 Band, Low Channel in EDGE mode**



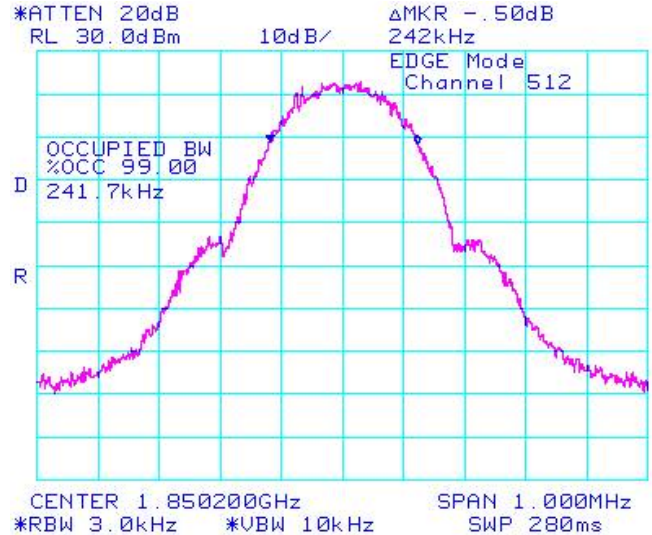
**Figure 1-30a: Occupied Bandwidth, GSM850 Band, Middle Channel in EDGE mode**



**Figure 1-31a: Occupied Bandwidth, GSM850 band, High Channel in EDGE mode**



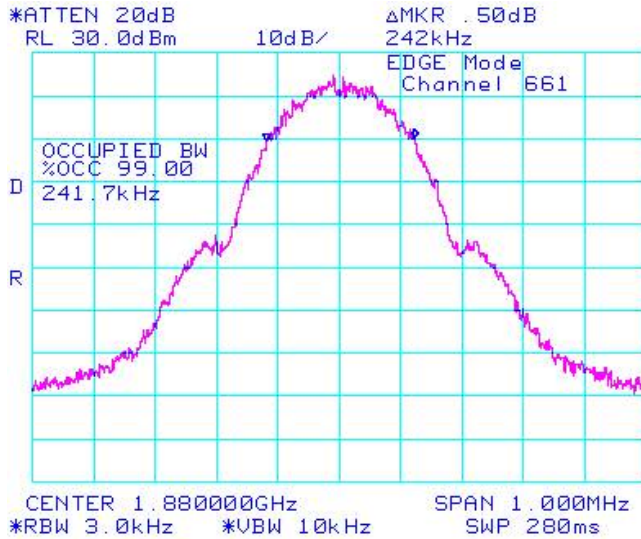
**Figure 1-32a: Occupied Bandwidth, PCS1900 Band, Low Channel in EDGE mode**



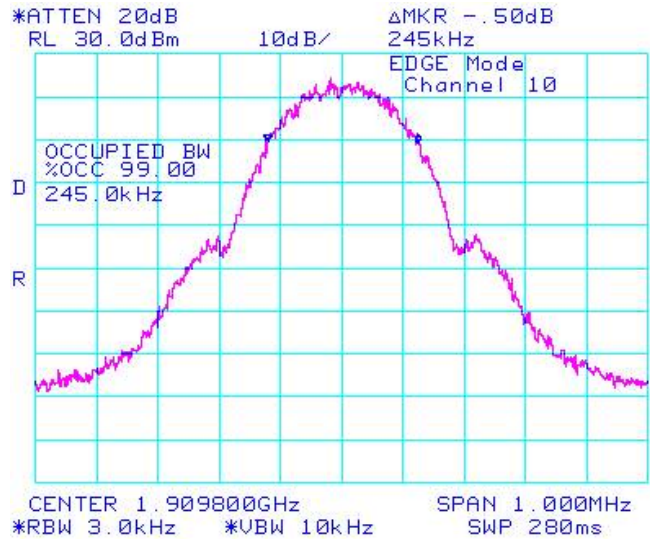


GSM Conducted RF Emission Test Data cont'd

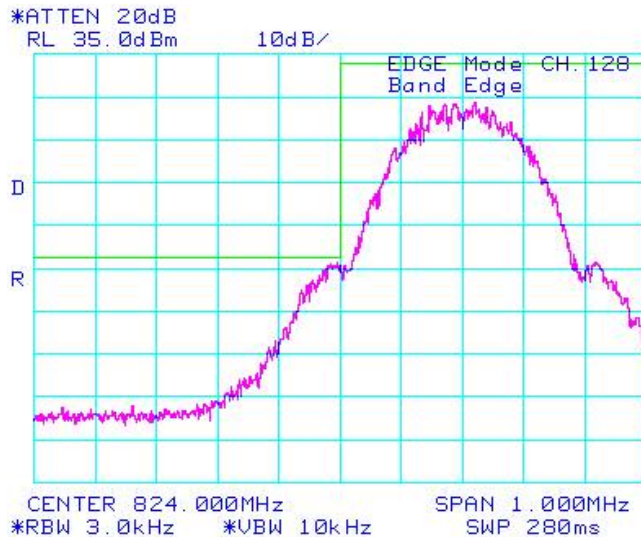
**Figure 1-33a: Occupied Bandwidth, PCS1900 Band, Middle Channel in EDGE mode**



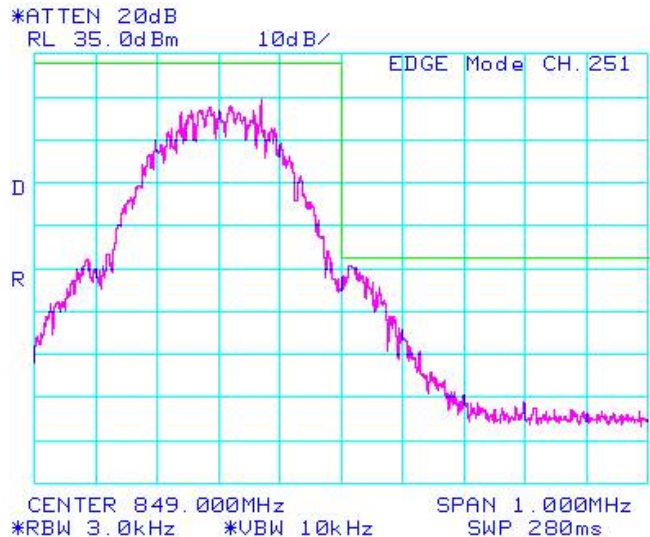
**Figure 1-34a: Occupied Bandwidth, PCS1900 Band, High Channel in EDGE mode**



**Figure 1-35a: GSM850 Band, Low Channel Mask in EDGE mode**

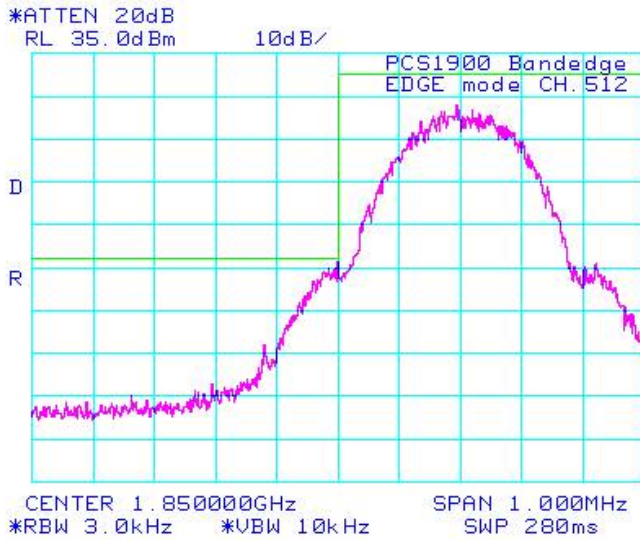


**Figure 1-36a: GSM850 Band, High Channel Mask in EDGE mode**

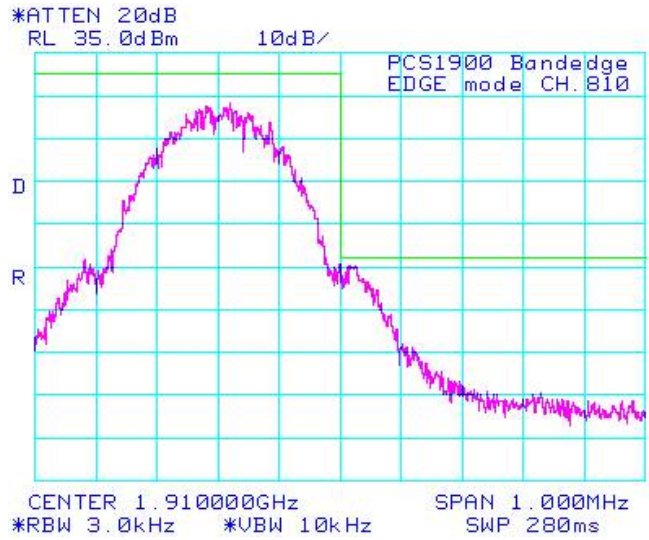


GSM Conducted RF Emission Test Data cont'd


**Figure 1-37a: PCS1900 Band, Low Channel Mask in EDGE mode**



**Figure 1-38a: PCS1900 Band, High Channel Mask in EDGE mode**



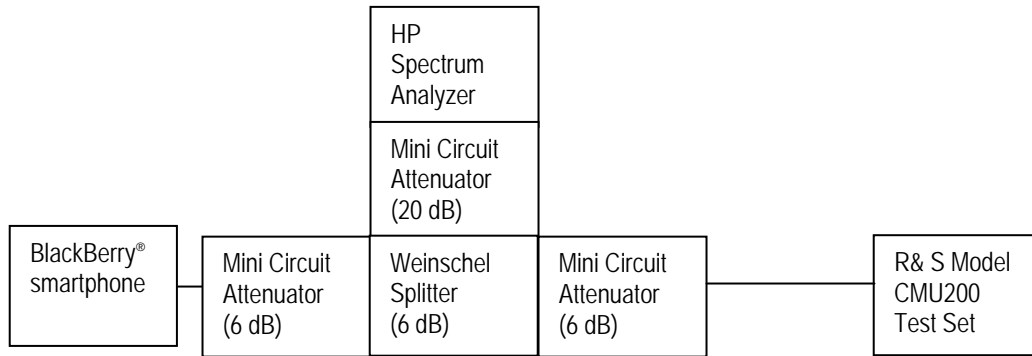
## APPENDIX 1B – WCDMA CONDUCTED RF EMISSIONS TEST DATA/PLOTS

	EMI Test Report for the BlackBerry® smartphone Model RCX71UW	
	<b>APPENDIX 1B</b>	
<b>Test Report No.</b> RTS-2474-1002-50	<b>Dates of Test</b> January 29 to February 23, 2010	<b>Author Data</b> Fahd Faisal

WCDMA Conducted RF Emission Test Data

This appendix contains measurement data pertaining to conducted spurious emissions, 99% power bandwidth and the channel mask on BlackBerry® smartphone.

**Test Setup Diagram**




Date of Test: February 08, 2010

The environmental test conditions were:

Temperature:	23 °C
Pressure:	1010 mb
Relative Humidity:	22 %

The following measurements were performed by Maurice Battler.

	EMI Test Report for the BlackBerry® smartphone Model RCX71UW <b>APPENDIX 1B</b>	
	<b>Test Report No.</b> RTS-2474-1002-50	<b>Dates of Test</b> January 29 to February 23, 2010

WCDMA Conducted RF Emission Test Data cont'd

**The conducted spurious emissions** – As per 47 CFR 27.53 and RSS-139, 6.5 were measured from 10 MHz to 20 GHz. The EUT emissions were in the noise floor. See figures 1-1b to 1-6b for the plots of the conducted spurious emissions.

**-26 dBc Bandwidth and Occupied Bandwidth (99%)**

For each carrier frequency of low, middle and high, the modulation spectrum was measured by both methods of 99% power bandwidth and -26 dBc bandwidth.

The resolution bandwidth required for out-of-band emissions in the 1 MHz bands immediately outside and adjacent to the frequency block, was determined to be at least 1% of the emission bandwidth.

The worst case -26dBc bandwidth for the UMTS1700 band was measured to be 4.175 MHz as shown below. This results in a 3.0 kHz resolution bandwidth.

On any frequency outside the frequency block and outside the adjacent 1 MHz bands, a resolution bandwidth of at least 2 MHz was employed.

*Test Data for 1700 band selected Frequencies in UMTS mode.*

<b>1700 band Frequency (MHz)</b>	<b>-26dBc Bandwidth (MHz)</b>	<b>99% Occupied Bandwidth (MHz)</b>
1712.4	4.667	4.175
1732.6	4.692	4.175
1752.6	4.667	4.167


**Measurement Plots for 1700 band in UMTS mode**

Refer to the following measurement plots for more detail.

See Figures 1-7b to 1-12b for the plots of the -26dBc Bandwidth and 99% Occupied Bandwidth.

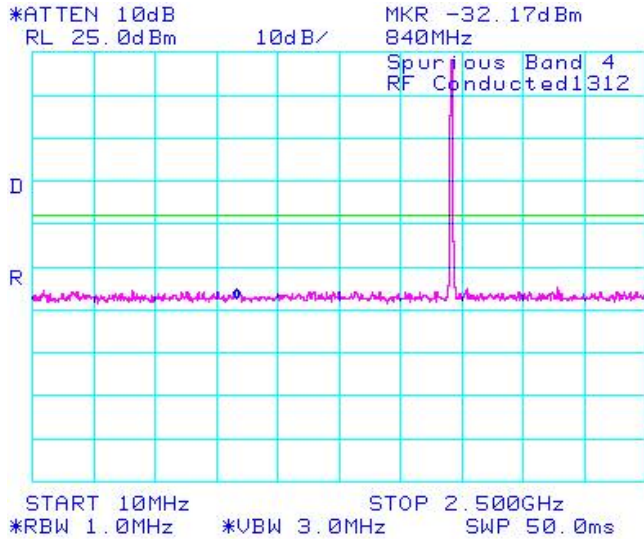
See Figures 1-13b to 1-14b for plots of the channel mask results.

The RF power output was at maximum for all the recorded measurements shown below.

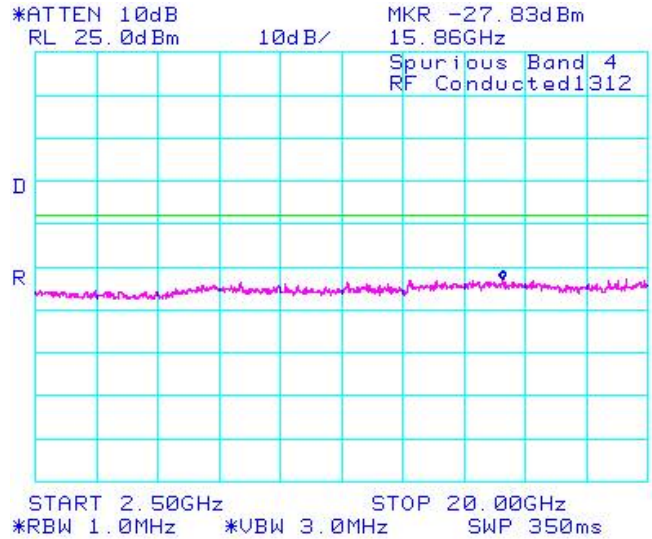
	EMI Test Report for the BlackBerry® smartphone Model RCX71UW <b>APPENDIX 1B</b>	
<b>Test Report No.</b> RTS-2474-1002-50	<b>Dates of Test</b> January 29 to February 23, 2010	<b>Author Data</b> Fahd Faisal

WCDMA Conducted RF Emission Test Data cont'd

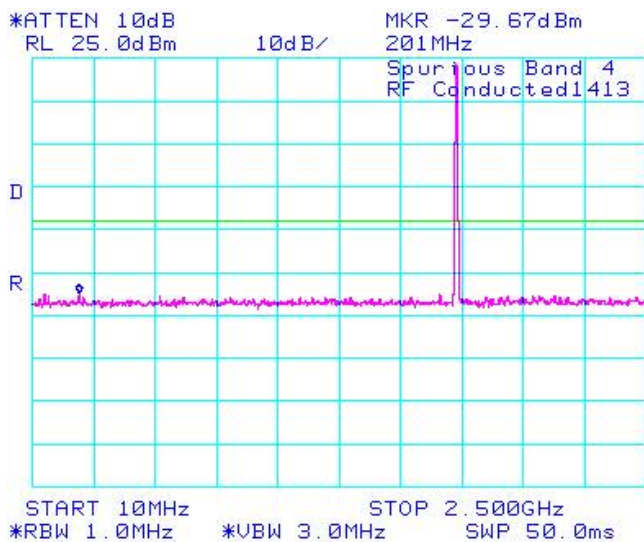
**Figure 1-1b: UMTS1700 band, Spurious Conducted Emissions, Low channel**



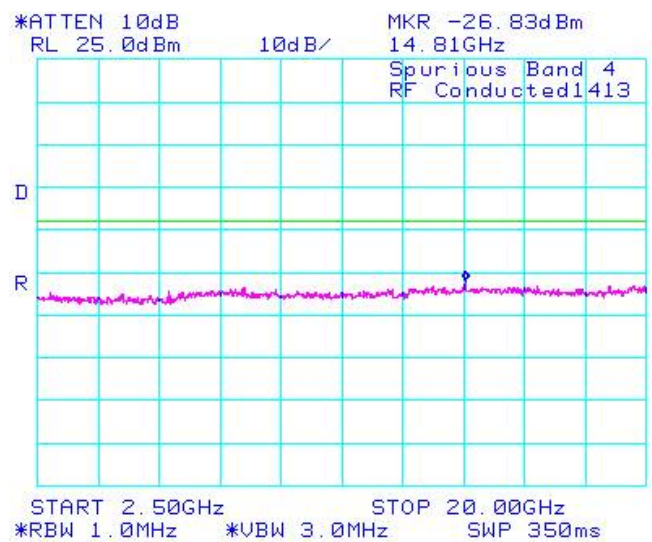
**Figure 1-2b: UMTS1700 band, Spurious Conducted Emissions, Low channel**




**Figure 1-3b: UMTS1700 band, Spurious Conducted Emissions, Middle Channel**



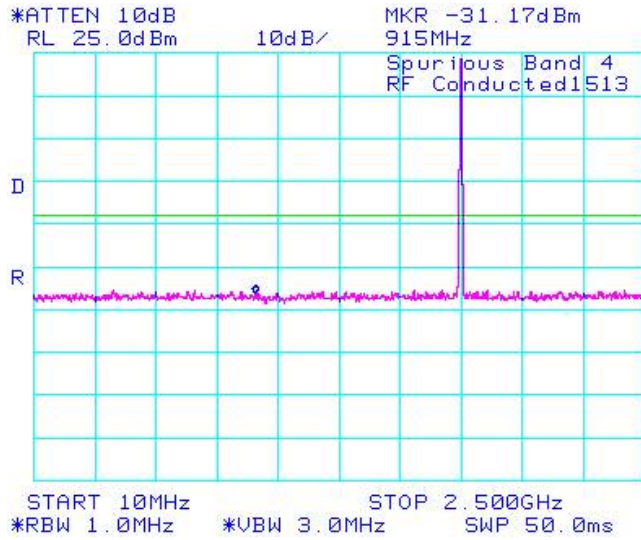
**Figure 1-4b: UMTS1700 band, Spurious Conducted Emissions, Middle Channel**



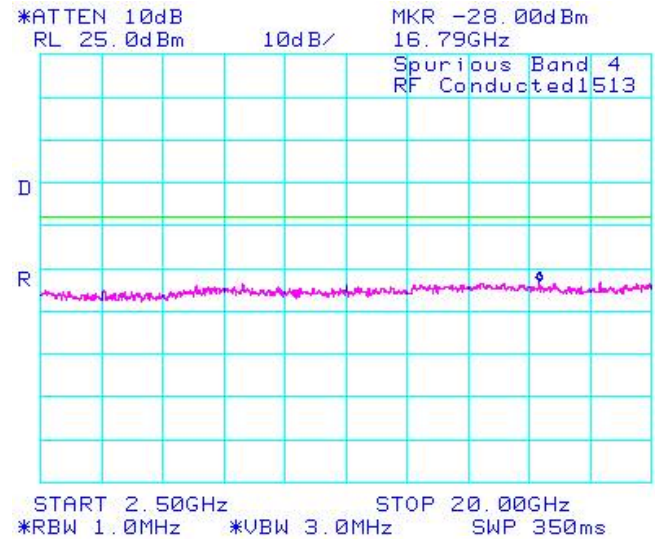
	EMI Test Report for the BlackBerry® smartphone Model RCX71UW <b>APPENDIX 1B</b>	
<b>Test Report No.</b> RTS-2474-1002-50	<b>Dates of Test</b> January 29 to February 23, 2010	<b>Author Data</b> Fahd Faisal

WCDMA Conducted RF Emission Test Data cont'd

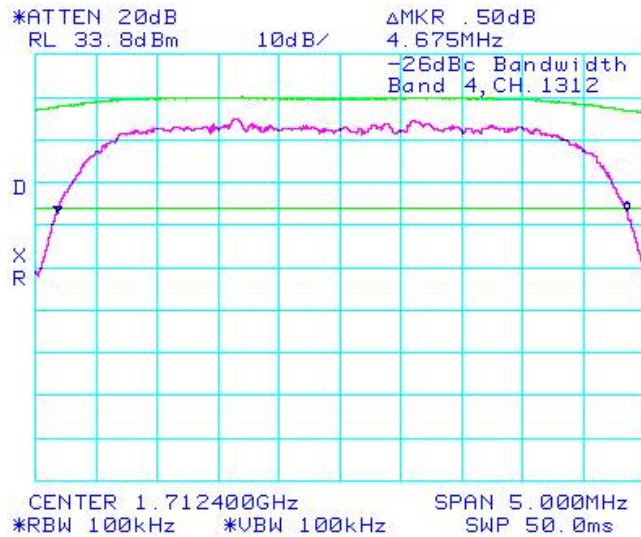
**Figure 1-5b: UMTS1700 band, Spurious Conducted Emissions, High Channel**



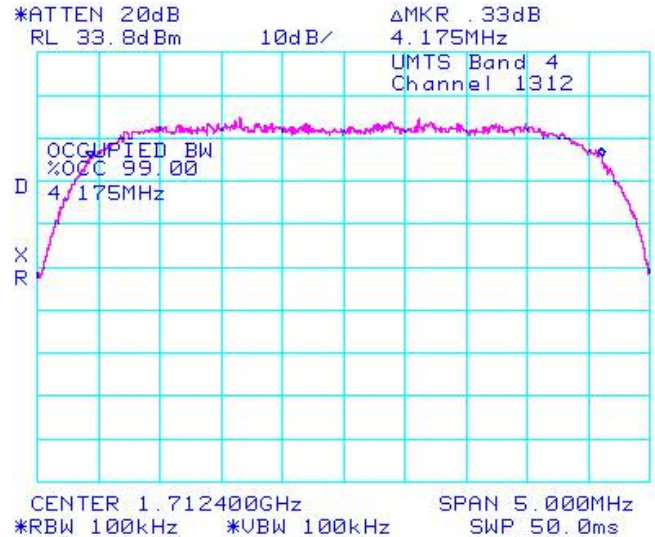
**Figure 1-6b: UMTS1700 band, Spurious Conducted Emissions, High Channel**



**Figure 1-7b: -26dBc bandwidth, UMTS1700 band Low Channel**



**Figure 1-8b: Occupied Bandwidth, UMTS1700 band Low Channel**



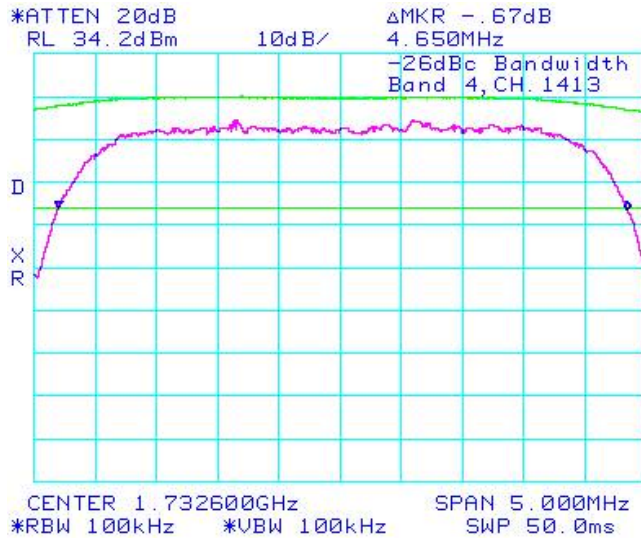
Test Report No.  
 RTS-2474-1002-50

Dates of Test  
 January 29 to February 23, 2010

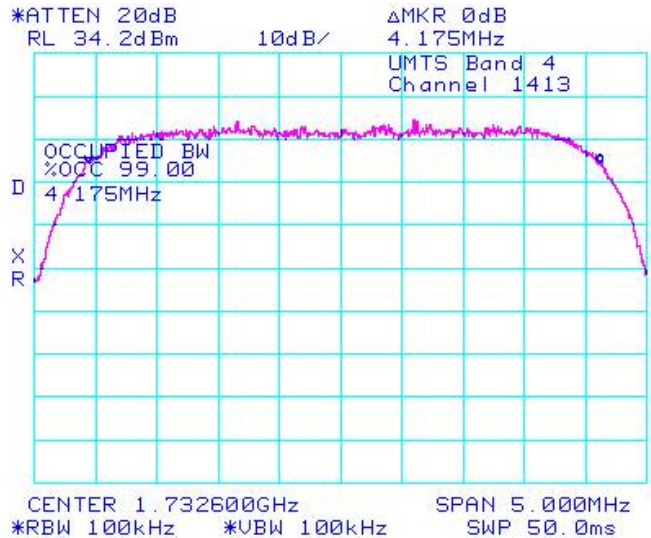
Author Data  
 Fahd Faisal

WCDMA Conducted RF Emission Test Data cont'd

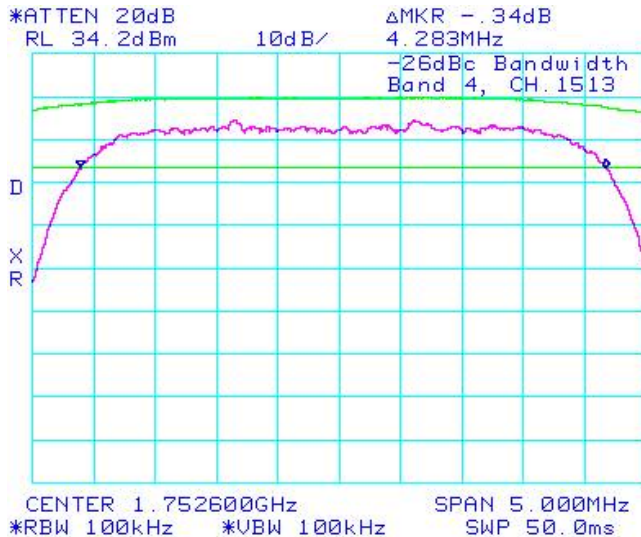
**Figure 1-9b: -26dBc bandwidth, UMTS1700 band Middle Channel**



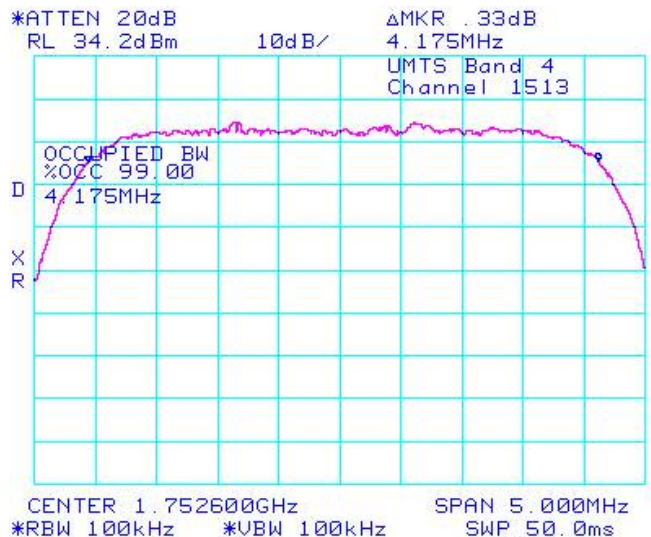
**Figure 1-10b: Occupied Bandwidth, UMTS1700 band Middle Channel**



**Figure 1-11b: -26dBc bandwidth, UMTS1700 band High Channel**



**Figure 1-12b: Occupied Bandwidth, UMTS1700 band High Channel**





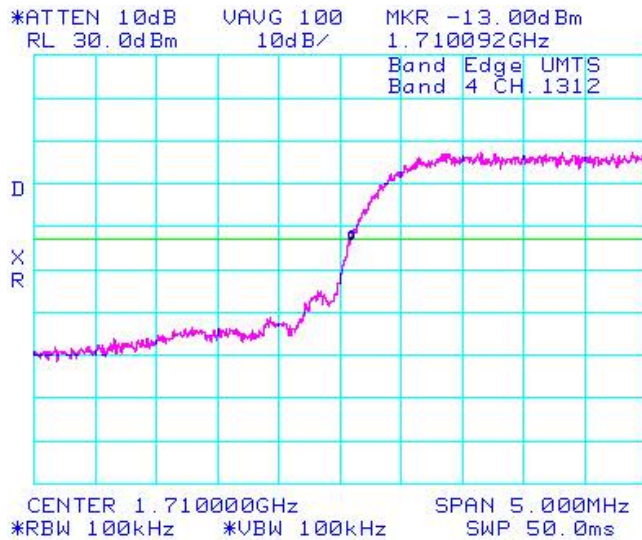
**Test Report No.**  
 RTS-2474-1002-50

**Dates of Test**  
 January 29 to February 23, 2010

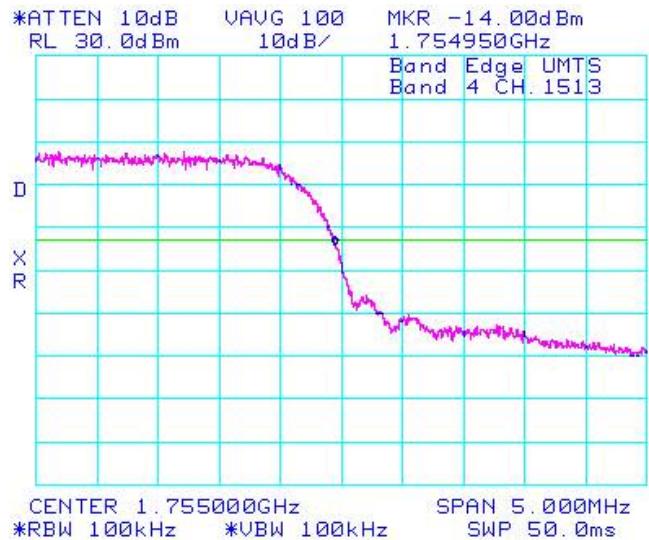
**Author Data**  
 Fahd Faisal

WCDMA Conducted RF Emission Test Data cont'd


**Figure 1-13b: UMTS1700 band, Low Channel Mask**



**Figure 1-14b: UMTS1700 band High Channel Mask**



## APPENDIX 2A – GSM CONDUCTED RF OUTPUT POWER TEST DATA

		EMI Test Report for the BlackBerry® smartphone Model RCX71UW <b>APPENDIX 2A</b>	
Test Report No. RTS-2474-1002-50	Dates of Test January 29 to February 23, 2010	Author Data Fahd Faisal	

### GSM Conducted RF Output Power Test Data

The following measurements were performed by Daoud Attayi.

The conducted RF output power was measured on the BlackBerry® smartphone using the Communication Tester, Rohde & Schwarz, model CMU 200. The low, middle and high channels were measured at maximum radio output power. The insertion loss of the coaxial cable from the CMU 200 to the BlackBerry® smartphone was compensated for in the measurements.

Peak nominal output power is 33.0 dBm ±0.5 dB for GSM850 and 30.5 dBm ±0.5 dB for PCS. Peak nominal output power is 30.6 dBm ±0.5 dB for GSM850 EDGE Mode (2-timeslot uplink) and 28.0 dBm ±0.5 dB for PCS EDGE Mode (2-timeslot uplink).


Date of Test: February 019, 2010

The environmental test conditions were:

Temperature:	23 °C
Pressure:	1002 mb
Relative Humidity:	23 %

Channel	Frequency (MHz)	Maximum Output Power (dBm)	Maximum Output Power (Watts)	Channel	Frequency (MHz)	Maximum Output Power (dBm)	Maximum Output Power (Watts)
<u>GSM850</u>				<u>GSM850 EDGE/GPRS/GSM (2-timeslot)</u>			
128	824.20	32.7	1.86	128	824.20	30.3	1.07
189	837.60	33.1	2.04	189	837.60	30.7	1.17
251	848.80	33.4	2.19	251	848.80	31.1	1.29
<u>PCS</u>				<u>PCS EDGE/GPRS/GSM (2-timeslot)</u>			
512	1850.2	30.3	1.07	512	1850.2	27.7	0.59
661	1880.0	30.5	1.12	661	1880.0	28.5	0.71
810	1909.8	31.0	1.26	810	1909.8	28.5	0.71

## APPENDIX 2B – WCDMA CONDUCTED RF OUTPUT POWER TEST DATA

	EMI Test Report for the BlackBerry® smartphone Model RCX71UW	
	<b>APPENDIX 2B</b>	
Test Report No. RTS-2474-1002-50	Dates of Test January 29 to February 23, 2010	Author Data Fahd Faisal

### WCDMA Conducted RF Output Power Test Data

The following measurements were performed by Daoud Attayi.

The conducted RF output power was measured on the BlackBerry® smartphone using the Communication Tester, Rohde & Schwarz, model CMU 200. The low, middle and high channels were measured at maximum radio output power. The insertion loss of the coaxial cable from the CMU 200 to the BlackBerry® smartphone was compensated for in the measurements.

Peak nominal output power is 24.0 dBm ±0.5 dB for UMTS1700.


Date of Test: February 019, 2010

The environmental test conditions were:

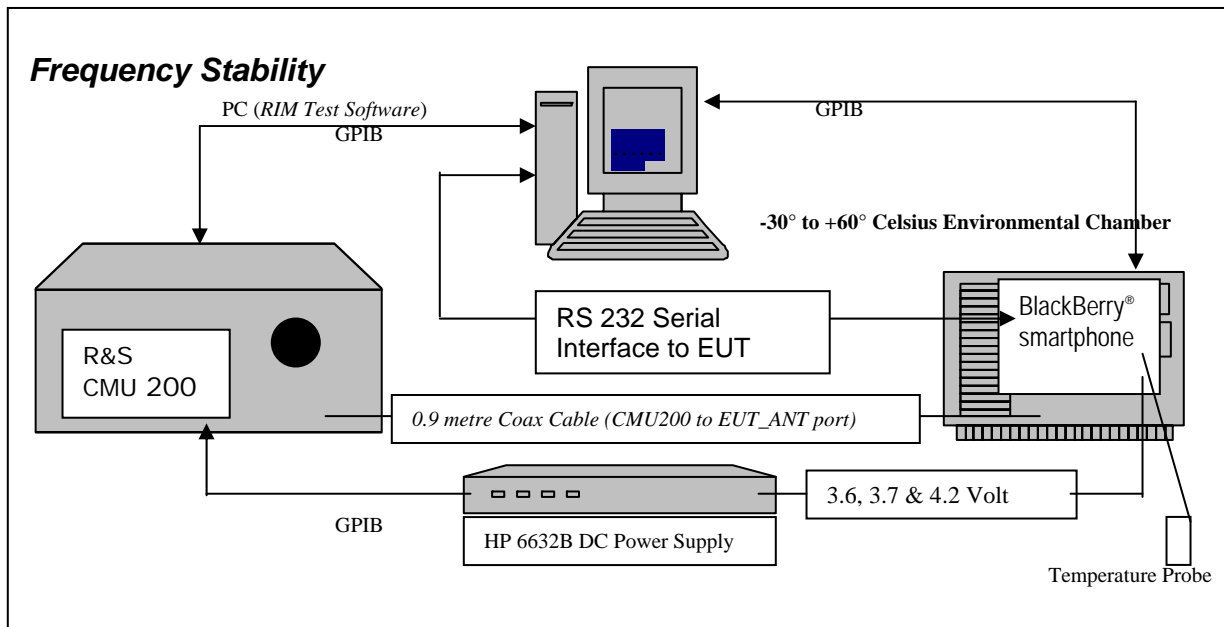
Temperature:	23 °C
Pressure:	1002 mb
Relative Humidity:	23 %

	Band	FDD IV (1700)		
	Channel	1312	1413	1513
	Freq (MHz)	1712.4	1732.6	1752.6
Mode	Subtest	Conducted Transmit Power (dBm)		
Rel99	12.2 kbps RMC	24.19	24.40	24.48
Rel99	12.2 kbps AMR, SRB 3.4 kbps	24.18	24.40	24.44
Rel5 HSDPA	1	23.60	24.00	24.10
Rel5 HSDPA	2	23.60	24.00	24.10
Rel5 HSDPA	3	23.70	24.05	24.15
Rel5 HSDPA	4	23.60	24.00	24.20

## APPENDIX 3A – GSM FREQUENCY STABILITY TEST DATA

	EMI Test Report for the BlackBerry® smartphone Model RCX71UW <b>APPENDIX 3A</b>	
	<b>Test Report No.</b> RTS-2474-1002-50	<b>Dates of Test</b> January 29 to February 23, 2010

### GSM Frequency Stability Test Data



The following measurements were performed by Maurice Battler.

CFR 47 Chapter 1 - Federal Communications Commission Rules

#### Part 2 Required Measurements

2.1055 Frequency Stability - Procedures

(a,b) Frequency Stability - Temperature Variation

(d) Frequency Stability - Voltage Variation

#### **24.235** *Frequency Stability.*

*The frequency stability shall be sufficient to ensure that the fundamental emission stays within the authorized frequency block.*

*The EUT meets the requirements as stated in CFR 47 chapter 1, Section 24.235, CFR 47 chapter 1, Section 22.917 and RSS-132, 4.3 Frequency Stability.*

Frequency Stability measurement devices were configured as presented in the block diagram recording frequency, power, data, temperatures, and stepped voltages controlled via a GPIB interface linked to the Environmental chamber, a DC power supply, and the Communications Test Set. A 0.9-metre coax cable was calibrated to characterize the insertion loss for the transmitted frequencies between the RF input/output of the CMU 200 and the EUT antenna port.

Calibration for the Cable Loss was performed in the RF Laboratory using the Agilent power meter and Agilent Signal Generator.

The cable assembly from the RF input to the RF output was measured at the following Frequencies:

Test Report No. RTS-2474-1002-50	Dates of Test January 29 to February 23, 2010	Author Data Fahd Faisal
-------------------------------------	--	----------------------------

PCS1900 Frequency (MHz)	Cable loss (dB)
1850.2	1.20
1880.0	1.20
1909.8	1.20

GSM850 Frequency (MHz)	Cable loss (dB)
824.2	0.90
836.4	0.90
848.6	0.90

**Procedure:**

The EUT was placed in the Temperature chamber and connected to CMU 200 outside as shown in the figure above. Dry air was pumped inside the temperature chamber to maintain a backpressure during the test. The EUT was kept in the off condition at all times except when the following measurements were to be made.


The chamber was switched on and the temperature was set to -30°C. After the chamber stabilized at -30 °C there was a soak period of one hour to alleviate moisture in the chamber, the EUT voltage was enabled. The system software recorded the frequency, power, and associated measurements.

A Computer system controlled the automated software. This application was given the command of activating all machines intrinsic to the temperature and voltage tests controlling the CMU 200 via the GPIB Bus. The Environmental Chamber was instructed through an RS-232 serial line. The EUT dialogue was passed through a serial connection.

The EUT repetitively transmitted 100 bursts for each set of programmed parameters recording temperature, voltage settings, and systematically selected frequencies. The power supply was cycled from minimum voltage 3.6 volts, to 3.7 volts to 4.2 volts maximum voltage. The frequency error was measured at a maximum output power and recorded by the automated system test software.

The EUT output power and frequency was measured at 3.6 volts, 3.7 volts and 4.2 volts. The transmit frequency was varied in 3 steps consisting of 824.2, 836.4, and 848.6 MHz for the GSM850 band, 1850.2, 1880.0 and 1909.8 MHz for the PCS1900 band. This frequency was recorded in MHz and deviation from nominal, in Parts Per Million. After the initial one-hour soak at the beginning of the tests, a period of thirty minutes soak was initialized between each ascending temperature step, before proceeding to the next measurement test cycle.



	EMI Test Report for the BlackBerry® smartphone Model RCX71UW	
	<b>APPENDIX 3A</b>	
Test Report No. RTS-2474-1002-50	Dates of Test January 29 to February 23, 2010	Author Data Fahd Faisal

## PROCEDURE:

The test system software for commencing the Frequency Stability Tests carried through the following cycle.

1. Switch on the HP 6632B power supply; CMU 200 Communications test Set, and Environmental Chamber.
2. Start test program
3. Set the Temperature to  $-30^{\circ}\text{C}$  and maintain a period of one- hour soak time, with the EUT supply voltage disabled.
4. Set power supply voltage to 3.6 volts.
5. Set up CMU 200 Radio Communication Tester.
6. Command the CMU 200 to switch to the low channel.
7. Enable the voltage to the EUT, and connect a link to the CMU 200 test set.
8. EUT is commanded to Transmit 100 Bursts.
9. Software logs the following data from the CMU 200, power supply and temperature chamber: Traffic Channel Number, Traffic Channel Frequency, Power Level, Chamber Temperature, Supply Voltage, Power and Frequency Error.
10. The CMU 200 commands the EUT to change frequency to the middle channel and high channel and repeats steps 7 to 9.
11. Repeat steps 5 to 10 changing the supply voltage to 3.7 Volts
12. Increase temperature by  $10^{\circ}\text{C}$  and soak for 1/2 hour.
13. Repeat steps 4 - 12 for temperatures  $-30^{\circ}\text{C}$  to  $60^{\circ}\text{C}$ .
14. Repeat steps 5 to 10 changing the supply voltage to 4.2 volts

Procedure 5 to 10 was repeated at room temperature ( $20^{\circ}\text{C}$ ) with the power supply voltage set to 3.6, 3.7 and 4.2 volts.

The maximum frequency error in the GSM850 band measured was **-0.0519 PPM**.  
The maximum frequency error in the PCS1900 band measured was **-0.0399 PPM**.

Test Report No. RTS-2474-1002-50	Dates of Test January 29 to February 23, 2010	Author Data Fahd Faisal
-------------------------------------	--	----------------------------

GSM850 Channel results: channels 128, 189 and 250 @ 20°C maximum transmitted power

The BlackBerry® smartphone PIN 21BE04F2 was tested on February 03, 2010.

Traffic Channel Number	GSM850 Frequency (MHz)	Voltage (Volts)	Temperature (Celsius)	Frequency Error (Hz)	PPM
128	824.20	3.6	20	30.03	0.0364
189	836.40	3.6	20	24.86	0.0297
250	848.60	3.6	20	22.41	0.0264

Traffic Channel Number	GSM850 Frequency (MHz)	Voltage (Volts)	Temperature (Celsius)	Frequency Error (Hz)	PPM
128	824.20	3.7	20	20.86	0.0253
189	836.40	3.7	20	21.83	0.0261
250	848.60	3.7	20	19.18	0.0226

Traffic Channel Number	GSM850 Frequency (MHz)	Voltage (Volts)	Temperature (Celsius)	Frequency Error (Hz)	PPM
128	824.20	4.2	20	23.31	0.0283
189	836.40	4.2	20	25.18	0.0301
250	848.60	4.2	20	25.63	0.0302

Test Report No. RTS-2474-1002-50	Dates of Test January 29 to February 23, 2010	Author Data Fahd Faisal
-------------------------------------	--	----------------------------

GSM850 Results: channel 128 @ maximum transmitted power

Traffic Channel Number	Frequency (MHz)	Voltage (Volts)	Temperature (Celsius)	Frequency Error (Hz)	PPM
128	824.20	3.6	-30	4.91	0.0060
128	824.20	3.6	-20	-17.89	-0.0217
128	824.20	3.6	-10	28.28	0.0343
128	824.20	3.6	0	15.56	0.0189
128	824.20	3.6	10	-7.68	-0.0093
128	824.20	3.6	20	30.03	0.0364
128	824.20	3.6	30	-38.68	-0.0469
128	824.20	3.6	40	-34.68	-0.0421
128	824.20	3.6	50	-35.58	-0.0432
128	824.20	3.6	60	-34.29	-0.0416

Traffic Channel Number	Frequency (MHz)	Voltage (Volts)	Temperature (Celsius)	Frequency Error (Hz)	PPM
128	824.20	3.7	-30	41.39	0.0502
128	824.20	3.7	-20	-35.71	-0.0433
128	824.20	3.7	-10	15.43	0.0187
128	824.20	3.7	0	-6.72	-0.0082
128	824.20	3.7	10	-22.73	-0.0276
128	824.20	3.7	20	20.86	0.0253
128	824.20	3.7	30	-39.13	-0.0475
128	824.20	3.7	40	-9.56	-0.0116
128	824.20	3.7	50	-32.22	-0.0391
128	824.20	3.7	60	18.60	0.0226

Traffic Channel Number	Frequency (MHz)	Voltage (Volts)	Temperature (Celsius)	Frequency Error (Hz)	PPM
128	824.20	4.2	-30	21.57	0.0262
128	824.20	4.2	-20	-23.89	-0.0290
128	824.20	4.2	-10	24.41	0.0296
128	824.20	4.2	0	22.47	0.0273
128	824.20	4.2	10	-4.65	-0.0056
128	824.20	4.2	20	23.31	0.0283
128	824.20	4.2	30	-39.52	-0.0479
128	824.20	4.2	40	-14.21	-0.0172
128	824.20	4.2	50	-38.68	-0.0469
128	824.20	4.2	60	22.99	0.0279

Test Report No. RTS-2474-1002-50	Dates of Test January 29 to February 23, 2010	Author Data Fahd Faisal
-------------------------------------	--	----------------------------

GSM850 Results: channel 189 @ maximum transmitted power

Traffic Channel Number	Frequency (MHz)	Voltage (Volts)	Temperature (Celsius)	Frequency Error (Hz)	PPM
189	836.40	3.6	-30	22.08	0.0264
189	836.40	3.6	-20	-29.57	-0.0354
189	836.40	3.6	-10	19.57	0.0234
189	836.40	3.6	0	7.04	0.0084
189	836.40	3.6	10	-19.24	-0.0230
189	836.40	3.6	20	24.86	0.0297
189	836.40	3.6	30	-41.00	-0.0490
189	836.40	3.6	40	-11.56	-0.0138
189	836.40	3.6	50	-35.45	-0.0424
189	836.40	3.6	60	-41.00	-0.0490

Traffic Channel Number	Frequency (MHz)	Voltage (Volts)	Temperature (Celsius)	Frequency Error (Hz)	PPM
189	836.40	3.7	-30	41.26	0.0493
189	836.40	3.7	-20	-37.45	-0.0448
189	836.40	3.7	-10	15.30	0.0183
189	836.40	3.7	0	-6.97	-0.0083
189	836.40	3.7	10	-24.60	-0.0294
189	836.40	3.7	20	21.83	0.0261
189	836.40	3.7	30	-38.68	-0.0462
189	836.40	3.7	40	-10.59	-0.0127
189	836.40	3.7	50	-32.41	-0.0387
189	836.40	3.7	60	17.56	0.0210

Traffic Channel Number	Frequency (MHz)	Voltage (Volts)	Temperature (Celsius)	Frequency Error (Hz)	PPM
189	836.40	4.2	-30	13.88	0.0166
189	836.40	4.2	-20	-22.79	-0.0272
189	836.40	4.2	-10	23.89	0.0286
189	836.40	4.2	0	24.73	0.0296
189	836.40	4.2	10	-3.75	-0.0045
189	836.40	4.2	20	25.18	0.0301
189	836.40	4.2	30	-42.29	-0.0506
189	836.40	4.2	40	-15.69	-0.0188
189	836.40	4.2	50	-40.49	-0.0484
189	836.40	4.2	60	20.28	0.0242

Test Report No. RTS-2474-1002-50	Dates of Test January 29 to February 23, 2010	Author Data Fahd Faisal
-------------------------------------	--	----------------------------

GSM850 Results: channel 250 @ maximum transmitted power

Traffic Channel Number	Frequency (MHz)	Voltage (Volts)	Temperature (Celsius)	Frequency Error (Hz)	PPM
250	848.60	3.6	-30	33.25	0.0392
250	848.60	3.6	-20	-36.10	-0.0425
250	848.60	3.6	-10	17.69	0.0208
250	848.60	3.6	0	-5.62	-0.0066
250	848.60	3.6	10	-24.60	-0.0290
250	848.60	3.6	20	22.41	0.0264
250	848.60	3.6	30	-39.45	-0.0465
250	848.60	3.6	40	-10.14	-0.0119
250	848.60	3.6	50	-35.26	-0.0416
250	848.60	3.6	60	-44.04	<b>-0.0519</b>

Traffic Channel Number	Frequency (MHz)	Voltage (Volts)	Temperature (Celsius)	Frequency Error (Hz)	PPM
250	848.60	3.7	-30	43.65	0.0514
250	848.60	3.7	-20	-38.29	-0.0451
250	848.60	3.7	-10	14.33	0.0169
250	848.60	3.7	0	-6.78	-0.0080
250	848.60	3.7	10	-25.63	-0.0302
250	848.60	3.7	20	19.18	0.0226
250	848.60	3.7	30	-39.26	-0.0463
250	848.60	3.7	40	-9.81	-0.0116
250	848.60	3.7	50	-33.90	-0.0399
250	848.60	3.7	60	17.50	0.0206

Traffic Channel Number	Frequency (MHz)	Voltage (Volts)	Temperature (Celsius)	Frequency Error (Hz)	PPM
250	848.60	4.2	-30	9.56	0.0113
250	848.60	4.2	-20	-21.31	-0.0251
250	848.60	4.2	-10	25.25	0.0298
250	848.60	4.2	0	26.93	0.0317
250	848.60	4.2	10	5.17	0.0061
250	848.60	4.2	20	25.63	0.0302
250	848.60	4.2	30	-43.39	-0.0511
250	848.60	4.2	40	-17.05	-0.0201
250	848.60	4.2	50	-42.10	-0.0496
250	848.60	4.2	60	21.05	0.0248

Test Report No. RTS-2474-1002-50	Dates of Test January 29 to February 23, 2010	Author Data Fahd Faisal
-------------------------------------	--	----------------------------

PCS Channel results: channels 512, 661, & 810 @ 20°C maximum transmitted power

Date of Test: February 01, 2010

Traffic Channel Number	PCS Frequency (MHz)	Voltage (Volts)	Temperature (Celsius)	Frequency Error (Hz)	PPM
512	1850.2	3.6	20	-25.25	-0.0136
661	1880.0	3.6	20	-36.29	-0.0193
810	1909.8	3.6	20	-33.84	-0.0177

Traffic Channel Number	PCS Frequency (MHz)	Voltage (Volts)	Temperature (Celsius)	Frequency Error (Hz)	PPM
512	1850.2	3.7	20	-34.16	-0.0185
661	1880.0	3.7	20	-37.97	-0.0202
810	1909.8	3.7	20	-33.58	-0.0176

Traffic Channel Number	PCS Frequency (MHz)	Voltage (Volts)	Temperature (Celsius)	Frequency Error (Hz)	PPM
512	1850.2	4.2	20	-10.53	-0.0057
661	1880.0	4.2	20	-14.33	-0.0076
810	1909.8	4.2	20	-11.36	-0.0059

Test Report No. RTS-2474-1002-50	Dates of Test January 29 to February 23, 2010	Author Data Fahd Faisal
-------------------------------------	--	----------------------------

PCS1900 Results: channel 512 @ maximum transmitted power

Traffic Channel Number	Frequency (MHz)	Voltage (Volts)	Temperature (Celsius)	Frequency Error (Hz)	PPM
512	1850.2	3.6	-30	19.44	0.0105
512	1850.2	3.6	-20	-68.96	-0.0373
512	1850.2	3.6	-10	30.99	0.0167
512	1850.2	3.6	0	-15.82	-0.0086
512	1850.2	3.6	10	12.14	0.0066
512	1850.2	3.6	20	-25.25	-0.0136
512	1850.2	3.6	30	-72.00	-0.0389
512	1850.2	3.6	40	-57.73	-0.0312
512	1850.2	3.6	50	-23.76	-0.0128
512	1850.2	3.6	60	-33.45	-0.0181

Traffic Channel Number	Frequency (MHz)	Voltage (Volts)	Temperature (Celsius)	Frequency Error (Hz)	PPM
512	1850.2	3.7	-30	36.29	0.0196
512	1850.2	3.7	-20	16.40	0.0089
512	1850.2	3.7	-10	-9.49	-0.0051
512	1850.2	3.7	0	-59.47	-0.0321
512	1850.2	3.7	10	-49.33	-0.0267
512	1850.2	3.7	20	-34.16	-0.0185
512	1850.2	3.7	30	12.40	0.0067
512	1850.2	3.7	40	-50.43	-0.0273
512	1850.2	3.7	50	-15.95	-0.0086
512	1850.2	3.7	60	-46.04	-0.0249

Traffic Channel Number	Frequency (MHz)	Voltage (Volts)	Temperature (Celsius)	Frequency Error (Hz)	PPM
512	1850.2	4.2	-30	-42.55	-0.0230
512	1850.2	4.2	-20	27.96	0.0151
512	1850.2	4.2	-10	14.66	0.0079
512	1850.2	4.2	0	-48.24	-0.0261
512	1850.2	4.2	10	-33.90	-0.0183
512	1850.2	4.2	20	-10.53	-0.0057
512	1850.2	4.2	30	12.40	0.0067
512	1850.2	4.2	40	-55.66	-0.0301
512	1850.2	4.2	50	-21.95	-0.0119
512	1850.2	4.2	60	-49.53	-0.0268

Test Report No. RTS-2474-1002-50	Dates of Test January 29 to February 23, 2010	Author Data Fahd Faisal
-------------------------------------	--	----------------------------

PCS1900 Results: channel 661 @ maximum transmitted power

Traffic Channel Number	Frequency (MHz)	Voltage (Volts)	Temperature (Celsius)	Frequency Error (Hz)	PPM
661	1880	3.6	-30	18.21	0.0097
661	1880	3.6	-20	18.27	0.0097
661	1880	3.6	-10	-12.46	-0.0066
661	1880	3.6	0	-49.72	-0.0264
661	1880	3.6	10	-36.87	-0.0196
661	1880	3.6	20	-36.29	-0.0193
661	1880	3.6	30	-72.84	-0.0387
661	1880	3.6	40	-52.63	-0.0280
661	1880	3.6	50	-20.92	-0.0111
661	1880	3.6	60	-43.39	-0.0231

Traffic Channel Number	Frequency (MHz)	Voltage (Volts)	Temperature (Celsius)	Frequency Error (Hz)	PPM
661	1880	3.7	-30	-18.27	-0.0097
661	1880	3.7	-20	10.59	0.0056
661	1880	3.7	-10	-19.57	-0.0104
661	1880	3.7	0	-74.97	<b>-0.0399</b>
661	1880	3.7	10	-62.44	-0.0332
661	1880	3.7	20	-37.97	-0.0202
661	1880	3.7	30	12.14	0.0065
661	1880	3.7	40	-47.14	-0.0251
661	1880	3.7	50	-13.30	-0.0071
661	1880	3.7	60	-52.82	-0.0281

Traffic Channel Number	Frequency (MHz)	Voltage (Volts)	Temperature (Celsius)	Frequency Error (Hz)	PPM
661	1880	4.2	-30	-31.70	-0.0169
661	1880	4.2	-20	18.14	0.0096
661	1880	4.2	-10	-7.23	-0.0038
661	1880	4.2	0	-57.08	-0.0304
661	1880	4.2	10	-44.43	-0.0236
661	1880	4.2	20	-14.33	-0.0076
661	1880	4.2	30	12.66	0.0067
661	1880	4.2	40	-52.11	-0.0277
661	1880	4.2	50	-18.40	-0.0098
661	1880	4.2	60	-54.76	-0.0291



Test Report No. RTS-2474-1002-50	Dates of Test January 29 to February 23, 2010	Author Data Fahd Faisal
-------------------------------------	--	----------------------------

PCS1900 Results: channel 810 @ maximum transmitted power

Traffic Channel Number	Frequency (MHz)	Voltage (Volts)	Temperature (Celsius)	Frequency Error (Hz)	PPM
810	1909.8	3.6	-30	31.38	0.0164
810	1909.8	3.6	-20	14.21	0.0074
810	1909.8	3.6	-10	-15.30	-0.0080
810	1909.8	3.6	0	-64.18	-0.0336
810	1909.8	3.6	10	-48.62	-0.0255
810	1909.8	3.6	20	-33.84	-0.0177
810	1909.8	3.6	30	-73.29	-0.0384
810	1909.8	3.6	40	-52.43	-0.0275
810	1909.8	3.6	50	-21.70	-0.0114
810	1909.8	3.6	60	-49.07	-0.0257

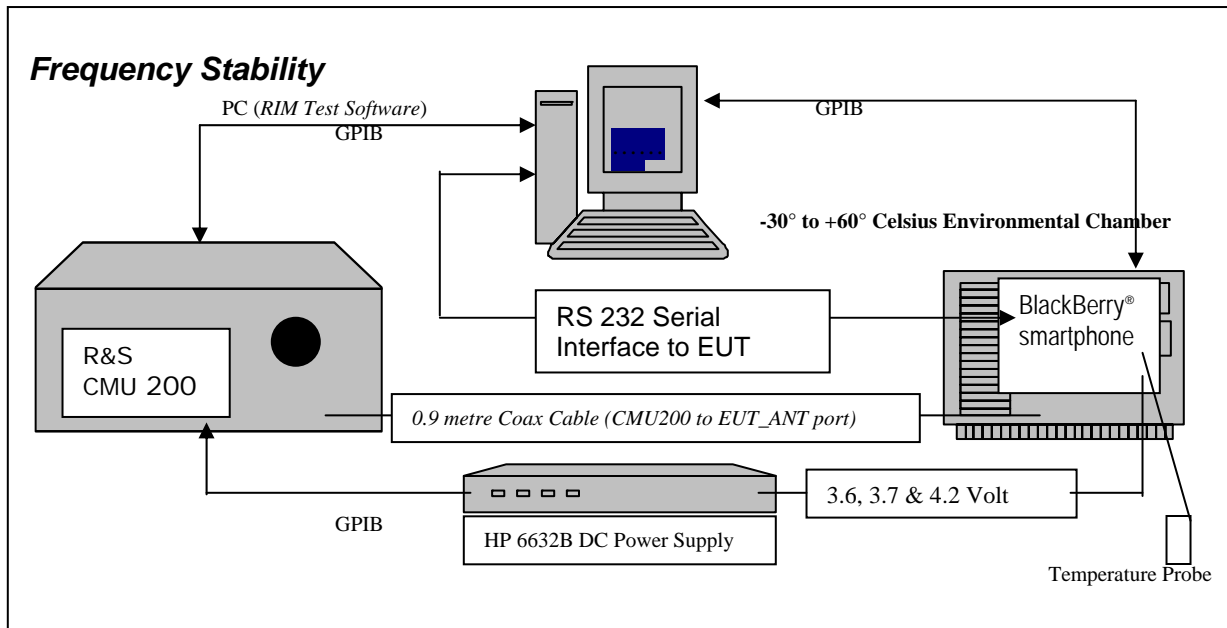
Traffic Channel Number	Frequency (MHz)	Voltage (Volts)	Temperature (Celsius)	Frequency Error (Hz)	PPM
810	1909.8	3.7	-30	-18.02	-0.0094
810	1909.8	3.7	-20	14.14	0.0074
810	1909.8	3.7	-10	-19.69	-0.0103
810	1909.8	3.7	0	-73.35	-0.0384
810	1909.8	3.7	10	-64.18	-0.0336
810	1909.8	3.7	20	-33.58	-0.0176
810	1909.8	3.7	30	17.76	0.0093
810	1909.8	3.7	40	-46.04	-0.0241
810	1909.8	3.7	50	-12.72	-0.0067
810	1909.8	3.7	60	-52.63	-0.0276

Traffic Channel Number	Frequency (MHz)	Voltage (Volts)	Temperature (Celsius)	Frequency Error (Hz)	PPM
810	1909.8	4.2	-30	-42.49	-0.0222
810	1909.8	4.2	-20	23.89	0.0125
810	1909.8	4.2	-10	10.85	0.0057
810	1909.8	4.2	0	-51.72	-0.0271
810	1909.8	4.2	10	-36.48	-0.0191
810	1909.8	4.2	20	-11.36	-0.0059
810	1909.8	4.2	30	16.98	0.0089
810	1909.8	4.2	40	-49.59	-0.0260
810	1909.8	4.2	50	-20.21	-0.0106
810	1909.8	4.2	60	-55.53	-0.0291

## APPENDIX 3B – WCDMA FREQUENCY STABILITY TEST DATA

Test Report No. RTS-2474-1002-50	Dates of Test January 29 to February 23, 2010	Author Data Fahd Faisal
-------------------------------------	--	----------------------------

WCDMA Frequency Stability Test Data



The following measurements were performed by Maurice Battler.  
 CFR 47 Chapter 1 - Federal Communications Commission Rules

Part 2 Required Measurements

- 2.1055** Frequency Stability - Procedures
- (a,b) Frequency Stability - Temperature Variation
- (d) Frequency Stability - Voltage Variation


**24.235** *Frequency Stability.*

*The frequency stability shall be sufficient to ensure that the fundamental emission stays within the authorized frequency block.*

*The EUT meets the requirements as stated in CFR 47 chapter 1, Section 27.54, CFR 47 and RSS-139, 6.3 Frequency Stability.*

Frequency Stability measurement devices were configured as presented in the block diagram recording frequency, power, data, temperatures, and stepped voltages controlled via a GPIB interface linked to the Environmental chamber, a DC power supply, and the Communications Test Set. A 0.9-metre coax cable was calibrated to characterize the insertion loss for the transmitted frequencies between the RF input/output of the CMU 200 and the EUT antenna port.

Calibration for the Cable Loss was performed in the RF Laboratory using the Agilent power meter and Agilent Signal Generator.

	EMI Test Report for the BlackBerry® smartphone Model RCX71UW	
	<b>APPENDIX 3B</b>	
Test Report No. RTS-2474-1002-50	Dates of Test January 29 to February 23, 2010	Author Data Fahd Faisal

The cable assembly from the RF input to the RF output was measured at the following Frequencies:

UMTS1700 Frequency (MHz)	Cable loss (dB)
1712.4	0.90
1732.6	0.90
1752.6	0.90

**Procedure:**

The EUT was placed in the Temperature chamber and connected to CMU 200 outside as shown in the figure above. Dry air was pumped inside the temperature chamber to maintain a backpressure during the test. The EUT was kept in the off condition at all times except when the following measurements were to be made.


The chamber was switched on and the temperature was set to -30°C. After the chamber stabilized at -30 °C there was a soak period of one hour to alleviate moisture in the chamber, the EUT voltage was enabled. The system software recorded the frequency, power, and associated measurements.

A Computer system controlled the automated software. This application was given the command of activating all machines intrinsic to the temperature and voltage tests controlling the CMU 200 via the GPIB Bus. The Environmental Chamber was instructed through an RS-232 serial line. The EUT dialogue was passed through a serial connection.

The EUT repetitively transmitted 100 bursts for each set of programmed parameters recording temperature, voltage settings, and systematically selected frequencies. The power supply was cycled from minimum voltage 3.6 volts, to 3.7 volts to 4.2 volts maximum voltage. The frequency error was measured at a maximum output power and recorded by the automated system test software.

The EUT output power and frequency was measured at 3.6 volts, 3.7 volts and 4.2 volts. The transmit frequency was varied in 3 steps consisting of 1712.4, 1732.6 and 1752.5 MHz for the UMTS1700 band. This frequency was recorded in MHz and deviation from nominal, in Parts Per Million.

After the initial one-hour soak at the beginning of the tests, a period of thirty minutes soak was initialized between each ascending temperature step, before proceeding to the next measurement test cycle.

	EMI Test Report for the BlackBerry® smartphone Model RCX71UW	
	<b>APPENDIX 3B</b>	
Test Report No. RTS-2474-1002-50	Dates of Test January 29 to February 23, 2010	Author Data Fahd Faisal

## PROCEDURE:

The test system software for commencing the Frequency Stability Tests carried through the following cycle.

1. Switch on the HP 6632B power supply; CMU 200 Communications test Set, and Environmental Chamber.
2. Start test program
3. Set the Temperature to  $-30^{\circ}\text{C}$  and maintain a period of one- hour soak time, with the EUT supply voltage disabled.
4. Set power supply voltage to 3.6 volts.
5. Set up CMU 200 Radio Communication Tester.
6. Command the CMU 200 to switch to the low channel.
7. Enable the voltage to the EUT, and connect a link to the CMU 200 test set.
8. EUT is commanded to Transmit 100 Bursts.
9. Software logs the following data from the CMU 200, power supply and temperature chamber: Traffic Channel Number, Traffic Channel Frequency, Power Level, Chamber Temperature, Supply Voltage, Power and Frequency Error.
10. The CMU 200 commands the EUT to change frequency to the middle channel and high channel and repeats steps 7 to 9.
11. Repeat steps 5 to 10 changing the supply voltage to 3.7 Volts
12. Increase temperature by  $10^{\circ}\text{C}$  and soak for 1/2 hour.
13. Repeat steps 4 - 12 for temperatures  $-30^{\circ}\text{C}$  to  $60^{\circ}\text{C}$ .
14. Repeat steps 5 to 10 changing the supply voltage to 4.2 volts

Procedure 5 to 10 was repeated at room temperature ( $20^{\circ}\text{C}$ ) with the power supply voltage set to 3.6, 3.7 and 4.2 volts.

The maximum frequency error in the UMTS1700 band measured was **0.0256 PPM**.

Test Report No. RTS-2474-1002-50	Dates of Test January 29 to February 23, 2010	Author Data Fahd Faisal
-------------------------------------	--	----------------------------

UMTS1700 Channel results: channels 1312, 1412 and 1512 @ 20°C maximum transmitted power

The BlackBerry® smartphone PIN 21BDDF4A was tested on .

Traffic Channel Number	UMTS1700 Frequency (MHz)	Voltage (Volts)	Temperature (Celsius)	Frequency Error (Hz)	PPM
1312	1712.4	3.6	20	26.95	0.0157
1412	1732.4	3.6	20	-11.23	-0.0065
1512	1752.4	3.6	20	21.61	0.0123

Traffic Channel Number	UMTS1700 Frequency (MHz)	Voltage (Volts)	Temperature (Celsius)	Frequency Error (Hz)	PPM
1312	1712.4	3.7	20	11.81	0.0069
1412	1732.4	3.7	20	-9.66	-0.0056
1512	1752.4	3.7	20	19.94	0.0114

Traffic Channel Number	UMTS1700 Frequency (MHz)	Voltage (Volts)	Temperature (Celsius)	Frequency Error (Hz)	PPM
1312	1712.4	4.2	20	5.69	0.0033
1412	1732.4	4.2	20	12.60	0.0073
1512	1752.4	4.2	20	12.88	0.0073

Test Report No. RTS-2474-1002-50	Dates of Test January 29 to February 23, 2010	Author Data Fahd Faisal
-------------------------------------	--	----------------------------

UMTS1700 Results: channel 4132 @ maximum transmitted power

Traffic Channel Number	Frequency (MHz)	Voltage (Volts)	Temperature (Celsius)	Frequency Error (Hz)	PPM
1312	1712.4	3.6	-30	10.99	0.0064
1312	1712.4	3.6	-20	11.25	0.0066
1312	1712.4	3.6	-10	4.62	0.0027
1312	1712.4	3.6	0	18.77	0.0110
1312	1712.4	3.6	10	27.40	0.0160
1312	1712.4	3.6	20	26.95	0.0157
1312	1712.4	3.6	30	7.61	0.0044
1312	1712.4	3.6	40	17.82	0.0104
1312	1712.4	3.6	50	10.33	0.0060
1312	1712.4	3.6	60	9.52	0.0056

Traffic Channel Number	Frequency (MHz)	Voltage (Volts)	Temperature (Celsius)	Frequency Error (Hz)	PPM
1312	1712.4	3.7	-30	7.37	0.0043
1312	1712.4	3.7	-20	9.41	0.0055
1312	1712.4	3.7	-10	19.06	0.0111
1312	1712.4	3.7	0	26.81	0.0157
1312	1712.4	3.7	10	21.27	0.0124
1312	1712.4	3.7	20	-6.47	-0.0038
1312	1712.4	3.7	30	16.98	0.0099
1312	1712.4	3.7	40	-4.65	-0.0027
1312	1712.4	3.7	50	13.41	0.0078
1312	1712.4	3.7	60	7.37	0.0043

Traffic Channel Number	Frequency (MHz)	Voltage (Volts)	Temperature (Celsius)	Frequency Error (Hz)	PPM
1312	1712.4	4.2	-30	6.47	0.0038
1312	1712.4	4.2	-20	6.56	0.0038
1312	1712.4	4.2	-10	19.76	0.0115
1312	1712.4	4.2	0	13.41	0.0078
1312	1712.4	4.2	10	15.08	0.0088
1312	1712.4	4.2	20	5.69	0.0033
1312	1712.4	4.2	30	14.51	0.0085
1312	1712.4	4.2	40	11.00	0.0064
1312	1712.4	4.2	50	9.49	0.0055
1312	1712.4	4.2	60	12.15	0.0071

Test Report No. RTS-2474-1002-50	Dates of Test January 29 to February 23, 2010	Author Data Fahd Faisal
-------------------------------------	--	----------------------------

UMTS1700 Results: channel 4182 @ maximum transmitted power

Traffic Channel Number	Frequency (MHz)	Voltage (Volts)	Temperature (Celsius)	Frequency Error (Hz)	PPM
1412	1732.4	3.6	-30	44.34	<b>0.0256</b>
1412	1732.4	3.6	-20	9.28	0.0054
1412	1732.4	3.6	-10	10.73	0.0062
1412	1732.4	3.6	0	11.35	0.0066
1412	1732.4	3.6	10	11.67	0.0067
1412	1732.4	3.6	20	-11.23	-0.0065
1412	1732.4	3.6	30	13.24	0.0076
1412	1732.4	3.6	40	10.51	0.0061
1412	1732.4	3.6	50	-7.72	-0.0045
1412	1732.4	3.6	60	-9.63	-0.0056

Traffic Channel Number	Frequency (MHz)	Voltage (Volts)	Temperature (Celsius)	Frequency Error (Hz)	PPM
1412	1732.4	3.7	-30	9.78	0.0056
1412	1732.4	3.7	-10	-5.58	-0.0032
1412	1732.4	3.7	0	15.41	0.0089
1412	1732.4	3.7	10	-7.45	-0.0043
1412	1732.4	3.7	20	-7.75	-0.0045
1412	1732.4	3.7	30	8.64	0.0050
1412	1732.4	3.7	40	6.91	0.0040
1412	1732.4	3.7	50	9.83	0.0057
1412	1732.4	3.7	60	3.49	0.0020

Traffic Channel Number	Frequency (MHz)	Voltage (Volts)	Temperature (Celsius)	Frequency Error (Hz)	PPM
1412	1732.4	4.2	-30	-6.47	-0.0037
1412	1732.4	4.2	-20	4.55	0.0026
1412	1732.4	4.2	-10	4.01	0.0023
1412	1732.4	4.2	0	-6.18	-0.0036
1412	1732.4	4.2	10	12.59	0.0073
1412	1732.4	4.2	20	12.60	0.0073
1412	1732.4	4.2	30	-9.93	-0.0057
1412	1732.4	4.2	40	9.64	0.0056
1412	1732.4	4.2	50	-6.13	-0.0035
1412	1732.4	4.2	60	10.56	0.0061




UMTS1700 Results: channel 4233 @ maximum transmitted power

Traffic Channel Number	Frequency (MHz)	Voltage (Volts)	Temperature (Celsius)	Frequency Error (Hz)	PPM
1512	1752.4	3.6	-30	9.16	0.0052
1512	1752.4	3.6	-20	13.75	0.0078
1512	1752.4	3.6	-10	5.83	0.0033
1512	1752.4	3.6	0	15.70	0.0090
1512	1752.4	3.6	10	23.56	0.0134
1512	1752.4	3.6	20	21.61	0.0123
1512	1752.4	3.6	30	5.52	0.0032
1512	1752.4	3.6	40	16.95	0.0097
1512	1752.4	3.6	50	6.01	0.0034
1512	1752.4	3.6	60	-5.10	-0.0029

Traffic Channel Number	Frequency (MHz)	Voltage (Volts)	Temperature (Celsius)	Frequency Error (Hz)	PPM
1512	1752.4	3.7	-30	10.74	0.0061
1512	1752.4	3.7	-20	5.23	0.0030
1512	1752.4	3.7	-10	10.44	0.0060
1512	1752.4	3.7	0	22.45	0.0128
1512	1752.4	3.7	10	17.70	0.0101
1512	1752.4	3.7	20	11.89	0.0068
1512	1752.4	3.7	30	15.52	0.0089
1512	1752.4	3.7	40	15.82	0.0090
1512	1752.4	3.7	50	10.01	0.0057
1512	1752.4	3.7	60	10.74	0.0061

Traffic Channel Number	Frequency (MHz)	Voltage (Volts)	Temperature (Celsius)	Frequency Error (Hz)	PPM
1512	1752.4	4.2	-30	14.24	0.0081
1512	1752.4	4.2	-20	13.85	0.0079
1512	1752.4	4.2	-10	12.34	0.0070
1512	1752.4	4.2	0	24.08	0.0137
1512	1752.4	4.2	10	25.13	0.0143
1512	1752.4	4.2	20	12.88	0.0073
1512	1752.4	4.2	30	9.49	0.0054
1512	1752.4	4.2	40	17.26	0.0098
1512	1752.4	4.2	50	11.80	0.0067
1512	1752.4	4.2	60	13.00	0.0074

	EMI Test Report for the BlackBerry® smartphone Model RCX71UW <b>APPENDIX 3B</b>	
<b>Test Report No.</b> RTS-2474-1002-50	<b>Dates of Test</b> January 29 to February 23, 2010	<b>Author Data</b> Fahd Faisal

APPENDIX 4A – GSM RADIATED EMISSIONS TEST DATA

Test Report No. RTS-2474-1002-50	Dates of Test January 29 to February 23, 2010	Author Data Fahd Faisal
-------------------------------------	--	----------------------------

### Radiated Power Test Data Results

Date of test: February 18, 2010

The measurements were performed by Kevin Rose.

The environmental tests conditions were: Temperature: 25 °C  
Pressure: 1013 mb  
Relative Humidity: 23 %

The BlackBerry® smartphone was in standalone, USB up position.

Test distance is 3.0 metres

### GSM850 Band

#### **GSM Mode**

EUT				Rx Antenna		Spectrum Analyzer		Substitution Method				Limit (dBm)	Diff. To Limit (dB)
Type	Ch	Frequency (MHz)	Band	Type	Pol.	Reading (dBuV)	Max (V,H) (dBuV)	Pol. Tx-Rx	Reading (dBm)	Tracking Generator Corrected Reading (relative to Dipole)			
										(dBm)	(W)		
F0	128	824.20	850	Dipole	V	74.68	87.39	V-V	13.26	28.30	0.68	38.50	-10.20
F0	128	824.20	850	Dipole	H	87.39		H-H	12.17				
F0	195	837.60	850	Dipole	V	74.06	86.29	V-V	12.86	28.54	0.71	38.50	-9.96
F0	195	837.60	850	Dipole	H	86.29		H-H	11.09				
F0	251	848.80	850	Dipole	V	73.12	88.03	V-V	14.90	<b>30.39</b>	1.09	38.50	-8.11
F0	251	848.80	850	Dipole	H	86.42		H-H	12.04				

#### **EDGE Mode**

EUT				Rx Antenna		Spectrum Analyzer		Substitution Method				Limit (dBm)	Diff. To Limit (dB)
Type	Ch	Frequency (MHz)	Band	Type	Pol.	Reading (dBuV)	Max (V,H) (dBuV)	Pol. Tx-Rx	Reading (dBm)	Tracking Generator Corrected Reading (relative to Dipole)			
										(dBm)	(W)		
F0	128	824.20	850	Dipole	V	73.53	85.74	V-V	11.59	26.63	0.46	38.50	-11.87
F0	128	824.20	850	Dipole	H	85.74		H-H	9.79				
F0	195	837.60	850	Dipole	V	72.87	85.09	V-V	11.59	27.27	0.53	38.50	-11.23
F0	195	837.60	850	Dipole	H	85.09		H-H	9.84				
F0	251	848.80	850	Dipole	V	75.51	86.2	V-V	13.07	<b>28.56</b>	0.72	38.50	-9.94
F0	251	848.80	850	Dipole	H	86.2		H-H	11.27				

Test Report No. RTS-2474-1002-50	Dates of Test January 29 to February 23, 2010	Author Data Fahd Faisal
-------------------------------------	--	----------------------------

Radiated Power Test Data Results cont'd


**PCS1900 Band**

**GSM Mode**

EUT				Rx Antenna		Spectrum Analyzer		Substitution Method				Limit	Diff to Limit
Type	Ch	Frequency (MHz)	Band	Type	Pol.	Reading (dBuV)	Max (V,H) dBuV	Tracking Generator		Corrected Reading (relative to Isotropic Radiator)			
								Tx-Rx	Reading (dBm)	(dBm)	(W)	(dBm)	(dB)
F0	512	1850.20	1900	Horn	V	90.97	90.97	V-V	-8.61	29.94	0.99	33.00	-3.06
F0	512	1850.20	1900	Horn	H	82.64		H-H	-6.44				
F0	661	1880.00	1900	Horn	V	92.17	92.17	V-V	-6.80	<b>31.48</b>	1.41	33.00	-1.52
F0	661	1880.00	1900	Horn	H	84.06		H-H	-4.80				
F0	810	1909.80	1900	Horn	V	91.7	91.7	V-V	-6.94	31.30	1.35	33.00	-1.70
F0	810	1909.80	1900	Horn	H	81.93		H-H	-5.02				

**EDGE Mode**

EUT				Rx Antenna		Spectrum Analyzer		Substitution Method				Limit	Diff to Limit
Type	Ch	Frequency (MHz)	Band	Type	Pol.	Reading (dBuV)	Max (V,H) dBuV	Tracking Generator		Corrected Reading (relative to Isotropic Radiator)			
								Tx-Rx	Reading (dBm)	(dBm)	(W)	(dBm)	(dB)
F0	512	1850.20	1900	Horn	V	87.79	88.08	V-V	-11.49	27.04	0.51	33.00	-5.96
F0	512	1850.20	1900	Horn	H	88.08		H-H	-9.34				
F0	661	1880.00	1900	Horn	V	88.94	88.94	V-V	-10.64	28.26	0.67	33.00	-4.74
F0	661	1880.00	1900	Horn	H	79.71		H-H	-8.02				
F0	810	1909.80	1900	Horn	V	89.07	89.07	V-V	-9.61	<b>28.62</b>	0.73	33.00	-4.38
F0	810	1909.80	1900	Horn	V	79.1		H-H	-7.70				

	EMI Test Report for the BlackBerry® smartphone Model RCX71UW	
	<b>APPENDIX 3B</b>	
Test Report No. RTS-2474-1002-50	Dates of Test January 29 to February 23, 2010	Author Data Fahd Faisal

### Radiated Emissions Test Data Results

#### GSM850

#### **GSM Mode**

Date of Test: February 10, 2010

The measurements were performed by Fahd Faisal.

The environmental test conditions were: Temperature: 20 °C

Pressure: 996 mb

Relative Humidity: 23 %

Test Distance was 3.0 metres with a height of 1.0 metre, 30 MHz to 1000 MHz.

The BlackBerry® smartphone was in standalone, Horizontal position.

The measurements were performed in GSM850 Tx mode on channels 128, 195 and 251.

All emissions had a test margin greater than 25.0 dB.

Date of Test: February 09, 2010

The measurements were performed by Steven Wang.

The environmental test conditions were: Temperature: 26 °C

Pressure: 1005 mb


Relative Humidity: 25 %

Test Distance was 3.0 metres with a height of 1.0 metre, 1 GHz to 9 GHz.

The BlackBerry® smartphone was in standalone, Horizontal position.

The measurements were performed in GSM850 Tx mode on channels 128, 195 and 251.

All emissions had a test margin greater than 25.0 dB.

	EMI Test Report for the BlackBerry® smartphone Model RCX71UW	
	<b>APPENDIX 3B</b>	
Test Report No. RTS-2474-1002-50	Dates of Test January 29 to February 23, 2010	Author Data Fahd Faisal

Radiated Emissions Test Data Results cont'd

**GSM850**

**EDGE Mode**

Date of Test: February 10, 2010

The measurements were performed by Fahd Faisal.

The environmental test conditions were: Temperature: 20 °C

Pressure: 996 mb

Relative Humidity: 23 %

Test Distance was 3.0 metres with a height of 1.0 metre, 30 MHz to 1000 MHz.

The BlackBerry® smartphone was in standalone, vertical position.

The measurements were performed in GSM850 EDGE Tx mode on channels 128, 195 and 251.

All emissions had a test margin greater than 25.0 dB.

Date of Test: February 23, 2010

The measurements were performed by Heng Lin.

The environmental test conditions were: Temperature: 25 °C

Pressure: 1012 mb


Relative Humidity: 29 %

Test Distance was 3.0 metres with a height of 1.0 metre, 1 GHz to 9 GHz.

The BlackBerry® smartphone was in standalone, Horizontal position.

The measurements were performed in GSM850 EDGE Tx mode on channels 128, 195 and 251.

All emissions had a test margin greater than 25.0 dB.

	EMI Test Report for the BlackBerry® smartphone Model RCX71UW	
	<b>APPENDIX 3B</b>	
Test Report No. RTS-2474-1002-50	Dates of Test January 29 to February 23, 2010	Author Data Fahd Faisal

## PCS1900

### **GSM Mode**

Date of Test: February 10, 2010

The measurements were performed by Fahd Faisal.

The environmental test conditions were: Temperature: 22 °C

Pressure: 996 mb

Relative Humidity: 22 %

Test Distance was 3.0 metres with a height of 1.0 metre, 30 MHz to 1000 MHz.

The BlackBerry® smartphone was in standalone, USB Up position.

The measurements were performed in PCS1900 Tx mode on channels 512, 661 and 810.

All emissions had a test margin greater than 25.0 dB.

Date of Test: February 10-17, 2010

The measurements were performed by Heng Lin.

The environmental test conditions were: Temperature: 23 – 25 °C

Pressure: 1003 – 1023 mb


Relative Humidity: 29 – 30 %

Test Distance was 3.0 metres with a height of 1.0 metre, 1 GHz to 20 GHz.

The BlackBerry® smartphone was in standalone, USB up position.

The measurements were performed in PCS1900 Tx mode on channels 512, 661 and 810.

All emissions had a test margin greater than 25.0 dB.

	EMI Test Report for the BlackBerry® smartphone Model RCX71UW	
	<b>APPENDIX 3B</b>	
Test Report No. RTS-2474-1002-50	Dates of Test January 29 to February 23, 2010	Author Data Fahd Faisal

Radiated Emissions Test Data Results cont'd

**PCS1900**

**EDGE Mode**

Date of Test: February 10, 2010

The measurements were performed by Fahd Faisal.

The environmental test conditions were: Temperature: 22 °C

Pressure: 996 mb

Relative Humidity: 22 %

Test Distance was 3.0 metres with a height of 1.0 metre, 30 MHz to 1000 MHz.

The BlackBerry® smartphone was in standalone, USB Up position.

The measurements were performed in PCS1900 EDGE Tx mode on channels 512, 661 and 810.

All emissions had a test margin greater than 25.0 dB.

Date of Test: February 10-17, 2010

The measurements were performed by Heng Lin.

The environmental test conditions were: Temperature: 23 – 25 °C

Pressure: 1003 – 1023 mb

Relative Humidity: 29 – 30 %


Test Distance was 3.0 metres with a height of 1.0 metre, 1 GHz to 20 GHz.

The BlackBerry® smartphone was in standalone, USB up position.


The measurements were performed in PCS1900 EDGE Tx mode on channels 512, 661 and 810.

All emissions had a test margin greater than 25.0 dB.



	EMI Test Report for the BlackBerry® smartphone Model RCX71UW <b>APPENDIX 3B</b>	
<b>Test Report No.</b> RTS-2474-1002-50	<b>Dates of Test</b> January 29 to February 23, 2010	<b>Author Data</b> Fahd Faisal

## APPENDIX 4B – UMTS RADIATED EMISSIONS TEST DATA

		EMI Test Report for the BlackBerry® smartphone Model RCX71UW <b>APPENDIX 3B</b>	
Test Report No. RTS-2474-1002-50	Dates of Test January 29 to February 23, 2010		Author Data Fahd Faisal

### Radiated Power Test Data Results

Date of test: November 02, 2009

The measurements were performed by Kevin Rose.


The environmental tests conditions were: Temperature: 25 °C  
 Pressure: 1013 mb  
 Relative Humidity: 23 %

The BlackBerry® smartphone was in standalone, Horizontal down position.  
 Test distance is 3.0 metres

### UMTS Band IV (1700 MHz)

#### Call Mode

EUT				Rx Antenna		Spectrum Analyzer		Substitution Method					
Type	Ch	Frequency (MHz)	Band	Type	Pol.	Reading (dBuV)	Max (V,H) (dBuV)	Tracking Generator		Corrected Reading (relative to Dipole)		Limit (dBm)	Diff. To Limit (dB)
								Pol.	Reading (dBm)	(dBm)	(W)		
F0	1312	1712.40	UMTS 4	Horn	V	75.51	83.27	V-V	-18.10	21.12	0.13	33.00	-11.88
F0	1312	1712.40	UMTS 4	Horn	H	83.27		H-H	-15.26				
F0	1413	1732.60	UMTS 4	Horn	V	76.86	82.39	V-V	-18.82	21.05	0.13	33.00	-11.95
F0	1413	1732.60	UMTS 4	Horn	H	82.39		H-H	-15.23				
F0	1513	1752.60	UMTS 4	Horn	V	76.48	82.51	V-V	-17.82	<b>21.47</b>	0.14	33.00	-11.53
F0	1513	1752.60	UMTS 4	Horn	H	82.51		H-H	-14.85				

	EMI Test Report for the BlackBerry® smartphone Model RCX71UW	
	<b>APPENDIX 3B</b>	
Test Report No. RTS-2474-1002-50	Dates of Test January 29 to February 23, 2010	Author Data Fahd Faisal

### Radiated Emissions Test Data Results

#### UMTS 1700 MHz Band

Date of Test: February 10, 2010

The measurements were performed by Fahd Faisal

The environmental test conditions were: Temperature: 23 °C  
Pressure: 997 mb  
Relative Humidity: 22 %

Test Distance was 3.0 metres with a height of 1.0 metre, 30 MHz to 1000 MHz.  
The BlackBerry® smartphone was in standalone, Horizontal face down position.

The measurements were performed in Call Tx mode, on channels 1312, 1413 and 1513.

All emissions had a test margin greater than 25.0 dB.

Date of Test: February 11 and 18, 2010.

The measurements were performed by Heng Lin.

The environmental test conditions were: Temperature: 26 °C  
Pressure: 1008 – 1026 mb  
Relative Humidity: 23 – 24 %

Test Distance was 3.0 metres with a height of 1.0 metre, 1 GHz to 9 GHz.  
The BlackBerry® smartphone was in standalone, USB up position.

All other emissions had a test margin greater than 25.0 dB.