	Document		Page
	Annex B to Hearing Aid Compatibility RF Emissions Test Report for the BlackBerry® Smartphone model RCM71UW		1(13)
Author Data	Dates of Test	Report No	FCC ID
Daoud Attayi	July 03-Aug 11, 2009	RTS-1689-0908-37	L6ARCM70UW

Annex B: Probe and dipole descriptions and calibration certificates

B.2 Dipole calibration certificate

	Document		Page
	Annex B to Hearing Aid Compatibility RF Emissions Test Report for the BlackBerry® Smartphone model RCM71UW		2(13)
Author Data Daoud Attayi	Dates of Test July 03-Aug 11, 2009	Report No RTS-1689-0908-37	FCC ID L6ARCM70UW

Calibration Laboratory of Schmid & Partner Engineering AG
Zeughausstrasse 43, 8004 Zurich, Switzerland



S Schweizerischer Kalibrierdienst
C Service suisse d'étalonnage
S Servizio svizzero di taratura
S Swiss Calibration Service

Accredited by the Swiss Accreditation Service (SAS)
The Swiss Accreditation Service is one of the signatories to the EA Multilateral Agreement for the recognition of calibration certificates

Accreditation No.: **SCS 108**

Client **RIM**

Certificate No: **CD835V3-1011_Nov07**

CALIBRATION CERTIFICATE

Object: **CD835V3 - SN: 1011**

Calibration procedure(s): **QA CAL-20.v4
Calibration procedure for dipoles in air**



Calibration date: **November 7, 2007**

Condition of the calibrated item: **In Tolerance**

This calibration certificate documents the traceability to national standards, which realize the physical units of measurements (SI). All calibrations have been conducted in the closed laboratory facility: environment temperature (22 ± 3)°C and humidity < 70%.

Calibration Equipment used (M&TE critical for calibration)

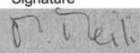
Primary Standards	ID #	Cal Date (Calibrated by, Certificate No.)	Scheduled Calibration
Power meter EPM-442A	GB37480704	04-Oct-07 (METAS, No. 217-00736)	Oct-08
Power sensor HP 8481A	US37292783	04-Oct-07 (METAS, No. 217-00736)	Oct-08
Probe ER3DV6	SN: 2336	27-Dec-06 (SPEAG, No. ER3-2336_Dec06)	Dec-07
Probe H3DV6	SN: 6065	27-Dec-06 (SPEAG, No. H3-6065-Dec06)	Dec-07
DAE4	SN: 781	2-Oct-07 (SPEAG, No. DAE4-781_Oct07)	Oct-08
Secondary Standards	ID #	Check Date (in house)	Scheduled Check
Power meter EPM-4419B	GB42420191	11-May-05 (SPEAG, in house check Oct -07)	In house check: Nov-08
Power sensor HP 8482A	US37295597	11-May-05 (SPEAG, in house check Oct -07)	In house check: Nov-08
Power sensor HP 8482H	3318A09450	08-Jan-02 (SPEAG, in house check Oct -07)	In house check: Nov-08
Network Analyzer HP 8753E	US37390585	18-Oct-01 (SPEAG, in house check Oct-07)	In house check: Nov-09
RF generator E4433B	MY 41310391	22-Nov-04 (SPEAG, in house check Oct-07)	In house check: Nov-09

Calibrated by:	Name Mike Meili	Function Laboratory Technician	Signature 
Approved by:	Name Fin Bomholt	Function Technical Director	Signature 

Issued: November 21, 2007

This calibration certificate shall not be reproduced except in full without written approval of the laboratory.

	Document		Page
	Annex B to Hearing Aid Compatibility RF Emissions Test Report for the BlackBerry® Smartphone model RCM71UW		3(13)
Author Data	Dates of Test	Report No	FCC ID
Daoud Attayi	July 03-Aug 11, 2009	RTS-1689-0908-37	L6ARCM70UW

Calibration Laboratory of Schmid & Partner Engineering AG
Zeughausstrasse 43, 8004 Zurich, Switzerland



S Schweizerischer Kalibrierdienst
C Service suisse d'étalonnage
S Servizio svizzero di taratura
S Swiss Calibration Service

Accredited by the Swiss Accreditation Service (SAS)
The Swiss Accreditation Service is one of the signatories to the EA Multilateral Agreement for the recognition of calibration certificates

Accreditation No.: **SCS 108**

References

- [1] ANSI-C63.19-2006
American National Standard for Methods of Measurement of Compatibility between Wireless Communications Devices and Hearing Aids.

Methods Applied and Interpretation of Parameters:

- *Coordinate System:* y-axis is in the direction of the dipole arms. z-axis is from the basis of the antenna (mounted on the table) towards its feed point between the two dipole arms. x-axis is normal to the other axes. In coincidence with standard [1], the measurement planes (probe sensor center) are selected to be at a distance of 10 mm above the top edge of the dipole arms.
- *Measurement Conditions:* Further details are available from the hardcopies at the end of the certificate. All figures stated in the certificate are valid at the frequency indicated. The forward power to the dipole connector is set with a calibrated power meter connected and monitored with an auxiliary power meter connected to a directional coupler. While the dipole under test is connected, the forward power is adjusted to the same level.
- *Antenna Positioning:* The dipole is mounted on a HAC Test Arch phantom using the matching dipole positioner with the arms horizontal and the feeding cable coming from the floor. The measurements are performed in a shielded room with absorbers around the setup to reduce the reflections. It is verified before the mounting of the dipole under the Test Arch phantom, that its arms are perfectly in a line. It is installed on the HAC dipole positioner with its arms parallel below the dielectric reference wire and able to move elastically in vertical direction without changing its relative position to the top center of the Test Arch phantom. The vertical distance to the probe is adjusted after dipole mounting with a DASY4 Surface Check job. Before the measurement, the distance between phantom surface and probe tip is verified. The proper measurement distance is selected by choosing the matching section of the HAC Test Arch phantom with the proper device reference point (upper surface of the dipole) and the matching grid reference point (tip of the probe) considering the probe sensor offset. The vertical distance to the probe is essential for the accuracy.
- *Feed Point Impedance and Return Loss:* These parameters are measured using a HP 8753E Vector Network Analyzer. The impedance is specified at the SMA connector of the dipole. The influence of reflections was eliminated by applying the averaging function while moving the dipole in the air, at least 70cm away from any obstacles.
- *E-field distribution:* E field is measured in the x-y-plane with an isotropic ER3D-field probe with 100 mW forward power to the antenna feed point. In accordance with [1], the scan area is 20mm wide, its length exceeds the dipole arm length (180 or 90mm). The sensor center is 10 mm (in z) above the top of the dipole arms. Two 3D maxima are available near the end of the dipole arms. Assuming the dipole arms are perfectly in one line, the average of these two maxima (in subgrid 2 and subgrid 8) is determined to compensate for any non-parallelity to the measurement plane as well as the sensor displacement. The E-field value stated as calibration value represents the maximum of the interpolated 3D-E-field, 10mm above the dipole surface.
- *H-field distribution:* H-field is measured with an isotropic H-field probe with 100mW forward power to the antenna feed point, in the x-y-plane. The scan area and sensor distance is equivalent to the E-field scan. The maximum of the field is available at the center (subgrid 5) above the feed point. The H-field value stated as calibration value represents the maximum of the interpolated H-field, 10mm above the dipole surface at the feed point.

	Document		Page
	Annex B to Hearing Aid Compatibility RF Emissions Test Report for the BlackBerry® Smartphone model RCM71UW		4(13)
Author Data Daoud Attayi	Dates of Test July 03-Aug 11, 2009	Report No RTS-1689-0908-37	FCC ID L6ARCM70UW

1 Measurement Conditions

DASY system configuration, as far as not given on page 1.

DASY Version	DASY4	V4.7 B55
DASY PP Version	SEMCAD	V1.8 B176
Phantom	HAC Test Arch	SD HAC P01 BA, #1070
Distance Dipole Top - Probe Center	10 mm	
Scan resolution	dx, dy = 5 mm	area = 20 x 180 mm
Frequency	835 MHz ± 1 MHz	
Forward power at dipole connector	20.0 dBm = 100mW	
Input power drift	< 0.05 dB	

2 Maximum Field values

H-field 10 mm above dipole surface	condition	interpolated maximum
Maximum measured	100 mW forward power	0.458 A/m

Uncertainty for H-field measurement: 8.2% (k=2)

E-field 10 mm above dipole surface	condition	Interpolated maximum
Maximum measured above high end-	100 mW forward power	167.1 V/m
Maximum measured above low end	100 mW forward power	160.1 V/m
Averaged maximum above arm	100 mW forward power	163.6 V/m

Uncertainty for E-field measurement: 12.8% (k=2)

3 Appendix

3.1 Antenna Parameters

Frequency	Return Loss	Impedance
800 MHz	16.2 dB	(42.9 – j12.6) Ohm
835 MHz	26.3 dB	(51.2 + j4.8) Ohm
900 MHz	16.5 dB	(56.7 – j14.6) Ohm
950 MHz	19.8 dB	(43.9 + j7.4) Ohm
960 MHz	16.3 dB	(50.3 + j15.5) Ohm

3.2 Antenna Design and Handling

The calibration dipole has a symmetric geometry with a built-in two stub matching network, which leads to the enhanced bandwidth.

The dipole is built of standard semirigid coaxial cable. The internal matching line is open ended. The antenna is therefore open for DC signals.

Do not apply force to dipole arms, as they are liable to bend. The soldered connections near the feedpoint may be damaged. After excessive mechanical stress or overheating, check the impedance characteristics to ensure that the internal matching network is not affected.

After long term use with 40W radiated power, only a slight warming of the dipole near the feedpoint can be measured.

Author Data
Daoud Attayi

Dates of Test
July 03-Aug 11, 2009

Report No
RTS-1689-0908-37

FCC ID
L6ARCM70UW

3.3 Measurement Sheets

3.3.1 Return Loss and Smith Chart

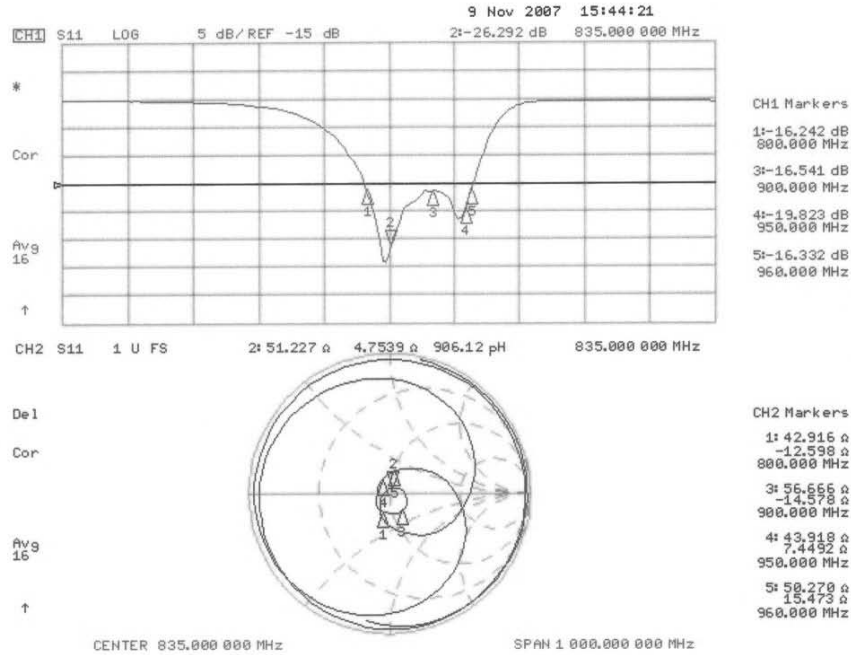

	Document		Page
	Annex B to Hearing Aid Compatibility RF Emissions Test Report for the BlackBerry® Smartphone model RCM71UW		6(13)
Author Data	Dates of Test	Report No	FCC ID
Daoud Attayi	July 03-Aug 11, 2009	RTS-1689-0908-37	L6ARCM70UW

3.3.2 DASY4 H-field result

Date/Time: 07.11.2007 12:08:55

Test Laboratory: SPEAG Lab 2

DUT: HAC-Dipole 835 MHz; Type: CD835V3; Serial: 1011
 Communication System: CW; Frequency: 835 MHz; Duty Cycle: 1:1
 Medium parameters used: $\sigma = 0$ mho/m, $\epsilon_r = 1$; $\rho = 1$ kg/m³
 Phantom section: H Dipole Section
 Measurement Standard: DASY4 (High Precision Assessment)

DASY4 Configuration:

- Probe: H3DV6 - SN6065; Calibrated: 27.12.2006
- Sensor-Surface: (Fix Surface)
- Electronics: DAE4 Sn781; Calibrated: 02.10.2007
- Phantom: HAC Test Arch with Coil; Type: SD HAC P01 BA; Serial: 1070
- Measurement SW: DASY4, V4.7 Build 55; Postprocessing SW: SEMCAD, V1.8 Build 176

H Scan - Sensor Center 10mm above CD835 Dipole/Hearing Aid Compatibility Test (41x361x1):

Measurement grid: dx=5mm, dy=5mm
 Maximum value of peak Total field = 0.458 A/m
 Probe Modulation Factor = 1.00
 Device Reference Point: 0.000, 0.000, 354.7 mm
 Reference Value = 0.484 A/m; Power Drift = 0.007 dB
Hearing Aid Near-Field Category: M4 (AWF 0 dB)

Peak H-field in A/m

Grid 1	Grid 2	Grid 3
0.378 M4	0.409 M4	0.394 M4
Grid 4	Grid 5	Grid 6
0.424 M4	0.458 M4	0.442 M4
Grid 7	Grid 8	Grid 9
0.373 M4	0.401 M4	0.386 M4

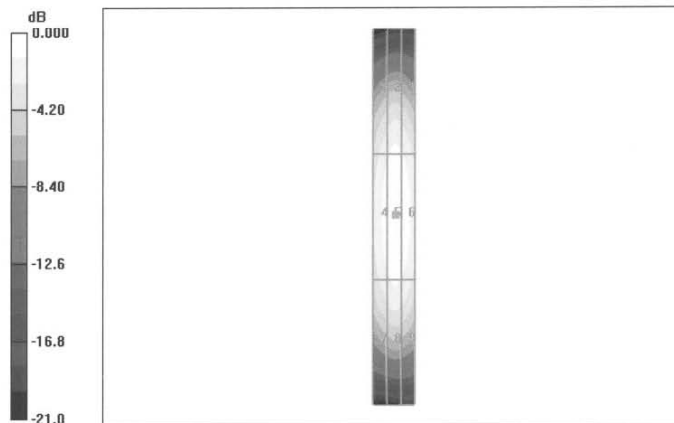

	Document		Page
	Annex B to Hearing Aid Compatibility RF Emissions Test Report for the BlackBerry® Smartphone model RCM71UW		7(13)
Author Data Daoud Attayi	Dates of Test July 03-Aug 11, 2009	Report No RTS-1689-0908-37	FCC ID L6ARCM70UW

3.3.3 DASY4 E-Field result

Date/Time: 07.11.2007 14:04:24

Test Laboratory: SPEAG Lab 2

DUT: HAC-Dipole 835 MHz; Type: D835V3; Serial: 1011

Communication System: CW; Frequency: 835 MHz; Duty Cycle: 1:1

Medium parameters used: $\sigma = 0$ mho/m, $\epsilon_r = 1$; $\rho = 1000$ kg/m³

Phantom section: E Dipole Section

Measurement Standard: DASY4 (High Precision Assessment)

DASY4 Configuration:

- Probe: ER3DV6 - SN2336; ConvF(1, 1, 1); Calibrated: 27.12.2006
- Sensor-Surface: (Fix Surface)
- Electronics: DAE4 Sn781; Calibrated: 02.10.2007
- Phantom: HAC Test Arch with Coil; Type: SD HAC P01 BA; Serial: 1070
- Measurement SW: DASY4, V4.7 Build 55; Postprocessing SW: SEMCAD, V1.8 Build 176

E Scan - Sensor Center 10mm above CD835 Dipole/Hearing Aid Compatibility Test (41x361x1):

Measurement grid: dx=5mm, dy=5mm

Maximum value of peak Total field = 167.1 V/m

Probe Modulation Factor = 1.00

Device Reference Point: 0.000, 0.000, 354.7 mm

Reference Value = 103.6 V/m; Power Drift = 0.012 dB

Hearing Aid Near-Field Category: M4 (AWF 0 dB)

Peak E-field in V/m

Grid 1 162.5 M4	Grid 2 167.1 M4	Grid 3 163.4 M4
Grid 4 87.2 M4	Grid 5 89.4 M4	Grid 6 87.1 M4
Grid 7 156.2 M4	Grid 8 160.1 M4	Grid 9 152.8 M4

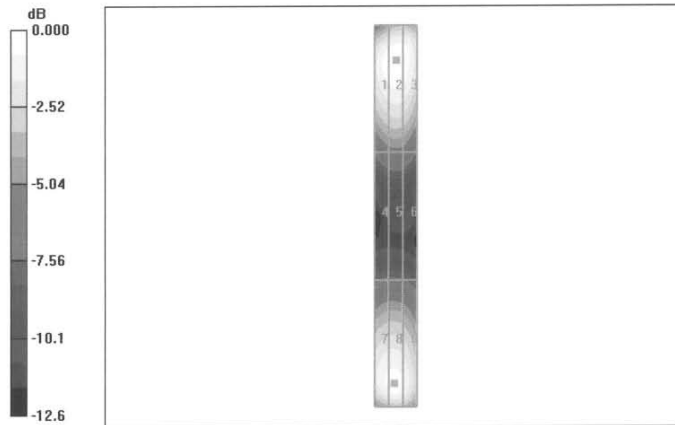

0 dB = 167.1V/m

	Document		Page
	Annex B to Hearing Aid Compatibility RF Emissions Test Report for the BlackBerry® Smartphone model RCM71UW		8(13)
Author Data Daoud Attayi	Dates of Test July 03-Aug 11, 2009	Report No RTS-1689-0908-37	FCC ID L6ARCM70UW

Engineering AG
Zeughausstrasse 43, 8004 Zurich, Switzerland



S Schweizerischer Kalibrierdienst
C Service suisse d'étalonnage
S Servizio svizzero di taratura
S Swiss Calibration Service

Accredited by the Swiss Accreditation Service (SAS)
The Swiss Accreditation Service is one of the signatories to the EA
Multilateral Agreement for the recognition of calibration certificates

Accreditation No.: **SCS 108**

Client **RIM**

Certificate No: **CD1880V3-1008_Nov07**



CALIBRATION CERTIFICATE

Object	CD1880V3 - SN: 1008
Calibration procedure(s)	QA CAL-20.v4 Calibration procedure for dipoles in air
Calibration date:	November 8, 2007
Condition of the calibrated item	In Tolerance

This calibration certificate documents the traceability to national standards, which realize the physical units of measurements (SI).
All calibrations have been conducted in the closed laboratory facility: environment temperature (22 ± 3)°C and humidity < 70%.

Calibration Equipment used (M&TE critical for calibration)

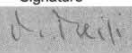
Primary Standards	ID #	Cal Date (Calibrated by, Certificate No.)	Scheduled Calibration
Power meter EPM-442A	GB37480704	04-Oct-07 (METAS, No. 217-00736)	Oct-08
Power sensor HP 8481A	US37292783	04-Oct-07 (METAS, No. 217-00736)	Oct-08
Probe ER3DV6	SN: 2336	27-Dec-06 (SPEAG, No. ER3-2336_Dec06)	Dec-07
Probe H3DV6	SN: 6065	27-Dec-06 (SPEAG, No. H3-6065_Dec06)	Dec-07
DAE4	SN: 781	2-Oct-07 (SPEAG, No. DAE4-781_Oct07)	Oct-08
Secondary Standards	ID #	Check Date (in house)	Scheduled Check
Power meter EPM-4419B	GB42420191	11-May-05 (SPEAG, in house check Oct-07)	In house check: Nov-08
Power sensor HP 8482A	US37295597	11-May-05 (SPEAG, in house check Oct-07)	In house check: Nov-08
Power sensor HP 8482H	3318A09450	08-Jan-02 (SPEAG, in house check Oct-07)	In house check: Nov-08
Network Analyzer HP 8753E	US37390585	18-Oct-01 (SPEAG, in house check Oct-07)	In house check: Nov-09
RF generator E4433B	MY 41310391	22-Nov-04 (SPEAG, in house check Oct-07)	In house check: Nov-09

	Name	Function	Signature
Calibrated by:	Mike Meili	Laboratory Technician	
Approved by:	Fin Bornholt	Technical Director	

Issued: November 22, 2007

This calibration certificate shall not be reproduced except in full without written approval of the laboratory.

Certificate No: CD1880V3-1008_Nov07

Page 1 of 6

	Document		Page
	Annex B to Hearing Aid Compatibility RF Emissions Test Report for the BlackBerry® Smartphone model RCM71UW		9(13)
Author Data	Dates of Test	Report No	FCC ID
Daoud Attayi	July 03-Aug 11, 2009	RTS-1689-0908-37	L6ARCM70UW

Calibration Laboratory of Schmid & Partner Engineering AG
Zeughausstrasse 43, 8004 Zurich, Switzerland



S Schweizerischer Kalibrierdienst
S Service suisse d'étalonnage
C Servizio svizzero di taratura
S Swiss Calibration Service

Accredited by the Swiss Accreditation Service (SAS)
The Swiss Accreditation Service is one of the signatories to the EA Multilateral Agreement for the recognition of calibration certificates

Accreditation No.: **SCS 108**

References

- [1] ANSI-C63.19-2006
American National Standard for Methods of Measurement of Compatibility between Wireless Communications Devices and Hearing Aids.

Methods Applied and Interpretation of Parameters:

- *Coordinate System:* y-axis is in the direction of the dipole arms. z-axis is from the basis of the antenna (mounted on the table) towards its feed point between the two dipole arms. x-axis is normal to the other axes. In coincidence with standard [1], the measurement planes (probe sensor center) are selected to be at a distance of 10 mm above the top edge of the dipole arms.
- *Measurement Conditions:* Further details are available from the hardcopies at the end of the certificate. All figures stated in the certificate are valid at the frequency indicated. The forward power to the dipole connector is set with a calibrated power meter connected and monitored with an auxiliary power meter connected to a directional coupler. While the dipole under test is connected, the forward power is adjusted to the same level.
- *Antenna Positioning:* The dipole is mounted on a HAC Test Arch phantom using the matching dipole positioner with the arms horizontal and the feeding cable coming from the floor. The measurements are performed in a shielded room with absorbers around the setup to reduce the reflections. It is verified before the mounting of the dipole under the Test Arch phantom, that its arms are perfectly in a line. It is installed on the HAC dipole positioner with its arms parallel below the dielectric reference wire and able to move elastically in vertical direction without changing its relative position to the top center of the Test Arch phantom. The vertical distance to the probe is adjusted after dipole mounting with a DASY4 Surface Check job. Before the measurement, the distance between phantom surface and probe tip is verified. The proper measurement distance is selected by choosing the matching section of the HAC Test Arch phantom with the proper device reference point (upper surface of the dipole) and the matching grid reference point (tip of the probe) considering the probe sensor offset. The vertical distance to the probe is essential for the accuracy.
- *Feed Point Impedance and Return Loss:* These parameters are measured using a HP 8753E Vector Network Analyzer. The impedance is specified at the SMA connector of the dipole. The influence of reflections was eliminated by applying the averaging function while moving the dipole in the air, at least 70cm away from any obstacles.
- *E-field distribution:* E field is measured in the x-y-plane with an isotropic ER3D-field probe with 100 mW forward power to the antenna feed point. In accordance with [1], the scan area is 20mm wide, its length exceeds the dipole arm length (180 or 90mm). The sensor center is 10 mm (in z) above the top of the dipole arms. Two 3D maxima are available near the end of the dipole arms. Assuming the dipole arms are perfectly in one line, the average of these two maxima (in subgrid 2 and subgrid 8) is determined to compensate for any non-parallelity to the measurement plane as well as the sensor displacement. The E-field value stated as calibration value represents the maximum of the interpolated 3D-E-field, 10mm above the dipole surface.
- *H-field distribution:* H-field is measured with an isotropic H-field probe with 100mW forward power to the antenna feed point, in the x-y-plane. The scan area and sensor distance is equivalent to the E-field scan. The maximum of the field is available at the center (subgrid 5) above the feed point. The H-field value stated as calibration value represents the maximum of the interpolated H-field, 10mm above the dipole surface at the feed point.

	Document		Page
	Annex B to Hearing Aid Compatibility RF Emissions Test Report for the BlackBerry® Smartphone model RCM71UW		10(13)
Author Data Daoud Attayi	Dates of Test July 03-Aug 11, 2009	Report No RTS-1689-0908-37	FCC ID L6ARCM70UW

1 Measurement Conditions

DASY system configuration, as far as not given on page 1.

DASY Version	DASY4	V4.7 B55
DASY PP Version	SEMCAD	V1.8 B176
Phantom	HAC Test Arch	SD HAC P01 BA, #1070
Distance Dipole Top - Probe Center	10 mm	
Scan resolution	dx, dy = 5 mm	area = 20 x 90 mm
Frequency	1880 MHz ± 1 MHz	
Forward power at dipole connector	20.0 dBm = 100mW	
Input power drift	< 0.05 dB	

2 Maximum Field values

H-field 10 mm above dipole surface	condition	Interpolated maximum
Maximum measured	100 mW forward power	0.465 A/m

Uncertainty for H-field measurement: 8.2% (k=2)

E-field 10 mm above dipole surface	condition	Interpolated maximum
Maximum measured above high end	100 mW forward power	133.7 V/m
Maximum measured above low end	100 mW forward power	133.5 V/m
Averaged maximum above arm	100 mW forward power	133.6 V/m

Uncertainty for E-field measurement: 12.8% (k=2)

3 Appendix

3.1 Antenna Parameters

Frequency	Return Loss	Impedance
1710 MHz	22.2 dB	(52.3 + j7.6) Ohm
1880 MHz	20.5 dB	(49.7 + j9.4) Ohm
1900 MHz	20.7 dB	(52.2 + j9.2) Ohm
1950 MHz	27.8 dB	(52.4 + j3.4) Ohm
2000 MHz	19.2 dB	(43.7 + j8.2) Ohm

3.2 Antenna Design and Handling

The calibration dipole has a symmetric geometry with a built-in two stub matching network, which leads to the enhanced bandwidth.

The dipole is built of standard semirigid coaxial cable. The internal matching line is open ended. The antenna is therefore open for DC signals.

Do not apply force to dipole arms, as they are liable to bend. The soldered connections near the feedpoint may be damaged. After excessive mechanical stress or overheating, check the impedance characteristics to ensure that the internal matching network is not affected.

After long term use with 40W radiated power, only a slight warming of the dipole near the feedpoint can be measured.

Author Data
Daoud Attayi

Dates of Test
July 03-Aug 11, 2009

Report No
RTS-1689-0908-37

FCC ID
L6ARCM70UW

3.3 Measurement Sheets

3.3.1 Return Loss and Smith Chart

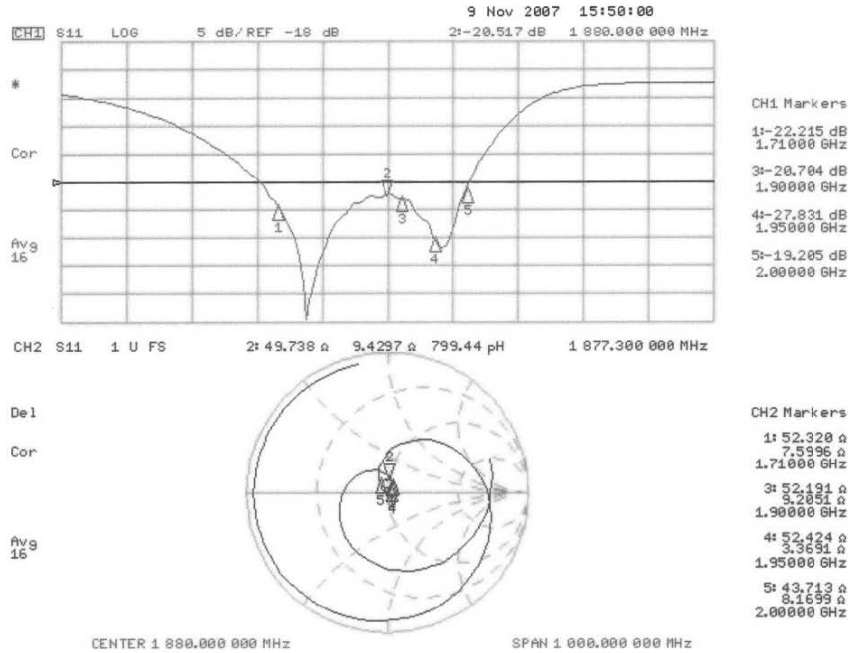

	Document		Page
	Annex B to Hearing Aid Compatibility RF Emissions Test Report for the BlackBerry® Smartphone model RCM71UW		12(13)
Author Data Daoud Attayi	Dates of Test July 03-Aug 11, 2009	Report No RTS-1689-0908-37	FCC ID L6ARCM70UW

3.3.2 DASY4 H-Field Result

Date/Time: 08.11.2007 11:15:44

Test Laboratory: SPEAG Lab 2

DUT: HAC Dipole 1880 MHz; Type: CD1880V3; Serial: 1008
 Communication System: CW; Frequency: 1880 MHz; Duty Cycle: 1:1
 Medium parameters used: $\sigma = 0 \text{ mho/m}$, $\epsilon_r = 1$; $\rho = 1 \text{ kg/m}^3$
 Phantom section: H Dipole Section
 Measurement Standard: DASY4 (High Precision Assessment)

DASY4 Configuration:

- Probe: H3DV6 - SN6065; Calibrated: 27.12.2006
- Sensor-Surface: (Fix Surface)
- Electronics: DAE4 Sn781; Calibrated: 02.10.2007
- Phantom: HAC Test Arch with Coil; Type: SD HAC P01 BA; Serial: 1070
- Measurement SW: DASY4, V4.7 Build 55; Postprocessing SW: SEMCAD, V1.8 Build 176

H Scan - Sensor Center 10mm above CD1880V3 Dipole/Hearing Aid Compatibility Test (41x181x1):

Measurement grid: dx=5mm, dy=5mm
 Maximum value of peak Total field = 0.465 A/m
 Probe Modulation Factor = 1.00
 Device Reference Point: 0.000, 0.000, 354.7 mm
 Reference Value = 0.490 A/m; Power Drift = -0.001 dB
Hearing Aid Near-Field Category: M2 (AWF 0 dB)

Peak H-field in A/m

Grid 1	Grid 2	Grid 3
0.395 M2	0.428 M2	0.415 M2
Grid 4	Grid 5	Grid 6
0.434 M2	0.465 M2	0.451 M2
Grid 7	Grid 8	Grid 9
0.394 M2	0.423 M2	0.409 M2

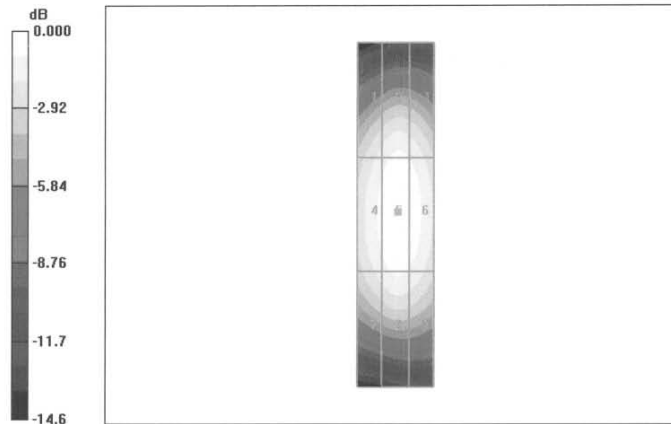

0 dB = 0.465A/m

	Document		Page
	Annex B to Hearing Aid Compatibility RF Emissions Test Report for the BlackBerry® Smartphone model RCM71UW		13(13)
Author Data Daoud Attayi	Dates of Test July 03-Aug 11, 2009	Report No RTS-1689-0908-37	FCC ID L6ARCM70UW

3.3.2 DASy4 E-Field Result

Date/Time: 07.11.2007 15:57:04

Test Laboratory: SPEAG Lab 2

DUT: HAC Dipole 1880 MHz; Type: CD1880V3; Serial: 1008
 Communication System: CW; Frequency: 1880 MHz; Duty Cycle: 1:1
 Medium parameters used: $\sigma = 0 \text{ mho/m}$, $\epsilon_r = 1$; $\rho = 1000 \text{ kg/m}^3$
 Phantom section: E Dipole Section
 Measurement Standard: DASy4 (High Precision Assessment)

DASy4 Configuration:

- Probe: ER3DV6 - SN2336; ConvF(1, 1, 1); Calibrated: 27.12.2006
- Sensor-Surface: (Fix Surface)
- Electronics: DAE4 Sn781; Calibrated: 02.10.2007
- Phantom: HAC Test Arch with Coil; Type: SD HAC P01 BA; Serial: 1070
- Measurement SW: DASy4, V4.7 Build 55; Postprocessing SW: SEMCAD, V1.8 Build 176

E Scan - Sensor Center 10mm above CD1880V3 Dipole/Hearing Aid Compatibility Test (41x181x1): Measurement
 grid: dx=5mm, dy=5mm
 Maximum value of peak Total field = 133.7 V/m
 Probe Modulation Factor = 1.00
 Device Reference Point: 0.000, 0.000, 354.7 mm
 Reference Value = 149.2 V/m; Power Drift = 0.031 dB
Hearing Aid Near-Field Category: M2 (AWF 0 dB)

Peak E-field in V/m

Grid 1 128.8 M2	Grid 2 133.7 M2	Grid 3 132.1 M2
Grid 4 88.1 M3	Grid 5 90.8 M3	Grid 6 87.7 M3
Grid 7 127.1 M2	Grid 8 133.5 M2	Grid 9 130.8 M2

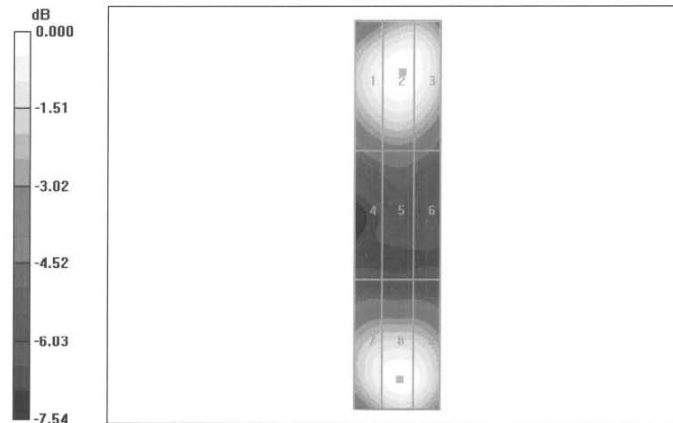

0 dB = 133.7V/m