

EMI Test Report

Tested in accordance with
Federal Communications Commission (FCC)
Personal Communications Services
CFR 47 Parts 2, 22 and 24
&
Industry Canada (IC) RSS-132 and 133



A division of Research In Motion Limited

REPORT NO: RTS-1765-0907-21

PRODUCT MODEL NO:	RCK71CW
TYPE NAME:	BlackBerry® smartphone
FCC ID:	L6ARCK70CW
IC:	2503A-RCK70CW
EMISSION DESIGNATOR (GSM):	247KG7W
EMISSION DESIGNATOR (EDGE):	247KGXW
EMISSION DESIGNATOR (CDMA):	1M29F9W

DATE: 24 August 2009

	EMI Test Report for the BlackBerry® smartphone Model RCK71CW	
Test Report No. RTS-1765-0907-21	Dates of Test July 23 to August 24, 2009	Author Data Michael Cino

Statement of Performance:

The BlackBerry® smartphone, model RCK71CW, part number CER-27168-001 Rev 2 and accessories performs within the requirements of the test standards when configured and operated per RIM's instructions.

Declaration:

We hereby certify that:
The test data reported herein is an accurate record of the performance of the sample(s) tested. The test results are valid for the tested unit (s) only. The test equipment used was suitable for the tests performed and within manufacturer's published specifications and operating parameters. The test methods were consistent with the methods described in the relevant standards.

Documented by:



Michael Cino
Regulatory Compliance Intern
Date: 24 August, 2009

Reviewed by:



Masud S. Attayi, P.Eng.
Manager, Regulatory Compliance
Date: 24 August, 2009

Approved by:



Paul G. Cardinal, Ph.D.
Director
Date: 25 August, 2009



		EMI Test Report for the BlackBerry® smartphone Model RCK71CW
Test Report No. RTS-1765-0907-21	Dates of Test July 23 to August 24, 2009	Author Data Michael Cino

Table of Contents

A)	Scope	4
B)	Associated Documents.....	4
C)	Product Identification.....	4
D)	Support Equipment Used for the Testing of the EUT	5
E)	Test Voltage	5
F)	Modifications to EUT	5
G)	Summary of Results	6
H)	Compliance Test Equipment Used.....	12
APPENDIX 1A – GSM CONDUCTED RF EMISSIONS TEST DATA/PLOTS.....		14
APPENDIX 1B – CDMA CONDUCTED RF EMISSIONS TEST DATA/PLOTS		28
APPENDIX 2A – GSM CONDUCTED RF OUTPUT POWER TEST DATA.....		44
APPENDIX 2B – CDMA CONDUCTED RF OUTPUT POWER TEST DATA.....		46
APPENDIX 3A – GSM FREQUENCY STABILITY TEST DATA		48
APPENDIX 3B – CDMA FREQUENCY STABILITY TEST DATA		60
APPENDIX 4A – GSM RADIATED EMISSIONS TEST DATA.....		72
APPENDIX 4B – CDMA RADIATED EMISSIONS TEST DATA		81

		EMI Test Report for the BlackBerry® smartphone Model RCK71CW
Test Report No. RTS-1765-0907-21	Dates of Test July 23 to August 24, 2009	Author Data Michael Cino

A) Scope

This report details the results of compliance tests which were performed in accordance to the requirements of:

- FCC CFR 47 Part 2, Oct. 1, 2008
- FCC CFR 47 Part 22, Subpart H, Cellular Radiotelephone Services, Oct. 1, 2008
- FCC CFR 47 Part 24 Subpart E, Broadband PCS, Oct 1. 2008
- Industry Canada, RSS-132 Issue 2, September 2005, Cellular Telephones Employing New Technologies Operating in the Bands 824-849 MHz and 869-894 MHz.
- Industry Canada, RSS-133 Issue 5, February 2009, 2 GHz Personal Communications Services.

B) Associated Documents

1. HW_Declaration_CER-27168-Rev2

C) Product Identification

Manufactured by Research In Motion Limited whose headquarters is located at:

295 Phillip Street
Waterloo, Ontario
Canada, N2L 3W8
Phone: 519 888 7465
Fax: 519 888 6906

The equipment under test (EUT) was tested at the following locations:

RIM Testing Services EMI test facilities

305 Phillip Street
Waterloo, Ontario
Canada, N2L 3W8
Phone: 519 888 7465
Fax: 519 888 6906

440 Phillip Street
Waterloo, Ontario,
Canada , N2L 5R9
Phone: 519 888 7465
Fax: 519 888 6906

The testing was performed from July 23 to August 24, 2009.

		EMI Test Report for the BlackBerry® smartphone Model RCK71CW	
Test Report No. RTS-1765-0907-21	Dates of Test July 23 to August 24, 2009		Author Data Michael Cino

The sample EUT included:

SAMPLE	MODEL	CER NUMBER	PIN
1	RCK71CW	CER-27168-Rev 1	30C1C104
2	RCK71CW	CER-27168-Rev 1	30C2BF79
3	RCK71CW	CER-27168-Rev 1	30C2BF78
4	RCK71CW	CER-27168-Rev 2	30C43837
5	RCK71CW	CER-27168-Rev 2	30C435AD

RF Conducted Emissions testing was performed on samples 1 and 4.
Radiated Emissions testing was performed on samples 2, 3 and 5.

To view the differences between CER-27168-Rev 1 and CER-24239-001 Rev 2, see document number HW_Declaration_CER-27168-Rev2

Only the measurements that may have been impacted by the changes from Rev 1 to Rev 2 were re-measured.

D) Support Equipment Used for the Testing of the EUT

No support equipment required; for list of equipment refer to section H, Compliance Test Equipment Used.

E) Test Voltage

The ac input voltage was 120 volts, 60 Hz where applicable. This configuration was per RIM's specifications.

F) Modifications to EUT

No modifications were required on the EUT.

		EMI Test Report for the BlackBerry® smartphone Model RCK71CW	
Test Report No. RTS-1765-0907-21	Dates of Test July 23 to August 24, 2009	Author Data Michael Cino	

G) Summary of Results

SPECIFICATION		TEST TYPE	RESULT	TEST DATA APPENDIX
FCC CFR 47	IC			
Part 2.1051 Part 22.917 Part 22.901	RSS-GEN, 4.9	GSM 850 Conducted Spurious Emissions	Pass	1A
Part 2.1051 Part 24.238(a)	RSS-GEN, 4.9	GSM PCS Conducted Spurious Emissions	Pass	1A
Part 2.202 Part 22.917	RSS-GEN, 4.6	GSM 850 Occupied Bandwidth and Channel Mask	Pass	1A
Part 2.202 Part 24.238	RSS-GEN, 4.6	GSM PCS Occupied Bandwidth and Channel Mask	Pass	1A
Part 2.1046(a)	RSS-133, 6.4 RSS-132, 4.4	GSM Conducted RF Output Power	Pass	2A
Part 2.1055(a)(d) Part 22.917	RSS-132, 4.3	GSM 850 Frequency Stability vs. Temperature and Voltage	Pass	3A
Part 2.1055(a)(d) Part 24.235	RSS-132, 4.3	GSM PCS Frequency Stability vs. Temperature and Voltage	Pass	3A
Part 22, Subpart H, Part 24, Subpart E	RSS-GEN, 4.9	GSM ERP, EIRP	Pass	4A
Part 22, Subpart H Part 24, Subpart E	RSS-GEN, 4.9	GSM Radiated Spurious/Harmonic Emissions	Pass	4A
Part 2.1051 Part 22.917 Part 22.901(d)	RSS-GEN, 4.9	CDMA Cell Conducted Spurious Emissions	Pass	1B
Part 2.1051 Part 24.238(a)	RSS-GEN, 4.9	CDMA PCS Conducted Spurious Emissions	Pass	1B
Part 2.202 Part 22.917	RSS-GEN, 4.6	CDMA Cell Occupied Bandwidth and Channel Mask	Pass	1B
Part 2.202 Part 24.238	RSS-GEN, 4.6	CDMA PCS Occupied Bandwidth and Channel Mask	Pass	1B
Part 2.1046(a)	RSS-133, 6.4 RSS-132, 4.4	CDMA Conducted RF Output Power	Pass	2B
Part 2.1055(a)(d) Part 22.917	RSS-132, 4.3	CDMA Cell Frequency Stability vs. Temperature and Voltage	Pass	3B

		EMI Test Report for the BlackBerry® smartphone Model RCK71CW	
Test Report No. RTS-1765-0907-21	Dates of Test July 23 to August 24, 2009	Author Data Michael Cino	

Summary of Results cont'd

Part 2.1055(a)(d) Part 24.235	RSS-GEN, 4.7	CDMA PCS Frequency Stability vs. Temperature and Voltage	Pass	3B
Part 22, Subpart H	RSS-GEN, 4.9	CDMA Cell Radiated Spurious/Harmonic Emissions, ERP	Pass	4B
Part 24, Subpart E	RSS-GEN, 4.9	CDMA PCS Radiated Spurious/Harmonic Emissions, EIRP	Pass	4B

- 1) The BlackBerry® smartphone met the requirements of the Tx Conducted Spurious Emissions requirements in the GSM850 as per 47 CFR 2.1051, CFR 22.917, CFR 22.901(d) and RSS-GEN, 4.9. The EUT was measured on the low, middle and high channels. The frequency range investigated was from 10 MHz to 10 GHz. See APPENDIX 1A for test data.
- 2) The BlackBerry® smartphone met the requirements of the Tx Conducted Spurious Emissions requirements in the PCS1900 as per 47 CFR 2.1051, CFR 24.238(a) and RSS-GEN, 4.9. The EUT was on the low, middle and high channels. The frequency range investigated was from 10 MHz to 20 GHz. See APPENDIX 1A for test data.
- 3) The BlackBerry® smartphone met the requirements of the Occupied Bandwidth and channel mask requirements in the GSM850 as per 47 CFR 2.202, CFR 22.917 and RSS-GEN, 4.6. The EUT was measured in GSM and EDGE mode on the low, middle and high channels. See APPENDIX 1A for test data.
- 4) The BlackBerry® smartphone met the requirements of the Occupied Bandwidth and channel mask requirements in the PCS1900 as per 47 CFR 2.202, CFR 24.238 and RSS-GEN, 4.6. The EUT was measured in GSM and EDGE mode on the low, middle and high channels. See APPENDIX 1A for test data.
- 5) The BlackBerry® smartphone met the requirements of the Conducted RF Output Power requirements for the GSM850 and PCS1900 as per 47 CFR 2.1046(a), RSS 133, 6.4 and RSS 132, 4.4. The EUT was measured in GSM and EDGE mode on the low, middle and high channels. See APPENDIX 2A for the test data.

		EMI Test Report for the BlackBerry® smartphone Model RCK71CW
Test Report No. RTS-1765-0907-21	Dates of Test July 23 to August 24, 2009	Author Data Michael Cino

- 6) The BlackBerry® smartphone met the requirements of the Frequency Stability vs. Temperature and Voltage requirements for GSM850 as per 47 CFR 2.1055(a), 2.1055(d), CFR 22.917 and RSS-132, 4.3. The temperature range was from -30°C to +60°C in 10° temperature steps. The EUT was measured on low, middle and high channels at each temperature step. The EUT was measured at low (3.6 volts), nominal (3.7 volts) and high (4.2 volts) dc input voltage at each temperature step and channel at maximum output power.
See APPENDIX 3A for the test data.
- 7) The BlackBerry® smartphone met the requirements of the Frequency Stability vs. Temperature and Voltage requirements for the PCS1900 as per 47 CFR 2.1055(a), 2.1055(d), 24.235 and RSS-132, 4.3. The temperature range was from -30°C to +60°C in 10° temperature steps. The EUT was measured on low, middle and high channels at each temperature step. The EUT was measured at low (3.6 volts), nominal (3.7 volts) and high (4.2 volts) dc input voltage at each temperature step and channel at maximum output power.
See APPENDIX 3A for the test data.
- 8) The BlackBerry® smartphone met the requirements of the Conducted Spurious Emissions in the Cellular band as per 47 CFR 1057, CFR 22.917, CFR 22.901(d) and RSS-GEN, 4.9. The EUT was measured in Loopback and 1xEVDO mode on the low, middle and high channels. The frequency range investigated was from 10 MHz to 10 GHz.
See APPENDIX 1B for the test data.
- 9) The BlackBerry® smartphone met the requirements of the Conducted Spurious Emissions in the PCS band as per 47 CFR 2.1057, CFR 24.238 and RSS-GEN, 4.9. The EUT was measured in Loopback and 1xEVDO mode on the low, middle and high channels. The frequency range investigated was from 10 MHz to 20 GHz.
See APPENDIX 1B for the test data.
- 10) The BlackBerry® smartphone met the requirements of the Occupied Bandwidth in the Cellular band as per 47 CFR 2.202, CFR 22.917 and RSS-GEN, 4.6. The channels were measured in Loopback and 1xEVDO mode on the low, middle and high channels.
See APPENDIX 1B for the test data.
- 11) The BlackBerry® smartphone met the requirements of the Occupied Bandwidth and channel mask in the PCS band as per 47 CFR 2.202, CFR 24.238 and RSS-GEN, 4.6. The channels were measured in Loopback and 1xEVDO mode on the low, middle and high channels.
See APPENDIX 1B for the test data.

		EMI Test Report for the BlackBerry® smartphone Model RCK71CW	
Test Report No. RTS-1765-0907-21	Dates of Test July 23 to August 24, 2009		Author Data Michael Cino

- 12) The BlackBerry® smartphone met the requirements of the Conducted RF Output Power for both the Cellular and PCS bands as per 47 CFR 2.1046(a), RSS-133, 6.4 and RSS-132, 4.4. The channels were measured in Loopback and 1xEVDO mode on the low, middle and high channels.
See APPENDIX 2B for the test data.
- 13) The BlackBerry® smartphone met the requirements of the Frequency Stability vs. Temperature and Voltage for Cellular band as per 47 CFR 2.1055(a)(d), CFR 22.917 and RSS-132, 4.3. The maximum frequency error measured was less than 0.1 ppm.
The temperature range was from -30°C to +60°C in 10° temperature steps. The BlackBerry® smartphone was measured on low, middle and high channels at each temperature step. The BlackBerry® smartphone was measured at low (3.6 volts), nominal (3.7 volts) and high (4.2 volts) dc input voltage at each temperature step and channel at maximum output power.
See APPENDIX 3B for the test data.
- 14) The BlackBerry® smartphone met the requirements of the Frequency Stability vs. Temperature and Voltage requirements for the PCS band as per 47 CFR 2.1055(a)(d), CFR 24.235 and RSS-GEN, 4.7. The maximum frequency error measured was less than 0.1 ppm.
The temperature range was from -30°C to +60°C in 10 degree temperature steps. The BlackBerry® smartphone was measured on low, middle and high channels at each temperature step. The BlackBerry® smartphone was measured at low (3.6 volts), nominal (3.7 volts) and high (4.2 volts) dc input voltage at each temperature step and channel at maximum output power.
See APPENDIX 3B for the test data.
- 15) The radiated spurious emissions/harmonics and ERP/EIRP were measured for GSM 850, PCS 1900, CDMA Cellular and PCS bands. The results are within the limits. The BlackBerry® smartphone was placed on a nonconductive styrofoam table, 100 cm high that was positioned on a remotely controlled turntable. The test distance used between the BlackBerry® smartphone and the receiving antenna was three metres. Then the emissions were maximized by elevating the antenna in the range of 1 to 4 metres. The turntable was rotated to determine the azimuth of the peak emissions. Both the horizontal and vertical polarizations of the emissions were measured. The maximum emissions level was recorded. The BlackBerry® smartphone was then substituted with an antenna placed in the same location as the BlackBerry® smartphone. A Dipole antenna was used for the ERP measurements and a Horn antenna was used for EIRP measurements. The substitution antenna was connected into a signal generator that was set to the test frequency.

		EMI Test Report for the BlackBerry® smartphone Model RCK71CW
Test Report No. RTS-1765-0907-21	Dates of Test July 23 to August 24, 2009	Author Data Michael Cino

The emissions were maximized by elevating the antenna in the range of 1 to 4 metres. The signal generator output was then adjusted to match the BlackBerry® smartphone output reading. The signal generator output was recorded. Both the horizontal and vertical polarizations of the emissions were measured.

The following measurements were done in a semi-anechoic chamber (SAC) below 1 GHz and a fully-anechoic room (FAR) above 1 GHz. The SAC's FCC registration number is **778487** and the Industry Canada (IC) file number is **2503B-1**. The FAR's FCC registration number is **959115** and the IC file number is **2503C-1**. The BlackBerry® smartphone was measured on the low, middle and high channels.

The ERP in the 850 band, GSM mode was measured on BlackBerry® smartphone. The highest ERP measured was 31.14 dBm (1.30 W) at 837.60 MHz (channel 195).

The ERP in the 850 band, EDGE mode was measured on BlackBerry® smartphone. The highest ERP measured was 24.27 dBm (0.27 W) at 837.60 MHz (channel 195).

The EIRP in the PCS band, GSM mode was measured on BlackBerry® smartphone. The highest ERP measured was 29.36 dBm (0.86 W) at 1850.2 MHz (channel 512).

The EIRP in the PCS band, EDGE mode was measured on BlackBerry® smartphone. The highest ERP measured was 24.52 dBm (0.28 W) at 1880.0 MHz (channel 661).

The ERP in the Cellular band, Loopback service mode was measured on BlackBerry® smartphone. The highest ERP measured was 23.52 dBm (0.22 W) at 836.52 MHz (channel 384).

The ERP in the Cellular band, 1xEVDO mode was measured on BlackBerry® smartphone. The highest ERP measured was 23.06 dBm (0.20 W) at 836.52 MHz (channel 384).

The EIRP in the PCS band, Loopback Service mode was measured on BlackBerry® smartphone. The highest EIRP measured was 27.29 dBm (0.54 W) at 1880.00 MHz (channel 600).

The EIRP in the PCS band, 1xEVDO mode was measured on BlackBerry® smartphone. The highest EIRP measured was 27.84 dBm (0.61 W) at 1880.00 MHz (channel 600).

The radiated spurious emission and carrier harmonics were measured up to the 10th harmonic for low, middle and high channels in the GSM850 and PCS bands.

	EMI Test Report for the BlackBerry® smartphone Model RCK71CW	
Test Report No. RTS-1765-0907-21	Dates of Test July 23 to August 24, 2009	Author Data Michael Cino

Each band was measured in GSM and EDGE mode. Both the horizontal and vertical polarizations were measured.

The margins in the 850 band for GSM and EDGE modes harmonic emissions were greater than 25 dB below the accepted limits for all test frequencies.

The margins in the PCS band for GSM and EDGE modes harmonic emissions were greater than 25 dB below the accepted limits for all test frequencies.

The radiated carrier harmonics were measured up to the 10th harmonic for low, middle and high channels in the Cellular and PCS bands. Each band was measured in Loopback, Testdata, and 1xEVDO modes. Both the horizontal and vertical polarizations were measured.

The worst test margin in the Cellular band harmonic emissions measured was 15.34 dB below the limit at 2509.304 MHz.

The worst test margin in the PCS band harmonic emissions measured was 15.42 dB below the limit at 3817.176 MHz.

Co-Location Measurements

The radiated emissions were measured up to 18 GHz for middle channels for simultaneous transmission in the following test configuration combinations: GSM850/Bluetooth, PCS1900/Bluetooth, GSM850/Wi-Fi 802.11b, PCS1900/Wi-Fi 802.11b and Cellular/Bluetooth, PCS/Bluetooth, Cellular/Wi-Fi 802.11b, PCS/Wi-Fi 802.11b.

Both the horizontal and vertical polarizations were measured. The emissions due to different simultaneous transmission did not increase the amplitude of any emissions nor did it produce any new inter-modulation products as a result of mixing.

Sample Calculation:

Field Strength (dB μ V/M) is calculated as follows:

FS = Measured Level (dB μ V) + A.F. (dB/m) + Cable Loss (dB) - Preamp (dB) + Filter Loss (dB)

To view the test data see APPENDIX 4A and 4B.

Measurement Uncertainty \pm 4.6 dB

		EMI Test Report for the BlackBerry® smartphone Model RCK71CW	
Test Report No. RTS-1765-0907-21	Dates of Test July 23 to August 24, 2009	Author Data Michael Cino	

H) Compliance Test Equipment Used

<u>UNIT</u>	<u>MANUFACTURER</u>	<u>MODEL</u>	<u>SERIAL NUMBER</u>	<u>CAL DUE DATE</u> (YY MM DD)	<u>USE</u>
Preamplifier	Sonoma	310N/11909A	185831	09-11-07	Radiated Emissions
Preamplifier system	TDK RF Solutions	PA-02	080010	09-11-07	Radiated Emissions
Preamplifier	Rohde & Schwarz	TS-ANA4-SP	001	10-05-08	Radiated Emissions
Preamplifier	Rohde & Schwarz	TS-ANA-SP	001	10-03-31	Radiated Emissions
Hybrid Log Antenna	TDK	HLP-3003C	017301	09-10-24	Radiated Emissions
Horn Antenna	TDK	HRN-0118	030101	10-07-22	Radiated Emissions
Horn Antenna	TDK	HRN-0118	030201	11-03-17	Radiated Emissions
Horn Antenna	ETS-Lindgren	3117	47653	11-07-15	Radiated Emissions
Horn Antenna	CMT	LHA 0180	R52734-001	09-12-17	Radiated Emissions
Preamplifier	TDK	18-26	030002	09-11-07	Radiated Emissions
Dipole Antenna	Schwarzbeck	UHAP	1018	11-03-12	Radiated Emissions
Dipole Antenna	Schwarzbeck	UHAP	974	11-10-16	Radiated Emissions
EMC Analyzer	Agilent	E7405A	US40240226	09-10-01	Radiated Emissions
Universal Radio Communication Tester	Rohde & Schwarz	CMU 200	837493/073	09-12-08	Radiated Emissions
Universal Radio Communication Tester	Rohde & Schwarz	CMU 200	112394	09-12-07	Radiated Emissions
Universal Radio Communication Tester	Rohde & Schwarz	CMU 200	102204	09-12-06	RF Conducted Emissions
Universal Radio Communication Tester	Agilent	8960	MY47510358	11-03-06	Frequency Stability, RF Conducted Emissions
EMI Receiver	Rohde & Schwarz	ESIB-40	100255	09-12-02	Radiated Emissions
Spectrum Analyzer	HP	8563E	3745A08112	09-09-22	RF Conducted Emissions
DC Power Supply	HP	6632B	US37472178	09-09-24	RF Conducted Emissions
Environment Monitor	Control Company	1870	230355190	10-02-12	Radiated Emissions
Environment Monitor	Control Company	1870	230355189	10-02-12	RF Conducted Emissions

		EMI Test Report for the BlackBerry® smartphone Model RCK71CW	
Test Report No. RTS-1765-0907-21	Dates of Test July 23 to August 24, 2009		Author Data Michael Cino

Compliance Test Equipment Used cont'd

<u>UNIT</u>	<u>MANUFACTURER</u>	<u>MODEL</u>	<u>SERIAL NUMBER</u>	<u>CAL DUE DATE</u> (YY MM DD)	<u>USE</u>
Temperature Probe	Control Company	15-077-21	51129471	10-05-01	Frequency Stability
Environmental Chamber	ESPEC Corp.	SH-240S1	91007118	N/R	Frequency Stability
Signal Generator	Agilent	8648C	4037U03155	09-09-20	Frequency Stability
Signal Generator	Agilent	E8257D	MY45140527	09-10-10	Radiated Emissions
Power Meter	Agilent	N1911A	MY45100905	11-01-05	Frequency Stability
Power Sensor	Agilent	N1921A	SG45240281	10-05-08	Frequency Stability

APPENDIX 1A – GSM CONDUCTED RF EMISSIONS TEST DATA/PLOTS

	EMI Test Report for the BlackBerry® smartphone Model RCK71CW	
	APPENDIX 1A	
Test Report No. RTS-1765-0907-21	Dates of Test July 23 to August 24, 2009	Author Data Michael Cino

GSM Conducted RF Emission Test Data

This appendix contains measurement data pertaining to conducted spurious emissions, -26 dBc bandwidth, 99% power bandwidth and the channel mask on BlackBerry® smartphone PIN 30C43837.

Test Setup Diagram

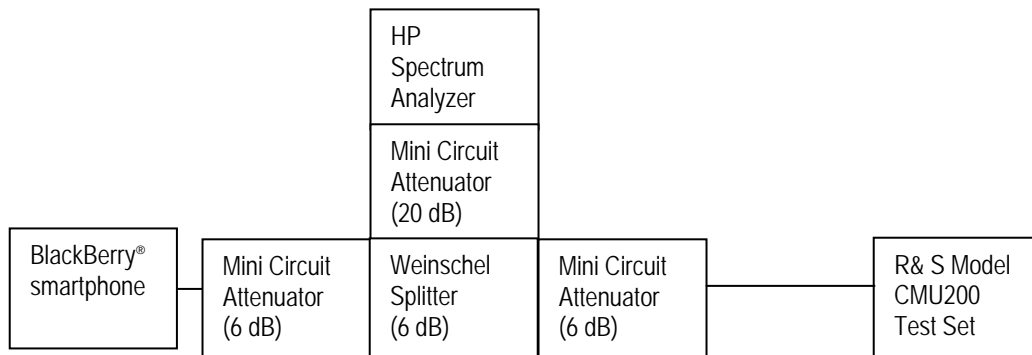

Date of Test: August 04 – 05, 2009

The environmental test conditions were:

Temperature: 22 – 24 °C
 Pressure: 1007 – 1014 mb
 Relative Humidity: 31 – 32 %

The following measurements were performed by Maurice Battler.

	EMI Test Report for the BlackBerry® smartphone Model RCK71CW	
	APPENDIX 1A	
Test Report No. RTS-1765-0907-21	Dates of Test July 23 to August 24, 2009	Author Data Michael Cino

GSM Conducted RF Emission Test Data cont'd

The conducted spurious emissions – As per 47 CFR 2.1051, CFR 24.238(a), RSS-GEN, 4.9, CFR 22 Subpart H and RSS-132 were measured from 10 MHz to 20 GHz. The EUT emissions were in the noise floor.
See figures 1-1a to 1-12a for the plots of the conducted spurious emissions.

–26 dBc Bandwidth and Occupied Bandwidth (99%)

For each carrier frequency of low, middle and high, the modulation spectrum was measured by both methods of 99% power bandwidth and –26 dBc bandwidth.

The resolution bandwidth required for out-of-band emissions in the 1 MHz bands immediately outside and adjacent to the frequency block, was determined to be at least 1% of the emission bandwidth.

The worst case –26dBc bandwidth for the GSM850 band was measured to be 277 kHz, and for the PCS1900 band was measured to be 275 kHz as shown below. This results in a 3.0 kHz resolution bandwidth.

On any frequency outside the frequency block and outside the adjacent 1 MHz bands, a resolution bandwidth of at least 1 MHz was employed.

Test Data for 850 band and 1900 band selected Frequencies in GSM mode.

850 band Frequency (MHz)	-26dBc Bandwidth (kHz)	99% Occupied Bandwidth (kHz)
824.2	270	245.0
837.6	277	246.7
848.8	272	243.3

1900 band Frequency (MHz)	-26dBc Bandwidth (kHz)	99% Occupied Bandwidth (kHz)
1850.2	272	243.3
1880.0	272	245.0
1909.8	275	246.7

Measurement Plots for 850 and 1900 in GSM mode

Refer to the following measurement plots for more detail.

See Figures 1-13a to 1-24a for the plots of the –26dBc Bandwidth and 99% Occupied Bandwidth.

See Figures 1-25a to 1-28a for plots of the channel mask results.

The RF power output was at maximum for all the recorded measurements shown below.

	EMI Test Report for the BlackBerry® smartphone Model RCK71CW	
	APPENDIX 1A	
Test Report No. RTS-1765-0907-21	Dates of Test July 23 to August 24, 2009	Author Data Michael Cino

GSM Conducted RF Emission Test Data cont'd

Date of Test: August 05, 2009

Test Data for 850 and 1900 bands selected Frequencies in EDGE mode.

850 band Frequency (MHz)	99% Occupied Bandwidth (kHz)
824.2	243.3
837.6	241.7
848.8	238.3

1900 band Frequency (MHz)	99% Occupied Bandwidth (kHz)
1850.2	246.7
1880.0	246.7
1909.8	245.0

Measurement Plots for 850 and 1900 bands in EDGE mode

Refer to the following measurement plots for more detail.

See Figures 1-29a to 1-34a for the plots of the 99% Occupied Bandwidth.

See Figures 1-35a to 1-38a for the plots of channel mask EDGE results.

The RF power output was at maximum for all the recorded measurements shown below.

Date of Test: August 05, 2009

GSM Conducted RF Emission Test Data cont'd

Figure 1-1a: GSM850 band, Spurious Conducted Emissions, Low channel

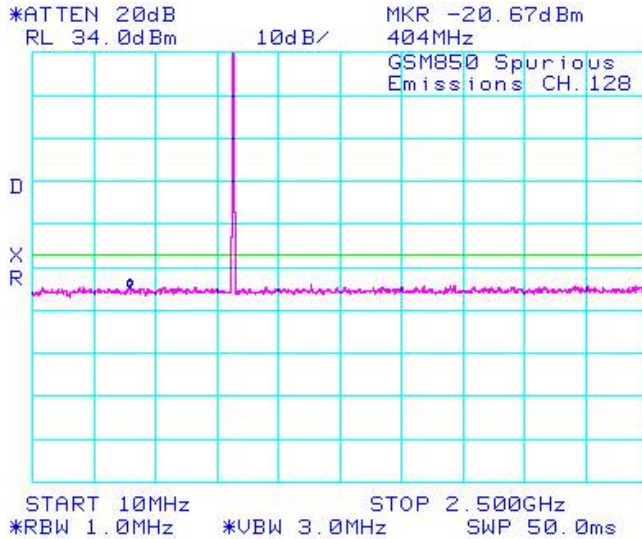

Figure 1-2a: GSM850 band, Spurious Conducted Emissions, Low channel

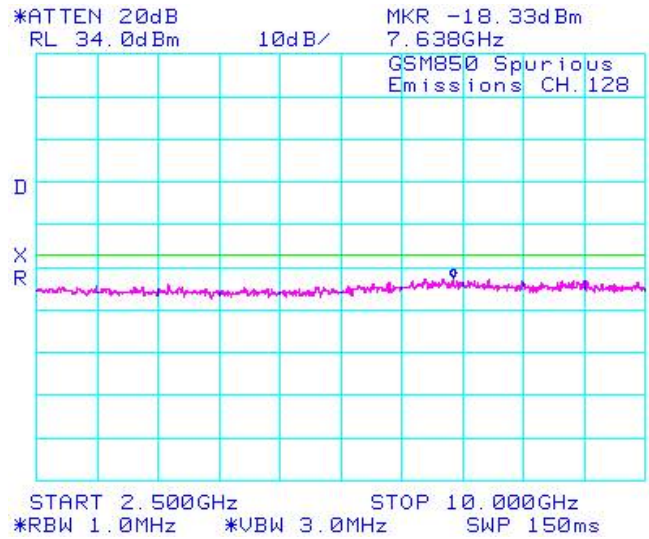

Figure 1-3a: GSM850 band, Spurious Conducted Emissions, Middle Channel

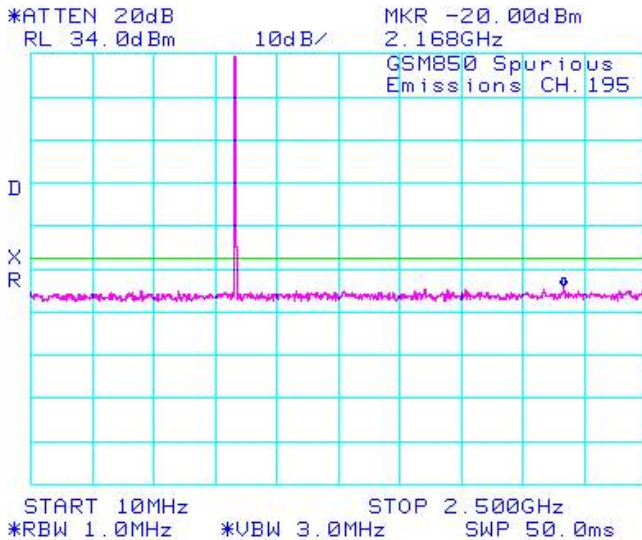
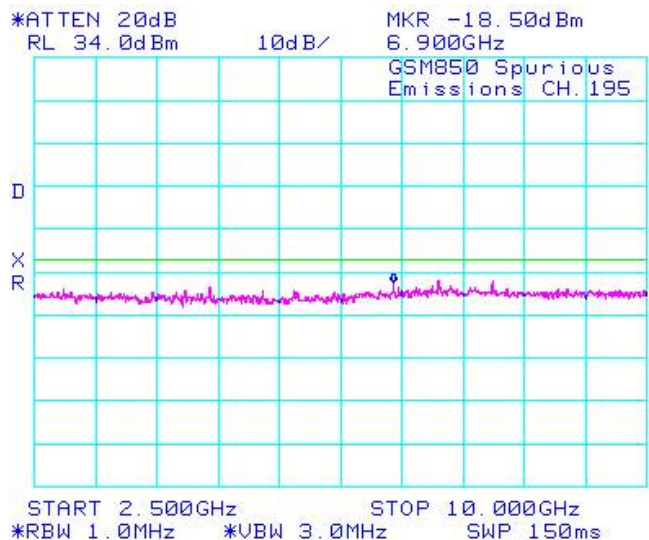

Figure 1-4a: GSM850 band, Spurious Conducted Emissions, Middle Channel



GSM Conducted RF Emission Test Data cont'd

Figure 1-5a: GSM850 band, Spurious Conducted Emissions, High Channel

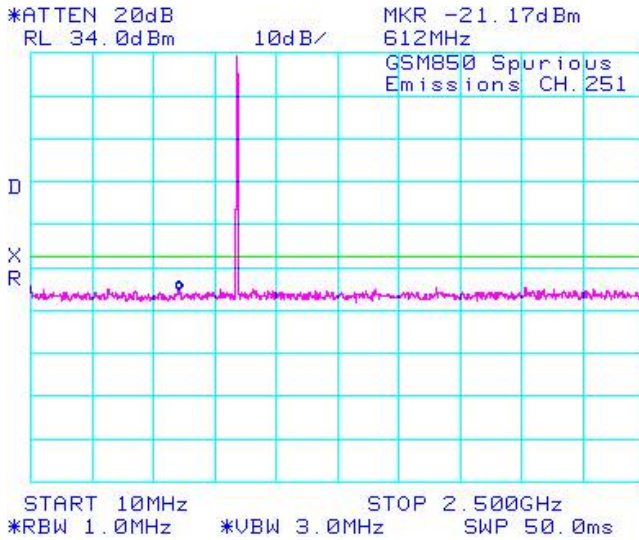

Figure 1-6a: GSM850 band, Spurious Conducted Emissions, High Channel

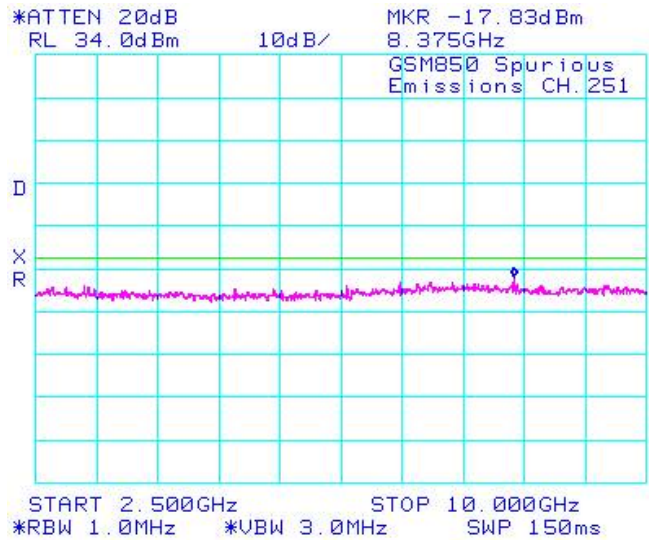

Figure 1-7a: PCS1900 band, Spurious Conducted Emissions, Low Channel

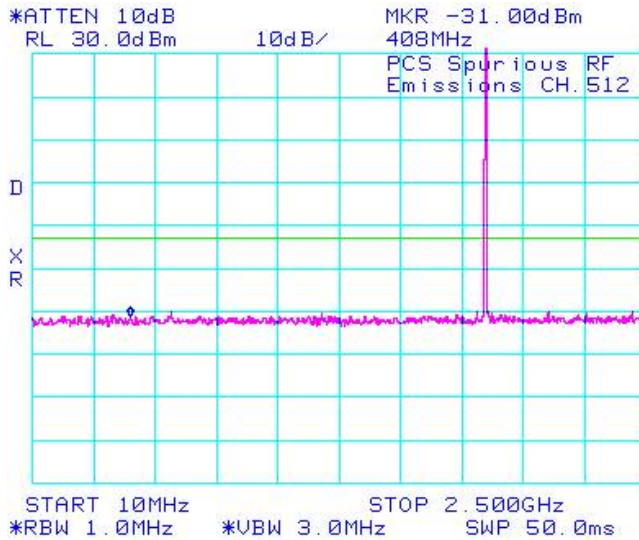
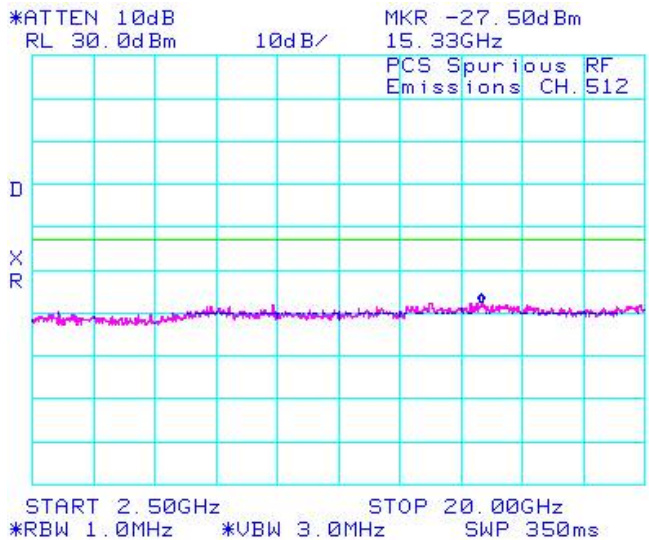



Figure 1-8a: PCS1900 band, Spurious Conducted Emissions, Low Channel



	EMI Test Report for the BlackBerry® smartphone Model RCK71CW	
	APPENDIX 1A	
Test Report No. RTS-1765-0907-21	Dates of Test July 23 to August 24, 2009	Author Data Michael Cino

GSM Conducted RF Emission Test Data cont'd

Figure 1-9a: PCS1900 band, Spurious Conducted Emissions, Middle Channel

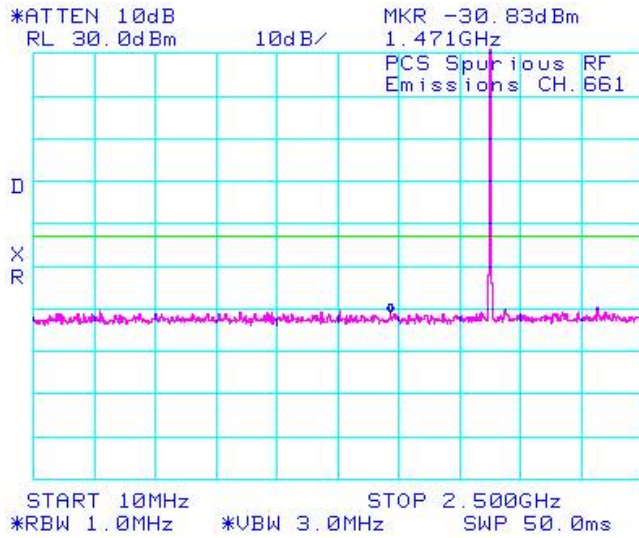

Figure 1-10a: PCS1900 band, Spurious Conducted Emissions, Middle Channel

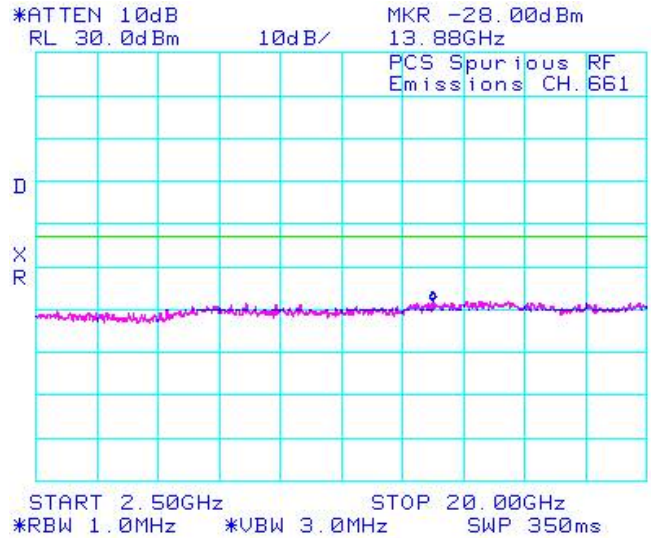

Figure 1-11a: PCS1900 band, Spurious Conducted Emissions, High Channel

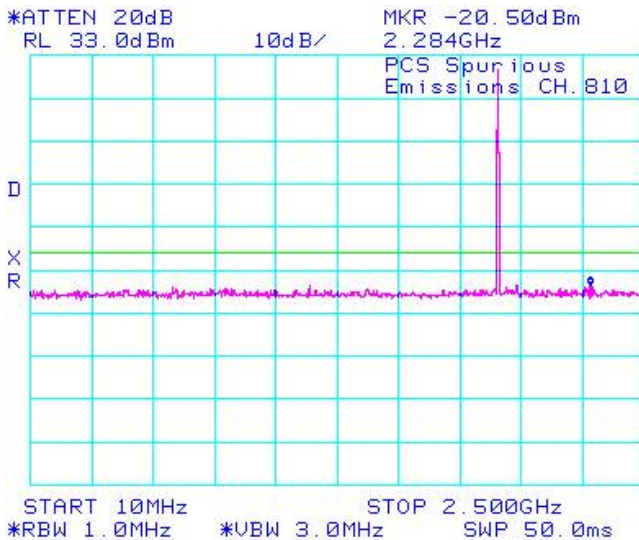
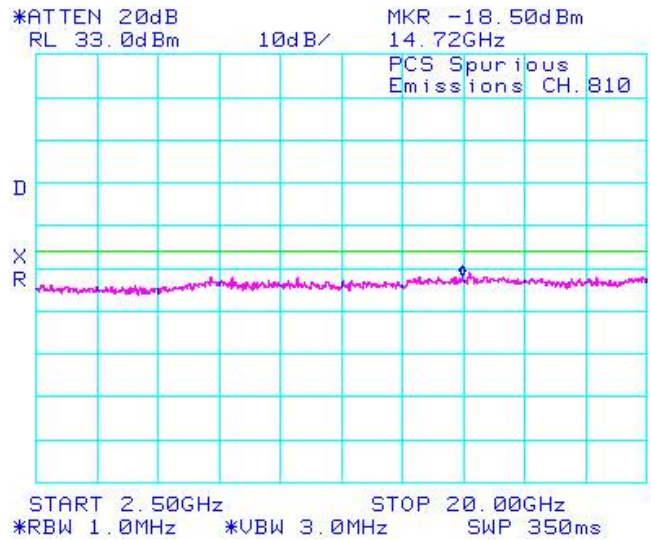

Figure 1-12a: PCS1900 band, Spurious Conducted Emissions, High Channel



GSM Conducted RF Emission Test Data cont'd

Figure 1-13a: -26dBc bandwidth, GSM850 band Low Channel in GSM mode

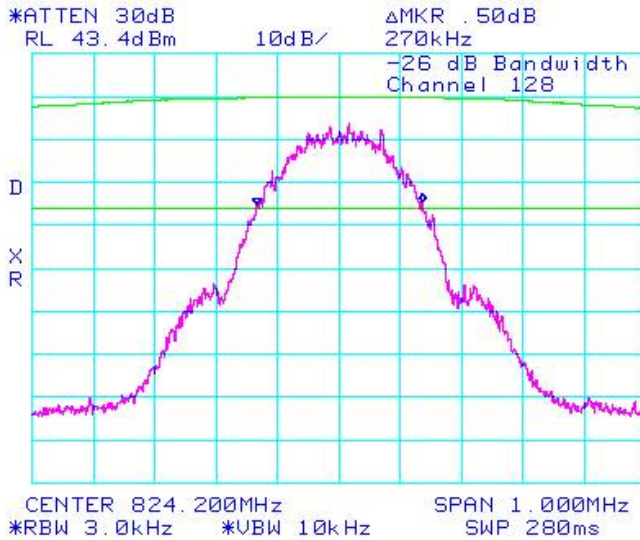

Figure 1-14a: Occupied Bandwidth, GSM850 band Low Channel in GSM mode

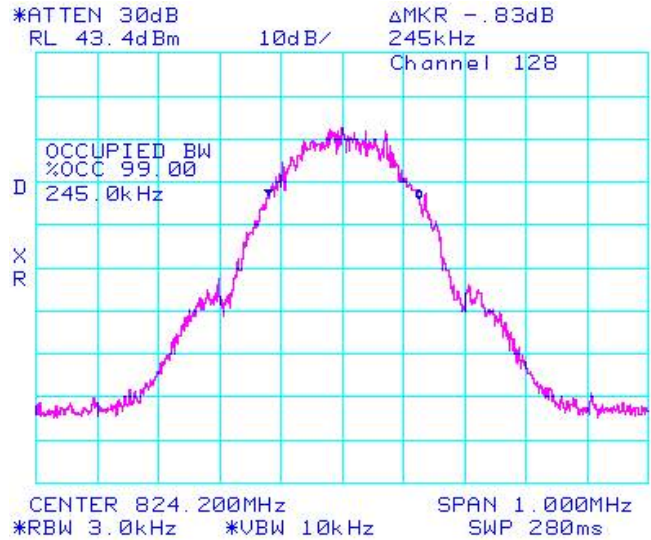

Figure 1-15a: -26dBc bandwidth, GSM850 band Middle Channel in GSM mode

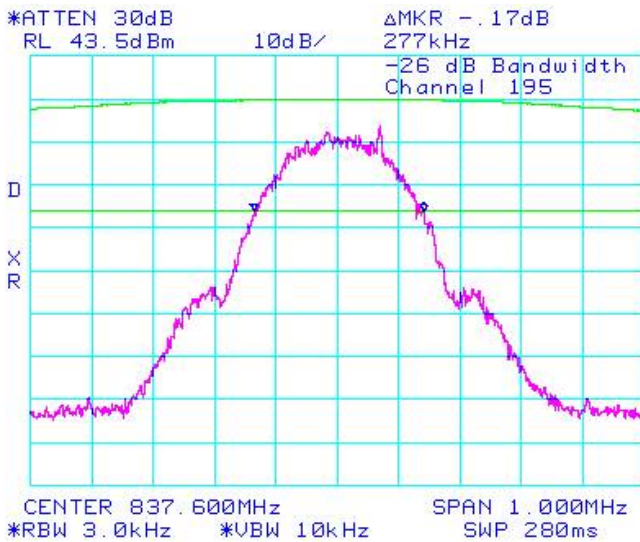
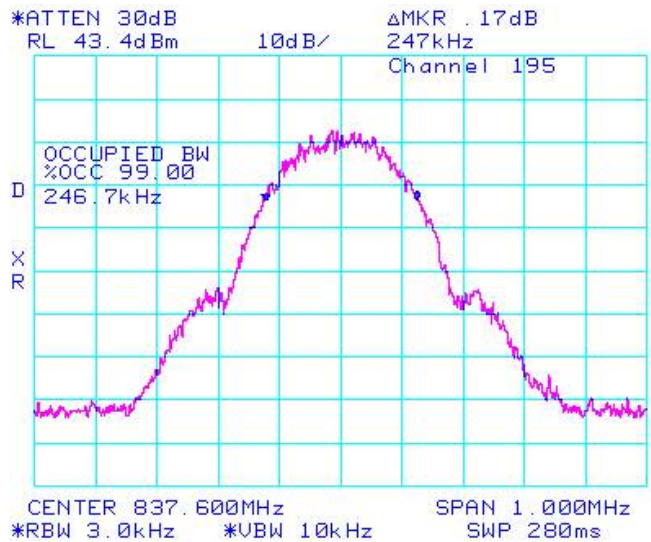

Figure 1-16a: Occupied Bandwidth, GSM850 band Middle Channel in GSM mode



GSM Conducted RF Emission Test Data cont'd

Figure 1-17a: -26dBc bandwidth, GSM850 band High Channel in GSM mode

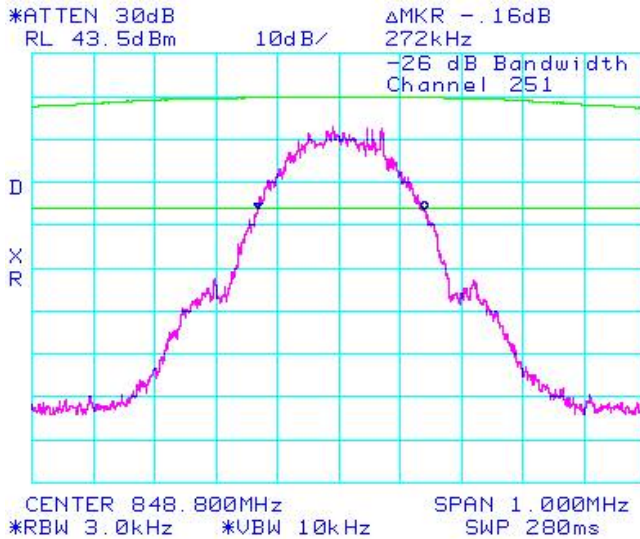

Figure 1-18a: Occupied Bandwidth, GSM850 band High Channel in GSM mode

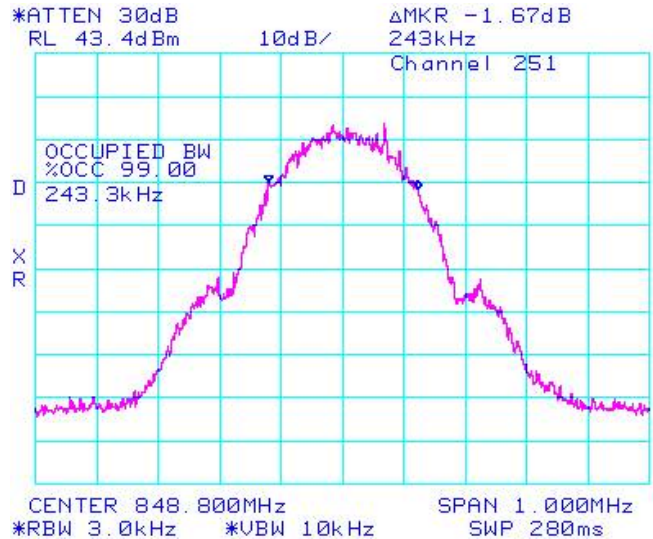
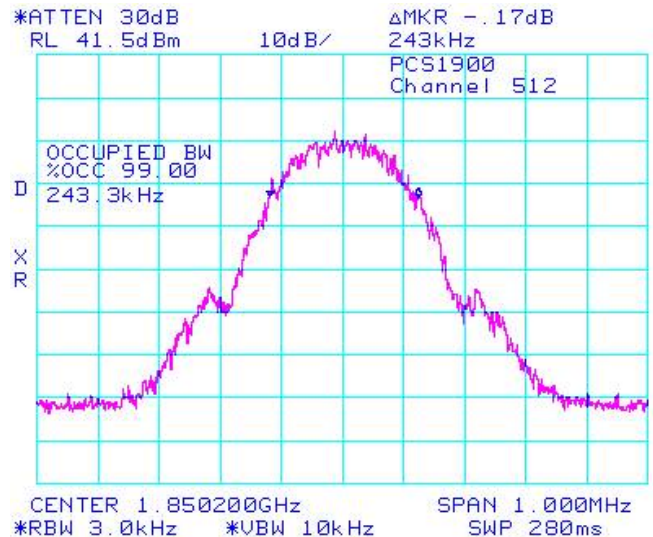

Figure 1-19a: -26dBc bandwidth, PCS1900 Low Channel in GSM mode



Figure 1-20a: Occupied Bandwidth, PCS1900 Low Channel in GSM mode



GSM Conducted RF Emission Test Data cont'd

Figure 1-21a: -26dBc bandwidth, PCS1900 Middle Channel in GSM mode

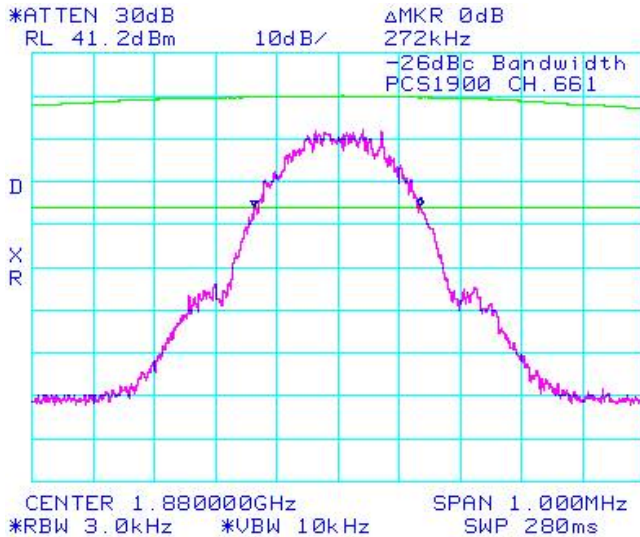

Figure 1-22a: Occupied Bandwidth, PCS1900 Middle Channel in GSM mode

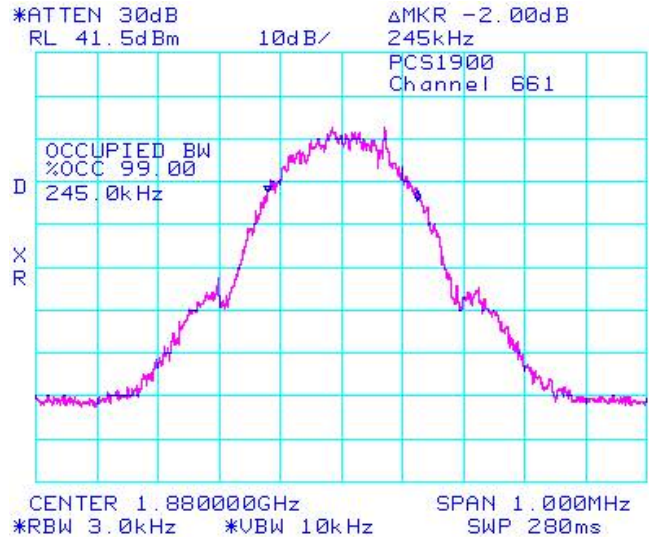

Figure 1-23a: -26dBc bandwidth, PCS1900 High Channel in GSM mode

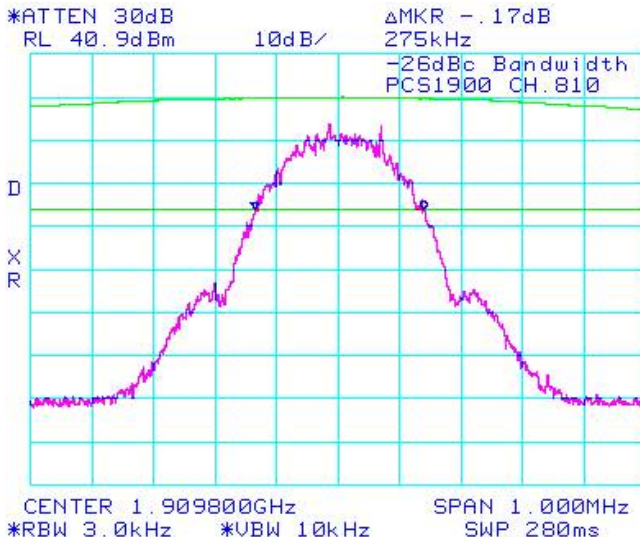
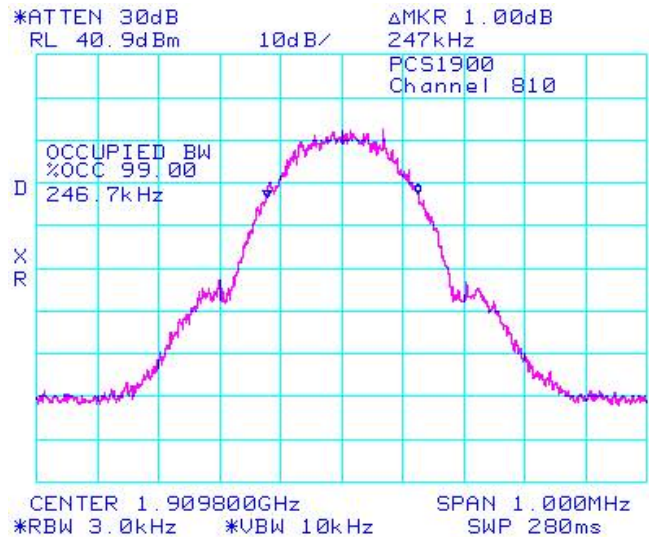

Figure 1-24a: Occupied Bandwidth, PCS1900 High Channel in GSM mode



GSM Conducted RF Emission Test Data cont'd

Figure 1-25a: GSM850 band, Low Channel Mask in GSM mode

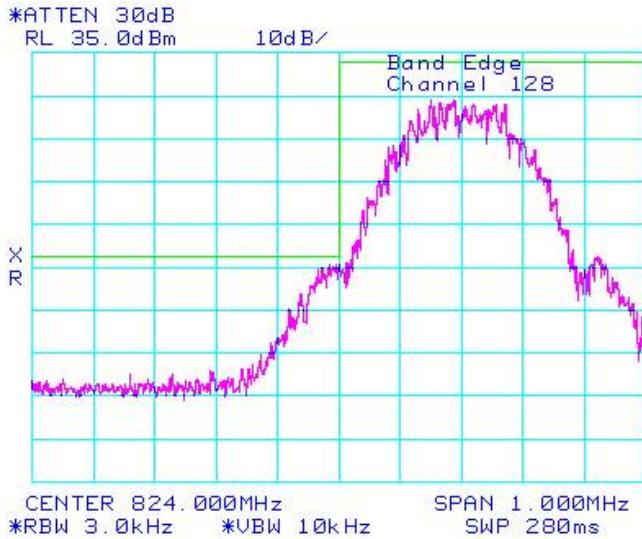

Figure 1-26a: GSM850 band High Channel Mask in GSM mode

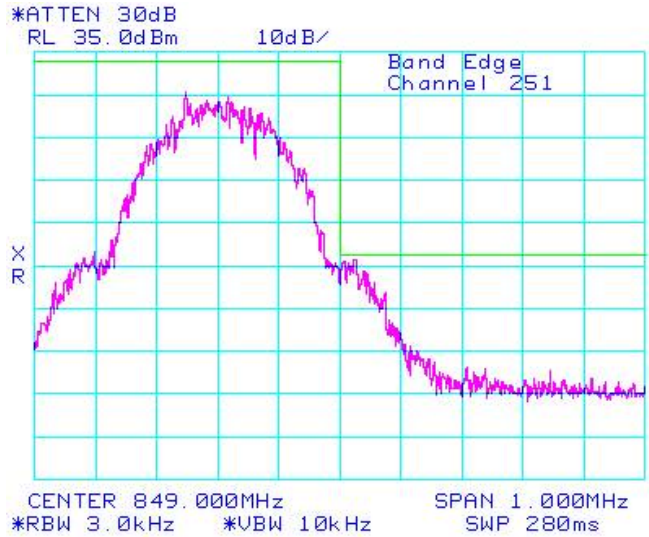

Figure 1-27a: PCS1900, Low Channel Mask in GSM mode

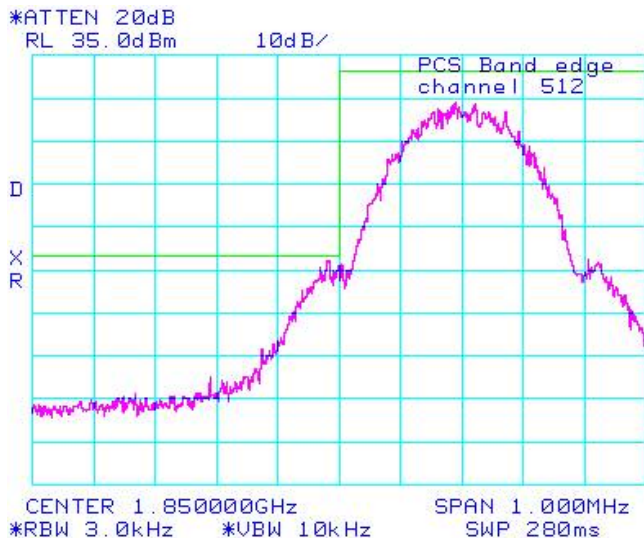
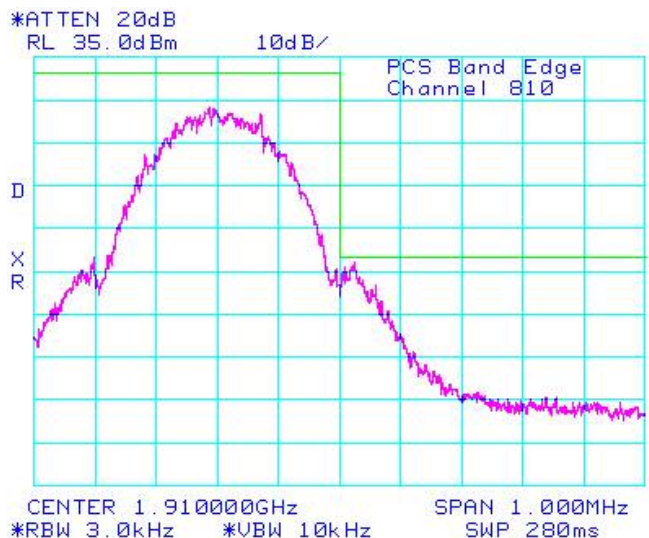

Figure 1-28a: PCS1900, High Channel Mask in GSM mode



GSM Conducted RF Emission Test Data cont'd

Figure 1-29a: Occupied Bandwidth, GSM850 Band, Low Channel in EDGE mode

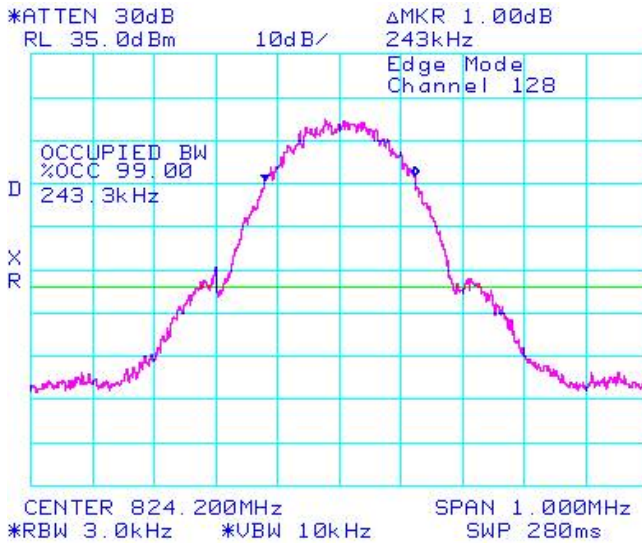

Figure 1-30a: Occupied Bandwidth, GSM850 Band, Middle Channel in EDGE mode

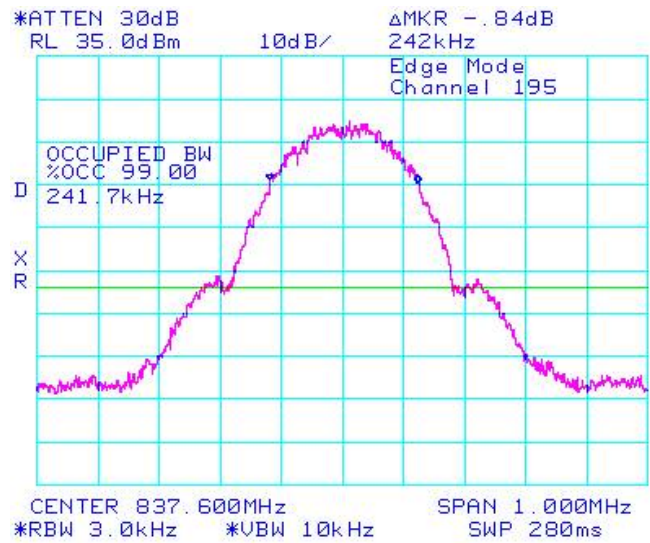

Figure 1-31a: Occupied Bandwidth, GSM850 band, High Channel in EDGE mode

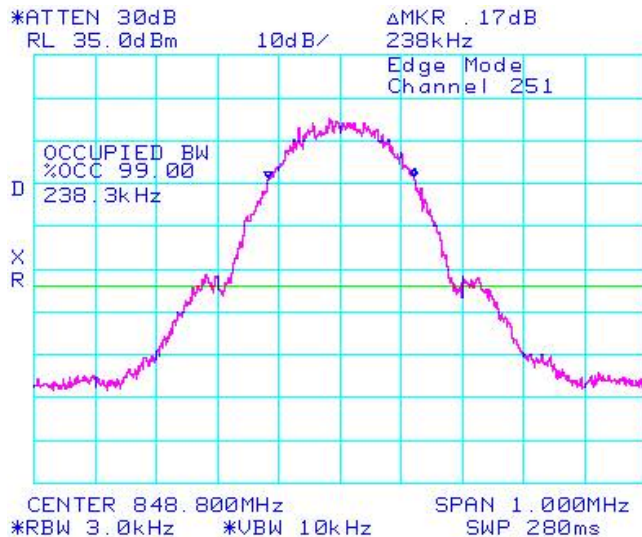
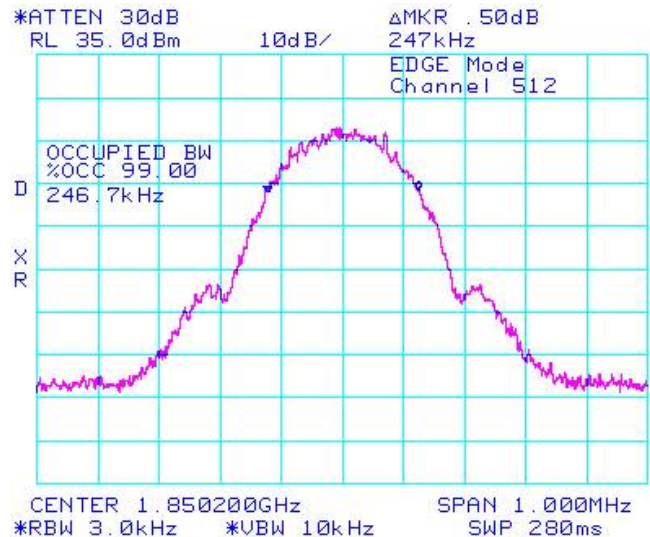

Figure 1-32a: Occupied Bandwidth, PCS1900 Band, Low Channel in EDGE mode



GSM Conducted RF Emission Test Data cont'd

Figure 1-33a: Occupied Bandwidth, PCS1900 Band, Middle Channel in EDGE mode

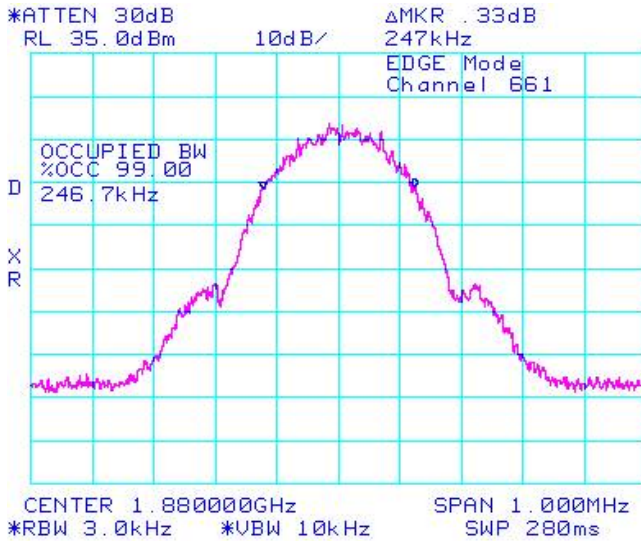

Figure 1-34a: Occupied Bandwidth, PCS1900 Band, High Channel in EDGE mode

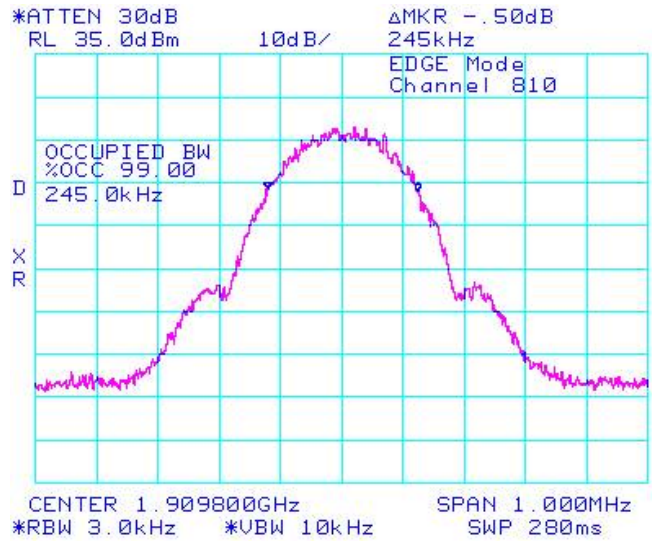

Figure 1-35a: GSM850 Band, Low Channel Mask in EDGE mode

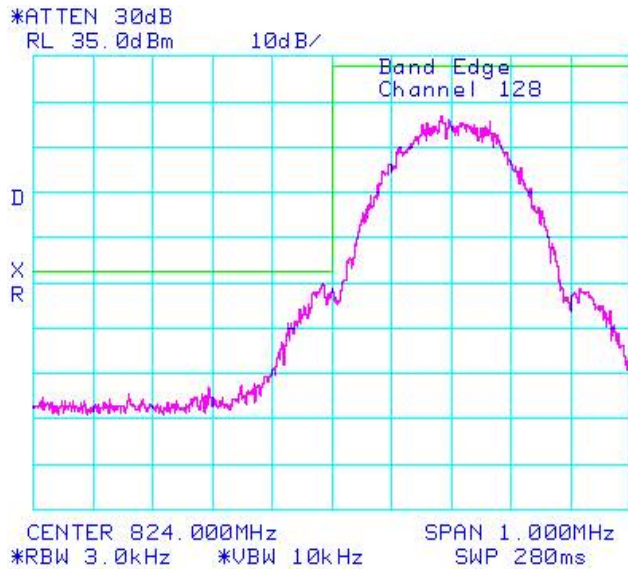
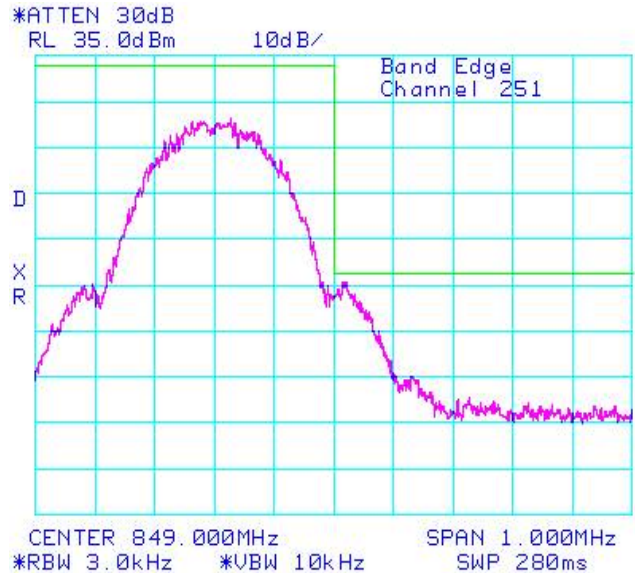

Figure 1-36a: GSM850 Band, High Channel Mask in EDGE mode



GSM Conducted RF Emission Test Data cont'd

Figure 1-37a: PCS1900 Band, Low Channel Mask in EDGE mode

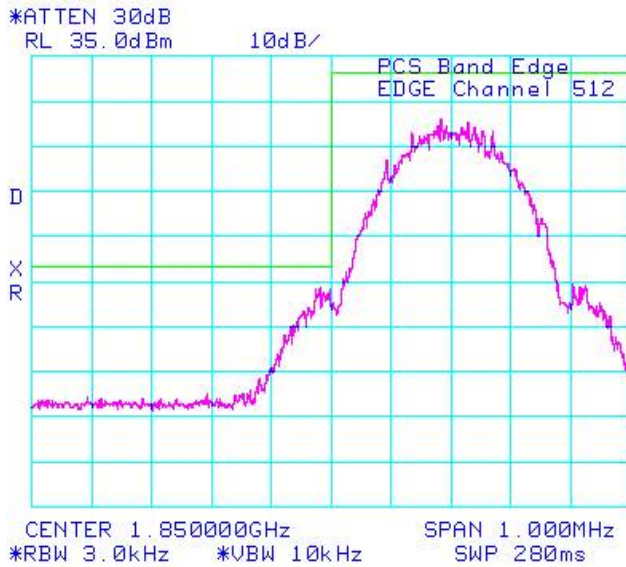
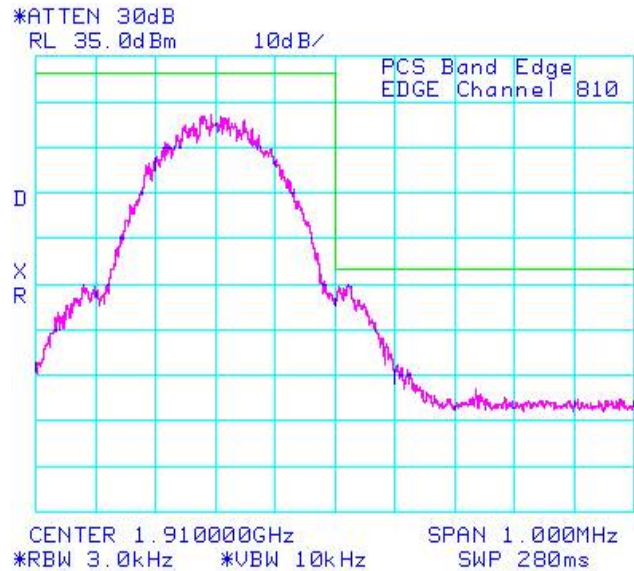



Figure 1-38a: PCS1900 Band, High Channel Mask in EDGE mode



APPENDIX 1B – CDMA CONDUCTED RF EMISSIONS TEST DATA/PLOTS

	EMI Test Report for the BlackBerry® smartphone Model RCK71CW	
	APPENDIX 1B	
Test Report No. RTS-1765-0907-21	Dates of Test July 23 to August 24, 2009	Author Data Michael Cino

CDMA Conducted RF Emission Test Data

This appendix contains measurement data pertaining to conducted spurious emissions, 99% power bandwidth and the channel mask on BlackBerry® smartphone PIN 30C43837.

Test Setup Diagram

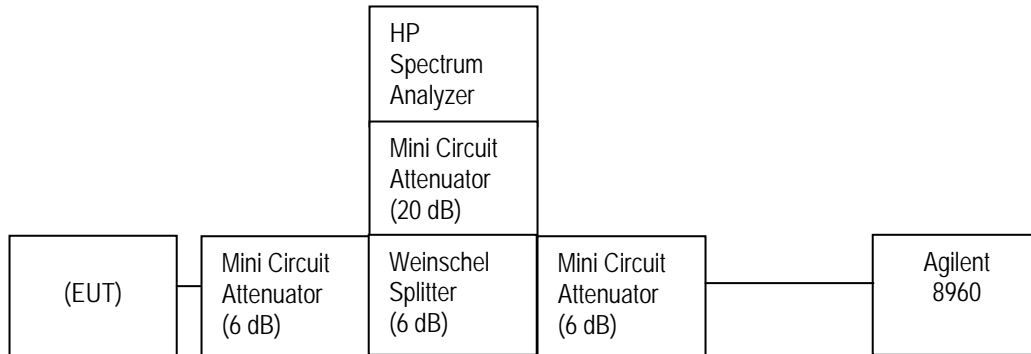

The environmental test conditions were: Temperature: 22 – 24 °C
 Pressure: 1014 – 1019 mb
 Relative Humidity: 31 – 32 %

The following measurements were performed by Maurice Battler.

	EMI Test Report for the BlackBerry® smartphone Model RCK71CW	
	APPENDIX 1B	
Test Report No. RTS-1765-0907-21	Dates of Test July 23 to August 24, 2009	Author Data Michael Cino

CDMA Conducted RF Emission Test Data cont'd

The conducted spurious emissions – As per 47 CFR 2.1051, CFR 24.238(a), RSS-GEN 4.9, CFR 22 Subpart H and RSS-132 were measured from 10 MHz to 20 GHz. See figures 1-1b to 1-12b for the plots of the conducted spurious emissions.

Date of Test: August 06 - 07, 2009

Test Data for Cellular and PCS selected Frequencies in Loopback mode

Cellular Frequency (MHz)	99% Occupied Bandwidth (MHz)
824.700	1.287
836.520	1.287
848.310	1.287

PCS Frequency (MHz)	99% Occupied Bandwidth (MHz)
1851.200	1.287
1880.000	1.287
1908.750	1.287

Measurement Plots for Cellular and PCS in Loopback mode

Refer to the following measurement plots for more detail.

See Figures 1-13b to 1-18b for the plots of the 99% Occupied Bandwidth.

See Figures 1-19b to 1-24b for plots of the channel mask results.

The RF power output was at maximum for all the recorded measurements shown below.

Test Report No. RTS-1765-0907-21	Dates of Test July 23 to August 24, 2009	Author Data Michael Cino
-------------------------------------	---------------------------------------------	-----------------------------

CDMA Conducted RF Emission Test Data cont'd

Figure 7-1b: Cellular, Spurious Conducted Emissions, Low channel

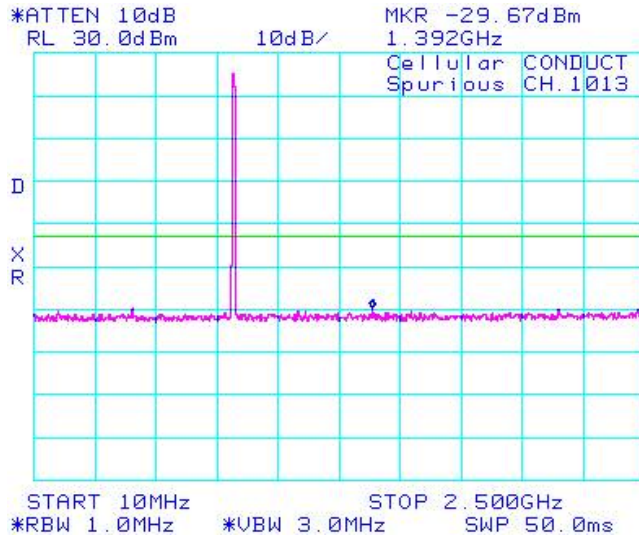

Figure 1-2b: Cellular, Spurious Conducted Emissions, Low channel

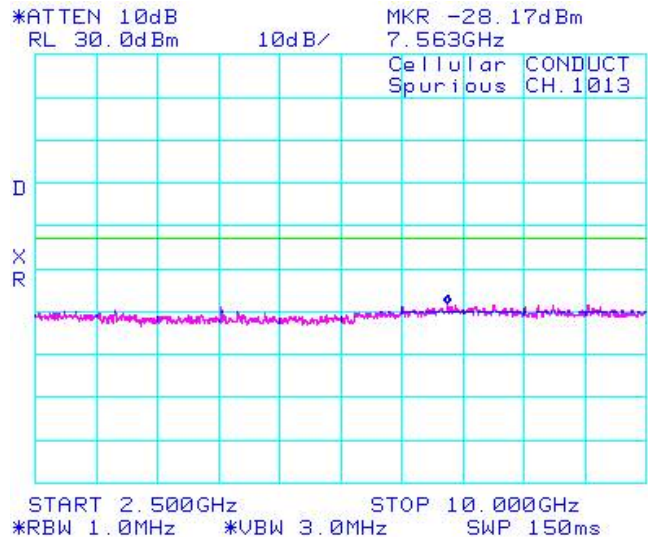

Figure 1-3b: Cellular, Spurious Conducted Emissions, Middle channel

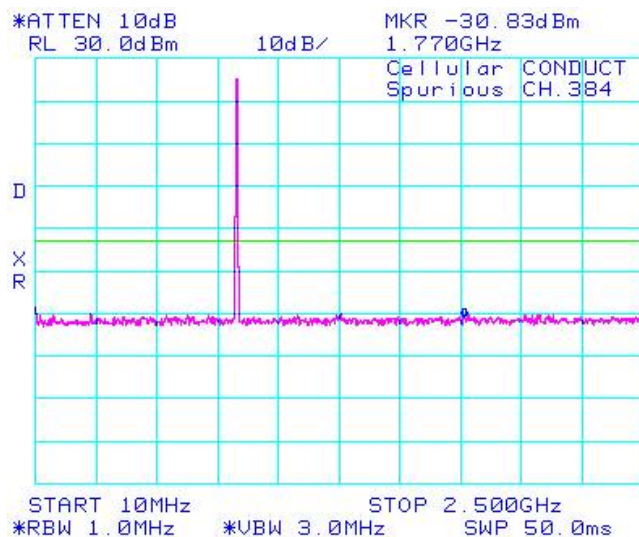
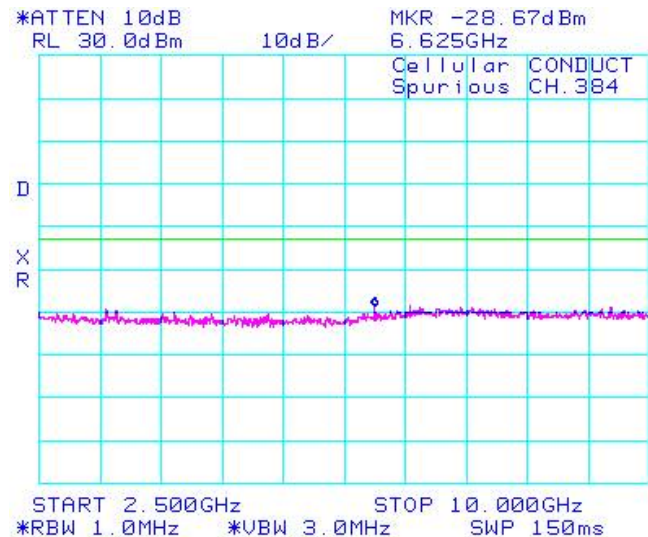

Figure 1-4b: Cellular, Spurious Conducted Emissions, Middle channel



Test Report No.
 RTS-1765-0907-21

Dates of Test
 July 23 to August 24, 2009

Author Data
 Michael Cino

CDMA Conducted RF Emission Test Data cont'd

Figure 8-5b: Cellular, Spurious Conducted Emissions, High Channel

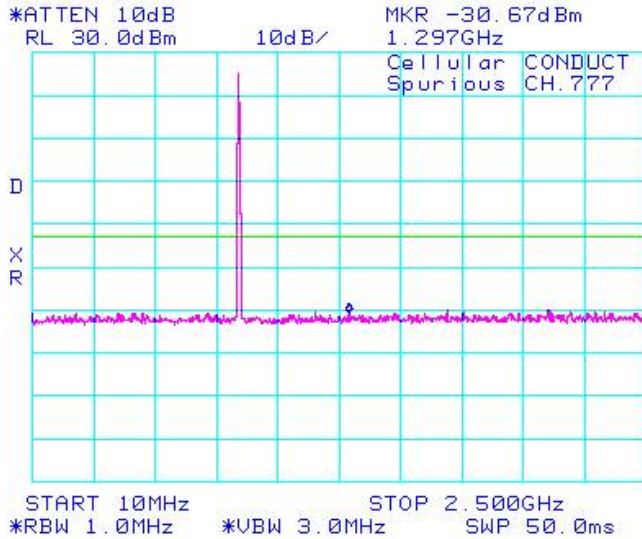

Figure 1-6b: Cellular, Spurious Conducted Emissions, High Channel

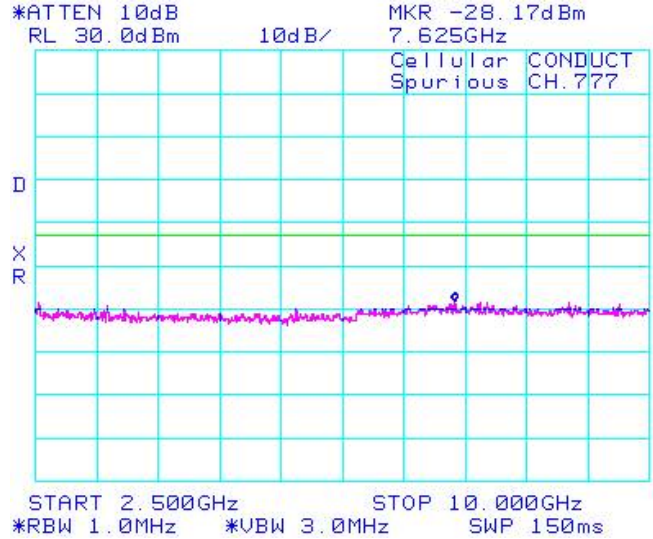

Figure 1-7b: PCS, Spurious Conducted Emissions, Low Channel

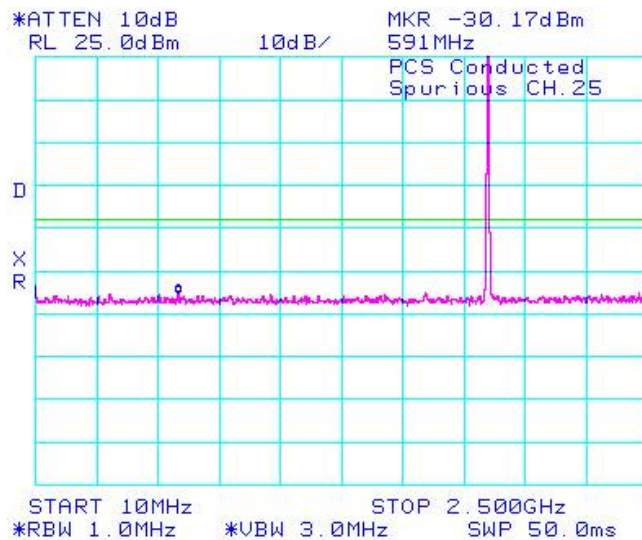
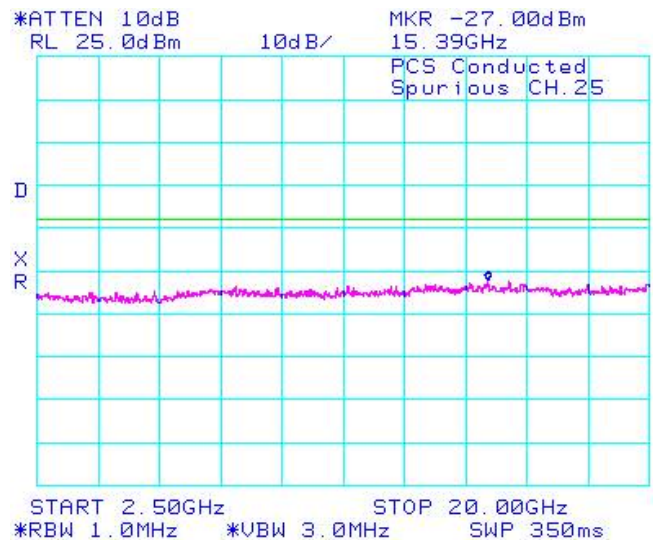

Figure 1-8b: PCS, Spurious Conducted Emissions, Low Channel



Test Report No.
 RTS-1765-0907-21

Dates of Test
 July 23 to August 24, 2009

Author Data
 Michael Cino

CDMA Conducted RF Emission Test Data cont'd

Figure 9-9b: PCS, Spurious Conducted Emissions, Middle Channel

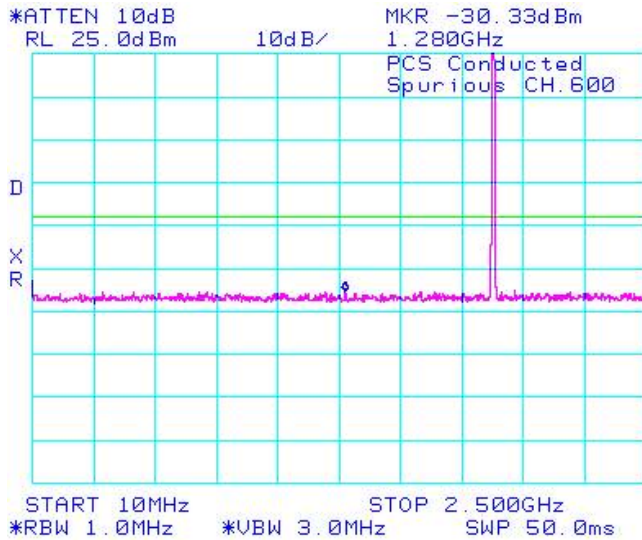

Figure 1-10b: PCS, Spurious Conducted Emissions, Middle Channel

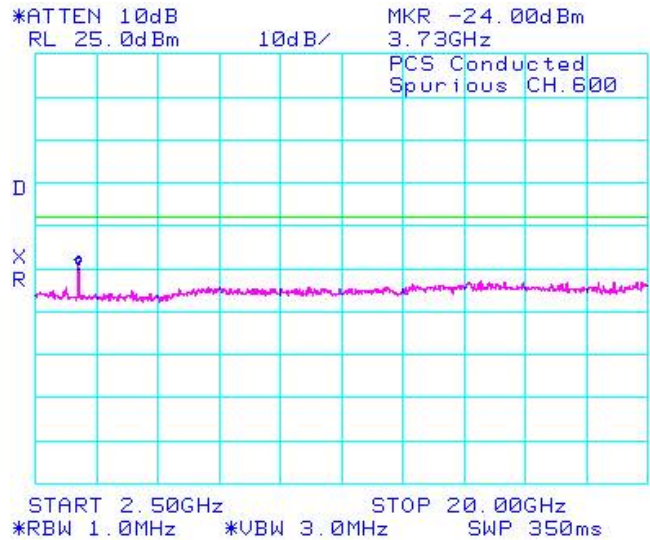

Figure 1-11b: PCS, Spurious Conducted Emissions, High Channel

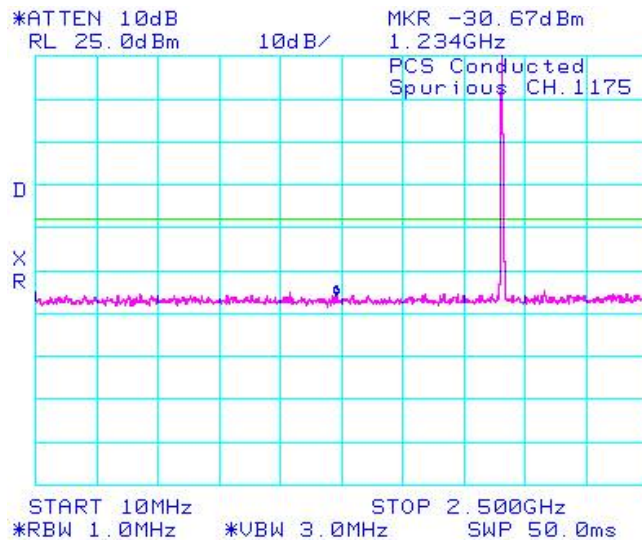
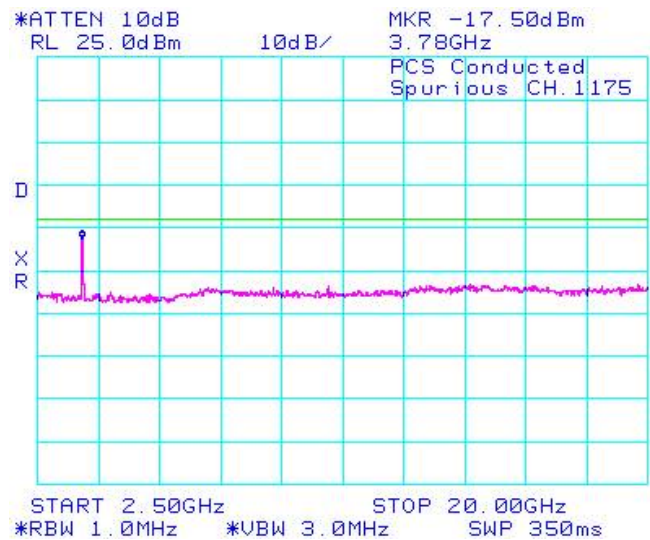

Figure 1-12b: PCS, Spurious Conducted Emissions, High Channel



Test Report No.
 RTS-1765-0907-21

Dates of Test
 July 23 to August 24, 2009

Author Data
 Michael Cino

CDMA Conducted RF Emission Test Data cont'd

Figure 1-13b: Occupied Bandwidth, Cellular Low Channel

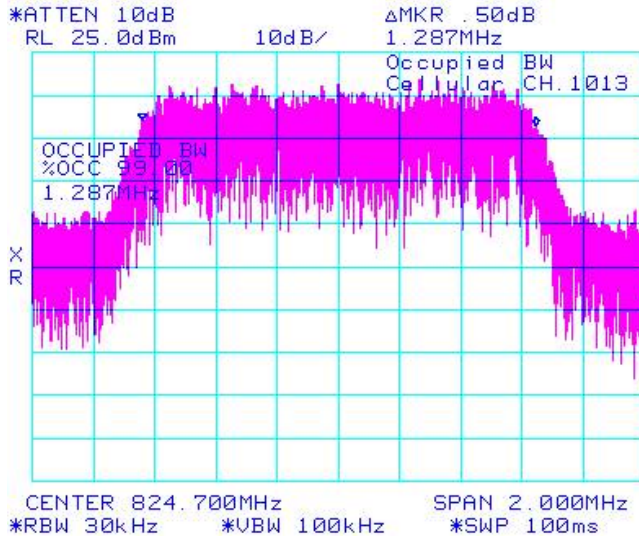

Figure 1-14b: Occupied Bandwidth, Cellular Middle Channel

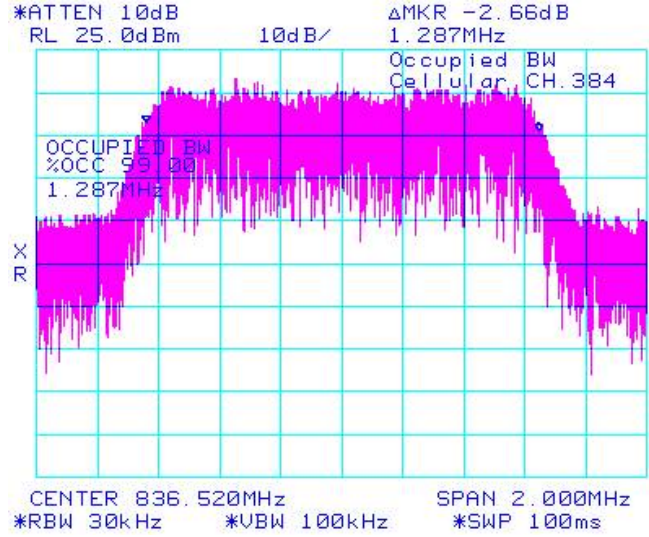

Figure 1-15b: Occupied Bandwidth, Cellular High Channel

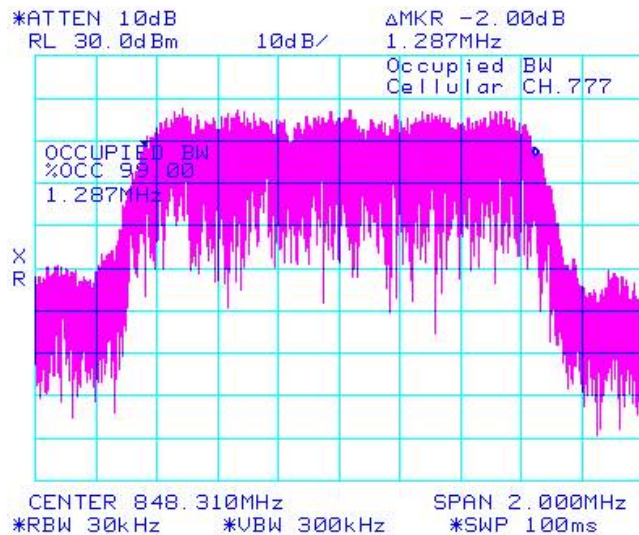
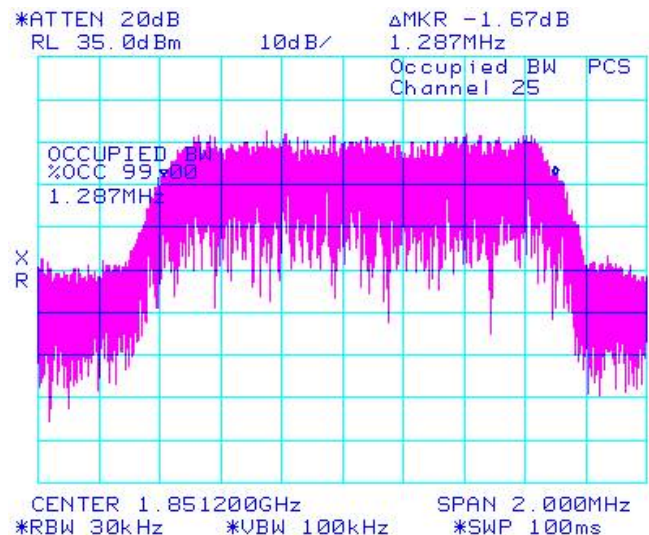



Figure 1-16b: Occupied Bandwidth, PCS Low Channel



	EMI Test Report for the BlackBerry® smartphone Model RCK71CW	
	APPENDIX 1B	
Test Report No. RTS-1765-0907-21	Dates of Test July 23 to August 24, 2009	Author Data Michael Cino

CDMA Conducted RF Emission Test Data cont'd

Figure 10-17b: Occupied Bandwidth, PCS Middle Channel

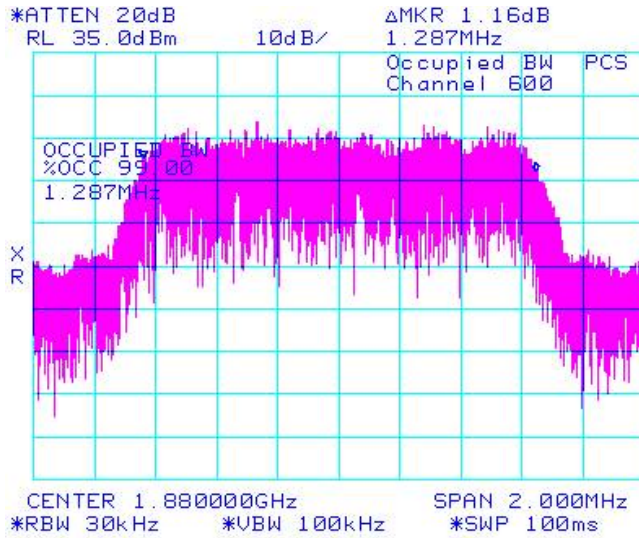

Figure 1-18b: Occupied Bandwidth, PCS High Channel

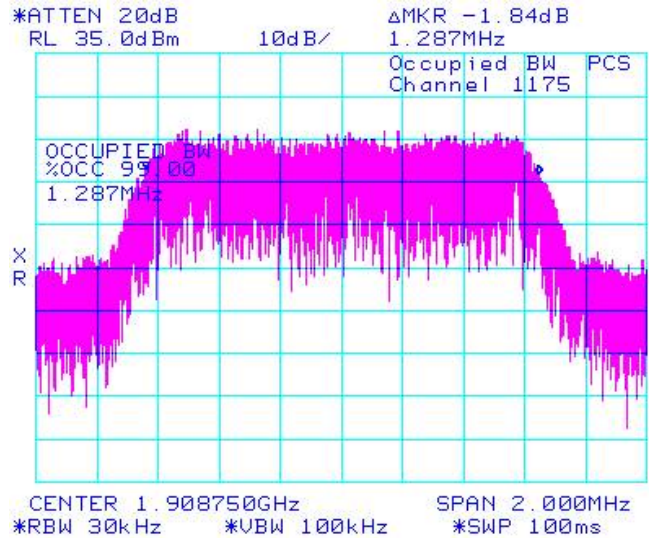

Figure 1-19b: Cellular Loopback, Low Channel Mask

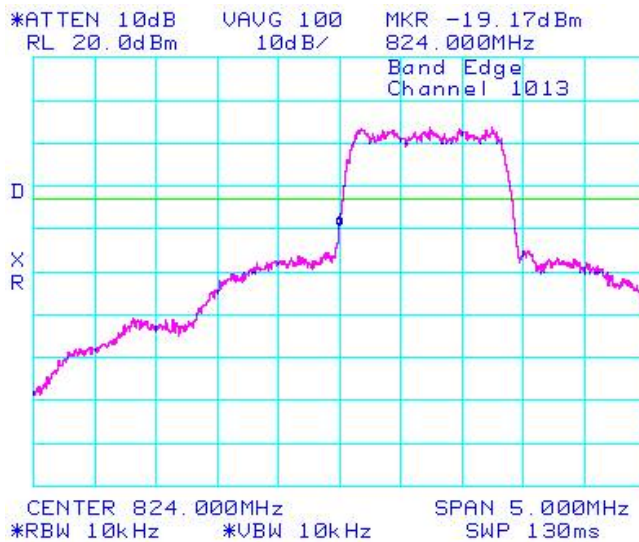
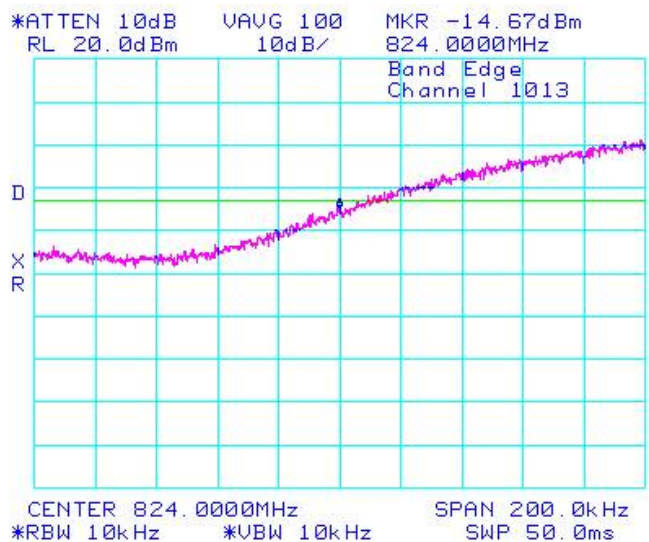

Figure 1-20b: Cellular Loopback, Low Channel Mask



Test Report No.
 RTS-1765-0907-21

Dates of Test
 July 23 to August 24, 2009

Author Data
 Michael Cino

CDMA Conducted RF Emission Test Data cont'd

Figure 11-21b: Cellular Loopback, High Channel Mask

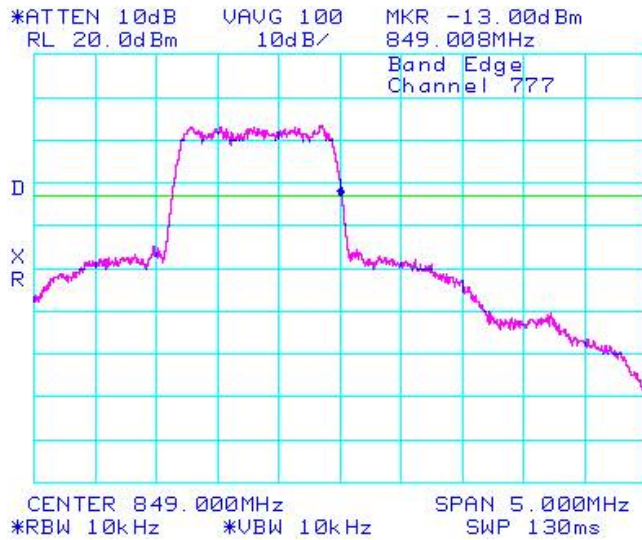

Figure 1-22b: Cellular Loopback, High Channel Mask

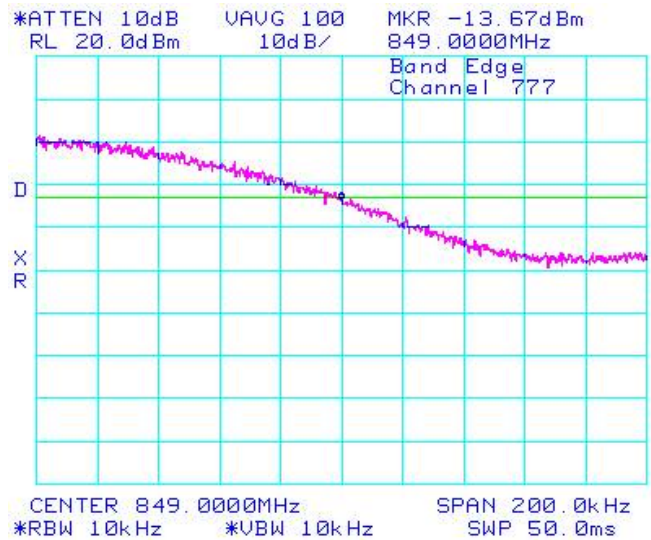

Figure 1-23b: PCS Loopback, Low Channel Mask

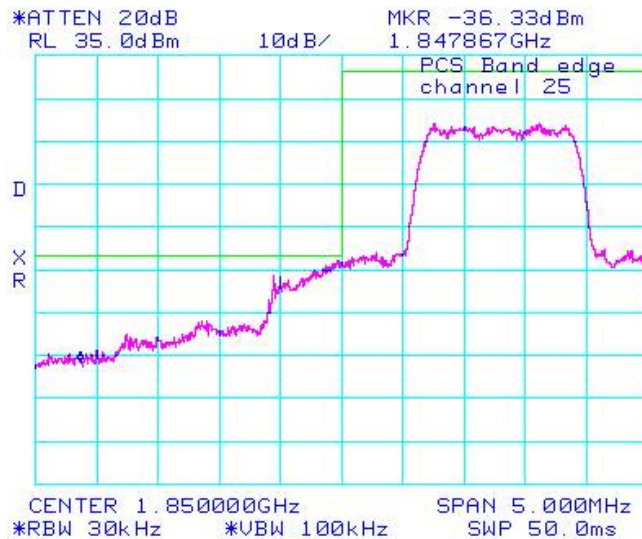
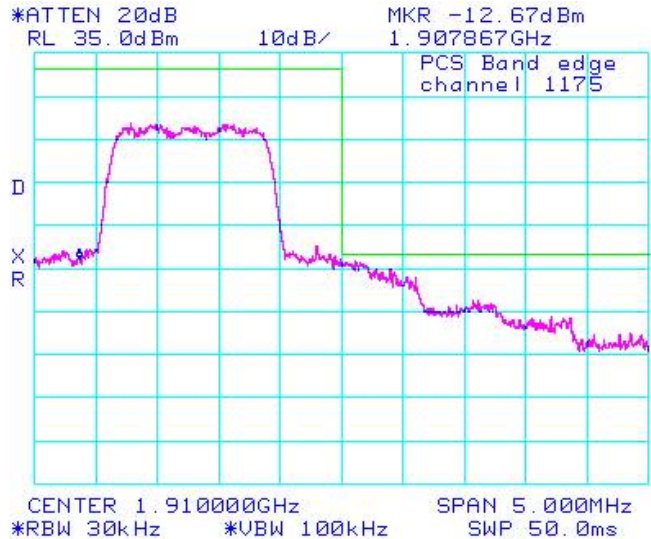



Figure 1-24b: PCS Loopback, High Channel Mask



	EMI Test Report for the BlackBerry® smartphone Model RCK71CW	
	APPENDIX 1B	
Test Report No. RTS-1765-0907-21	Dates of Test July 23 to August 24, 2009	Author Data Michael Cino

CDMA Conducted RF Emission Test Data cont'd

The conducted spurious emissions – As per 47 CFR 2.1051, CFR 24.238(a), RSS-GEN, 4.9, CFR 22 Subpart H and RSS-132 were measured from 10 MHz to 20 GHz. See figures 1-25b to 1-36b for the plots of the conducted spurious emissions. Date of Test: August 07, 2009

The environmental test conditions were: Temperature: 22 °C
Pressure: 1019 mb
Relative Humidity: 32 %

Test Data for Cellular and PCS selected Frequencies in 1xEVDO mode

Cellular Frequency (MHz)	99% Occupied Bandwidth (MHz)
824.700	1.287
836.520	1.287
848.310	1.293

PCS Frequency (MHz)	99% Occupied Bandwidth (MHz)
1851.200	1.293
1880.000	1.293
1908.750	1.300

Measurement Plots for Cellular and PCS in 1xEVDO mode

Refer to the following measurement plots for more detail.

See Figures 1-37b to 1-42b for the plots of the 99% Occupied Bandwidth.

See Figures 1-43b to 1-48b for plots of the channel mask results.

The RF power output was at maximum for all the recorded measurements shown below.

Test Report No.
 RTS-1765-0907-21

Dates of Test
 July 23 to August 24, 2009

Author Data
 Michael Cino

CDMA Conducted RF Emission Test Data cont'd

Figure 1-25b: Cellular, Spurious Conducted Emissions, Low channel

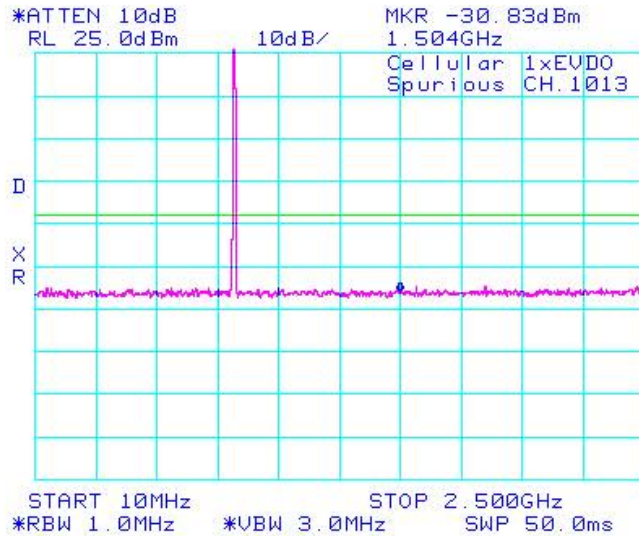

Figure 1-26b: Cellular, Spurious Conducted Emissions, Low channel

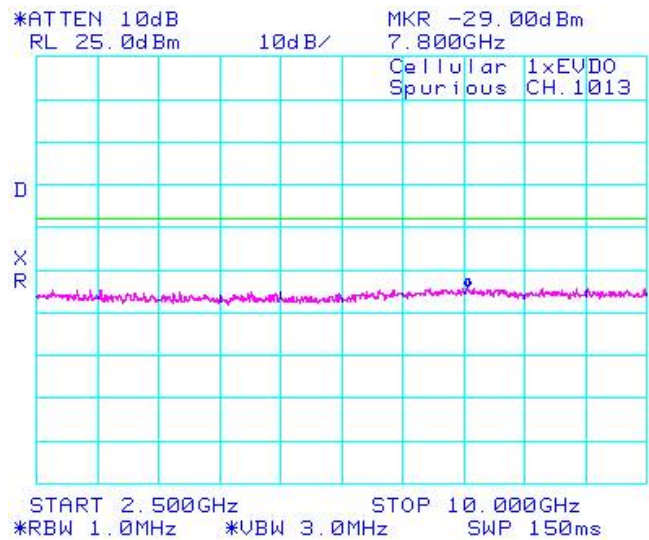

Figure 1-27b: Cellular, Spurious Conducted Emissions, Middle channel

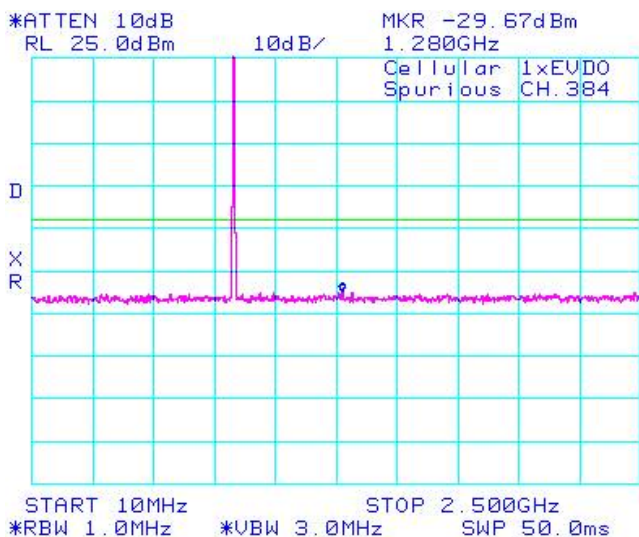
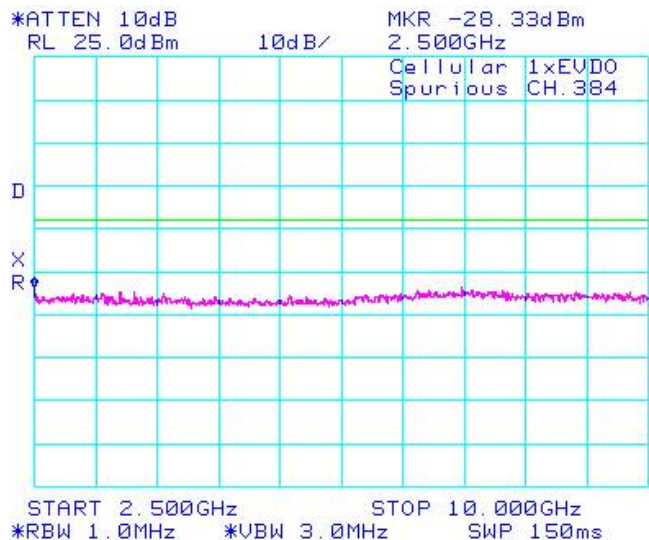

Figure 1-28b: Cellular, Spurious Conducted Emissions, Middle channel



Test Report No.
 RTS-1765-0907-21

Dates of Test
 July 23 to August 24, 2009

Author Data
 Michael Cino

CDMA Conducted RF Emission Test Data cont'd

Figure 12-29b: Cellular, Spurious Conducted Emissions, High Channel

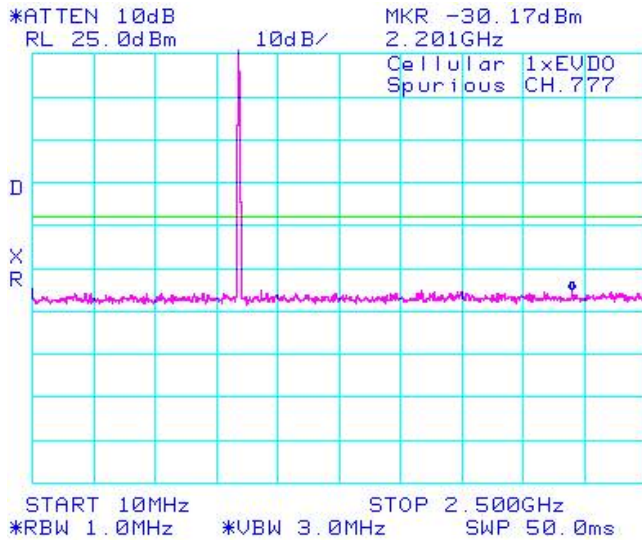

Figure 1-30b: Cellular, Spurious Conducted Emissions, High Channel

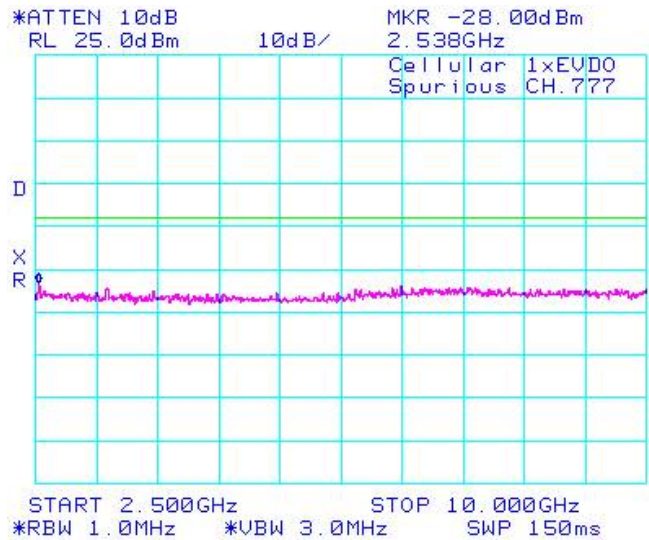

Figure 1-31b: PCS, Spurious Conducted Emissions, Low Channel

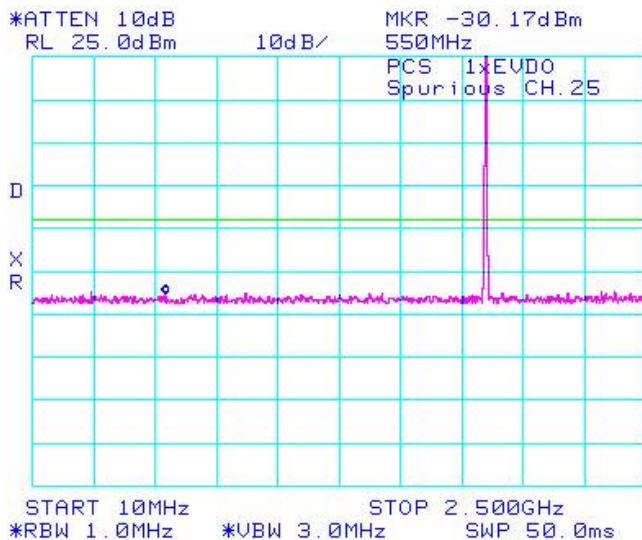
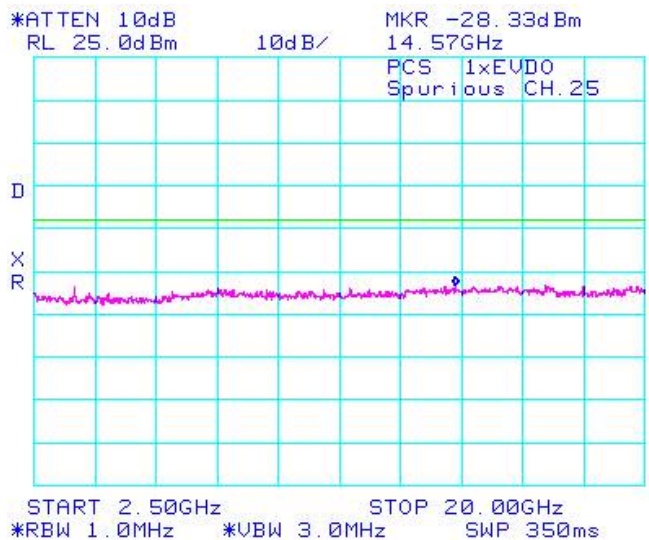

Figure 1-32b: PCS, Spurious Conducted Emissions, Low Channel



Test Report No.
 RTS-1765-0907-21

Dates of Test
 July 23 to August 24, 2009

Author Data
 Michael Cino

CDMA Conducted RF Emission Test Data cont'd

Figure 1-33b: PCS, Spurious Conducted Emissions, Middle Channel

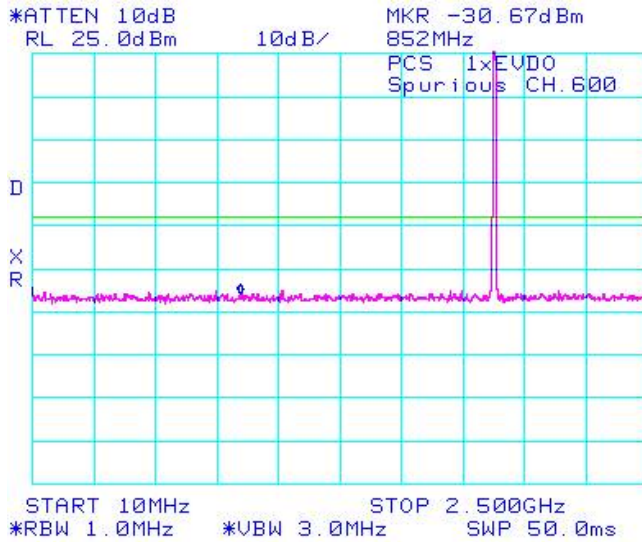

Figure 1-34b: PCS, Spurious Conducted Emissions, Middle Channel

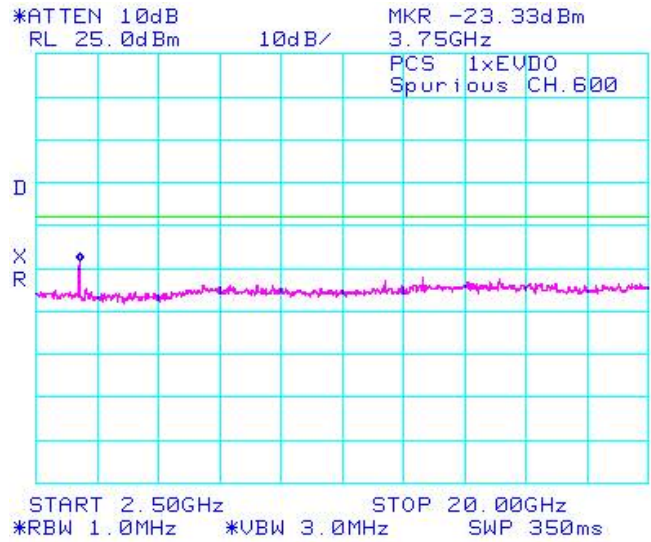

Figure 1-35b: PCS, Spurious Conducted Emissions, High Channel

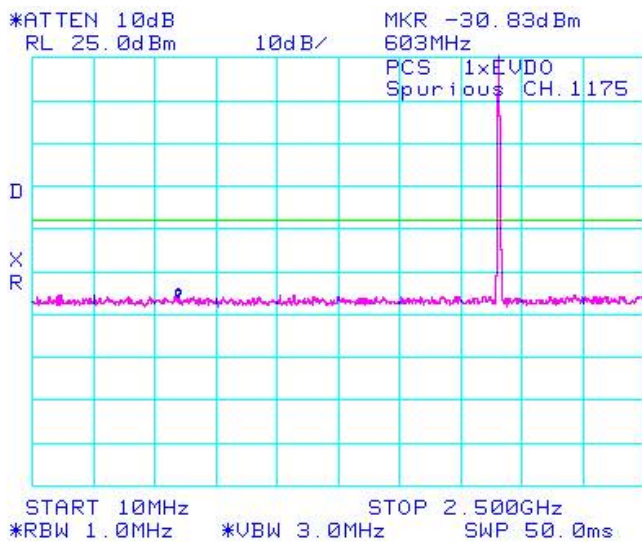
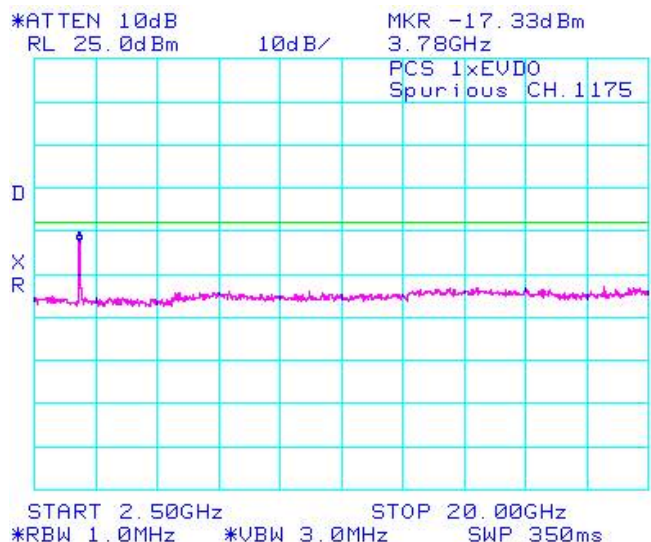

Figure 1-36b: PCS, Spurious Conducted Emissions, High Channel



Test Report No.
 RTS-1765-0907-21

Dates of Test
 July 23 to August 24, 2009

Author Data
 Michael Cino

CDMA Conducted RF Emission Test Data cont'd

Figure 1-37b: Occupied Bandwidth, Cellular Low Channel

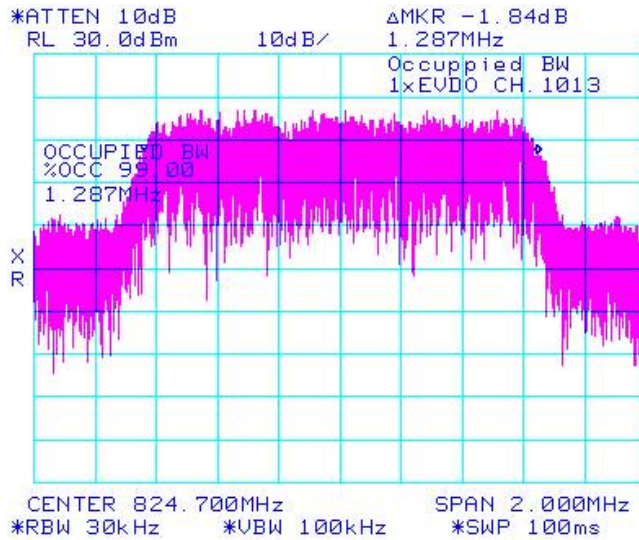

Figure 1-38b: Occupied Bandwidth, Cellular Middle Channel

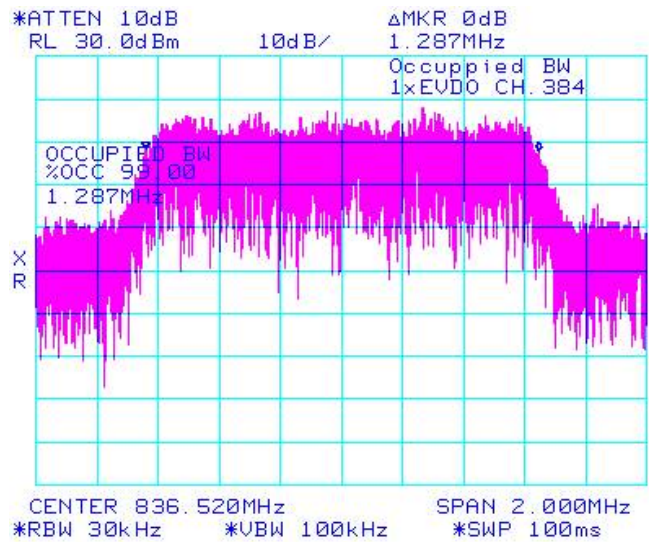

Figure 1-39b: Occupied Bandwidth, Cellular High Channel

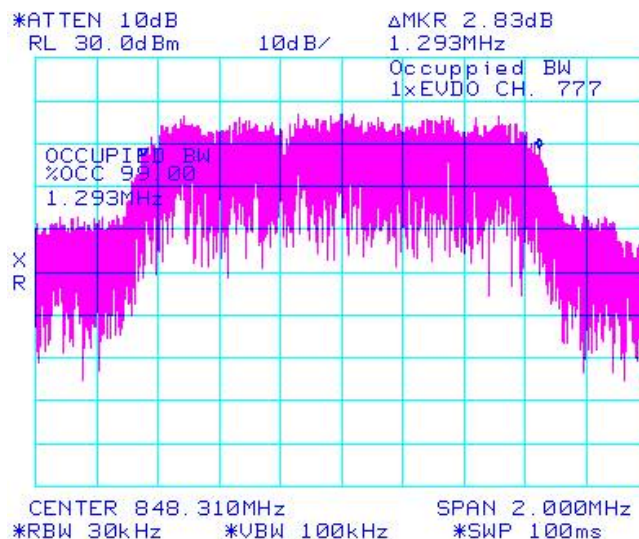
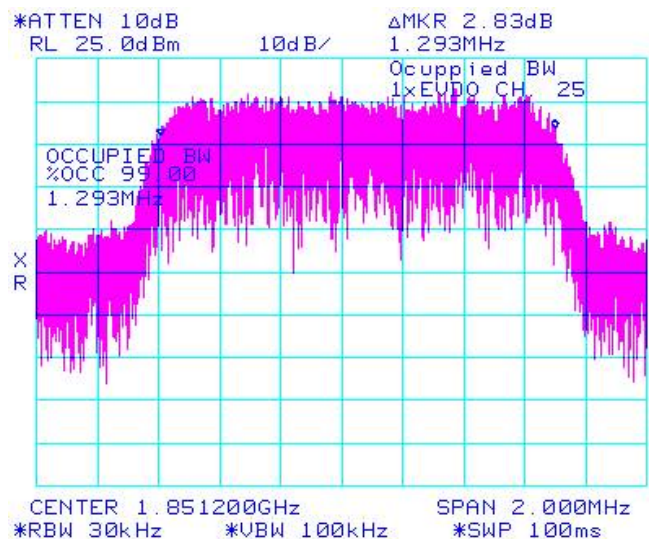

Figure 1-40b: Occupied Bandwidth, PCS Low Channel



Test Report No.
 RTS-1765-0907-21

Dates of Test
 July 23 to August 24, 2009

Author Data
 Michael Cino

CDMA Conducted RF Emission Test Data cont'd

Figure 1-41b: Occupied Bandwidth, PCS Middle Channel

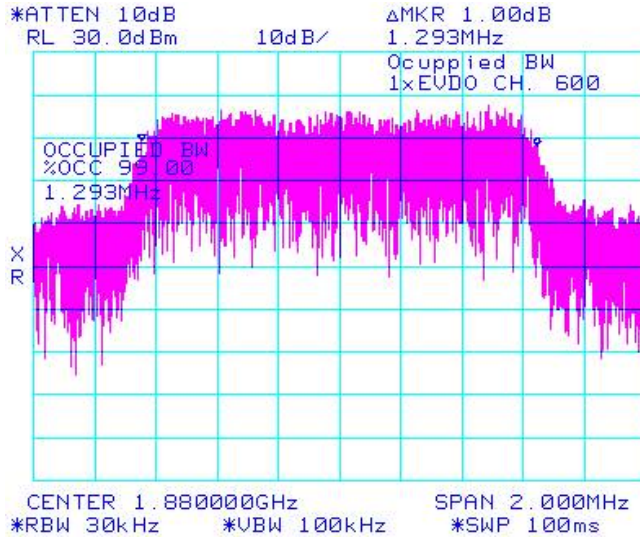

Figure 1-42b: Occupied Bandwidth, PCS High Channel

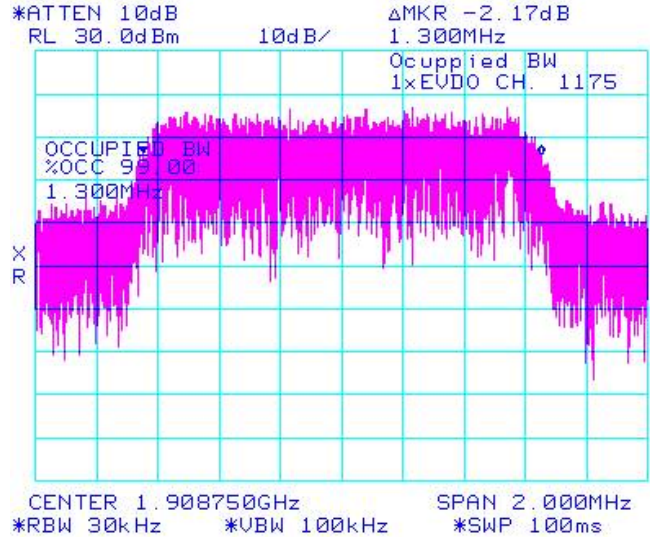

Figure 1-43b: Cellular CDMA2000, Low Channel Mask

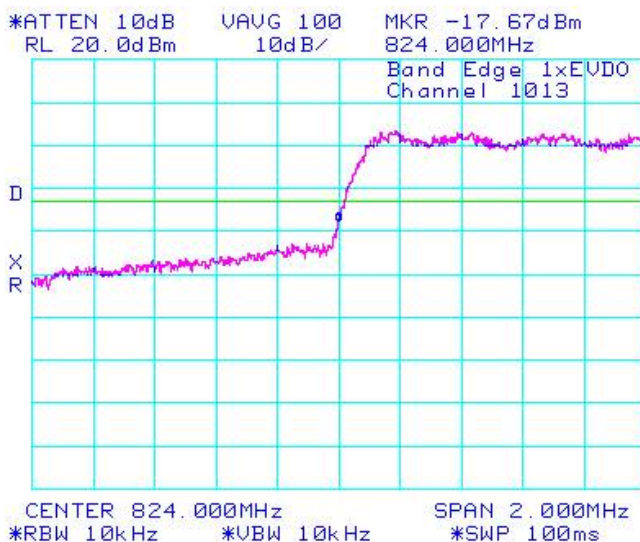
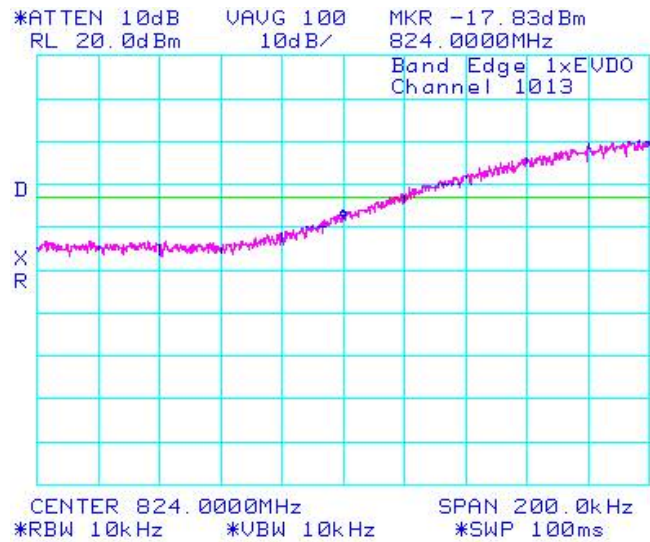

Figure 1-44b: Cellular CDMA2000, Low Channel Mask



Test Report No.
 RTS-1765-0907-21

Dates of Test
 July 23 to August 24, 2009

Author Data
 Michael Cino

CDMA Conducted RF Emission Test Data cont'd

Figure 1-45b: Cellular CDMA2000, High Channel Mask

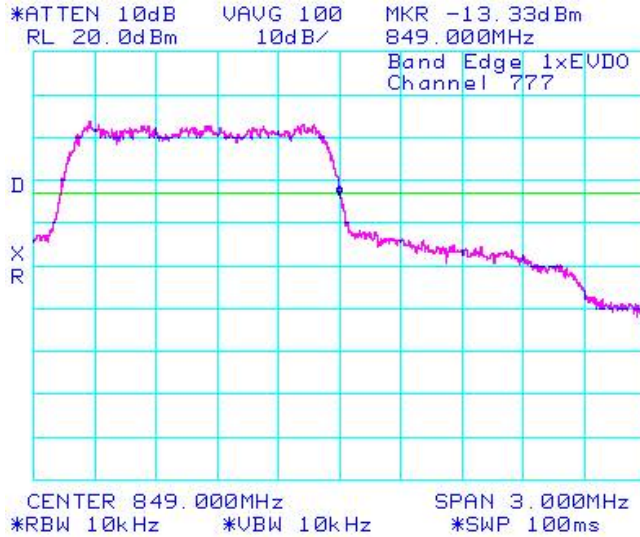

Figure 1-46b: Cellular CDMA2000, High Channel Mask

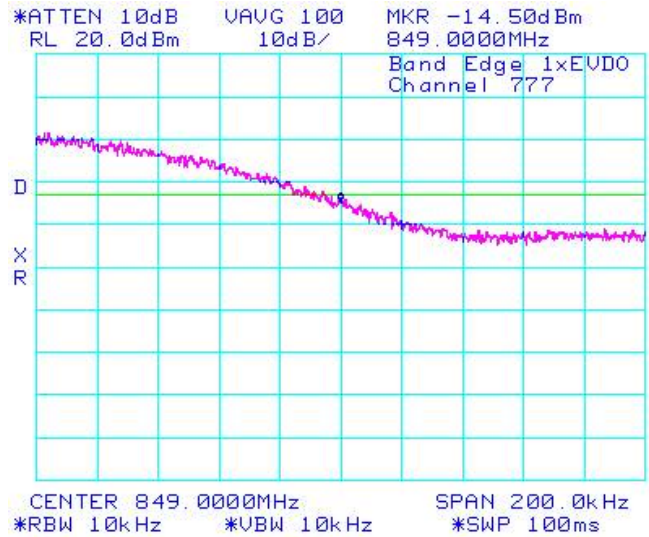

Figure 1-47b: PCS, Low Channel Mask

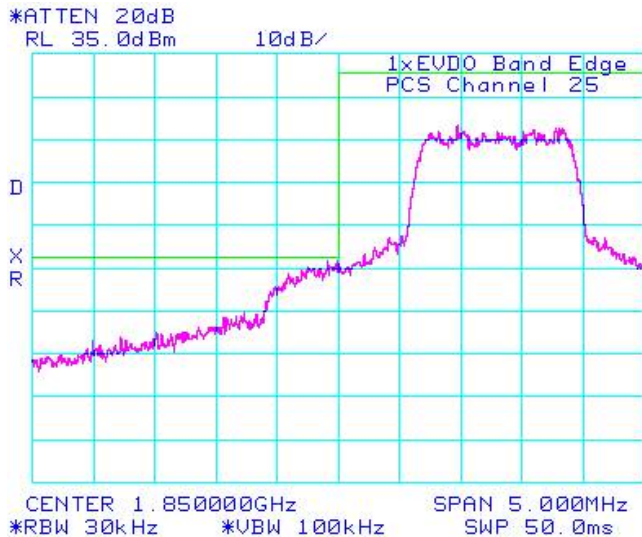
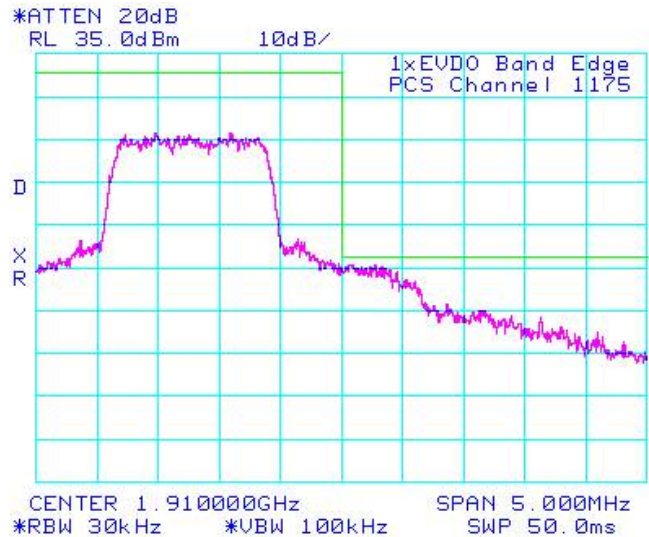

Figure 1-48b: PCS, High Channel Mask



APPENDIX 2A – GSM CONDUCTED RF OUTPUT POWER TEST DATA

Test Report No. RTS-1765-0907-21	Dates of Test July 23 to August 24, 2009	Author Data Michael Cino
-------------------------------------	---------------------------------------------	-----------------------------

GSM Conducted RF Output Power Test Data

The following measurements were performed by J.P. Hacquoil

The conducted RF output power was measured on the BlackBerry® smartphone PIN 30C1C104 using the Communication Tester, Rohde & Schwarz, model CMU 200. The low, middle and high channels were measured at maximum radio output power. The insertion loss of the coaxial cable from the CMU 200 to the BlackBerry® smartphone was compensated for in the measurements.

Peak nominal output power is 32.5 dBm ±0.5 dB for GSM850 and 30 dBm ±0.5 dB for PCS. Peak nominal output power is 26.0 dBm ±0.5 dB for GSM850 EDGE Mode (4-timeslot uplink) and 24.5 dBm ±0.5 dB for PCS EDGE Mode (4-timeslot uplink).

Date of Test: August 06, 2009

Channel	Frequency (MHz)	Maximum Output Power (dBm)	Maximum Output Power (Watts)	Channel	Frequency (MHz)	Maximum Output Power (dBm)	Maximum Output Power (Watts)
<u>GSM850</u>				<u>GSM850 EDGE/GPRS/GSM (4-timeslot)</u>			
128	824.20	32.8	1.91	128	824.20	26.2	0.42
189	837.60	32.8	1.91	189	837.60	26.2	0.42
251	848.80	32.8	1.91	251	848.80	26.1	0.41
<u>PCS</u>				<u>PCS EDGE/GPRS/GSM (4-timeslot)</u>			
512	1850.2	30.0	1.00	512	1850.2	24.5	0.28
661	1880.0	30.1	1.02	661	1880.0	24.6	0.29
810	1909.8	30.4	1.10	810	1909.8	24.6	0.29

APPENDIX 2B – CDMA CONDUCTED RF OUTPUT POWER TEST DATA

Test Report No. RTS-1765-0907-21	Dates of Test July 23 to August 24, 2009	Author Data Michael Cino
-------------------------------------	---------------------------------------------	-----------------------------

CDMA Conducted RF Output Power Test Data

The following measurements were performed by Maurice Battler.

The conducted RF output power was measured on the BlackBerry® smartphone PIN 30C1C104 using the CDMA base station simulator. Low, middle and high channels were measured at maximum radio output power at different service options and modes. Peak nominal output power is 24.50 dBm ±0.5 dB for Cellular and 23.50 dBm ±0.5 dB for PCS.

Date of Test: August 06, 2009

Test Results

Band	Channel	1x EvDO (153.6kbps)		CDMA2000 RC	SO2 Loopback		SO55 Loopback		TDSO SO32	
		(dBm)	(Watts)		(dBm)	(Watts)	(dBm)	(Watts)	(dBm)	(Watts)
CDMA 800	1013	24.1	0.26	RC1	24.2	0.263	24.2	0.263	-	-
				RC3	24.1	0.257	24.1	0.257	24.1	0.257
	384	24.3	0.27	RC1	24.2	0.263	24.3	0.269	-	-
				RC3	24.1	0.257	24.1	0.257	24.0	0.251
	777	24.1	0.26	RC1	24.2	0.263	24.2	0.263	-	-
				RC3	24.0	0.251	23.9	0.245	24.0	0.251
Band	Channel	1x EvDO (153.6kbps)		CDMA2000 RC	SO2 Loopback		SO55 Loopback		TDSO SO32	
		(dBm)	(Watts)		(dBm)	(Watts)	(dBm)	(Watts)	(dBm)	(Watts)
CDMA 1900	25	23.0	0.20	RC1	23.5	0.224	23.2	0.209	-	-
				RC3	23.3	0.214	23.2	0.209	23.2	0.209
	600	23.7	0.27	RC1	23.6	0.229	23.3	0.214	-	-
				RC3	23.4	0.219	23.2	0.209	23.4	0.219
	1175	23.7	0.26	RC1	23.7	0.234	23.6	0.229	-	-
				RC3	24	0.251	23.6	0.229	23.5	0.224

APPENDIX 3A – GSM FREQUENCY STABILITY TEST DATA

	EMI Test Report for the BlackBerry® smartphone Model RCK71CW	
	APPENDIX 3A	
Test Report No. RTS-1765-0907-21	Dates of Test July 23 to August 24, 2009	Author Data Michael Cino

GSM Frequency Stability Test Data

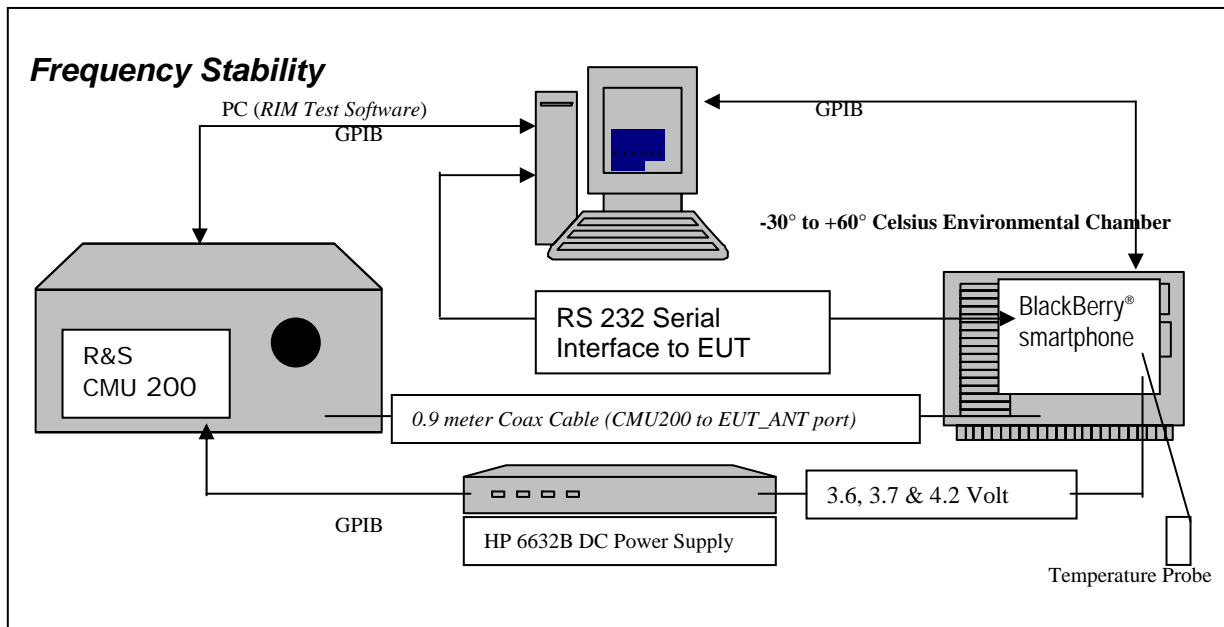

The following measurements were performed by Maurice Battler.

CFR 47 Chapter 1 - Federal Communications Commission Rules

Part 2 Required Measurements

- 2.995 Frequency Stability - Procedures
- (a,b) Frequency Stability - Temperature Variation
- (d) Frequency Stability - Voltage Variation

24.235 *Frequency Stability.*

The frequency stability shall be sufficient to ensure that the fundamental emission stays within the authorized frequency block.

The EUT meets the requirements as stated in CFR 47 chapter 1, Section 24.235, CFR 47 chapter 1, Section 22.917 and RSS-132, 4.3 Frequency Stability.

Frequency Stability measurement devices were configured as presented in the block diagram recording frequency, power, data, temperatures, and stepped voltages controlled via a GPIB interface linked to the Environmental chamber, a DC power supply, and the Communications Test Set. A 0.9-metre coax cable was calibrated to characterize the insertion loss for the transmitted frequencies between the RF input/output of the CMU 200 and the EUT antenna port.

Calibration for the Cable Loss was performed in the RF Laboratory using the Agilent power meter and Agilent Signal Generator.
The cable assembly from the RF input to the RF output was measured at the following Frequencies:

Test Report No. RTS-1765-0907-21	Dates of Test July 23 to August 24, 2009	Author Data Michael Cino
-------------------------------------	---------------------------------------------	-----------------------------

PCS1900 Frequency (MHz)	Cable loss (dB)
1850.2	1.20
1880.0	1.20
1909.8	1.20

GSM850 Frequency (MHz)	Cable loss (dB)
824.2	0.90
836.4	0.90
848.6	0.90

Procedure:

The EUT was placed in the Temperature chamber and connected to CMU 200 outside as shown in the figure above. Dry air was pumped inside the temperature chamber to maintain a backpressure during the test. The EUT was kept in the off condition at all times except when the following measurements were to be made.

The chamber was switched on and the temperature was set to -30°C. After the chamber stabilized at -30 °C there was a soak period of one hour to alleviate moisture in the chamber, the EUT voltage was enabled. The system software recorded the frequency, power, and associated measurements.

A Computer system controlled the automated software. This application was given the command of activating all machines intrinsic to the temperature and voltage tests controlling the CMU 200 via the GPIB Bus. The Environmental Chamber was instructed through an RS-232 serial line. The EUT dialogue was passed through a serial connection.

The EUT repetitively transmitted 100 bursts for each set of programmed parameters recording temperature, voltage settings, and systematically selected frequencies. The power supply was cycled from minimum voltage 3.6 volts, to 3.7 volts to 4.2 volts maximum voltage. The frequency error was measured at a maximum output power and recorded by the automated system test software.

The EUT output power and frequency was measured at 3.6 volts, 3.7 volts and 4.2 volts. The transmit frequency was varied in 3 steps consisting of 824.2, 836.4, and 848.6 MHz for the GSM850 band, 1850.2, 1880.0 and 1909.8 MHz for the PCS1900 band. This frequency was recorded in MHz and deviation from nominal, in Parts Per Million. After the initial one-hour soak at the beginning of the tests, a period of thirty minutes soak was initialized between each ascending temperature step, before proceeding to the next measurement test cycle.

	EMI Test Report for the BlackBerry® smartphone Model RCK71CW	
	APPENDIX 3A	
Test Report No. RTS-1765-0907-21	Dates of Test July 23 to August 24, 2009	Author Data Michael Cino

PROCEDURE:

The test system software for commencing the Frequency Stability Tests carried through the following cycle.

1. Switch on the HP 6632B power supply; CMU 200 Communications test Set, and Environmental Chamber.
2. Start test program
3. Set the Temperature to -30°C and maintain a period of one- hour soak time, with the EUT supply voltage disabled.
4. Set power supply voltage to 3.6 volts.
5. Set up CMU 200 Radio Communication Tester.
6. Command the CMU 200 to switch to the low channel.
7. Enable the voltage to the EUT, and connect a link to the CMU 200 test set.
8. EUT is commanded to Transmit 100 Bursts.
9. Software logs the following data from the CMU 200, power supply and temperature chamber: Traffic Channel Number, Traffic Channel Frequency, Power Level, Chamber Temperature, Supply Voltage, Power and Frequency Error.
10. The CMU 200 commands the EUT to change frequency to the middle channel and high channel and repeats steps 7 to 9.
11. Repeat steps 5 to 10 changing the supply voltage to 3.7 Volts
12. Increase temperature by 10°C and soak for 1/2 hour.
13. Repeat steps 4 - 12 for temperatures -30°C to 60°C .
14. Repeat steps 5 to 10 changing the supply voltage to 4.2 volts

Procedure 5 to 10 was repeated at room temperature (20°C) with the power supply voltage set to 3.6, 3.7 and 4.2 volts.

The maximum frequency error in the GSM850 band measured was **-0.0665 PPM**.
The maximum frequency error in the PCS1900 band measured was **-0.0528 PPM**.

Test Report No. RTS-1765-0907-21	Dates of Test July 23 to August 24, 2009	Author Data Michael Cino
-------------------------------------	---------------------------------------------	-----------------------------

GSM850 Channel results: channels 128, 189 and 250 @ 20°C maximum transmitted power

The BlackBerry® smartphone PIN 30C43837 was tested on August 05, 2009.

Traffic Channel Number	GSM850 Frequency (MHz)	Voltage (Volts)	Temperature (Celsius)	Frequency Error (Hz)	PPM
128	824.20	3.6	20	-41.65	-0.0505
189	836.40	3.6	20	-43.33	-0.0518
250	848.60	3.6	20	-43.78	-0.0516

Traffic Channel Number	GSM850 Frequency (MHz)	Voltage (Volts)	Temperature (Celsius)	Frequency Error (Hz)	PPM
128	824.20	3.7	20	-39.97	-0.0485
189	836.40	3.7	20	-40.62	-0.0486
250	848.60	3.7	20	-35.97	-0.0424

Traffic Channel Number	GSM850 Frequency (MHz)	Voltage (Volts)	Temperature (Celsius)	Frequency Error (Hz)	PPM
128	824.20	4.2	20	-41.91	-0.0508
189	836.40	4.2	20	-41.33	-0.0494
250	848.60	4.2	20	-39.84	-0.0469

Test Report No.
 RTS-1765-0907-21

Dates of Test
 July 23 to August 24, 2009

Author Data
 Michael Cino

GSM850 Results: channel 128 @ maximum transmitted power

Traffic Channel Number	Frequency (MHz)	Voltage (Volts)	Temperature (Celsius)	Frequency Error (Hz)	PPM
128	824.20	3.6	-30	-37.26	-0.0452
128	824.20	3.6	-20	-36.87	-0.0447
128	824.20	3.6	-10	-34.87	-0.0423
128	824.20	3.6	0	-43.39	-0.0526
128	824.20	3.6	10	-46.10	-0.0559
128	824.20	3.6	20	-41.65	-0.0505
128	824.20	3.6	30	-51.59	-0.0626
128	824.20	3.6	40	-49.59	-0.0602
128	824.20	3.6	50	-48.36	-0.0587
128	824.20	3.6	60	-52.30	-0.0635

Traffic Channel Number	Frequency (MHz)	Voltage (Volts)	Temperature (Celsius)	Frequency Error (Hz)	PPM
128	824.20	3.7	-30	-26.41	-0.0320
128	824.20	3.7	-20	-31.58	-0.0383
128	824.20	3.7	-10	-24.09	-0.0292
128	824.20	3.7	0	-34.61	-0.0420
128	824.20	3.7	10	-39.26	-0.0476
128	824.20	3.7	20	-39.97	-0.0485
128	824.20	3.7	30	-43.72	-0.0530
128	824.20	3.7	40	-41.07	-0.0498
128	824.20	3.7	50	-45.26	-0.0549
128	824.20	3.7	60	-50.11	-0.0608

Traffic Channel Number	Frequency (MHz)	Voltage (Volts)	Temperature (Celsius)	Frequency Error (Hz)	PPM
128	824.20	4.2	-30	-25.31	-0.0307
128	824.20	4.2	-20	-27.77	-0.0337
128	824.20	4.2	-10	-31.12	-0.0378
128	824.20	4.2	0	-32.16	-0.0390
128	824.20	4.2	10	-35.90	-0.0436
128	824.20	4.2	20	-41.91	-0.0508
128	824.20	4.2	30	-38.74	-0.0470
128	824.20	4.2	40	-43.07	-0.0523
128	824.20	4.2	50	-39.00	-0.0473
128	824.20	4.2	60	-39.32	-0.0477

Test Report No.
 RTS-1765-0907-21

Dates of Test
 July 23 to August 24, 2009

Author Data
 Michael Cino

GSM850 Results: channel 189 @ maximum transmitted power

Traffic Channel Number	Frequency (MHz)	Voltage (Volts)	Temperature (Celsius)	Frequency Error (Hz)	PPM
189	836.40	3.6	-30	-28.86	-0.0345
189	836.40	3.6	-20	-34.74	-0.0415
189	836.40	3.6	-10	-35.58	-0.0425
189	836.40	3.6	0	-50.24	-0.0601
189	836.40	3.6	10	-54.30	-0.0649
189	836.40	3.6	20	-43.33	-0.0518
189	836.40	3.6	30	-43.91	-0.0525
189	836.40	3.6	40	-55.60	-0.0665
189	836.40	3.6	50	-47.01	-0.0562
189	836.40	3.6	60	-49.85	-0.0596

Traffic Channel Number	Frequency (MHz)	Voltage (Volts)	Temperature (Celsius)	Frequency Error (Hz)	PPM
189	836.40	3.7	-30	-24.92	-0.0298
189	836.40	3.7	-20	-28.22	-0.0337
189	836.40	3.7	-10	-28.09	-0.0336
189	836.40	3.7	0	-36.16	-0.0432
189	836.40	3.7	10	-38.36	-0.0459
189	836.40	3.7	20	-40.62	-0.0486
189	836.40	3.7	30	-47.20	-0.0564
189	836.40	3.7	40	-44.10	-0.0527
189	836.40	3.7	50	-39.45	-0.0472
189	836.40	3.7	60	-47.01	-0.0562

Traffic Channel Number	Frequency (MHz)	Voltage (Volts)	Temperature (Celsius)	Frequency Error (Hz)	PPM
189	836.40	4.2	-30	-29.70	-0.0355
189	836.40	4.2	-20	-23.76	-0.0284
189	836.40	4.2	-10	-34.03	-0.0407
189	836.40	4.2	0	-29.57	-0.0354
189	836.40	4.2	10	-31.12	-0.0372
189	836.40	4.2	20	-41.33	-0.0494
189	836.40	4.2	30	-44.10	-0.0527
189	836.40	4.2	40	-43.91	-0.0525
189	836.40	4.2	50	-39.52	-0.0473
189	836.40	4.2	60	-37.84	-0.0452

Test Report No. RTS-1765-0907-21	Dates of Test July 23 to August 24, 2009	Author Data Michael Cino
-------------------------------------	---------------------------------------------	-----------------------------

GSM850 Results: channel 250 @ maximum transmitted power

Traffic Channel Number	Frequency (MHz)	Voltage (Volts)	Temperature (Celsius)	Frequency Error (Hz)	PPM
250	848.60	3.6	-30	-29.44	-0.0347
250	848.60	3.6	-20	-25.12	-0.0296
250	848.60	3.6	-10	-25.89	-0.0305
250	848.60	3.6	0	-45.65	-0.0538
250	848.60	3.6	10	-48.36	-0.0570
250	848.60	3.6	20	-43.78	-0.0516
250	848.60	3.6	30	-44.94	-0.0530
250	848.60	3.6	40	-39.52	-0.0466
250	848.60	3.6	50	-43.07	-0.0508
250	848.60	3.6	60	-48.56	-0.0572

Traffic Channel Number	Frequency (MHz)	Voltage (Volts)	Temperature (Celsius)	Frequency Error (Hz)	PPM
250	848.60	3.7	-30	-21.63	-0.0255
250	848.60	3.7	-20	-24.92	-0.0294
250	848.60	3.7	-10	-23.37	-0.0275
250	848.60	3.7	0	-27.51	-0.0324
250	848.60	3.7	10	-32.93	-0.0388
250	848.60	3.7	20	-35.97	-0.0424
250	848.60	3.7	30	-43.46	-0.0512
250	848.60	3.7	40	-41.13	-0.0485
250	848.60	3.7	50	-37.45	-0.0441
250	848.60	3.7	60	-46.81	-0.0552

Traffic Channel Number	Frequency (MHz)	Voltage (Volts)	Temperature (Celsius)	Frequency Error (Hz)	PPM
250	848.60	4.2	-30	-27.89	-0.0329
250	848.60	4.2	-20	-19.50	-0.0230
250	848.60	4.2	-10	-32.22	-0.0380
250	848.60	4.2	0	-32.35	-0.0381
250	848.60	4.2	10	-31.25	-0.0368
250	848.60	4.2	20	-39.84	-0.0469
250	848.60	4.2	30	-40.81	-0.0481
250	848.60	4.2	40	-39.52	-0.0466
250	848.60	4.2	50	-41.13	-0.0485
250	848.60	4.2	60	-40.29	-0.0475

Test Report No. RTS-1765-0907-21	Dates of Test July 23 to August 24, 2009	Author Data Michael Cino
-------------------------------------	---------------------------------------------	-----------------------------

PCS Channel results: channels 512, 661, & 810 @ 20°C maximum transmitted power

Date of Test: August 05, 2009

Traffic Channel Number	PCS Frequency (MHz)	Voltage (Volts)	Temperature (Celsius)	Frequency Error (Hz)	PPM
512	1850.2	3.6	20	-89.43	-0.0483
661	1880.0	3.6	20	-75.42	-0.0401
810	1909.8	3.6	20	-76.00	-0.0398

Traffic Channel Number	PCS Frequency (MHz)	Voltage (Volts)	Temperature (Celsius)	Frequency Error (Hz)	PPM
512	1850.2	3.7	20	-80.84	-0.0437
661	1880.0	3.7	20	-72.77	-0.0387
810	1909.8	3.7	20	-77.62	-0.0406

Traffic Channel Number	PCS Frequency (MHz)	Voltage (Volts)	Temperature (Celsius)	Frequency Error (Hz)	PPM
512	1850.2	4.2	20	-60.57	-0.0327
661	1880.0	4.2	20	-55.14	-0.0293
810	1909.8	4.2	20	-57.47	-0.0301

Test Report No. RTS-1765-0907-21	Dates of Test July 23 to August 24, 2009	Author Data Michael Cino
-------------------------------------	---------------------------------------------	-----------------------------

PCS1900 Results: channel 512 @ maximum transmitted power

Traffic Channel Number	Frequency (MHz)	Voltage (Volts)	Temperature (Celsius)	Frequency Error (Hz)	PPM
512	1850.2	3.6	-30	-33.51	-0.0181
512	1850.2	3.6	-20	-55.92	-0.0302
512	1850.2	3.6	-10	-77.03	-0.0416
512	1850.2	3.6	0	-73.22	-0.0396
512	1850.2	3.6	10	-85.56	-0.0462
512	1850.2	3.6	20	-89.43	-0.0483
512	1850.2	3.6	30	-92.21	-0.0498
512	1850.2	3.6	40	-96.92	-0.0524
512	1850.2	3.6	50	-94.02	-0.0508
512	1850.2	3.6	60	-94.98	-0.0513

Traffic Channel Number	Frequency (MHz)	Voltage (Volts)	Temperature (Celsius)	Frequency Error (Hz)	PPM
512	1850.2	3.7	-30	-21.37	-0.0116
512	1850.2	3.7	-20	-67.80	-0.0366
512	1850.2	3.7	-10	-75.42	-0.0408
512	1850.2	3.7	0	-74.45	-0.0402
512	1850.2	3.7	10	-79.29	-0.0429
512	1850.2	3.7	20	-80.84	-0.0437
512	1850.2	3.7	30	-81.68	-0.0441
512	1850.2	3.7	40	-82.01	-0.0443
512	1850.2	3.7	50	-94.60	-0.0511
512	1850.2	3.7	60	-96.02	-0.0519

Traffic Channel Number	Frequency (MHz)	Voltage (Volts)	Temperature (Celsius)	Frequency Error (Hz)	PPM
512	1850.2	4.2	-30	-19.44	-0.0105
512	1850.2	4.2	-20	-48.56	-0.0262
512	1850.2	4.2	-10	-69.03	-0.0373
512	1850.2	4.2	0	-56.82	-0.0307
512	1850.2	4.2	10	-53.66	-0.0290
512	1850.2	4.2	20	-60.57	-0.0327
512	1850.2	4.2	30	-76.26	-0.0412
512	1850.2	4.2	40	-86.59	-0.0468
512	1850.2	4.2	50	-68.58	-0.0371
512	1850.2	4.2	60	-76.39	-0.0413

Test Report No. RTS-1765-0907-21	Dates of Test July 23 to August 24, 2009	Author Data Michael Cino
-------------------------------------	---------------------------------------------	-----------------------------

PCS1900 Results: channel 661 @ maximum transmitted power

Traffic Channel Number	Frequency (MHz)	Voltage (Volts)	Temperature (Celsius)	Frequency Error (Hz)	PPM
661	1880	3.6	-30	-25.38	-0.0135
661	1880	3.6	-20	-59.79	-0.0318
661	1880	3.6	-10	-79.16	-0.0421
661	1880	3.6	0	-74.52	-0.0396
661	1880	3.6	10	-76.58	-0.0407
661	1880	3.6	20	-75.42	-0.0401
661	1880	3.6	30	-78.52	-0.0418
661	1880	3.6	40	-94.60	-0.0503
661	1880	3.6	50	-89.88	-0.0478
661	1880	3.6	60	-89.63	-0.0477

Traffic Channel Number	Frequency (MHz)	Voltage (Volts)	Temperature (Celsius)	Frequency Error (Hz)	PPM
661	1880	3.7	-30	-18.08	-0.0096
661	1880	3.7	-20	-49.46	-0.0263
661	1880	3.7	-10	-69.61	-0.0370
661	1880	3.7	0	-57.79	-0.0307
661	1880	3.7	10	-64.83	-0.0345
661	1880	3.7	20	-72.77	-0.0387
661	1880	3.7	30	-83.62	-0.0445
661	1880	3.7	40	-80.26	-0.0427
661	1880	3.7	50	-91.18	-0.0485
661	1880	3.7	60	-85.43	-0.0454

Traffic Channel Number	Frequency (MHz)	Voltage (Volts)	Temperature (Celsius)	Frequency Error (Hz)	PPM
661	1880	4.2	-30	-31.12	-0.0166
661	1880	4.2	-20	-36.61	-0.0195
661	1880	4.2	-10	-62.57	-0.0333
661	1880	4.2	0	-42.81	-0.0228
661	1880	4.2	10	-57.79	-0.0307
661	1880	4.2	20	-55.14	-0.0293
661	1880	4.2	30	-74.52	-0.0396
661	1880	4.2	40	-77.94	-0.0415
661	1880	4.2	50	-65.41	-0.0348
661	1880	4.2	60	-71.80	-0.0382

PCS1900 Results: channel 810 @ maximum transmitted power

Traffic Channel Number	Frequency (MHz)	Voltage (Volts)	Temperature (Celsius)	Frequency Error (Hz)	PPM
810	1909.8	3.6	-30	-31.83	-0.0167
810	1909.8	3.6	-20	-73.61	-0.0385
810	1909.8	3.6	-10	-67.35	-0.0353
810	1909.8	3.6	0	-62.57	-0.0328
810	1909.8	3.6	10	-65.15	-0.0341
810	1909.8	3.6	20	-76.00	-0.0398
810	1909.8	3.6	30	-78.20	-0.0409
810	1909.8	3.6	40	-98.28	-0.0515
810	1909.8	3.6	50	-90.72	-0.0475
810	1909.8	3.6	60	-100.80	-0.0528

Traffic Channel Number	Frequency (MHz)	Voltage (Volts)	Temperature (Celsius)	Frequency Error (Hz)	PPM
810	1909.8	3.7	-30	-24.86	-0.0130
810	1909.8	3.7	-20	-61.47	-0.0322
810	1909.8	3.7	-10	-63.93	-0.0335
810	1909.8	3.7	0	-52.43	-0.0275
810	1909.8	3.7	10	-61.41	-0.0322
810	1909.8	3.7	20	-77.62	-0.0406
810	1909.8	3.7	30	-78.33	-0.0410
810	1909.8	3.7	40	-77.94	-0.0408
810	1909.8	3.7	50	-88.98	-0.0466
810	1909.8	3.7	60	-84.40	-0.0442

Traffic Channel Number	Frequency (MHz)	Voltage (Volts)	Temperature (Celsius)	Frequency Error (Hz)	PPM
810	1909.8	4.2	-30	-36.48	-0.0191
810	1909.8	4.2	-20	-50.11	-0.0262
810	1909.8	4.2	-10	-59.15	-0.0310
810	1909.8	4.2	0	-34.16	-0.0179
810	1909.8	4.2	10	-52.82	-0.0277
810	1909.8	4.2	20	-57.47	-0.0301
810	1909.8	4.2	30	-71.03	-0.0372
810	1909.8	4.2	40	-78.26	-0.0410
810	1909.8	4.2	50	-62.96	-0.0330
810	1909.8	4.2	60	-61.99	-0.0325

APPENDIX 3B – CDMA FREQUENCY STABILITY TEST DATA

CDMA Frequency Stability Test Data

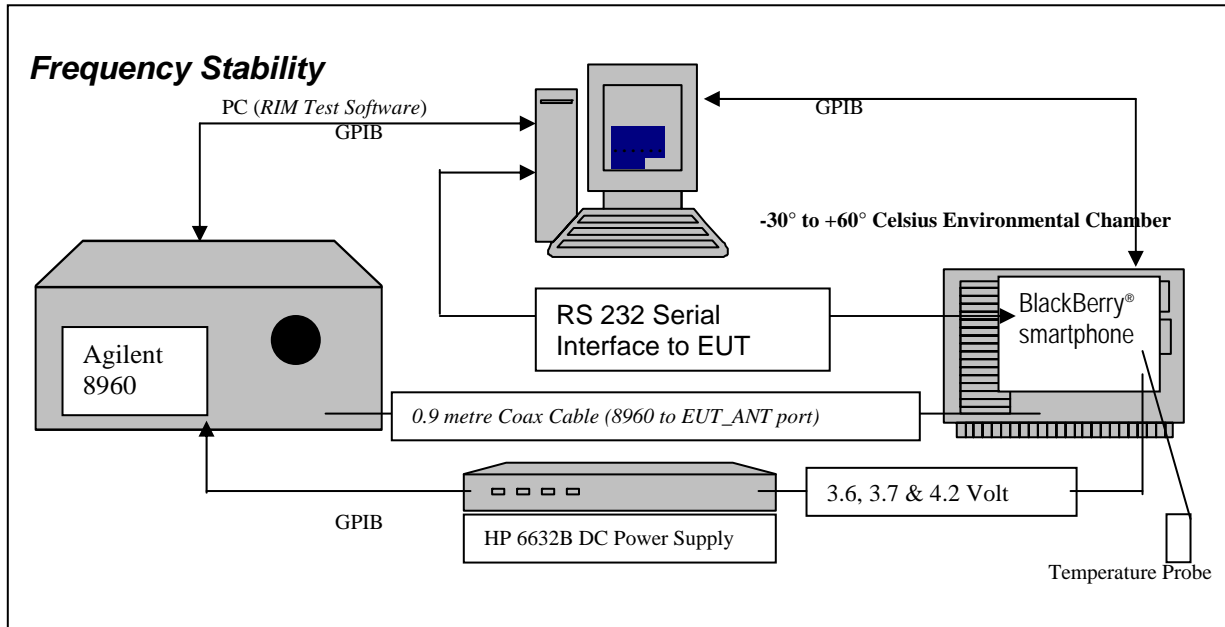

CFR 47 Chapter 1 - Federal Communications Commission Rules

Part 2 Required Measurements

2.1055 Frequency Stability - Procedures

- (a,b) Frequency Stability - Temperature Variation
- (d) Frequency Stability - Voltage Variation

24.236 Frequency Stability.

The frequency stability shall be sufficient to ensure that the fundamental emission stays within the authorized frequency block.

The RCK71CW BlackBerry® smartphone, (referred as EUT herein and after) transmitted frequencies are less than 0.1 ppm of the received frequency from the Agilent 8960 CDMA Base Station Simulator

The EUT meets the requirements as stated in CFR 47 chapter 1, Section 24.235, RSS-GEN, 4.7, CFR 47 chapter 1, Section 22.917 and RSS-132, 4.3 Frequency Stability.

Frequency Stability measurement devices were configured as presented in the block diagram recording frequency, power, data, temperatures, and stepped voltages controlled via a GPIB interface linked to the Environmental chamber, a DC power supply, and the Communications Test Set. A 0.9-metre coax cable was calibrated to characterize the insertion loss for the transmitted frequencies between the RF input/output of the base station simulator and the EUT antenna port; located inside the environmental chamber.

Calibration for the Cable Loss was performed in the RF Laboratory using the Agilent power meter and Agilent Signal Generator.

	EMI Test Report for the BlackBerry® smartphone Model RCK71CW	
	APPENDIX 3B	
Test Report No. RTS-1765-0907-21	Dates of Test July 23 to August 24, 2009	Author Data Michael Cino

The cable assembly from the RF input to the RF output was measured at the following Frequencies:

PCS Frequency (MHz)	Cable loss (dB)
1851.20	1.20
1880.00	1.20
1908.75	1.20

Cellular Frequency (MHz)	Cable loss (dB)
824.70	0.90
836.52	0.90
848.31	0.90

Procedure:

The EUT was placed in the Temperature chamber and connected to the Agilent 8960 outside as shown in the figure above. Dry air was pumped inside the temperature chamber to maintain a backpressure during the test. The EUT was kept in the off condition at all times except when the following measurements were to be made.

The chamber was switched on and the temperature was set to -30°C. After the chamber stabilized at -30 °C there was a soak period of one hour to alleviate moisture in the chamber, the EUT voltage was enabled. The system software recorded the frequency, power, and associated measurements.

A Computer system controlled the automated software. This application was given the command of activating all machines intrinsic to the temperature and voltage tests controlling the base station simulator via the GPIB Bus. The Environmental Chamber was instructed through an RS-232 serial line. The EUT dialogue was passed through a serial connection.

The EUT repetitively transmitted 100 bursts for each set of programmed parameters recording temperature, voltage settings, and systematically selected frequencies. The power supply was cycled from minimum voltage 3.6 volts, to 3.7 volts nominal voltage to 4.2 volts maximum voltage. The frequency error was measured at a maximum output power and recorded by the automated system test software.

The EUT output power and frequency was measured at 3.6 volts, 3.7 volts and 4.2 volts. The transmit frequency was varied in 3 steps consisting of 824.70, 836.52, and 848.31 MHz for the cellular band and 1851.20, 1880.00 and 1908.75 MHz for the PCS band. This frequency was recorded in MHz and deviation from nominal, in Parts per Million. After the initial one-hour soak at the beginning of the tests, a period of thirty minutes soak was initialized between each ascending temperature step, before proceeding to the next measurement test cycle.

	EMI Test Report for the BlackBerry® smartphone Model RCK71CW APPENDIX 3B	
	Test Report No. RTS-1765-0907-21	Dates of Test July 23 to August 24, 2009

PROCEDURE:

The test system software for commencing the Frequency Stability Tests carried through the following cycle.

1. Switch on the HP 6632B power supply; AGILENT 8960, and Environmental Chamber.
2. Start test program
3. Set the Temperature to -30°C and maintain a period of one- hour soak time, with the EUT supply voltage disabled.
4. Set power supply voltage to 3.6 volts.
5. Set up base station simulator.
6. Command the base station simulator to switch to the low channel.
7. Enable the voltage to the EUT, and connect a link to the base station simulator.
8. EUT is commanded to Transmit 100 Bursts.
9. Software logs the following data from the base station simulator, power supply and temperature chamber: Traffic Channel Number, Traffic Channel Frequency, Power Level, Chamber Temperature, Supply Voltage, Power, Frequency Error.
10. The base station simulator commands the EUT to change frequency to the middle channel and high channel and repeats steps 7 to 9.
11. Repeat steps 5 to 10 changing the supply voltage to 3.7 Volts
12. Increase temperature by 10°C and soak for 1/2 hour.
13. Repeat steps 4 - 12 for temperatures -30°C to 60°C .
14. Repeat steps 5 to 10 changing the supply voltage to 4.2 volts

Procedure 5 to 10 was repeated at room temperature (20°C) with the power supply voltage set to 3.6, 3.7 and 4.2 volts.

The BlackBerry® smartphone PIN 30C43837 was tested on August 06, 2009. The following measurements were performed by Maurice Battler.

The maximum frequency error in the Cellular band measured was **0.0102 PPM**.
The maximum frequency error in the PCS band measured was **0.0061 PPM**.

Test Report No. RTS-1765-0907-21	Dates of Test July 23 to August 24, 2009	Author Data Michael Cino
-------------------------------------	---------------------------------------------	-----------------------------

Cellular Channel results: channels 1013, 384 and 777 @ 20°C maximum transmitted power

Traffic Channel Number	Cellular Frequency (MHz)	Voltage (Volts)	Temperature (Celsius)	Frequency Error (Hz)	PPM
1013	824.700	3.6	20	-1.46	-0.0018
384	836.520	3.6	20	2.01	0.0024
777	848.310	3.6	20	0.10	0.0001

Traffic Channel Number	Cellular Frequency (MHz)	Voltage (Volts)	Temperature (Celsius)	Frequency Error (Hz)	PPM
1013	824.700	3.7	20	-1.03	-0.0013
384	836.520	3.7	20	-0.29	-0.0003
777	848.310	3.7	20	-0.24	-0.0003

Traffic Channel Number	Cellular Frequency (MHz)	Voltage (Volts)	Temperature (Celsius)	Frequency Error (Hz)	PPM
1013	824.700	4.2	20	0.92	0.0011
384	836.520	4.2	20	-0.09	-0.0001
777	848.310	4.2	20	-0.36	-0.0004

Test Report No. RTS-1765-0907-21	Dates of Test July 23 to August 24, 2009	Author Data Michael Cino
-------------------------------------	---------------------------------------------	-----------------------------

Cellular Results: channel 1013 @ maximum transmitted power

Traffic Channel Number	Frequency (MHz)	Voltage (Volts)	Temperature (Celsius)	Frequency Error (Hz)	PPM
1013	824.700	3.6	-30	-3.89	-0.0047
1013	824.700	3.6	-20	-0.03	0.0000
1013	824.700	3.6	-10	-4.19	-0.0051
1013	824.700	3.6	0	0.37	0.0004
1013	824.700	3.6	10	1.64	0.0020
1013	824.700	3.6	20	-1.46	-0.0018
1013	824.700	3.6	30	-0.35	-0.0004
1013	824.700	3.6	40	-2.57	-0.0031
1013	824.700	3.6	50	-1.42	-0.0017
1013	824.700	3.6	60	2.47	0.0030

Traffic Channel Number	Frequency (MHz)	Voltage (Volts)	Temperature (Celsius)	Frequency Error (Hz)	PPM
1013	824.700	3.7	-30	-2.24	-0.0027
1013	824.700	3.7	-20	2.10	0.0026
1013	824.700	3.7	-10	-3.21	-0.0039
1013	824.700	3.7	0	3.49	0.0042
1013	824.700	3.7	10	2.66	0.0032
1013	824.700	3.7	20	-1.03	-0.0013
1013	824.700	3.7	30	0.41	0.0005
1013	824.700	3.7	40	0.70	0.0008
1013	824.700	3.7	50	1.92	0.0023
1013	824.700	3.7	60	4.73	0.0057

Traffic Channel Number	Frequency (MHz)	Voltage (Volts)	Temperature (Celsius)	Frequency Error (Hz)	PPM
1013	824.700	4.2	-30	0.36	0.0004
1013	824.700	4.2	-20	0.18	0.0002
1013	824.700	4.2	-10	0.67	0.0008
1013	824.700	4.2	0	-0.30	-0.0004
1013	824.700	4.2	10	-0.78	-0.0009
1013	824.700	4.2	20	0.92	0.0011
1013	824.700	4.2	30	-0.50	-0.0006
1013	824.700	4.2	40	0.28	0.0003
1013	824.700	4.2	50	-0.29	-0.0004
1013	824.700	4.2	60	-0.41	-0.0005

Cellular Results: channel 384 @ maximum transmitted power

Traffic Channel Number	Frequency (MHz)	Voltage (Volts)	Temperature (Celsius)	Frequency Error (Hz)	PPM
384	836.520	3.6	-30	-4.81	-0.0058
384	836.520	3.6	-20	4.87	0.0058
384	836.520	3.6	-10	-2.56	-0.0031
384	836.520	3.6	0	6.86	0.0082
384	836.520	3.6	10	7.79	0.0093
384	836.520	3.6	20	2.01	0.0024
384	836.520	3.6	30	0.37	0.0004
384	836.520	3.6	40	1.85	0.0022
384	836.520	3.6	50	3.24	0.0039
384	836.520	3.6	60	10.17	0.0122

Traffic Channel Number	Frequency (MHz)	Voltage (Volts)	Temperature (Celsius)	Frequency Error (Hz)	PPM
384	836.520	3.7	-30	-1.39	-0.0017
384	836.520	3.7	-20	1.36	0.0016
384	836.520	3.7	-10	-2.41	-0.0029
384	836.520	3.7	0	2.36	0.0028
384	836.520	3.7	10	2.94	0.0035
384	836.520	3.7	20	-0.29	-0.0003
384	836.520	3.7	30	0.99	0.0012
384	836.520	3.7	40	0.75	0.0009
384	836.520	3.7	50	2.58	0.0031
384	836.520	3.7	60	5.32	0.0064

Traffic Channel Number	Frequency (MHz)	Voltage (Volts)	Temperature (Celsius)	Frequency Error (Hz)	PPM
384	836.520	4.2	-30	0.55	0.0007
384	836.520	4.2	-20	0.10	0.0001
384	836.520	4.2	-10	-0.20	-0.0002
384	836.520	4.2	0	0.25	0.0003
384	836.520	4.2	10	0.20	0.0002
384	836.520	4.2	20	-0.09	-0.0001
384	836.520	4.2	30	0.11	0.0001
384	836.520	4.2	40	0.45	0.0005
384	836.520	4.2	50	1.02	0.0012
384	836.520	4.2	60	1.11	0.0013

Cellular Results: channel 777 @ maximum transmitted power

Traffic Channel Number	Frequency (MHz)	Voltage (Volts)	Temperature (Celsius)	Frequency Error (Hz)	PPM
777	848.310	3.6	-30	-4.00	-0.0047
777	848.310	3.6	-20	3.18	0.0038
777	848.310	3.6	-10	-3.57	-0.0042
777	848.310	3.6	0	4.39	0.0052
777	848.310	3.6	10	5.28	0.0062
777	848.310	3.6	20	0.10	0.0001
777	848.310	3.6	30	0.08	0.0001
777	848.310	3.6	40	1.29	0.0015
777	848.310	3.6	50	3.24	0.0038
777	848.310	3.6	60	9.13	0.0108

Traffic Channel Number	Frequency (MHz)	Voltage (Volts)	Temperature (Celsius)	Frequency Error (Hz)	PPM
777	848.310	3.7	-30	-2.58	-0.0030
777	848.310	3.7	-20	0.86	0.0010
777	848.310	3.7	-10	-2.94	-0.0035
777	848.310	3.7	0	2.62	0.0031
777	848.310	3.7	10	2.53	0.0030
777	848.310	3.7	20	-0.24	-0.0003
777	848.310	3.7	30	0.73	0.0009
777	848.310	3.7	40	0.75	0.0009
777	848.310	3.7	50	1.35	0.0016
777	848.310	3.7	60	4.60	0.0054

Traffic Channel Number	Frequency (MHz)	Voltage (Volts)	Temperature (Celsius)	Frequency Error (Hz)	PPM
777	848.310	4.2	-30	0.09	0.0001
777	848.310	4.2	-20	-0.14	-0.0002
777	848.310	4.2	-10	-0.33	-0.0004
777	848.310	4.2	0	1.11	0.0013
777	848.310	4.2	10	1.46	0.0017
777	848.310	4.2	20	-0.36	-0.0004
777	848.310	4.2	30	0.05	0.0001
777	848.310	4.2	40	0.19	0.0002
777	848.310	4.2	50	0.89	0.0010
777	848.310	4.2	60	2.10	0.0025

PCS Channel results: channels 25, 600, & 1175 @ 20°C maximum transmitted power

Traffic Channel Number	PCS Frequency (MHz)	Voltage (Volts)	Temperature (Celsius)	Frequency Error (Hz)	PPM
25	1851.20	3.6	20	1.25	0.0007
600	1880.00	3.6	20	2.18	0.0012
1175	1908.75	3.6	20	0.76	0.0004

Traffic Channel Number	PCS Frequency (MHz)	Voltage (Volts)	Temperature (Celsius)	Frequency Error (Hz)	PPM
25	1851.20	3.7	20	-0.16	-0.0001
600	1880.00	3.7	20	-1.15	-0.0006
1175	1908.75	3.7	20	-1.62	-0.0008

Traffic Channel Number	PCS Frequency (MHz)	Voltage (Volts)	Temperature (Celsius)	Frequency Error (Hz)	PPM
25	1851.20	4.2	20	0.45	0.0002
600	1880.00	4.2	20	-0.06	0.0000
1175	1908.75	4.2	20	-0.85	-0.0004

PCS Results: channel 25 @ maximum transmitted power

Traffic Channel Number	Frequency (MHz)	Voltage (Volts)	Temperature (Celsius)	Frequency Error (Hz)	PPM
25	1851.20	3.6	-30	-9.99	-0.0054
25	1851.20	3.6	-20	3.43	0.0019
25	1851.20	3.6	-10	-5.55	-0.0030
25	1851.20	3.6	0	5.09	0.0027
25	1851.20	3.6	10	7.08	0.0038
25	1851.20	3.6	20	1.25	0.0007
25	1851.20	3.6	30	-3.87	-0.0021
25	1851.20	3.6	40	-2.59	-0.0014
25	1851.20	3.6	50	0.00	0.0000
25	1851.20	3.6	60	8.15	0.0044

Traffic Channel Number	Frequency (MHz)	Voltage (Volts)	Temperature (Celsius)	Frequency Error (Hz)	PPM
25	1851.20	3.7	-30	-4.02	-0.0022
25	1851.20	3.7	-20	3.49	0.0019
25	1851.20	3.7	-10	-3.36	-0.0018
25	1851.20	3.7	0	4.45	0.0024
25	1851.20	3.7	10	5.38	0.0029
25	1851.20	3.7	20	-0.16	-0.0001
25	1851.20	3.7	30	-1.06	-0.0006
25	1851.20	3.7	40	-0.04	0.0000
25	1851.20	3.7	50	2.44	0.0013
25	1851.20	3.7	60	7.64	0.0041

Traffic Channel Number	Frequency (MHz)	Voltage (Volts)	Temperature (Celsius)	Frequency Error (Hz)	PPM
25	1851.20	4.2	-30	0.63	0.0003
25	1851.20	4.2	-20	1.56	0.0008
25	1851.20	4.2	-10	-0.23	-0.0001
25	1851.20	4.2	0	2.04	0.0011
25	1851.20	4.2	10	1.39	0.0008
25	1851.20	4.2	20	0.45	0.0002
25	1851.20	4.2	30	0.64	0.0003
25	1851.20	4.2	40	0.51	0.0003
25	1851.20	4.2	50	-0.38	-0.0002
25	1851.20	4.2	60	1.36	0.0007

Test Report No.
 RTS-1765-0907-21

Dates of Test
 July 23 to August 24, 2009

Author Data
 Michael Cino

PCS Results: channel 600 @ maximum transmitted power

Traffic Channel Number	Frequency (MHz)	Voltage (Volts)	Temperature (Celsius)	Frequency Error (Hz)	PPM
600	1880.00	3.6	-30	-5.68	-0.0030
600	1880.00	3.6	-20	5.24	0.0028
600	1880.00	3.6	-10	-4.13	-0.0022
600	1880.00	3.6	0	5.92	0.0032
600	1880.00	3.6	10	8.03	0.0043
600	1880.00	3.6	20	2.18	0.0012
600	1880.00	3.6	30	-0.37	-0.0002
600	1880.00	3.6	40	1.41	0.0007
600	1880.00	3.6	50	4.42	0.0024
600	1880.00	3.6	60	11.51	0.0061

Traffic Channel Number	Frequency (MHz)	Voltage (Volts)	Temperature (Celsius)	Frequency Error (Hz)	PPM
600	1880.00	3.7	-30	-2.55	-0.0014
600	1880.00	3.7	-20	1.12	0.0006
600	1880.00	3.7	-10	-2.63	-0.0014
600	1880.00	3.7	0	1.54	0.0008
600	1880.00	3.7	10	1.21	0.0006
600	1880.00	3.7	20	-1.15	-0.0006
600	1880.00	3.7	30	-1.47	-0.0008
600	1880.00	3.7	40	-0.97	-0.0005
600	1880.00	3.7	50	1.51	0.0008
600	1880.00	3.7	60	4.67	0.0025

Traffic Channel Number	Frequency (MHz)	Voltage (Volts)	Temperature (Celsius)	Frequency Error (Hz)	PPM
600	1880.00	4.2	-30	-1.44	-0.0008
600	1880.00	4.2	-20	0.88	0.0005
600	1880.00	4.2	-10	-1.31	-0.0007
600	1880.00	4.2	0	0.33	0.0002
600	1880.00	4.2	10	0.94	0.0005
600	1880.00	4.2	20	-0.06	0.0000
600	1880.00	4.2	30	-0.52	-0.0003
600	1880.00	4.2	40	0.11	0.0001
600	1880.00	4.2	50	-0.70	-0.0004
600	1880.00	4.2	60	0.38	0.0002

Test Report No.
RTS-1765-0907-21

Dates of Test
July 23 to August 24, 2009

Author Data
Michael Cino

PCS Results: channel 1175 @ maximum transmitted power

Traffic Channel Number	Frequency (MHz)	Voltage (Volts)	Temperature (Celsius)	Frequency Error (Hz)	PPM
1175	1908.75	3.6	-30	-4.24	-0.0022
1175	1908.75	3.6	-20	2.88	0.0015
1175	1908.75	3.6	-10	-5.17	-0.0027
1175	1908.75	3.6	0	3.44	0.0018
1175	1908.75	3.6	10	4.56	0.0024
1175	1908.75	3.6	20	0.76	0.0004
1175	1908.75	3.6	30	-1.36	-0.0007
1175	1908.75	3.6	40	1.23	0.0006
1175	1908.75	3.6	50	1.48	0.0008
1175	1908.75	3.6	60	5.69	0.0030

Traffic Channel Number	Frequency (MHz)	Voltage (Volts)	Temperature (Celsius)	Frequency Error (Hz)	PPM
1175	1908.75	3.7	-30	-1.93	-0.0010
1175	1908.75	3.7	-20	1.72	0.0009
1175	1908.75	3.7	-10	-2.73	-0.0014
1175	1908.75	3.7	0	1.93	0.0010
1175	1908.75	3.7	10	2.33	0.0012
1175	1908.75	3.7	20	-1.62	-0.0008
1175	1908.75	3.7	30	-2.27	-0.0012
1175	1908.75	3.7	40	0.50	0.0003
1175	1908.75	3.7	50	0.09	0.0000
1175	1908.75	3.7	60	2.41	0.0013

Traffic Channel Number	Frequency (MHz)	Voltage (Volts)	Temperature (Celsius)	Frequency Error (Hz)	PPM
1175	1908.75	4.2	-30	0.35	0.0002
1175	1908.75	4.2	-20	-0.01	0.0000
1175	1908.75	4.2	-10	-1.12	-0.0006
1175	1908.75	4.2	0	0.62	0.0003
1175	1908.75	4.2	10	-0.51	-0.0003
1175	1908.75	4.2	20	-0.85	-0.0004
1175	1908.75	4.2	30	-0.27	-0.0001
1175	1908.75	4.2	40	-0.77	-0.0004
1175	1908.75	4.2	50	-1.87	-0.0010
1175	1908.75	4.2	60	-1.45	-0.0008

APPENDIX 4A – GSM RADIATED EMISSIONS TEST DATA

		EMI Test Report for the BlackBerry® smartphone Model RCK71CW APPENDIX 4A	
Test Report No. RTS-1765-0907-21	Dates of Test July 23 to August 24, 2009	Author Data Michael Cino	

Radiated Power Test Data Results

The following measurements were performed by Fahd Faisal.

Date of tests: August 13 and 24, 2009

The environmental tests conditions were: Temperature: 24 – 25 °C
Pressure: 1006 – 1017 mb
Relative Humidity: 30 %

GSM850 Band

GSM Mode

The BlackBerry® smartphone PIN 30C2BF78 was in standalone, USB up position.
Test distance is 3.0 metres.

EUT				Rx Antenna		Spectrum Analyzer		Substitution Method				Limit (dBm)	Diff. To Limit (dB)
Type	Ch	Frequency (MHz)	Band	Type	Pol.	Reading (dBuV)	Max (V,H) (dBuV)	Tracking Generator		Corrected Reading (relative to Dipole)			
								Pol. Tx-Rx	Reading (dBm)	(dBm)	(W)		
F0	128	824.20	850	Dipole	V	76.58	87.32	V-V	14.62	29.66	0.92	38.50	-8.84
F0	128	824.20	850	Dipole	H	87.32		H-H	12.51				
F0	195	837.60	850	Dipole	V	78.63	87.59	V-V	15.46	31.14	1.30	38.50	-7.36
F0	195	837.60	850	Dipole	H	87.59		H-H	13.61				
F0	251	848.80	850	Dipole	V	76.45	86.78	V-V	14.11	29.60	0.91	38.50	-8.90
F0	251	848.80	850	Dipole	H	86.78		H-H	12.12				

		EMI Test Report for the BlackBerry® smartphone Model RCK71CW APPENDIX 4A	
Test Report No. RTS-1765-0907-21	Dates of Test July 23 to August 24, 2009	Author Data Michael Cino	

Radiated Power Test Data Results, Cont'd

EDGE Mode

The BlackBerry® smartphone PIN 30C2BF78 was in standalone, USB up position
Test distance is 3.0 metres.

EUT				Rx Antenna		Spectrum Analyzer		Substitution Method				Limit (dBm)	Diff. To Limit (dB)
Type	Ch	Frequency (MHz)	Band	Type	Pol.	Reading (dBuV)	Max (V,H) (dBuV)	Pol. Tx-Rx	Reading (dBm)	Tracking Generator Corrected Reading (relative to Dipole)			
										(dBm)	(W)		
F0	128	824.20	850	Dipole	V	71.56	80.84	V-V	8.09	23.13	0.21	38.50	-15.37
F0	128	824.20	850	Dipole	H	80.84		H-H	6.14				
F0	195	837.60	850	Dipole	V	71.14	80.57	V-V	8.59	24.27	0.27	38.50	-14.23
F0	195	837.60	850	Dipole	H	80.57		H-H	6.31				
F0	251	848.80	850	Dipole	V	69.29	80.73	V-V	8.53	24.02	0.25	38.50	-14.48
F0	251	848.80	850	Dipole	H	80.73		H-H	6.49				

	EMI Test Report for the BlackBerry® smartphone Model RCK71CW APPENDIX 4A	
	Test Report No. RTS-1765-0907-21	Dates of Test July 23 to August 24, 2009

Radiated Power Test Data Results cont'd

The following measurements were performed by Fahd Faisal.

PCS1900 Band

GSM Mode

Date of test: August 13, 2009

The environmental tests conditions were: Temperature: 24 °C
 Pressure: 1006 mb
 Relative Humidity: 30 %

The BlackBerry® smartphone PIN 30C2BF79 was in standalone, USB up position
 Test distance is 3.0 metres.

								Substitution Method					
EUT				Receive Antenna		Spectrum Analyzer		Tracking Generator					
Type	Ch	Frequency (MHz)	Band	Type	Pol.	Reading (dBuV)	Max (V,H) dBuV	Pol. Tx-Rx	Reading (dBm)	Corrected Reading (relative to Isotropic Radiator)		Limit (dBm)	Diff to Limit (dB)
										(dBm)	(W)		
F0	512	1850.20	1900	Horn	V	91.9	91.9	V-V	-7.02	29.36	0.86	33.00	-3.64
F0	512	1850.20	1900	Horn	H	83.67		H-H	-7.59				
F0	661	1880.00	1900	Horn	V	90.17	90.17	V-V	-8.09	28.55	0.72	33.00	-4.45
F0	661	1880.00	1900	Horn	H	83.12		H-H	-7.73				
F0	810	1909.80	1900	Horn	V	90.05	90.05	V-V	-8.23	28.33	0.68	33.00	-4.67
F0	810	1909.80	1900	Horn	H	82.4		H-H	-7.99				

		EMI Test Report for the BlackBerry® smartphone Model RCK71CW APPENDIX 4A	
Test Report No. RTS-1765-0907-21	Dates of Test July 23 to August 24, 2009	Author Data Michael Cino	

Radiated Power Test Data Results cont'd

PCS1900 Band

EDGE Mode

Date of test: August 13, 2009

The environmental test conditions were: Temperature: 24 °C
 Pressure: 1006 mb
 Relative Humidity: 30 %

The BlackBerry® smartphone PIN 30C2BF79 was in standalone, USB down position
 Test Distance was 3.0 metres.

								Substitution Method					
EUT				Receive Antenna		Spectrum Analyzer		Tracking Generator					
Type	Ch	Frequency (MHz)	Band	Type	Pol.	Reading (dBuV)	Max (V,H) dBuV	Pol. Tx-Rx	Reading (dBm)	Corrected Reading (relative to Isotropic Radiator)		Limit (dBm)	Diff to Limit (dB)
										(dBm)	(W)		
F0	512	1850.20	1900	Horn	V	85.98	85.98	V-V	-12.42	25.24	0.33	33.00	-7.76
F0	512	1850.20	1900	Horn	H	78.8		H-H	-11.14				
F0	661	1880.00	1900	Horn	V	85.03	85.03	V-V	-12.79	24.52	0.28	33.00	-8.48
F0	661	1880.00	1900	Horn	H	77.58		H-H	-11.76				
F0	810	1909.80	1900	Horn	V	84.36	84.36	V-V	-13.35	23.76	0.24	33.00	-9.24
F0	810	1909.80	1900	Horn	H	76.69		H-H	-12.56				

	EMI Test Report for the BlackBerry® smartphone Model RCK71CW	
	APPENDIX 4A	
Test Report No. RTS-1765-0907-21	Dates of Test July 23 to August 24, 2009	Author Data Michael Cino

Radiated Emissions Test Data Results

GSM850

The following measurements were performed by Kevin Rose.

Date of Test: July 23, 2009

The environmental test conditions were: Temperature: 24 °C
Pressure: 1011 mb
Relative Humidity: 29 %

Test Distance was 3.0 metres with a height of 1.0 metres, 30 MHz to 1000 MHz.
The BlackBerry® smartphone PIN 30C2BF78 was in standalone, vertical position.

The measurements were performed in GSM850 Tx mode, on channels 128, 195, and 251..

All emissions had a test margin greater than 25.0 dB.

The following measurements were performed by Savtej Sandhu.

Date of Test: July 24 and August 13, 2009

The environmental test conditions were: Temperature: 26 °C
Pressure: 1008
Relative Humidity: 26 %

Test Distance was 3.0 metres with a height of 1.0 metres, 1 GHz to 9 GHz.
The BlackBerry® smartphone PIN 30C2BF79 was in standalone, Horizontal top-down position.

The measurements were performed in GSM Tx mode, channel 128, 195 and 251.

All emissions had a test margin greater than 25.0 dB.

	EMI Test Report for the BlackBerry® smartphone Model RCK71CW	
	APPENDIX 4A	
Test Report No. RTS-1765-0907-21	Dates of Test July 23 to August 24, 2009	Author Data Michael Cino

Radiated Emissions Test Data Results cont'd

GSM850

EDGE Mode

The following measurements were performed by Kevin Rose.

Date of Test: July 23 and August 13, 2009

The environmental test conditions were: Temperature: 24 °C
Pressure: 1005 – 1011 mb
Relative Humidity: 29 – 31 %

Test Distance was 3.0 metres with a height of 1.0 metres, 30 MHz to 1000 MHz.
The BlackBerry® smartphone PIN 30C2BF78 was in standalone, vertical upright position.

The measurements were performed in GSM850 EDGE Tx mode, channels 128, 195 and 251.

All emissions had a test margin greater than 25.0 dB

The following measurements were performed by Heng Lin.

Date of Test: July 23 and August 10, 2009

The environmental test conditions were: Temperature: 24 – 26 °C
Pressure: 1008 – 1011 mb
Relative Humidity: 26 – 35 %

Test Distance was 3.0 metres with a height of 1.0 metres, 1 GHz to 9 GHz.
The BlackBerry® smartphone PIN 30C2BF79 was in standalone, horizontal position.

The measurements were performed in GSM850 EDGE Tx mode, channels 128, 195 and 251.

All emissions had a test margin greater than 25.0 dB

	EMI Test Report for the BlackBerry® smartphone Model RCK71CW	
	APPENDIX 4A	
Test Report No. RTS-1765-0907-21	Dates of Test July 23 to August 24, 2009	Author Data Michael Cino

PCS1900

The following measurements were performed by Andrew Fleming.

Date of Test: July 23, 2009

The environmental test conditions were: Temperature: 24 °C
Pressure: 1011 mb
Relative Humidity: 29 %

Test Distance was 3.0 metres with a height of 1.0 metres, 30 MHz to 1000 MHz.
The BlackBerry® smartphone PIN 30C2BF78 was in standalone, vertical position.

The measurements were performed in PCS1900 Tx mode, channels 512, 661 and 810.

All emissions had a test margin greater than 25.0 dB.

The following measurements were performed by Savtej Sandhu.

Date of Test: July 24 – 31, and August 13, 2009

The environmental test conditions were: Temperature: 24 – 26 °C
Pressure: 1008 – 1020 mb
Relative Humidity: 26 – 35 %

Test Distance was 3.0 metres with a height of 1.0 metres, 1 GHz to 20 GHz.
The BlackBerry® smartphone PIN 30C2BF79 was in standalone, USB up position.

The measurements were performed in PCS1900 Tx mode, channels 512, 661 and 810.

All emissions had a test margin greater than 25.0 dB.

	EMI Test Report for the BlackBerry® smartphone Model RCK71CW	
	APPENDIX 4A	
Test Report No. RTS-1765-0907-21	Dates of Test July 23 to August 24, 2009	Author Data Michael Cino

Radiated Emissions Test Data Results cont'd

Radiated Emissions Test Data Results cont'd

PCS1900

EDGE Mode

The following measurements were performed by Kevin Rose.

Date of Test: July 23 and August 13, 2009

The environmental test conditions were: Temperature: 24 °C
Pressure: 1005 – 1011 mb
Relative Humidity: 29 – 31 %

Test Distance was 3.0 metres with a height of 1.0 metres, 30 MHz to 1000 MHz.
The BlackBerry® smartphone PIN 30C2BF78 was in standalone, vertical position.

The measurements were performed in PCS1900 EDGE Tx mode on channels 512, 661 and 810.

All emissions had a test margin greater than 25.0 dB.

The following measurements were performed by Savtej Sandhu.

Date of Test: July 27 – 31, and August 13, 2009

The environmental test conditions were: Temperature: 24 – 26 °C
Pressure: 1008 – 1020mb
Relative Humidity: 26 – 30 %

Test Distance was 3.0 metres with a height of 1.0 metres, 1 GHz to 20 GHz.
The BlackBerry® smartphone PIN 30C2BF79 was in standalone, USB up position.

The measurements were performed in PCS1900 EDGE Tx mode on channels 512, 661 and 810.

All emissions had a test margin greater than 25.0 dB.

APPENDIX 4B – CDMA RADIATED EMISSIONS TEST DATA

		EMI Test Report for the BlackBerry® smartphone Model RCK71CW APPENDIX 4B	
Test Report No. RTS-1765-0907-21	Dates of Test July 23 to August 24, 2009		Author Data Michael Cino

Radiated Power Test Data Results

The following measurements were performed by Andrew Fleming.

Date of tests: July 30 and August 24, 2009

The environmental tests conditions were: Temperature: 24 – 25 °C
 Pressure: 1006 – 1017 mb
 Relative Humidity: 30 %

Cellular Band

Loopback Service

The BlackBerry® smartphone PIN 30C435AD was in standalone, USB down position.
 Test distance is 3.0 metres

EUT				Rx Antenna		Spectrum Analyzer		Substitution Method					
Type	Ch	Frequency (MHz)	Band	Type	Pol.	Reading (dBuV)	Max (V,H) (dBuV)	Tracking Generator		Corrected Reading (relative to Dipole)		Limit (dBm)	Diff. To Limit (dB)
								Pol.	Reading (dBm)	(dBm)	(W)		
F0	1013	824.70	800	Dipole	V	64.97	80.54	V-V	7.66	22.80	0.19	39.00	-16.20
F0	1013	824.70	800	Dipole	H	80.54		H-H	6.22				
F0	384	836.52	800	Dipole	V	65.86	79.88	V-V	8.48	23.52	0.22	39.00	-15.48
F0	384	836.52	800	Dipole	H	79.88		H-H	5.99				
F0	777	848.32	800	Dipole	V	68.23	80.01	V-V	8.27	23.30	0.21	39.00	-15.70
F0	777	848.32	800	Dipole	H	80.01		H-H	6.12				

Test Report No. RTS-1765-0907-21	Dates of Test July 23 to August 24, 2009	Author Data Michael Cino
--------------------------------------------	----------------------------------------------------	------------------------------------

Radiated Power Test Data Results cont'd

Cellular Band

1xEVDO

The BlackBerry® smartphone PIN 30C435AD was in standalone, USB up position.
 Test Distance was 3.0 metres.

EUT				Rx Antenna		Spectrum Analyzer		Substitution Method					
Type	Ch	Frequency (MHz)	Band	Type	Pol.	Reading (dBuV)	Max (V,H) (dBuV)	Tracking Generator		Corrected Reading (relative to Dipole)		Limit (dBm)	Diff. To Limit (dB)
								Pol.	Reading (dBm)	(dBm)	(W)		
F0	1013	824.70	800	Dipole	V	69.19	80.05	V-V	7.33	22.47	0.18	39.00	-16.53
F0	1013	824.70	800	Dipole	H	80.05		H-H	5.24				
F0	384	836.52	800	Dipole	V	69.52	80.17	V-V	8.02	23.06	0.20	39.00	-15.94
F0	384	836.52	800	Dipole	H	80.17		H-H	6.20				
F0	777	848.32	800	Dipole	V	70.77	80.18	V-V	7.51	22.54	0.18	39.00	-16.46
F0	777	848.32	800	Dipole	H	80.18		H-H	6.02				

		EMI Test Report for the BlackBerry® smartphone Model RCK71CW APPENDIX 4B	
Test Report No. RTS-1765-0907-21	Dates of Test July 23 to August 24, 2009		Author Data Michael Cino

Radiated Power Test Data Results cont'd

PCS Band

Loopback Service

The BlackBerry® smartphone PIN 30C435AD was in standalone, USB down position.
Test Distance was 3.0 metres.

								Substitution Method					
EUT				Receive Antenna		Spectrum Analyzer		Tracking Generator					
Type	Ch	Frequency (MHz)	Band	Type	Pol.	Reading (dBuV)	Max (V,H) dBuV	Pol. Tx-Rx	Reading (dBm)	Corrected Reading (relative to Isotropic Radiator)		Limit (dBm)	Diff to Limit (dB)
										(dBm)	(W)		
F0	25	1851.25	1900	Horn	V	87.56	87.56	V-V	-11.35	26.28	0.42	33.00	-6.72
F0	25	1851.25	1900	Horn	H	80.47		H-H	-10.10				
F0	600	1880.00	1900	Horn	V	88.1	88.1	V-V	-10.19	27.29	0.54	33.00	-5.71
F0	600	1880.00	1900	Horn	H	80.1		H-H	-8.99				
F0	1175	1908.75	1900	Horn	V	87.53	87.53	V-V	-10.89	26.54	0.45	33.00	-6.46
F0	1175	1908.75	1900	Horn	H	80.03		H-H	-9.78				

Test Report No. RTS-1765-0907-21	Dates of Test July 23 to August 24, 2009	Author Data Michael Cino
--------------------------------------------	----------------------------------------------------	------------------------------------

Radiated Power Test Data Results cont'd

PCS Band

1xEVDO

The BlackBerry® smartphone PIN 30C435AD was in standalone, USB down position.
 Test Distance was 3.0 metres.

								Substitution Method					
EUT				Receive Antenna		Spectrum Analyzer		Tracking Generator					
Type	Ch	Frequency (MHz)	Band	Type	Pol.	Reading (dBuV)	Max (V,H) dBuV	Pol. Tx-Rx	Reading (dBm)	Corrected Reading (relative to Isotropic Radiator)		Limit (dBm)	Diff to Limit (dB)
										(dBm)	(W)		
F0	25	1851.25	1900	Horn	V	87.72	87.72	V-V	-11.19	26.43	0.44	33.00	-6.57
F0	25	1851.25	1900	Horn	H	80.12		H-H	-9.95				
F0	600	1880.00	1900	Horn	V	88.66	88.66	V-V	-9.68	27.84	0.61	33.00	-5.16
F0	600	1880.00	1900	Horn	H	80.33		H-H	-8.44				
F0	1175	1908.75	1900	Horn	V	88.12	88.12	V-V	-10.29	27.13	0.52	33.00	-5.87
F0	1175	1908.75	1900	Horn	H	80.38		H-H	-9.19				

		EMI Test Report for the BlackBerry® smartphone Model RCK71CW APPENDIX 4B	
Test Report No. RTS-1765-0907-21	Dates of Test July 23 to August 24, 2009	Author Data Michael Cino	

Radiated Emissions Test Data Results

Cellular Band

Loopback Service

Date of Test: July 24, 2009

The following measurements were performed by Andrew Fleming.

The environmental test conditions were: Temperature: 23 °C
 Pressure: 1007 mb
 Relative Humidity: 32 %

Test Distance was 3.0 metres with a height of 1.0 metres, 30 MHz to 1000 MHz.
 The BlackBerry® smartphone PIN 30C2BF78 was in standalone, vertical position.

The following measurements were performed in Cellular Tx mode on channels 1013, 384 and 777.

All emissions had a test margin greater than 25.0 dB.

The following measurements were performed by Savtej Sandhu.

Date of Test: July 23 – July 30, 2009

The environmental test conditions were: Temperature: 24 – 28 °C
 Pressure: 1008 – 1014 mb
 Relative Humidity: 26 – 30 %

Test Distance was 3.0 metres with a height of 1.0 metres, 1 GHz to 9 GHz.
 The BlackBerry® smartphone PIN 30C2BF79 was in standalone, vertical top-down position.
 The following measurements were performed in CDMA Cellular Tx mode on channels 1013, 384 and 777.

Frequency (MHz)	Channel	Antenna		Test Angle (Deg.)	Detector (PK or QP)	Measured Level (dBµV)	Correction Factor for preamp/antenna/ cables/ filter (dB)	Field Strength Level (reading+corr) (dBm)	Limit @ 3.0 m (dBm)	Test Margin (dB)
		Pol. (V/H)	Height (metres)							
2510.584	384	H	1.00	184.00	PK	53.41	-88.47	-35.06	-13.00	-22.06
2544.026	777	H	4.03	15.00	PK	51.64	-88.08	-36.45	-13.00	-23.45

All other emissions had a test margin greater than 25.0 dB.

		EMI Test Report for the BlackBerry® smartphone Model RCK71CW APPENDIX 4B	
Test Report No. RTS-1765-0907-21	Dates of Test July 23 to August 24, 2009	Author Data Michael Cino	

Radiated Emissions Test Data Results cont'd

Cellular Band

Test Data

Date of Test: July 24, 2009

The following measurements were performed by Andrew Fleming.

The environmental test conditions were: Temperature: 23 °C
 Pressure: 1007 mb
 Relative Humidity: 32 %

Test Distance was 3.0 metres with a height of 1.0 metres, 30 MHz to 1000 MHz.
 The BlackBerry® smartphone PIN 30C2BF78 was in standalone, vertical position.

The following measurements were performed in Cellular Tx mode on channels 1013, 384 and 777.

All emissions had a test margin greater than 25.0 dB.

The following measurements were performed by Savtej Sandhu.

Date of Test: July 23 – July 30, 2009

The environmental test conditions were: Temperature: 24 – 28 °C
 Pressure: 1008 – 1014 mb
 Relative Humidity: 26 – 30 %

Test Distance was 3.0 metres with a height of 1.0 metres, 1 GHz to 9 GHz.
 The BlackBerry® smartphone PIN 30C2BF79 was in standalone, vertical top-down position.
 The following measurements were performed in CDMA Cellular Tx mode on channels 1013, 384 and 777.

Frequency (MHz)	Channel	Antenna		Test Angle (Deg.)	Detector (PK or QP)	Measured Level (dBµV)	Correction Factor for preamp/antenna/cables/ filter (dB)	Field Strength Level (reading+corr) (dBm)	Limit @ 3.0 m (dBm)	Test Margin (dB)
		Pol. (V/H)	Height (metres)							
2509.610	384	H	1.00	198.00	PK	52.08	-88.47	-36.39	-13.00	-23.39

All other emissions had a test margin greater than 25.0 dB.

		EMI Test Report for the BlackBerry® smartphone Model RCK71CW APPENDIX 4B	
Test Report No. RTS-1765-0907-21	Dates of Test July 23 to August 24, 2009	Author Data Michael Cino	

Radiated Emissions Test Data Results cont'd

Cellular Band

1xEVDO

Date of Test: July 24, 2009

The following measurements were performed by Andrew Fleming.

The environmental test conditions were: Temperature: 23 °C
 Pressure: 1007 mb
 Relative Humidity: 32 %

Test Distance was 3.0 metres with a height of 1.0 metres, 30 MHz to 1000 MHz.
 The BlackBerry® smartphone PIN 30C2BF78 was in standalone, vertical position.

The following measurements were performed in Cellular Tx mode on channels 1013, 384 and 777.

All emissions had a test margin greater than 25.0 dB.

The following measurements were performed by Savtej Sandhu.

Date of Test: July 23 – July 30, 2009

The environmental test conditions were: Temperature: 24 – 28 °C
 Pressure: 1008 – 1014 mb
 Relative Humidity: 26 – 30 %

Test Distance was 3.0 metres with a height of 1.0 metres, 1 GHz to 9 GHz.
 The BlackBerry® smartphone PIN 30C2BF79 was in standalone, vertical top-down position.
 The following measurements were performed in CDMA Cellular Tx mode on channels 1013, 384 and 777.

Frequency (MHz)	Channel	Antenna		Test Angle (Deg.)	Detector (PK or QP)	Measured Level (dBµV)	Correction Factor for preamp/antenna/ cables/ filter (dB)	Field Strength Level (reading+corr) (dBm)	Limit @ 3.0 m (dBm)	Test Margin (dB)
		Pol. (V/H)	Height (metres)							
2474.221	1013	H	4.00	166.00	PK	56.66	-87.85	-31.20	-13.00	-18.20
2509.304	384	H	1.00	170.00	PK	60.13	-88.47	-28.34	-13.00	-15.34
2546.128	777	H	1.00	158.00	PK	55.54	-88.20	-32.66	-13.00	-19.66

All other emissions had a test margin greater than 25.0 dB.

		EMI Test Report for the BlackBerry® smartphone Model RCK71CW APPENDIX 4B	
Test Report No. RTS-1765-0907-21	Dates of Test July 23 to August 24, 2009	Author Data Michael Cino	

Radiated Emissions Test Data Results cont'd

PCS Band

Loopback Service

Date of Test: July 24, 2009

The following measurements were performed by Andrew Fleming.

The environmental test conditions were: Temperature: 23 °C
 Pressure: 1007 mb
 Relative Humidity: 32 %

Test Distance was 3.0 metres with a height of 1.0 metres, 30 MHz to 1000 MHz.
 The BlackBerry® smartphone PIN 30C2BF78 was in standalone, vertical position.

The following measurements were performed in PCS Tx mode on channels 25, 600 and 1175.

All emissions had a test margin greater than 25.0 dB.

The following measurements were performed by Savtej Sandhu.

Date of Test: July 29 – August 04, 2009

The environmental test conditions were: Temperature: 26 – 28 °C
 Relative Humidity: 25 – 27 %
 Pressure: 1008 – 1011 mb

Test Distance was 3.0 metres with a height of 1.0 metres, 1 GHz to 20 GHz.
 The BlackBerry® smartphone PIN 30C2BF79 was in standalone, USB up position.

The following measurements were performed in PCS Tx mode on channels 25, 600 and 1175.

Frequency (MHz)	Channel	Antenna		Test Angle (Deg.)	Detector (PK or QP)	Measured Level (dBµV)	Correction Factor for preamp/antenna/ cables/ filter (dB)	Field Strength Level (reading+corr) (dBm)	Limit @ 3.0 m (dBm)	Test Margin (dB)
		Pol. (V/H)	Height (metres)							
3759.351	600	V	3.45	225.00	PK	49.04	-80.83	-31.79	-13.00	-18.79
3817.744	1175	H	1.00	47.00	PK	51.76	-81.73	-29.97	-13.00	-16.97

All other emissions had a test margin greater than 25.0 dB.

	EMI Test Report for the BlackBerry® smartphone Model RCK71CW APPENDIX 4B	
Test Report No. RTS-1765-0907-21	Dates of Test July 23 to August 24, 2009	Author Data Michael Cino

Radiated Emissions Test Data Results cont'd

PCS Band

Test Data

Date of Test: July 24, 2009

The following measurements were performed by Andrew Fleming.

The environmental test conditions were: Temperature: 23 °C
Pressure: 1007 mb
Relative Humidity: 32 %

Test Distance was 3.0 metres with a height of 1.0 metres, 30 MHz to 1000 MHz.
The BlackBerry® smartphone PIN 30C2BF78 was in standalone, vertical position.

The following measurements were performed in PCS Tx mode on channels 25, 600 and 1175.

All emissions had a test margin greater than 25.0 dB.

The following measurements were performed by Savtej Sandhu.

Date of Test: July 29 – August 04, 2009

The environmental test conditions were: Temperature: 26 – 28 °C
Relative Humidity: 25 – 27 %
Pressure: 1008 – 1011 mb

Test Distance was 3.0 metres with a height of 1.0 metres, 1 GHz to 20 GHz.
The BlackBerry® smartphone PIN 30C2BF79 was in standalone, USB up position.

The following measurements were performed in PCS Tx mode on channels 25, 600 and 1175.

All emissions had a test margin greater than 25.0 dB.

		EMI Test Report for the BlackBerry® smartphone Model RCK71CW APPENDIX 4B	
Test Report No. RTS-1765-0907-21	Dates of Test July 23 to August 24, 2009	Author Data Michael Cino	

Radiated Emissions Test Data Results cont'd

PCS Band

1xEVDO

Date of Test: July 24, 2009

The following measurements were performed by Andrew Fleming.

The environmental test conditions were: Temperature: 23 °C
 Pressure: 1007 mb
 Relative Humidity: 32 %

Test Distance was 3.0 metres with a height of 1.0 metres, 30 MHz to 1000 MHz.
 The BlackBerry® smartphone PIN 30C2BF78 was in standalone, vertical position.

The following measurements were performed in PCS Tx mode on channels 25, 600 and 1175.

All emissions had a test margin greater than 25.0 dB.

The following measurements were performed by Savtej Sandhu.

Date of Test: July 29 – August 04, 2009

The environmental test conditions were: Temperature: 26 – 28 °C
 Relative Humidity: 25 – 27 %
 Pressure: 1008 – 1011 mb

Test Distance was 3.0 metres with a height of 1.0 metres, 1 GHz to 20 GHz.
 The BlackBerry® smartphone PIN 30C2BF79 was in standalone, USB up position.
 The following measurements were performed in PCS Tx mode on channels 25, 600 and 1175.

Frequency (MHz)	Channel	Antenna		Test Angle (Deg.)	Detector (PK or QP)	Measured Level (dBµV)	Correction Factor for preamp/antenna/cables/ filter (dB)	Field Strength Level (reading+corr) (dBm)	Limit @ 3.0 m (dBm)	Test Margin (dB)
		Pol. (V/H)	Height (metres)							
3817.176	1175	V	1.00	61.00	PK	52.31	-80.73	-28.42	-13.00	-15.42

All other emissions had a test margin greater than 25.0 dB.