

<b>RTS</b> RIM Testing Services	Document <b>Annex B to Hearing Aid Compatibility RF Emissions Test Report for the BlackBerry® Smartphone model RCD21IN</b>		Page 1(31)
	Author Data <b>Daoud Attayi</b>	Dates of Test <b>June 25, Oct 23-24, 2008</b>	Report No <b>RTS-1271-0810-32</b>

## **Annex B: Probe and dipole description and calibration certificates**

### **B.1 Probe, measurement chain description, specification and calibration certificate**

<b>RTS</b> RIM Testing Services	Document <b>Annex B to Hearing Aid Compatibility RF Emissions Test Report for the BlackBerry® Smartphone model RCD21IN</b>		Page 2(31)
	Author Data <b>Daoud Attayi</b>	Dates of Test <b>June 25, Oct 23-24, 2008</b>	Report No <b>RTS-1271-0810-32</b>

DASY Dosimetric Assessment System by Schmid & Partner Engineering AG

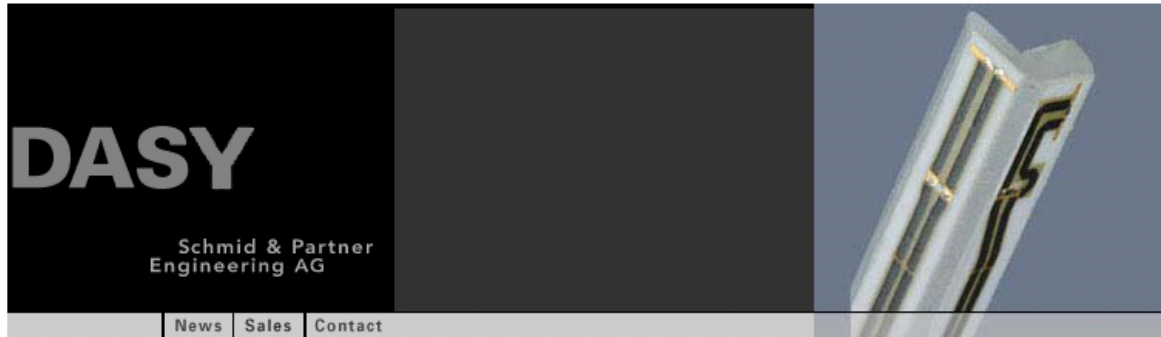

<b>Applications</b>
<b>Support &amp; Downloads</b>
<b>Products</b>
▪ DASY4 Packages
▪ EASY4
▪ Probes
ET3DV6 - Isotropic Dos-Probe
ES3DV3 - Isotropic Dos-Probe
EX3DV4 - Isotropic Dos-Probe
ET1DV3 - D-Probe
EUV3 - Universal Vector E-Probe
H3DV6 - Isotropic H-Probe
HUV4 - Universal Vector H-Probe
T1V3 - Temp-Probe
DP1 - Dummy-Probe
▪ Data Acquisition System
▪ Software
▪ Phantoms
▪ Robots
▪ Validation Kits & Calibration Dipoles
▪ Hearing Aid Compatibility (HAC) Ext
▪ Tissue Simulating Liquids
<b>SPEAG Home</b>

### ER3DV6 ISOTROPIC E-FIELD PROBE FOR GENERAL NEAR-FIELD MEASUREMENTS

[Download Product Flyer \(PDF, 192kB\)](#)

<b>Construction</b>	One dipole parallel, two dipoles normal to probe axis Built-in shielding against static charges PEEK enclosure material (resistant to organic solvents, e.g., glycoether)
<b>Calibration</b>	In air from 100 MHz to 3.0 GHz (absolute accuracy $\pm 6.0\%$ , $k=2$ )
<b>Frequency</b>	100 MHz to $> 6$ GHz; Linearity: $\pm 0.2$ dB (100 MHz to 3 GHz)
<b>Directivity</b>	$\pm 0.2$ dB in air (rotation around probe axis) $\pm 0.4$ dB in air (rotation normal to probe axis)
<b>Dynamic Range</b>	2 V/m to $> 1000$ V/m; Linearity: $\pm 0.2$ dB
<b>Dimensions</b>	Overall length: 330 mm (Tip: 16 mm) Tip diameter: 8 mm (Body: 12 mm) Distance from probe tip to dipole centers: 2.5 mm
<b>Application</b>	General near-field measurements up to 6 GHz Field component measurements Fast automatic scanning in phantoms

<http://www.dasy4.com/er3.htm>

<b>RTS</b> <b>RIM Testing Services</b>	Document <b>Annex B to Hearing Aid Compatibility RF Emissions Test Report for the BlackBerry® Smartphone model RCD21IN</b>		Page 3(31)
	Author Data <b>Daoud Attayi</b>	Dates of Test <b>June 25, Oct 23-24, 2008</b>	Report No <b>RTS-1271-0810-32</b>

DASY Dosimetric Assessment System by Schmid & Partner Engineering AG

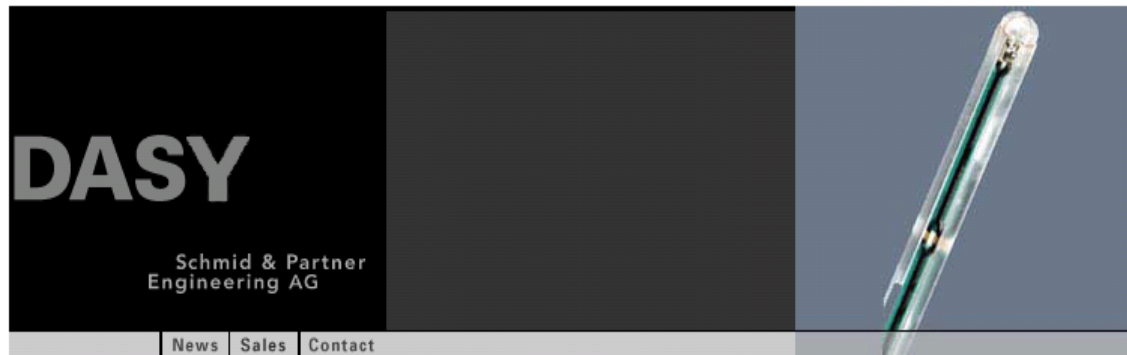

<b>Applications</b>
<b>Support &amp; Downloads</b>
<b>Products</b>
▪ DASY4 Packages
▪ EASY4
▪ Probes
ET3DV6 - Isotropic Dos-Probe
ES3DV3 - Isotropic Dos-Probe
EX3DV4 - Isotropic Dos-Probe
ET1DV3 - D-Probe
ER3DV6 - Isotropic E-Probe
EUV3 - Universal Vector E-Probe
HUV4 - Universal Vector H-Probe
T1V3 - Temp-Probe
DP1 - Dummy-Probe
▪ Data Acquisition System
▪ Software
▪ Phantoms
▪ Robots
▪ Validation Kits & Calibration Dipoles
▪ Hearing Aid Compatibility (HAC) Ext
▪ Tissue Simulating Liquids
<b>SPEAG Home</b>

### H3DV6 3-DIMENSIONAL H-FIELD PROBE FOR SMALL BAND APPLICATIONS

 [Download Product Flyer \(PDF, 192kB\)](#)

<b>Construction</b>	Three concentric loop sensors with 3.8 mm loop diameters Resistively loaded detector diodes for linear response Built-in shielding against static charges PEEK enclosure material (resistant to organic solvents, e.g., glycoether)
<b>Frequency</b>	200 MHz to 3 GHz (absolute accuracy $\pm 6.0\%$ , $k=2$ ); Output linearized
<b>Directivity</b>	$\pm 0.25$ dB (spherical isotropy error)
<b>Dynamic Range</b>	10 mA/m to 2 A/m at 1 GHz
<b>E-Field Interference</b>	< 10% at 3 GHz (for plane wave)
<b>Dimensions</b>	Overall length: 330 mm (Tip: 40 mm) Tip diameter: 6 mm (Body: 12 mm) Distance from probe tip to dipole centers: 3 mm
<b>Application</b>	General magnetic near-field measurements up to 3 GHz Field component measurements Surface current measurements Measurements in air or liquids Low interaction with the measured field

<http://www.dasy4.com/h3d.htm>

<b>RTS</b> <b>RIM Testing Services</b>	Document <b>Annex B to Hearing Aid Compatibility RF Emissions Test Report for the BlackBerry® Smartphone model RCD21IN</b>		Page 4(31)
	Author Data <b>Daoud Attayi</b>	Dates of Test <b>June 25, Oct 23-24, 2008</b>	Report No <b>RTS-1271-0810-32</b>

All measurements were performed to the nearest element point as per the C63.19 standard. Offset distances were entered in the DASY4 software so that the measurement was to the nearest element.

Figures 1 and 2, provided by the manufacturer, illustrate detail of the probe tip and its dimensions.

**ER3DV6** E-Field probe: The distances from the probe tip to the closest points on the dipole sensors are 1.45mm for X and Y and 1.25mm for Z. From the probe tip to the center of the sensors is 2.5mm.

**H3DV6** H-Field probe: The distance from the probe tip to the closest point of the X, Y and Z loop sensors is 1.1mm. From the probe tip to the center of the sensor is 3.00mm.



**E-Field Probe (ER3DV6)**

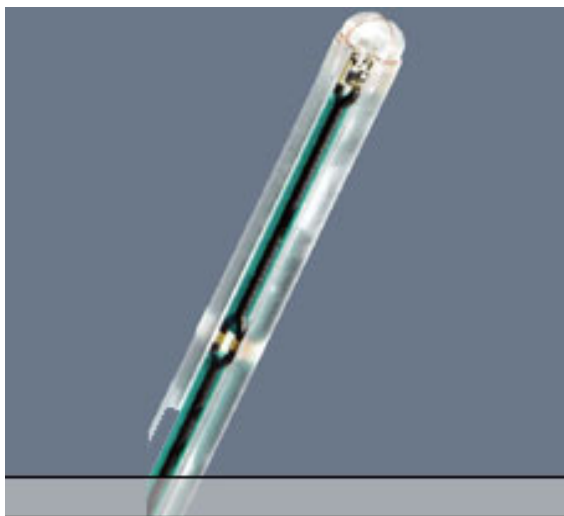
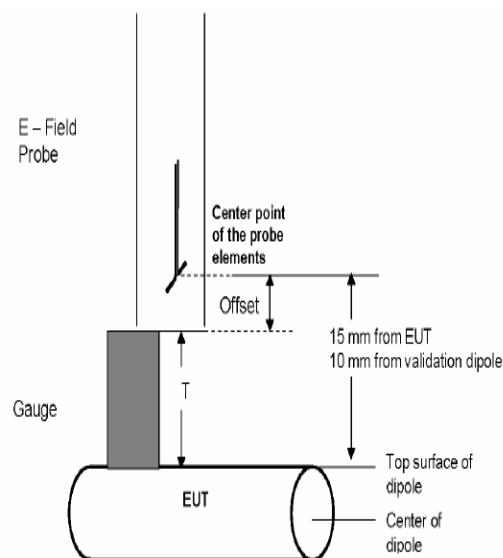

**H-Field Probe (H3DV6)**

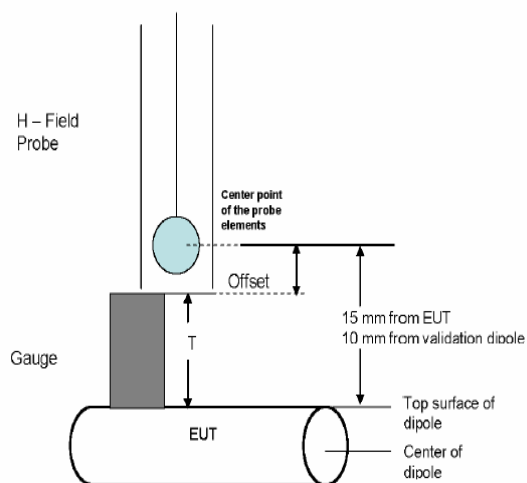

<b>RTS</b> <b>RIM Testing Services</b>	Document <b>Annex B to Hearing Aid Compatibility RF Emissions Test Report for the BlackBerry® Smartphone model RCD21IN</b>		Page 5(31)
	Author Data <b>Daoud Attayi</b>	Dates of Test <b>June 25, Oct 23-24, 2008</b>	Report No <b>RTS-1271-0810-32</b>

The following information is from the system manufacturer user manual describing the process chain:

The first step of the evaluation is a linearization of the filtered input signal to account for the compression characteristics of the detector diode. The compensation depends on the input signal, the diode type and the DC-transmission factor from the diode to the evaluation electronics. If the exciting field is pulsed, the crest factor of the signal must be known to correctly compensate for peak power. The formula for each channel can be given as:

$$V_i = U_i + U_i^2 \cdot \frac{cf}{dcp_i} \quad (20.1)$$

with  $V_i$  = compensated signal of channel i (i = x, y, z)  
 $U_i$  = input signal of channel i (i = x, y, z)  
 $cf$  = crest factor of exciting field (DASY parameter)  
 $dcp_i$  = diode compression point (DASY parameter)

From the compensated input signals the primary field data for each channel can be evaluated:

$$\text{E - fieldprobes : } E_i = \sqrt{\frac{V_i}{Norm_i \cdot ConvF}}$$

$$\text{H - fieldprobes : } H_i = \sqrt{V_i} \cdot \frac{a_{i0} + a_{i1}f + a_{i2}f^2}{f}$$

with  $V_i$  = compensated signal of channel i (i = x, y, z)  
 $Norm_i$  = sensor sensitivity of channel i (i = x, y, z)  
 $\mu\text{V}/(\text{V/m})^2$  for E-field Probes  
 $ConvF$  = sensitivity enhancement in solution  
 $a_{ij}$  = sensor sensitivity factors for H-field probes  
 $f$  = carrier frequency [GHz]  
 $E_i$  = electric field strength of channel i in V/m  
 $H_i$  = magnetic field strength of channel i in A/m

The RSS value of the field components gives the total field strength (Hermitian magnitude):

$$E_{tot} = \sqrt{E_x^2 + E_y^2 + E_z^2} \quad (20.2)$$

The measurement / integration time per point is > 500 ms, as per the system manufacturer:

The time response of the field probes has been assessed by exposing the probe to a well-controlled field producing signals larger than HAC E- and H-fields of class M4. The signal response time is evaluated as the time required by the system to reach 90% of the expected final value after an on/off switch of the power source with an integration time of 500 ms and a probe response time of <5 ms. In the current implementation, DASY4 waits longer than 100 ms after having reached the grid point before starting a measurement, i.e., the response time uncertainty is negligible.

If the device under test does not emit a CW signal, the integration time applied to measure the electric field at a specific point may introduce additional uncertainties due to the discretization. The tolerances for the different systems had the worst-case of 2.6%.

<b>RTS</b> <b>RIM Testing Services</b>	Document <b>Annex B to Hearing Aid Compatibility RF Emissions Test Report for the BlackBerry® Smartphone model RCD21IN</b>		Page 6(31)
	Author Data <b>Daoud Attayi</b>	Dates of Test <b>June 25, Oct 23-24, 2008</b>	Report No <b>RTS-1271-0810-32</b>

**Calibration Laboratory of Schmid & Partner Engineering AG**  
 Zeughausstrasse 43, 8004 Zurich, Switzerland



**S** Schweizerischer Kalibrierdienst  
**S** Service suisse d'étalonnage  
**C** Servizio svizzero di taratura  
**S** Swiss Calibration Service

Accredited by the Swiss Accreditation Service (SAS)  
 The Swiss Accreditation Service is one of the signatories to the EA  
 Multilateral Agreement for the recognition of calibration certificates

Accreditation No.: **SCS 108**

Client: **RIM** Certificate No: **ER3-2285\_Mar08**

**CALIBRATION CERTIFICATE**

Object: **ER3DV6 - SN:2285**  
 Calibration procedure(s): **QA CAL-02.v5**  
 Calibration procedure for E-field probes optimized for close near field evaluations in air  
 Calibration date: **March 7, 2008**  
 Condition of the calibrated item: **In Tolerance**

This calibration certificate documents the traceability to national standards, which realize the physical units of measurements (SI).  
 The measurements and the uncertainties with confidence probability are given on the following pages and are part of the certificate.

All calibrations have been conducted in the closed laboratory facility: environment temperature (22 ± 3)°C and humidity < 70%.

Calibration Equipment used (M&TE critical for calibration)

Primary Standards	ID #	Cal Date (Calibrated by, Certificate No.)	Scheduled Calibration
Power meter E4419B	GB41293874	29-Mar-07 (METAS, No. 217-00670)	Mar-08
Power sensor E4412A	MY41495277	29-Mar-07 (METAS, No. 217-00670)	Mar-08
Power sensor E4412A	MY41498087	29-Mar-07 (METAS, No. 217-00670)	Mar-08
Reference 3 dB Attenuator	SN: S5054 (3c)	8-Aug-07 (METAS, No. 217-00719)	Aug-08
Reference 20 dB Attenuator	SN: S5086 (20b)	29-Mar-07 (METAS, No. 217-00671)	Mar-08
Reference 30 dB Attenuator	SN: S5129 (30b)	8-Aug-07 (METAS, No. 217-00720)	Aug-08
Reference Probe ER3DV6	SN: 2328	2-Oct-07 (SPEAG, No. ER3-2328_Oct07)	Oct-08
DAE4	SN: 654	20-Apr-07 (SPEAG, No. DAE4-654_Apr07)	Apr-08
Secondary Standards	ID #	Check Date (in house)	Scheduled Check
RF generator HP 8648C	US3642U01700	4-Aug-99 (SPEAG, in house check Oct-07)	In house check: Oct-09
Network Analyzer HP 8753E	US37390585	18-Oct-01 (SPEAG, in house check Oct-07)	In house check: Oct-08

Calibrated by: **Katja Pokovic** (Technical Manager) [Signature]  
 Approved by: **Niels Kuster** (Quality Manager) [Signature]

Issued: March 8, 2008

This calibration certificate shall not be reproduced except in full without written approval of the laboratory.

<b>RTS</b> <b>RIM Testing Services</b>	Document <b>Annex B to Hearing Aid Compatibility RF Emissions Test Report for the BlackBerry® Smartphone model RCD21IN</b>		Page 7(31)
	Author Data <b>Daoud Attayi</b>	Dates of Test <b>June 25, Oct 23-24, 2008</b>	Report No <b>RTS-1271-0810-32</b>

**Calibration Laboratory of Schmid & Partner Engineering AG**  
 Zeughausstrasse 43, 8004 Zurich, Switzerland



**S** Schweizerischer Kalibrierdienst  
**S** Service suisse d'étalonnage  
**C** Servizio svizzero di taratura  
**S** Swiss Calibration Service

Accredited by the Swiss Accreditation Service (SAS)  
 The Swiss Accreditation Service is one of the signatories to the EA  
 Multilateral Agreement for the recognition of calibration certificates

Accreditation No.: **SCS 108**

**Glossary:**

**NORM<sub>x,y,z</sub>** sensitivity in free space  
**DCP** diode compression point  
**Polarization  $\phi$**   $\phi$  rotation around probe axis  
**Polarization  $\vartheta$**   $\vartheta$  rotation around an axis that is in the plane normal to probe axis (at measurement center), i.e.,  $\vartheta = 0$  is normal to probe axis  
**Connector Angle** information used in DASY system to align probe sensor X to the robot coordinate system

**Calibration is Performed According to the Following Standards:**

- a) IEEE Std 1309-2005, " IEEE Standard for calibration of electromagnetic field sensors and probes, excluding antennas, from 9 kHz to 40 GHz", December 2005.

**Methods Applied and Interpretation of Parameters:**

- **NORM<sub>x,y,z</sub>**: Assessed for E-field polarization  $\vartheta = 0$  for XY sensors and  $\vartheta = 90$  for Z sensor ( $f \leq 900$  MHz in TEM-cell;  $f > 1800$  MHz: R22 waveguide).
- **NORM(f)<sub>x,y,z</sub> = NORM<sub>x,y,z</sub> \* frequency\_response** (see Frequency Response Chart).
- **DCP<sub>x,y,z</sub>**: DCP are numerical linearization parameters assessed based on the data of power sweep (no uncertainty required). DCP does not depend on frequency.
- **Spherical isotropy (3D deviation from isotropy)**: in a locally homogeneous field realized using an open waveguide setup.
- **Sensor Offset**: The sensor offset corresponds to the offset of virtual measurement center from the probe tip (on probe axis). No tolerance required.
- **Connector Angle**: The angle is assessed using the information gained by determining the **NORM<sub>x</sub>** (no uncertainty required).

<b>RTS</b> RIM Testing Services	Document <b>Annex B to Hearing Aid Compatibility RF Emissions Test Report for the BlackBerry® Smartphone model RCD21IN</b>		Page 8(31)
	Author Data <b>Daoud Attayi</b>	Dates of Test <b>June 25, Oct 23-24, 2008</b>	Report No <b>RTS-1271-0810-32</b>

ER3DV6 SN:2285

March 7, 2008

# Probe ER3DV6

## SN:2285

Manufactured: September 20, 2002  
Last calibrated: March 12, 2007  
Recalibrated: March 7, 2008

Calibrated for DASY Systems

(Note: non-compatible with DASY2 system!)



<b>RTS</b> RIM Testing Services	Document <b>Annex B to Hearing Aid Compatibility RF Emissions Test Report for the BlackBerry® Smartphone model RCD21IN</b>		Page 9(31)
	Author Data <b>Daoud Attayi</b>	Dates of Test <b>June 25, Oct 23-24, 2008</b>	Report No <b>RTS-1271-0810-32</b>

ER3DV6 SN:2285

March 7, 2008

**DASY - Parameters of Probe: ER3DV6 SN:2285**

Sensitivity in Free Space [ $\mu\text{V}/(\text{V}/\text{m})^2$ ]		Diode Compression <sup>A</sup>	
NormX	1.24 ± 10.1 % (k=2)	DCP X	93 mV
NormY	1.40 ± 10.1 % (k=2)	DCP Y	93 mV
NormZ	1.59 ± 10.1 % (k=2)	DCP Z	98 mV

Frequency Correction

X	0.0
Y	0.0
Z	0.0

Sensor Offset (Probe Tip to Sensor Center)

X	2.5 mm
Y	2.5 mm
Z	2.5 mm

Connector Angle -278 °

The reported uncertainty of measurement is stated as the standard uncertainty of measurement multiplied by the coverage factor k=2, which for a normal distribution corresponds to a coverage probability of approximately 95%.

<sup>A</sup> numerical linearization parameter; uncertainty not required

<b>RTS</b> RIM Testing Services	Document <b>Annex B to Hearing Aid Compatibility RF Emissions Test Report for the BlackBerry® Smartphone model RCD21IN</b>		Page 10(31)
	Author Data <b>Daoud Attayi</b>	Dates of Test <b>June 25, Oct 23-24, 2008</b>	Report No <b>RTS-1271-0810-32</b>

ER3DV6 SN:2285

March 7, 2008

### Frequency Response of E-Field

(TEM-Cell:ifi110 EXX, Waveguide R22)

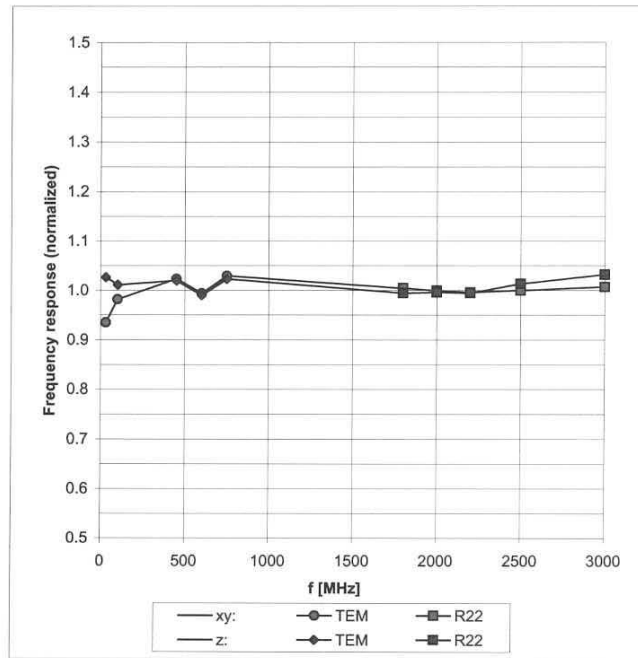

Uncertainty of Frequency Response of E-field:  $\pm 6.3\%$  (k=2)

<b>RTS</b> RIM Testing Services	Document <b>Annex B to Hearing Aid Compatibility RF Emissions Test Report for the BlackBerry® Smartphone model RCD21IN</b>		Page 11(31)
	Author Data <b>Daoud Attayi</b>	Dates of Test <b>June 25, Oct 23-24, 2008</b>	Report No <b>RTS-1271-0810-32</b>

ER3DV6 SN:2285

March 7, 2008

**Receiving Pattern ( $\phi$ ),  $\vartheta = 0^\circ$**

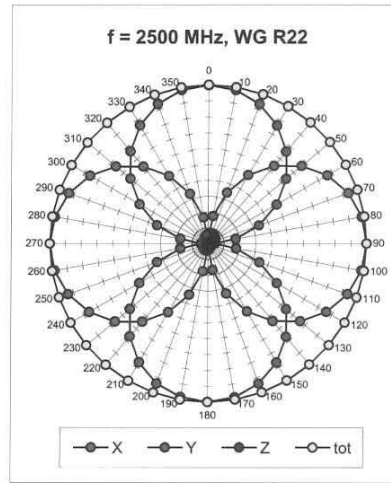
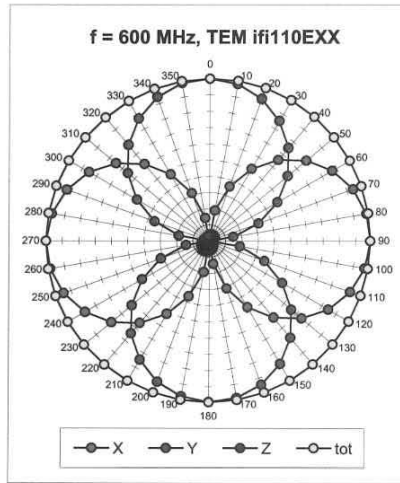

**Receiving Pattern ( $\phi$ ),  $\vartheta = 90^\circ$**

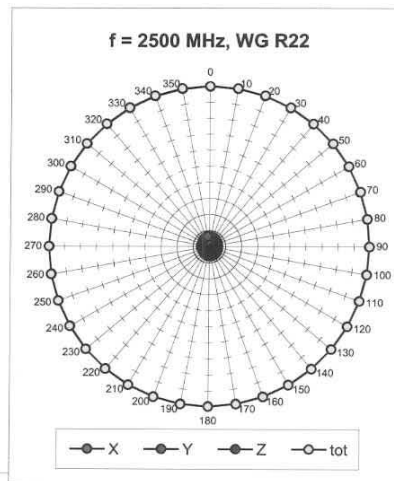
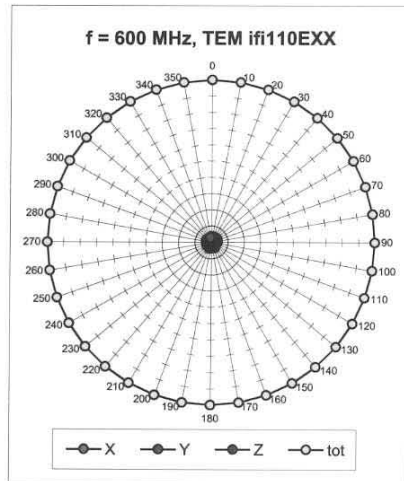

<b>RTS</b> RIM Testing Services	Document <b>Annex B to Hearing Aid Compatibility RF Emissions Test Report for the BlackBerry® Smartphone model RCD21IN</b>		Page 12(31)
	Author Data <b>Daoud Attayi</b>	Dates of Test <b>June 25, Oct 23-24, 2008</b>	Report No <b>RTS-1271-0810-32</b>

ER3DV6 SN:2285

March 7, 2008

### Receiving Pattern ( $\phi$ ), $\vartheta = 0^\circ$

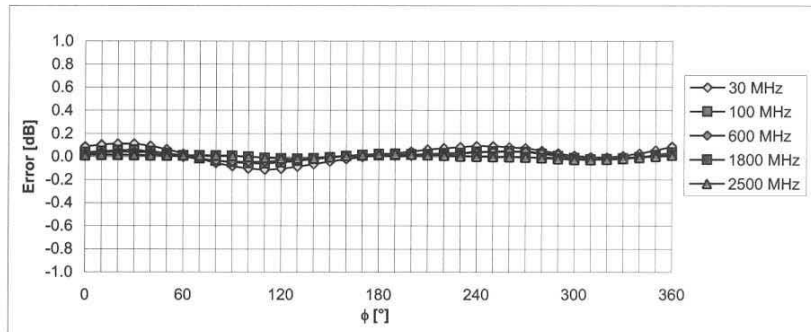

Uncertainty of Axial Isotropy Assessment:  $\pm 0.5\%$  ( $k=2$ )

### Receiving Pattern ( $\phi$ ), $\vartheta = 90^\circ$

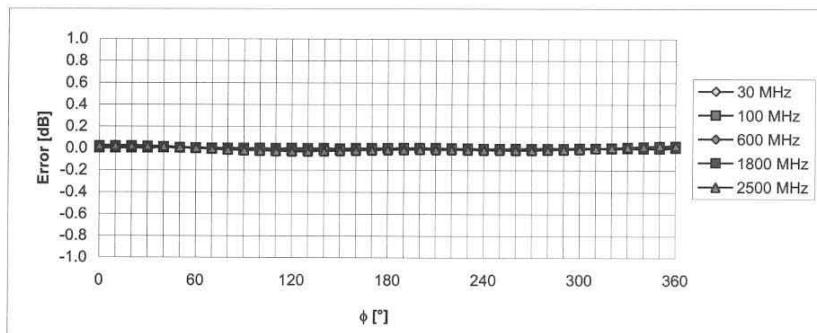

Uncertainty of Axial Isotropy Assessment:  $\pm 0.5\%$  ( $k=2$ )

<b>RTS</b> RIM Testing Services	Document <b>Annex B to Hearing Aid Compatibility RF Emissions Test Report for the BlackBerry® Smartphone model RCD21IN</b>		Page 13(31)
	Author Data <b>Daoud Attayi</b>	Dates of Test <b>June 25, Oct 23-24, 2008</b>	Report No <b>RTS-1271-0810-32</b>

ER3DV6 SN:2285

March 7, 2008

### Dynamic Range f(E-field) (Waveguide R22, f = 1800 MHz)

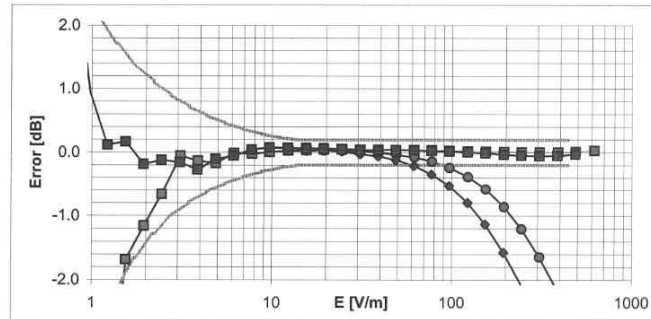
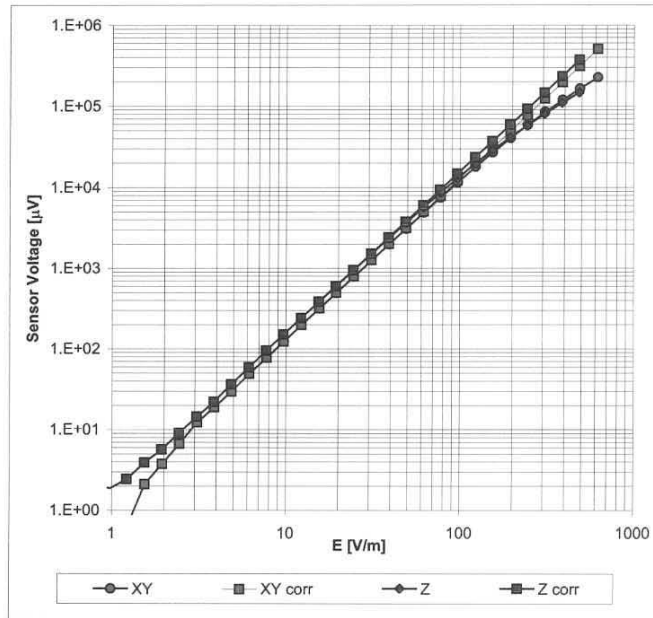

Uncertainty of Linearity Assessment:  $\pm 0.6\%$  (k=2)

<b>RTS</b> RIM Testing Services	Document <b>Annex B to Hearing Aid Compatibility RF Emissions Test Report for the BlackBerry® Smartphone model RCD21IN</b>		Page 14(31)
	Author Data <b>Daoud Attayi</b>	Dates of Test <b>June 25, Oct 23-24, 2008</b>	Report No <b>RTS-1271-0810-32</b>

ER3DV6 SN:2285

March 7, 2008

**Deviation from Isotropy in Air**  
**Error ( $\phi, \vartheta$ ),  $f = 900$  MHz**

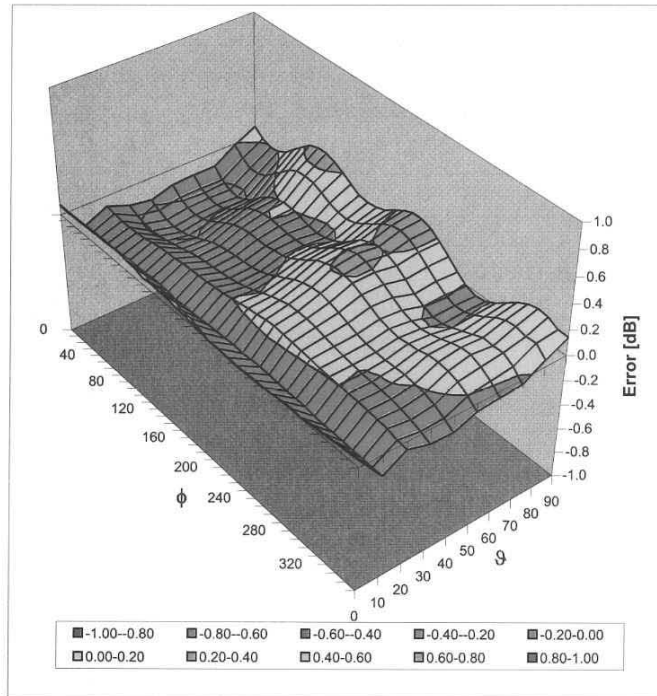

Uncertainty of Spherical Isotropy Assessment:  $\pm 2.6\%$  ( $k=2$ )

<b>RTS</b> <b>RIM Testing Services</b>	Document	<b>Annex B to Hearing Aid Compatibility RF Emissions Test Report for the BlackBerry® Smartphone model RCD21IN</b>		Page
	Author Data	Dates of Test	Report No	FCC ID
<b>Daoud Attayi</b>	<b>June 25, Oct 23-24, 2008</b>	<b>RTS-1271-0810-32</b>	<b>L6ARCD20IN</b>	

**Calibration Laboratory of Schmid & Partner Engineering AG**  
 Zeughausstrasse 43, 8004 Zurich, Switzerland



S Schweizerischer Kalibrierdienst  
 S Service suisse d'étalonnage  
 C Servizio svizzero di taratura  
 S Swiss Calibration Service

Accredited by the Swiss Accreditation Service (SAS)  
 The Swiss Accreditation Service is one of the signatories to the EA  
 Multilateral Agreement for the recognition of calibration certificates

Accreditation No.: SCS 108

Client **RIM**

Certificate No: ER3-2286\_Jan08

### CALIBRATION CERTIFICATE

Object: **ER3DV6 - SN:2286**  
 Calibration procedure(s): **QA CAL-02.v5  
 Calibration procedure for E-field probes optimized for close near field evaluations in air**  
 Calibration date: **January 21, 2008**  
 Condition of the calibrated item: **In Tolerance**

This calibration certificate documents the traceability to national standards, which realize the physical units of measurements (SI).  
 The measurements and the uncertainties with confidence probability are given on the following pages and are part of the certificate.

All calibrations have been conducted in the closed laboratory facility; environment temperature (22 ± 3)°C and humidity < 70%.

Calibration Equipment Used (M&TE critical for calibration)

Primary Standards	ID #	Cal Date (Calibrated by, Certificate No.)	Scheduled Calibration
Power meter E4419B	GB41293874	29-Mar-07 (METAS, No. 217-00670)	Mar-08
Power sensor E4412A	MY41495277	29-Mar-07 (METAS, No. 217-00670)	Mar-08
Power sensor E4412A	MY41498087	29-Mar-07 (METAS, No. 217-00670)	Mar-08
Reference 3 dB Attenuator	SN: S5054 (3c)	8-Aug-07 (METAS, No. 217-00719)	Aug-08
Reference 20 dB Attenuator	SN: S5086 (20b)	29-Mar-07 (METAS, No. 217-00671)	Mar-08
Reference 30 dB Attenuator	SN: S5129 (30b)	8-Aug-07 (METAS, No. 217-00720)	Aug-08
Reference Probe ER3DV6	SN: 2328	2-Oct-07 (SPEAG, No. ER3-2328_Oct07)	Oct-08
DAE4	SN: 654	20-Apr-07 (SPEAG, No. DAE4-654_Apr07)	Apr-08

Secondary Standards	ID #	Check Date (In house)	Scheduled Check
RF generator HP 8648C	US3642U01700	4-Aug-99 (SPEAG, in house check Oct-07)	In house check: Oct-09
Network Analyzer HP 8753E	US37390585	18-Oct-01 (SPEAG, in house check Oct-07)	In house check: Oct-08

	Name	Function	Signature
Calibrated by:	Katja Pokovic	Technical Manager	
Approved by:	Nils Kuster	Quality Manager	

Issued: January 21, 2008

This calibration certificate shall not be reproduced except in full without written approval of the laboratory.

Certificate No: ER3-2286\_Jan08

Page 1 of 9

<b>RTS</b> <b>RIM Testing Services</b>	Document <b>Annex B to Hearing Aid Compatibility RF Emissions Test Report for the BlackBerry® Smartphone model RCD21IN</b>		Page 16(31)
	Author Data <b>Daoud Attayi</b>	Dates of Test <b>June 25, Oct 23-24, 2008</b>	Report No <b>RTS-1271-0810-32</b>

**Calibration Laboratory of  
 Schmid & Partner  
 Engineering AG**  
 Zeughausstrasse 43, 8004 Zurich, Switzerland



**S** Schweizerischer Kalibrierdienst  
**C** Service suisse d'étalonnage  
**S** Servizio svizzero di taratura  
**S** Swiss Calibration Service

Accredited by the Swiss Accreditation Service (SAC)  
 The Swiss Accreditation Service is one of the signatories to the EA  
 Multilateral Agreement for the recognition of calibration certificates

Accreditation No.: **SCS 108**

**Glossary:**

**NORM<sub>x,y,z</sub>** sensitivity in free space  
**DCP** diode compression point  
**Polarization  $\phi$**   $\phi$  rotation around probe axis  
**Polarization  $\vartheta$**   $\vartheta$  rotation around an axis that is in the plane normal to probe axis (at measurement center), i.e.,  $\vartheta = 0$  is normal to probe axis  
**Connector Angle** information used in DASYS system to align probe sensor X to the robot coordinate system

**Calibration is Performed According to the Following Standards:**

- a) IEEE Std 1309-2005, "IEEE Standard for calibration of electromagnetic field sensors and probes, excluding antennas, from 9 kHz to 40 GHz", December 2005.

**Methods Applied and Interpretation of Parameters:**

- **NORM<sub>x,y,z</sub>**: Assessed for E-field polarization  $\vartheta = 0$  for XY sensors and  $\vartheta = 90$  for Z sensor ( $f \leq 900$  MHz in TEM-cell;  $f > 1800$  MHz: R22 waveguide).
- **NORM( $f$ )<sub>x,y,z</sub>** = **NORM<sub>x,y,z</sub>** \* *frequency\_response* (see Frequency Response Chart).
- **DCP<sub>x,y,z</sub>**: DCP are numerical linearization parameters assessed based on the data of power sweep (no uncertainty required). DCP does not depend on frequency.
- **Spherical isotropy (3D deviation from isotropy)**: in a locally homogeneous field realized using an open waveguide setup.
- **Sensor Offset**: The sensor offset corresponds to the offset of virtual measurement center from the probe tip (on probe axis). No tolerance required.
- **Connector Angle**: The angle is assessed using the information gained by determining the **NORM<sub>x</sub>** (no uncertainty required).



<b>RTS</b> RIM Testing Services	Document <b>Annex B to Hearing Aid Compatibility RF Emissions Test Report for the BlackBerry® Smartphone model RCD21IN</b>		Page 17(31)
	Author Data <b>Daoud Attayi</b>	Dates of Test <b>June 25, Oct 23-24, 2008</b>	Report No <b>RTS-1271-0810-32</b>

ER3DV6 SN:2286

January 21, 2008

# Probe ER3DV6

## SN:2286

Manufactured: September 19, 2002  
Last calibrated: January 10, 2007  
Recalibrated: January 21, 2008

Calibrated for DASYS Systems

(Note: non-compatible with DASYS2 system!)

<b>RTS</b> RIM Testing Services	Document <b>Annex B to Hearing Aid Compatibility RF Emissions Test Report for the BlackBerry® Smartphone model RCD21IN</b>		Page 18(31)
	Author Data <b>Daoud Attayi</b>	Dates of Test <b>June 25, Oct 23-24, 2008</b>	Report No <b>RTS-1271-0810-32</b>

ER3DV6 SN:2286

January 21, 2008

**DASY - Parameters of Probe: ER3DV6 SN:2286**

Sensitivity in Free Space [ $\mu\text{V}/(\text{V}/\text{m})^2$ ]		Diode Compression <sup>A</sup>	
NormX	2.20 ± 10.1 % (k=2)	DCP X	94 mV
NormY	1.44 ± 10.1 % (k=2)	DCP Y	94 mV
NormZ	1.54 ± 10.1 % (k=2)	DCP Z	95 mV

Frequency Correction

X	0.0
Y	0.0
Z	0.0

Sensor Offset (Probe Tip to Sensor Center)

X	2.5 mm
Y	2.5 mm
Z	2.5 mm

Connector Angle -187 °

The reported uncertainty of measurement is stated as the standard uncertainty of measurement multiplied by the coverage factor k=2, which for a normal distribution corresponds to a coverage probability of approximately 95%.

<sup>A</sup> numerical linearization parameter: uncertainty not required

<b>RTS</b> RIM Testing Services	Document <b>Annex B to Hearing Aid Compatibility RF Emissions Test Report for the BlackBerry® Smartphone model RCD21IN</b>		Page 19(31)
	Author Data <b>Daoud Attayi</b>	Dates of Test <b>June 25, Oct 23-24, 2008</b>	Report No <b>RTS-1271-0810-32</b>

ER3DV6 SN:2286

January 21, 2008

### Frequency Response of E-Field

(TEM-Cell:ifi110 EXX, Waveguide R22)

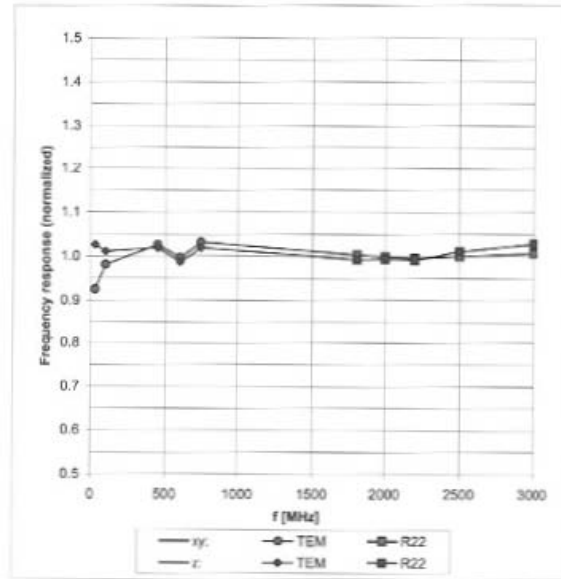

Uncertainty of Frequency Response of E-field:  $\pm 6.3\%$  (k=2)

<b>RTS</b> RIM Testing Services	Document <b>Annex B to Hearing Aid Compatibility RF Emissions Test Report for the BlackBerry® Smartphone model RCD21IN</b>		Page 20(31)
	Author Data <b>Daoud Attayi</b>	Dates of Test <b>June 25, Oct 23-24, 2008</b>	Report No <b>RTS-1271-0810-32</b>

ER3DV6 SN:2286

January 21, 2008

**Receiving Pattern ( $\phi$ ),  $\vartheta = 0^\circ$**

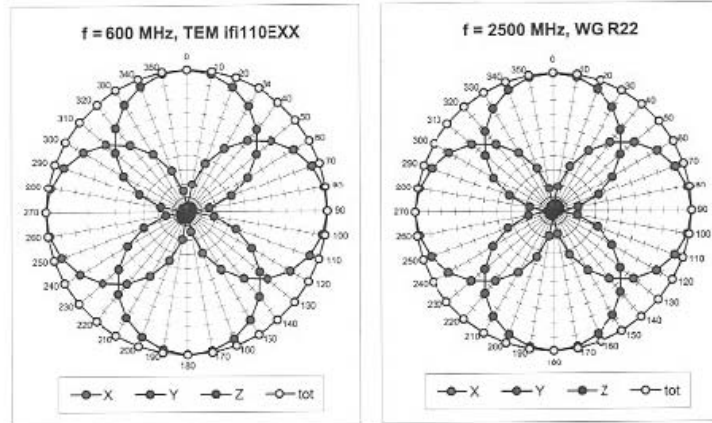

**Receiving Pattern ( $\phi$ ),  $\vartheta = 90^\circ$**

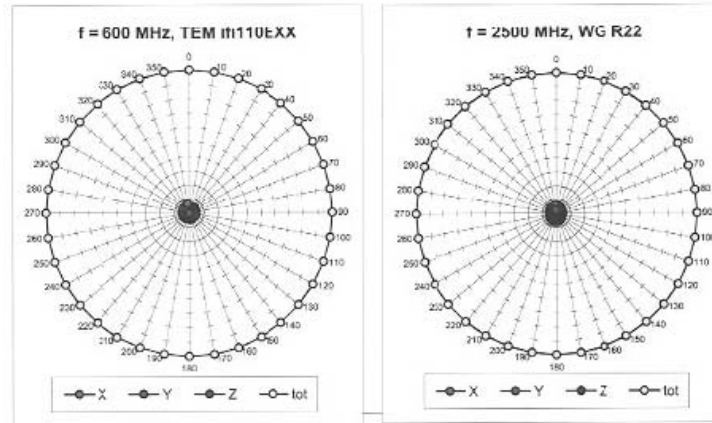

Certificate No: ER3-2286\_Jan08

Page 6 of 9

<b>RTS</b> RIM Testing Services	Document <b>Annex B to Hearing Aid Compatibility RF Emissions Test Report for the BlackBerry® Smartphone model RCD21IN</b>		Page 21(31)
	Author Data <b>Daoud Attayi</b>	Dates of Test <b>June 25, Oct 23-24, 2008</b>	Report No <b>RTS-1271-0810-32</b>

ER3DV6 SN:2286

January 21, 2008

Receiving Pattern ( $\phi$ ),  $\vartheta = 0^\circ$

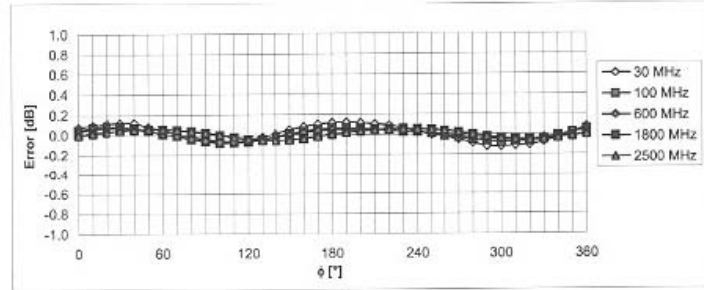

Uncertainty of Axial Isotropy Assessment:  $\pm 0.5\%$  ( $k=2$ )

Receiving Pattern ( $\phi$ ),  $\vartheta = 90^\circ$

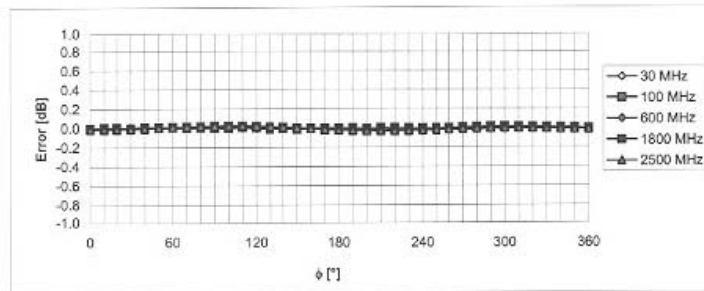

Uncertainty of Axial Isotropy Assessment:  $\pm 0.5\%$  ( $k=2$ )

<b>RTS</b> RIM Testing Services	Document <b>Annex B to Hearing Aid Compatibility RF Emissions Test Report for the BlackBerry® Smartphone model RCD21IN</b>		Page 22(31)
	Author Data <b>Daoud Attayi</b>	Dates of Test <b>June 25, Oct 23-24, 2008</b>	Report No <b>RTS-1271-0810-32</b>

ER3DV6 SN:2286

January 21, 2008

**Dynamic Range f(E-field)**  
(Waveguide R22, f = 1800 MHz)

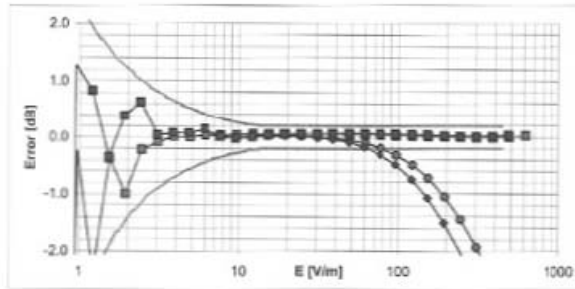
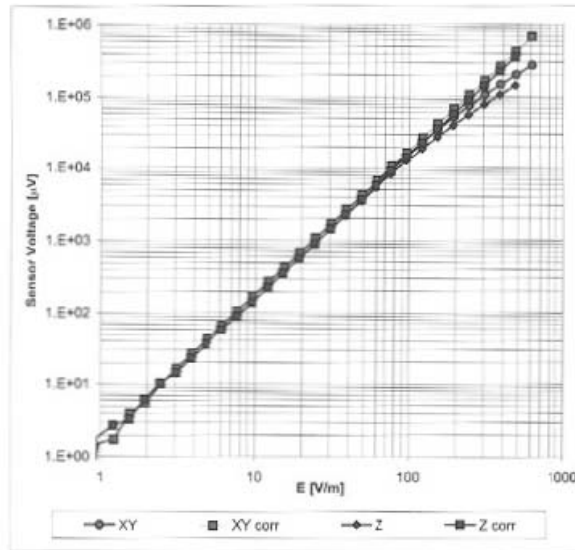

Uncertainty of Linearity Assessment: ± 0.6% (k=2)

<b>RTS</b> RIM Testing Services	Document <b>Annex B to Hearing Aid Compatibility RF Emissions Test Report for the BlackBerry® Smartphone model RCD21IN</b>		Page 23(31)
	Author Data <b>Daoud Attayi</b>	Dates of Test <b>June 25, Oct 23-24, 2008</b>	Report No <b>RTS-1271-0810-32</b>

ER3DV6 SN:2286

January 21, 2008

**Deviation from Isotropy in Air**  
**Error ( $\phi, \theta$ ),  $f = 900$  MHz**

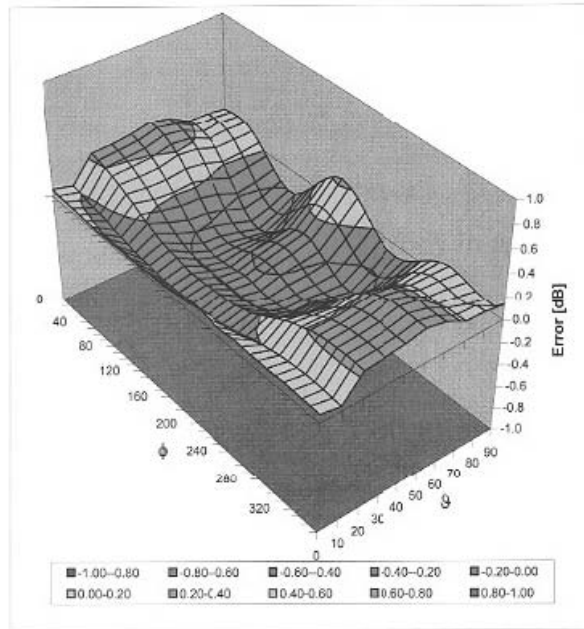

Uncertainty of Spherical Isotropy Assessment:  $\pm 2.6\%$  ( $k=2$ )

<b>RTS</b> RIM Testing Services	Document <b>Annex B to Hearing Aid Compatibility RF Emissions Test Report for the BlackBerry® Smartphone model RCD21IN</b>		Page 24(31)
	Author Data <b>Daoud Attayi</b>	Dates of Test <b>June 25, Oct 23-24, 2008</b>	Report No <b>RTS-1271-0810-32</b>
		FCC ID <b>L6ARCD20IN</b>	

**Calibration Laboratory of Schmid & Partner Engineering AG**  
Zeughausstrasse 43, 8004 Zurich, Switzerland



**S** Schweizerischer Kalibrierdienst  
**S** Service suisse d'étalonnage  
**C** Servizio svizzero di taratura  
**S** Swiss Calibration Service

Accredited by the Swiss Accreditation Service (SAS)  
The Swiss Accreditation Service is one of the signatories to the EA Multilateral Agreement for the recognition of calibration certificates

Accreditation No.: **SCS 108**

Client **RIM**

Certificate No: **H3-6105\_Nov07**

### CALIBRATION CERTIFICATE

Object	<b>H3DV6 - SN:6105</b>
Calibration procedure(s)	<b>QA CAL-03.v5 Calibration procedure for H-field probes optimized for close near field evaluations in air</b>
Calibration date:	<b>November 9, 2007</b>
Condition of the calibrated item	<b>In Tolerance</b>

This calibration certificate documents the traceability to national standards, which realize the physical units of measurements (SI). The measurements and the uncertainties with confidence probability are given on the following pages and are part of the certificate.

All calibrations have been conducted in the closed laboratory facility: environment temperature (22 ± 3)°C and humidity < 70%.

Calibration Equipment used (M&TE critical for calibration)

Primary Standards	ID #	Cal Date (Calibrated by, Certificate No.)	Scheduled Calibration
Power meter E4419B	GB41293874	29-Mar-07 (METAS, No. 217-00670)	Mar-08
Power sensor E4412A	MY41495277	29-Mar-07 (METAS, No. 217-00670)	Mar-08
Power sensor E4412A	MY41498087	29-Mar-07 (METAS, No. 217-00670)	Mar-08
Reference 3 dB Attenuator	SN: S5054 (3c)	8-Aug-07 (METAS, No. 217-00719)	Aug-08
Reference 20 dB Attenuator	SN: S5086 (20b)	29-Mar-07 (METAS, No. 217-00671)	Mar-08
Reference 30 dB Attenuator	SN: S5129 (30b)	8-Aug-07 (METAS, No. 217-00720)	Aug-08
Reference Probe H3DV6	SN: 6182	2-Oct-07 (SPEAG, No. H3-6182_Oct07)	Oct-08
DAE4	SN: 654	20-Apr-07 (SPEAG, No. DAE4-654_Apr07)	Apr-08
Secondary Standards	ID #	Check Date (in house)	Scheduled Check
RF generator HP 8648C	US3642U01700	4-Aug-99 (SPEAG, in house check Oct-07)	In house check: Oct-09
Network Analyzer HP 8753E	US37390585	18-Oct-01 (SPEAG, in house check Oct-07)	In house check: Oct-08

	Name	Function	Signature
Calibrated by:	Katja Pokovic	Technical Manager	
Approved by:	Niels Kuster	Quality Manager	

Issued: November 12, 2007

This calibration certificate shall not be reproduced except in full without written approval of the laboratory.



<b>RTS</b> RIM Testing Services	Document <b>Annex B to Hearing Aid Compatibility RF Emissions Test Report for the BlackBerry® Smartphone model RCD21IN</b>		Page 25(31)
	Author Data <b>Daoud Attayi</b>	Dates of Test <b>June 25, Oct 23-24, 2008</b>	Report No <b>RTS-1271-0810-32</b>

**Calibration Laboratory of Schmid & Partner Engineering AG**  
Zeughausstrasse 43, 8004 Zurich, Switzerland



**S** Schweizerischer Kalibrierdienst  
**S** Service suisse d'étalonnage  
**C** Servizio svizzero di taratura  
**S** Swiss Calibration Service

Accredited by the Swiss Accreditation Service (SAS)  
The Swiss Accreditation Service is one of the signatories to the EA Multilateral Agreement for the recognition of calibration certificates

Accreditation No.: **SCS 108**

**Glossary:**

**NORM<sub>x,y,z</sub>** sensitivity in free space  
**DCP** diode compression point  
**Polarization  $\varphi$**   $\varphi$  rotation around probe axis  
**Polarization  $\vartheta$**   $\vartheta$  rotation around an axis that is in the plane normal to probe axis (at measurement center), i.e.,  $\vartheta = 0$  is normal to probe axis  
**Connector Angle** information used in DASY system to align probe sensor X to the robot coordinate system

**Calibration is Performed According to the Following Standards:**

- a) IEEE Std 1309-2005, " IEEE Standard for calibration of electromagnetic field sensors and probes, excluding antennas, from 9 kHz to 40 GHz", December 2005.

**Methods Applied and Interpretation of Parameters:**

- **$X, Y, Z_{a0a1a2}$** : Assessed for E-field polarization  $\vartheta = 90$  for XY sensors and  $\vartheta = 0$  for Z sensor ( $f \leq 900$  MHz in TEM-cell;  $f > 1800$  MHz: R22 waveguide).
- **$X, Y, Z(f)_{a0a1a2} = X, Y, Z_{a0a1a2} * frequency\_response$**  (see Frequency Response Chart).
- **$DCP_{x,y,z}$** : DCP are numerical linearization parameters assessed based on the data of power sweep (no uncertainty required). DCP does not depend on frequency.
- **Spherical isotropy (3D deviation from isotropy)**: in a locally homogeneous field realized using an open waveguide setup.
- **Sensor Offset**: The sensor offset corresponds to the offset of virtual measurement center from the probe tip (on probe axis). No tolerance required.
- **Connector Angle**: The angle is assessed using the information gained by determining the  $X_{a0a1a2}$  (no uncertainty required).

<b>RTS</b> RIM Testing Services	Document <b>Annex B to Hearing Aid Compatibility RF Emissions Test Report for the BlackBerry® Smartphone model RCD21IN</b>		Page 26(31)
	Author Data <b>Daoud Attayi</b>	Dates of Test <b>June 25, Oct 23-24, 2008</b>	Report No <b>RTS-1271-0810-32</b>

**H3DV6 SN:6105**

**November 9, 2007**

# Probe H3DV6

## SN:6105

Manufactured:	January 4, 2002
Last calibrated:	November 15, 2006
Recalibrated:	November 9, 2007

**Calibrated for DASY Systems**

(Note: non-compatible with DASY2 system!)

<b>RTS</b> RIM Testing Services	Document <b>Annex B to Hearing Aid Compatibility RF Emissions Test Report for the BlackBerry® Smartphone model RCD21IN</b>		Page 27(31)
	Author Data <b>Daoud Attayi</b>	Dates of Test <b>June 25, Oct 23-24, 2008</b>	Report No <b>RTS-1271-0810-32</b>

H3DV6 SN:6105

November 9, 2007

### DASY - Parameters of Probe: H3DV6 SN:6105

Sensitivity in Free Space [A/m /  $\sqrt{(\mu V)}$ ]

	a0	a1	a2
X	2.879E-03	7.363E-5	-1.925E-5 ± 5.1 % (k=2)
Y	2.588E-03	1.222E-4	-1.861E-5 ± 5.1 % (k=2)
Z	2.929E-03	-6.729E-6	-1.558E-5 ± 5.1 % (k=2)

Diode Compression<sup>1</sup>

DCP X	87 mV
DCP Y	87 mV
DCP Z	87 mV

Sensor Offset (Probe Tip to Sensor Center)

X	3.0 mm
Y	3.0 mm
Z	3.0 mm

Connector Angle -234 °

The reported uncertainty of measurement is stated as the standard uncertainty of measurement multiplied by the coverage factor k=2, which for a normal distribution corresponds to a coverage probability of approximately 95%.

<sup>1</sup> numerical linearization parameter: uncertainty not required

<b>RTS</b> RIM Testing Services	Document <b>Annex B to Hearing Aid Compatibility RF Emissions Test Report for the BlackBerry® Smartphone model RCD21IN</b>		Page 28(31)
	Author Data <b>Daoud Attayi</b>	Dates of Test <b>June 25, Oct 23-24, 2008</b>	Report No <b>RTS-1271-0810-32</b>

H3DV6 SN:6105

November 9, 2007

### Frequency Response of H-Field

(TEM-Cell:ifi110, Waveguide R22)

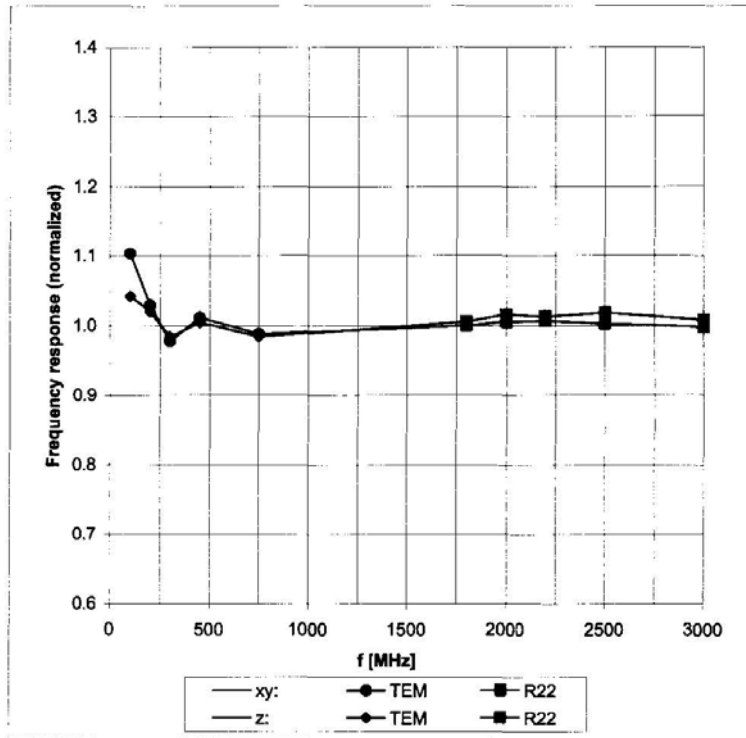

Uncertainty of Frequency Response of E-field:  $\pm 6.3\%$  (k=2)

<b>RTS</b> RIM Testing Services	Document <b>Annex B to Hearing Aid Compatibility RF Emissions Test Report for the BlackBerry® Smartphone model RCD21IN</b>		Page 29(31)
	Author Data <b>Daoud Attayi</b>	Dates of Test <b>June 25, Oct 23-24, 2008</b>	Report No <b>RTS-1271-0810-32</b>

H3DV6 SN:6105

November 9, 2007

**Receiving Pattern ( $\phi$ ),  $\vartheta = 90^\circ$**

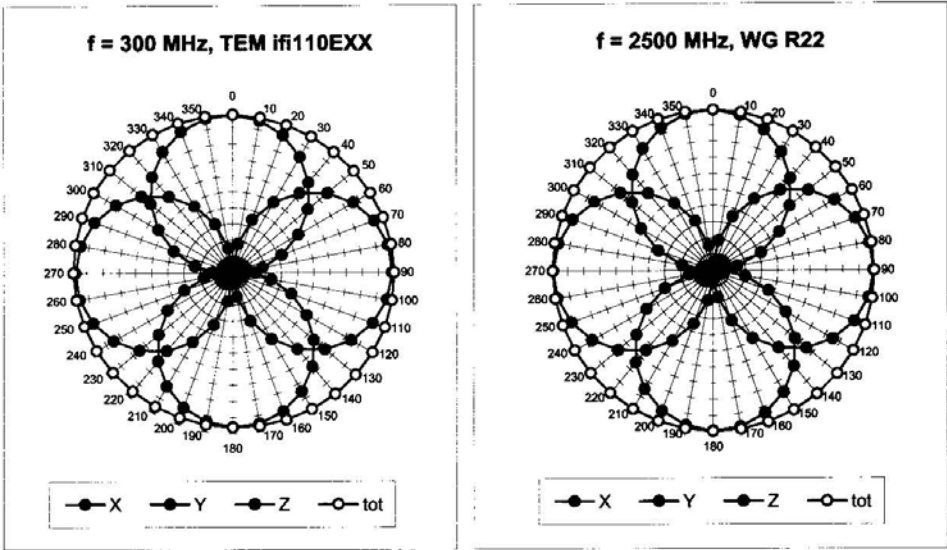

**Receiving Pattern ( $\phi$ ),  $\vartheta = 0^\circ$**

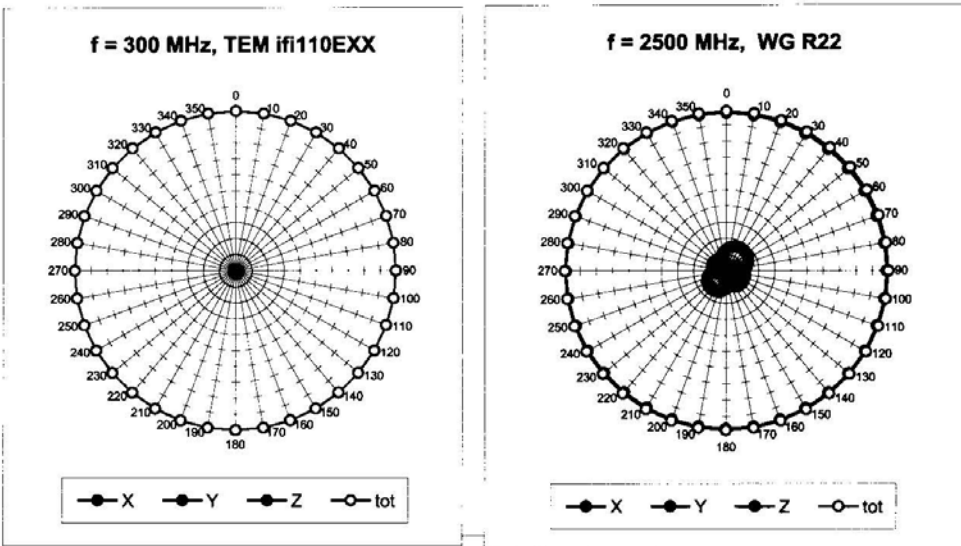

<b>RTS</b> RIM Testing Services	Document <b>Annex B to Hearing Aid Compatibility RF Emissions Test Report for the BlackBerry® Smartphone model RCD21IN</b>		Page 30(31)
	Author Data <b>Daoud Attayi</b>	Dates of Test <b>June 25, Oct 23-24, 2008</b>	Report No <b>RTS-1271-0810-32</b>

H3DV6 SN:6105

November 9, 2007

### Receiving Pattern ( $\phi$ ), $\vartheta = 90^\circ$

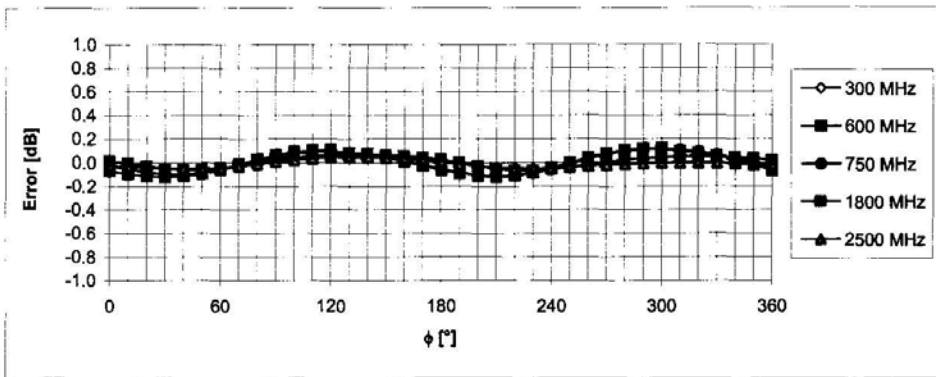

Uncertainty of Axial Isotropy Assessment:  $\pm 0.5\%$  ( $k=2$ )

### Receiving Pattern ( $\phi$ ), $\vartheta = 0^\circ$

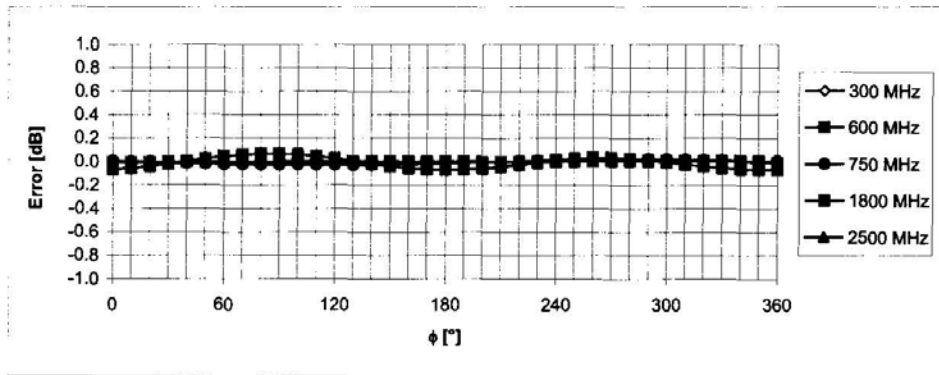

Uncertainty of Axial Isotropy Assessment:  $\pm 0.5\%$  ( $k=2$ )

<b>RTS</b> RIM Testing Services	Document <b>Annex B to Hearing Aid Compatibility RF Emissions Test Report for the BlackBerry® Smartphone model RCD21IN</b>		Page 31(31)
	Author Data <b>Daoud Attayi</b>	Dates of Test <b>June 25, Oct 23-24, 2008</b>	Report No <b>RTS-1271-0810-32</b>

H3DV6 SN:6105

November 9, 2007

### Dynamic Range f(H-field) (Waveguide R22, f = 1800 MHz)

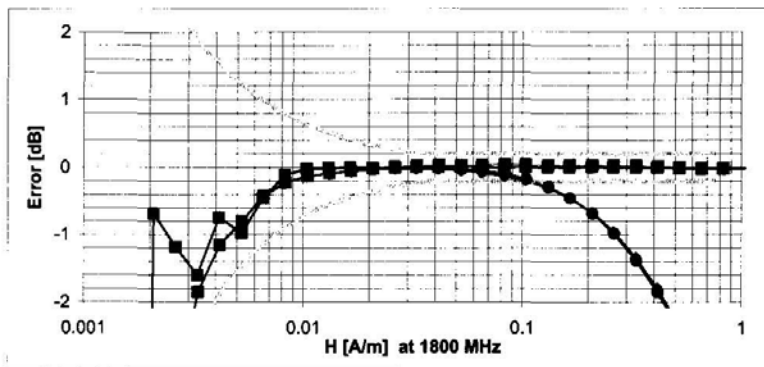
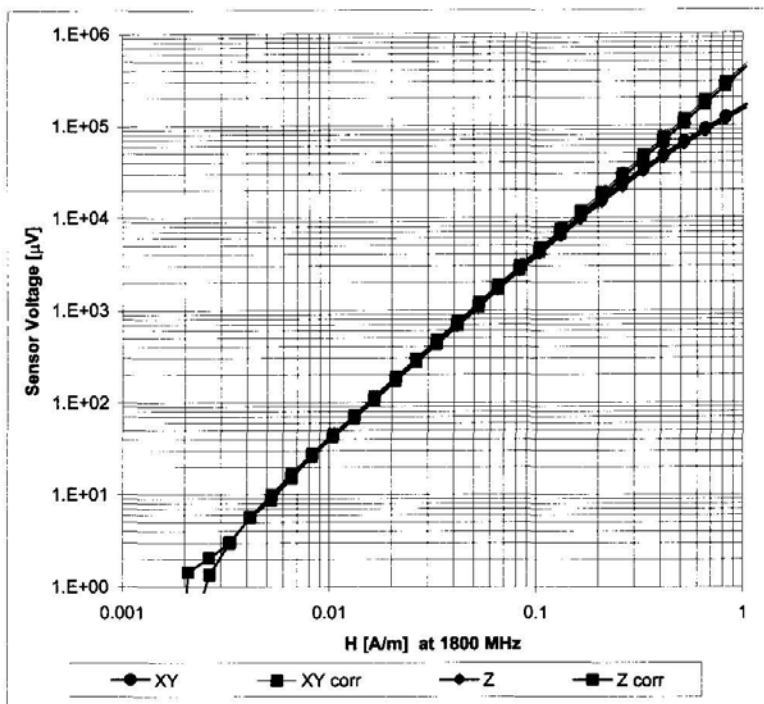

Uncertainty of Linearity Assessment:  $\pm 0.6\%$  (k=2)