

# EMI Test Report

Tested in accordance with  
Federal Communications Commission (FCC)  
Personal Communications Services  
CFR 47, Parts 2, 22 and 24

## RIM Testing Services (RTS)

**REPORT NO.:** RTS-0181-0506-05

**PRODUCT MODEL NO:** RAV20CW  
**TYPE NAME:** BlackBerry Wireless Handheld  
**FCC ID:** L6ARAV20CW  
**IC:** 2503A-RAV20CW

**Date:** \_\_\_\_\_26 August, 2005\_\_\_\_\_

# RTS

## RIM Testing Services

Report No. RTS-0181-0506-05

Test Date: July 29 to August 26, 2005

---

### Declaration

#### Statement of Performance:

The BlackBerry Wireless Handheld, model RAV20CW ASY-10007-00x and accessories when configured and operated per RIM's operation instructions, performs within the requirements of the test standards.

#### Declaration:

We hereby certify that:

The test data reported herein is an accurate record of the performance of the sample(s) tested.

The test results are valid for the tested unit (s) only.

The test equipment used was suitable for the tests performed and within manufacturer's published specifications and operating parameters.

The test methods were consistent with the methods described in the relevant standards.

Tested by:



Maurice Battler  
Compliance Specialist

Date: 26 August, 2005

Tested and Reviewed by:



Masud S. Attayi, P.Eng.  
Senior Compliance Engineer

Date: 07 September, 2005

Approved by:



Paul G. Cardinal, Ph.D.  
Manager

Date: 08 September, 2005

### Table of Contents

A) Scope -----	Pg. 4
B) Product Identification -----	Pg. 4
C) Support Equipment Used for Testing of the EUT -----	Pg. 4
D) Test Voltage -----	Pg. 5
E) Test Results Chart -----	Pg. 5
F) Modifications to EUT -----	Pg. 5
G) Summary of Results -----	Pg. 6
H) Compliance Test Equipment Used -----	Pg. 8
Appendix 1 Conducted Emissions Test Data/Plots	Pg. 9
Appendix 2 Conducted RF Output Power Test Data	Pg. 22
Appendix 3 Frequency Stability Test Data	Pg. 24
Appendix 4 Radiated Emissions Test Data	Pg. 36

# RTS

## RIM Testing Services

Report No. RTS-0181-0506-05

Test Date: July 29 to August 26, 2005

---

### A) Scope

This report details the results of compliance tests which were performed in accordance to the requirements of:

FCC CFR 47 Part 2, Oct. 1, 2000

FCC CFR 47 Part 22, Subpart H, Cellular Radiotelephone Services, Oct. 1, 2000

FCC CFR 47 Part 24 Subpart E, Broadband PCS, Oct 1. 2000

Industry Canada, RSS-129 Issue 2, Sept. 25, 1999, 800 MHz Dual-Mode CDMA Cellular Telephones

Industry Canada, RSS-133 Issue 3, June, 2005, 2.0 GHz Personal Communications Services

### B) Product Identification

The equipment under test (EUT) was tested at the RIM Testing Services (RTS) EMI test facility, located at:

305 Phillip Street

Waterloo, Ontario

Canada, N2L 3W8

Phone: 519 888 7465

Fax: 519 880-8173

The testing began on July 29, 2005 and completed on August 26, 2005. The sample equipment under test (EUT) included:

1a BlackBerry Wireless Handheld, model number RAV20CW, ASY-10007-00x, PIN number 300A7ABE, FCC ID L6ARAV20CW, IC: 2503A-RAV20CW.

1b) BlackBerry Wireless Handheld, model number RAV20CW, ASY-10007-00x, PIN number 300A7AB4, FCC ID L6ARAV20CW, IC: 2503A-RAV20CW.

The transmit frequency bands for the Handheld are: Cellular 824 to 849 MHz, PCS 1850 to 1910 MHz and Bluetooth 2402 to 2480 MHz.

### C) Support Equipment Used for the Testing of the EUT

1) Agilent Wireless Communication Test Set, model 8960, serial number GB41070272

2) Communication Tester, Rohde & Schwarz, model CMU 200, serial number 837493/073

3) DC Power Supply, H/P, model 6632B, serial number US37472178

# RTS

## RIM Testing Services

Report No. RTS-0181-0506-05

Test Date: July 29 to August 26, 2005

### D) Test Voltage

The ac input voltage was 120 volts, 60 Hz where applicable. This configuration was per RIM's specifications.

### E) Test Results Chart

SPECIFICATION	Test Type	MEETS REQUIREMENTS	Performed By
FCC CFR 47 Part 22, Subpart H IC RSS-129	Radiated Spurious/harmonic Emissions, ERP, LO	Yes	Masud Attayi
FCC CFR 47 Part 22, Subpart H IC RSS-129	Conducted Emissions, Occupied Bandwidth, Frequency Stability	Yes	Maurice Battler
FCC CFR 47 Part 24, Subpart E IC RSS-133	Radiated Spurious/harmonic Emissions, EIRP, LO	Yes	Masud Attayi
FCC CFR 47 Part 24, Subpart E IC RSS-133	Conducted Emissions, Occupied Bandwidth, Frequency Stability	Yes	Maurice Battler

### F) Modifications to EUT

No modifications were required to the EUT.

### G) Summary of Results

- 1) The EUT met the requirements of the Conducted Spurious Emissions in the Cellular band as per 47 CFR 22.917, CFR 22.901(d) and RSS-129. The EUT was measured on the low, middle and high channels. The frequency range investigated was from 10 MHz to 20 GHz. See APPENDIX 1 for the test data.
- 2) The EUT met the requirements of the Conducted Spurious Emissions in the PCS band as per 47 CFR 2.1057, CFR 24.238 and RSS-133. The EUT was measured on the low, middle and high channels. The frequency range investigated was from 10 MHz to 20 GHz. See APPENDIX 1 for the test data.
- 3) The EUT met the requirements of the Occupied Bandwidth in the Cellular band as per 47 CFR 2.202, CFR 22.917 and RSS-129. The channels measured were low, middle and high. See APPENDIX 1 for the test data.
- 4) The EUT met the requirements of the Occupied Bandwidth and channel mask in the PCS band as per 47 CFR 2.202, CFR 24.238 and RSS-133. The channels measured were low, middle and high. See APPENDIX 1 for the test data.
- 5) The EUT met the requirements of the Conducted RF Output Power for both the Cellular and PCS bands. The channels measured were low, middle and high. See APPENDIX 2 for the test data.
- 6) The EUT met the requirements of the Frequency Stability vs. Temperature and Voltage for Cellular band as per 22.917 and RSS-129.  
The maximum frequency error measured was less than 0.1 ppm.  
The temperature range was from -30°C to +60°C in 10° temperature steps. The EUT was measured on low, middle and high channels at each temperature step. The EUT was measured at low (3.5 volts), nominal (3.8 volts) and high (4.2 volts) dc input voltage at each temperature step and channel at maximum output power.  
See APPENDIX 3 for the test data.
- 7) The EUT met the requirements of the Frequency Stability vs. Temperature and Voltage requirements for the PCS band as per 24.235 and RSS-133. The maximum frequency error measured was less than 0.1 ppm.  
The temperature range was from -30°C to +60°C in 10 degree temperature steps. The EUT was measured on low, middle and high channels at each temperature step. The EUT was measured at low (3.5 volts), nominal (3.8 volts) and high (4.2 volts) dc input voltage at each temperature step and channel at maximum output power.  
See APPENDIX 3 for the test data.

# RTS

## RIM Testing Services

Report No. RTS-0181-0506-05

Test Date: July 29 to August 26, 2005

- 8) The radiated spurious emissions/harmonics and ERP/EIRP were measured for both Cellular and PCS bands. The results are within the limits. The EUT was placed on a nonconductive styrofoam table, 100 cm high that was positioned on a remote controlled turntable. The EUT height of one metre was set in order to align it with the lowest height of the receiving antenna. The test distance used between the EUT and the receiving antenna was three metres. Then the emissions were maximized by elevating the antenna in the range of 1 to 4 metres. The turntable was rotated to determine the azimuth of the peak emissions. The maximum emissions level was recorded. The measurements were performed in a semi-anechoic chamber. The semi-anechoic chamber FCC registration number is **778487** and the Industry Canada file number is **IC4240**. The EUT was measured on the low, middle and high channels with Bluetooth in frequency hopping mode.

The highest ERP in the Cellular band measured was 23.45 dBm at 836.52 MHz (channel 384).

The highest EIRP in the PCS band measured was 28.5 dBm at 1880.00 MHz (channel 600).

The radiated carrier harmonics were measured up to the 10<sup>th</sup> harmonic for low, middle and high channels in the Cellular and PCS bands.

The Cellular radiated carrier harmonic emissions had a test margin of greater than 25 dB.

The lowest test margin for the PCS band was 17.2 dB below the limit at 5726.25 MHz.

The EUT's RF local oscillator emissions were measured in the Cellular band on the low, middle and high channels (1013, 384 and 777) in the standalone upright position. Both the horizontal and vertical antenna polarizations were measured. The Cellular RF local oscillator emissions were in the NF.

The EUT's RF local oscillator emissions were measured in the PCS band on the low, middle and high channels (25, 600 and 1175) in the standalone upright position. Both the horizontal and vertical antenna polarizations were measured. The PCS RF local oscillator emissions were in the NF.

The radiated carrier harmonics were measured up to the 10<sup>th</sup> harmonic for low, middle and high channels in EVDO transmit mode in the Cellular and PCS bands.

The Cellular radiated carrier harmonic emissions had a test margin of greater than 25 dB.

The PCS radiated carrier harmonic emissions had a test margin of 17.3 dB at 5640.0 Mhz.

### **Sample Calculation:**

Field Strength (dB $\mu$ V/M) is calculated as follows:

FS = Measured Level (dB $\mu$ V) + A.F. (dB/m) + Cable Loss (dB) - Preamp (dB) + Filter Loss (dB)

See APPENDIX 4 for the test data.

**Measurement Uncertainty  $\pm 4.0$  dB**

# RTS

## RIM Testing Services

Report No. RTS-0181-0506-05

Test Date: July 29 to August 26, 2005

### H) Compliance Test Equipment Used

<u>UNIT</u>	<u>MANUFACTURER</u>	<u>MODEL</u>	<u>SERIAL NUMBER</u>	<u>CAL DUE DATE</u> (YY MM DD)	<u>USE</u>
Preamplifier	Sonoma	310N/11909A	185831	05-11-26	Radiated Emissions
Preamplifier system	TDK RF Solutions	PA-02	080010	06-01-13	Radiated Emissions
EMC Analyzer	Agilent	E7405A	US40240226	06-07-18	Radiated Emissions
Hybrid Log Antenna	TDK	HLP-3003C	130092	05-09-24	Radiated Emissions
Horn Antenna	TDK	HRN-0118	130092	05-09-24	Radiated Emissions
Horn Antenna	TDK	HRN-0118	30201	06-01-07	Radiated Emissions
Dipole Antenna	Schwarzbeck	UHAP	1018	06-02-05	Radiated Emissions
Dipole Antenna	Schwarzbeck	UHAP	974	05-09-21	Radiated Emissions
Wireless Communication Test Set	Agilent	8960	GB41070272	06-07-28	Radiated/RF Conducted Emissions
Universal Radio Communication Tester	Rohde & Schwarz	CMU 200	837493/073	06-02-06	Radiated Emissions
Spectrum Analyzer	HP	8563E	3745A08112	06-07-13	Conducted Emissions
DC Power Supply	HP	6632B	US37472178	07-07-12	Conducted Emissions
Temperature Probe	Hart Scientific	61161-302	21352860	05-09-10	Frequency Stability
Environmental Chamber	ESPEC Corp.	SH-240S1	91007118	N/R	Frequency Stability
Environment Monitor	Control Company	1870	230355189	06-01-11	RF Conducted Emissions
Environment Monitor	Control Company	1870	230355190	06-01-11	Radiated Emissions



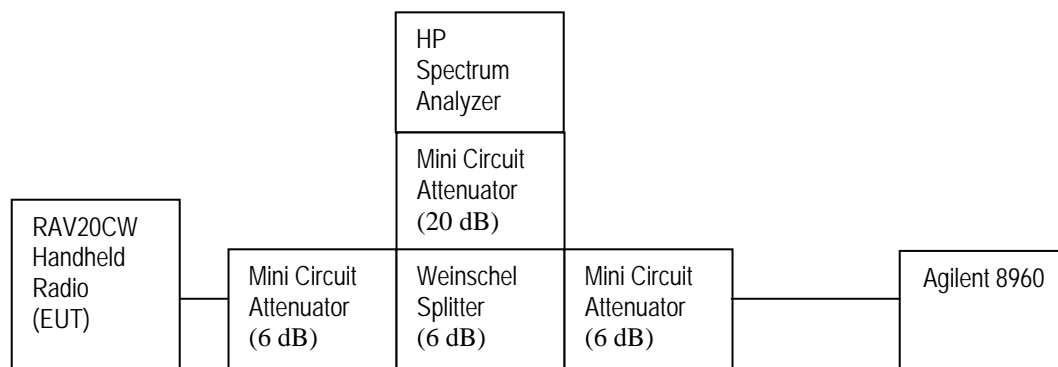
## APPENDIX 1

### CONDUCTED EMISSIONS TEST DATA/PLOTS

### Conducted Emission Test Results

This appendix contains measurement data pertaining to conducted spurious emissions, 99% power bandwidth and the channel mask.

### Test Setup Diagram



### Test Equipment List

Test Instruments	Manufacturer	Model No.	Serial No.	Frequency Range
Spectrum Analyzer	HP	8563E	3745A08112	30 Hz – 26.5 GHz
Splitter	Weinschel	1515	ME092	DC – 18 GHz
Attenuator	Mini Circuit	MCL BW-S20W2	--	DC – 18 GHz
Attenuator	Mini Circuit	MCL BW-S6W2	--	DC – 18 GHz
Attenuator	Mini Circuit	MCL BW-S6W2	--	DC – 18 GHz
Universal Radio Communication Tester	Aglient	8960	GB41070272	--

### Conducted Emission Test Data cont'd

**The conducted spurious emissions** – As per 47 CFR 2.202, 47 CFR 2.1057, 47 CFR 24.238, RSS-133, CFR 22 Subpart H and RSS-129 were measured from 10 MHz to 20 GHz. The EUT emissions were in the noise floor.

See figures 1 to 12 for the plots of the conducted spurious emissions.

### *Test Data for Cellular and PCS selected Frequencies*

<b>Cellular Frequency (MHz)</b>	<b>99% Occupied Bandwidth (MHz)</b>
824.700	1.269
836.520	1.269
848.310	1.279

<b>PCS Frequency (MHz)</b>	<b>99% Occupied Bandwidth (MHz)</b>
1851.200	1.310
1880.000	1.290
1908.750	1.300

### *Measurement Plots for Cellular and PCS*

Refer to the following measurement plots for more detail.

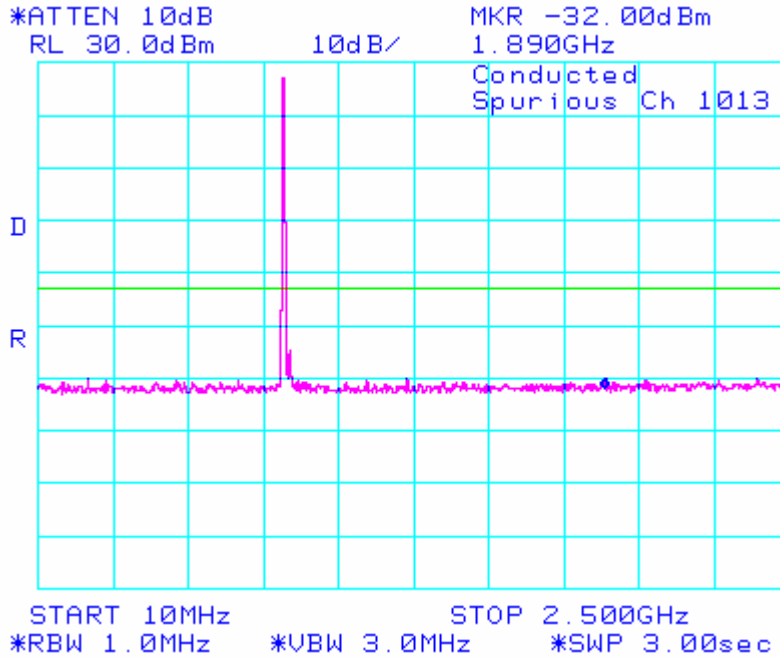
See Figures 13 to 18 for the plots of the 99% Occupied Bandwidth.

See Figures 19 to 20 for plots of the channel mask results.

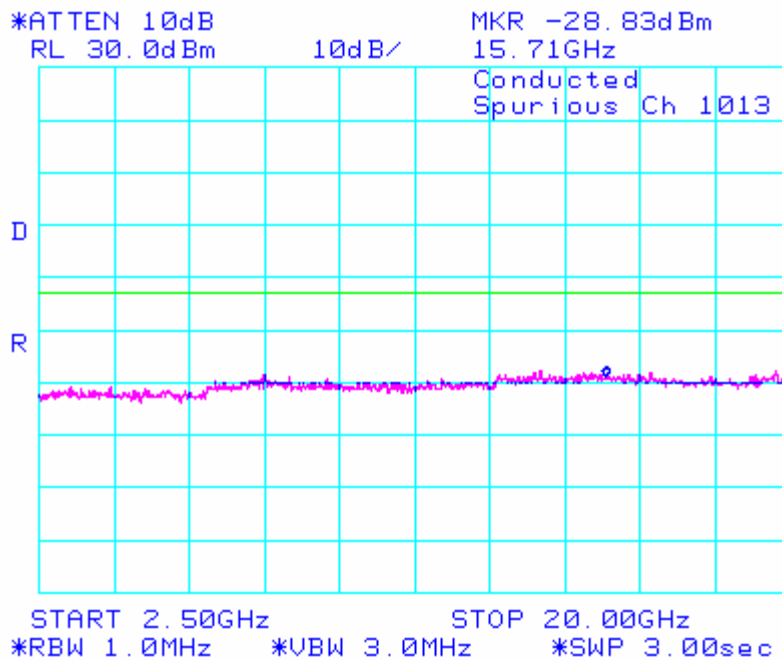
The RF power output was at maximum for all the recorded measurements shown below.

Conducted Emission Test Results cont'd

**Figure 1: Cellular, Spurious Conducted Emissions, Low channel**

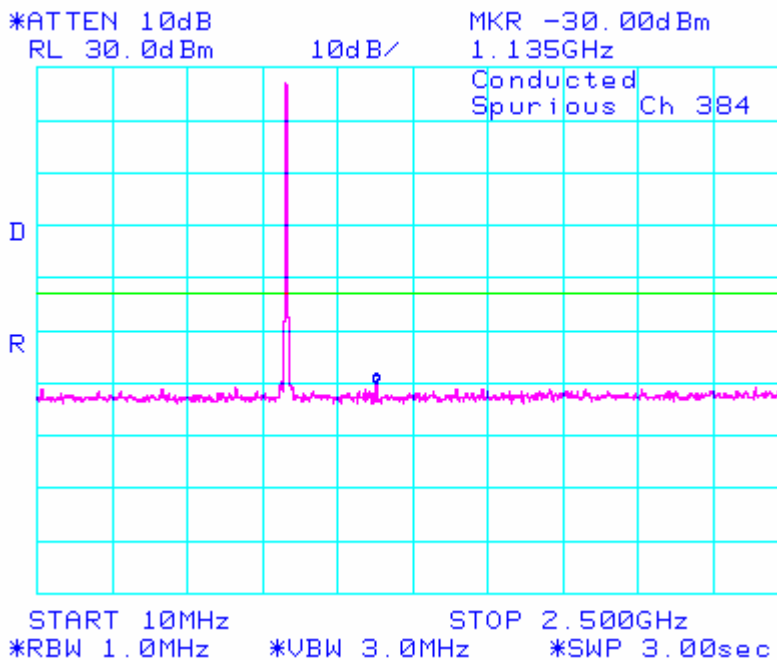


**Figure 2: Cellular, Spurious Conducted Emissions, Low channel**

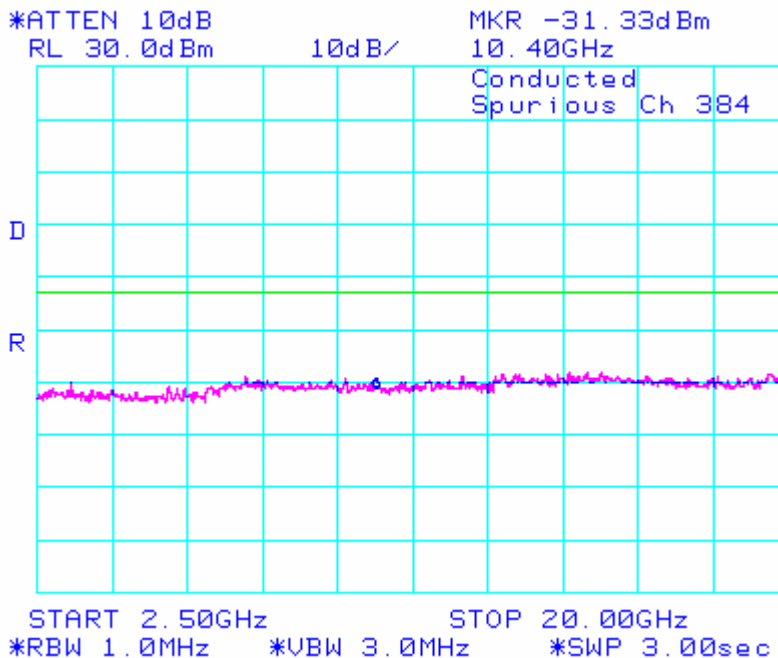


### Conducted Emission Test Results cont'd

**Figure 3: Cellular, Spurious Conducted Emissions, Middle Channel**

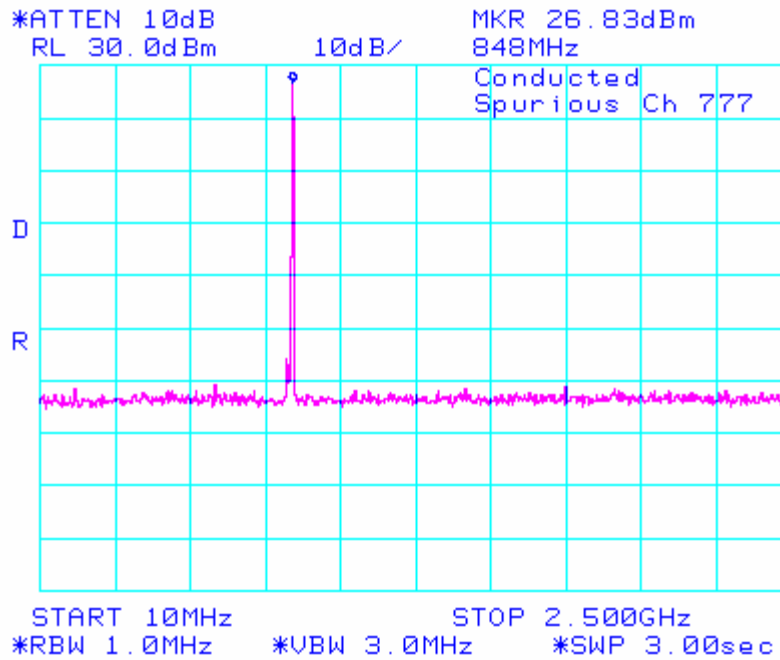


**Figure 4: Cellular, Spurious Conducted Emissions, Middle Channel**

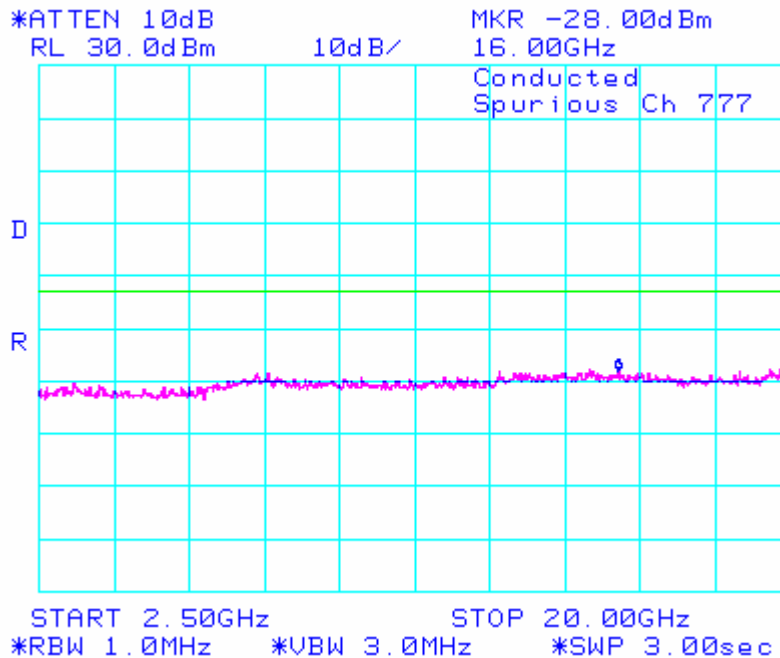


### Conducted Emission Test Results cont'd

**Figure 5: Cellular, Spurious Conducted Emissions, High Channel**

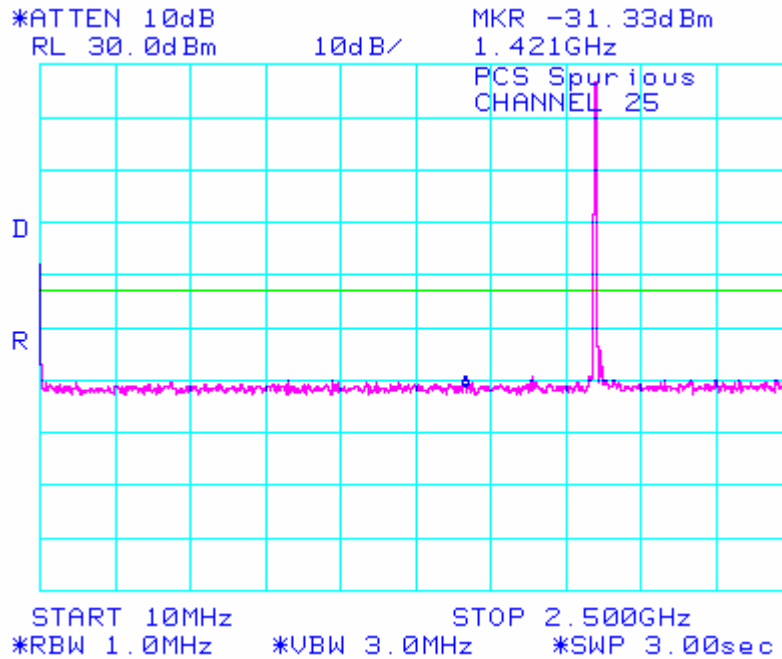


**Figure 6: Cellular, Spurious Conducted Emissions, High Channel**

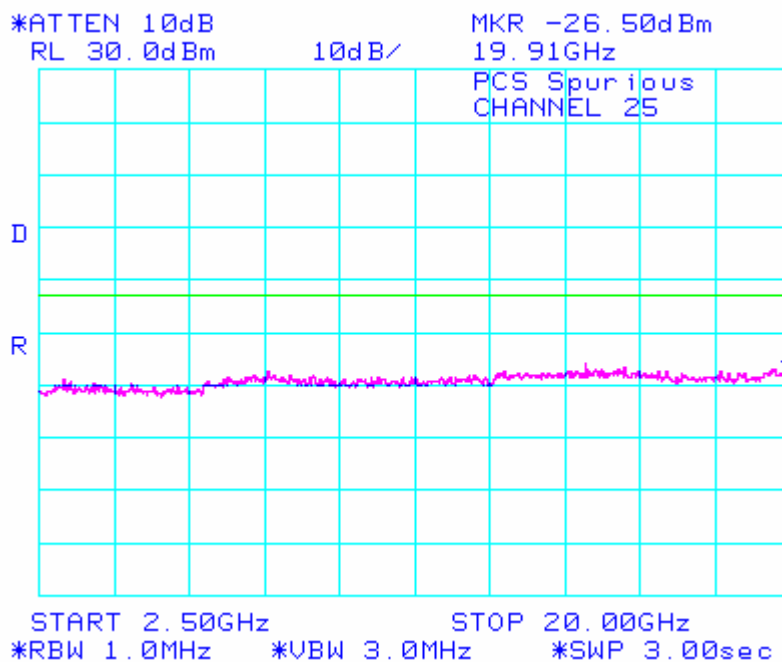


#### Conducted Emission Test Results cont'd

**Figure 7: PCS, Spurious Conducted Emissions, Low Channel**

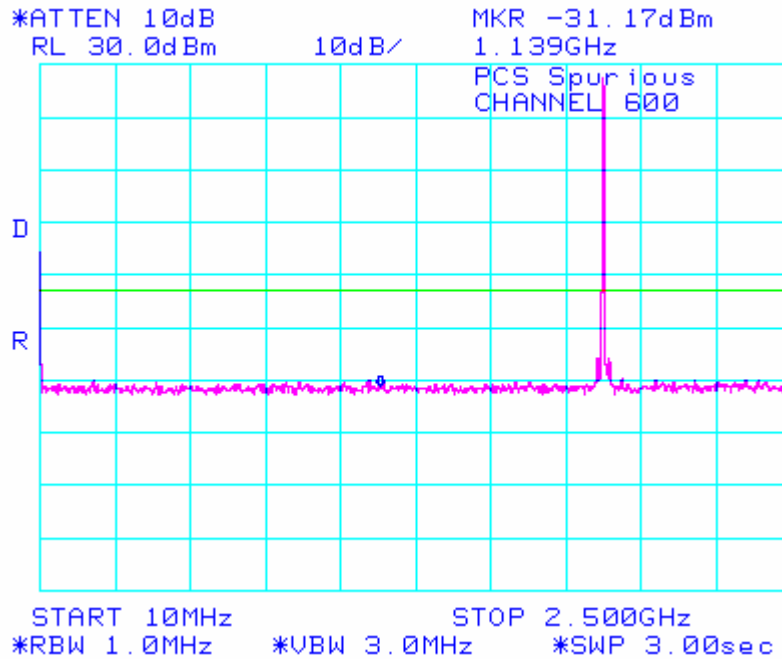


**Figure 8: PCS, Spurious Conducted Emissions, Low Channel**

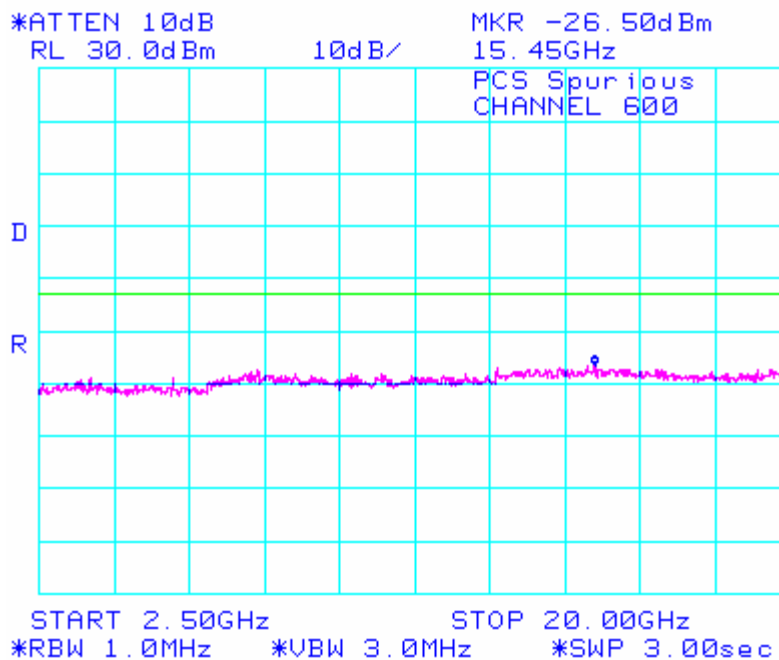


### Conducted Emission Test Results cont'd

**Figure 9: PCS, Spurious Conducted Emissions, Middle Channel**



**Figure 10: PCS, Spurious Conducted Emissions, Middle Channel**

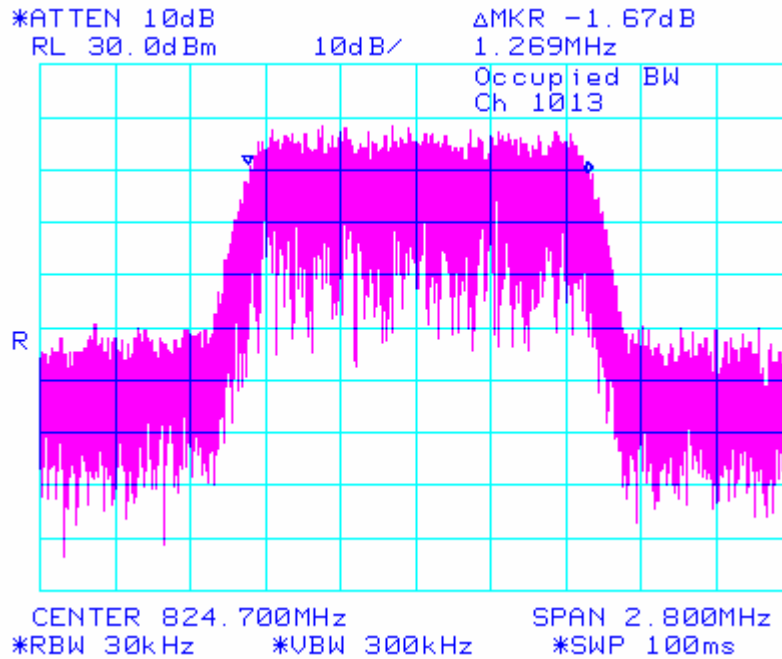




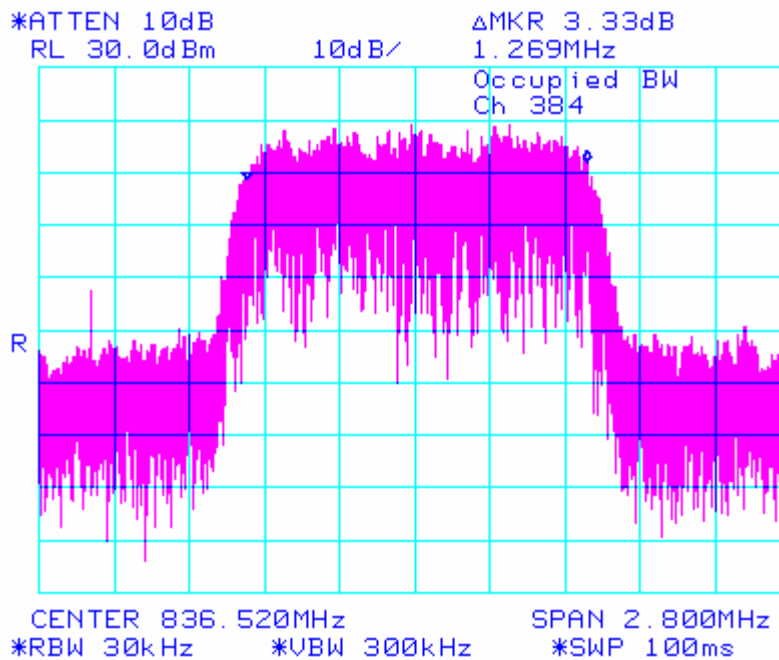


### Conducted Emission Test Results cont'd

**Figure 13: Occupied Bandwidth, Cellular Low Channel**

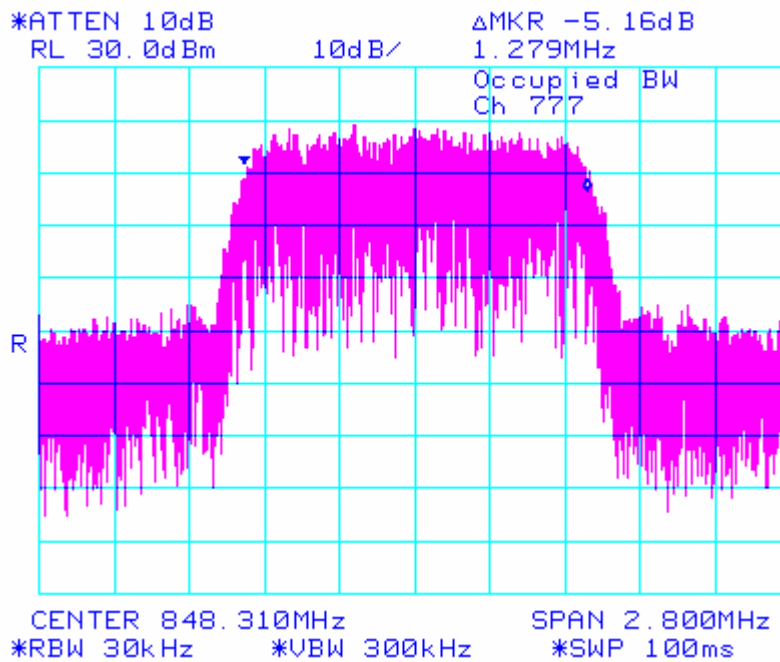


**Figure 14: Occupied Bandwidth, Cellular Middle Channel**

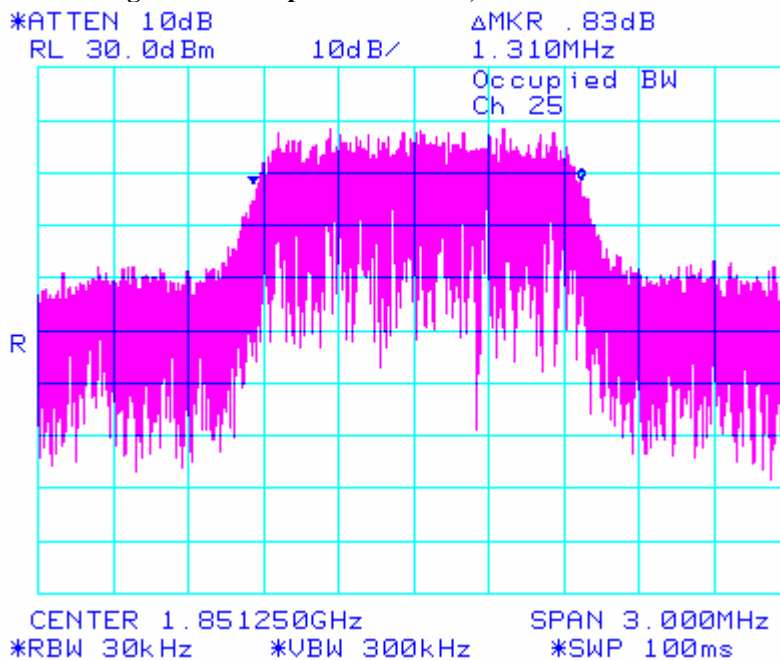


### Conducted Emission Test Results cont'd

**Figure 15: Occupied Bandwidth, Cellular High Channel**

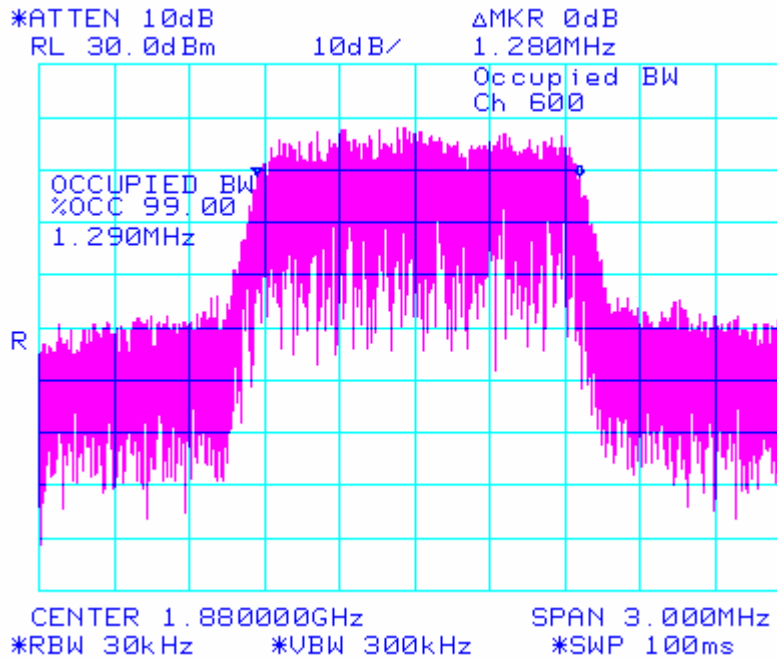


**Figure 16: Occupied Bandwidth, PCS Low Channel**

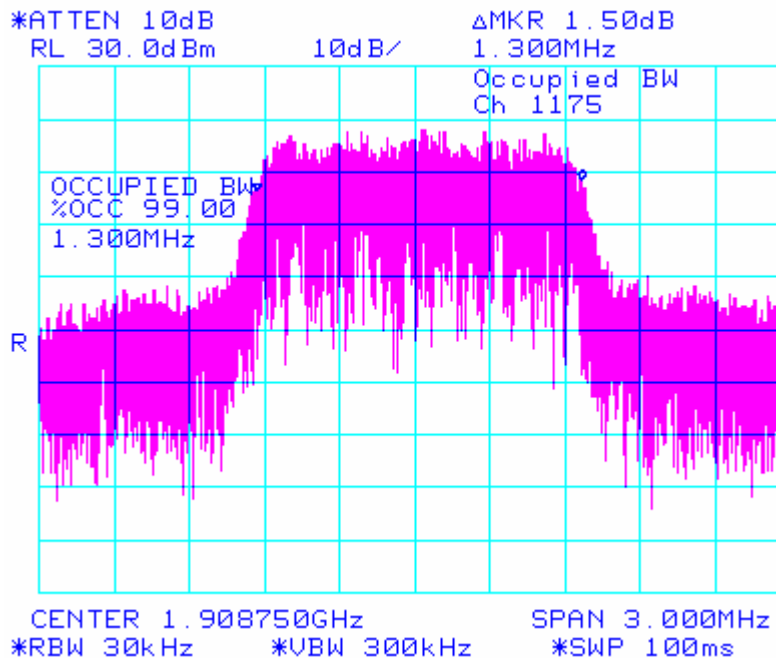


### Conducted Emission Test Results cont'd

**Figure 17: Occupied Bandwidth, PCS Middle Channel**

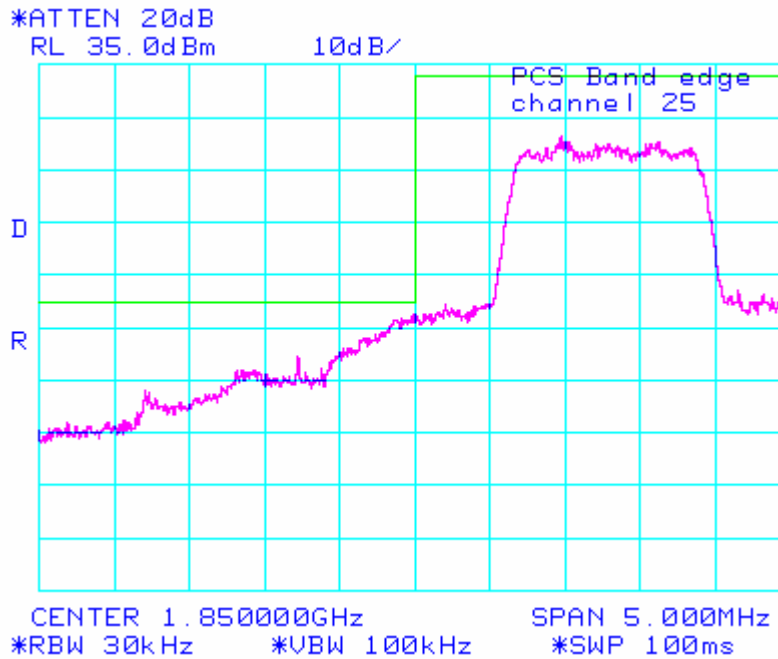


**Figure 18: Occupied Bandwidth, PCS High Channel**

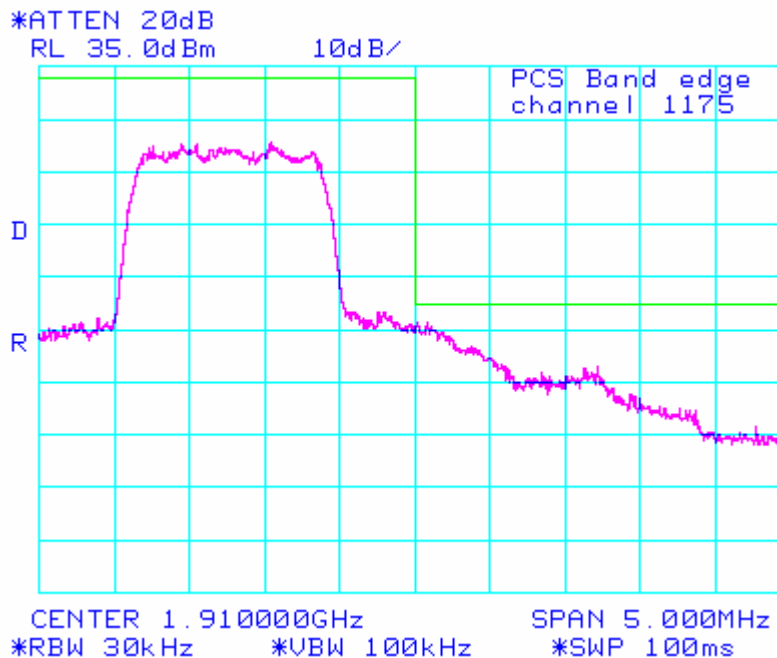


### Conducted Emission Test Results cont'd

**Figure 19: PCS, Low Channel Mask**



**Figure 20: PCS, High Channel Mask**



## APPENDIX 2

### CONDUCTED RF OUTPUT POWER TEST DATA

### Conducted RF Output Power Test Data

The conducted RF output power was measured using the Agilent Wireless Communication Test Set, model 8960. Low, middle and high channels were measured at maximum radio output power. Peak nominal output power is 24.5 dBm  $\pm$ 0.5 dB for Cellular and 23.5 dBm  $\pm$ 0.5 dB for PCS.

#### Test results

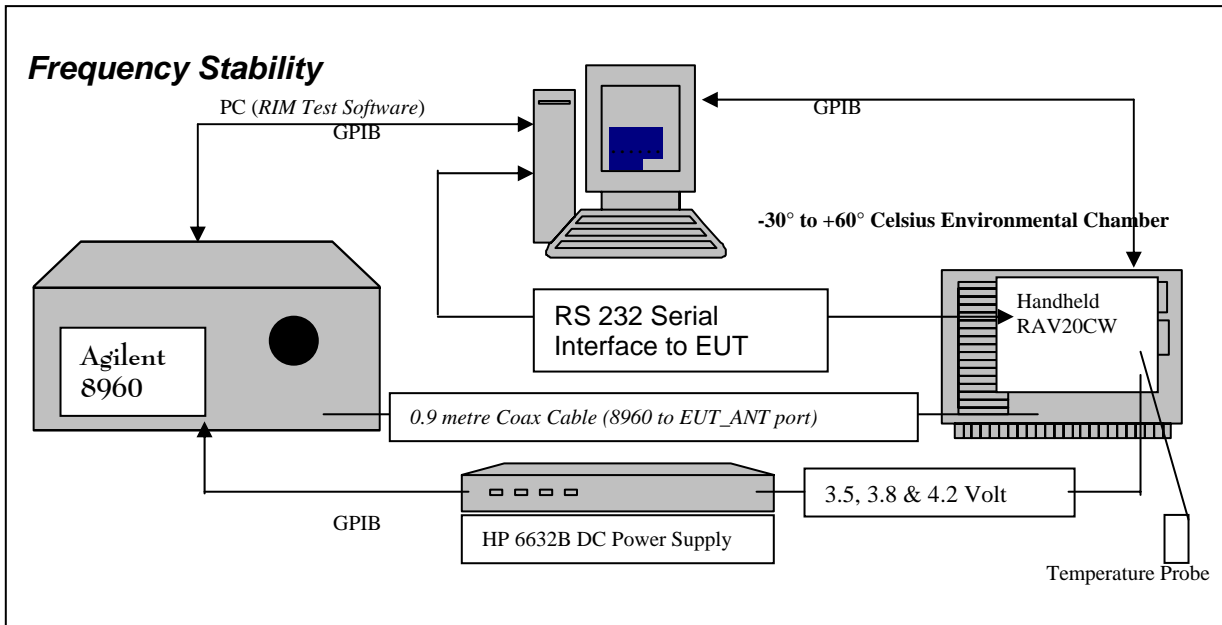
Channel	Frequency (MHz)	Maximum Output Power (dBm)
<u>Cellular</u>		
1013	824.700	24.7
384	836.520	25.0
777	848.310	24.9
<u>PCS</u>		
25	1851.200	24.0
600	1880.000	23.9
1175	1908.750	24.0

## APPENDIX 3

### FREQUENCY STABILITY TEST DATA



### Frequency Stability Test Data



<i>SYSTEM</i>	<i>Model</i>	<i>Serial Number</i>	<i>Calibration Due Date.</i>
Agilent Wireless Communication Test Set	8960	GB41070272	28 July 2006
HP System DC Power Supply	6632B	US37472178	12-July 2007
Network Analyzer	HP 8753D	3410A07083	03-Aug. 2006
Calibration Kit	HP85033D	3423A02787	24 Sept. 2005
Espec Environmental Chamber	SH240S1	91007118	N/A
Hart Temperature Probe	61161-302	21352860	10-Sept. 2005

CFR 47 Chapter 1 - Federal Communications Commission Rules

Part 2 Required Measurements

2.995 Frequency Stability - Procedures

(a,b) Frequency Stability - Temperature Variation

(d) Frequency Stability - Voltage Variation

**24.235** *Frequency Stability.*

*The frequency stability shall be sufficient to ensure that the fundamental emission stays within the authorized frequency block.*

The RAV20CW handheld, (referred as EUT hereinafter) transmitted frequencies are less than 0.1 ppm of the received frequency from the Agilent, Wireless Communication Test Set.

*The EUT meets the requirements as stated in CFR 47 chapter 1, Section 24.235, RSS-133, CFR 47 chapter 1, Section 22.917 and RSS-129 Frequency Stability.*

Frequency Stability measurement devices were configured as presented in the block diagram recording frequency, power, data, temperatures, and stepped voltages controlled via a GPIB interface linked to the Environmental chamber, a DC power supply, and the Communications Test Set. A 0.9-meter coax cable was calibrated to characterize the insertion loss for the transmitted frequencies between the RF input/output of the Wireless Communication Test Set and the EUT antenna port; located inside the environmental chamber.

Calibration for the Cable Loss was performed in the RF Laboratory on August 22, 2005

The cable assembly from the RF input to the RF output was measured at the following Frequencies:

PCS Frequency (MHz)	Cable loss (dB)
1851.20	1.10
1880.00	1.10
1908.75	1.10

Cellular Frequency (MHz)	Cable loss (dB)
824.70	0.78
836.52	0.78
848.31	0.78

### Procedure:

The EUT was placed in the Temperature chamber and connected to Wireless Communication Test Set outside as shown in the figure above. Dry air was pumped inside the temperature chamber to maintain a backpressure during the test. The EUT was kept in the off condition at all times except when the measurements were to be made.

The chamber was switched on and the temperature was set to -30°C.

After the chamber stabilized at -30°C there was a soak period of one hour to alleviate moisture in the chamber, the EUT voltage was enabled.

The system software recorded the frequency, power, and associated measurements.

A Computer system controlled the automated software. This application was given the command of activating all machines intrinsic to the temperature and voltage tests controlling the Wireless Communication Test Set via the GPIB Bus. The Environmental Chamber was instructed through an RS-232 serial line. The EUT dialogue was passed through a serial connection.

The EUT repetitively transmitted 100 bursts for each set of programmed parameters recording temperature, voltage settings, and systematically selected frequencies. The power supply was cycled from minimum voltage 3.5 volts, to 3.8 volts to 4.2 volts nominal voltage.

The frequency error was measured at a maximum output power and recorded by the automated system test software.

The EUT output power and frequency was measured at 3.5 volts, 3.8 volts and 4.2 volts. The transmit frequency was varied in 3 steps consisting of 824.70, 836.52, and 848.31 MHz for the cellular band and 1851.20, 1880.00 and 1908.75 MHz for the PCS band. This frequency was recorded in MHz and deviation from nominal, in Parts Per Million.

After the initial one-hour soak at the beginning of the measurement, a period of thirty minutes soak was initialized between each ascending temperature step, before proceeding to the next measurement test cycle.

### PROCEDURE:

The test system software for commencing the Frequency Stability Tests carried through the following cycle.

1. Switch on the HP 6632B power supply; Wireless Communication Test Set, and Environmental Chamber.
2. Start test program
3. Set the Temperature to -30 degrees Celsius and maintain a period of one- hour soak time, with the EUT supply voltage disabled.
4. Set power supply voltage to 3.5 Volts.
5. Set up Wireless Communication Test Set.
6. Command the Wireless Communication Test Set to switch to the low channel.
7. Enable the voltage to the EUT, and connect a link to the Wireless Communication Test Set.
8. EUT is commanded to Transmit 100 Bursts.
9. Software logs the following data from the Wireless Communication Test Set, power supply and temperature chamber: Traffic Channel Number, Traffic Channel Frequency, Chamber Temperature, Supply Voltage, Power, Frequency Error.
10. The Wireless Communication Test Set commands the EUT to change frequency to the middle channel and high channel and repeats steps 7 to 9.
11. Repeat steps 5 to 10 changing the supply voltage to 3.8 Volts
12. Increase temperature by 10 degrees Celsius and soak for 1/2 hour.
13. Repeat steps 4 - 12 for temperatures -30 degrees to 60 degrees Celsius.
14. Repeat steps 5 to 10 changing the supply voltage to 4.2 Volts

Procedure 5 to 10 was repeated at room temperature (20 degrees Celsius) with the power supply voltage set to 3.5, 3.8 and 4.2 Volts.

# RTS

## RIM Testing Services

## Appendix 3

Report No. RTS-0181-0506-05

Test Date: July 29 to August 26, 2005

Cellular Channel results: channels 1013, 384 and 777 @ 20°C maximum transmitted power

Traffic Channel Number	Cellular Frequency (MHz)	Voltage (Volts)	Temperature (Celsius)	Frequency Error (Hz)	PPM
1013	824.700	3.5	20	0.102	0.0001
384	836.520	3.5	20	0.164	0.0002
777	848.310	3.5	20	-0.528	-0.0006

Traffic Channel Number	Cellular Frequency (MHz)	Voltage (Volts)	Temperature (Celsius)	Frequency Error (Hz)	PPM
1013	824.700	3.8	20	-0.553	-0.0007
384	836.520	3.8	20	0.557	0.0007
777	848.310	3.8	20	0.306	0.0004

Traffic Channel Number	Cellular Frequency (MHz)	Voltage (Volts)	Temperature (Celsius)	Frequency Error (Hz)	PPM
1013	824.700	4.2	20	-0.171	-0.0002
384	836.520	4.2	20	0.614	0.0007
777	848.310	4.2	20	0.651	0.0008

# RTS

## RIM Testing Services

## Appendix 3

Report No. RTS-0181-0506-05

Test Date: July 29 to August 26, 2005

### Cellular Results: channel 1013 @ maximum transmitted power

Traffic Channel Number	Frequency (MHz)	Voltage (Volts)	Temperature (Celsius)	Frequency Error (Hz)	PPM
1013	824.700	3.5	-30	0.190	0.0002
1013	824.700	3.5	-20	-1.032	-0.0013
1013	824.700	3.5	-10	0.883	0.0011
1013	824.700	3.5	0	0.029	0.0000
1013	824.700	3.5	10	0.150	0.0002
1013	824.700	3.5	20	0.102	0.0001
1013	824.700	3.5	30	0.251	0.0003
1013	824.700	3.5	40	-0.042	-0.0001
1013	824.700	3.5	50	0.263	0.0003
1013	824.700	3.5	60	0.232	0.0003

Traffic Channel Number	Frequency (MHz)	Voltage (Volts)	Temperature (Celsius)	Frequency Error (Hz)	PPM
1013	824.700	3.8	-30	0.127	0.0002
1013	824.700	3.8	-20	0.052	0.0001
1013	824.700	3.8	-10	0.711	0.0009
1013	824.700	3.8	0	-0.352	-0.0004
1013	824.700	3.8	10	-0.022	0.0000
1013	824.700	3.8	20	-0.553	-0.0007
1013	824.700	3.8	30	-0.268	-0.0003
1013	824.700	3.8	40	-0.538	-0.0007
1013	824.700	3.8	50	-0.545	-0.0007
1013	824.700	3.8	60	0.008	0.0000

Traffic Channel Number	Frequency (MHz)	Voltage (Volts)	Temperature (Celsius)	Frequency Error (Hz)	PPM
1013	824.700	4.2	-30	-0.658	-0.0008
1013	824.700	4.2	-20	0.448	0.0005
1013	824.700	4.2	-10	0.182	0.0002
1013	824.700	4.2	0	-0.283	-0.0003
1013	824.700	4.2	10	-0.592	-0.0007
1013	824.700	4.2	20	-0.171	-0.0002
1013	824.700	4.2	30	-0.420	-0.0005
1013	824.700	4.2	40	-0.248	-0.0003
1013	824.700	4.2	50	0.584	0.0007
1013	824.700	4.2	60	0.612	0.0007

This report shall NOT be reproduced except in full without the written consent of RIM Testing Services (RTS)  
A division of Research in Motion Limited.

Copyright 2004-2005

Page 29 of 43

# RTS

## RIM Testing Services

## Appendix 3

Report No. RTS-0181-0506-05

Test Date: July 29 to August 26, 2005

### Cellular Results: channel 384 @ maximum transmitted power

Traffic Channel Number	Frequency (MHz)	Voltage (Volts)	Temperature (Celsius)	Frequency Error (Hz)	PPM
384	836.520	3.5	-30	-0.260	-0.0003
384	836.520	3.5	-20	0.677	0.0008
384	836.520	3.5	-10	0.499	0.0006
384	836.520	3.5	0	0.776	0.0009
384	836.520	3.5	10	0.373	0.0004
384	836.520	3.5	20	0.164	0.0002
384	836.520	3.5	30	-0.092	-0.0001
384	836.520	3.5	40	0.810	0.0010
384	836.520	3.5	50	0.170	0.0002
384	836.520	3.5	60	-0.751	-0.0009

Traffic Channel Number	Frequency (MHz)	Voltage (Volts)	Temperature (Celsius)	Frequency Error (Hz)	PPM
384	836.520	3.8	-30	-0.989	-0.0012
384	836.520	3.8	-20	-0.129	-0.0002
384	836.520	3.8	-10	0.941	0.0011
384	836.520	3.8	0	0.383	0.0005
384	836.520	3.8	10	-0.483	-0.0006
384	836.520	3.8	20	0.557	0.0007
384	836.520	3.8	30	1.040	0.0012
384	836.520	3.8	40	0.386	0.0005
384	836.520	3.8	50	-0.656	-0.0008
384	836.520	3.8	60	0.401	0.0005

Traffic Channel Number	Frequency (MHz)	Voltage (Volts)	Temperature (Celsius)	Frequency Error (Hz)	PPM
384	836.520	4.2	-30	0.403	0.0005
384	836.520	4.2	-20	0.681	0.0008
384	836.520	4.2	-10	0.415	0.0005
384	836.520	4.2	0	0.534	0.0006
384	836.520	4.2	10	-0.350	-0.0004
384	836.520	4.2	20	0.614	0.0007
384	836.520	4.2	30	2.181	0.0026
384	836.520	4.2	40	-1.218	-0.0015
384	836.520	4.2	50	0.192	0.0002
384	836.520	4.2	60	0.396	0.0005

This report shall NOT be reproduced except in full without the written consent of RIM Testing Services (RTS)  
A division of Research in Motion Limited.

Copyright 2004-2005

Page 30 of 43

# RTS

## RIM Testing Services

## Appendix 3

Report No. RTS-0181-0506-05

Test Date: July 29 to August 26, 2005

### Cellular Results: channel 777 @ maximum transmitted power

Traffic Channel Number	Frequency (MHz)	Voltage (Volts)	Temperature (Celsius)	Frequency Error (Hz)	PPM
777	848.310	3.5	-30	-1.078	-0.0013
777	848.310	3.5	-20	-1.305	-0.0015
777	848.310	3.5	-10	0.805	0.0009
777	848.310	3.5	0	1.181	0.0014
777	848.310	3.5	10	0.435	0.0005
777	848.310	3.5	20	-0.528	-0.0006
777	848.310	3.5	30	0.199	0.0002
777	848.310	3.5	40	0.212	0.0003
777	848.310	3.5	50	0.464	0.0005
777	848.310	3.5	60	0.112	0.0001

Traffic Channel Number	Frequency (MHz)	Voltage (Volts)	Temperature (Celsius)	Frequency Error (Hz)	PPM
777	848.310	3.8	-30	0.022	0.0000
777	848.310	3.8	-20	0.714	0.0008
777	848.310	3.8	-10	-0.857	-0.0010
777	848.310	3.8	0	0.618	0.0007
777	848.310	3.8	10	0.649	0.0008
777	848.310	3.8	20	0.306	0.0004
777	848.310	3.8	30	-0.219	-0.0003
777	848.310	3.8	40	0.774	0.0009
777	848.310	3.8	50	-0.300	-0.0004
777	848.310	3.8	60	0.463	0.0005

Traffic Channel Number	Frequency (MHz)	Voltage (Volts)	Temperature (Celsius)	Frequency Error (Hz)	PPM
777	848.310	4.2	-30	0.036	0.0000
777	848.310	4.2	-20	-0.370	-0.0004
777	848.310	4.2	-10	0.794	0.0009
777	848.310	4.2	0	-0.107	-0.0001
777	848.310	4.2	10	0.568	0.0007
777	848.310	4.2	20	0.651	0.0008
777	848.310	4.2	30	-0.973	-0.0011
777	848.310	4.2	40	0.027	0.0000
777	848.310	4.2	50	0.454	0.0005
777	848.310	4.2	60	0.433	0.0005

PCS Channel results: channels 25, 600, & 1175 @ 20°C maximum transmitted power

Traffic Channel Number	PCS Frequency (MHz)	Voltage (Volts)	Temperature (Celsius)	Frequency Error (Hz)	PPM
25	1851.200	3.5	20	-2.245	-0.0012
600	1880.000	3.5	20	0.580	0.0003
1175	1908.750	3.5	20	1.048	0.0005

Traffic Channel Number	PCS Frequency (MHz)	Voltage (Volts)	Temperature (Celsius)	Frequency Error (Hz)	PPM
25	1851.200	3.8	20	0.608	0.0003
600	1880.000	3.8	20	-2.705	-0.0014
1175	1908.750	3.8	20	-0.224	-0.0001

Traffic Channel Number	PCS Frequency (MHz)	Voltage (Volts)	Temperature (Celsius)	Frequency Error (Hz)	PPM
25	1851.200	4.2	20	-1.686	-0.0009
600	1880.000	4.2	20	0.370	0.0002
1175	1908.750	4.2	20	2.768	0.0015



# RTS

## RIM Testing Services

## Appendix 3

Report No. RTS-0181-0506-05

Test Date: July 29 to August 26, 2005

### PCS Results: channel 25 @ maximum transmitted power

Traffic Channel Number	Frequency (MHz)	Voltage (Volts)	Temperature (Celsius)	Frequency Error (Hz)	PPM
25	1851.20	3.5	-30	-1.774	-0.0010
25	1851.20	3.5	-20	-0.096	-0.0001
25	1851.20	3.5	-10	-1.701	-0.0009
25	1851.20	3.5	0	-0.202	-0.0001
25	1851.20	3.5	10	0.024	0.0000
25	1851.20	3.5	20	-2.245	-0.0012
25	1851.20	3.5	30	2.778	0.0015
25	1851.20	3.5	40	-0.606	-0.0003
25	1851.20	3.5	50	-0.413	-0.0002
25	1851.20	3.5	60	1.140	0.0006

Traffic Channel Number	Frequency (MHz)	Voltage (Volts)	Temperature (Celsius)	Frequency Error (Hz)	PPM
25	1851.20	3.8	-30	-1.505	-0.0008
25	1851.20	3.8	-20	-1.124	-0.0006
25	1851.20	3.8	-10	-1.085	-0.0006
25	1851.20	3.8	0	2.101	0.0011
25	1851.20	3.8	10	1.146	0.0006
25	1851.20	3.8	20	0.608	0.0003
25	1851.20	3.8	30	1.723	0.0009
25	1851.20	3.8	40	0.471	0.0003
25	1851.20	3.8	50	0.876	0.0005
25	1851.20	3.8	60	0.886	0.0005

Traffic Channel Number	Frequency (MHz)	Voltage (Volts)	Temperature (Celsius)	Frequency Error (Hz)	PPM
25	1851.20	4.2	-30	-1.465	-0.0008
25	1851.20	4.2	-20	0.011	0.0000
25	1851.20	4.2	-10	0.424	0.0002
25	1851.20	4.2	0	1.260	0.0007
25	1851.20	4.2	10	0.812	0.0004
25	1851.20	4.2	20	-1.686	-0.0009
25	1851.20	4.2	30	-1.014	-0.0005
25	1851.20	4.2	40	1.491	0.0008
25	1851.20	4.2	50	-1.857	-0.0010
25	1851.20	4.2	60	0.492	0.0003

This report shall NOT be reproduced except in full without the written consent of RIM Testing Services (RTS)  
A division of Research in Motion Limited.

Copyright 2004-2005

Page 33 of 43

# RTS

## RIM Testing Services

## Appendix 3

Report No. RTS-0181-0506-05

Test Date: July 29 to August 26, 2005

### PCS Results: channel 600 @ maximum transmitted power

Traffic Channel Number	Frequency (MHz)	Voltage (Volts)	Temperature (Celsius)	Frequency Error (Hz)	PPM
600	1880.00	3.5	-30	-0.298	-0.0002
600	1880.00	3.5	-20	0.613	0.0003
600	1880.00	3.5	-10	-1.079	-0.0006
600	1880.00	3.5	0	-2.108	-0.0011
600	1880.00	3.5	10	1.848	0.0010
600	1880.00	3.5	20	0.580	0.0003
600	1880.00	3.5	30	2.610	0.0014
600	1880.00	3.5	40	-0.379	-0.0002
600	1880.00	3.5	50	-1.811	-0.0010
600	1880.00	3.5	60	0.132	0.0001

Traffic Channel Number	Frequency (MHz)	Voltage (Volts)	Temperature (Celsius)	Frequency Error (Hz)	PPM
600	1880.00	3.8	-30	-0.854	-0.0005
600	1880.00	3.8	-20	0.112	0.0001
600	1880.00	3.8	-10	-0.753	-0.0004
600	1880.00	3.8	0	1.782	0.0009
600	1880.00	3.8	10	0.849	0.0005
600	1880.00	3.8	20	-2.705	-0.0014
600	1880.00	3.8	30	0.008	0.0000
600	1880.00	3.8	40	0.186	0.0001
600	1880.00	3.8	50	0.773	0.0004
600	1880.00	3.8	60	-0.268	-0.0001

Traffic Channel Number	Frequency (MHz)	Voltage (Volts)	Temperature (Celsius)	Frequency Error (Hz)	PPM
600	1880.00	4.2	-30	0.100	0.0001
600	1880.00	4.2	-20	0.330	0.0002
600	1880.00	4.2	-10	-0.194	-0.0001
600	1880.00	4.2	0	-0.425	-0.0002
600	1880.00	4.2	10	-2.482	-0.0013
600	1880.00	4.2	20	0.370	0.0002
600	1880.00	4.2	30	-0.811	-0.0004
600	1880.00	4.2	40	0.713	0.0004
600	1880.00	4.2	50	-0.414	-0.0002
600	1880.00	4.2	60	-0.413	-0.0002

This report shall NOT be reproduced except in full without the written consent of RIM Testing Services (RTS)  
A division of Research in Motion Limited.

Copyright 2004-2005

Page 34 of 43

# RTS

## RIM Testing Services

## Appendix 3

Report No. RTS-0181-0506-05

Test Date: July 29 to August 26, 2005

### PCS Results: channel 1175 @ maximum transmitted power

Traffic Channel Number	Frequency (MHz)	Voltage (Volts)	Temperature (Celsius)	Frequency Error (Hz)	PPM
1175	1908.75	3.5	-30	0.142	0.0001
1175	1908.75	3.5	-20	1.040	0.0005
1175	1908.75	3.5	-10	-0.466	-0.0002
1175	1908.75	3.5	0	-1.814	-0.0010
1175	1908.75	3.5	10	0.178	0.0001
1175	1908.75	3.5	20	1.048	0.0005
1175	1908.75	3.5	30	0.500	0.0003
1175	1908.75	3.5	40	0.656	0.0003
1175	1908.75	3.5	50	1.041	0.0005
1175	1908.75	3.5	60	-1.133	-0.0006

Traffic Channel Number	Frequency (MHz)	Voltage (Volts)	Temperature (Celsius)	Frequency Error (Hz)	PPM
1175	1908.75	3.8	-30	-0.738	-0.0004
1175	1908.75	3.8	-20	-0.823	-0.0004
1175	1908.75	3.8	-10	1.593	0.0008
1175	1908.75	3.8	0	2.112	0.0011
1175	1908.75	3.8	10	1.724	0.0009
1175	1908.75	3.8	20	-0.224	-0.0001
1175	1908.75	3.8	30	0.622	0.0003
1175	1908.75	3.8	40	1.266	0.0007
1175	1908.75	3.8	50	0.252	0.0001
1175	1908.75	3.8	60	0.585	0.0003

Traffic Channel Number	Frequency (MHz)	Voltage (Volts)	Temperature (Celsius)	Frequency Error (Hz)	PPM
1175	1908.75	4.2	-30	0.468	0.0002
1175	1908.75	4.2	-20	0.209	0.0001
1175	1908.75	4.2	-10	1.420	0.0007
1175	1908.75	4.2	0	-0.427	-0.0002
1175	1908.75	4.2	10	0.039	0.0000
1175	1908.75	4.2	20	2.768	0.0015
1175	1908.75	4.2	30	-0.197	-0.0001
1175	1908.75	4.2	40	0.696	0.0004
1175	1908.75	4.2	50	-1.307	-0.0007
1175	1908.75	4.2	60	1.076	0.0006

This report shall NOT be reproduced except in full without the written consent of RIM Testing Services (RTS)  
A division of Research in Motion Limited.

Copyright 2004-2005

Page 35 of 43

## APPENDIX 4

### RADIATED EMISSIONS TEST DATA

### Radiated Emissions Test Data Results

Test distance was 3.0 metres.

Cellular Band

July 29, 2005

EUT				Rx Antenna		Spectrum Analyzer		Substitution Method				
Type	Ch	Frequency (MHz)	Band	Type	Pol.	Reading (dBuV)	Max (V,H) (dBuV)	Pol. Tx-Rx	Reading (dBm)	Corrected Reading (relative to dipole)	Limit (dBm)	Diff to Limit (dB)
<b>Cellular Band (ERP)</b>												
Handheld Standalone, on its side												
F0	1013	824.70	800	Dipole	V	69.3	81.6	V V	6.7	23.05	39.00	-15.95
F0	1013	824.70	800	Dipole	H	81.6		H H	5.3			
F0	384	836.52	800	Dipole	V	70.5	90.9	V V	7.1	<b>23.45</b>	39.00	-15.55
F0	384	836.52	800	Dipole	H	80.9		H H	5.8			
F0	777	848.32	800	Dipole	V	69.8	80.1	V V	6.9	23.25	39.00	-15.75
F0	777	848.32	800	Dipole	H	80.1		H H	4.8			

ERP = Tracking Generator Level + Antenna Gain – Cable Loss + Preamp

Example: 824.70 MHz = 6.7 (Tracking Generator Level) – 7.8 (Antenna Loss) – 2.15 (Dipole Factor) – 3.8 (Cable Loss) + 30.1 (Preamp Gain) = 23.05 dBm (Reading Relative to Dipole)

### Radiated Emissions Test Data Results cont'd

Test distance was 3.0 metres.

Cellular Band

July 29, 2005

Bluetooth in frequency hopping mode during all spurious/harmonic/LO measurements.

EUT				Rx Antenna		Spectrum Analyzer		Substitution Method				
Type	Ch	Frequency (MHz)	Band	Type	Pol.	Reading (dBuV)	Max (V,H) (dBuV)	Pol. Tx-Rx	Reading (dBm)	Corrected Reading (relative to dipole)	Limit (dBm)	Diff to Limit (dB)
<b>Cellular Band (Harmonics)</b>												
Handheld Standalone, on its side												
<b>Low Channel – 824.70 MHz</b>												
2 <sup>nd</sup>	1013	1649.40	800	Horn	V	56.2	56.2	V-V	-48.0	-43.8	-13	-30.8
2 <sup>nd</sup>	1013	1649.40	800	Horn	H	54.5		H-H	-47.5			
3 <sup>rd</sup>	1013	2474.10	800	Horn	V	NF	NF	V-V		-	-13	
3 <sup>rd</sup>	1013	2474.20	800	Horn	H	NF		H-H				
The harmonics were investigated up to the 10 <sup>th</sup> harmonic. Emissions above the 3 <sup>rd</sup> harmonic were in the noise floor (NF)												
<b>Middle Channel – 836.52 MHz</b>												
2 <sup>nd</sup>	384	1673.04	800	Horn	V	56.8	57.5	V-V	-46.3	-42.5	-13	-29.5
2 <sup>nd</sup>	384	1673.04	800	Horn	H	57.5		H-H	-46.2			
3 <sup>rd</sup>	384	2509.56	800	Horn	V	NF	NF	V-V		-	-13	
3 <sup>rd</sup>	384	2509.56	800	Horn	H	NF		H-H				
The harmonics were investigated up to the 10 <sup>th</sup> harmonic. Emissions above the 3 <sup>rd</sup> harmonic were in the NF												
<b>High Channel – 848.32 MHz</b>												
2 <sup>nd</sup>	777	1696.64	800	Horn	V	57.4	57.6	V-V	-45.5	-41.7	-13	-28.7
2 <sup>nd</sup>	777	1696.64	800	Horn	H	57.6		H-H	-45.4			
3 <sup>rd</sup>	777	2544.96	800	Horn	V	NF	NF	V-V		-	-13	
3 <sup>rd</sup>	777	2544.96	800	Horn	H	NF		H-H				
The harmonics were investigated up to the 10 <sup>th</sup> harmonic. Emissions above the 3 <sup>rd</sup> harmonic were in the NF												

### Radiated Emissions Test Data Results cont'd

Test distance was 3.0 metres.

Cellular Band

July 29, 2005

EUT				Rx Antenna		Spectrum Analyzer		Substitution Method				
Type	Ch	Frequency (MHz)	Band	Type	Pol.	Reading (dBuV)	Max (V,H) (dBuV)	Pol. Tx-Rx	Reading (dBm)	Corrected Reading (relative to dipole) (dBm)	Limit (dBm)	Diff to Limit (dB)
<b>Cellular BAND</b> <b>RF Local Oscillator (LO)</b>  Handheld Standalone, vertical position <b><u>Low Channel</u></b>												
F0	1013	1739.40	800	Horn	V	NF		V-V			-13	
F0	1013	1739.40	800	Horn	H	NF		H-H				
Emissions were in the NF.												
<b><u>Middle Channel</u></b>												
F0	384	1763.04	800	Horn	V	NF		V-V			-13	
F0	384	1763.04	800	Horn	H	NF		H-H				
Emissions were in the NF.												
<b><u>High Channel</u></b>												
F0	777	1786.62	800	Horn	V	NF		V-V			-13	
F0	777	1786.62	800	Horn	H	NF		H-H				
Emissions were in the NF.												
<b>Cellular BAND (Harmonics)</b> EVDO transmit mode with the handheld in standalone vertical position. <b><u>Middle Channel</u></b> 836.52 MHz												
2 <sup>nd</sup>	384	1673.04	800	Horn	V	55.6	56.7	V-V	-47.5	-43.1	-13	-30.1
2 <sup>nd</sup>	384	1673.04	800	Horn	H	56.7		H-H	-46.9			
The harmonics were investigated up to the 10 <sup>th</sup> harmonic. Emissions above the 2 <sup>nd</sup> harmonic were in the NF												

### Radiated Emissions Test Data Results cont'd

Test distance was 3.0 metres.

PCS Band

July 29, 2005

								Substitution Method				
EUT				Receive Antenna		Spectrum Analyzer		Tracking Generator				
Type	Ch	Frequency (MHz)	Band	Type	Pol.	Reading (dBuV)	Max (V,H) dBuV	Pol. Tx-Rx	Reading (dBm)	Corrected Reading (relative to Isotropic Radiator) (dBm)	Limit (dBm)	Diff to Limit (dB)
<b>PCS BAND (EIRP)</b>												
Handheld Standalone, on its side												
F0	25	1851.25	1900	Horn	V	85.2	90.5	V-V	-8.6	28.2	33	-4.8
F0	25	1851.25	1900	Horn	H	90.5		H-H	-7.2			
F0	600	1880.00	1900	Horn	V	83.1	90.5	V-V	-8.3	<b>28.5</b>	33	-4.5
F0	600	1880.00	1900	Horn	H	90.5		H-H	-6.9			
F0	1175	1908.75	1900	Horn	V	80.6	90.2	V-V	-8.5	28.3	33	-4.7
F0	1175	1908.75	1900	Horn	H	90.2		H-H	-7.1			

EIRP = Tracking Generator Level + Antenna Factor – Cable Loss + Preamp Gain

Example: 1851.25 MHz = -7.2 (Tracking Generator Level) + 8.4 (Antenna Factor) – 5.6 (Cable Loss) + 32.6 (Preamp Gain) = 28.2 dBm (Reading Relative to Isotropic Radiator)



### Radiated Emissions Test Data Results cont'd

Test distance was 3.0 metres.

PCS Band

July 29, 2005

Bluetooth in frequency hopping mode during all spurious/harmonic/LO measurements.

								Substitution Method				
EUT				Receive Antenna		Spectrum Analyzer		Tracking Generator				
Type	Ch	Frequency (MHz)	Band	Pol. Type	Pol.	Reading (dBuV)	Max (V,H) (dBuV)	Pol. Tx-Rx	Reading (dBm)	Corrected Reading (relative to Isotropic Radiator) (dBm)	Limit (dBm)	Diff to Limit (dB)
<b>PCS BAND (Harmonics)</b>												
Handheld Standalone, vertical position												
<b>Low Channel</b> 1851.25 MHz												
2 <sup>nd</sup>	25	3702.50	1900	Horn	V	47.2	47.2	V-V	-40.1	-36.7	-13	-23.7
2 <sup>nd</sup>	25	3702.50	1900	Horn	H	45.2		H-H	-40.6			
3 <sup>rd</sup>	25	5553.75	1900	Horn	V	45.6	46.3	V-V	-32.5	-30.3	-13	-17.3
3 <sup>rd</sup>	25	5553.75	1900	Horn	H	46.3		H-H	-30.9			
The harmonics were investigated up to the 10th harmonic. Emissions above the 3 <sup>rd</sup> harmonic were in the NF												
<b>Middle Channel</b> 1880.00 MHz												
2 <sup>nd</sup>	600	3760.00	1900	Horn	V	47.3	47.3	V-V	--38.1	-34.7	-13	-21.7
2 <sup>nd</sup>	600	3760.00	1900	Horn	H	44.9		H-H	-38.4			
3 <sup>rd</sup>	600	5640.00	1900	Horn	V	46.4	46.4	V-V	-32.1	-30.5	-13	-17.5
3 <sup>rd</sup>	600	5640.00	1900	Horn	H	45.0		H-H	-31.1			
The harmonics were investigated up to the 10th harmonic. Emissions above the 3 <sup>rd</sup> harmonic were in the NF												

### Radiated Emissions Test Data Results cont'd

Test distance was 3.0 metres.

PCS Band

July 29, 2005

EUT								Substitution Method				
EUT				Receive Antenna		Spectrum Analyzer		Tracking Generator				
Type	Ch	Frequency (MHz)	Band	Type	Pol.	Reading (dBuV)	Max (V,H) (dBuV)	Pol. Tx-Rx	Reading (dBm)	Corrected Reading (relative to Isotropic Radiator) (dBm)	Limit (dBm)	Diff to Limit (dB)
<b>High Channel</b> 1908.75 MHz												
2 <sup>nd</sup>	117 5	3817.50	1900	Horn	V	47.0	47.0	V-V	-40.1	-36.6	-13	-23.6
2 <sup>nd</sup>	117 5	3817.50	1900	Horn	H	46.0		H-H	-40.0			
3 <sup>rd</sup>	117 5	5726.25	1900	Horn	V	46.5	46.5	V-V	-31.9	-30.2	-13	<b>-17.2</b>
3 <sup>rd</sup>	117 5	5726.25	1900	Horn	H	45.5		H-H	-30.8			
The harmonics were investigated up to the 10th harmonic. Emissions were in the NF.												
<b>PCS Band</b>												
<b>RF LO</b>												
Transmit mode with the handheld in standalone vertical position.												
<b>Low Channel</b>												
F0	25	1716.67	1900	Horn	V	NF	NF	V-V	NF	-	-13	-
F0	25	1716.67	1900	Horn	H	NF		H-H				
Emissions were in the NF.												
<b>Middle Channel</b>												
F0	600	1742.22	1900	Horn	V	NF	NF	V-V	NF	-	-13	-
F0	600	1742.22	1900	Horn	H	NF		H-H				
Emissions were in the NF.												

### Radiated Emissions Test Results cont'd

Test distance was 3.0 metres.

PCS Band

July 29, 2005

EUT				Rx Antenna		Spectrum Analyzer		Substitution Method				
Type	Ch	Frequency (MHz)	Band	Type	Pol.	Reading (dBuV)	Max (V,H) (dBuV)	Pol. Tx-Rx	Reading (dBm)	Corrected Reading (relative to Isotropic Radiator) (dBm)	Limit (dBm)	Diff to Limit (dB)
<b>PCS Band</b> <b>RF LO</b>  <b>High Channel</b>												
F0	1175	1767.78	1900	Horn	V	NF	NF	V-V			-13	
F0	1175	1767.78	1900	Horn	H	NF		H-H				
Emissions were in the NF.												
<b>PCS BAND (Harmonics)</b> EVDO transmit mode with the handheld in standalone upright position.												
<b>Middle Channel</b> 1880.00 MHz												
2 <sup>nd</sup>	600	3760.00	1900	Horn	V	47.6	47.6	V-V	-38.0	-34.6	-13	-21.6
2 <sup>nd</sup>	600	3760.00	1900	Horn	H	44.1		H-H	-39.2			
3 <sup>rd</sup>	600	5640.00	1900	Horn	V	45.1	45.2	V-V	-32.4	-30.3	-13	<b>-17.3</b>
3rd	600	5640.00	1900	Horn	H	45.2		H-H	-30.9			
The harmonics were investigated up to the 10th harmonic. Emissions above the 3 <sup>rd</sup> harmonic were in the NF												