

RTS RIM Testing Services	Document Hearing Aid Compatibility RF Emissions Test Report for BlackBerry 7130e Wireless Handheld Model RAV20CW		Page 1(23)
	Author Data Lauren Weber	Dates of Test July 05-08, 2005	Report No RTS-0181-0507-01

Hearing Aid Compatibility RF Emissions Test Report

Testing Lab:



RIM Testing Services (RTS)
305 Phillip Street
Waterloo, Ontario
Canada N2L 3W8
Phone: 519-888-7465
Fax: 519-880-8173

Applicant:

Research In Motion Limited
295 Phillip Street
Waterloo, Ontario
Canada N2L 3W8
Phone: 519-888-7465
Fax: 519-888-6906
Web site: www.rim.com

Statement of Compliance: RIM Testing Services (RTS) declares that the product was tested in accordance with the appropriate measurement standards, guidelines and recommended practices.

This wireless portable device has been shown to be in compliance with FCC 20.19 (10-1-04 Edition), Hearing Aid-Compatible Mobile Handsets.

	Signatures	Date
Tested and documented by:		
Daoud Attayi Compliance Specialist		18-July-2005
Lauren Weber Compliance Specialist		08-July-2005
Approved by:		
Paul G. Cardinal, Ph.D. Manager, RIM Testing Services		26-July-2005

RTS RIM Testing Services	Document Hearing Aid Compatibility RF Emissions Test Report for BlackBerry 7130e Wireless Handheld Model RAV20CW		Page 2(23)
	Author Data Lauren Weber	Dates of Test July 05-08, 2005	Report No RTS-0181-0507-01

CONTENTS

1.0 Introduction	3
2.0 Applicable standards	3
3.0 Equipment unit tested	4
4.0 List of equipment	5
5.0 Measurement procedures	6
6.0 Summary of results	15
7.0 Measurement uncertainty	18
8.0 Annexes	24

RTS RIM Testing Services	Document Hearing Aid Compatibility RF Emissions Test Report for BlackBerry 7130e Wireless Handheld Model RAV20CW		Page 3(23)
	Author Data Lauren Weber	Dates of Test July 05-08, 2005	Report No RTS-0181-0507-01

1.0 Introduction

This test report documents the measurement of the near electric and magnetic fields generated by a wireless communication device in the region where a hearing aid would be used. The measurement procedures of ANSI C63.19-2001 were followed along with the guidance provided by the FCC at the May 2005 TCBC workshop with the document "Hearing Aid Compatibility: RF Emissions Measurements TCB Review Guidance, 12 May 2005".

The electric and magnetic fields from a wireless device are scanned using a SPEAG DASY4 automated system with HAC extension and free-space probes (ER3DV_x and H3DV_x) in a 5cm x 5cm area, 10mm above the wireless device's acoustic output. The area is divided into 9 sub-grids and the maximum values of the electrical and a magnetic field scans are evaluated automatically according to the rules defined in the standard and the device is assigned a certain category. Should the wireless device's maximum T-Coil output occur in a location other than the centre of acoustic output, then the RF field scans are repeated with the measurement area centered on the maximum T-Coil output.

The DASY4 HAC Extension consists of the following parts: the Test Arch phantom, three validation dipoles, dipole and DUT holders, magnetic and electric field probes and DASY4 software. The field probes and measurement electronics are described in Annex B.1.

The specially designed Test Arch allows high precision positioning of both the device and any of the validation dipoles. The broadband dipoles are calibrated at a single frequency and are used for system performance checks.

In order to correlate the usability of a hearing aid with a wireless device (WD), the WD's radio frequency (RF) and audio band emissions are measured. ANSI C63.19 requires:

- Radio frequency (RF) measurements of the near-field electric and magnetic fields emitted by a WD in the vicinity of the audio output to categorize these emissions for correlation with the RF immunity of the microphone mode of operation of a hearing aid.
- Audio frequency magnetic field measurements of a WD emitted in the vicinity of the audio output to categorize these emissions for correlation with the T-Coil mode of operation of a hearing aid.

Hence, the following measurements are made for the WDs:

1. RF E-Field emissions.
2. RF H-Field emissions.
3. T-Coil mode, magnetic signal strength in the audio band.
4. T-Coil mode, magnetic signal and noise articulation index.
5. T-Coil mode, magnetic signal frequency response through the audio band.

2.0 Applicable standards

[1] ANSI C63.19-2001, Rev. 3.6 (which will become ANSI C63.19-2005), American National Standard for Methods of Measurement of Compatibility between Wireless Communication Devices and Hearing Aids.

[2] FCC 47CFR § 20.19 (10-1-04 Edition), Hearing Aid-Compatible Mobile Handsets.

RTS RIM Testing Services	Document Hearing Aid Compatibility RF Emissions Test Report for BlackBerry 7130e Wireless Handheld Model RAV20CW		Page 4(23)
	Author Data Lauren Weber	Dates of Test July 05-08, 2005	Report No RTS-0181-0507-01

3.0 Equipment unit tested

3.1 Picture of Handheld



Figure 1. BlackBerry Wireless Handheld

3.2 Handheld description

Handheld Model	RAV20CW		
FCC ID	L6ARAV20CW		
Serial / PIN Number	003B2 28		
Prototype or Production Unit	Production		
Mode(s) of Operation	CDMA 800	CDMA 1900	* Bluetooth
Transmitting Frequency Range	824.70-848.31 MHz	1851.25-1908.75 MHz	2402-2483MHz
Nominal Maximum conducted RF Output Power**	24.50 dBm	23.50 dBm	3.5 dBm
Tolerance in Power Setting on centre channel	± 0.50 dB	± 0.50 dB	N/A
Duty Cycle	1:1	1:1	N/A

Table 1. Test device characterization

*For this product, a headset is the only Bluetooth application. Therefore, HAC RF emission testing is not applicable to Bluetooth.

**The measured conducted power presented in the EMC, SAR and HAC reports are within 0.20dB of each other. The differences are due to the use of different test equipment.

3.3 Batteries

1. BAT-06860-001; Rated capacity: 1000 mAh
2. BAT-06860-001; Rated capacity: 1000 mAh (Alternate source)
3. BAT-06985-001; Rated capacity: 1780 mAh
4. BAT-06860-002; Rated capacity: 1000 mAh

RTS RIM Testing Services	Document Hearing Aid Compatibility RF Emissions Test Report for BlackBerry 7130e Wireless Handheld Model RAV20CW		Page 5(23)
	Author Data Lauren Weber	Dates of Test July 05-08, 2005	Report No RTS-0181-0507-01
		FCC ID L6ARAV20CW	

3.4 Antenna description

Type	Internal fixed antenna
Location	Bottom back centre
Configuration	Internal fixed antenna

Table 2. Antenna description

4.0 List of test equipment

Manufacturer	Test Equipment	Model Number	Serial Number	Calibration Due Date
SCHMID & Partner Engineering AG	Data Acquisition Electronics (DAE3)	DAE3 V1	472	03-Jan-06
SCHMID & Partner Engineering AG	3-Dimensional E-Field Probe for Near-Field	ER3DV6	2285	10-Dec-05
SCHMID & Partner Engineering AG	3-Dimensional H-Field Probe for Near-Field	H3DV6	6105	10-Dec-05
Rohde & Schwarz	Wireless Communication Test Set	CMU 200	104805	30-April-06
TEM Consulting, LP	T-Coil radial / axial probe	SBI 1092	N/A	04-Nov-05
Agilent	Multimeter	34401A	US36042322	26-July-05
Agilent	Signal Generator	8648C	4037U03155	01-Aug-05
Agilent	Signal Generator	E4433B	US38440672	27-July-05
Agilent	Spectrum Analyzer	8563E	3745A08112	20-July-05
Giga-tronics	Power Meter	8541C	1837762	03-Dec-05
Giga-tronics	Power Sensor	80401A	1835838	03-Dec-05
SCHMID & Partner Engineering AG	Validation Dipole	CD 835 V3	1011	24-Feb-06
SCHMID & Partner Engineering AG	Validation Dipole	CD 1880 V3	1008	23-Feb-06
Agilent	Wireless Communication Test Set	8960 Series E5515C	GB41070272	30-July-05

Table 3. List of test equipment

RTS RIM Testing Services	Document Hearing Aid Compatibility RF Emissions Test Report for BlackBerry 7130e Wireless Handheld Model RAV20CW		Page 6(23)
	Author Data Lauren Weber	Dates of Test July 05-08, 2005	Report No RTS-0181-0507-01

5.0 Measurement procedures

5.1 System Validation

The test setup should be validated when first configured and verified periodically thereafter to ensure proper function. The procedure consists of two parts: dipole validation and determination of probe modulation factor.

5.1.1 Dipole Validation

The HAC validation dipole antenna serves as a known source for an electrical and magnetic RF output. Figure 2 shows the setup used for the dipole validation.

1. The dipole antenna was placed in the position normally occupied by the WD.
2. The dipole was energized with a 20 dBm un-modulated continuous-wave signal.
3. The length of the dipole was scanned with both E-field and H-field probes and the maximum value for each scan was recorded.
4. The readings were compared with the values provided by the probe manufacturer and were found to agree within the allowed tolerance of 10%. Please refer to Annex A.3 for Dipole Validation Plots.

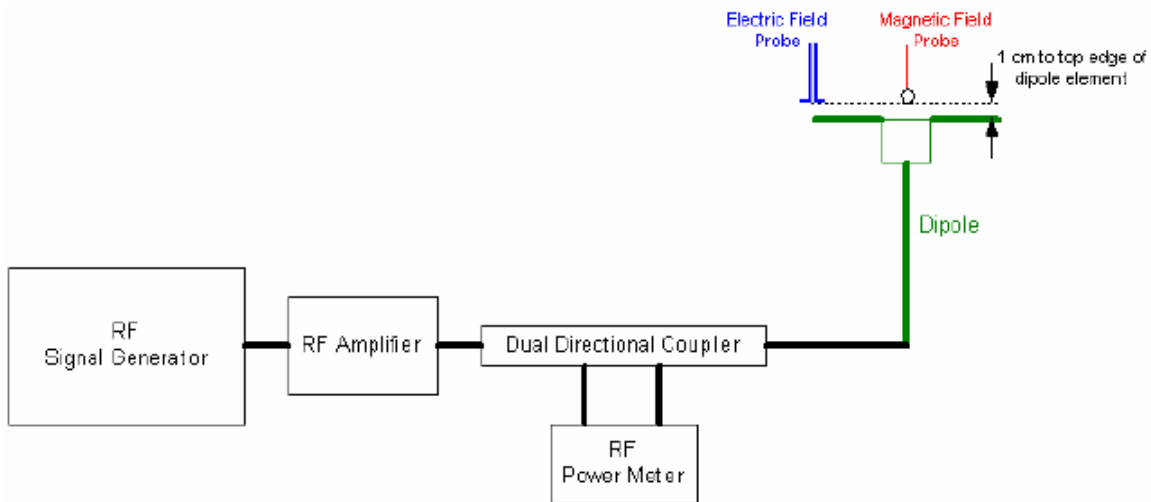

Figure 2: Dipole Validation Procedure

5.1.2 RF Field Probe Modulation Factor

The Probe Modulation Factor (PMF) characterizes the responses of the E-field and H-field probes and their instrumentation chain to a modulated signal. The PMF is the ratio of the responses to fields produced by CW and modulated signals having equal peak amplitude.

The PMF was calculated for the following signals: 80% AM and the modulated signal produced by the WD. The PMF measurement was performed with the field probe and instrumentation that will be used

RTS RIM Testing Services	Document Hearing Aid Compatibility RF Emissions Test Report for BlackBerry 7130e Wireless Handheld Model RAV20CW		Page 7(23)
	Author Data Lauren Weber	Dates of Test July 05-08, 2005	Report No RTS-0181-0507-01

together during RF emissions measurements. Once calculated, the PMF was entered into the DASY software and applied to the measured modulated fields of the specified type.

ANSI C63.19 outlines the following procedure as one method for determining probe modulation factor:

1. Fix the field probe in a set location relative to a field-generating device, such as the reference dipole antenna.
2. Illuminate the probe using the wireless device connected to the reference dipole with a test signal at the intended measurement frequency, Ensure there is sufficient field coupling between the probe and the antenna so the resulting reading is greater than 10 dB above the probe system noise floor but within the system's operating range.
3. Record the peak amplitude applied to the antenna during transmission and the field strength measured by the E-field probe located near the tip of the dipole antenna.³
4. Replace the wireless device with an RF signal generator producing an unmodulated CW signal and set to the wireless device operating frequency.
5. Set the amplitude of the unmodulated signal to equal that recorded from the wireless device.
6. Record the reading of the probe measurement system of the unmodulated signal.
7. The ratio, in linear units, of the probe reading in step 6 to the reading in step 3 is the E-field modulation factor.
- 8 Repeat the above using the H-field probe, except locate the probe at the center of the dipole.

³ The amplitude of the signal applied to the antenna may be measured in any of several ways, such as using a directional coupler to monitor the forward power to the antenna or by connecting the cable first to the spectrum analyzer and then to the antenna.

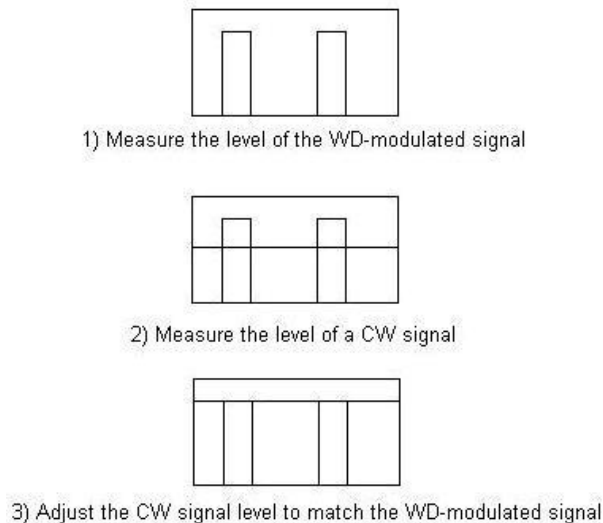

Figure 3: Setting the RF levels for determining the PMF (0 Hz span plots). The CW signal amplitude is adjusted to match the peak of the WD-modulated signal.

Please refer to Annex A.2 for 0 Hz-span spectrum analyzer plots. An Agilent E4433 signal generator was used to generate the CW and AM signals. The WD was used to generate the CDMA signals.

Please refer to Annex A.3 for probe modulation factor measurement plots.

RTS RIM Testing Services	Document Hearing Aid Compatibility RF Emissions Test Report for BlackBerry 7130e Wireless Handheld Model RAV20CW		Page 8(23)
	Author Data Lauren Weber	Dates of Test July 05-08, 2005	Report No RTS-0181-0507-01

The results of the dipole validation and probe modulation factor measurements are shown in Table 4.

f (MHz)	Signal Type	Average power (dBm)	Peak Envelop Power (dBm)	Measured E-Field (V/m)	Target E-Field (V/m)	Delta (%)	Mod. Factor Ratio
835	CW	20	20	167.2	160.4	+4.2	-
835	CW	-	12.5	71.6	67.6*	+5.9	-
835	80 % AM	-	12.5	44.4	37.6*	+18.0	1.61
835	CDMA full rate (WD)	-	12.5	71.5	67.6*	+5.8	1.001
835	CDMA 1/8 gating (WD)	-	12.5	25.1	23.90*	+4.8	2.85
1880	CW	-	20	132.3	135.4	-2.3	-
1880	CW	-	11.1	47.6	48.60*	-2.1	-
1880	80 % AM	-	11.1	30.0	27.01*	+11.0	1.59
1880	CDMA full rate (WD)	-	11.1	47.2	48.60*	-2.9	1.008
1880	CDMA 1/8 gating (WD)	-	11.1	16.6	17.18*	-3.4	2.87

f (MHz)	Signal Type	Average power (dBm)	Peak Envelop Power (dBm)	Measured H-Field (A/m)	Target H-Field (A/m)	Delta (%)	Mod. Factor Ratio
835	CW	20	20	0.415	0.442	-6.1	-
835	CW	-	12.5	0.181	0.186*	-2.9	-
835	80% AM	-	12.5	0.114	0.103*	+10.3	1.59
835	CDMA full rate (WD)	-	12.5	0.184	0.186*	-1.1	0.984
835	CDMA 1/8 gating (WD)	-	12.5	0.066	0.066*	0	2.74
1880	CW	-	20	0.405	0.444	-8.8	-
1880	CW	-	11.1	0.148	0.159*	-7.1	-
1880	80% AM	-	11.1	0.094	0.088*	+6.3	1.57
1880	CDMA full rate (WD)	-	11.1	0.145	0.159*	-8.8	1.02
1880	CDMA 1/8 gating (WD)	-	11.1	0.052	0.056*	-7.1	2.85

Table 4: Dipole Validation and Modulation Factors

*Not an official target value. Neither ANSI C63.19 nor the probe manufacturer give target values for AM and WD signals. The only available target values are for 20dBm CW signals.

Therefore, from the ratio of average input powers, the modulation factor target was determined for AM and WD signals. The manufacturer target value for CW was divided by the theoretical linear modulation factor to find target values for AM and WD signals. Please note that C63.19 requires values to be within 25% of their targets.

RTS RIM Testing Services	Document Hearing Aid Compatibility RF Emissions Test Report for BlackBerry 7130e Wireless Handheld Model RAV20CW		Page 9(23)
	Author Data Lauren Weber	Dates of Test July 05-08, 2005	Report No RTS-0181-0507-01

5.1.3.1 Calculation of Modulation Factor and Crest Factor:

1) Modulation Factor = Measured E or H-Field (CW) / Measured E or H-Field (Modulated)

E-Field Probe Modulation Factor for CDMA 835 band full rate = $71.6 / 71.5 = 1.001$

E-Field Probe Modulation Factor for CDMA 835 band 1/8 gating = $71.6 / 25.1 = 2.852$

E-Field Probe Modulation Factor for CDMA 1880 band full rate = $47.6 / 47.2 = 1.008$

E-Field Probe Modulation Factor for CDMA 1880 band 1/8 gating = $47.6 / 16.6 = 2.867$

H-Field Probe Modulation Factor for CDMA 835 band full rate = $0.181 / 0.184 = 0.984 \equiv 1.00^*$

H-Field Probe Modulation Factor for CDMA 835 band 1/8 gating = $0.181 / 0.066 = 2.742$

H-Field Probe Modulation Factor for CDMA 1880 band full rate = $0.148 / 0.145 = 1.021$

H-Field Probe Modulation Factor for CDMA 1880 band 1/8 gating = $0.148 / 0.052 = 2.846$

2) Crest Factor = (Modulation Factor)²

DASY4 calculates the modulation factor by taking the square root of the crest factor entered by the user.

E-Field Probe Crest Factor for CDMA 835 band full rate = $(1.001)^2 = 1.00$

E-Field Probe Crest Factor for CDMA 835 band 1/8 gating = $(2.852)^2 = 8.14$

E-Field Probe Crest Factor for CDMA 1880 band full rate = $(1.008)^2 = 1.02$

E-Field Probe Crest Factor for CDMA 1880 band 1/8 gating = $(2.867)^2 = 8.22$

H-Field Probe Crest Factor for CDMA 835 band full rate = $(0.984)^2 = 0.97 \equiv 1.00^*$

H-Field Probe Crest Factor for CDMA 835 band 1/8 gating = $(2.742)^2 = 7.52$

H-Field Probe Crest Factor for CDMA 1880 band full rate = $(1.021)^2 = 1.04$

H-Field Probe Crest Factor for CDMA 1880 band 1/8 gating = $(2.846)^2 = 8.10$

* In the DASY4 software program, a Crest Factor of 1.0 was used since CFs less than 1 are not allowed.

RTS RIM Testing Services	Document Hearing Aid Compatibility RF Emissions Test Report for BlackBerry 7130e Wireless Handheld Model RAV20CW		Page 10(23)
	Author Data Lauren Weber	Dates of Test July 05-08, 2005	Report No RTS-0181-0507-01

5.2 Near-Field RF Emission

The following procedure was used to measure RF near E-field and H-field emissions:

1. Proper operation of the field probe, probe measurement system, other instrumentation, and the positioning system was confirmed.
2. The WD was oriented in its intended test position with the reference plane in the horizontal plane (see Figure 4), and was secured in the device holder to maintain position accuracy.
3. An Agilent 8960 Base Station Simulator was used to place a normal voice call to the WD on the desired channel. Radio Configuration mode 3 was used. The Base Station Simulator's Power Control was set to "all up bits" to force the WD to transmit at maximum power.
4. The DASY4 system measures power drift as part of each scan. If the power during a scan drifted by more than 0.25dB, the scan was repeated. Power drift measurements for the worst-case scans are included in Annex A.4. A fully charged battery was used for each test.
5. The 5cm x 5cm measurement grid was centered on the center of the acoustic output or the T-Coil output, as appropriate. The field probe was located at the initial position at the center of the measurement grid.
6. A surface verification was performed before each setup change to ensure repeatable spacing and proper maintenance of the measurement plane.
7. The electric field probe, and separately the magnetic field probe, were used to measure the highest field strength in the 5cm x 5cm reference plane.
8. The entire 5cm x 5cm region was scanned with a 5mm step size. The reading was recorded at each measurement location. Justification of the step size and interpolation used is provided at the end of Annex A.3.
9. Around the center sub-grid, five contiguous sub-grids were identified with the lowest maximum field strength readings. Please note that a maximum of five sub-grids can be excluded for both E- and H-field measurements.
10. The highest field reading was identified within the non-excluded sub-grids
11. The highest field reading was converted from average to peak V/m or A/m, as appropriate. This conversion was done by multiplying by the probe modulation factor. In the plots, DASY4 refers to the average readings as "Time averaged" and the peak values as "Slot averaged".
12. Once the worst-case configuration was determined, the WD was tested in 1/8 gating mode (12.5% data rate). Results are shown in Tables 8 and 9.
13. In the worst-case configuration, the probe was rotated 360° about the azimuth axis at the location of the highest field strength in the included blocks. The peak reading from this rotation was recorded and the maximum field was recalculated.
14. The highest peak reading was compared to the categories defined in C63.19 using the appropriate AWF (see Tables 5 and 6 in this report).

- If a WD has more than one antenna position, it is necessary to test the WD only in the condition of maximum antenna efficiency, i.e. antenna extended.
- The WD's backlight shuts off automatically a short time after a call is established.

RTS RIM Testing Services	Document Hearing Aid Compatibility RF Emissions Test Report for BlackBerry 7130e Wireless Handheld Model RAV20CW		Page 11(23)
	Author Data Lauren Weber	Dates of Test July 05-08, 2005	Report No RTS-0181-0507-01

Table 5 shows the ANSI C63.19 M-rating categories for Wireless Device RF emissions. Table 6 outlines the Articulation Weighting Factors for various cellular technologies.

Category	Telephone RF Parameters				
Near Field	AWF	E-Field Emissions (Peak)		H-Field Emissions (Peak)	
Category M1	0	199.5 – 354.8	V/m	0.60 – 1.07	A/m
	-5	149.6 – 266.1	V/m	0.45 – 0.80	A/m
Category M2	0	112.2 – 199.5	V/m	0.34 – 0.60	A/m
	-5	84.1 – 149.6	V/m	0.25 – 0.45	A/m
Category M3	0	63.1 – 112.2	V/m	0.19 – 0.34	A/m
	-5	47.3 – 84.1	V/m	0.14 – 0.25	A/m
Category M4	0	<63.1	V/m	<0.19	A/m
	-5	<47.3	V/m	<0.14	A/m

Category	Telephone RF Parameters				
Near Field	AWF	E-Field Emissions (Peak)		H-Field Emissions (Peak)	
Category M1	0	46 – 51	dB (V/m)	-4.4 – 0.6	dB (A/m)
	-5	43.5 – 48.5	dB (V/m)	-6.9 – -1.9	dB (A/m)
Category M2	0	41 – 46	dB (V/m)	-9.4 – -4.4	dB (A/m)
	-5	38.5 – 43.5	dB (V/m)	-11.9 – -6.9	dB (A/m)
Category M3	0	36 – 41	dB (V/m)	-14.4 – -9.4	dB (A/m)
	-5	33.5 – 38.5	dB (V/m)	-16.9 – -11.9	dB (A/m)
Category M4	0	<36	dB (V/m)	<-14.4	dB (A/m)
	-5	<33.5	dB (V/m)	<-16.9	dB (A/m)

Table 5: Wireless Device near-field categories

Standard	Technology	AWF (dB)
TIA/EIA/IS-2000	CDMA	0
TIA/EIA-136	TDMA (50 Hz)	0
J-STD-007	GSM (217)	-5
T1/T1P1/3GPP	UMTS (WCDMA)	0
iDEN™	TDMA (22 and 11 Hz)	0

Table 6: Articulation Weighting Factor (AWF)

RTS RIM Testing Services	Document Hearing Aid Compatibility RF Emissions Test Report for BlackBerry 7130e Wireless Handheld Model RAV20CW		Page 12(23)
	Author Data Lauren Weber	Dates of Test July 05-08, 2005	Report No RTS-0181-0507-01

Figures 4 and 5 show the orientation of the WD in the reference plane.

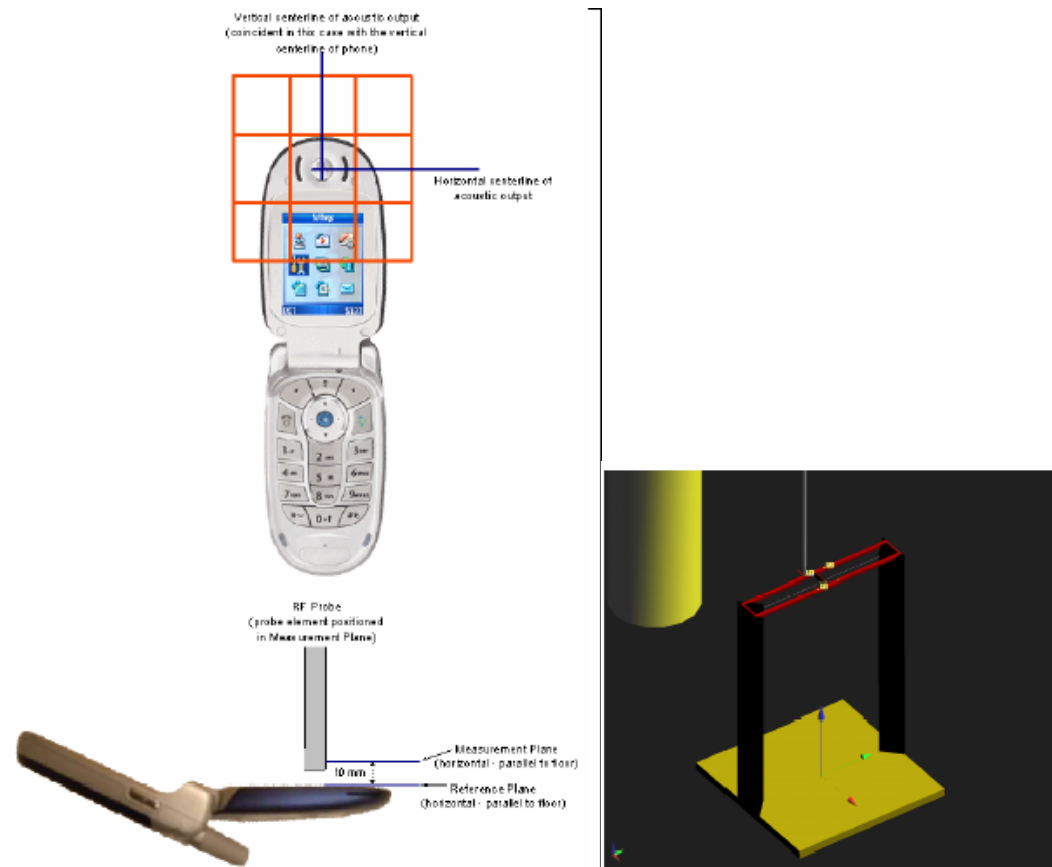

Figure 4: WD reference plane for RF emission measurements **Figure 5: HAC Phantom/Test Arch**

5.3 Wireless Device Audio Band Magnetic Signal Test

- The Audio Band Magnetic (ABM) test run for this report was solely for the purpose of locating the centre of the T-Coil output, not to determine if the WD is in compliance with the T-Coil requirements of ANSI C63.19.

The Audio Band Magnetic Field or T-Coil output of a wireless device is measured using an EM Scan automated system from TEM Consulting. This consists of a Magnetic Field T-Coil Axial Probe, Sound Level Meter, Voltmeter and accompanying software. The scan is performed in a 5cm x 5cm area, 10mm above the acoustic output as shown in Figure 7. The location of the maximum field strength is referred to as the centre of the T-Coil.

The measurement shall not include undesired properties from the WD's RF field. By replacing the antenna with a coaxial cable providing a conducted connection, undesired RF emissions from the WD's transmitter can be excluded.

RTS RIM Testing Services	Document Hearing Aid Compatibility RF Emissions Test Report for BlackBerry 7130e Wireless Handheld Model RAV20CW		Page 13(23)
	Author Data Lauren Weber	Dates of Test July 05-08, 2005	Report No RTS-0181-0507-01

ANSI C63.19 describes the procedure as follows:

1. Position the WD in the test setup and connect the WD RF connector to a base station simulator or a non-radiating load.
2. Set the reference drive level for the system with the maximum volume control setting or as specified by the manufacturer. The drive level is set such that the reference input level is input to the base station simulator (or manufacturer's test mode equivalent) in the 1 kHz, 1/3 octave band. This drive level shall be used for the audio band signal test (ABM1 at f). Either a sine wave at 1025 Hz or a voice-like signal shall be used for the reference audio signal. If interference is found at 1025 Hz an alternate reference audio signal frequency may be used. The same drive level will be used for the ABM1 frequency response measurements at each 1/3-octave band center frequency.

The following reference input levels that correlate to a normal speech input level shall be used for the standard transmission protocols.

STANDARD	TECHNOLOGY	INPUT (dBm0)
TIA/EIA/IS-2000	CDMA	-18 dBm0
TIA/EIA/IS-136	TDMA (50 Hz)	-18 dBm0
J-STD-007	GSM (217 Hz)	-16 dBm0
iDEN	TDMA (22 and 11 Hz)	-18 dBm0

Table 7 – Reference input level for normal speech input level

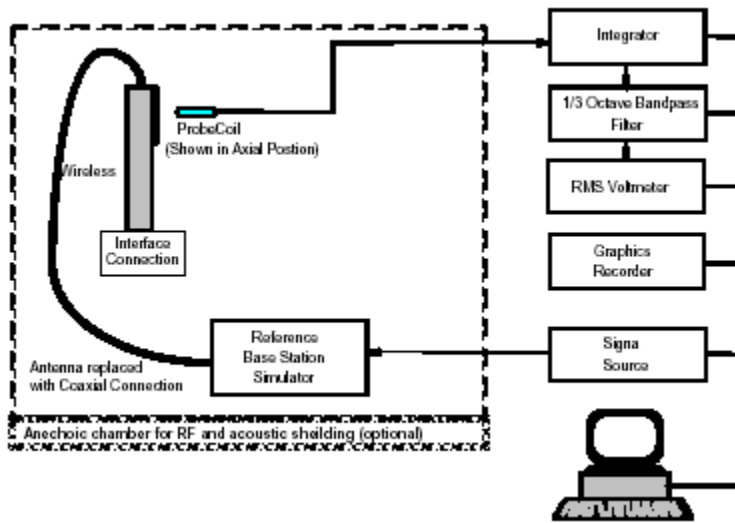

Figure 6: Magnetic field measurement test setup – in call method

RTS RIM Testing Services	Document Hearing Aid Compatibility RF Emissions Test Report for BlackBerry 7130e Wireless Handheld Model RAV20CW		Page 14(23)
	Author Data Lauren Weber	Dates of Test July 05-08, 2005	Report No RTS-0181-0507-01

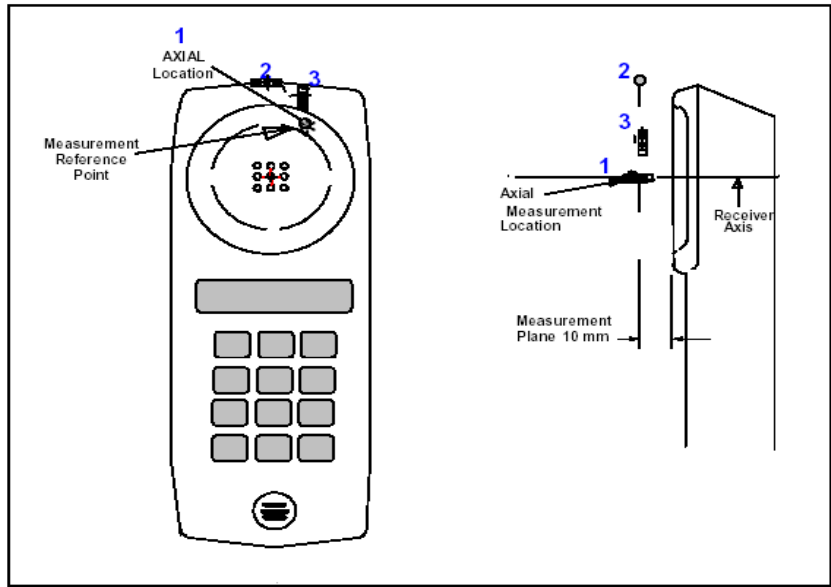

Figure 7: Axis & planes for WD audio frequency magnetic field measurements

RTS RIM Testing Services	Document Hearing Aid Compatibility RF Emissions Test Report for BlackBerry 7130e Wireless Handheld Model RAV20CW		Page 15(23)
	Author Data Lauren Weber	Dates of Test July 05-08, 2005	Report No RTS-0181-0507-01
		FCC ID L6ARAV20CW	

6.0 Summary of results

Table 8 shows the results of the RF near-field (E-Field) emissions tests. The worst-case result is highlighted.

Wireless Device: BlackBerry Wireless Handheld – Model: RAV20CW									
RF Emissions Test									
Mode	f (MHz)	Cond. Power (dBm)	Peak E-Field (V/m)	Peak E-Field after 360° Rotation* (V/m)	Centered at mid Speaker or T-Coil	Data Rate	Batt #	M-Rating	Excl. Blocks after re-evaluation **
CDMA 800	824.7	24.9	84.0	-	Speaker	1	1	3	-
	836.52	25.0	89.7	90.9	Speaker	1	1	3	-
	848.52	24.9	86.3	-	Speaker	1	1	3	-
	824.7	-	82.0	-	T-Coil	1	1	3	-
	836.52	-	87.8	-	T-Coil	1	1	3	-
	848.52	-	83.4	-	T-Coil	1	1	3	-
	836.52	-	86.9	-	Speaker	1	2	3	-
	836.52	-	80.3	-	Speaker	1	3	3	-
	836.52	-	88.2	-	Speaker	1	4	3	-
CDMA 1900	836.52	-	88.2	-	Speaker	1/8	1	3	-
	1851.25	24.0	67.5	-	Speaker	1	1	3	-
	1880.00	23.9	68.2	-	Speaker	1	1	3	-
	1908.50	24.0	65.9	-	Speaker	1	1	3	-
	1851.25	-	69.0	-	T-Coil	1	1	3	-
	1880.00	-	66.6	-	T-Coil	1	1	3	-
	1908.50	-	63.3	-	T-Coil	1	1	3	-
	1851.25	-	67.3	-	T-Coil	1	2	3	-
	1851.25	-	64.8	-	T-Coil	1	3	3	-
1851.25	-	69.2	-	T-Coil	1	4	3	-	
1851.25	-	69.2	-	T-Coil	1/8	4	3	-	
Overall M-Rating:								M3	

Table 8 – E-Field Data Summary

*In accordance with the TCB guidance, the probe was rotated 360° in the worst-case configuration. The rotation was performed at the location of maximum field strength in the included blocks. This location was found by exporting the data from the worst-case scan to a spreadsheet and finding the point of highest field strength in the non-excluded blocks. The robot then moved the probe to the coordinates of this point to do the rotation.

** In cases where the E and H field scans did not share at least one common exclusion block, the blocks were re-evaluated manually for one of the two fields.

RTS RIM Testing Services	Document Hearing Aid Compatibility RF Emissions Test Report for BlackBerry 7130e Wireless Handheld Model RAV20CW		Page 16(23)
	Author Data Lauren Weber	Dates of Test July 05-08, 2005	Report No RTS-0181-0507-01
		FCC ID L6ARAV20CW	

Table 9 shows the results of the RF near-field (H-Field) emissions tests. The worst-case result is highlighted.

Wireless Device: BlackBerry Wireless Handheld – Model: RAV20CW									
RF Emissions Test									
Mode	f (MHz)	Cond. Power (dBm)	Peak H-Field (A/m)	Peak H-Field after 360° Rotation* (A/m)	Center at mid Speaker or T-Coil	Data Rate	Batt #	M-Rating	Excl. Blocks after re-evaluation **
CDMA 800	824.7	-	0.115	-	Speaker	1	1	4	-
	836.52	-	0.134	-	Speaker	1	1	4	-
	848.52	-	0.118	-	Speaker	1	1	4	-
	824.7	-	0.102	-	T-Coil	1	1	4	-
	836.52	-	0.122	-	T-Coil	1	1	4	-
	848.52	-	0.107	-	T-Coil	1	1	4	-
	836.52	-	0.134	-	Speaker	1	2	4	-
	836.52	-	0.124	-	Speaker	1	3	4	-
	836.52	-	0.131	-	Speaker	1	4	4	-
CDMA 1900	836.52	-	0.129	-	Speaker	1/8	1	4	-
	1851.25	-	0.183	-	Speaker	1	1	4	-
	1880.00	-	0.196	0.204	Speaker	1	1	3	-
	1908.50	-	0.181	-	Speaker	1	1	4	-
	1851.25	-	0.172	-	T-Coil	1	1	4	-
	1880.00	-	0.189	-	T-Coil	1	1	4	-
	1908.50	-	0.176	-	T-Coil	1	1	4	-
	1880.00	-	0.193	-	Speaker	1	2	3	-
	1880.00	-	0.191	-	Speaker	1	3	3	-
1880.00	-	0.193	-	Speaker	1	4	3	-	
1880.00	-	0.194	-	Speaker	1/8	1	3	-	
Overall M-Rating:								M3	

Table 9 – H-Field Data Summary

*In accordance with the TCB guidance, the probe was rotated 360° in the worst-case configuration. The rotation was performed at the location of maximum field strength in the included blocks. This location was found by exporting the data from the worst-case scan to a spreadsheet and finding the point of highest field strength in the non-excluded blocks. The robot then moved the probe to the coordinates of this point to do the rotation.

** In cases where the E and H field scans did not share at least one common exclusion block, the blocks were re-evaluated manually for one of the two fields.

RTS RIM Testing Services	Document Hearing Aid Compatibility RF Emissions Test Report for BlackBerry 7130e Wireless Handheld Model RAV20CW		Page 17(23)
	Author Data Lauren Weber	Dates of Test July 05-08, 2005	Report No RTS-0181-0507-01

6.1 Conclusion

The RIM BlackBerry 7130e Wireless Handheld Model Number RAV20CW is categorized to be M3 based on RF performance in accordance with ANSI C63.19-2001, Rev. 3.6: American National Standard for Methods of Measurement of Compatibility between Wireless Communication Devices and Hearing Aids.

Therefore, the handheld is found to be in compliance with the requirements of FCC 20.19 (10-1-04 Edition) Hearing Aid-Compatible Mobile Handsets.

RTS RIM Testing Services	Document Hearing Aid Compatibility RF Emissions Test Report for BlackBerry 7130e Wireless Handheld Model RAV20CW		Page 18(23)
	Author Data Lauren Weber	Dates of Test July 05-08, 2005	Report No RTS-0181-0507-01

7.0 Measurement uncertainty

Table 10 outlines the measurement uncertainty for the SPEAG DASY4 measurement system.

HAC Uncertainty Budget According to ANSI C63.19 [1]							
Error Description	Uncertainty value	Prob. Dist.	Div.	(c_1) E	(c_1) H	Std. Unc. E	Std. Unc. H
Measurement System							
Probe Calibration	±5.1 %	N	1	1	1	±5.1 %	±5.1 %
Axial Isotropy	±4.7 %	R	$\sqrt{3}$	1	1	±2.7 %	±2.7 %
Sensor Displacement	±16.5 %	R	$\sqrt{3}$	1	0.145	±9.5 %	±1.4 %
Boundary Effects	±2.4 %	R	$\sqrt{3}$	1	1	±1.4 %	±1.4 %
Linearity	±4.7 %	R	$\sqrt{3}$	1	1	±2.7 %	±2.7 %
Scaling to Peak Envelope Power	±2.0 %	R	$\sqrt{3}$	1	1	±1.2 %	±1.2 %
System Detection Limit	±1.0 %	R	$\sqrt{3}$	1	1	±0.6 %	±0.6 %
Readout Electronics	±0.3 %	N	1	1	1	±0.3 %	±0.3 %
Response Time	±0.8 %	R	$\sqrt{3}$	1	1	±0.5 %	±0.5 %
Integration Time	±2.6 %	R	$\sqrt{3}$	1	1	±1.5 %	±1.5 %
RF Ambient Conditions	±3.0 %	R	$\sqrt{3}$	1	1	±1.7 %	±1.7 %
RF Reflections	±12.0 %	R	$\sqrt{3}$	1	1	±6.9 %	±6.9 %
Probe Positioner	±1.2 %	R	$\sqrt{3}$	1	0.67	±0.7 %	±0.5 %
Probe Positioning	±4.7 %	R	$\sqrt{3}$	1	0.67	±2.7 %	±1.8 %
Extrap. and Interpolation	±1.0 %	R	$\sqrt{3}$	1	1	±0.6 %	±0.6 %
Test Sample Related							
Device Positioning Vertical	±4.7 %	R	$\sqrt{3}$	1	0.67	±2.7 %	±1.8 %
Device Positioning Lateral	±1.0 %	R	$\sqrt{3}$	1	1	±0.6 %	±0.6 %
Device Holder and Phantom	±2.4 %	R	$\sqrt{3}$	1	1	±1.4 %	±1.4 %
Power Drift	±5.0 %	R	$\sqrt{3}$	1	1	±2.9 %	±2.9 %
Phantom and Setup Related							
Phantom Thickness	±2.4 %	R	$\sqrt{3}$	1	0.67	±1.4 %	±0.9 %
Combined Std. Uncertainty						±14.7 %	±10.9 %
Expanded Std. Uncertainty on Power						±29.4 %	±21.8 %
Expanded Std. Uncertainty on Field						±14.7 %	±10.9 %

Table 10. Worst-Case uncertainty budget for HAC free field assessment according to ANSI C63.19.

[1] The budget is valid for the frequency range 800 MHz - 3 GHz and represents a worst-case analysis.

RTS RIM Testing Services	Document Hearing Aid Compatibility RF Emissions Test Report for BlackBerry 7130e Wireless Handheld Model RAV20CW		Page 19(23)
	Author Data Lauren Weber	Dates of Test July 05-08, 2005	Report No RTS-0181-0507-01

7.1 Site-Specific Uncertainty

RF Reflections

Section 4.2 of ANSI C63.19 requires that any RF reflecting objects are a minimum distance of 2 wavelengths away from the WD under test. For this WD, the longest wavelength occurs when the WD is transmitting at 824.7MHz. The wavelength is:

$$\lambda = \frac{c}{f} = \frac{3 \cdot 10^8 \text{ m/s}}{824.7 \text{ MHz}} = 0.364 \text{ m}$$

Therefore, 2 wavelengths result in a distance of 0.73m. Tests are performed in an RF shielded chamber. The distance to the nearest wall is >1m and the distance to the robot's safety guardrail is ~1.0m, both satisfying the requirement. In addition, RF absorbing cones are placed at the base of the robot to further reduce reflections. The HAC phantom arch is made of low dielectric constant plastic and should not be a source of reflections.

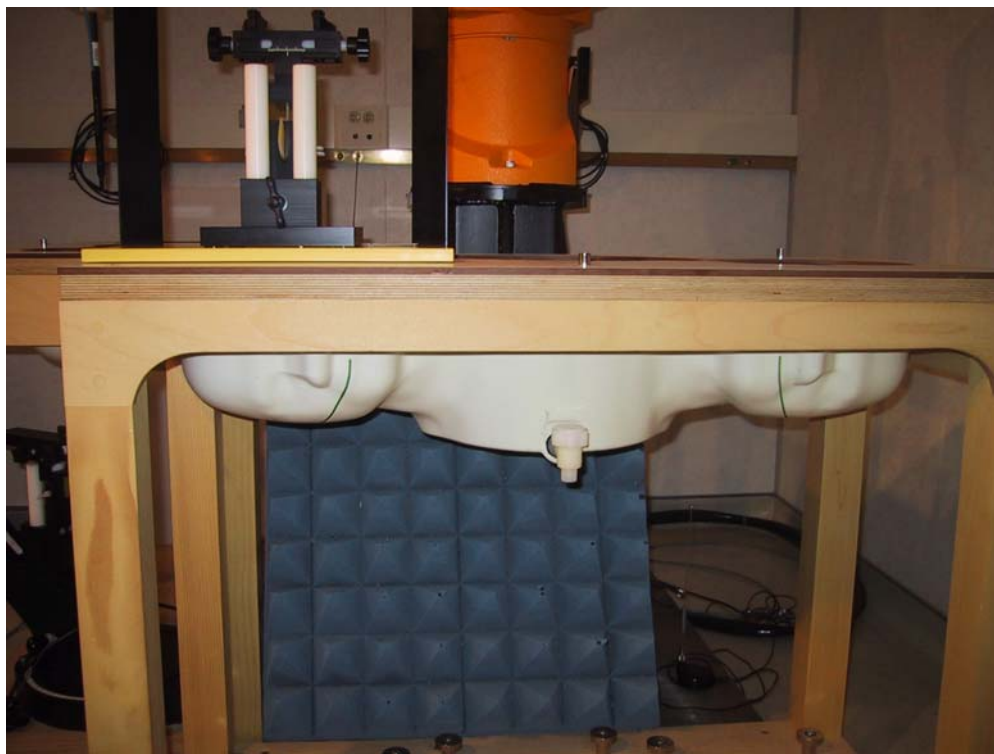

Figure 8: DASY4 system with absorbing material

Environmental Conditions

During measurements, the temperature of the test lab was kept between 21°C and 25°C and relative humidity was maintained between 20% and 55%.

RTS RIM Testing Services	Document		Page
	Hearing Aid Compatibility RF Emissions Test Report for BlackBerry 7130e Wireless Handheld Model RAV20CW		20(23)
Author Data Lauren Weber	Dates of Test July 05-08, 2005	Report No RTS-0181-0507-01	FCC ID L6ARAV20CW

Ambient Noise

C63.19 requires ambient noise to be at least 20dB below the measurement level. Scans of ambient fields were performed for verification. The ambient E-Field level was determined to be 3.03V/m and the ambient H-field level 0.001A/m. The ambient noise was determined to be more than ~32 dB below the dipole validation results with an input power of 20 dBm. Plots of ambient field scans follow.

Date/Time: 14/07/2005 11:22:49 AM

Page 1 of 2

Date/Time: 14/07/2005 11:22:49 AM

Lab: RIM Testing Services (RTS)

Ambient measurement_E-Field

DUT: HAC Dipole 1880 MHz; Type: CD1880V3

Communication System: CW; Frequency: 1880 MHz;Duty Cycle: 1:1
 Medium: Air Medium parameters used: $\sigma = 0$ mho/m, $\epsilon_r = 1$; $\rho = 1000$ kg/m³
 Phantom section: H Device Section

DASY4 Configuration:
 - Probe: ER3DV6 - SN2285; ConvF(1, 1, 1); Calibrated: 10/12/2004
 - Sensor-Surface: 0mm (Fix Surface)Sensor-Surface: (Fix Surface)
 - Electronics: DAE3 Sn472; Calibrated: 03/01/2005
 - Phantom: HAC Test Arch; Type: SD HAC P01 BA;
 - Measurement SW: DASY4, V4.5 Build 19; Postprocessing SW: SEMCAD, V1.8 Build 146

E Scan 10mm above CD 1880 MHz/Hearing Aid Compatibility Test (5x19x1):

Measurement grid: dx=5mm, dy=5mm
 Maximum value of Total (measured) = 1.43 V/m

E Scan 10mm above CD 1880 MHz/Hearing Aid Compatibility Test (41x181x1):

Measurement grid: dx=5mm, dy=5mm
 Maximum value of Total field (slot averaged) = 3.03 V/m
Hearing Aid Near-Field Category: M4 (AWF 0 dB)

E in V/m (Time averaged) E in V/m (Slot averaged)

Grid 1	Grid 2	Grid 3	Grid 1	Grid 2	Grid 3
1.62	1.94	2.67	1.62	1.94	2.67
Grid 4	Grid 5	Grid 6	Grid 4	Grid 5	Grid 6
2.04	3.03	2.59	2.04	3.03	2.59
Grid 7	Grid 8	Grid 9	Grid 7	Grid 8	Grid 9
2.23	1.57	1.91	2.23	1.57	1.91

Category	AWF (dB)	Limits for E-Field Emissions (V/m)	Limits for H-Field Emissions (A/m)
M1	0	199.5 - 354.8	0.6 - 1.07
	-5	149.6 - 266.1	0.45 - 0.8
M2	0	112.2 - 199.5	0.34 - 0.6
	-5	84.1 - 149.6	0.25 - 0.45
M3	0	63.1 - 112.2	0.19 - 0.34
	-5	47.3 - 84.1	0.15 - 0.25
M4	0	<63.1	<0.19

file://C:\Program%20Files\DASY4\Print_Templates\Ambient%20measurement_E-Field-... 14/07/2005

RTS RIM Testing Services	Document Hearing Aid Compatibility RF Emissions Test Report for BlackBerry 7130e Wireless Handheld Model RAV20CW		Page 21(23)
	Author Data Lauren Weber	Dates of Test July 05-08, 2005	Report No RTS-0181-0507-01

Date/Time: 14/07/2005 11:22:49 AM

Page 2 of 2

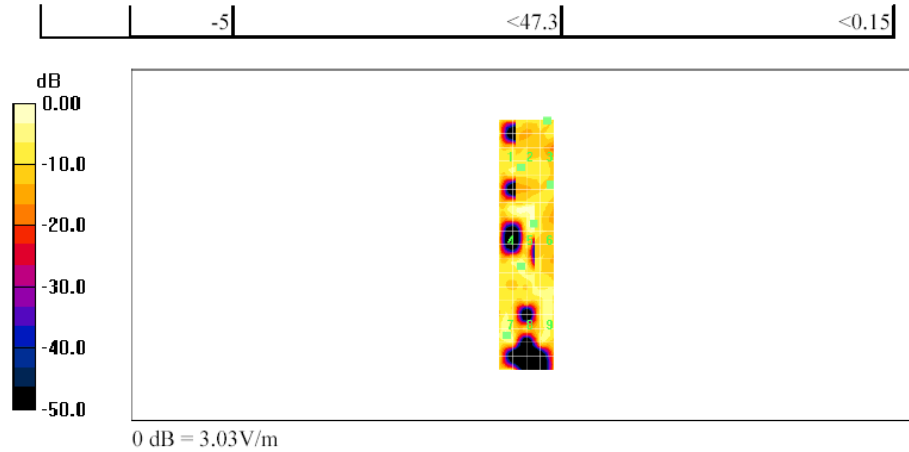

file://C:\Program%20Files\DASY4\Print_Templates\Ambient%20measurement_E-Field-... 14/07/2005

RTS RIM Testing Services	Document Hearing Aid Compatibility RF Emissions Test Report for BlackBerry 7130e Wireless Handheld Model RAV20CW		Page 22(23)
	Author Data Lauren Weber	Dates of Test July 05-08, 2005	Report No RTS-0181-0507-01

Date/Time: 14/07/2005 12:36:18 PM

Page 1 of 2

Date/Time: 14/07/2005 12:36:18 PM

Lab: RIM Testing Services (RTS)

Ambient noise 1880_H_Field

DUT: HAC Dipole 1880 MHz; Type: CD1880V3

Communication System: CW; Frequency: 1880 MHz; Duty Cycle: 1:1
Medium: Air Medium parameters used: $\sigma = 0$ mho/m, $\epsilon_r = 1$; $\rho = 1$ kg/m³
Phantom section: H Dipole Section

DASY4 Configuration:

- Probe: H3DV6 - SN6105; ; Calibrated: 10/12/2004
- Sensor-Surface: 0mm (Fix Surface) Sensor-Surface: (Fix Surface)
- Electronics: DAE3 Sn472; Calibrated: 03/01/2005
- Phantom: HAC Test Arch; Type: SD HAC P01 BA;
- Measurement SW: DASY4, V4.5 Build 19; Postprocessing SW: SEMCAD, V1.8 Build 146

H Scan 10mm above CD 1880 MHz/Hearing Aid Compatibility Test (5x19x1):

Measurement grid: dx=5mm, dy=5mm
Maximum value of Total (measured) = 0.00 A/m

H Scan 10mm above CD 1880 MHz/Hearing Aid Compatibility Test (41x181x1):

Measurement grid: dx=5mm, dy=5mm
Maximum value of Total field (slot averaged) = 0.00 A/m

Hearing Aid Near-Field Category: M4 (AWF 0 dB)

H in A/m (Time averaged) H in A/m (Slot averaged)

Grid 1	Grid 2	Grid 3	Grid 1	Grid 2	Grid 3
0.00	0.00	0.00	0.00	0.00	0.00
Grid 4	Grid 5	Grid 6	Grid 4	Grid 5	Grid 6
0.00	0.00	0.00	0.00	0.00	0.00
Grid 7	Grid 8	Grid 9	Grid 7	Grid 8	Grid 9
0.00	0.00	0.00	0.00	0.00	0.00

Category	AWF (dB)	Limits for E-Field Emissions (V/m)	Limits for H-Field Emissions (A/m)
M1	0	199.5 - 354.8	0.6 - 1.07
	-5	149.6 - 266.1	0.45 - 0.8
M2	0	112.2 - 199.5	0.34 - 0.6
	-5	84.1 - 149.6	0.25 - 0.45
M3	0	63.1 - 112.2	0.19 - 0.34
	-5	47.3 - 84.1	0.15 - 0.25
M4	0	<63.1	<0.19

file://C:\Program%20Files\DASY4\Print_Templates\Ambient%20noise%201880_H_Fiel... 14/07/2005

RTS RIM Testing Services	Document Hearing Aid Compatibility RF Emissions Test Report for BlackBerry 7130e Wireless Handheld Model RAV20CW		Page 23(23)
	Author Data Lauren Weber	Dates of Test July 05-08, 2005	Report No RTS-0181-0507-01

Date/Time: 14/07/2005 12:36:18 PM

Page 2 of 2

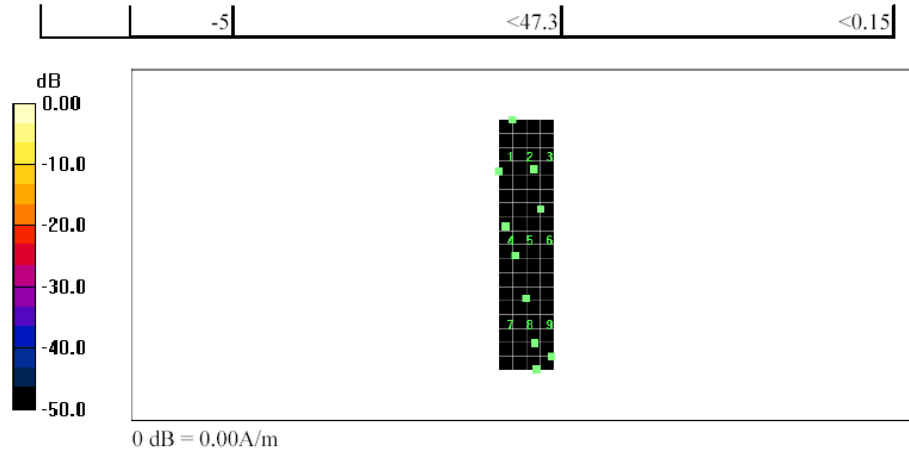

file://C:\Program%20Files\DASY4\Print_Templates\Ambient%20noise%201880_H_Fiel... 14/07/2005