 RESEARCH IN MOTION	Document		Page
	SAR Compliance Test Report for foam holsters with BlackBerry Wireless Handheld Model No. RAO30GN		1(1)
Author Data	Dates of Test	Test Report No	FCC ID:
Daoud Attayi	Oct. 31 – Nov. 04, 2003	RIM-0073-0311-01	L6ARAO30GN

SAR Compliance Test Report



Testing Lab:	Research In Motion Limited 305 Phillip Street Waterloo, Ontario Canada N2L 3W8 Phone: 519-888-7465 Fax: 519-880-8173 Web site: www.rim.net	Applicant:	Research In Motion Limited 295 Phillip Street Waterloo, Ontario Canada N2L 3W8 Phone: 519-888-7465 Fax: 519-888-6906 Web site: www.rim.net
---------------------	--	-------------------	--

Statement of Compliance: Research In Motion Limited, declares under its sole responsibility that the product to which this declaration relates, is in conformity with the appropriate RF exposure standards, recommendations and guidelines. It also declares that the product was tested in accordance with the appropriate measurement standards, guidelines and recommended practices. Any deviations from these standards, guidelines and recommended practices are noted below:

(none)

Device Category: This wireless handheld is a portable device, designed to be used in direct contact with the user's head, hand and to be carried in approved accessories when carried on the user's body.

RF exposure environment: This wireless portable device has been shown to be in compliance for localized specific absorption rate (SAR) for uncontrolled environment/general population exposure limits specified in OET Bulletin 65 Supplement C (Edition 01-01), FCC 96-326 and IEEE Std. C95.1-1999 and had been tested in accordance with the measurement procedures specified in OET Bulletin 65 Supplement C (Edition 01-01) and ANSI/IEEE Std. C95.3-1991.

Approved by:	Signatures	Date
Paul G. Cardinal, Ph.D. Manager, Compliance & Certification		Nov. 24, 2003
Tested and documented by: Daoud Attayi Compliance Specialist		Nov. 05, 2003

 RESEARCH IN MOTION	Document	SAR Compliance Test Report for foam holsters with BlackBerry Wireless Handheld Model No. RAO30GN		Page 2(2)
	Author Data Daoud Attayi	Dates of Test Oct. 31 – Nov. 04, 2003	Test Report No RIM-0073-0311-01	FCC ID: L6ARAO30GN

CONTENTS

GENERAL INFORMATION	1
1.0 OPERATING CONFIGURATIONS AND TEST CONDITIONS	4
1.1 PICTURE OF HANDHELD	4
1.2 ANTENNA DESCRIPTION	4
1.3 HANDHELD DESCRIPTION	4
1.4 BODY WORN ACCESSORIES	5
1.5 HEADSETS	6
1.6 PROCEDURE USED TO ESTABLISHING THE TEST SIGNAL	6
2.0 DESCRIPTION OF THE TEST EQUIPMENT	6
2.1 SAR MEASUREMENT SYSTEM	6
2.2 DESCRIPTION OF THE TEST SETUP	8
2.2.1 HANDHELD AND BASE STATION SIMULATOR	8
2.2.2 DASY SETUP	8
3.0 ELECTRIC FIELD PROBE CALIBRATION	8
3.1 PROBE SPECIFICATION	8
3.2 PROBE CALIBRATION AND MEASUREMENT ERROR	9
4.0 SAR MEASUREMENT SYSTEM VERIFICATION	9
4.1 SYSTEM ACCURACY VERIFICATION for Head Adjacent Use	9
5.0 PHANTOM DESCRIPTION	10
6.0 TISSUE DIELECTRIC PROPERTY	11
6.1 COMPOSITION OF TISSUE SIMULANT	11
6.1.1 EQUIPMENT	11
6.1.2 PREPARATION PROCEDURE	11
6.2 ELECTRICAL PARAMETERS OF THE TISSUE SIMULATING LIQUID	12
6.2.1 EQUIPMENT	12
6.2.2 TEST CONFIGURATION	13
6.2.3 TEST PROCEDURE	13
7.0 SAR SAFETY LIMITS	16
8.0 DEVICE POSITIONING	17
8.1 DEVICE HOLDER	17
8.2 DESCRIPTION OF TEST POSITION	18
8.2.1 TEST POSITION OF DEVICE RELATIVE TO HEAD	18
8.2.1.1 DEFINITION OF THE "CHEEK" POSITION	19
8.2.1.2 DEFINITION OF THE "TILTED" POSITION	20
8.2.2 BODY-WORN TEST CONFIGURATION	20

 RESEARCH IN MOTION	Document		Page
	SAR Compliance Test Report for foam holsters with BlackBerry Wireless Handheld Model No. RAO30GN		3(3)
Author Data	Dates of Test	Test Report No	FCC ID:
Daoud Attayi	Oct. 31 – Nov. 04, 2003	RIM-0073-0311-01	L6ARAO30GN

9.0 HIGH LEVEL EVALUATION	21
9.1 MAXIMUM SEARCH	21
9.2 EXTRAPOLATION	
9.3 BOUNDARY CORRECTION	21
9.4 PEAK SEARCH FOR 1G AND 10G AVERAGED SAR	21
10.0 MEASUREMENT UNCERTAINTIES	22
11.0 SAR TEST RESULTS	23
11.1 BODY-WORN CONFIGURATION USING HOLSTER	23
12.0 REFERENCES	24

- APPENDIX A: SAR DISTRIBUTION COMPARISON FOR THE ACCURACY VERIFICATION
- APPENDIX B: SAR DISTRIBUTION PLOTS FOR BODY-WORN CONFIGURATION
- APPENDIX C: PROBE & DIPOLE CALIBRATION DATA
- APPENDIX D: SAR TEST SETUP PHOTOGRAPHS

1.0 OPERATING CONFIGURATIONS AND TEST CONDITIONS

1.1 Picture of Handheld

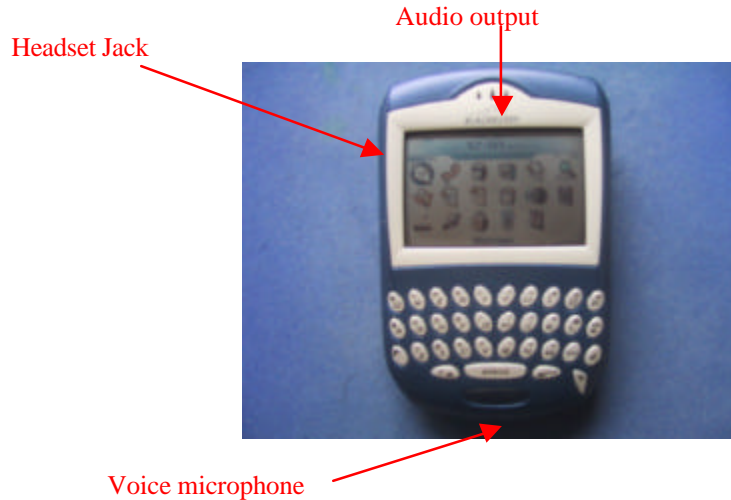

Figure 1. BlackBerry Wireless Handheld

1.2 Antenna description

Type	Internal fixed antenna
Location	Back top centre section
Configuration	Internal fixed antenna

Table 1. Antenna description

1.3 Handheld description

Handheld Model	RAO30GN		
FCC ID	L6ARAO30GN		
Serial Number	404TB-621D6		
Prototype or Production Unit	Pre-production		
Mode(s) of Operation	GSM 850	DCS 1800	PCS 1900
Maximum conducted RF Output Power	32.00 dBm	30.00 dBm	30.00 dBm
Tolerance in Power Setting	31.7 ± 0.3 dB	29.7 ± 0.3 dB	29.7 ± 0.3 dB
Duty Cycle	1:8	1:8	1:8
Transmitting Frequency Range (s)	824.20-948.80 MHz	1710.20-1784.80 MHz	1850.20-1909.80 MHz

Table 2. Test device description

Note: DCS 1800 band cannot be used in North America, therefore there is no SAR results presented in this report for FCC submission. A separate report is generated for this band.
The test report only demonstrates body-worn SAR compliance with two new foam holsters.

 RESEARCH IN MOTION	Document SAR Compliance Test Report for foam holsters with BlackBerry Wireless Handheld Model No. RAO30GN		Page 5(5)
	Author Data Daoud Attayi	Dates of Test Oct. 31 – Nov. 04, 2003	Test Report No RIM-0073-0311-01

1.4 Body worn accessories

Holster

In addition to the holster / leather swivel holster that were tested and submitted under file number RIM-0073-0311-01, the following two new foam holsters are designed to be used with the BlackBerry Wireless Handheld.

The intended usage of the holsters is that the handheld to be slid into the holster with keyboard side facing the user (facing the belt-clip) while in the holster. This positioning has the benefit of protecting the keypad and the large LCD from damage.



Figure 2. Body-worn Vertical Holster HDW-06620-000 and Horizontal Holster HDW-06619-000

The device-to-phantom spacing when the handheld is in the holster is 15 mm.

	Document		Page
	SAR Compliance Test Report for foam holsters with BlackBerry Wireless Handheld Model No. RAO30GN		6(6)
Author Data	Dates of Test	Test Report No	FCC ID:
Daoud Attayi	Oct. 31 – Nov. 04, 2003	RIM-0073-0311-01	L6ARAO30GN

1.5 Headsets

The RIM Blackberry Wireless handheld was tested with and without headset model number HDW-03458-001.

1.6 Procedure used to establish the test signal

The Handheld was put into test mode for the SAR measurements by enabling a call via a Rohde & Schwartz CMU 200 Base Station Simulator test instrument. A SIM card was placed in the Handheld to enable the interaction between the BSS communications test instrument and the Handheld. The CMU 200 communications test instrument then sent out a command for the Handheld to transmit at full power at the specified frequency.

2.0 DESCRIPTION OF THE TEST EQUIPMENT

2.1 SAR measurement system

SAR measurements were performed using a Dosimetric Assessment System (DASY4), an automated SAR measurement system manufactured by Schmid & Partner Engineering AG (SPEAG), of Zurich, Switzerland.

The DASY4 system for performing compliance tests consists of the following items:

- A standard high precision 6-axis robot (Stäubli RX family) with controller and software.
- An arm extension for accommodating the data acquisition electronics (DAE).
- A dosimetric probe, i.e., an isotropic E-field probe optimized and calibrated for usage in tissue simulating liquid. The probe is equipped with an optical surface detector system.
- A DAE module which performs the signal amplification, signal multiplexing, AD-conversion, offset measurements, mechanical surface detection, collision detection, etc. The unit is battery powered with standard or rechargeable batteries. The signal is optically transmitted to the Electro-optical coupler (EOC).
- A unit to operate the optical surface detector which is connected to the EOC.
- The EOC performs the conversion from an optical signal into the digital electric signal of the DAE. The EOC is connected to the PC plug-in card.
- The functions of the PC plug-in card based on a DSP is to perform the time critical tasks such as signal filtering, surveillance of the robot operation fast movement interrupts.
- A computer operating Windows NT.
- DASY4 software version 3.1C.
- Remote control with teach pendant and additional circuitry for robot safety such as warning lamps, etc.
- The SAM Twin Phantom enabling testing left-hand and right-hand usage.
- The device holder for handheld mobile phones.
- Tissue simulating liquid mixed according to the given recipes (see Application Note).
- System validation dipoles allowing for the validation of proper functioning of the system.

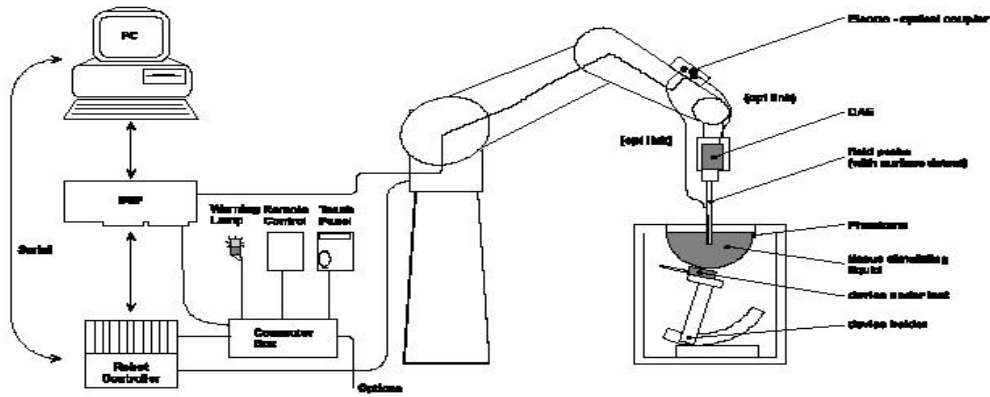



Figure 3: System Description

2.1.1 Equipment List

Manufacturer	Test Equipment	Model Number	Serial Number	Cal. Due Date
SCHMID & Partner Engineering AG	E-field probe	ET3DV6	1642	28/08/2004
SCHMID & Partner Engineering AG	Data Acquisition Electronics (DAE3)	DAE3 V1	472	19/08/2004
SCHMID & Partner Engineering AG	Dipole Validation Kit	D835V2	446	21/08/2005
SCHMID & Partner Engineering AG	Dipole Validation Kit	D1900V2	545	22/08/2005
Agilent Technologies	Signal generator	HP 8648C	4037U03155	01/08/2005
Agilent Technologies	Power meter	E4419B	GB40202821	31/07/2004
Agilent Technologies	Power sensor	8482A	US37295126	07/08/2004
Amplifier Research	Amplifier	5S1G4M3	300986	CNR
Agilent Technologies	Network analyzer	8753ES	US39174857	31/07/2004
Amplifier Research	Amplifier	5S1G4M3	300986	CNR

Table 3. Equipment list

 RESEARCH IN MOTION	Document SAR Compliance Test Report for foam holsters with BlackBerry Wireless Handheld Model No. RAO30GN		Page 8(8)
	Author Data Daoud Attayi	Dates of Test Oct. 31 – Nov. 04, 2003	Test Report No RIM-0073-0311-01

2.2 Description of the test setup

Before a SAR test is conducted the Handheld and the DASY equipment are setup as follows:

2.2.1 Handheld and base station simulator setup

- Insert SIM card into the Handheld's SIM card slot and power it up.
- Turn on the CMU 200 test set and set the carrier frequency and power to the appropriate values.
- Connect an antenna to the RF IN/OUT of the communication test set and place it close to the Handheld.

2.2.2 DASY setup

- Turn the computer on and log on to Windows NT.
- Start DASY4 software by clicking on the icon located on the Windows desktop. Once the software loads, click on the Change to Robot toolbar button to open the State and Robot Monitoring Windows.
- Once the DASY State dialog opens you can ignore all errors and click OK to open the Robot Monitoring window.
- Mount the DAE unit and the probe. Turn on the DAE unit.
- Turn the Robot Controller on by turning the main power switch to the horizontal position
- Align the probe and click the align probe in the light beam button to correct the probe offset.
- Open a program and configure it to the proper parameters
- Establish a connection between the Handheld and the communications test instrument. Place the Handheld on the stand and adjust it under the phantom.
- Start SAR measurements.

3.0 ELECTRIC FIELD PROBE CALIBRATION

3.1 Probe Specification

SAR measurements were conducted using the dosimetric probe ET3DV6, designed by Schmid & Partner Engineering AG for the measurement of SAR. The probe is constructed using the thin film technique, with printed resistive lines on ceramic substrates. It has a symmetrical design with triangular core, built-in optical fiber for the surface detection system and built-in shielding against static discharge. The probe is sensitive to E-fields and thus incorporates three small dipoles arranged so that the overall response is close to isotropic. The table below summarizes the technical data for the probe.

Property	Data
Frequency range	30 MHz – 3 GHz
Linearity	± 0.1 dB
Directivity (rotation around probe axis)	$= \pm 0.2$ dB
Directivity (rotation normal to probe axis)	± 0.4 dB
Dynamic Range	5 mW/kg – 100 W/kg
Probe positioning repeatability	± 0.2 mm
Spatial resolution	< 0.125 mm ³

Table 4. Probe specification

3.2 Probe calibration and measurement errors

The probe was calibrated on 28/08/2003 with an accuracy better than $\pm 10\%$. The sensitivity parameters (NormX, NormY, NormZ), the diode compression parameter (DCP) and the conversion factor (ConvF) of the probe were tested. The probe calibration parameters are shown on Appendix D.

4.0 SAR MEASUREMENT SYSTEM VERIFICATION

Prior to conducting SAR evaluation, the measurements were validated using the dipole validation kit and a flat phantom. A power level of 1.0 W was applied to the dipole antenna. The verification results are in the table below with a comparison to reference values. Printouts are shown in Appendix A. All the measured parameters are satisfactory.

4.1 System accuracy verification for Head Adjacent use

f (MHz)	Limits / Measured	SAR (W/kg) 1 g/ 10 g	Dielectric Parameters		Liquid Temp (°C)
			ϵ_r	σ [S/m]	
835	Measured	8.7 / 5.8	42.4	0.90	22.5
	Recommended Limits	9.6 / 6.2	43.3	0.91	N/A
1900	Measured	43.1 / 22.3	40.5	1.47	22.1
	Recommended Limits	43.2 / 22.0	40.0	1.45	N/A

Table 5. System accuracy (Validation for Head Adjacent use)

 RESEARCH IN MOTION	Document		Page
	SAR Compliance Test Report for foam holsters with BlackBerry Wireless Handheld Model No. RAO30GN		10(10)
Author Data	Dates of Test	Test Report No	FCC ID:
Daoud Attayi	Oct. 31 – Nov. 04, 2003	RIM-0073-0311-01	L6ARAO30GN

5.0 PHANTOM DESCRIPTION

The SAM Twin Phantom, manufactured by SPEAG, was used during the SAR measurements. The phantom is made of a fiberglass shell integrated with a wooden table.

The SAM Twin Phantom is a fiberglass shell phantom with 2 mm shell thickness. It has three measurement areas:

- Left hand
- Right hand
- Flat phantom

The phantom table dimensions are: 100x50x85 cm (LxWxH). The table is intended for use with free standing robots.

The bottom shelf contains three pair of bolts for locking the device holder in place. The device holder positions are adjusted to the standard measurement positions in the three sections. Only one device holder is necessary if two phantoms are used (e.g., for different solutions).

A white cover is provided to top the phantom during off-periods to prevent water evaporation and changes in the liquid parameters. Free space scans of devices on the cover are possible; however the optical surface detector does not work properly at the cover surface. Place a sheet of white paper on the cover when using optical surface detection.

Liquid depth of = 15 cm is maintained in the phantom for all the measurement.



Figure 4
SAM Twin Phantom

 RESEARCH IN MOTION	Document		Page
	SAR Compliance Test Report for foam holsters with BlackBerry Wireless Handheld Model No. RAO30GN		11(11)
Author Data	Dates of Test	Test Report No	FCC ID:
Daoud Attayi	Oct. 31 – Nov. 04, 2003	RIM-0073-0311-01	L6ARAO30GN

6.0 TISSUE DIELECTRIC PROPERTY

6.1 Composition of tissue simulant

The composition of the brain and muscle simulating liquids for 800-900 MHz and 1800-1900 MHz are shown in the table below.

INGREDIENT	MIXTURE 800–900MHz		MIXTURE 1800–1900MHz	
	Brain %	Muscle %	Brain %	Muscle %
Water	51.07	65.45	54.88	69.91
Sugar	47.31	34.31	0	0
Salt	1.15	0.62	0.21	0.13
HEC	0.23	0	0	0
Bactericide	0.24	0.10	0	0
DGBE	0	0	44.91	29.96

Table 6. Tissue simulant recipe

6.1.1 Equipment

Manufacturer	Test Equipment	Model Number	Serial Number	Cal. Due Date
Pyrex, England	Graduated Cylinder	N/A	N/A	N/A
Pyrex, USA	Beaker	N/A	N/A	N/A
Acculab	Weight Scale	V1-1200	018WB2003	N/A
Hart Scientific	Digital Thermometer	61161-302	21352860	15/09/2005
IKA Works Inc.	Hot Plate	RC Basic	3.107433	N/A

Table 7. Tissue simulant preparation equipment

6.1.2 Preparation procedure

800-900 MHz liquids

- Fill the container with **water**. Begin heating and stirring.
- Add the **Cellulose**, the **preservative substance** and the **salt**. After several hours, the liquid will become more transparent again. The container must be covered to prevent evaporation.
- Add **Sugar**. Stir it well until the sugar is sufficiently dissolved.
- Keep the liquid hot but below the boiling point for at least an hour. The container must be covered to prevent evaporation.
- Remove the container from, and turn the hotplate off and allow the liquid to cool off to room temperature prior to performing dielectric measurements.

1800-1900 MHz liquid

- Fill the container with **water**. Begin heating and stirring.

 RESEARCH IN MOTION	Document		Page
	SAR Compliance Test Report for foam holsters with BlackBerry Wireless Handheld Model No. RAO30GN		12(12)
Author Data	Dates of Test	Test Report No	FCC ID:
Daoud Attayi	Oct. 31 – Nov. 04, 2003	RIM-0073-0311-01	L6ARAO30GN

- Add the **salt** and **Glycol**. The container must be covered to prevent evaporation.
- Keep the liquid hot but below the boiling point for at least an hour. The container must be covered to prevent evaporation.
- Remove the container from, and turn the hotplate off and allow the liquid to cool off to room temperature prior to performing dielectric measurements.

6.2 Electrical parameters of the tissue simulating liquid

The tissue dielectric parameters shall be measured before a batch can be used for SAR measurements to ensure that the simulated tissue was properly made and will simulate the desired human characteristic.

Limits and measured electrical parameters are show in the table below.

Recommended limits are adopted from IEEE P1528/D1.2, April 21, 2003:

“Recommended Practice for Determining the Peak Spatial-Average Specific Absorption Rate (SAR) in the Human Head from Wireless Communications Devices: Measurement Techniques”, SPEAG dipole calibration certificates and from FCC Tissue Dielectric Properties web page at <http://www.fcc.gov/fcc-bin/dielec.sh>

f (MHz)	Tissue Type	Limits / Measured	Dielectric Parameters		Liquid Temp (°C)
			ϵ_r	σ [S/m]	
835	Head	Measured	42.4	0.90	22.5
		Recommended Limits	43.3	0.91	N/A
	Muscle	Measured	53.8	0.97	22.3
		Recommended Limits	55.2	0.97	N/A
1900	Head	Measured	40.5	1.47	22.1
		Recommended Limits	40.0	1.45	N/A
	Muscle	Measured	51.0	1.53	22.3
		Recommended Limits	53.3	1.52	N/A

Table 8. Electrical parameters of tissue simulating liquid

6.2.1 Equipment

Manufacturer	Test Equipment	Model Number	Serial Number	Cal. Due Date
Agilent Technologies	Network Analyzer	8753ES	US39174857	31/07/2004
Agilent Technologies	Dielectric probe kit	HP 85070C	US9936135	CNR
Dell	PC using GPIB card	GX110	347	N/A
Hart Scientific	Digital Thermometer	61161-302	21352860	15/09/2005

Table 9. Equipment required for electrical parameter measurements

 RESEARCH IN MOTION	Document	SAR Compliance Test Report for foam holsters with BlackBerry Wireless Handheld Model No. RAO30GN		Page 13(13)
	Author Data Daoud Attayi	Dates of Test Oct. 31 – Nov. 04, 2003	Test Report No RIM-0073-0311-01	FCC ID: L6ARAO30GN

6.2.2 Test Configuration

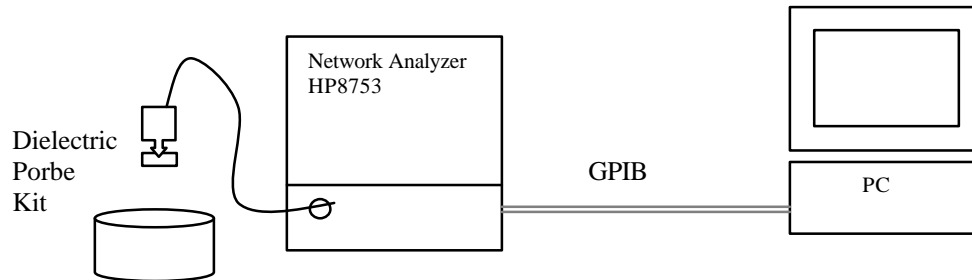

Figure 5: Test configuration

6.2.3 Procedure

1. Turn NWA on and allow at least 30 minutes for warm up.
2. Mount dielectric probe kit so that interconnecting cable to NWA will not be moved during measurements or calibration.
3. Pour de-ionized water and measure water temperature ($\pm 1^\circ$).
4. Set water temperature in HP-Software (Calibration Setup).
5. Perform calibration.
6. Validate calibration with dielectric material of known properties (e.g. polished ceramic slab with $>8\text{mm}$ thickness $\epsilon' = 10.0$, $\epsilon'' = 0.0$). If measured parameters do not fit within tolerance, repeat calibration (± 0.2 for ϵ' : ± 0.1 for ϵ'').
7. Relative permittivity $\epsilon_r = \epsilon'$ and conductivity can be calculated from ϵ''

$$\sigma = \omega \epsilon_0 \epsilon''$$
8. Measure liquid shortly after calibration.
9. Stir the liquid to be measured. Take a sample ($\sim 50\text{ml}$) with a syringe from the center of the liquid container.
10. Pour the liquid into a small glass flask. Hold the syringe at the bottom of the flask to avoid air bubbles.
11. Put the dielectric probe in the glass flask. Check that there are no air bubbles in front of the opening in the dielectric probe kit.
12. Perform measurements.
13. Adjust medium parameters in DASY4 for the frequencies necessary for the measurements ('Setup Config', select medium (e.g. Brain 900 MHz) and press 'Option' -button).
14. Select the current medium for the frequency of the validation (e.g. Setup Medium Brain 900 MHz).

Sample calculation for 835 MHz head tissue dielectric parameters using data from Table 10.

Relative permittivity $\epsilon_r = \epsilon' = 42.43$

Conductivity $\sigma = \omega \epsilon_0 \epsilon'' = 2 \times 3.1416 \times 835 \text{ e}+6 \times 8.854\text{e-}12 \times 19.27 = 0.90 \text{ S/m}$

 RESEARCH IN MOTION	Document		Page
	SAR Compliance Test Report for foam holsters with BlackBerry Wireless Handheld Model No. RAO30GN		14(14)
Author Data	Dates of Test	Test Report No	FCC ID:
Daoud Attayi	Oct. 31 – Nov. 04, 2003	RIM-0073-0311-01	L6ARAO30GN

Title

SubTitle

November 03, 2003 10:24 AM

Frequency	e'	e''
800.000000 MHz	42.8144	19.4036
801.153846 MHz	42.8134	19.3587
802.307692 MHz	42.7865	19.3973
803.461538 MHz	42.8133	19.3937
804.615385 MHz	42.7574	19.3860
805.769231 MHz	42.7483	19.3706
806.923077 MHz	42.7313	19.3847
808.076923 MHz	42.7257	19.4009
809.230769 MHz	42.7249	19.3563
810.384615 MHz	42.6994	19.3781
811.538462 MHz	42.6970	19.3665
812.692308 MHz	42.6790	19.3376
813.846154 MHz	42.6765	19.3637
815.000000 MHz	42.6580	19.3136
816.153846 MHz	42.6575	19.3660
817.307692 MHz	42.6129	19.3180
818.461538 MHz	42.6014	19.3305
819.615385 MHz	42.5951	19.3040
820.769231 MHz	42.5829	19.3327
821.923077 MHz	42.5590	19.3006
823.076923 MHz	42.5611	19.3412
824.230769 MHz	42.5704	19.2945
825.384615 MHz	42.5346	19.3138
826.538462 MHz	42.5341	19.2700
827.692308 MHz	42.5167	19.3159
828.846154 MHz	42.5008	19.2554
830.000000 MHz	42.4765	19.3138
831.153846 MHz	42.4901	19.2450
832.307692 MHz	42.4687	19.3131
833.461538 MHz	42.4726	19.2472
834.615385 MHz	42.4193	19.3137
835.769231 MHz	42.4288	19.2674
836.923077 MHz	42.4133	19.2810
838.076923 MHz	42.4102	19.2279
839.230769 MHz	42.3824	19.3079
840.384615 MHz	42.3435	19.2757
841.538462 MHz	42.3890	19.2822
842.692308 MHz	42.3281	19.2460
843.846154 MHz	42.3764	19.2620
845.000000 MHz	42.3020	19.2507
846.153846 MHz	42.3021	19.2806
847.307692 MHz	42.2692	19.2679

Title

SubTitle

November 03, 2003 10:33 AM

Frequency	e'	e''
800.000000 MHz	54.4164	21.1036
802.500000 MHz	54.3866	21.1127
805.000000 MHz	54.3479	21.0796
807.500000 MHz	54.3303	21.0732
810.000000 MHz	54.3129	21.0667
812.500000 MHz	54.3043	21.0683
815.000000 MHz	54.2581	21.0273
817.500000 MHz	54.2244	21.0044
820.000000 MHz	54.2129	20.9960
822.500000 MHz	54.1963	20.9727
825.000000 MHz	54.1459	20.9785
827.500000 MHz	54.1057	20.9807
830.000000 MHz	54.1049	20.9685
832.500000 MHz	54.0848	20.9633
835.000000 MHz	54.0277	20.9167
837.500000 MHz	54.0417	20.9432
840.000000 MHz	54.0187	20.9283
842.500000 MHz	53.9889	20.8940
845.000000 MHz	53.9856	20.8720
847.500000 MHz	53.9739	20.8858
850.000000 MHz	53.9316	20.8457
852.500000 MHz	53.9204	20.8593
855.000000 MHz	53.8762	20.8419
857.500000 MHz	53.8454	20.8304
860.000000 MHz	53.8285	20.8408
862.500000 MHz	53.7858	20.8393
865.000000 MHz	53.8005	20.8322
867.500000 MHz	53.7988	20.8099
870.000000 MHz	53.7562	20.7925
872.500000 MHz	53.7362	20.7773
875.000000 MHz	53.7163	20.7621
877.500000 MHz	53.6703	20.7889
880.000000 MHz	53.6716	20.7444
882.500000 MHz	53.6354	20.7675
885.000000 MHz	53.6221	20.7394
887.500000 MHz	53.6012	20.7459
890.000000 MHz	53.6025	20.7544
892.500000 MHz	53.6094	20.7501
895.000000 MHz	53.5713	20.7371
897.500000 MHz	53.5543	20.7107
900.000000 MHz	53.5146	20.7194

Table 10. 835 MHz head and muscle tissue dielectric parameters

Title
SubTitle
October 31, 2003 12:41 PM

Title
SubTitle
October 31, 2003 11:12 AM

Frequency	e'	e''	Frequency	e'	e''
1.700000000 GHz	41.2576	13.2804	1.700000000 GHz	51.8145	13.8694
1.710000000 GHz	41.2129	13.3064	1.710000000 GHz	51.7728	13.9123
1.720000000 GHz	41.1656	13.3308	1.720000000 GHz	51.7211	13.9308
1.730000000 GHz	41.1458	13.3513	1.730000000 GHz	51.6832	13.9459
1.740000000 GHz	41.0877	13.3637	1.740000000 GHz	51.6569	13.9734
1.750000000 GHz	41.0509	13.3883	1.750000000 GHz	51.6084	13.9974
1.760000000 GHz	41.0050	13.4060	1.760000000 GHz	51.5795	14.0345
1.770000000 GHz	40.9613	13.4351	1.770000000 GHz	51.5561	14.0670
1.780000000 GHz	40.9488	13.4573	1.780000000 GHz	51.5173	14.1088
1.790000000 GHz	40.9184	13.4935	1.790000000 GHz	51.5013	14.1497
1.800000000 GHz	40.8787	13.5325	1.800000000 GHz	51.4647	14.1935
1.810000000 GHz	40.8430	13.5412	1.810000000 GHz	51.4333	14.2153
1.820000000 GHz	40.8132	13.5863	1.820000000 GHz	51.3948	14.2646
1.830000000 GHz	40.7914	13.6324	1.830000000 GHz	51.3625	14.3019
1.840000000 GHz	40.7446	13.6514	1.840000000 GHz	51.3158	14.3408
1.850000000 GHz	40.7183	13.7003	1.850000000 GHz	51.2740	14.3830
1.860000000 GHz	40.6732	13.7368	1.860000000 GHz	51.2394	14.3982
1.870000000 GHz	40.6178	13.7740	1.870000000 GHz	51.2057	14.4412
1.880000000 GHz	40.5833	13.8131	1.880000000 GHz	51.1574	14.4651
1.890000000 GHz	40.5407	13.8423	1.890000000 GHz	51.1134	14.4999
1.900000000 GHz	40.4956	13.8702	1.900000000 GHz	51.0754	14.5192
1.910000000 GHz	40.4709	13.9090	1.910000000 GHz	51.0317	14.5581
1.920000000 GHz	40.4382	13.9472	1.920000000 GHz	51.0084	14.5581
1.930000000 GHz	40.3834	13.9729	1.930000000 GHz	50.9546	14.5855
1.940000000 GHz	40.3352	14.0066	1.940000000 GHz	50.9391	14.6144
1.950000000 GHz	40.2976	14.0273	1.950000000 GHz	50.9083	14.6361
1.960000000 GHz	40.2603	14.0421	1.960000000 GHz	50.8984	14.6673
1.970000000 GHz	40.2185	14.0839	1.970000000 GHz	50.8873	14.7068
1.980000000 GHz	40.1707	14.1151	1.980000000 GHz	50.8608	14.7429
1.990000000 GHz	40.1197	14.1397	1.990000000 GHz	50.8387	14.7856
2.000000000 GHz	40.0793	14.1693	2.000000000 GHz	50.8169	14.8038

Table 11. 1900 MHz head and muscle tissue dielectric parameters

 RESEARCH IN MOTION	Document		Page
	SAR Compliance Test Report for foam holsters with BlackBerry Wireless Handheld Model No. RAO30GN		16(16)
Author Data	Dates of Test	Test Report No	FCC ID:
Daoud Attayi	Oct. 31 – Nov. 04, 2003	RIM-0073-0311-01	L6ARAO30GN

7.0 SAR SAFETY LIMITS

Standards/Guideline	Localized SAR Limit (W/kg) General public (uncontrolled)	Localized SAR Limits (W/kg) Workers (controlled)
ICNIRP (1998) Standard	2.0 (10g)	10.0 (10g)
IEEE C95.1 (1999) Standard	1.6 (1g)	8.0 (1g)

Table 12. SAR safety limits for Controlled / Uncontrolled environment

Human Exposure	Localized SAR Limits (W/kg) 10g, ICNIRP (1998) Standard	Localized SAR Limits (W/kg) 1g, IEEE C95.1 (1999) Standard
Spatial Average (averaged over the whole body)	0.08	0.08
Spatial Peak (averaged over any X g of tissue)	2.00	1.60
Spatial Peak (hands/wrists/feet/ankles averaged over 10 g)	4.00	4.00 (10g)

Table 13. SAR safety limits

Uncontrolled Environments are defined as locations where there is exposure of individuals who have no knowledge or control of their exposure.

Controlled Environments are defined as locations where there is exposure that may be incurred by persons who are aware of the potential for exposure, (i.e. as a result of employment or occupation).

 RESEARCH IN MOTION	Document SAR Compliance Test Report for foam holsters with BlackBerry Wireless Handheld Model No. RAO30GN		Page 17(17)
	Author Data Daoud Attayi	Dates of Test Oct. 31 – Nov. 04, 2003	Test Report No RIM-0073-0311-01

8.0 DEVICE POSITIONING

8.1 Device holder for SAM Twin Phantom

The Handheld was positioned for all test configurations using the DASY4 holder. The device holder facilitates the rotation of the mounted transmitter in spherical coordinates whereby the rotation point is the ear opening. The devices can be easily, accurately and with repeatability positioned according to FCC and CENELEC specifications. The device holder can be locked at different phantom locations (left head, right head, flat phantom).

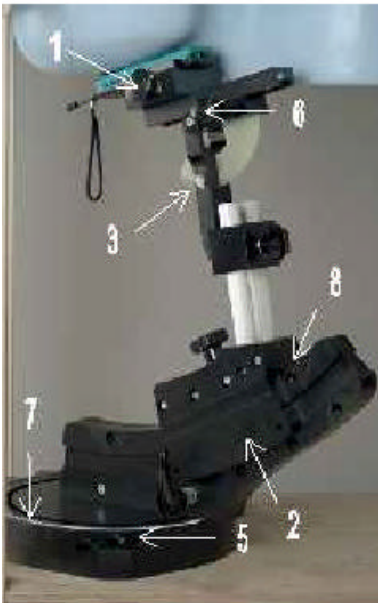



Figure 6
Device Holder

1. Put the phone in the clamp mechanism (1) and hold it straight while tightening. (Curved phones or phones with asymmetrical ear pieces should be positioned so that the ear piece is in the symmetry plane of the clamp).
2. Adjust the sliding carriage (2) to 90°. Then adjust the phone holder angle (3) until the reference line of the phone is horizontal (parallel to the flat phantom bottom). The phone reference line is defined as the front tangential line between the ear piece and the center of the device bottom (or the center of the flip hinge). For devices with parallel front and back sides, the phone holder angle (3) is 0°.
3. Place the device holder at the desired phantom section and move it securely against the positioning pins (4). The screw in front of the turning plate can be applied for correct positioning (5). (Do not tighten it too strongly).
4. Shift the phone clamp (6) so that the ear piece is exactly below the ear marking of the phantom. The phone is now correctly positioned in the holder for all standard phantom measurements, even after changing the phantom or phantom section.

	Document SAR Compliance Test Report for foam holsters with BlackBerry Wireless Handheld Model No. RAO30GN		Page 18(18)
	Author Data Daoud Attayi	Dates of Test Oct. 31 – Nov. 04, 2003	Test Report No RIM-0073-0311-01

5. Adjust the device position angles to the desired measurement position.
6. After fixing the device angles, move the phone fixture up until the phone touches the ear marking. (The point of contact depends on the design of the device and the positioning angle).

8.2 Description of the test positioning

8.2.1 Test Positions of Device Relative to Head

The handset was tested in two test positions against the head phantom, the “cheek” position and the “tilted” position, on both left and right sides of the phantom.

The handset was tested in the above positions according to IEEE 1528-Draft 6.1 “Recommended Practice for Determining the Spatial-Peak Specific Absorption Rate (SAR) in the Human Body Due to Wireless Communications Devices: Experimental Techniques”.

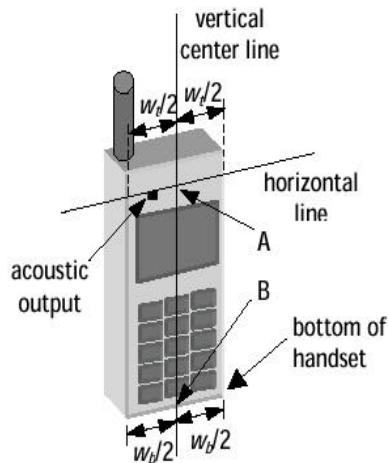

Figure 7a – Handset vertical and horizontal reference lines – fixed case

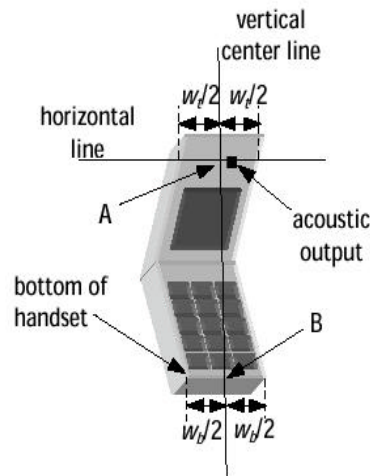



Figure 7b – Handset vertical and horizontal reference lines – “clam-shell”

 RESEARCH IN MOTION	Document		Page
	SAR Compliance Test Report for foam holsters with BlackBerry Wireless Handheld Model No. RAO30GN		19(19)
Author Data	Dates of Test	Test Report No	FCC ID:
Daoud Attayi	Oct. 31 – Nov. 04, 2003	RIM-0073-0311-01	L6ARAO30GN

8.2.1.1 Definition of the “cheek” position

- 1) Ready the handset for talk operation, if necessary. For example, for handsets with a cover piece, open the cover.
- 2) Define two imaginary lines on the handset: the vertical centerline and the horizontal line. The vertical centerline passes through two points on the front side of the handset: the midpoint of the width w_t of the handset at the level of the acoustic output (point A on Figures 7a and 7b), and the midpoint of the width w_b of the bottom of the handset (point B). The horizontal line is perpendicular to the vertical centerline and passes through the center of the acoustic output (see Figure 7a). The two lines intersect at point A. Note that for many handsets, point A coincides with the center of the acoustic output. However, the acoustic output may be located elsewhere on the horizontal line. Also note that the vertical centerline is not necessarily parallel to the front face of the handset (see Figure 7b), especially for clamshell handsets, handsets with flip pieces, and other irregularly shaped handsets.
- 3) Position the handset close to the surface of the phantom such that point A is on the (virtual) extension of the line passing through points RE and LE on the phantom (see Figure 7), such that the plane defined by the vertical center line and the horizontal center line is in a plane approximately parallel to the sagittal plane of the phantom.
- 4) Translate the handset towards the phantom along the line passing through RE and LE until the handset touches the ear.
- 5) While maintaining the handset in this plane, rotate it around the LE-RE line until the vertical centerline is the plane normal to MB (“mouth-back”) - NF (“neck-front”) including the line MB (reference plane).
- 6) Rotate the phone around the vertical centerline until the phone (horizontal line) is symmetrical with respect to the line NF.
- 7) While maintaining the vertical centerline in the reference plane, keeping point A on the line passing through RE and LE, and maintaining the phone contact with the ear, rotate the handset about the line NF until any point on the handset is in contact with a phantom point below the ear (cheek).

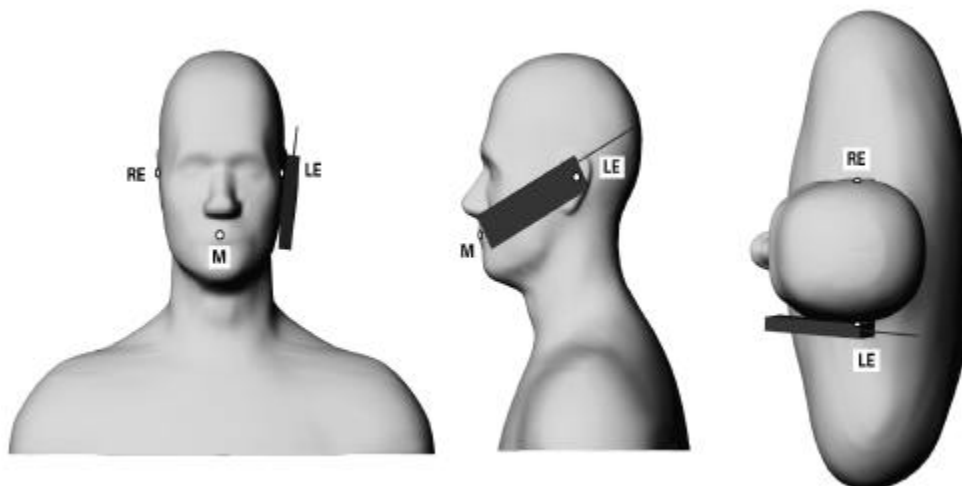



Figure 8 – Phone position 1, “cheek” or “touch” position. The reference points for the right ear (RE), left ear (LE) and mouth (M), which define the reference plane for phone positioning, are indicated. The shoulders are shown for illustration purposes only.

 RESEARCH IN MOTION	Document SAR Compliance Test Report for foam holsters with BlackBerry Wireless Handheld Model No. RAO30GN		Page 20(20)
	Author Data Daoud Attayi	Dates of Test Oct. 31 – Nov. 04, 2003	Test Report No RIM-0073-0311-01

8.2.1.2 Definition of the “Tilted” Position

- 1) Repeat steps 1 to 7 of 5.4.1 (in this report 8.2.1.1) to replace the device in the “cheek position.”
- 2) While maintaining the device in the reference plane (described above) and pivoting against the ear, move the device outward away from the mouth by an angle of 15 degrees, or until the antenna touches the phantom.

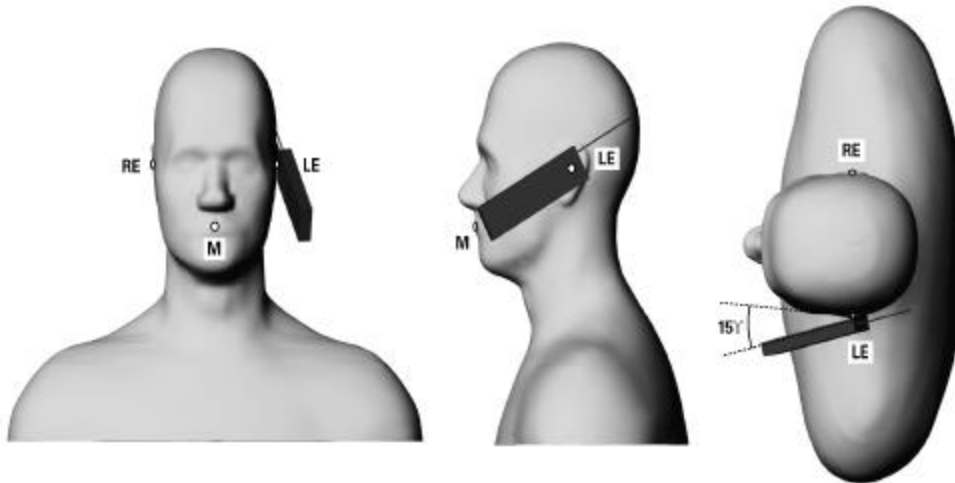



Figure 9 – Phone position 2, “tilted position.” The reference points for the right ear (RE), left ear (LE) and mouth (M), which define the reference plane for phone positioning, are indicated. The shoulders are shown for illustration purposes only.

8.2.2 Body Holster Configuration

Body worn holsters, as shown on Figure 2, were tested with the Wireless Handheld for FCC RF exposure compliance. The EUT was positioned in the holster case and the belt clip was placed against the flat section of the phantom. A headset was then connected to the handheld to simulate hands-free operation in a body worn holster configuration.

 RESEARCH IN MOTION	Document		Page
	SAR Compliance Test Report for foam holsters with BlackBerry Wireless Handheld Model No. RAO30GN		21(21)
Author Data	Dates of Test	Test Report No	FCC ID:
Daoud Attayi	Oct. 31 – Nov. 04, 2003	RIM-0073-0311-01	L6ARAO30GN

9.0 High Level Evaluation

9.1 Maximum search

The maximum search is automatically performed after each coarse scan measurement. It is based on splines in two or three dimensions. The procedure can find the maximum for most SAR distributions even with relatively large grid spacing. After the coarse scan measurement, the probe is automatically moved to a position at the interpolated maximum. The following scan can directly use this position for reference, e.g., for a finer resolution grid or the cube evaluations.

9.2 Extrapolation

The extrapolation can be used in z-axis scans with automatic surface detection. The SAR values can be extrapolated to the inner phantom surface. The extrapolation distance is the sum of the probe sensor offset, the surface detection distance and the grid offset. The extrapolation is based on fourth order polynomial functions. The extrapolation is only available for SAR values.

9.3 Boundary correction

The correction of the probe boundary effect in the vicinity of the phantom surface is done in the standard (worst case) evaluation; the boundary effect is reduced by different weights for the lowest measured points in the extrapolation routine. The result is a slight overestimation of the extrapolated SAR values (2% to 8%) depending on the SAR distribution and gradient. The advanced evaluation makes a full compensation of the boundary effect before doing the extrapolation. This is only possible for probes with specifications on the boundary effect.

9.4 Peak search for 1g and 10g cube averaged SAR

The 1g and 10g peak evaluations are only available for the predefined cube 5x5x7 scan. The routines are verified and optimized for the grid dimensions used in these cube measurements.

The measure volume of 32x32x35mm mm contains about 35g of tissue. The first procedure is an extrapolation (incl. Boundary correction) to get the points between the lowest measured plane and the surface. The next step uses 3D interpolation to get all points within the measured volume in a 1mm grid (35000 points). In the last step, a 1g cube is placed numerically into the volume and its averaged SAR is calculated. This cube is then moved around until the highest averaged SAR is found. This last procedure is repeated for a 10 g cube. If the highest SAR is found at the edge of the measured volume, the system will issue a warning: higher SAR values might be found outside of the measured volume. In that case the cube measurement can be repeated, using the new interpolated maximum as the center.

	Document		Page	
	SAR Compliance Test Report for foam holsters with BlackBerry Wireless Handheld Model No. RAO30GN		22(22)	
Author Data	Dates of Test	Test Report No	FCC ID:	
Daoud Attayi	Oct. 31 – Nov. 04, 2003	RIM-0073-0311-01	L6ARAO30GN	

10.0 MEASUREMENT UNCERTAINTIES

DASY4 Uncertainty Budget According to IEEE P1528 [1]								
Error Description	Uncertainty value	Prob. Dist.	Div.	(c_i) 1g	(c_i) 10g	Std. Unc. (1g)	Std. Unc. (10g)	(v_i) v_{eff}
Measurement System								
Probe Calibration	±4.8%	N	1	1	1	±4.8%	±4.8%	∞
Axial Isotropy	±4.7%	R	√3	0.7	0.7	±1.9%	±1.9%	∞
Hemispherical Isotropy	±9.6%	R	√3	0.7	0.7	±3.9%	±3.9%	∞
Boundary Effects	±1.0%	R	√3	1	1	±0.6%	±0.6%	∞
Linearity	±4.7%	R	√3	1	1	±2.7%	±2.7%	∞
System Detection Limits	±1.0%	R	√3	1	1	±0.6%	±0.6%	∞
Readout Electronics	±1.0%	N	1	1	1	±1.0%	±1.0%	∞
Response Time	±0.8%	R	√3	1	1	±0.5%	±0.5%	∞
Integration Time	±2.6%	R	√3	1	1	±1.5%	±1.5%	∞
RF Ambient Conditions	±3.0%	R	√3	1	1	±1.7%	±1.7%	∞
Probe Positioner	±0.4%	R	√3	1	1	±0.2%	±0.2%	∞
Probe Positioning	±2.9%	R	√3	1	1	±1.7%	±1.7%	∞
Max. SAR Eval.	±1.0%	R	√3	1	1	±0.6%	±0.6%	∞
Test Sample Related								
Device Positioning	±2.9%	N	1	1	1	±2.9%	±2.9%	145
Device Holder	±3.6%	N	1	1	1	±3.6%	±3.6%	5
Power Drift	±5.0%	R	√3	1	1	±2.9%	±2.9%	∞
Phantom and Setup								
Phantom Uncertainty	±4.0%	R	√3	1	1	±2.3%	±2.3%	∞
Liquid Conductivity (target)	±5.0%	R	√3	0.64	0.43	±1.8%	±1.2%	∞
Liquid Conductivity (meas.)	±2.5%	N	1	0.64	0.43	±1.6%	±1.1%	∞
Liquid Permittivity (target)	±5.0%	R	√3	0.6	0.49	±1.7%	±1.4%	∞
Liquid Permittivity (meas.)	±2.5%	N	1	0.6	0.49	±1.5%	±1.2%	∞
Combined Std. Uncertainty						±10.3%	±10.0%	330
Expanded STD Uncertainty						±20.6%	±20.1%	

Table 14. Measurement uncertainty

11.0 TEST RESULTS

11.1 SAR measurement results at highest power measured against the body using Horizontal and Vertical foam holsters

Mode	f (MHz)	Conducted Output Power (dBm)	Liquid Temp (°C)	SAR, averaged over 1 g (W/kg) Vertical Holster	SAR, averaged over 1 g (W/kg) Horizontal Holster	SAR, averaged over 1 g with headset (W/kg) Holster
GSM 850	824.20	-	-	-	-	-
	*836.80	32.0	22.2	0.17	0.25	-
	848.80	-	-	-	-	-
PCS 1900	1850.20	-	-	-	-	-
	*1880.00	30.2	22.1	0.10	0.07	-
	1909.80	-	-	-	-	-

11.2 Table 15. SAR results with Holster and Leather Swivel Holster for body configuration

* Supplement C: Middle channel testing is sufficient only if SAR < 3dB below limit see PN 02-1438

 RESEARCH IN MOTION	Document		Page
	SAR Compliance Test Report for foam holsters with BlackBerry Wireless Handheld Model No. RAO30GN		24(24)
Author Data	Dates of Test	Test Report No	FCC ID:
Daoud Attayi	Oct. 31 – Nov. 04, 2003	RIM-0073-0311-01	L6ARAO30GN

12.0 REFERENCES

[1] EN 50360: 2001, Product standard to demonstrate the compliance of mobile phones with the basic restrictions related to human exposure to electromagnetic fields (300 MHz – 3 GHz)

[2] EN 50361: 2001, Basic standard for the measurement of Specific Absorption Rate related to human exposure to electromagnetic fields from mobile phones (300 MHz – 3 GHz)

[3] ICNIRP, International Commission on Non-Ionizing Radiation Protection (1998), Guidelines for limiting exposure in time-varying electric, magnetic, and electromagnetic fields (up to 300 GHz).

[4] Council Recommendation 1999/519/EC of July 1999 on the limitation of exposure of the general public to electromagnetic fields (0 Hz to 300 GHz)

[5] IEEE C95.3-1991, IEEE Recommended Practice for the Measurement of Potentially Hazardous Electromagnetic Fields – RF and Microwave.

[6] IEEE C95.1-1999, IEEE Standard for Safety Levels with Respect to Human Exposure to Radio Frequency Electromagnetic Fields, 3 kHz to 300 GHz.

[7] OET Bulletin 65 (Edition 97-01) Supplement C (Edition 01-01), Evaluating Compliance with FCC Guidelines for Human Exposure to Radio Frequency Electromagnetic Fields.

[8] FCC 96-326, Guidelines for Evaluating the Environmental Effects of Radio-Frequency Radiation.

[9] DASY 3 DOSIMETRIC ASSESSMENT SYSTEM SOFTWARE MANUAL
Schmid & Partner Engineering AG, August 99.

[10] DASY 4 DOSIMETRIC ASSESSMENT SYSTEM SOFTWARE MANUAL V4.1
Schmid & Partner Engineering AG, April 2003.

[11] IEEE P1528/D1.2, April 21, 2003: Recommended Practice for Determining the Peak Spatial-Average Specific Absorption Rate (SAR) in the Human Head from Wireless Communications Devices: Measurement Techniques.

 RESEARCH IN MOTION	Document SAR Compliance Test Report for foam holsters with BlackBerry Wireless Handheld Model No. RAO30GN		Page 25(25)
Author Data Daoud Attayi	Dates of Test Oct. 31 – Nov. 04, 2003	Test Report No RIM-0073-0311-01	FCC ID: L6ARAO30GN