

ELECTROMAGNETIC EMISSIONS TEST REPORT

BY

COM-SERVE CORPORATION

KITCHENER, ONTARIO

CANADA

RADIATED and CONDUCTED EMI TEST REPORT

August 27, 1999

CLIENT:

Research In Motion
295 Phillip Street
Waterloo, Ontario
N2L 3W8

TESTED MODEL:

Model Number: **R802D-2-0**
Serial Number: 128/00/000008 (Radio 08)
Description: 800 MHz **OEM RADIO MODEM DEVICE**
Date tested: August 16, 1999
Tested with: Host computer, IBM ThinkPad 770ED-S97-3819-2,
Serial # 78-X1980 09/98, FCC ID 4U6JPN-31879-DTE;
RIM Radio Monitor [ITB] Board, PCB-02120-001 Rev
B; ITB PCB Power Supply, AC/DC adapter, Mfr.
Globtek, Part No. WR91A2400CCP, 05 VDC @ 2.4A;
Antenna Company 800 MHz "Cell" antenna, Model
Eclipse II/8110; Associated cables and cords.

IN ACCORDANCE WITH:

- **FCC Part 2 and FCC Part 90 Transmitters; Certification**
- Test procedure(s) MP-4 and ANSI C63.4
- Industry Canada OATS reference number, **IC 2963**. RSP 100, Issue 7.

TESTED BY:

Com-Serve Corporation
17 Old Carriage Court
Kitchener, Ontario
N2P 1V3

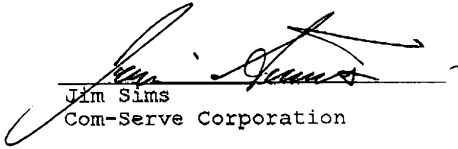
Jim Sims

Com-Serve Corporation

TECHNICIAN:

Jim Sims
With: Mr. Masud Attayi and Mr. Jonathan Doll (Research in Motion)

FILE NUMBER: RIM 025

RESULTS R802D-2-O RIM 025

COMPLIANCE

(yes) (no)

RF POWER OUTPUT

Transmitter: 2.1046 (X) ()

OCCUPIED BANDWIDTH

Transmitter: 2.1049 (N/T) ()

SPURIOUS EMISSIONS AT THE ANTENNA TERMINALS

Transmitter: 2.1051 (N/T) ()

FIELD STRENGTH OF SPURIOUS RADIATION

Transmitter: 2.1053 (X) ()

FREQUENCY STABILITY

Transmitter: 2.1055 (N/T) ()

BANDWIDTH LIMITATIONS

Transmitter: 90.210 g (N/T) ()

SYSTEM DESCRIPTION RIM 025

The R802D-2-O OEM RADIO MODEM

The R802D-2-O radio modem is intended for integration into other equipment to allow wireless data communication. The R802D-2-O has a standard TTL level serial asynchronous interface allowing it to communicate directly with embedded controllers and host processors.

Radio evaluation and application development is facilitated by the radio monitor board (PCB-02120-001 Rev B). The radio monitor board translates the TTL serial interface signals to standard RS232 level signals. The RS232 level signals can be directly interfaced to a Personal Computer serial port. The radio monitor board is an interface between a serial I/O and the RIM R802D-2-O radio. The board translates the 3.0 volt level serial interface signals to standard RS-232 level signals. The radio monitor board also provides a regulated and filtered 4.4 VDC to the radio. The radio power and the level translation circuit power are derived from a 5 V/2.4 A AC/DC power adapter. The R802D-2-O radio, radio monitor board, AC adapter, 8110 Eclipse II cellular antenna and all required interface cables will be typically marketed as the "RIM 802D Radio Evaluation and Development Kit".

The OEM 900 MHz packet data radio modem is formally model R802D-2-O. The RIM Radio Monitor board RS232 converter is formally model 02120-001.

The antenna used for testing and to be included in the evaluation and development kit, is an ECLIPSE II Magnet Mount Cellular Antenna Model 8110 from The Antenna Company International Limited. Please see attached data sheet for Model 8110 and others. Model 8110 is a semi-custom device with a 6 foot RG58A/U cable and a SMA male connector.

Normal radio modem operation for live use is called burst packet activity. The radio is normally in receive mode listening to all network activity. When a data packet is received that is explicitly addressed to the radio it then transmits a short acknowledgment packet. When data is to be transmitted from the radio modem, the radio modem first receives system information from the network to determine when to transmit. There is no deterministic pattern to the network traffic or transmit packet timing. To facilitate testing, the network's radio specification allows several test modes for transmitting continuous carrier without modulation, or with modulation generated from scrambler sequence or fixed sequence data. The transmit test modes were used for testing the radio for compliance to CFR47 standards.

SYSTEM DESCRIPTION; CONTINUED

FUNCTIONAL DESCRIPTION:

The R802D-2-O is an 800 MHz band, half duplex (two frequency simplex), 2.0 Watt transceiver system for wireless data modem communications on DataTAC wireless systems.

The transmitter is capable of transmitting at carrier frequencies from 806 MHz to 825 MHz, with channels at discrete 12.5 KHz steps having a channel bandwidth of 25 KHz each.

The active transmit frequencies are determined by the radio firmware for nationally allocated DataTAC system channels and by the DataTAC system for operational local channels. The user is not capable of modifying the frequency of operation of the device.

The transmitter will only generate RF power at a single level of 2000 milliwatts (+33 dBm). The output power level of the device cannot be modified by the user.

SYSTEM DESCRIPTION Photos



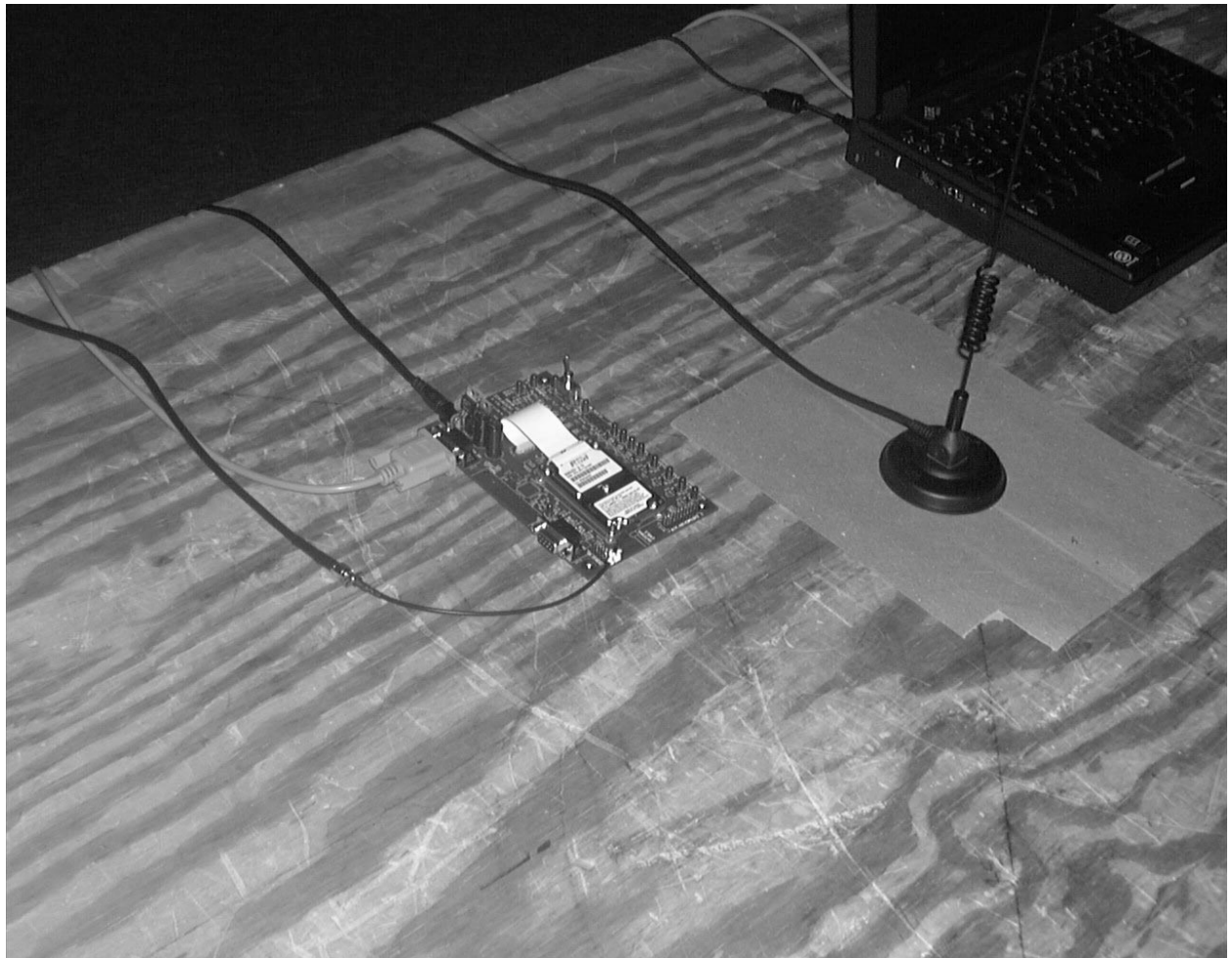

TEST PROCEDURE: RADIATED EMISSIONS RIM 025

All tests were performed in accordance with FCC/MP-4, & ANSI C63.4.

The Research In Motion Limited R802D-2-O OEM radio modem device, as connected together with a host laptop computer, interface PCB, power adaptor and external antenna as described on the "Title and System Description" pages. The system was arranged in a typical configuration of use and placed on top of a one metre non-conducting turntable as per ANSI C63.4. All of the system parts were connected together with cables that are sold with each piece or generic cables purchased for the specific connection involved. Several different equipment placements were tried so as to establish the worst normal case of equipment positioning. In this case the IBM laptop computer with the Research in Motion OEM radio modem device and external antenna were placed on top of the turntable, while the power supply for the IBM ThinkPad computer and the power supply for the ITB interface PCB, were placed at the bottom centre of the test table. All of the cables and cords were moved about so as to create the highest level of EMI. The complete system was operating as it would be in normal use. Special software was employed in order that the Research in Motion radio modem device was processing data to and from the IBM PC in a worst case NORMAL manner, and included normal operating transmitter and receiver modes. The turntable was rotated through 360 degrees.

A preliminary radio frequency scan was performed on the system to determine the worst case cable and equipment configuration. The attached results represent the system configuration maximized for worst case emissions in each frequency band. The ERP level was also checked with the OEM radio modem transmitting as a stand-alone device.

The tests were conducted at a distance of three (3) metres with the receiving antennas in both the horizontal and vertical planes at each emission frequency. It should be noted that a preamplifier (LNA) in conjunction with a notch filter, was used above 1.0 GHz. The test results table entry referred to as "ANT. FAC." include cable loss, antenna correction factor, LNA gain and notch filter insertion loss.

EQUIPMENT:

Advantest R3261A Spectrum Analyzer and
H.P. 8563E Spectrum Analyzer 9.0 KHz - 26.5 GHz
Setting: BW: 300 Hz, 100 KHz or 120 KHz (Q.P), as required.
LNA, HP 8449B Preamplifier (30 dB) 1.0 to 26.5 GHz
MA-COM 20 dB att. # 2082-6502-20 0 Hz - 18.0 GHz
A.H. Systems biconical antenna; 20 MHz - 330 MHz
A.H. Systems log periodic antenna; 300 MHz - 1.8 GHz
A.H. Systems log periodic antenna; 1.0 GHz - 12.4 GHz
EATON dipole antennas; T1, T2, T3 25 MHz - 1.0 GHz
CDI ROBERTS dipole antennas T1 T2 T3 T4 25 MHz - 1.0 GHz

NOTE: The three metre test range has been carefully evaluated to the ANSI C63.4, and will be remeasured for reflections and losses every three years. (ANSI C63.4/FCC OET-55)

RADIATED EMISSION RESULTS RIM 025

BW: 100/120 KHz

Span: 05 to 50 MHz

PART 2/90 TRANSMITTER RADIATED TESTS TO 10 G HZ

**TEST FREQ. LEVEL ANT. ANT. F.S. LIMIT DIFF. TO
G Hz μ V TYPE (PZ) FAC. V/M μ V/M LIMIT; dB**

| TEST # | FREQ. G Hz | LEVEL μ V | ANT. TYPE (PZ) | ANT. FAC. | F.S. V/M | LIMIT μ V/M | DIFF. TO LIMIT; dB |
|--------|------------|---------------|----------------|-----------|----------|-----------------|--------------------|
| 01 TX | 815.00 | 82200.0 | RT.4 V | 41.4 | 3403080 | 3300000 | 0.27 |
| 02 TX | 1630.00 | 325.0 | L/P V | 3.0 | 975.0 | 17036 | -24.85 |
| 03 TX | 2445.00 | 271.0 | L/P V | 5.5 | 1490.5 | 17036 | -21.16 |

NOTES:

A) It should be noted that a preamplifier (LNA) in conjunction with a notch filter was used above 1.0 GHz. The test results table entry referred to as "ANT. FAC." include cable loss, antenna correction factor, LNA gain and notch filter insertion loss.

B) The limit as specified in the above table, is 46.01 dB below the measured maximum conducted power output of the transmitter 2.00 W.

C) Limit Calculations:

$$\begin{aligned} \text{Attenuation} &= 43 + 10 \cdot \text{Log of } P_t (2.00\text{w}) \\ &= 43 + (3.01) \\ &= 46.01 \text{ dBc} \\ \text{Limit (FS)} &= 3.403080 \text{ V/m less } 46.01\text{dB} \\ &= 0.017036 \text{ V/m or } 17036 \mu\text{V/m} \end{aligned}$$

Description Eclipse II Magnet Mount

The Eclipse II Magnet Mount Antenna is a full 3 dB gain providing dramatically improved performance to portable radio communications in fringe areas or where reception is poor. In addition, the sleek aerodynamic styling and convenient size look great and install easily.

Features and Benefits

Mounts and removes in seconds.
 Power balanced magnet delivers maximum magnetic strength.
 UV stabilized rubber boot protects vehicle surface.
 Connector is protected with extended strain relief.

The Eclipse II is an outstanding performance booster and a proven performer.
 Stranded center conductor allows maximum durability and flexibility.

Private Label
 Increase your visibility, your prestige, and your sales with this form of low cost advertising.



Call your TAC representative for details.

K2+ Klip™ Window Clip

The K2+ Klip™ enclosed coil has all the advantages of the K2+ series in an ideal window clip design. Simply slip the one-piece antenna over your vehicle window and close.

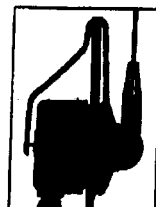

The K2+ Klip™ features our enclosed coil whip to eliminate whistling and to ensure proper clearance over the roof line.

The one piece molded LEXAN™ clip and foot assembly looks fantastic on the vehicle, yet offers maximum strength and durability.

The design of the K2+ Klip™ allows you to seal the window completely without damaging it or the antenna.

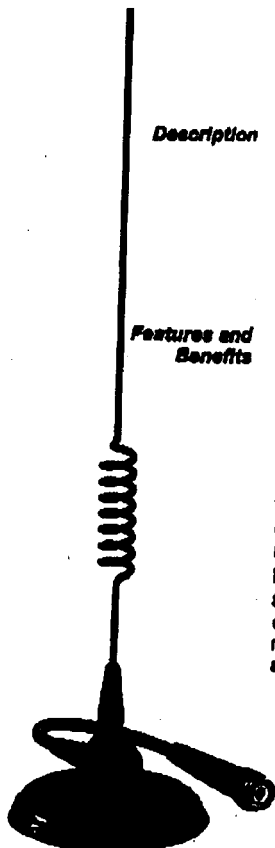

Technical Specifications

| | |
|------------------------------|--------------------------------------|
| All antennas include: | |
| Power Input | 80 Watts |
| Frequency Range | 806-866 |
| VSWR | Less than 1.5:1 over specified range |
| Impedance | 50 Ohms |

| Name | Model numbers | Gain | Whip Height |
|-------------|----------------------------------|------|-------------|
| Eclipse II | #8110-QR/8111-QR/8115-QR/8119 | 3 dB | 14" |
| MightyMini® | #8120-QR/8121-QR/8125-QR/8129-QR | 0 dB | 4" |
| K2+ Klip™ | #8620/8621/8825/8829 | 3 dB | 16" |

Ordering Information

| Model Number | Name |
|--------------|--|
| 8110 | Eclipse II magnet mount w/TNC connector |
| 8111 | Eclipse II magnet mount w/N connector |
| 8115 | Eclipse II magnet mount w/Mini-UHF connector |
| 8119 | Eclipse II magnet mount w/ACC connector |
| 8120-QR | MightyMini® w/TNC connector |
| 8121-QR | MightyMini® w/N connector |
| 8125-QR | MightyMini® w/Mini-UHF connector |
| 8129-QR | MightyMini® w/ACC connector |
| 8620 | K2+ Klip™ w/TNC connector |
| 8621 | K2+ Klip™ w/N connector |
| 8825 | K2+ Klip™ w/Mini-UHF connector |
| 8829 | K2+ Klip™ w/ACC connector |

To Order Call 1-800-458-2820



Made in the USA
 All TAC products are made in the USA, ensuring "America Works."

* LEXAN™ is a trademark of GE

FEDERAL COMMUNICATIONS COMMISSION

7435 Oakland Mills Road
Columbia, MD 21046
Telephone: 301-725-1585 (ext-218)
Facsimile: 301-344-2060

September 23, 1997

IN REPLY REFER TO
31040/SIT
1300F2

Electrohome Electronics Ltd
809 Wellington Street, North
Kitchener, Ontario N2G 4J6, Canada

Attention: Gerry Gallagher

Re: Measurement facility located at Roseville
(3 meter site)

Gentlemen:

Your submission of the description of the subject measurement facility has been reviewed and found to be in compliance with the requirements of Section 2.948 of the FCC Rules. The description has, therefore, been placed on file and the name of your organization added to the Commission's list of facilities whose measurement data will be accepted in conjunction with applications for certification or notification under Parts 15 or 18 of the Commission's Rules. Our list will also indicate that the facility complies with the radiated and AC line conducted test site criteria in ANSI C63.4-1992. Please note that this filing must be updated for any changes made to the facility, and at least every three years the data on file must be certified as current.

Per your request, the above mentioned facility has been also added to our list of those who perform these measurement services for the public on a fee basis. This list is published periodically and is also available on the Laboratory's Public Access Link as described in the enclosed Public Notice.

Sincerely,

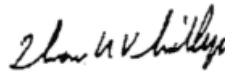

Thomas W. Phillips
Electronics Engineer
Customer Service Branch



| | | |
|------------------------------|-----------------|---|
| Author Data Jonathan Doll | August 30, 1999 | Document No. 02400-CERT-FCC-TEST-BW_MASK |
| Approved Masud S. Attayi | Rev | File / Reference BW Masks |

OCCUPIED BANDWIDTH/BANDWIDTH LIMITATIONS

TEST PROCEDURE:

The Research In Motion Limited R802D-2-O Radio modem was connected together with a host computer, external power supply and a 20 dB external attenuator. The R802D-2-O antenna output terminal was connected to the input of a 50 Ω spectrum analyzer through a matched 20 dB attenuator. The R802D-2-O transmitter was operating at full output power with and without internal data modulation.

TEST RESULTS:

UNMODULATED CARRIER, High Power: **12.87dBm** with a 20dB external pad and a 1 m Sucoflex cable with a total loss of 0.18 dB.

Internal Modulation: Please refer to the attached spectrum analyzer plots. 100% of the in-band modulation is below the specified mask per 90.210(g) for both RD_LAP and MDC protocols.

Below is the **description of the mask** for band 806-821/851-866 MHz (DataTAC) : 2.0 Watts transmitter

| <u>Frequency</u> (MHz) | <u>Formula</u> | <u>Limit</u> (Db) |
|---------------------------|---|----------------------|
| -26500 | 43+10 log (P) | -46 |
| -0.050 | 43+10 log (P) | -46 |
| -0.050 | 50+10 log (P) | -53 |
| -0.0175 | 116 log (f _d / 6.1) | -53 |
| -0.010 | 116 log (f _d / 6.1) or 83 log (f _d / 5) | -25 |
| -0.005 | 83 log (f _d / 5) | 0.0 |
| 0.005 | 83 log (f _d / 5) | 0.0 |
| 0.010 | 116 log (f _d / 6.1) or 83 log (f _d / 5) | -25 |
| 0.0175 | 116 log (f _d / 6.1) | -53 |
| 0.050 | 50+10 log (P) | -53 |
| 0.050 | 43+10 log (P) | -46 |
| 26500 | 43+10 log (P) | -46 |



| | | |
|-------------------------|-----|----------------------|
| Date August 30, 1999 | Rev | Document BW Masks |
|-------------------------|-----|----------------------|

EQUIPMENT:

- H.P. 8563E Spectrum Analyzer 9.0 KHz - 26.5 GHz
- HP6632B DC POWER SUPPLY
- Mini Circuits 20 dB att. # NAT-20 0 Hz - 1.5 GHz

**OCCUPIED BANDWIDTH/BANDWIDTH LIMITATIONS
UNMODULATED CARRIER**

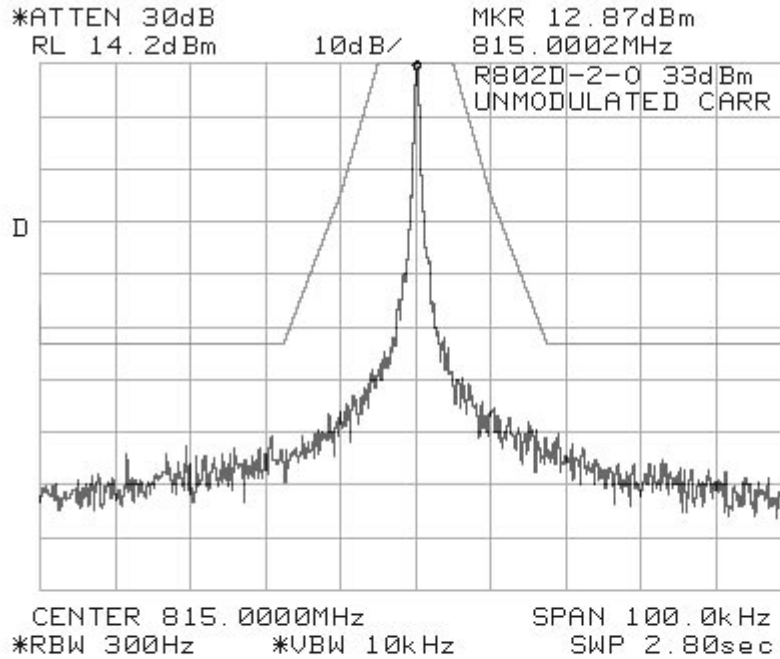

**OCCUPIED BANDWIDTH/BANDWIDTH LIMITATIONS
MODULATED CARRIER - RD_LAP**



Document
R802D-2-0 RADIO MODEM DEVICE OCCUPIED
BANDWIDTH/BANDWIDTH LIMITATIONS

| | | |
|-------------------------|-----|----------------------|
| Date August 30, 1999 | Rev | Document BW Masks |
|-------------------------|-----|----------------------|

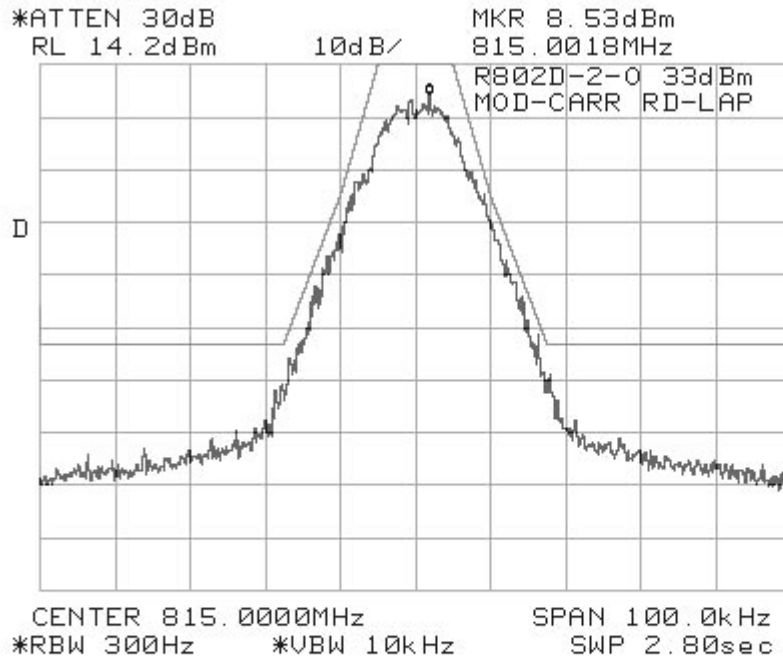



| | | |
|-------------------------|-----|----------------------|
| Date August 30, 1999 | Rev | Document BW Masks |
|-------------------------|-----|----------------------|

OCCUPIED BANDWIDTH/BANDWIDTH LIMITATIONS

MODULATED CARRIER MDC

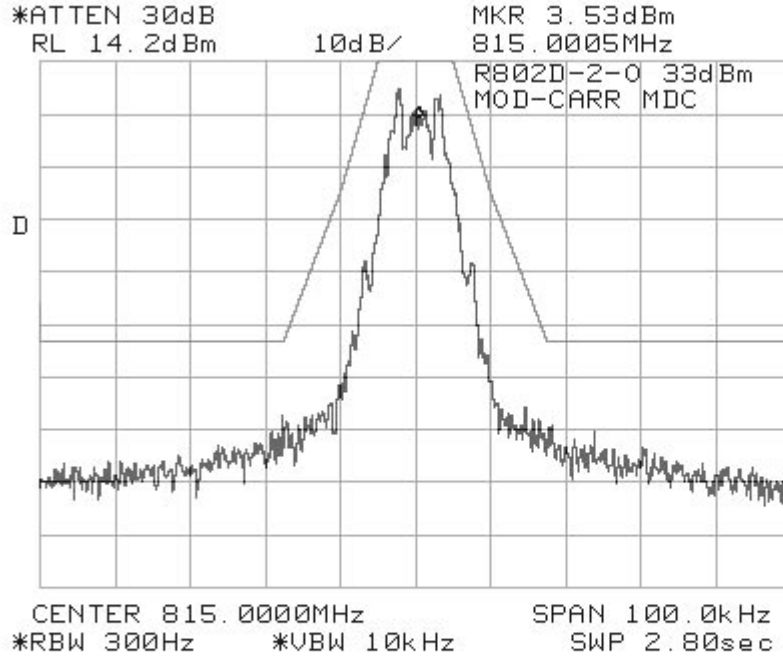



| | | |
|------------------------------|-----------------|--|
| Author Data Jonathan Doll | August 30, 1999 | Document No. 02400-CERT-FCC-TEST-SPURIOUS |
| Approved Masud S. Attayi | Rev | File / Reference Spurious Emissions |

SPURIOUS EMISSIONS AT ANTENNA TERMINALS

TEST PROCEDURE:

The Research In Motion Limited R802D-2-O radio modem device was connected together with a radio monitor board 02120-001, host computer, external power supply, a 30 dB external attenuator, and a 0.80 dB coaxial cable. The R802D-2-O antenna output terminal was connected to the input of a 50 Ω spectrum analyzer through a matched 30 dB attenuator and a coaxial cable. The transmitter was operating at full output power with and without internal data modulation. The calculated limit below the unmodulated carrier at +2.50 dBm, including the 30 dB external attenuator and 0.8 dB cable loss, is equal to +33.30 dBm. The actual limit is 46.3 dBc lower, or -13.0 dB.

TEST RESULTS:

Ref 815

+33.30 (- 46.3)

-13.0

| FREQUENCY MHz | LEVEL DBm | LIMIT DB |
|------------------|--------------|-------------|
| 815 | +33.30 | |
| 1630 | -40.87 | -13.00 |
| 2445 | -46.70 | -13.00 |
| 3260 | -57.37 | -13.00 |
| 4075 | -47.70 | -13.00 |
| 4890 | -56.20 | -13.00 |
| 5705 | -57.37 | -13.00 |
| 6520 | NOT FOUND | -13.00 |
| 7335 | NOT FOUND | -13.00 |

NOTE:

The above limits take into account the unmodulated carrier level of +33.30 dBm inclusive of the 30 dB external attenuator and 0.80 dB coaxial cable loss. The modulation used for spurious harmonics was a worst case, random data pattern while still representing a normal modulation pattern.

EQUIPMENT:

- H.P. 8563E Spectrum Analyzer 9.0 KHz - 26.5 GHz
- RIM OEM Interface wth AC adaptor P/N:WR91A2400CCP
- Radio: R802D-2-O
- Mini Circuits 20 dB att. # NAT-20 0 Hz - 10.5 GHz
- MD west microwave att. # 0217NNN-02 10dB DC - 8.0 GHz



| | | |
|-------------------------------------|------------------------|--|
| Author Data Jonathan Doll | August 30, 1999 | Document No. 02400-CERT-FCC-TEST-012 |
| Approved Masud S. Attayi | Rev | File / Reference 012 |

CFR 47 Chapter 1 - Federal Communication Commission Rules

Part 2 Required Measurement
 2.1046 (a,c) RF Power Output

Part 90 Subpart I : Technical Standards
 90.205 RF Power Output
 (i) Maximum power output limit : reference to subpart S, Subsection 90.635 (806-821 MHz band).

Part 90 - Subpart S : Use of Frequencies in 806-821 MHz Band
 90.635 Limitations on Output Power
 (d) Mobile station maximum output power is 100 W (20dBW)

We are rating the device as 2.00 W (33 dBm) transmitter output power across a 50 ohm load, but due to the 0.5 dB uncertainty in our Calibration Software Tool, we are requesting 2.25 W (33.5 dBm).
 Limit on device output power would therefore be 2.25 W (33.5 dBm).

Calibrated power measurement using the following equipment:

- HP EPM-441A Power Meter S/N GB37481294 Cal on 05/08/99
- HP ECP-E18A Power Sensor S/N US37181260 Cal on 05/08/99
- HP 8720D Network Analyzer S/N US36140834 Cal on 05/08/99
- HP HP85033D Calibration Kit S/N 3423A00734 Cal on 05/08/99
- Mini-Circuits NAT-20 DC to 1500 MHz Coaxial Attenuator

Procedure: These results were obtained using the test procedure described in document 02400-CERT-FCC-TEST-013.

The HP8720D was calibrated using the HP85033D. The cable assembly and microwave attenuator used for the measurements were calibrated using the HP8720D. The EPM-441A and ECP-E18A were calibrated using the internal power reference. The radio was tuned by the procedure as provided for sections 2.1033 (c) (8) and 2.1033 (c) (9). At three transmit frequencies the maximum radio output power level was measured using the EPM-441A and ECP-E18A. Output levels were measured for both modulated and unmodulated carrier. The calibrated insertion loss measured for the attenuator and cable assembly was added to the calibrated power measurements which produced the following results:

Results:

| Carrier Frequency (MHz) | Measured Level (dBm) | Calibrated Attenuation (dB) | Output Power (dBm) | Output Power (W) |
|-------------------------|----------------------|-----------------------------|--------------------|------------------|
| 806.000 | 12.88 | 20.18 | 33.06 | 2.023 |
| 815.000 | 12.87 | 20.18 | 33.05 | 2.018 |
| 821.000 | 12.83 | 20.18 | 33.01 | 2.000 |



| | | |
|-------------------------------------|------------------------|--|
| Author Data Jonathan Doll | August 30, 1999 | Document No. 02400-CERT-FCC-TEST-013 |
| Approved Masud S. Attayi | Rev | File / Reference 013 |

CFR 47 Chapter 1 - Federal Communications Commission Rules

Part 2 Required Measurement

- 2.1055 Frequency Stability - Procedures
 - (a,b) Frequency Stability - Temperature Variation
 - (d) Frequency Stability - Voltage Variation

Part 90 Subpart I : Technical Standards

- 90.213 Frequency Tolerance
 - (a) Maintain the carrier frequency within 0.00025 % (2.5 ppm) of the assigned frequency.
 - (b) Maximum power output used for measurement

Frequency and power measurements were performed together with the same set up. Frequency and power data were both recorded across temperature and voltage. The set up used a cable assembly with a power splitter to allow concurrent measurements with the frequency counter, and the power meter. The cable assembly was calibrated to allow compensation of the insertion loss between the transmitter and the power meter.

Calibration for the Cable and Attenuator Loss:

Place: RF Lab in RIM
 Date: JULY 28th, 1999

Instruments used:

| Instrument | Serial Number | Calibrated on |
|---------------------------|---------------|---------------|
| Network Analyzer HP 8720D | US36140834 | 05/08/99 |
| Calibration Kit HP85033D | 3423A00734 | 05/08/99 |

Procedure:

Full Two port Calibration of 8720D using the 85033D was done.

An assembly of Cables, Attenuator, power splitter, and connectors were set up to complete the RF power measurements.

- Attenuator: 20dB, DC to 1500 MHz - Mini-Circuits model no: NAT-20
- Power splitter 3 Port: 4.50 dB - Mini-Circuits model no: MCL ZN3PD- 900W

The total loss of this cable assembly from the RF input to the RF output was measured to be 26.16 dB at 815.0 ± 6 MHz.

| | | |
|-----------------|-----|---|
| August 30, 1999 | Rev | Document No. 02400-CERT-FCC-TEST-013 |
|-----------------|-----|---|

Power and frequency measurements of RIM Radio Modem at different temperatures:

Place: RF Lab in RIM
 Date: JULY 28th, 1999

Instruments used:

| Instrument | Serial number | Calibrated on |
|-----------------------------|---------------|---------------|
| DC Power supply HP 6632B | US37472173 | 28/07/99 |
| Universal Counter HP 53131A | 3736A18844 | 03/08/99 |
| Power Meter HP EPM-441A | GB37481300 | 05/08/99 |
| Power Sensor HP ECP-E18A | US37181260 | 05/08/99 |

Temperature Chamber used:

Manufacturer: Envirotronics
 Model: SH8C
 Serial No: 01984093-S-10860

Procedure:

The RIM Radio Modem was placed in the Temperature chamber and connected to the instruments outside as shown in the figure below. Dry air was pumped inside the temperature chamber to maintain a back pressure during the test. The Radio was kept in the off condition at all times except when the measurements were to be made.

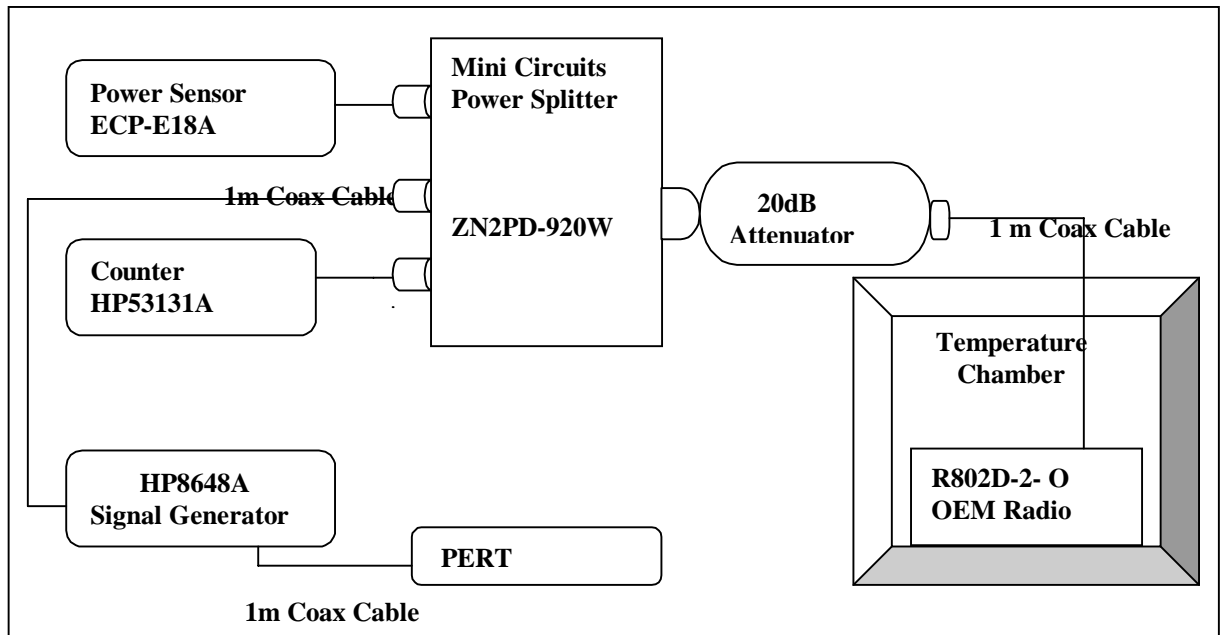

The chamber was switched on and the temperature was set to -30°C.

August 30, 1999

Rev

Document No.

02400-CERT-FCC-TEST-013

After the chamber stabilized at -30 °C there was a soak period of one hour to alleviate moisture in the chamber. The Radio was switched on and frequency and power measurements were made as follows:

The RIM Radio automated test utility was controlled by a computer. This application was given the command of activating all machines intrinsic to the temperature test. It controls the HP 53131A universal counter, HP 6632B power supply, and HP EPM-441A power meter by GPIB Bus. The Environmental Chamber was instructed through an RS-232 serial line. The RIM Radio Modem dialogue was passed through a serial connection from the controlling computer to a Radio Modem Interface. The radio was put in repetitive transmit modes and the power and frequency levels were measured and recorded by the RIM automated test utility.

The RIM Radio Modem Automated test utility produces data files in text format. All data from this test has been formatted from the initial files into a single Spreadsheet.

The RIM Radio Modem output was characterized through its power and frequency across temperature (-30°C to 60°C), and transmit frequency (806 MHz to 821 MHz) at an output power of 33 dBm.

The Radio Modem power and frequency were measured at voltages of 4.15, 4.45 and 4.75 VDC. The transmit frequency was varied in 3 steps consisting of 806 MHz, 815 MHz and 821 MHz. This frequency generated by the RIM Radio Modem has been recorded in MHz and also as deviation from nominal in Parts Per Million.

The output from the RIM Radio Modem was accounted from -30°C to 60°C in +5°C steps. The radio was interrogated for data every 18 seconds for each measurement and 6.0 minutes for each voltage readings. From activity the radio heats up and produces different signals. This heating led to much data which characterizes the radio over most temperatures, not just at 5°C intervals.

After the initial one hour soak, a ½ hour soak was accomplished between the subsequent temperature steps.

PROCEDURE

This process was affected through automation.

1. Switch on the HP 6632B, power supply and set the Voltage to 4.45 V
2. Set the initial Environmental Chamber temperature (-30 Degrees Celsius) and hold for initial soak.
3. Set the frequency to 806 MHz, and power to 33 dBm on RIM Radio Modem.
4. Activate Carrier on RIM Radio Modem.
5. Take initial HP EPM-441A power meter measurement.
6. Take initial HP 53131A frequency counter measurement.
7. Measure temperature of product.
8. Measure power output.
9. Measure frequency output
10. Increase temperature by 5°C and soak for 1/2 hour. Repeat steps 8 - 10 for twenty measurements every 18 seconds for 6 minutes.
11. Repeat steps 3 - 10 for 815 MHz and 821 MHz.
12. Increase temperature by 5°C and soak for 1/2 hour.



| | | |
|-----------------|-----|---|
| August 30, 1999 | Rev | Document No. 02400-CERT-FCC-TEST-013 |
|-----------------|-----|---|

13 Repeat steps 2-12 for temperatures -30 degrees to 60 degrees Celsius.

Procedure 3 to 12 was then repeated at 25°C with the power supply voltage set to 4.15, 4.45 and 4.75V.



| | | |
|-------------------------------------|-----------------|--|
| Author Data Jonathan Doll | August 30, 1999 | Document No. 02400-CERT-FCC-TEST-014 |
| Approved Masud S. Attayi | Rev | File / Reference 014 |

CFR 47 Chapter 1 - Federal Communication Commission Rules

Part 2 Required Measurement

- 2.1055 Frequency Stability - Procedures
- (a,b) Frequency Stability - Temperature Variation

Part 90 - Subpart I : Technical Standards

- 90.213 Frequency Tolerance
- (a) Maintain the carrier frequency within 0.00025 % (2.5 ppm) of the assigned frequency.
- (b) Maximum power output used for measurement

Procedure: These results were obtained using the test procedure described in document 02400 -CERT-FCC-TEST-013.

Results: 806 MHz nominal transmitter

| Ambient Temperature (Degrees Celsius) | Minimum Device Temperature (Degrees Celsius) | Maximum Device Temperature (Degrees Celsius) | Initial Frequency Deviation [ppm] | Maximum Deviation [ppm] |
|---------------------------------------|--|--|-----------------------------------|-------------------------|
| -30 | -22.4 | -21.8 | 0.4591 | 1.3251 |
| -25 | -17.4 | -16.8 | 0.5112 | 0.5112 |
| -20 | -12.7 | -12 | 0.4218 | 0.4218 |
| -15 | -7.4 | -6.6 | 0.2767 | 0.2767 |
| -10 | -2.2 | -1.5 | 0.1427 | 0.1427 |
| -5 | 3 | 3.5 | 0.0298 | 0.0347 |
| 0 | 8 | 8.6 | -0.0360 | 0.8524 |
| 5 | 12.5 | 13.2 | -0.0658 | 0.8189 |
| 10 | 17.6 | 18.3 | -0.0682 | -0.0906 |
| 15 | 22.3 | 23.1 | -0.0273 | -0.0298 |
| 20 | 27.8 | 28.6 | 0.0757 | 0.0968 |
| 25 | 33.1 | 33.8 | 0.1923 | 0.2072 |
| 30 | 37.8 | 39.1 | 0.2643 | 0.2655 |
| 35 | 42.5 | 44.1 | 0.2382 | 0.2382 |
| 40 | 48.1 | 49.1 | 0.0620 | 0.0620 |
| 45 | 53 | 54.2 | -0.2060 | -0.3400 |
| 50 | 58.3 | 59.6 | -0.5546 | -0.7060 |
| 55 | 63.1 | 64.5 | -0.9094 | -1.0434 |
| 60 | 67.9 | 69.3 | -1.1849 | -1.2556 |

Results: 815 MHz nominal transmitter



| | | |
|-------------------------|-----|---|
| Date August 30, 1999 | Rev | Document No. 02400-CERT-FCC-TEST-014 |
|-------------------------|-----|---|

| Ambient Temperature (Degrees Celsius) | Minimum Device Temperature (Degrees Celsius) | Maximum Device Temperature (Degrees Celsius) | Initial Frequency Deviation [ppm] | Maximum Deviation [ppm] |
|---------------------------------------|--|--|-----------------------------------|-------------------------|
| -30 | -22.6 | -22.1 | 0.3988 | 1.3055 |
| -25 | -17.5 | -16.9 | 0.4761 | 0.5031 |
| -20 | -12.7 | -12.1 | 0.3693 | 0.3791 |
| -15 | -7.5 | -7 | 0.2000 | 1.0847 |
| -10 | -2.4 | -1.9 | 0.0810 | 0.0969 |
| -5 | 2.7 | 3.3 | -0.0135 | -0.0135 |
| 0 | 7.7 | 8.3 | -0.0712 | 0.8147 |
| 5 | 12.2 | 12.8 | -0.1141 | -0.1153 |
| 10 | 17.5 | 18 | -0.0945 | -0.1006 |
| 15 | 22.3 | 22.8 | -0.0552 | -0.0613 |
| 20 | 27.8 | 28.3 | 0.0429 | 0.9423 |
| 25 | 33 | 33.8 | 0.1558 | 0.2098 |
| 30 | 37.9 | 38.6 | 0.2221 | 0.2638 |
| 35 | 42.7 | 43.6 | 0.1963 | 0.2184 |
| 40 | 47.9 | 48.7 | 0.0160 | 0.0380 |
| 45 | 53 | 54.1 | -0.2724 | -0.3092 |
| 50 | 58 | 59.2 | -0.6184 | -0.6761 |
| 55 | 63.2 | 64.3 | -0.9669 | -1.0074 |
| 60 | 68.3 | 69.2 | -1.2319 | -1.2405 |



| | | |
|-------------------------|-----|---|
| Date August 30, 1999 | Rev | Document No. 02400-CERT-FCC-TEST-014 |
|-------------------------|-----|---|

Results: 821 MHz nominal transmitter

| Ambient Temperature (Degrees Celsius) | Minimum Device Temperature (Degrees Celsius) | Maximum Device Temperature (Degrees Celsius) | Initial Frequency Deviation [ppm] | Maximum Deviation [ppm] |
|---------------------------------------|--|--|-----------------------------------|-------------------------|
| -30 | -27.9 | -27.9 | 0.3362 | 1.1949 |
| -25 | -23 | -22.9 | 0.4641 | 0.4653 |
| -20 | -18.2 | -18.1 | 0.3995 | 0.3995 |
| -15 | -13.3 | -13.1 | 0.2521 | 0.2558 |
| -10 | -8.3 | -8.2 | 0.1242 | 0.1267 |
| -5 | -3.5 | -3.2 | 0.0037 | 0.0097 |
| 0 | 1.4 | 1.6 | -0.0633 | -0.0804 |
| 5 | 6.2 | 6.3 | -0.1084 | -0.1242 |
| 10 | 11 | 11.1 | -0.1121 | -0.1303 |
| 15 | 15.9 | 16.1 | -0.0828 | -0.0901 |
| 20 | 20.9 | 21 | 0.0085 | 0.9123 |
| 25 | 25.9 | 25.9 | 0.1218 | 1.0305 |
| 30 | 30.8 | 30.9 | 0.2095 | 0.2241 |
| 35 | 35.7 | 35.8 | 0.2266 | 0.2266 |
| 40 | 40.6 | 40.7 | 0.0877 | 0.0877 |
| 45 | 45.6 | 45.7 | -0.1705 | -0.2777 |
| 50 | 50.5 | 50.7 | -0.5104 | -0.6322 |
| 55 | 55.4 | 55.5 | -0.8636 | -0.9805 |
| 60 | 60.4 | 60.5 | -1.1669 | -1.2460 |



| | | |
|-------------------------------------|--------------------------------|--|
| Author Data Jonathan Doll | Date August 30, 1999 | Document No. 02400-CERT-FCC-TEST-015 |
| Approved Masud S. Attayi | Rev | File / Reference 015 |

CFR 47 Chapter 1 - Federal Communication Commission Rules

Part 2 Required Measurement

- 2.1055 Frequency Stability - Procedures
- (d) Frequency Stability - Voltage Variation

Part 90 Subpart I : Technical Standards

- 90.213 Frequency Tolerance
- (a) Maintain the carrier frequency within 0.00025 % (2.5 ppm) of the assigned frequency.
- (b) Maximum power output used for measurement

Procedure: These results were obtained using the test procedure described in document 02400 -CERT-FCC-TEST-013.

Results: 806 MHz. nominal transmitter.

| Ambient Temperature [Degrees Celsius] | Device Supply Voltage [Volts] | Initial Frequency Deviation [ppm] | Maximum Deviation [ppm] |
|---------------------------------------|-------------------------------|-----------------------------------|-------------------------|
| 25.0 | 4.15 | -0.0186 | 1.0074 |
| 25.0 | 4.45 | 0.1923 | 0.2072 |
| 25.0 | 4.75 | 0.2035 | 0.2221 |

Results: 815 MHz. nominal transmitter.

| Ambient Temperature [Degrees Celsius] | Device Supply Voltage [Volts] | Initial Frequency Deviation [ppm] | Maximum Deviation [ppm] |
|---------------------------------------|-------------------------------|-----------------------------------|-------------------------|
| 25.0 | 4.15 | 0.1902 | 1.0577 |
| 25.0 | 4.45 | 0.1558 | 0.2098 |
| 25.0 | 4.75 | 0.1975 | 0.2172 |

Results: 821 MHz. nominal transmitter.

| Ambient Temperature [Degrees Celsius] | Device Supply Voltage [Volts] | Initial Frequency Deviation [ppm] | Maximum Deviation [ppm] |
|---------------------------------------|-------------------------------|-----------------------------------|-------------------------|
| 25.0 | 4.15 | -0.0572 | 1.0171 |
| 25.0 | 4.45 | 0.1218 | 1.0305 |
| 25.0 | 4.75 | 0.1291 | 0.1462 |



| | | |
|-------------------------------------|--------------------------------|--|
| Author Data Jonathan Doll | Date August 30, 1999 | Document No. 02400-CERT-FCC-TEST-015 |
| Approved Masud S. Attayi | Rev | File / Reference 015 |

CFR 47 Chapter 1 - Federal Communication Commission Rules

Part 2 Required Measurement

- 2.1055 Frequency Stability - Procedures
- (d) Frequency Stability - Voltage Variation

Part 90 Subpart I : Technical Standards

- 90.213 Frequency Tolerance
- (a) Maintain the carrier frequency within 0.00025 % (2.5 ppm) of the assigned frequency.
- (b) Maximum power output used for measurement

Procedure: These results were obtained using the test procedure described in document 02400 -CERT-FCC-TEST-013.

Results: 806 MHz. nominal transmitter.

| Ambient Temperature [Degrees Celsius] | Device Supply Voltage [Volts] | Initial Frequency Deviation [ppm] | Maximum Deviation [ppm] |
|---------------------------------------|-------------------------------|-----------------------------------|-------------------------|
| 25.0 | 4.15 | -0.0186 | 1.0074 |
| 25.0 | 4.45 | 0.1923 | 0.2072 |
| 25.0 | 4.75 | 0.2035 | 0.2221 |

Results: 815 MHz. nominal transmitter.

| Ambient Temperature [Degrees Celsius] | Device Supply Voltage [Volts] | Initial Frequency Deviation [ppm] | Maximum Deviation [ppm] |
|---------------------------------------|-------------------------------|-----------------------------------|-------------------------|
| 25.0 | 4.15 | 0.1902 | 1.0577 |
| 25.0 | 4.45 | 0.1558 | 0.2098 |
| 25.0 | 4.75 | 0.1975 | 0.2172 |

Results: 821 MHz. nominal transmitter.

| Ambient Temperature [Degrees Celsius] | Device Supply Voltage [Volts] | Initial Frequency Deviation [ppm] | Maximum Deviation [ppm] |
|---------------------------------------|-------------------------------|-----------------------------------|-------------------------|
| 25.0 | 4.15 | -0.0572 | 1.0171 |
| 25.0 | 4.45 | 0.1218 | 1.0305 |
| 25.0 | 4.75 | 0.1291 | 0.1462 |