

DIMENSIONS ARE IN: mm

UNLESS OTHERWISE SPECIFIED
TOLERANCES ARE:
LINEAR: ± NA
ANGULAR: ± NA°
SURFACE FINISH NA

INTERPRET DIMENSIONS
AND TOLERANCES AS PER
ANSI Y14.5M-1994

A	ECN- XXX	XXX	XXX	XXX
REV	ECN	CHANGES		DATE
A			RESEARCH IN MOTION WATERLOO, ONTARIO CANADA PH: (519) 888-7465, FAX: (519) 888-6906	
DWG SIZE	APPROVALS		THE CONTENT OF THIS DOCUMENT IS RIM INTELLECTUAL PROPERTY. IT IS CONFIDENTIAL AND IS NOT TO BE DISCLOSED, REPRODUCED OR USED EXCEPT WITH THE WRITTEN PERMISSION OF RIM. COPYRIGHT 1998 RESEARCH IN MOTION LIMITED.	
	NAME	DATE		
DESIGNED BY	JAH	02-04-99	PROJECT:	AMSC
DRAWN BY	JAH	02-04-99	NAME:	PAGER LABELS
CHECKED BY	XXX	MM-DD-YR	CAD MODEL FILE:	FCCASSY
ENG APPRD	XXX	MM-DD-YR	SCALE	1:1
MFG APPRD	XXX	MM-DD-YR	SHEET	1 OF 1
SUPERSEDES	XXX	MM-DD-YR	R800D-2-PW_LABEL	
SUPSD BY	XXX	MM-DD-YR	REV A	
FILEPATH	/RIMSERV1/HOME/JHOLMES/PROJ_FILES			

PART NO.	REV	ECN	DESCRIPTION	ARTWORK NO.
MAT-02210-001	1	ECN-00XXX	LABEL - BOTTOM, AMSC	ART-02210-001

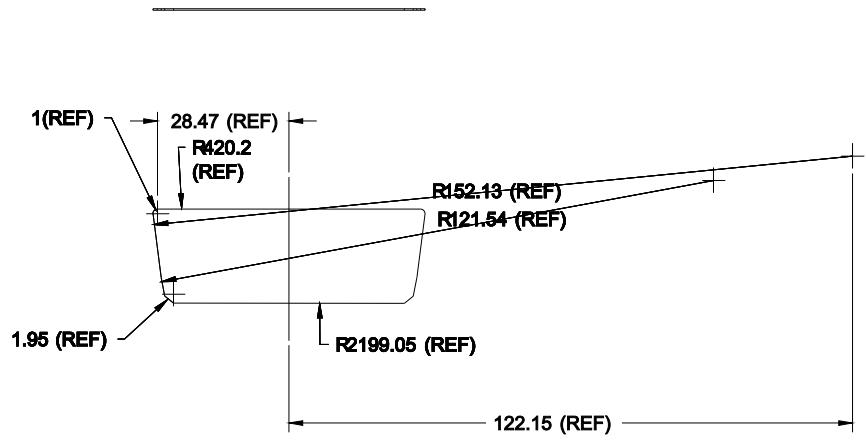

PART IS SYMETRICAL ABOUT CENTRELINE

NOTES:
 1. MATERIAL: 8B35 SUB-SURFACE PRINTED POLYCARBONATE (LEXAN) FILM
 FILM THICKNESS: 10 mil [(0.25mm/.010")]
 COLOUR: *TRANSPARENT
 2. ADHESIVE: *PERMANENT PRESSURE-SENSITIVE ACRYLIC
 THICKNESS: 2 mil [0.05mm (.002")]
 LINER: *SILICONE TREATED PAPER OR DENSIFIED KRAFT
 3. ARTWORK: OBTAIN FROM RIM TECHNICAL PUBLICATIONS DEPT.
 REFERENCE RIM PART NO. ART-02210-XXX, LATEST REVISION
 4. *PART TO BE DIE CUT WITH LINER AND SUPPLIED IN ROLL FORM
 5. PACKAGING:
 ROLL FORM:
 *ROLLS TO BE INDIVIDUALLY WRAPPED IN PROTECTIVE PACKAGING
 *ROLLS TO DISPLAY RIM PART NUMBER AND NUMBER OF LABELS/ROLL
 6. PART TOOLING (DIE) TO BE MANUFACTURED USING GEOMETRY FROM Pro/ENGINEER
 FILE SUPPLIED BY RIM MECHANICAL ENGINEERING DEPT.

DIMENSIONS ARE IN: mm
 UNLESS OTHERWISE SPECIFIED
 TOLERANCES ARE:
 LINEAR: ± 0.1
 ANGULAR: ± 0.5 °
 SURFACE FINISH 1.6

INTERPRET DIMENSIONS
 AND TOLERANCES AS PER
 ANSI Y14.5M-1994

1	ECN: 00XXX	INITIAL RELEASE	PD	MM-DD-YR
REV	ECN	CHANGES		DFTS DATE
B		RESEARCH IN MOTION WATERLOO, ONTARIO CANADA PH:(519) 888-7465, FAX:(519) 888-6906		
APPROVALS		THE CONTENT OF THIS DOCUMENT IS RIM INTELLECTUAL PROPERTY. IT IS CONFIDENTIAL AND IS NOT TO BE DISCLOSED, REPRODUCED OR USED EXCEPT WITH THE WRITTEN PERMISSION OF RIM. COPYRIGHT 1999 RESEARCH IN MOTION LIMITED.		
DESIGNED BY	P.DULLAERT	DATE	PROJECT: LEAPFROG	
DRAWN BY	P.BIMOB	01-21-98	NAME: LABEL - BOTTOM BLANK	
CHECKED BY	P.BIMOB	09-24-98	CAD MODEL FILE: MAT-02210-001_A_LABEL-BOTTOM_BL	
ENG APPRD			SCALE 1:1	
MFG APPRD	XXX	MM-DD-YR	SHEET 1 OF 1	
SUPERSEDES	XXX	MM-DD-YR	MAT-02210-001	
SUP'D BY	XXX	MM-DD-YR		
FILEPATH	/RIMSERVICAD/ARCHIVE/LEAPFROG		REV	A

PART NO.	REV	ECN	DESCRIPTION	ARTWORK NO.	REV	ECN
MAT-01978-001	1	ECN-00284	NAMEPLATE - RIM (SATIN CHROME)	ART-01978-001	2	ECN-00347
MAT-01978-002	1	ECN-00347	NAMEPLATE - RIM (SATIN GOLD)	ART-01978-002	1	ECN-00347

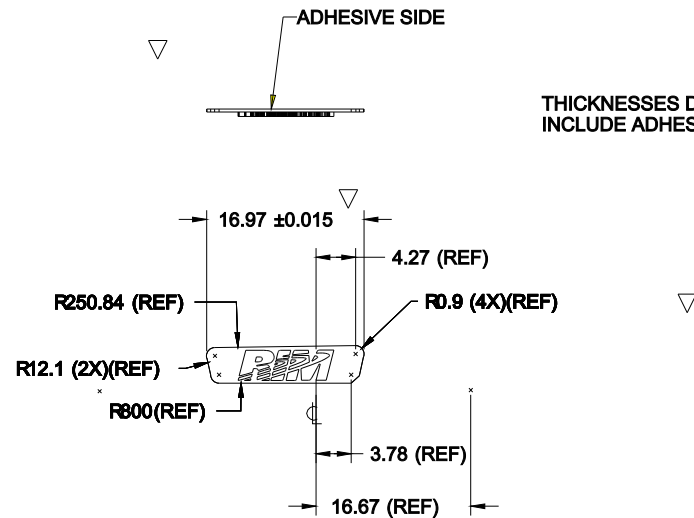

THICKNESSES DO NOT
INCLUDE ADHESIVE

PART IS NOT SYMMETRICAL ABOUT CENTRELINE

NOTES:

1. MATERIAL: ELECTROFORMED COPPER
2. ADHESIVE: *PERMANENT PRESSURE-SENSITIVE ACRYLIC, DOUBLE SIDED : NITTO 500
THICKNESS: 5 mil [0.127mm (.005")]
3. LINER: *SILICONE TREATED PAPER OR DENSIFIED KRAFT
4. ARTWORK: OBTAIN FROM RIM TECHNICAL PUBLICATIONS DEPT.
REFERENCE RIM PART NO. ART-01978-XXX, LATEST REVISION
5. *PART TO BE DIE CUT WITH LINER AND SUPPLIED IN SHEET FORM
6. PACKAGING:
SHEET FORM:
*SHEETS TO BE WRAPPED IN PROTECTIVE PACKAGING, 80/PACK
*PACKS TO DISPLAY RIM PART NUMBER AND NUMBER OF NAMEPLATES/PACK
7. PART TOOLING TO BE MANUFACTURED USING GEOMETRY FROM Pro/ENGINEER
FILE SUPPLIED BY RIM MECHANICAL ENGINEERING DEPT.
8. DIMENSIONS WITH ∇ DENOTE CRITICAL INSPECTION DIMENSIONS

REV	ECN	CHANGES	DFTS	DATE
2	ECN- 00347	TABLE: ADDED NEW PART, MAT-01978-002	PS	11-17-98
1	ECN- 00284	INITIAL RELEASE	PLD	01-21-98

B DWG SIZE 3rd ANGLE PROJECTION	APPROVALS NAME DATE DESIGNED BY PDULLABRT 01-21-98 DRAWN BY P8IMCOES 11-18-98 CHECKED BY P8IMCOES 11-18-98 ENG APPRD MFG APPRD XXX MM-DD-YR SUPERSEDES XXX MM-DD-YR SUPP'D BY XXX MM-DD-YR FILEPTH /RIMSERV/CAD/ARCHIVE/LEAPFROG		RESEARCH IN MOTION WATERLOO, ONTARIO CANADA PH:(519) 888-7465, FAX:(519) 888-8908 THE CONTENT OF THIS DOCUMENT IS RIM INTELLECTUAL PROPERTY. IT IS CONFIDENTIAL AND IS NOT TO BE DISCLOSED, REPRODUCED OR USED EXCEPT WITH THE WRITTEN PERMISSION OF RIM. COPYRIGHT 1998 RESEARCH IN MOTION LIMITED. PROJECT: LEAPFROG NAME: NAMEPLATE - RIM CAD MODEL FILE: MAT-01978-002_NAMEPLATE.RIM
	DIMENSIONS ARE IN: mm UNLESS OTHERWISE SPECIFIED TOLERANCES ARE: LINEAR: ± 0.025 ANGULAR: ± 0.5 ° SURFACE FINISH 1.6 INTERPRET DIMENSIONS AND TOLERANCES AS PER ANSI Y14.5M-1994		

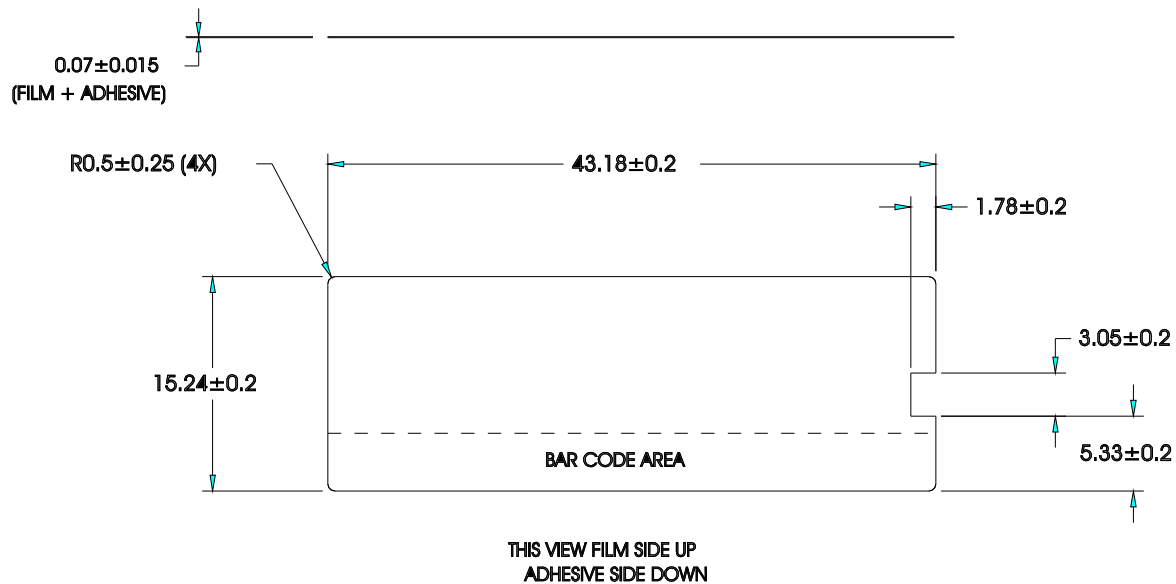

NOTES:

- 1) MATERIAL: 3M 7816 THERMAL-PRINTABLE POLYESTER FILM
FILM THICKNESS: .002"/0.05mm (2 mil FACE STOCK).
- 2) ADHESIVE: PERMANENT PRESSURE-SENSITIVE ACRYLIC.
THICKNESS: 0.7-1.0 mils (.0007-.001"/0.018-0.025mm).
- 3) PRINTING PROCESS: SILK SCREEN ONLY.
- 4) SUPPLY ON ROLL OF RELEASE PAPER. EACH ROLL
TO BE INDIVIDUALLY WRAPPED IN PROTECTIVE PACKAGING.
RIM PART NUMBER AND NUMBER OF LABELS SETS
PER ROLL TO BE STATED ON EACH ROLL.
ROLL TO HAVE 3" DIA. CORE AND LABELS TO BE
OUTSIDE WOUND - HEAD FIRST.
MAXIMUM OUTSIDE ROLL DIA. TO BE 8".
- 5) OBTAIN ARTWORK FROM RIM TECHNICAL PUBLICATIONS DEPT.
- 6) TO MANUFACTURE DIE, USE GEOMETRY FROM AUTOCAD .dxf
FILE OBTAINED FROM RIM MECHANICAL ENGINEERING DEPT.
- 7) USE OVERALL WIDTH AND LENGTH DIMENSIONS GIVEN FOR CHECKING.

THE CONTENT OF THIS DOCUMENT IS RIM INTELLECTUAL PROPERTY.
IT IS CONFIDENTIAL AND IS NOT TO BE DISCLOSED, REPRODUCED
OR USED EXCEPT WITH THE WRITTEN PERMISSION OF RIM.

COPYRIGHT 1999 RESEARCH IN MOTION LIMITED

DIMENSIONS ARE IN: mm

UNLESS OTHERWISE SPEC.
TOLERANCES ARE:

.XX = ± 0.025
X = ± 0.1
ANGLES = ± 0.5°

SURFACE FINISH 1.6 ✓

A	ECN-00XXX	INITIAL RELEASE	PLD	12/02/99
REV	ECN	CHANGES	DFTS	DATE
DRAWN BY: R DULLABT CHKD BY: APPRD BY:		295 PHILLIP ST., WATERLOO, ONTARIO, CANADA, N2L 3W8 www.rim.net VOICE: (519) 888-7466, FAX: (519) 888-6906		
SCALE: 2:1 FILEPATH: C:\WORKING\		PART NAME: LABEL - BATTERY, R800D-2-PW PROJECT: LEAPFROG - AMSC		
DWG SIZE		DRAWING NUMBER: MAT-01979-003		



1	ECN-0xxx	NEW	HD	02/16/99
REV	ECN	CHANGES		DATE
Software: CorelDRAW 7.0 Colours: Pantone 877, Pantone 433, Pantone 1815C or 187U, process black		 RESEARCH IN MOTION WATERLOO, ONTARIO, CANADA PH:(519) 888-7465 FAX:(519) 888-6906		
APPROVALS		THE CONTENT OF THIS DOCUMENT IS RIM INTELLECTUAL PROPERTY. IT IS CONFIDENTIAL AND IS NOT TO BE DISCLOSED, REPRODUCED OR USED EXCEPT WITH THE WRITTEN PERMISSION OF RIM. COPYRIGHT 1999 RESEARCH IN MOTION LIMITED.		
	NAME	DATE		
DRAWN BY	Heather Dwyer	02/16/99		
CHK'D BY				
ENG			PROJECT:	Leapfrog
MFG				
MKTG			NAME:	Art - BlackBerry label
LEGAL				
SUPERSEDES			SCALE	1 : 1
SUPSD BY			SHEET	1 OF 1
FILEPATH: ILINK/PROJECTS			ART-01976-006	
				REV 1



Notes:

1. Plating finish: Satin Chrome
2. Background: Match background to GE Cycoloy C1200HF Resin, colour: GE-CY1353, surface textured as per unlimited textures MT11020. Supplied by RIM Mechanical Engineering Dept.

2	ECN-00347	ADDED NOTES	SC	11/18/98
1	ECN-00291	INITIAL RELEASE	HD	09/03/98
REV	ECN	CHANGES	DFTS	DATE
Software: CorelDraw 7.0		 RESEARCH IN MOTION WATERLOO, ONTARIO, CANADA PH:(519) 888-7465 FAX:(519) 888-6906		
APPROVALS		THE CONTENT OF THIS DOCUMENT IS RIM INTELLECTUAL PROPERTY. IT IS CONFIDENTIAL AND IS NOT TO BE DISCLOSED, REPRODUCED OR USED EXCEPT WITH THE WRITTEN PERMISSION OF RIM. COPYRIGHT 1998 RESEARCH IN MOTION LIMITED.		
	NAME DATE			
DRAWN BY	Susan Clarke 04/01/98	PROJECT:	Leapfrog	
CHK'D BY		NAME:	NAMEPLATE - RIM (Satin Chrome)	
ENG		SCALE	1 : 1	
MFG		SHEET	1 OF 1	
MKTG		ART-01978-001		REV 2
LEGAL				
SUPERSEDES				
SUPSD BY				
FILEPATH:	W:\y\cad\archive\leapfrog			

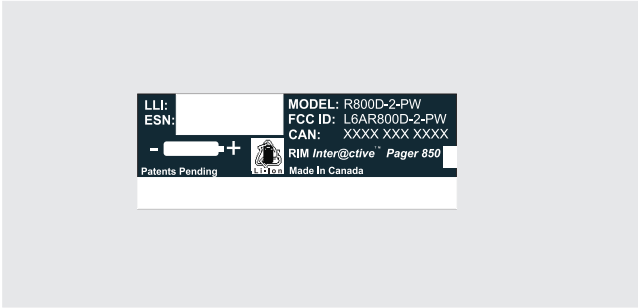

LLI:		MODEL: R800D-2-PW
ESN:		FCC ID: L6AR800D-2-PW
		CAN: XXXX XXX XXXX
- [] + []		RIM Inter@ctive Pager 850
Patents Pending		Made In Canada

A	ECN-00xxx	NEW	HD	02/16/99		
REV	ECN	CHANGES	DFTS	DATE		
Software: CorelDraw 7.0 Colours: Pantone spot colour 433 and process white		 RESEARCH IN MOTION WATERLOO, ONTARIO, CANADA PH:(519) 888-7465 FAX:(519) 888-6906				
		APPROVALS NAME DATE DRAWN BY Heather Dwyer 02/16/99 CHK'D BY ENG MFG MKTG LEGAL SUPERSEDES SUPSD BY FILEPATH: ILINK/PROJECTS			THE CONTENT OF THIS DOCUMENT IS RIM INTELLECTUAL PROPERTY. IT IS CONFIDENTIAL AND IS NOT TO BE DISCLOSED, REPRODUCED OR USED EXCEPT WITH THE WRITTEN PERMISSION OF RIM. COPYRIGHT 1999 RESEARCH IN MOTION LIMITED.	
		PROJECT:	RIM Inter@ctive Pager™ 850			
		NAME:	LABEL - BATTERY COMPARTMENT, PRINTED			
		SCALE 1:1				
		SHEET 1 OF 1				
			ART-01979-003	REV A		