

EMI Test Report

Tested in accordance with
Federal Communications Commission (FCC)
Personal Communications Services
CFR 47, Parts 2, 22 and 24
and
Industry Canada, RSS-133 and RSS-128



Research In Motion Limited

REPORT NO.: RIM-0054-0307-06

PRODUCT MODEL NO: R6030GN
TYPE NAME: BlackBerry Wireless Handheld
FCC ID: L6AR6030GN
IC: 2503A-R6030GN

Date: _____ 18 July 2003 _____

Declaration**Statement of Performance:**

The BlackBerry Wireless Handheld, model R6030GN ASY-06030-001 version 003 when configured and operated per RIM's operation instructions, performs within the requirements of the test standards.

Declaration:

We hereby certify that:

The test data reported herein is an accurate record of the performance of the sample(s) tested.

The test equipment used was suitable for the tests performed and within the manufacturers published specifications and operating parameters.

The test methods were consistent with the methods described in the relevant standards.

Tested by

Maurice Battler
Compliance Specialist

Date: 17 July 2003



Masud S. Attayi, P.Eng.
Senior Compliance Engineer

Date: 18 July 2003

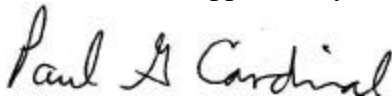
Reviewed and Approved by:

Paul G. Cardinal, Ph.D.
Manager, Compliance and Certification

Date: 18 July 2003

Table of Contents

A) Scope	Pg. 3
B) Product Identification	Pg. 3
C) Support Equipment Used for Testing of the EUT	Pg. 4
D) Test Voltage	Pg. 4
E) Test Results Chart	Pg. 4
F) Modifications to EUT	Pg. 4
G) Summary of Results	Pg. 5
H) Compliance Test Equipment Used	Pg. 8

Appendix 1 Conducted Emissions Test Data/Plots

Appendix 2 Conducted RF Output Power Test Data

Appendix 3 Frequency Stability Test Data

Appendix 4 Radiated Emissions Test Data

A) Scope

This report details the results of compliance tests which were performed in accordance to the requirements of:

FCC CFR 47 Part 2, Oct. 1, 2000

FCC CFR 47 Part 22, Subpart H, Cellular Radiotelephone Services, Oct. 1, 2000

FCC CFR 47 Part 24 Subpart E, Broadband PCS, Oct 1. 2000

Industry Canada, RSS-128 Issue 2, Rev 1, Nov. 6/99, 800 MHz Dual-Mode TDMA Cellular Telephones

Industry Canada, RSS-133 Issue 2, Rev. 1 Nov. 6/1999, 2.0 GHz Personal Communications Services

B) Product Identification

The equipment under test (EUT) was tested at the Research In Motion (RIM) EMI test facility, located at:

305 Phillip Street

Waterloo, Ontario

Canada, N2L 3W8

Phone: 519 888 7465

Fax: 519 888 6906

Web Site: www.rim.net

The testing began on July 08, 2003 and completed on July 14, 2003. The sample equipment under test (EUT) included:

1a BlackBerry Wireless Handheld, model number R6030GN, ASY-06030-001 version 003, PIN 2004A983, IMEI 001020.00.053040.0, FCC ID L6AR6030GN, IC: 2503A-R6030GN.

1b BlackBerry Wireless Handheld, model number R6030GN, ASY-06030-001 version 003, PIN 2004A97F, IMEI 001020.00.053036.0, FCC ID L6AR6030GN, IC: 2503A-R6030GN.

The transmit frequency bands for the Handheld are: GSM 824 to 849 MHz, DCS 1710 to 1785 MHz and PCS 1850 to 1910 MHz. Only the GSM band and PCS band emission results are presented here.

C) Support Equipment Used for the Testing of the EUT

- 1) Rohde & Schwarz, Universal Radio Communication Tester, model number CMU 200, serial number 100249
- 2) Rohde & Schwarz, Universal Radio Communication Tester, model number CMU 200, serial number 837493/073
- 3) DC Power Supply, H/P, model 6632B, serial number US37472179

D) Test Voltage

The ac input voltage was 120 volts, 60 Hz where applicable. This configuration was per RIM's specifications.

E) Test Results Chart

SPECIFICATION	Test Type	MEETS REQUIREMENTS	Performed By
FCC CFR 47 Part 22, Subpart H IC RSS-128	Radiated Spurious/harmonic Emissions, ERP, LO	Yes	Masud Attayi
FCC CFR 47 Part 22, Subpart H IC RSS-128	Conducted Emissions, Occupied Bandwidth, Frequency Stability	Yes	Maurice Battler
FCC CFR 47 Part 24, Subpart E IC RSS-133	Radiated Spurious/harmonic Emissions, EIRP, LO	Yes	Masud Attayi
FCC CFR 47 Part 24, Subpart E IC RSS-133	Conducted Emissions, Occupied Bandwidth, Frequency Stability	Yes	Maurice Battler

F) Modifications to EUT

No modifications were required to the EUT.

G) Summary of Results

- 1) The EUT passed the Conducted Spurious Emissions requirements in the GSM850 band as per 47 CFR 22.917, CFR 22.901(d). The EUT was measured on the low, middle and high channels. The frequency range investigated was from 10 MHz to 10 GHz.
See APPENDIX 1 for the test data.
- 2) The EUT passed the Conducted Spurious Emissions requirements in the PCS band as per 47 CFR 2.1057, CFR 24.238 and RSS-133. The EUT was measured on the low, middle and high channels. The frequency range investigated was from 10 MHz to 20 GHz.
See APPENDIX 1 for the test data.
- 3) The EUT passed the Occupied Bandwidth and channel mask requirements in the GSM band as per 47 CFR 2.202, CFR 22.917 and RSS-128. The channels measured were low, middle and high.
See APPENDIX 1 for the test data.
- 4) The EUT passed the Occupied Bandwidth and channel mask requirements in the PCS band as per 47 CFR 2.202, CFR 24.238 and RSS-133. The channels measured were low, middle and high.
See APPENDIX 1 for the test data.
- 5) The EUT passed the Conducted RF Output Power requirements for both the GSM850 and PCS bands. The channels measured were low, middle and high.
See APPENDIX 2 for the test data.
- 6) The EUT passed the Frequency Stability vs. Temperature and Voltage requirements for GSM850 band as per 22.917 and RSS-128.
The maximum frequency error measured was less than 0.1 ppm.
The temperature range was from -30°C to +60°C in 10° temperature steps. The EUT was measured on low, middle and high channels at each temperature step. The EUT was measured at low (3.5 volts), nominal (3.8 volts) and high (4.1 volts) dc input voltage at each temperature step and channel at maximum output power.
See APPENDIX 3 for the test data.

- 7) The EUT passed the Frequency Stability vs. Temperature and Voltage requirements for the PCS band as per 24.235 and RSS-133. The maximum frequency error measured was less than 0.1 ppm.

The temperature range was from -30°C to +60°C in 10 degree temperature steps. The EUT was measured on low, middle and high channels at each temperature step. The EUT was measured at low (3.5 volts), nominal (3.8 volts) and high (4.1 volts) dc input voltage at each temperature step and channel at maximum output power.

See APPENDIX 3 for the test data.

- 8) The radiated spurious emissions/harmonics and ERP/EIRP were measured for both GSM850 and PCS bands. The results are within the limits. The EUT was placed on a nonconductive wooden table, 80 cm high plus 20 cm high styrofoam on top of the table which was positioned on a remotely rotatable turntable. The EUT height of one metre was set in order to align it with the lowest height of the receiving antenna. The test distance used between the EUT and the receiving antenna was three metres. At this point the emissions were maximized by elevating the antenna in the range of 1 to 4 metres. The turntable was rotated to determine the azimuth of the peak emissions. The maximum emissions level was recorded. The measurements were performed in a semi-anechoic chamber. The semi-anechoic chamber FCC registration number is **778487** and the Industry Canada file number is **IC4240**. The EUT was measured on the low, middle and high channels.

The highest ERP in the GSM850 band measured was 24.5 dBm at 848.8 MHz (channel 251).

The highest EIRP in the PCS band measured was 30.1 dBm at 1850.2 MHz (channel 512).

To view the test data see APPENDIX 4.

The radiated carrier harmonics were measured up to the 10th harmonic for low, middle and high channels in the GSM850 and PCS bands.

The worst test margin for GSM850 measured was 19.9 dB below the limit at 1675.2 MHz.

The worst test margin for PCS measured was 28.7 dB below the limit at 3700.4 MHz.

To view the test data see APPENDIX 4.

The EUT's RF local oscillator 1 emissions were measured in the GSM850 band on the low and high channels (128 and 251) in the standalone upright position. Both the horizontal and vertical polarizations were measured. The GSM850 RF local oscillator 1 emissions were in the noise floor (NF).

The EUT's RF local oscillator 1 emissions were measured in the PCS band on the low and high channels (512 and 810) in the standalone upright position. Both the horizontal and vertical polarizations were measured. The PCS RF local oscillator 1 emissions were in the NF.

The EUT's RF local oscillator 2 emissions were measured in the GSM850 band on the low and high channels in the standalone upright position. Both the horizontal and vertical polarizations were measured. The GSM850 RF local oscillator 2 emissions were in the NF.

The EUT's RF local oscillator emissions were measured in the PCS band on the low and high channels in the standalone upright position. Both the horizontal and vertical polarizations were measured. The PCS RF local oscillator 2 emissions were in the NF.

The EUT's IF local oscillator emissions in the GSM850 band were measured in the middle channel for both the horizontal and vertical polarizations. The lowest emission test margin was 8.65 dB at 896.0 MHz.

The EUT's IF local oscillator emissions in the PCS band were measured in the middle channel for both the horizontal and vertical polarizations. The PCS IF local oscillator emissions were in the NF.

Sample Calculation:

Field Strength (dB μ V/M) is calculated as follows:

$$FS = \text{Measured Level (dB}\mu\text{V)} + \text{A.F. (dB/m)} + \text{Cable Loss (dB)} - \text{Preamp (dB)} + \text{Filter Loss (dB)}$$

Measurement Uncertainty ± 4.0 dB

H) Compliance Test Equipment Used

<u>UNIT</u>	<u>MANUFACTURER</u>	<u>MODEL</u> / <u>SERIAL NUMBER</u>	<u>CAL DUE DATE</u> (YY MO DD)	<u>USE</u>
Preamplifier system	TDK RF Solutions	PA-02 080010	03-10-02	Radiated Emissions
Preamplifier	Sonoma	310N/11909A 185831	03-10-02	Radiated Emissions
EMC Analyzer	Agilent	E7405A US40240226	03-09-21	Radiated Emissions
Universal Radio Communication Tester	Rohde & Schwarz	CMU 200 837493/073	04-04-05	Radiated Emissions
Horn Antenna	TDK	HRN-0118 130092	03-08-14	Radiated Emissions
Horn Antenna	TDK	HRN-0118 030201	03-12-11	Radiated Emissions
Hybrid Log Antenna	TDK	HLP-3003C 017301	03-12-11	Radiated Emissions
Dipole Antenna	Schwarzbeck	VHAP 1006	03-09-12	Radiated Emissions
Dipole Antenna	Schwarzbeck	VHAP 1007	03-09-12	Radiated Emissions
Synthesized Sweeper	Agilent	83630B 3844A00927	04-04-30	Radiated Emissions
Universal Radio Communication Tester	Rohde & Schwarz	CMU 200 100249	04-04-05	Conducted Emissions
Spectrum Analyzer	HP	8563E 3745A08112	03-07-31	Conducted Emissions
DC Power Supply	HP	6632B US37472170	03-07-31	Conducted Emissions
Temperature Probe	Hart Scientific	61161-302 21352860	03-09-10	Conducted Emissions
Environmental Chamber	ESPEC Corp.	SH-240S1 91005607	N/R	Conducted Emissions

APPENDIX 1

CONDUCTED EMISSIONS TEST DATA/PLOTS

Conducted Emission Test Results

This appendix contains measurement data pertaining to conducted spurious emissions, -26 dBc bandwidth, 99% power bandwidth and the channel mask.

Test Setup Diagram

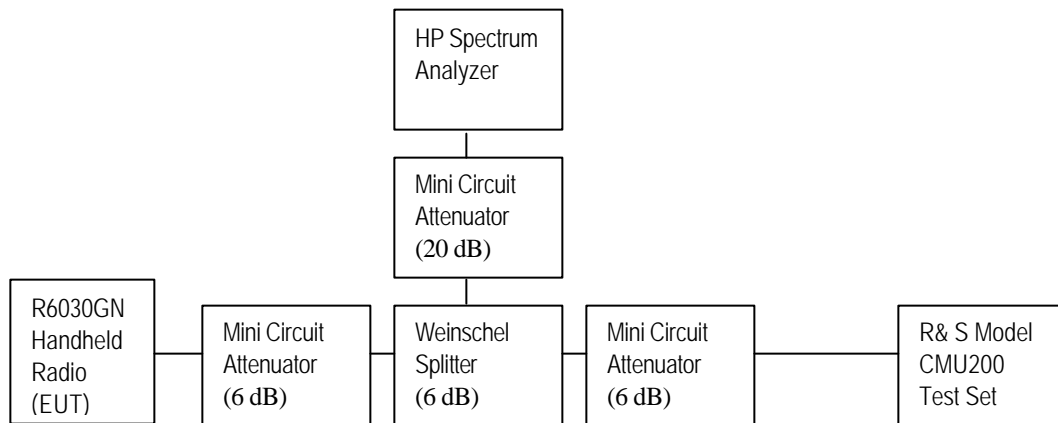

Test Equipment List

Test Instruments	Manufacturer	Model No.	Serial No.	Frequency Range
Spectrum Analyzer	HP	8563E	374A08112	30 Hz – 26.5 GHz
Splitter	Weinschel	1515	ME092	DC – 18 GHz
Attenuator	Mini Circuit	MCL BW-S20W2	--	DC – 18 GHz
Attenuator	Mini Circuit	MCL BW-S6W2	--	DC – 18 GHz
Attenuator	Mini Circuit	MCL BW-S6W2	--	DC – 18 GHz
Universal Radio Communication Tester	Rohde & Schwarz	CMU200	100249	--

Conducted Emission Test Data Con't

The conducted spurious emissions – As per 47 CFR 2.202, 47 CFR 2.1057, 47 CFR 24.238, RSS-133, CFR 22 Subpart H and RSS-128 were measured from 10 MHz to 20 GHz. The EUT has a test margin of greater than 20 dB.

See figures 1 to 12 for the plots of the conducted spurious emissions.

-26 dBc Bandwidth and Occupied Bandwidth (99%)

For each carrier frequency of low, middle and high, the modulation spectrum were measured by both methods of 99% power bandwidth and -26 dBc bandwidth.

The resolution bandwidth required for out-of-band emissions in the 1 MHz bands immediately outside and adjacent to the frequency block, was determined to be at least 1% of the emission bandwidth.

The worst case emission bandwidth for the three GSM850 channels was measured to be 278.0 kHz, and for the three PCS channels was measured to be 273 kHz as shown below, which results in 3.0 kHz resolution bandwidth.

On any frequency outside the frequency block and outside the adjacent 1 MHz bands, a resolution bandwidth of at least 1 MHz was employed.

Test Data for GSM850 and PCS selected Frequencies

GSM Frequency (MHz)	-26dBc Bandwidth (kHz)	-99% Occupied Bandwidth (kHz)
824.2	283	248
837.6	278	250
848.8	272	248

PCS Frequency (MHz)	-26dBc Bandwidth (kHz)	99% Occupied Bandwidth (kHz)
1850.2	270	248
1880.0	265	247
1909.8	273	245

Measurement Plots for GSM850 and PCS

Refer to the following measurement plots for more detail.

See Figures 1 to 12 for plots of the Spurious Emission results

See Figures 13 to 24 for the plots of the -26dBc Bandwidth and 99% Occupied Bandwidth.

See Figures 25 to 28 for plots of the channel mask results.

The RF power output was at maximum for all the recorded measurements shown below.

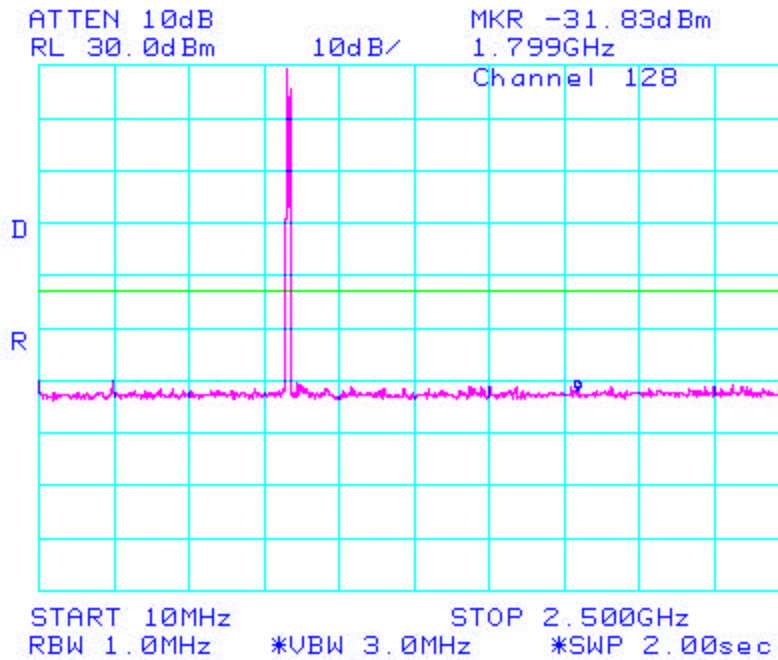
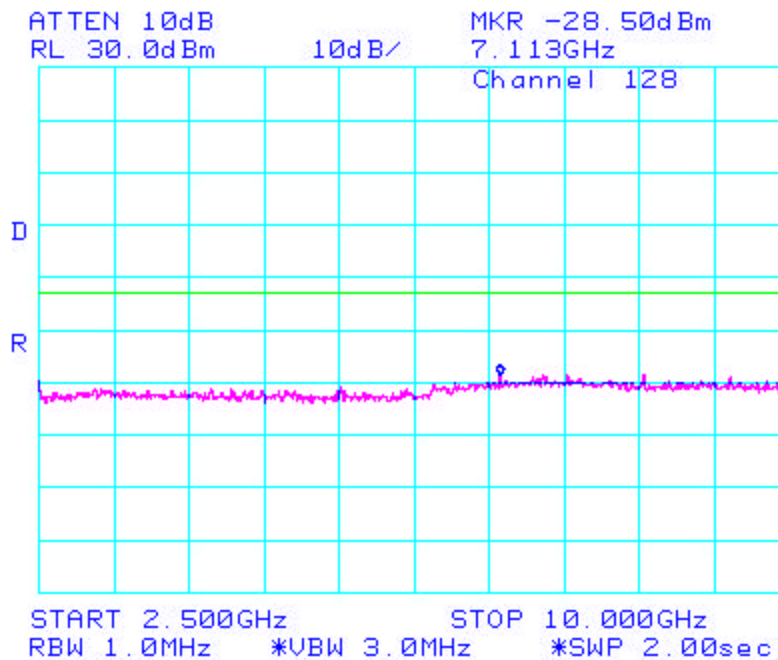
Conducted Emission Test Results con't**Figure 1: GSM 850, Spurious Conducted Emissions, Low channel****Figure 2: GSM 850, Spurious Conducted Emissions, Low channel**

Conducted Emission Test Results Con't

Figure 3: GSM 850, Spurious Conducted Emissions, Middle Channel

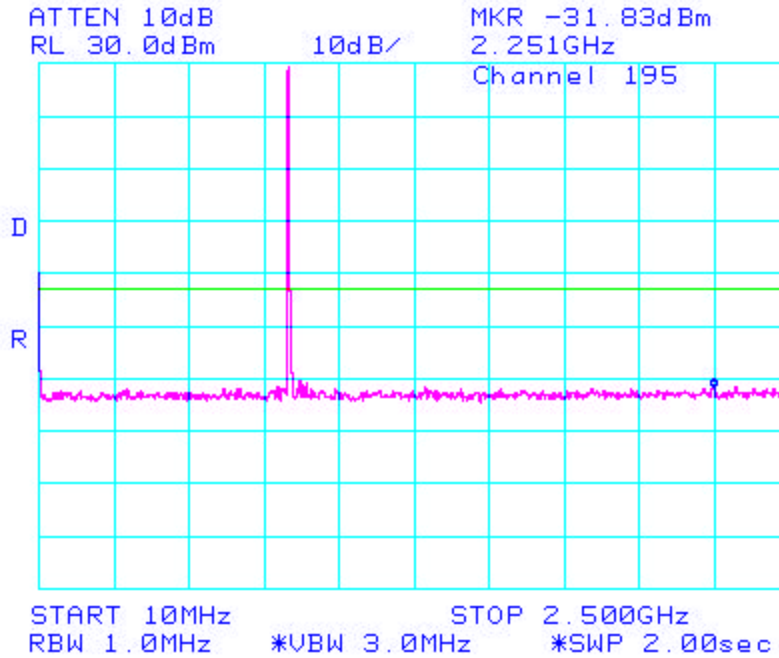
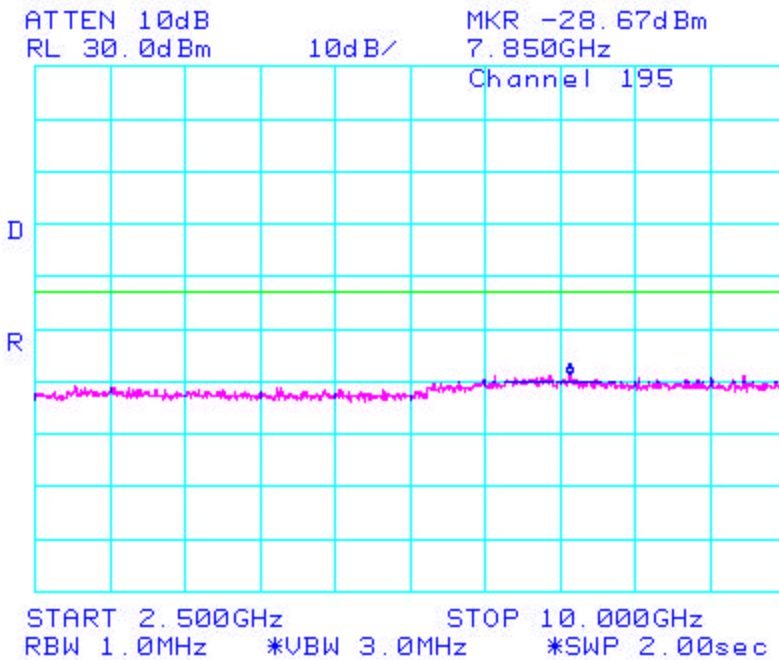
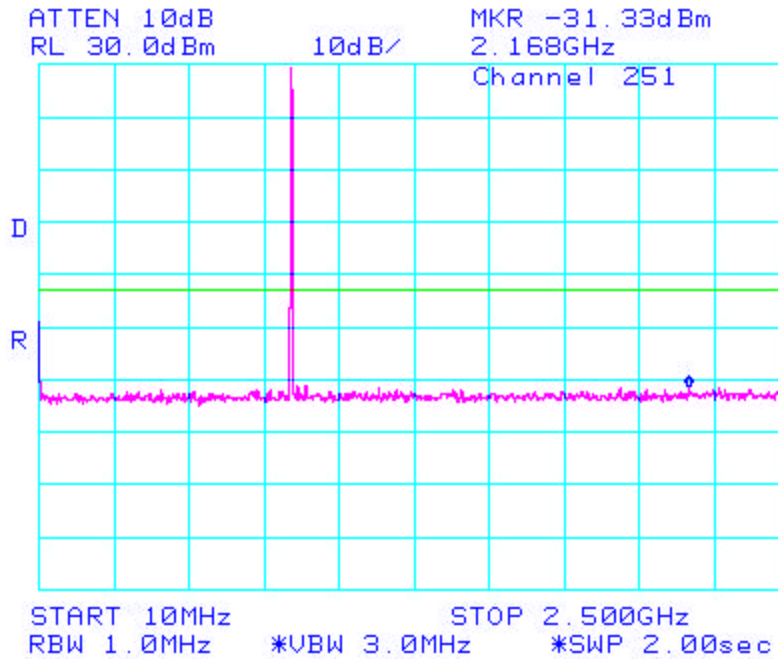
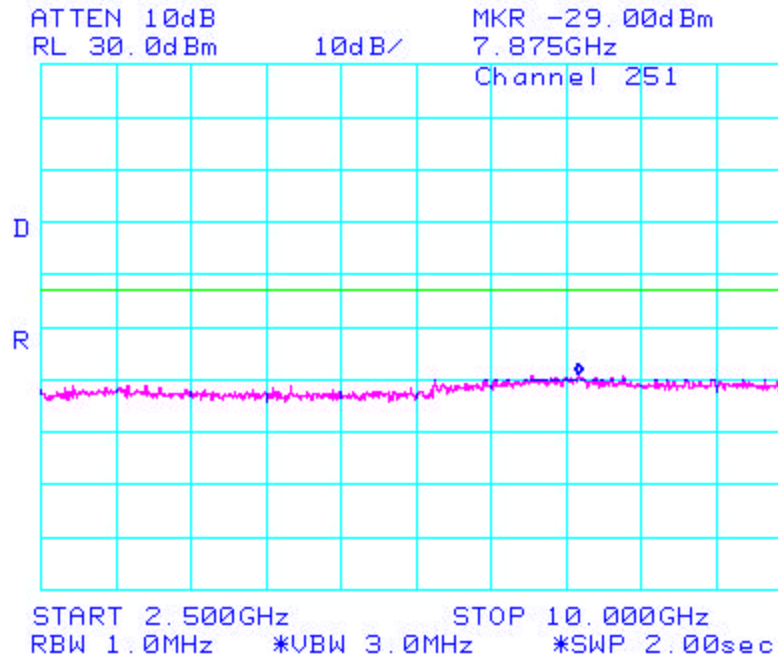
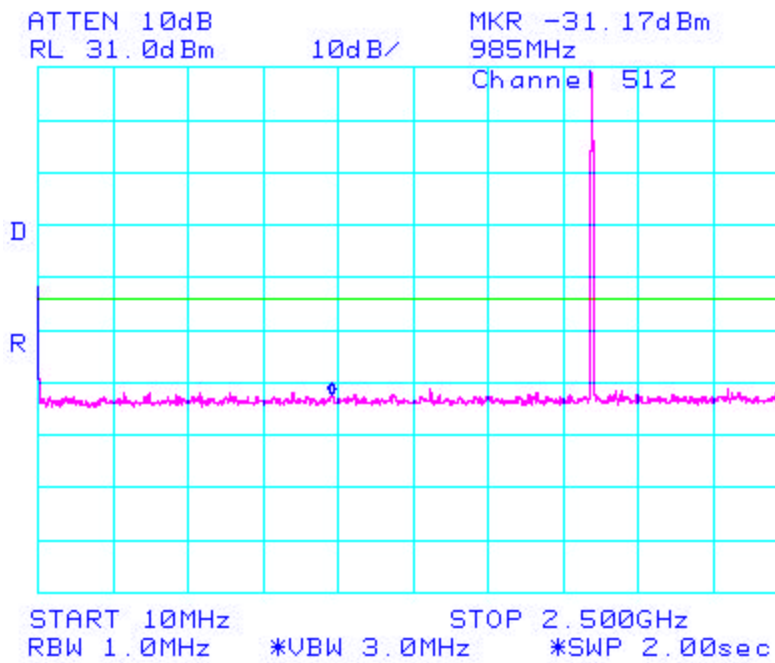
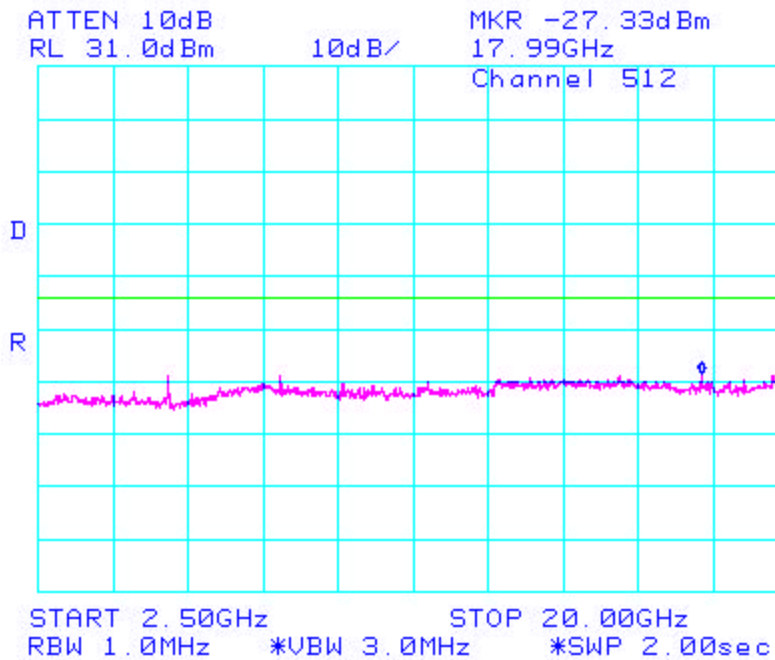
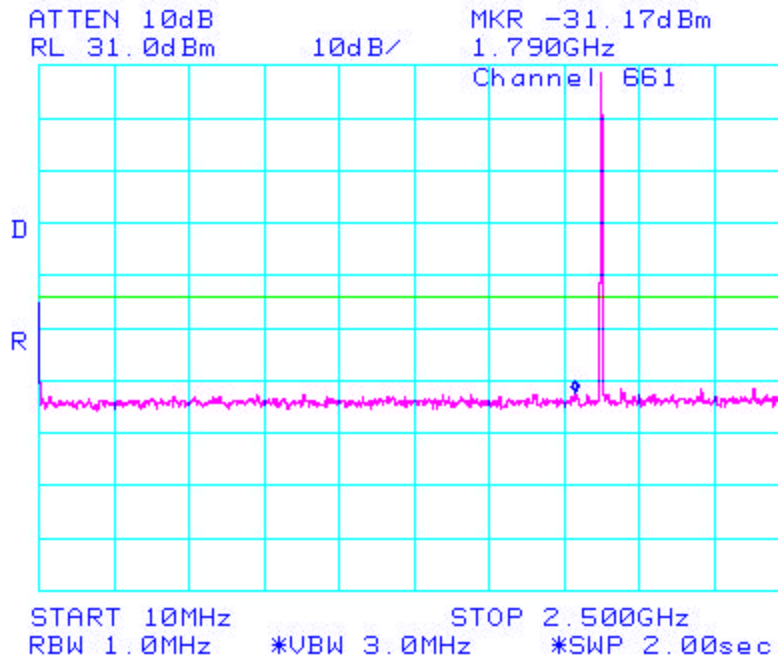
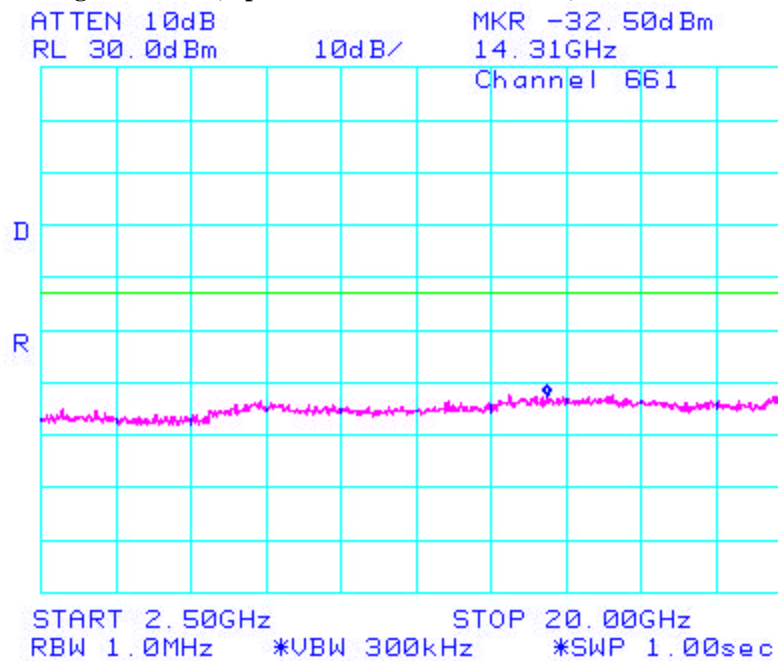

Figure 4: GSM 850, Spurious Conducted Emissions, Middle Channel



Conducted Emission Test Results Con't**Figure 5: GSM 850, Spurious Conducted Emissions, High Channel****Figure 6: GSM 850, Spurious Conducted Emissions, High Channel**

Conducted Emission Test Results Con't**Figure 7: PCS, Spurious Conducted Emissions, Low Channel****Figure 8: PCS, Spurious Conducted Emissions, Low Channel**

Conducted Emission Test Results Con't**Figure 9: PCS, Spurious Conducted Emissions, Middle Channel****Figure 10: PCS, Spurious Conducted Emissions, Middle Channel**

Conducted Emission Test Results Con't

Figure 13: -26dBc bandwidth, GSM 850 Low Channel

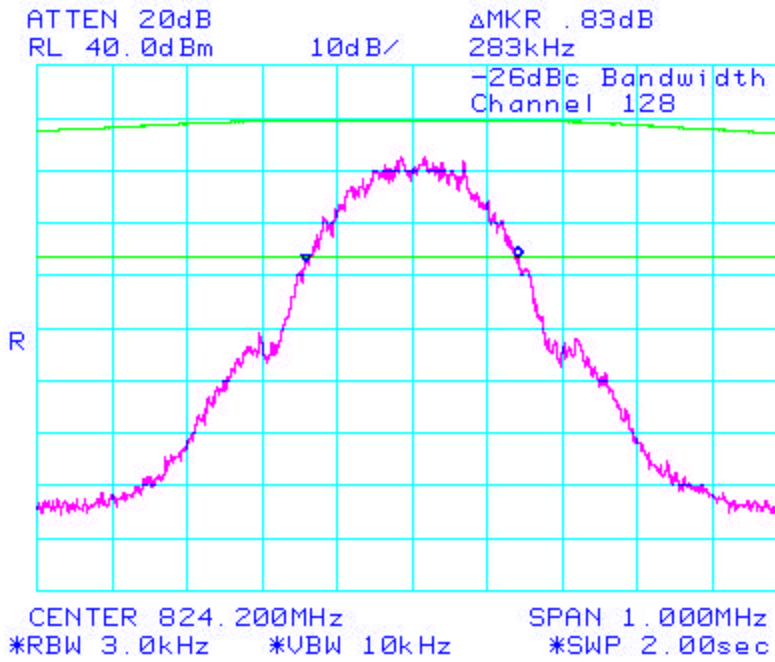
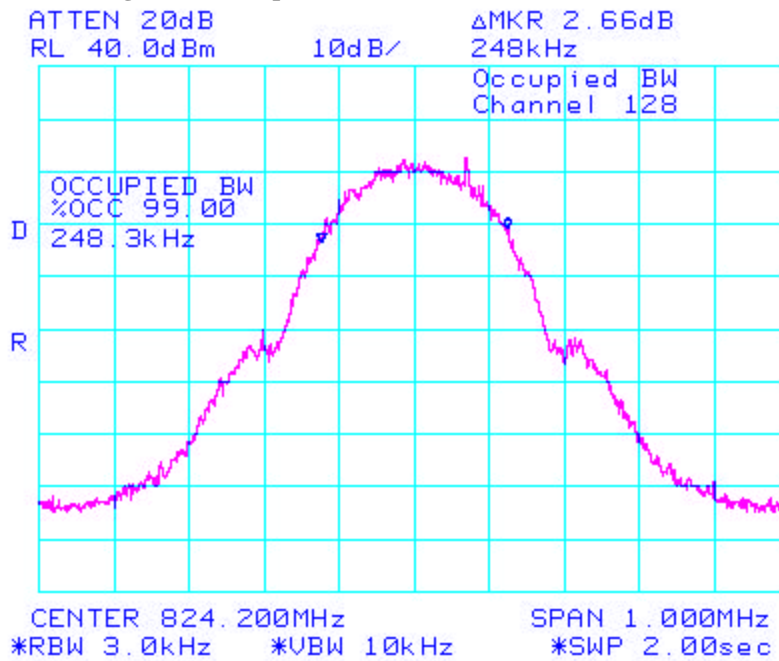

Figure 14: Occupied Bandwidth, GSM 850 Low Channel



Conducted Emission Test Results Con't

Figure 17: -26dBc bandwidth, GSM 850 High Channel

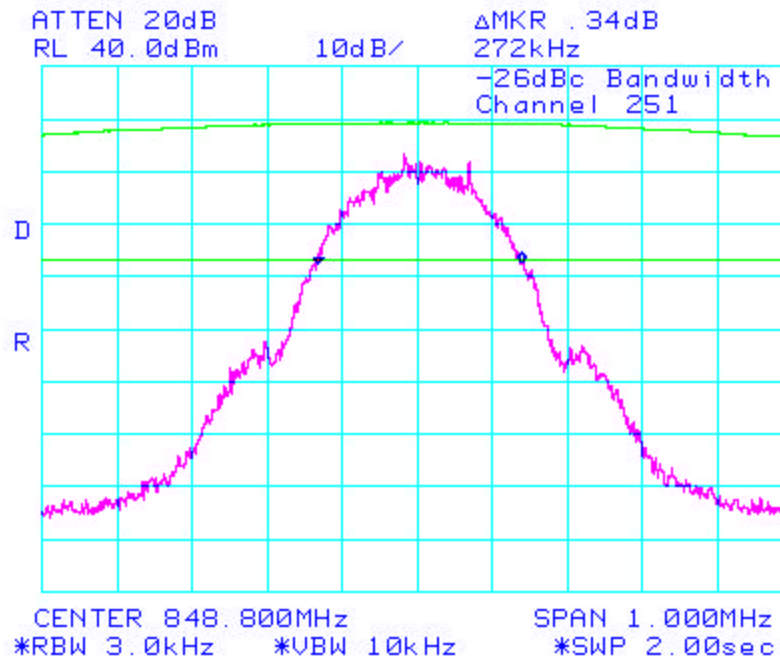
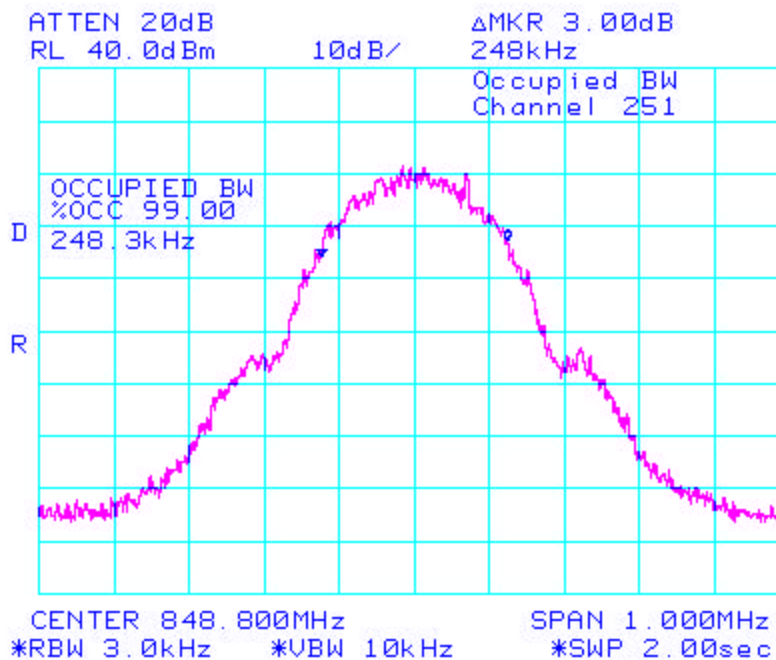

Figure 18: Occupied Bandwidth, GSM 850 High Channel



Conducted Emission Test Results Con't

Figure 21: -26dBc bandwidth, PCS Middle Channel

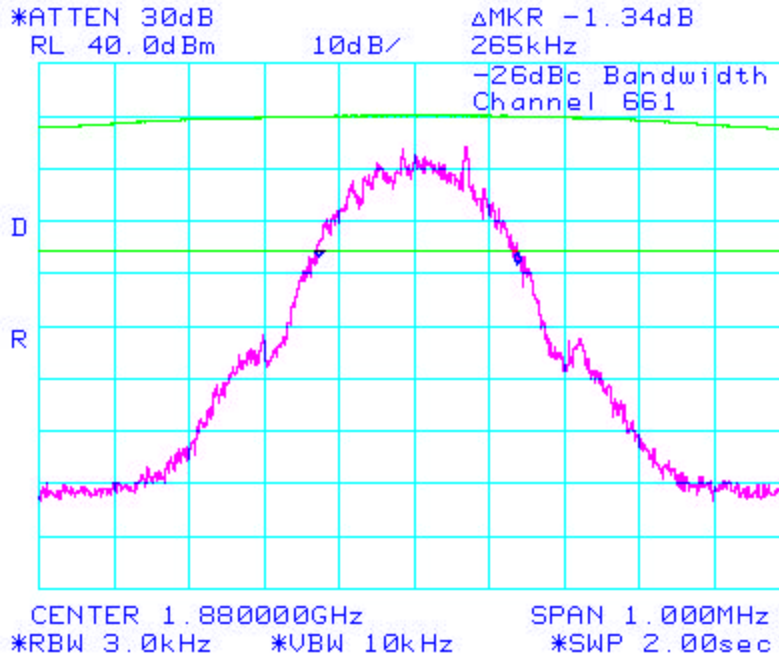
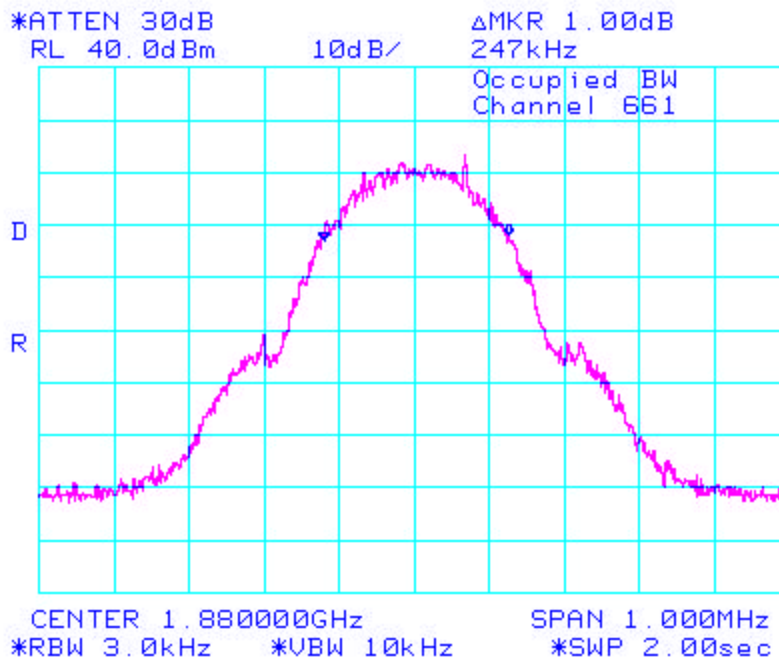
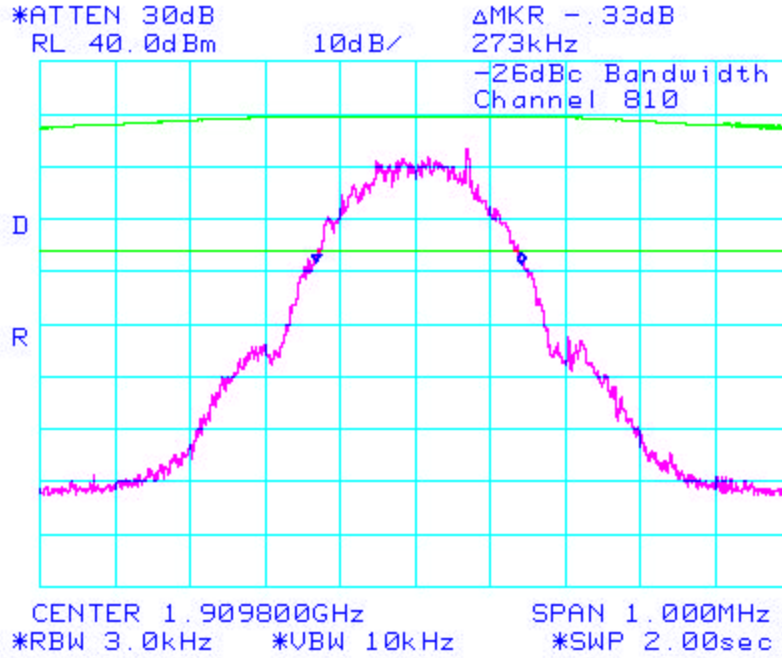
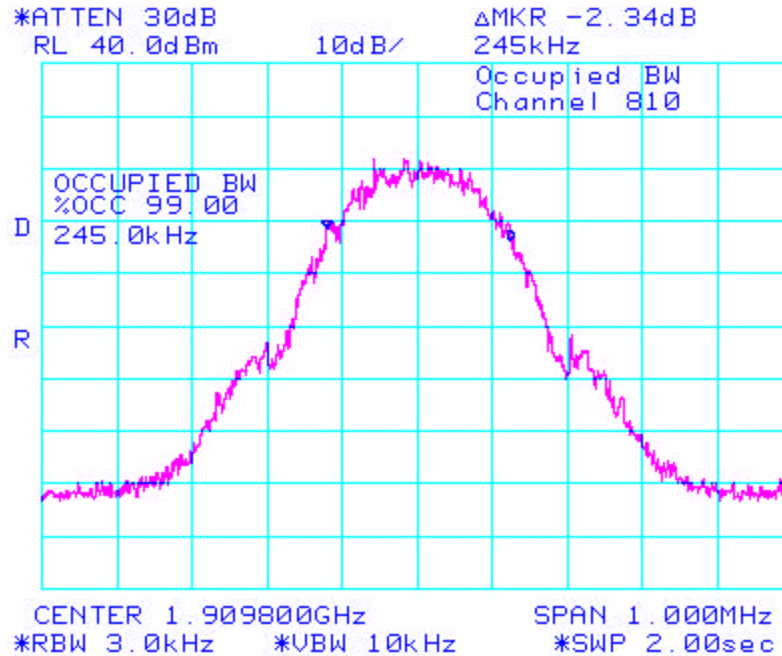

Figure 22: Occupied Bandwidth, PCS Middle Channel



Conducted Emission Test Results Con't**Figure 23: -26dBc bandwidth, PCS High Channel****Figure 24: Occupied Bandwidth, PCS High Channel**

Conducted Emission Test Results Con't

Figure 25: GSM 850, Low Channel Mask

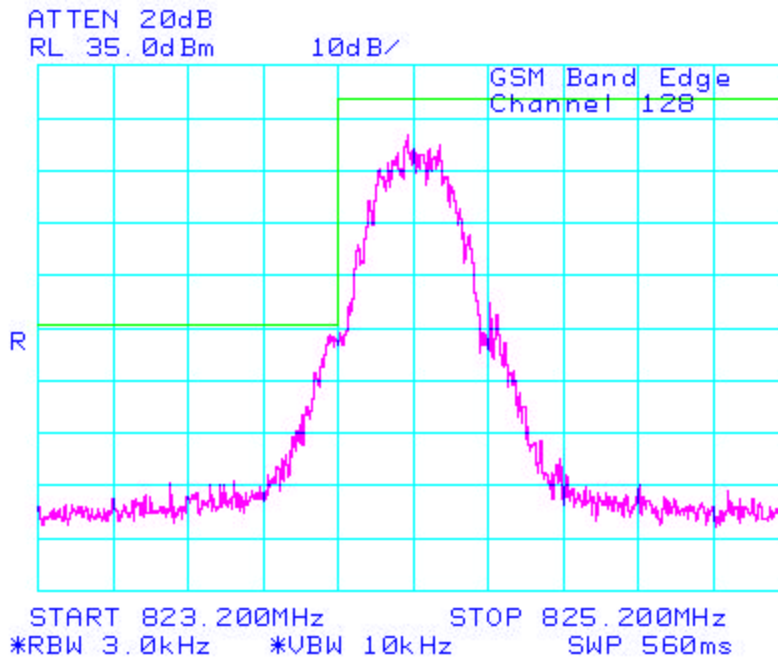
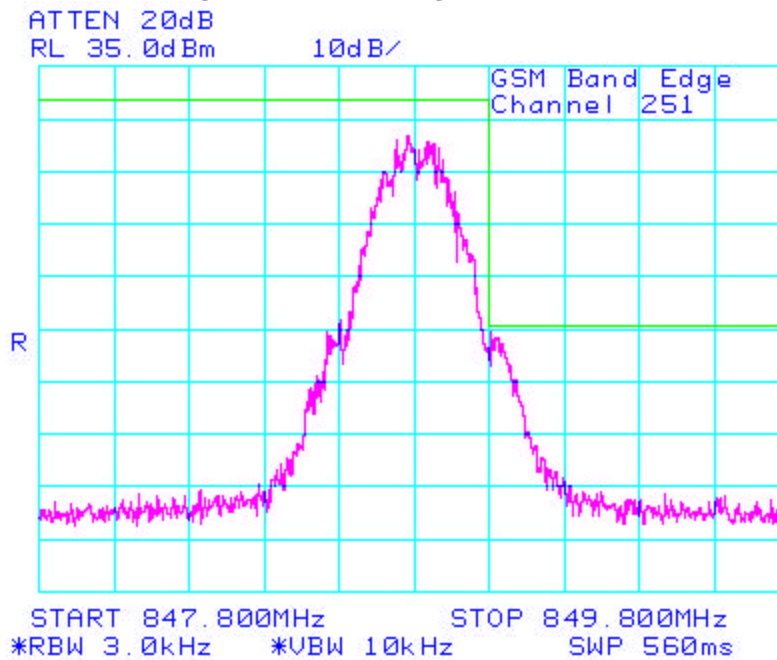
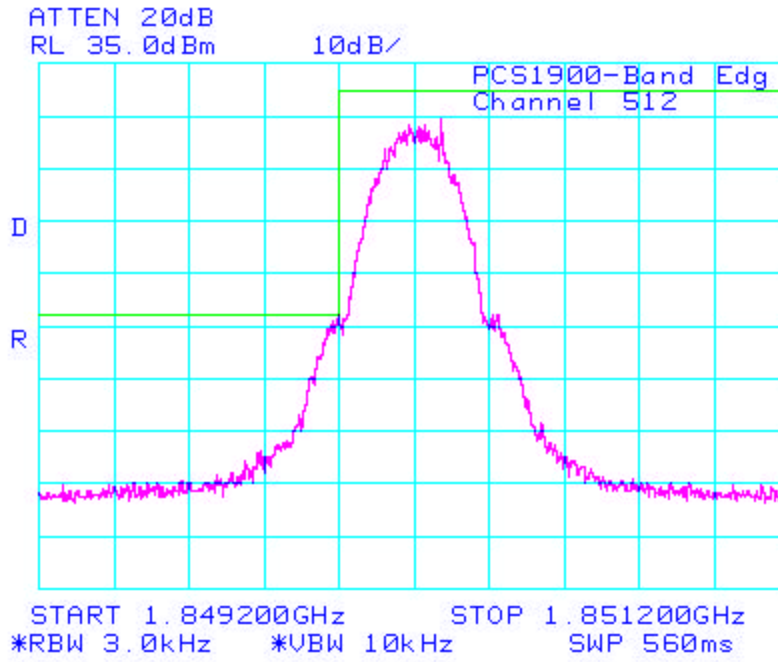
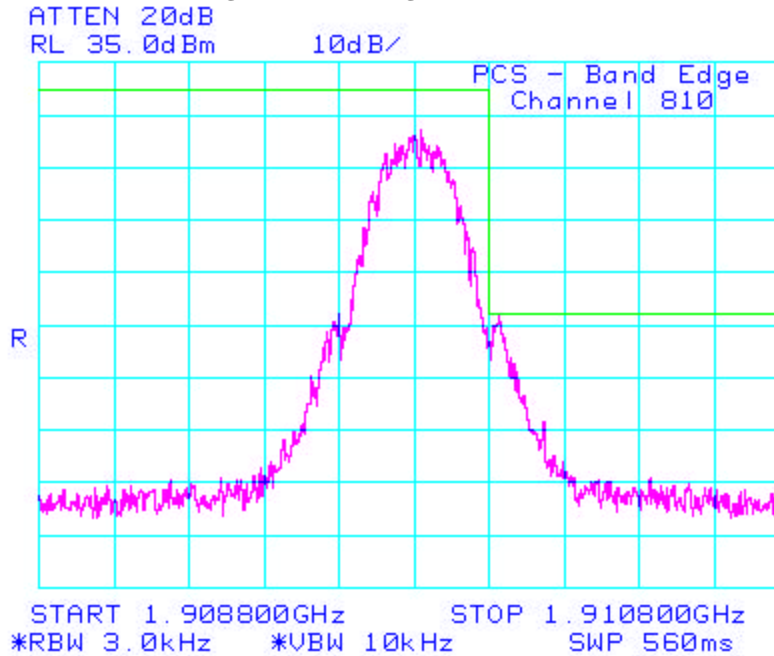

Figure 26: GSM 850 High Channel Mask



Conducted Emission Test Results Con't**Figure27: PCS, Low Channel Mask****Figure28: PCS, High Channel Mask**

Conducted Emission Test-Setup Photo

FCC CFR 47 Part 24, Subpart E, RSS-133



APPENDIX 2

CONDUCTED RF OUTPUT POWER TEST DATA

Conducted RF Output Power Test Data

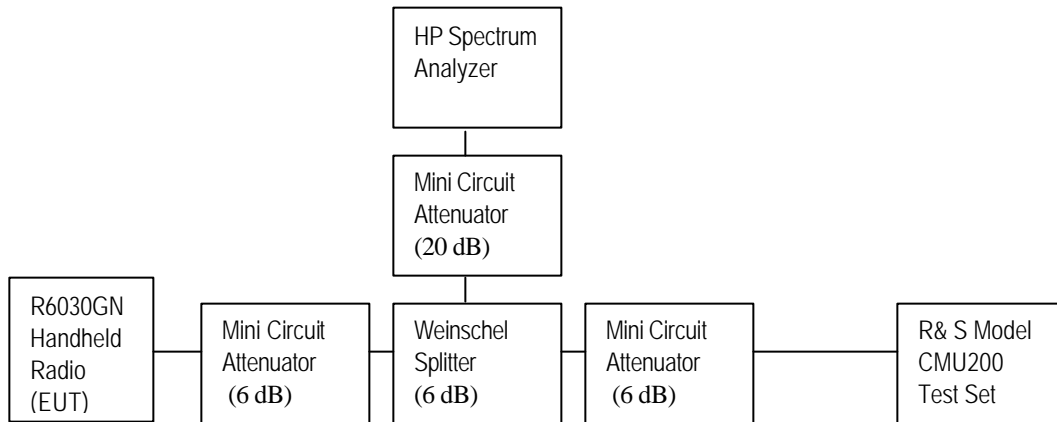

Test Equipment List

Test Instruments	Manufacturer	Model No.	Serial No.	Frequency Range
Spectrum Analyzer	HP	8563E	374A08112	30 Hz – 26.5 GHz
Splitter	Weinschel	1515	ME092	DC – 18 GHz
Attenuator	Mini Circuit	MCL BW-S20W2	--	DC – 18 GHz
Attenuator	Mini Circuit	MCL BW-S6W2	--	DC – 18 GHz
Attenuator	Mini Circuit	MCL BW-S6W2	--	DC – 18 GHz
Universal Radio Communication Tester	Rohde & Schwarz	CMU200	100249	--

Power Output for GSM850 and PCS

At three transmit frequencies the maximum radio output power level was measured using the Spectrum Analyzer. The calibrated insertion loss measured for the attenuator and cable assembly was added to the power measurements which produced the following results.

Test Data

Peak nominal output power is 29 dBm for GSM850 and 30 dBm for PCS.

Channel	GSM850 Frequency (MHz)	Measured Peak Conducted Power (dBm)	Total Correction Factor (dB)	Corrected Peak Conducted Power (dBm)
128	824.2	-3.2	32.4	29.2
195	837.6	-2.9	32.4	29.5
251	848.8	-3.0	32.4	29.4

Channel	PCS Frequency (MHz)	Measured Peak Conducted Power (dBm)	Total Correction Factor (dB)	Corrected Peak Conducted Power (dBm)
512	1850.2	-2.5	32.7	30.2
661	1880.0	-2.5	32.7	30.2
810	1909.8	-2.8	32.7	29.8

Figure 01: GSM 850, Low Channel Peak Power

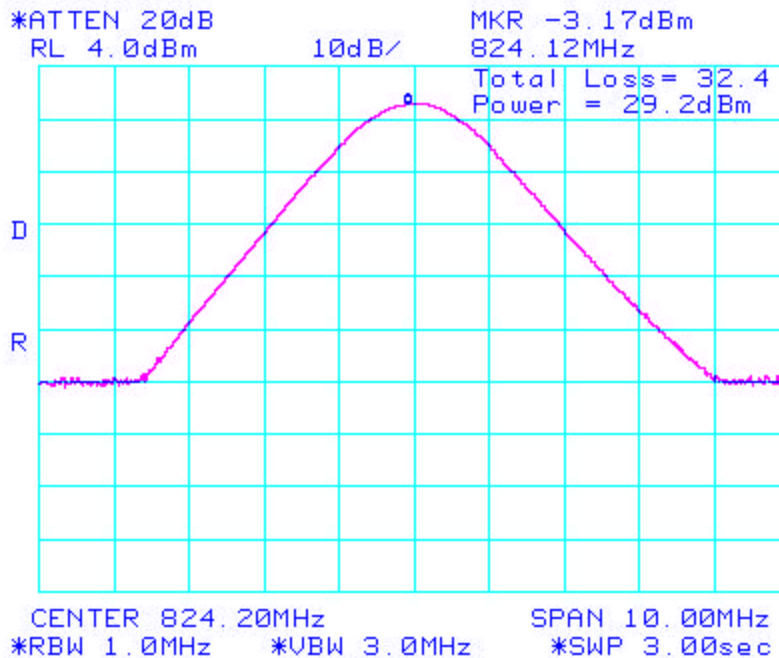

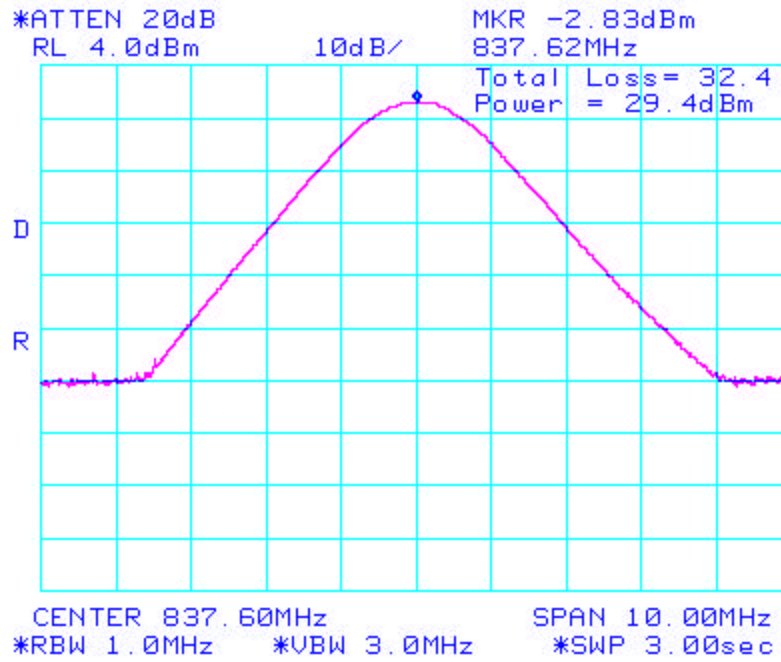
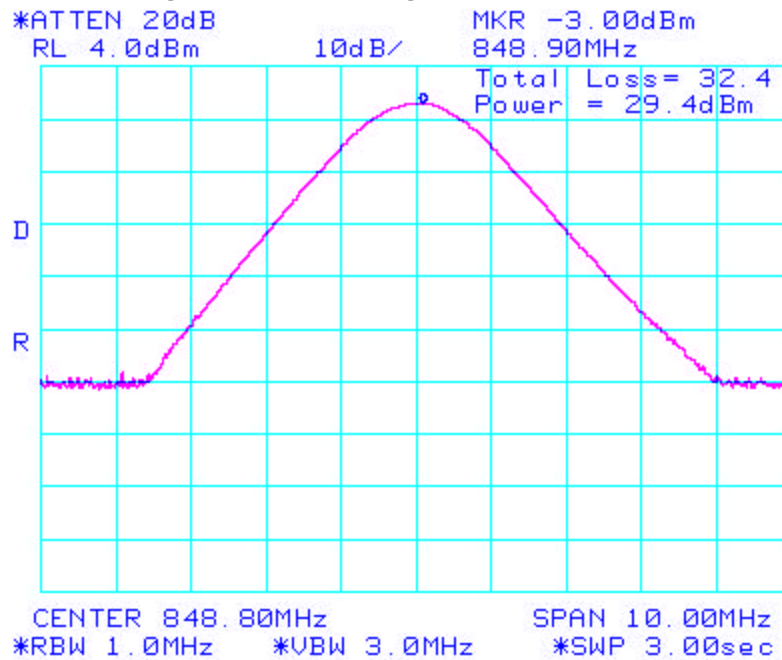
Conducted RF Output Power Test Data con't**Figure 02: GSM 850, Middle Channel Peak Power****Figure 03: GSM 850, High Channel Peak Power**

Conducted RF Output Power Test Data con't

Figure 04: PCS, Low Channel Peak Power

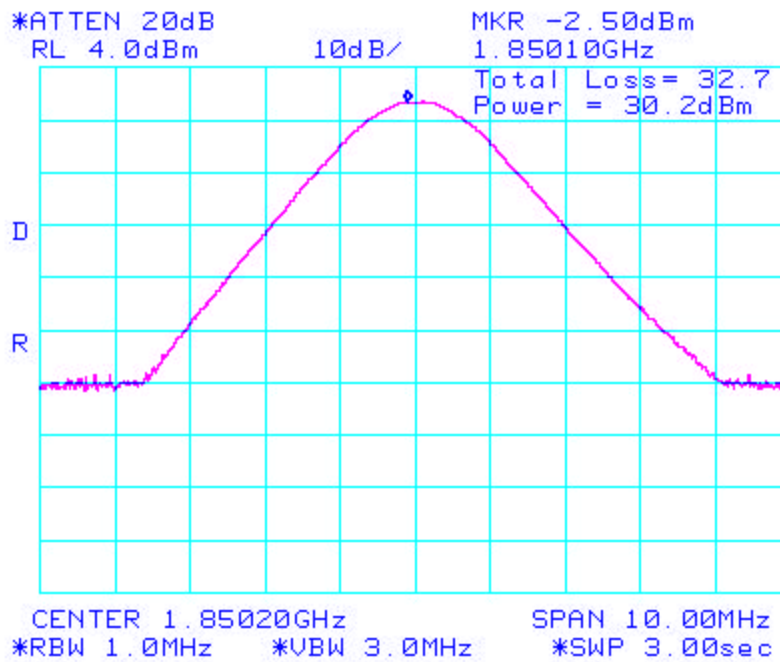
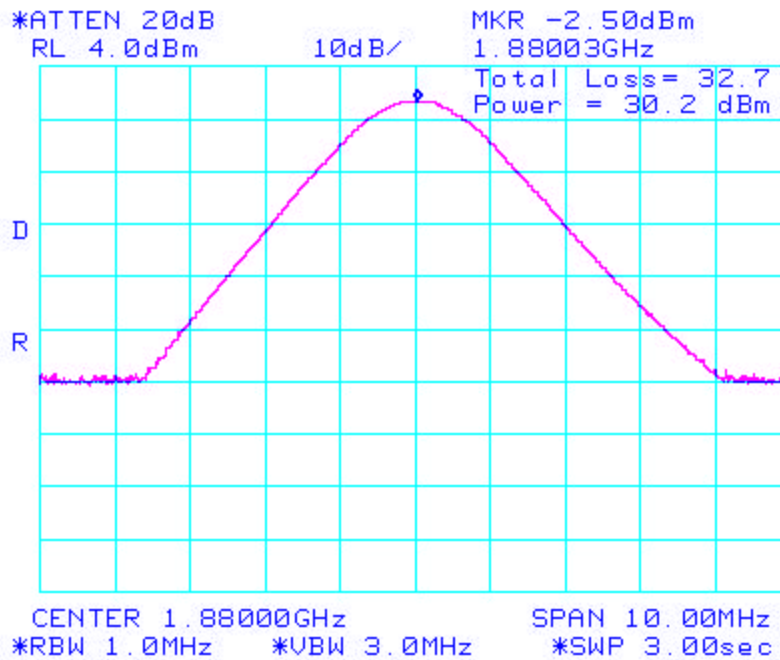

Figure 05: PCS, Middle Channel Peak Power



APPENDIX 3

FREQUENCY STABILITY TEST DATA

Frequency Stability Test Data

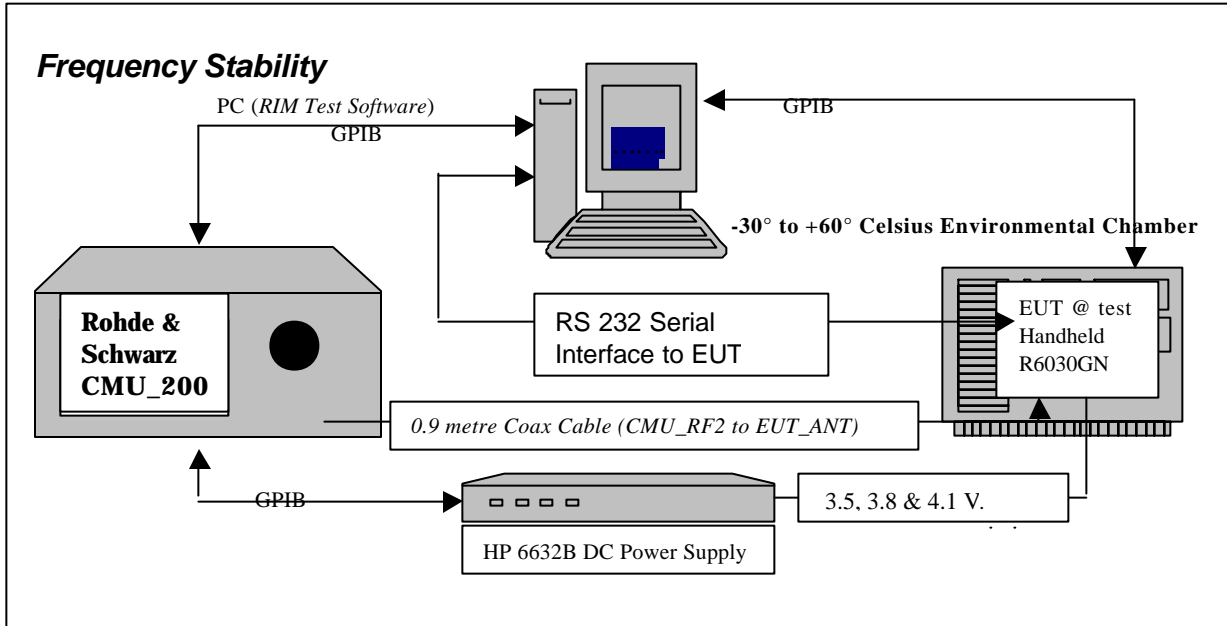

<i>SYSTEM</i>	<i>Model</i>	<i>Serial Number</i>	<i>Calibration Due Date.</i>
R & S Universal Radio Communication Test Set	CMU200	100249	04-April-2004
HP System DC Power Supply	6632B	US37472170	31-July-2003
Network Analyzer	HP 8753D	20A80400806	12-Aug-2003
Calibration Kit	HP85033D	3423A02787	28-Sept-2003
Espec Environmental Chamber	SH240S1	91005607	N/A
Hart Temperature Probe	61161-302	21352860	10-Sept-2003

CFR 47 Chapter 1 - Federal Communications Commission Rules

Part 2 Required Measurements

2.995 Frequency Stability - Procedures

- (a,b) Frequency Stability - Temperature Variation
- (d) Frequency Stability - Voltage Variation

24.235 *Frequency Stability.*

The frequency stability shall be sufficient to ensure that the fundamental emission stays within the authorized frequency block.

The R6030GN handheld, (referred as EUT herein and after) transmitted frequencies are less than 0.1 ppm of the received frequency from the Rhode & Schwarz CMU 200 Universal Radio Communication Test Set. *The EUT meets the requirements as stated in CFR 47 chapter 1, Section 24.235, RSS-133, CFR 47 chapter 1, Section 22.917 and RSS-128 Frequency Stability.*

Frequency Stability measurement devices were configured as presented in the block diagram recording frequency, power, data, temperatures, and stepped voltages controlled via a GPIB interface linked to the Environmental chamber, a DC power supply, and the Communications Test Set. A 1.9-meter coax cable was calibrated to characterize the insertion loss for the transmitted frequencies between the RF input/output of the CMU 200 and the EUT antenna port; located inside the environmental chamber.

Calibration for the Cable Loss was performed in the RF Laboratory on July 14 2003.

Procedure:

Full_ Two port Calibration of 8720D using the 85033D was completed.

The cable assembly from the RF input to the RF output was measured at the following Frequencies:

PCS Frequency (MHz)	Cable loss (dB)	GSM 850 Frequency (MHz)	Cable loss (dB)
1850.2	2.67	824.2	1.80
1880.0	2.67	836.4	1.80
1909.8	2.67	848.6	1.80

Procedure:

The EUT was placed in the Temperature chamber and connected to CMU 200 outside as shown in the figure above. Dry air was pumped inside the temperature chamber to maintain a backpressure during the test. The EUT was kept in the off condition at all times except when the measurements were to be made.

The chamber was switched on and the temperature was set to -30°C.

After the chamber stabilized at -30 °C there was a soak period of one hour to alleviate moisture in the chamber, the EUT voltage was enabled.

The system software recorded the frequency, power, and associated measurements.

A Computer system controlled the automated software. This application was given the command of activating all machines intrinsic to the temperature and voltage tests controlling the CMU 200 via the GPIB Bus. The Environmental Chamber was instructed through an RS-232 serial line. The EUT dialogue was passed through a serial connection.

The EUT repetitively transmitted 100 bursts for each set of programmed parameters recording temperature, voltage settings, and systematically selected frequencies. The power supply was cycled from minimum voltage 3.5 volts, to 3.8 volts to 4.1 volts nominal voltage.

The frequency error was measured at a maximum output power and recorded by the automated system test software.

The EUT output power and frequency was measured at 3.5 volts, 3.8 volts and 4.1 volts. The transmit frequency was varied in 3 steps consisting of 824.2, 836.4, and 848.6 MHz for the GSM850 band and 1850.2, 1880.0 and 1909.8 MHz for the PCS band. This frequency was recorded in MHz and deviation from nominal, in Parts Per Million.

After the initial one-hour soak at the beginning of the start of the measurement tests, a period of thirty minutes soak was initialized between each ascending temperature step, before proceeding to the next measurement test cycle.

PROCEDURE:

The test system software for commencing the Frequency Stability Tests carried through the following cycle.

1. Switch on the HP 6632B power supply; CMU 200 Communications test Set, and Environmental Chamber.
2. Start test program
3. Set the Temperature to -30 degrees Celsius and maintain a period of one- hour soak time, with the EUT supply voltage disabled.
4. Set power supply voltage to 3.5 Volts.
5. Set up CMU 200 Radio Communication Tester.
6. Command the CMU 200 to switch to the low channel.
7. Enable the voltage to the EUT, and connect a link to the CMU 200 test set.
8. EUT is commanded to Transmit 100 Bursts.
9. Software logs the following data from the CMU 200, power supply and temperature chamber: Traffic Channel Number, Traffic Channel Frequency, Power Level, Chamber Temperature, Supply Voltage, Power, Frequency Error.
10. The CMU 200 commands the EUT to change frequency to the middle channel and high channel and repeats steps 7 to 9.
11. Repeat steps 5 to 10 changing the supply voltage to 3.8 Volts
12. Increase temperature by 10°C and soak for 1/2 hour.
13. Repeat steps 4 - 12 for temperatures -30 degrees to 60 degrees Celsius.
14. Repeat steps 5 to 10 changing the supply voltage to 4.1 Volts

Procedure 5 to 10 was repeated at room temperature (20°C) with the power supply voltage set to 3.5, 3.8 and 4.1 Volts.

GSM 850 Channel results: channels 128, 189 and 250 @ 20°C maximum transmitted power

Traffic Channel Number	GSM 850 Frequency (MHz)	PCL (dBm)	Voltage (Volts)	Temperature (Celsius)	Frequency Error (Hz)	PPM
128	824.2	29	3.5	20	-31.90	-0.0387
189	836.4	29	3.5	20	-27.25	-0.0326
250	848.6	29	3.5	20	-26.80	-0.0316

Traffic Channel Number	GSM 850 Frequency (MHz)	PCL (dBm)	Voltage (Volts)	Temperature (Celsius)	Frequency Error (Hz)	PPM
128	824.2	29	3.8	20	-32.8	-0.0398
189	836.4	29	3.8	20	-20.6	-0.0246
250	848.6	29	3.8	20	-15.69	-0.0185

Traffic Channel Number	GSM 850 Frequency (MHz)	PCL (dBm)	Voltage (Volts)	Temperature (Celsius)	Frequency Error (Hz)	PPM
128	824.2	29	4.1	20	-26.47	-0.0321
189	836.4	29	4.1	20	-18.66	-0.0223
250	848.6	29	4.1	20	-25.76	-0.0304

PCS Channel results: channels 512, 661, & 810 @ 20°C maximum transmitted power

Traffic Channel Number	PCS Frequency (MHz)	PCL (dBm)	Voltage (Volts)	Temperature (Celsius)	Frequency Error (Hz)	PPM
512	1850.2	30	3.5	20	32.74	0.0177
661	1880.0	30	3.5	20	27.83	0.0148
810	1909.8	30	3.5	20	39.26	0.0206

Traffic Channel Number	PCS Frequency (MHz)	PCL (dBm)	Voltage (Volts)	Temperature (Celsius)	Frequency Error (Hz)	PPM
512	1850.2	30	3.8	20	30.09	0.0163
661	1880.0	30	3.8	20	33.90	0.0180
810	1909.8	30	3.8	20	38.81	0.0203

Traffic Channel Number	PCS Frequency (MHz)	PCL (dBm)	Voltage (Volts)	Temperature (Celsius)	Frequency Error (Hz)	PPM
512	1850.2	30	4.1	20	30.03	0.0162
661	1880.0	30	4.1	20	30.61	0.0163
810	1909.8	30	4.1	20	46.10	0.0241

GSM850 Results: channel 128 @ maximum transmitted power

<i>Traffic Channel Number</i>	<i>Frequency (MHz)</i>	<i>PCL (dBm)</i>	<i>Voltage (Volts)</i>	<i>Temperature (Celsius)</i>	<i>Frequency Error (Hz)</i>	<i>PPM</i>
128	824.2	29	3.5	-30	-59.34	-0.0720
128	824.2	29	3.5	-20	-28.15	-0.0342
128	824.2	29	3.5	-10	-55.47	-0.0673
128	824.2	29	3.5	0	-32.93	-0.0400
128	824.2	29	3.5	10	-62.25	-0.0755
128	824.2	29	3.5	20	-31.90	-0.0387
128	824.2	29	3.5	30	-34.55	-0.0419
128	824.2	29	3.5	40	-45.98	-0.0558
128	824.2	29	3.5	50	-24.54	-0.0298
128	824.2	29	3.5	60	-19.44	-0.0236

<i>Traffic Channel Number</i>	<i>Frequency (MHz)</i>	<i>PCL (dBm)</i>	<i>Voltage (Volts)</i>	<i>Temperature (Celsius)</i>	<i>Frequency Error (Hz)</i>	<i>PPM</i>
128	824.2	29	3.8	-30	-52.17	-0.0633
128	824.2	29	3.8	-20	-29.32	-0.0356
128	824.2	29	3.8	-10	-46.81	-0.0568
128	824.2	29	3.8	0	-35.26	-0.0428
128	824.2	29	3.8	10	-68.19	-0.0827
128	824.2	29	3.8	20	-32.80	-0.0398
128	824.2	29	3.8	30	-28.99	-0.0352
128	824.2	29	3.8	40	-35.26	-0.0428
128	824.2	29	3.8	50	-18.66	-0.0226
128	824.2	29	3.8	60	-23.05	-0.0280

<i>Traffic Channel Number</i>	<i>Frequency (MHz)</i>	<i>PCL (dBm)</i>	<i>Voltage (Volts)</i>	<i>Temperature (Celsius)</i>	<i>Frequency Error (Hz)</i>	<i>PPM</i>
128	824.2	29	4.1	-30	-35.51	-0.0431
128	824.2	29	4.1	-20	-33.06	-0.0401
128	824.2	29	4.1	-10	-51.98	-0.0631
128	824.2	29	4.1	0	-28.35	-0.0344
128	824.2	29	4.1	10	-36.29	-0.0440
128	824.2	29	4.1	20	-26.47	-0.0321
128	824.2	29	4.1	30	-33.00	-0.0400
128	824.2	29	4.1	40	-39.91	-0.0484
128	824.2	29	4.1	50	-22.86	-0.0277
128	824.2	29	4.1	60	-14.27	-0.0173

GSM850 Results: channel 189 @ maximum transmitted power

<i>Traffic Channel Number</i>	<i>Frequency (MHz)</i>	<i>PCL (dBm)</i>	<i>Voltage (Volts)</i>	<i>Temperature (Celsius)</i>	<i>Frequency Error (Hz)</i>	<i>PPM</i>
189	836.4	29	3.5	-30	-48.36	-0.0578
189	836.4	29	3.5	-20	-18.73	-0.0224
189	836.4	29	3.5	-10	-26.22	-0.0313
189	836.4	29	3.5	0	-21.63	-0.0259
189	836.4	29	3.5	10	-53.59	-0.0641
189	836.4	29	3.5	20	-27.25	-0.0326
189	836.4	29	3.5	30	-16.98	-0.0203
189	836.4	29	3.5	40	-48.95	-0.0585
189	836.4	29	3.5	50	16.59	0.0198
189	836.4	29	3.5	60	-15.56	-0.0186

<i>Traffic Channel Number</i>	<i>Frequency (MHz)</i>	<i>PCL (dBm)</i>	<i>Voltage (Volts)</i>	<i>Temperature (Celsius)</i>	<i>Frequency Error (Hz)</i>	<i>PPM</i>
189	836.4	29	3.8	-30	-49.46	-0.0591
189	836.4	29	3.8	-20	-22.54	-0.0269
189	836.4	29	3.8	-10	-39.91	-0.0477
189	836.4	29	3.8	0	-13.43	-0.0161
189	836.4	29	3.8	10	-34.74	-0.0415
189	836.4	29	3.8	20	-20.60	-0.0246
189	836.4	29	3.8	30	-17.24	-0.0206
189	836.4	29	3.8	40	-48.95	-0.0585
189	836.4	29	3.8	50	-18.21	-0.0218
189	836.4	29	3.8	60	-16.08	-0.0192

<i>Traffic Channel Number</i>	<i>Frequency (MHz)</i>	<i>PCL (dBm)</i>	<i>Voltage (Volts)</i>	<i>Temperature (Celsius)</i>	<i>Frequency Error (Hz)</i>	<i>PPM</i>
189	836.4	29	4.1	-30	-53.72	-0.0642
189	836.4	29	4.1	-20	-24.60	-0.0294
189	836.4	29	4.1	-10	-35.90	-0.0429
189	836.4	29	4.1	0	12.53	0.0150
189	836.4	29	4.1	10	-24.21	-0.0289
189	836.4	29	4.1	20	-18.66	-0.0223
189	836.4	29	4.1	30	-24.09	-0.0288
189	836.4	29	4.1	40	-43.33	-0.0518
189	836.4	29	4.1	50	-20.40	-0.0244
189	836.4	29	4.1	60	-18.79	-0.0225

GSM850 Results: channel 250 @ maximum transmitted power

<i>Traffic Channel Number</i>	<i>Frequency (MHz)</i>	<i>PCL (dBm)</i>	<i>Voltage (Volts)</i>	<i>Temperature (Celsius)</i>	<i>Frequency Error (Hz)</i>	<i>PPM</i>
250	848.6	29	3.5	-30	-28.02	-0.0330
250	848.6	29	3.5	-20	-32.16	-0.0379
250	848.6	29	3.5	-10	-17.69	-0.0208
250	848.6	29	3.5	0	-26.99	-0.0318
250	848.6	29	3.5	10	-49.72	-0.0586
250	848.6	29	3.5	20	-26.80	-0.0316
250	848.6	29	3.5	30	-13.69	-0.0161
250	848.6	29	3.5	40	-39.84	-0.0469
250	848.6	29	3.5	50	13.56	0.0160
250	848.6	29	3.5	60	-15.37	-0.0181

<i>Traffic Channel Number</i>	<i>Frequency (MHz)</i>	<i>PCL (dBm)</i>	<i>Voltage (Volts)</i>	<i>Temperature (Celsius)</i>	<i>Frequency Error (Hz)</i>	<i>PPM</i>
250	848.6	29	3.8	-30	-28.73	-0.0339
250	848.6	29	3.8	-20	-44.49	-0.0524
250	848.6	29	3.8	-10	-15.82	-0.0186
250	848.6	29	3.8	0	-32.03	-0.0377
250	848.6	29	3.8	10	-36.61	-0.0431
250	848.6	29	3.8	20	-15.69	-0.0185
250	848.6	29	3.8	30	-16.08	-0.0189
250	848.6	29	3.8	40	-40.16	-0.0473
250	848.6	29	3.8	50	-15.82	-0.0186
250	848.6	29	3.8	60	12.66	0.0149

<i>Traffic Channel Number</i>	<i>Frequency (MHz)</i>	<i>PCL (dBm)</i>	<i>Voltage (Volts)</i>	<i>Temperature (Celsius)</i>	<i>Frequency Error (Hz)</i>	<i>PPM</i>
250	848.6	29	4.1	-30	-23.44	-0.0276
250	848.6	29	4.1	-20	-46.75	-0.0551
250	848.6	29	4.1	-10	-12.79	-0.0151
250	848.6	29	4.1	0	-20.47	-0.0241
250	848.6	29	4.1	10	-25.57	-0.0301
250	848.6	29	4.1	20	-25.76	-0.0304
250	848.6	29	4.1	30	-16.53	-0.0195
250	848.6	29	4.1	40	-33.71	-0.0397
250	848.6	29	4.1	50	-17.18	-0.0202
250	848.6	29	4.1	60	-16.72	-0.0197

PCS 1900 Results: channel 512 @ maximum transmitted power

<i>Traffic Channel Number</i>	<i>Frequency (MHz)</i>	<i>PCL (dBm)</i>	<i>Voltage (Volts)</i>	<i>Temperature (Celsius)</i>	<i>Frequency Error (Hz)</i>	<i>PPM</i>
512	1850.2	30	3.5	-30	27.51	0.0149
512	1850.2	30	3.5	-20	39.13	0.0211
512	1850.2	30	3.5	-10	64.77	0.0350
512	1850.2	30	3.5	0	30.41	0.0164
512	1850.2	30	3.5	10	24.86	0.0134
512	1850.2	30	3.5	20	32.74	0.0177
512	1850.2	30	3.5	30	18.21	0.0098
512	1850.2	30	3.5	40	-74.90	-0.0405
512	1850.2	30	3.5	50	31.77	0.0172
512	1850.2	30	3.5	60	20.15	0.0109

<i>Traffic Channel Number</i>	<i>Frequency (MHz)</i>	<i>PCL (dBm)</i>	<i>Voltage (Volts)</i>	<i>Temperature (Celsius)</i>	<i>Frequency Error (Hz)</i>	<i>PPM</i>
512	1850.2	30	3.8	-30	23.31	0.0126
512	1850.2	30	3.8	-20	32.80	0.0177
512	1850.2	30	3.8	-10	85.17	0.0460
512	1850.2	30	3.8	0	16.79	0.0091
512	1850.2	30	3.8	10	26.93	0.0146
512	1850.2	30	3.8	20	30.09	0.0163
512	1850.2	30	3.8	30	28.41	0.0154
512	1850.2	30	3.8	40	-59.73	-0.0323
512	1850.2	30	3.8	50	34.80	0.0188
512	1850.2	30	3.8	60	28.35	0.0153

<i>Traffic Channel Number</i>	<i>Frequency (MHz)</i>	<i>PCL (dBm)</i>	<i>Voltage (Volts)</i>	<i>Temperature (Celsius)</i>	<i>Frequency Error (Hz)</i>	<i>PPM</i>
512	1850.2	30	4.1	-30	29.96	0.0162
512	1850.2	30	4.1	-20	38.16	0.0206
512	1850.2	30	4.1	-10	60.44	0.0327
512	1850.2	30	4.1	0	25.05	0.0135
512	1850.2	30	4.1	10	35.84	0.0194
512	1850.2	30	4.1	20	30.03	0.0162
512	1850.2	30	4.1	30	29.77	0.0161
512	1850.2	30	4.1	40	-65.22	-0.0353
512	1850.2	30	4.1	50	30.99	0.0167
512	1850.2	30	4.1	60	22.92	0.0124

PCS 1900 Results: channel 661 @ maximum transmitted power

<i>Traffic Channel Number</i>	<i>Frequency (MHz)</i>	<i>PCL (dBm)</i>	<i>Voltage (Volts)</i>	<i>Temperature (Celsius)</i>	<i>Frequency Error (Hz)</i>	<i>PPM</i>
661	1880.0	30	3.5	-30	38.74	0.0206
661	1880.0	30	3.5	-20	45.39	0.0241
661	1880.0	30	3.5	-10	66.32	0.0353
661	1880.0	30	3.5	0	29.44	0.0157
661	1880.0	30	3.5	10	41.07	0.0218
661	1880.0	30	3.5	20	27.83	0.0148
661	1880.0	30	3.5	30	26.22	0.0139
661	1880.0	30	3.5	40	-80.07	-0.0426
661	1880.0	30	3.5	50	35.13	0.0187
661	1880.0	30	3.5	60	20.53	0.0109

<i>Traffic Channel Number</i>	<i>Frequency (MHz)</i>	<i>PCL (dBm)</i>	<i>Voltage (Volts)</i>	<i>Temperature (Celsius)</i>	<i>Frequency Error (Hz)</i>	<i>PPM</i>
661	1880.0	30	3.8	-30	44.68	0.0238
661	1880.0	30	3.8	-20	34.29	0.0182
661	1880.0	30	3.8	-10	89.50	0.0476
661	1880.0	30	3.8	0	47.01	0.0250
661	1880.0	30	3.8	10	40.10	0.0213
661	1880.0	30	3.8	20	33.90	0.0180
661	1880.0	30	3.8	30	41.00	0.0218
661	1880.0	30	3.8	40	-41.71	-0.0222
661	1880.0	30	3.8	50	36.10	0.0192
661	1880.0	30	3.8	60	25.96	0.0138

<i>Traffic Channel Number</i>	<i>Frequency (MHz)</i>	<i>PCL (dBm)</i>	<i>Voltage (Volts)</i>	<i>Temperature (Celsius)</i>	<i>Frequency Error (Hz)</i>	<i>PPM</i>
661	1880.0	30	4.1	-30	40.03	0.0213
661	1880.0	30	4.1	-20	42.29	0.0225
661	1880.0	30	4.1	-10	74.26	0.0395
661	1880.0	30	4.1	0	35.51	0.0189
661	1880.0	30	4.1	10	49.59	0.0264
661	1880.0	30	4.1	20	30.61	0.0163
661	1880.0	30	4.1	30	32.48	0.0173
661	1880.0	30	4.1	40	-51.40	-0.0273
661	1880.0	30	4.1	50	36.29	0.0193
661	1880.0	30	4.1	60	19.05	0.0101

PCS 1900 Results: channel 810 @ maximum transmitted power

<i>Traffic Channel Number</i>	<i>Frequency (MHz)</i>	<i>PCL (dBm)</i>	<i>Voltage (Volts)</i>	<i>Temperature (Celsius)</i>	<i>Frequency Error (Hz)</i>	<i>PPM</i>
810	1909.8	30	3.5	-30	26.86	0.0141
810	1909.8	30	3.5	-20	48.43	0.0254
810	1909.8	30	3.5	-10	52.24	0.0274
810	1909.8	30	3.5	0	31.19	0.0163
810	1909.8	30	3.5	10	37.90	0.0198
810	1909.8	30	3.5	20	39.26	0.0206
810	1909.8	30	3.5	30	28.80	0.0151
810	1909.8	30	3.5	40	-53.66	-0.0281
810	1909.8	30	3.5	50	34.68	0.0182
810	1909.8	30	3.5	60	22.86	0.0120

<i>Traffic Channel Number</i>	<i>Frequency (MHz)</i>	<i>PCL (dBm)</i>	<i>Voltage (Volts)</i>	<i>Temperature (Celsius)</i>	<i>Frequency Error (Hz)</i>	<i>PPM</i>
810	1909.8	30	3.8	-30	40.49	0.0212
810	1909.8	30	3.8	-20	47.98	0.0251
810	1909.8	30	3.8	-10	93.82	0.0491
810	1909.8	30	3.8	0	39.52	0.0207
810	1909.8	30	3.8	10	41.46	0.0217
810	1909.8	30	3.8	20	38.81	0.0203
810	1909.8	30	3.8	30	37.71	0.0197
810	1909.8	30	3.8	40	-66.90	-0.0350
810	1909.8	30	3.8	50	41.84	0.0219
810	1909.8	30	3.8	60	26.41	0.0138

<i>Traffic Channel Number</i>	<i>Frequency (MHz)</i>	<i>PCL (dBm)</i>	<i>Voltage (Volts)</i>	<i>Temperature (Celsius)</i>	<i>Frequency Error (Hz)</i>	<i>PPM</i>
810	1909.8	30	4.1	-30	47.59	0.0249
810	1909.8	30	4.1	-20	43.20	0.0226
810	1909.8	30	4.1	-10	89.82	0.0470
810	1909.8	30	4.1	0	54.95	0.0288
810	1909.8	30	4.1	10	52.04	0.0272
810	1909.8	30	4.1	20	46.10	0.0241
810	1909.8	30	4.1	30	31.96	0.0167
810	1909.8	30	4.1	40	-60.44	-0.0316
810	1909.8	30	4.1	50	27.25	0.0143
810	1909.8	30	4.1	60	21.44	0.0112

APPENDIX 4

RADIATED EMISSIONS TEST DATA

Radiated Emissions Test Data Results

Test distance is 3.0 metres

EUT				Rx Antenna		Spectrum Analyzer			Substitution Method				
Type	Ch	Frequency (MHz)	Band	Type	Pol.	Reading (dBuV)	Corrected Reading (dBuV)	Max (V,H)	Tracking Generator				
									Reading (dBm)	Corrected Reading (relative to dipole)	Pol.	Limit	Diff to Limit (dB)
GSM850 Band (ERP)													
Handheld Standalone, upright position													
F0	128	824.20	850	Dipole	V	82.4	82.4	82.4	7.6	23.55	VV	27.78	-4.23
F0	128	824.20	850	Dipole	H	76.5	76.5		6.2		HH		
F0	195	837.60	850	Dipole	V	81.8	81.8	81.8	7.1	23.05	VV	27.78	-7.73
F0	195	837.60	850	Dipole	H	75.7	75.7		5.9		HH		
F0	251	848.80	850	Dipole	V	81.3	81.3	81.3	6.7	22.65	VV	27.78	-5.13
F0	251	848.80	850	Dipole	H	75.8	75.8		5.1		HH		
Handheld standalone, on its side													
F0	128	824.20	850	Dipole	V	76.9	76.9	82.6	7.8	23.75	VV	27.78	-4.03
F0	128	824.20	850	Dipole	H	82.6	82.6		6.4		HH		
F0	195	837.60	850	Dipole	V	75.0	75.0	82.4	7.7	23.65	VV	27.78	-4.13
F0	195	837.60	850	Dipole	H	82.4	82.4		6.5		HH		
F0	251	848.80	850	Dipole	V	76.0	76.0	83.1	8.5		VV	27.78	-3.33
F0	251	848.80	850	Dipole	H	83.1	83.1		6.9	24.45	HH		
Handheld standalone, on its back													
F0	128	824.20	850	Dipole	V	74.3	74.3	80.8	6.0	21.95	VV	27.78	-5.83
F0	128	824.20	850	Dipole	H	80.8	80.8		4.6		HH		
F0	195	837.60	850	Dipole	V	73.2	73.2	81.3	6.6	22.55	VV	27.78	-5.23
F0	195	837.60	850	Dipole	H	81.3	81.3		5.4		HH		
F0	251	848.80	850	Dipole	V	74.0	74.0	81.8	7.2	23.15	VV	27.78	-4.63
F0	251	848.80	850	Dipole	H	81.8	81.8		5.6		HH		

Radiated Emissions Test Data Results con't

Test distance is 3.0 metres

EUT				Rx Antenna		Spectrum Analyzer			Substitution Method				
Type	Ch	Frequency (MHz)	Band	Type	Pol.	Reading (dBuV)	Corrected Reading (dBuV)	Max (V,H)	Tracking Generator				
									Reading (dBm)	Corrected Reading (relative to dipole)	Pol.	Limit	Diff to Limit (dB)
GSM850 Band (Harmonics)													
Handheld Standalone, on its back													
Low Channel – 824.5 MHz													
2 nd	128	1648.40	850	Horn	V	50.4	50.4	60.6	-36.9	-34.0	VV	-13	-21.0
2 nd	128	1648.40	850	Horn	H	60.6	60.6		-36.8		HH		
3 rd	128	2472.60	850	251	251	40.0	40.0	44.7	-50.9	-46.4	VV	-13	-33.4
3 rd	128	2472.60	850	251	251	44.7	44.7		-52.1				
The harmonics were investigated up to the 10 th harmonic. Emissions above the 4 th harmonic were in the noise floor (NF)													
Middle Channel – 837.6 MHz													
2 nd	195	1675.2	850	Horn	V	51.8	51.8	61.7	-36.0	-32.9	VV	-13	-19.9
2 nd	195	1675.2	850	Horn	H	61.7	61.7		-35.7		HH		
3 rd	195	2512.80	850	Horn	V	42.4	42.4	47.0	-46.9	-42.4	VV	-13	-29.4
3 rd	195	2512.80	850	Horn	H	47.0	47.0		-47.7				
The harmonics were investigated up to the 10 th harmonic. Emissions above the 4 th harmonic were in the NF													
High Channel – 848.8													
2 nd	251	1697.60	850	Horn	V	51.1	51.1	61.1	-36.2	-33.3	VV	-13	-20.3
2 nd	251	1697.60	850	Horn	H	61.1	61.1	42.6	47.3	-46.1	HH		
3 rd	251	2546.40	850	Horn	V	42.6	42.6	47.3		-46.6	VV	-13	-28.6
3 rd	251	2546.40	850	Horn	H	47.3	47.3						
The harmonics were investigated up to the 10 th harmonic. Emissions above the 4 th harmonic were in the NF													

Radiated Emissions Test Results con't

Test Distance was 3.0 metres.

GSM850 Band

July 09, 2003

The measurements were performed with the handheld in standalone upright position.

EUT				Rx Antenna		Spectrum Analyzer			Substitution Method				
Type	Ch	Frequency (MHz)	Band	Type	Pol.	Reading (dBUV)	Corrected Reading (dBUV)	Max (V,H)	Tracking Generator				
									Reading (dBm)	Corrected Reading (relative to dipole)	Pol.	Limit	Diff to Limit (dB)
GSM850 BAND (Local Oscillator) Transmit RF Local Oscillator 1 , (LO) Tx/Rx mode Low Channel													
FO	128	1272.20	850	Horn	V	NF	NF					-13	
FO	128	1272.20	850	Horn	H	NF							
High Channel													
FO	251	1296.80	850	Horn	V	NF	NF						
FO	251	1296.80	850	Horn	H	NF							
GSM850 BAND (Local Oscillator) RF Local Oscillator 2, (LO) Tx/Rx mode Low Channel													
FO	128	1738.20	850	Horn	V	NF	NF					-13	
FO	128	1738.20	850	Horn	H	NF							
High Channel													
FO	251	1787.40	850	Horn	V	NF	NF					-13	
FO	251	1787.40	850	Horn	H	NF							

Radiated Emissions Test Data con't

Test Distance was 3.0 metres.

GSM850 Band

July 09, 2003

The measurements were performed with the handheld in standalone upright position.

EUT				Rx Antenna		Spectrum Analyzer			Substitution Method					
Type	Ch	Frequency (MHz)	Band	Type	Pol.	Reading (dBuV)	Corrected Reading (dBuV)	Max (V,H)	Tracking Generator					
									Reading (dBm)	Corrected Reading (relative to dipole)	Pol.	Limit	Diff to Limit (dB)	
GSM850 BAND IF Local Oscillator														
IF LO Channel 195, (837.6 MHz)														
FO	195	896.00	850	HLP	V	52.1	51.56	51.26	-37.1	-21.65	VV	-13	-8.65	
FO	195	896.00	850	HLP	H	47.8	47.26				HH			

Radiated Emissions Test Data Results con't

Test Distance is 3.0 metres

										Substitution Method				
EUT				Receive Antenna			Spectrum Analyzer			Tracking Generator				
Type	Ch	Freq (MHz)	Band	Pol.	Type	Pol.	Reading (dBuV)	Corrected Reading (dBuV)	Max (V,H) dBuV	Reading (dBm)	Corrected Reading (relative to Isotropic Radiator) (dBm)	Pol.	Limit dBm	Diff to Limit (dB)
PCS BAND (EIRP) - Handheld standalone, upright position														
F0	512	1850.2	1900	V	Horn	V	92.3	92.3	92.2	-3.6	28.09	VV	33	-4.91
F0	512	1850.2	1900	V	Horn	H	77.0	77.0		-2.8		HH		
F0	661	1880.0	1900	V	Horn	V	91.4	91.4	91.4	-3.7	28.09	VV	33	-4.91
F0	661	1880.0	1900	V	Horn	H	78.3	78.3		-2.8		HH		
F0	810	1909.8	1900	V	Horn	V	91.0	91.0	91.0	-4.6	27.19	VV	33	-5.81
F0	810	1909.8	1900	V	Horn	H	79.8	79.8		-3.7		HH		
PCS BAND (EIRP) - Handheld standalone, on its side														
F0	512	1850.2	1900	V	Horn	V	84.4	84.4	85.3	-10.2	21.09	VV	33	-11.91
F0	512	1850.2	1900	V	Horn	H	85.3	85.3		-9.8		HH		
F0	661	1880.0	1900	V	Horn	V	84.8	84.8	84.8	-10.3	21.39	VV	33	-11.61
F0	661	1880.0	1900	V	Horn	H	84.2	84.2		-9.5		HH		
F0	810	1909.8	1900	V	Horn	V	78.9	78.9	89.1	-6.5	25.29	VV	33	-7.71
F0	810	1909.8	1900	V	Horn	H	89.1	89.1		-5.6		HH		
PCS BAND (EIRP) - Handheld standalone, on its back														
F0	512	1850.2	1900	V	Horn	V	81.5	81.5	94.2	-1.6	30.09	VV	33	-2.91
F0	512	1850.2	1900	V	Horn	H	94.2	94.2		-0.8		HH		
F0	661	1880.0	1900	V	Horn	V	81.6	81.6	93.4	-1.7	30.09	VV	33	-2.91
F0	661	1880.0	1900	V	Horn	H	93.4	93.4		-0.8		HH		
F0	810	1909.8	1900	V	Horn	V	80.6	80.6	93.4	-2.1	29.59	VV	33	-3.41
F0	810	1909.8	1900	V	Horn	H	93.4	93.4		-1.3		HH		

Radiated Emissions Test Data Results con't

Test distance is 3.0 metres.

										Substitution Method				
EUT				Receive Antenna			Spectrum Analyzer			Tracking Generator				
Type	Ch	Freq (MHz)	Band	Pol.	Type	Pol.	Reading (dBuV)	Corrected Reading (dBuV)	Max (V,H) dBuV	Reading (dBm)	Corrected Reading (relative to dipole) (dBm)	Pol.	Limit dBm	Diff to Limit (dB)
PCS BAND (Harmonics) - handheld standalone, on its back														
Low Channel														
2nd	512	3700.4	1900	V	Horn	V	NF	NF	41.8	-46.4	-41.7	VV	-13	-28.7
2nd	512	3700.4	1900	V	Horn	H	41.8	41.8		-45.3		HH		
The harmonics were investigated up to the 10th harmonic. Emissions above the 2 th harmonic were in the NF														
Middle Channel														
2nd	661	3760.0	1900	V	Horn	V	NF	NF	40.8	-45.4	-41.8	VV	-13	-28.8
2nd	661	3760.0	1900	V	Horn	H	40.8	40.8		-46.1		HH		
The harmonics were investigated up to the 10th harmonic. Emissions above the 2 th harmonic were in the NF														
High Channel														
2nd	810	3819.6	1900	V	Horn	V	NF	NF	40.1	-46.6	-43.0	VV	-13	-30.0
2nd	810	3819.6	1900	V	Horn	H	40.1	40.1		-48.6		HH		
The harmonics were investigated up to the 10th harmonic. Emissions above the 2 th harmonic were in the NF														

Radiated Emissions Test Results con't

Test Distance was 3.0 metres.

PCS Band

July 09, 2003

The measurements were performed with the handheld in standalone upright position.

EUT				Rx Antenna		Spectrum Analyzer			Substitution Method						
Type	Ch	Frequency (MHz)	Band	Type	Pol.	Reading (dBuV)	Corrected Reading (dBuV)	Max (V,H)	Tracking	Generator	Reading (dBm)	Corrected Reading (relative to dipole) (dBm)	Pol.	Limit	Diff to Limit (dB)
PCS BAND (Local Oscillator)															
RF Local Oscillator 1 (LO) Tx/Rx mode															
Low Channel															
F0	512	1930.10	1900	Horn	V	NF	NF							-13	
F0	512	1930.10	1900	Horn	H	NF									
High Channel															
F0	810	1989.70	1900	Horn	V	NF	NF							-13	
F0	810	1989.70	1900	Horn	H	NF									
PCS BAND (Local Oscillator)															
RF Local Oscillator 2 (LO) Tx/Rx mode															
Low Channel															
FO	512	1423.20	1900	Horn	V	NF	NF							-13	
FO	512	1423.20	1900	Horn	H	NF									
High Channel															
FO	810	1482.80	1900	Horn	V	NF	NF							-13	
FO	810	1482.80	1900	Horn	H	NF									

Radiated Emissions Test Data con't

Test Distance was 3.0 metres.

PCS Band

July 09, 2003

The measurements were performed with the handheld in standalone upright position.

EUT				Rx Antenna		Spectrum Analyzer			Substitution Method				
Type	Ch	Frequency (MHz)	Band	Type	Pol.	Reading (dBuV)	Corrected Reading (dBuV)	Max (V,H)	Tracking Generator				
Type	Ch	Frequency (MHz)	Band	Type	Pol.	Reading (dBuV)	Corrected Reading (dBuV)	Max (V,H)	Reading (dBm)	Corrected Reading (relative to dipole)	Pol.	Limit	Diff to Limit (dB)
PCS BAND IF Local Oscillator LO Channel 661, (1880 MHz)													
TX													
FO	661	854.00	1900	HLP	V	NF	NF				VV	-13	
FO	661	854.00	1900	HLP	H	NF					HH		

Radiated Emissions Test Photo con't**Radiated Emissions at 3.0 metres**