



BLACKBERRY RADAR R2 IS

ITK100 – 1

March 2024

Load Detection (DRAFT)

Installation Guide

Table of contents

1	Overview	3
2	Safety and Product Information	4
3	Get ready for installation	10
4	Installing BlackBerry Radar R2 IS modules	11
4.1	Prepare to install	11
4.2	Installation tools	14
4.3	Matching a module identifier to an asset identifier	15
4.4	Module installation	16
4.4.1	Installation procedure	19
4.4.2	Resetting BlackBerry Radar R2 IS modules	27
5	Cleaning BlackBerry Radar R2 IS modules	28
6	Removing BlackBerry Radar R2 IS modules	29
6.1	Removal tools	29
6.2	Module removal	30
6.3	Battery removal and replacement	31
6.4	Shipment prep	35
7	Support	41
	Legal notice	42

Revision history

Date	Document number	Rev.	Change description	Author	Approved by
March 15, 2024	DOC-63892-001	1.1	Draft release	Cortez Corley	Scott Dill

1 Overview

This guide provides detailed instructions for installing and activating new BlackBerry Radar R2 IS modules. It includes three main tasks:

Task 1: Get ready for installation (see Section 2)

Task 2: Install a BlackBerry Radar R2 IS module (see Section 3)

- Match the module identifier with the asset identifier on the installation worksheet.
- Install the module onto the asset.

Task 3: Uninstall a module (see Section 6)

- Remove the module from the asset.
- Prepare the device for shipping.

Complete BlackBerry Radar documentation is available online when you log in to BlackBerry Radar Dashboard. For instructions on how to configure the BlackBerry Radar Dashboard or how to activate newly installed devices, see the online documentation.











2 Safety and Product Information

Before you start using the BlackBerry Radar R2 IS™ device (herein after referred to as device), review the safety and regulatory information provided in this document. Keep this document in a safe place so that you can refer to it whenever you need it.

In some countries there may be restrictions on using wireless devices with encryption software. Check with your local authorities for the restrictions in your area.

To find the latest safety and product information, visit:
docs.radar.blackberry.com/guides/user_guide_safety

Important safety precautions

	Do not use the device or magnet near medical devices, including pacemakers and hearing aids, because they might malfunction and cause serious harm or death to you or others.
	Do not dispose of the device, in a fire because this might cause an explosion resulting in serious injury, death, or property loss.
	Do not attempt to install the device or open the device when an explosive atmosphere is present.
	The device is designed to be operated in temperatures between -40 and 85°C (-40 and 185°F). Store device in temperatures between 10 and 30°C (14 and 86°F) and 0-50% humidity. Do not expose the device to temperatures above 100°C (212°F). Use of the device outside of the recommended temperature range could cause damage to the device or lithium-metal battery.
	Do not submerge the device in water.
	Do not puncture, crush, or expose battery to severe physical shock. Do not attempt to disassemble battery pack. Do not short-circuit the battery or allow metallic or conductive objects to contact the battery terminals.
 	Under certain extreme circumstances, the non-metallic parts incorporated in the enclosure of this equipment may generate an ignition-capable level of electrostatic charge. Therefore, the equipment shall not be installed in a location where the external conditions are conducive to the build-up of electrostatic charge on such surfaces. In addition, the equipment shall only be cleaned with a damp cloth.
	Exposure to some chemicals may degrade the sealing properties of materials used in the device. Avoid exposing your device to these chemicals.
	This equipment is not suitable for use in locations where children are likely to be present.
	Keep device magnets away from small children. Potential choking hazard.

Product information: BlackBerry Radar R2 IS ITK100-1

Intrinsic safety warnings

Warning markings
WARNING—DO NOT OPEN WHEN AN EXPLOSIVE ATMOSPHERE IS PRESENT
WARNING—POTENTIAL ELECTROSTATIC CHARGING HAZARD—SEE INSTRUCTIONS
WARNING – DO NOT REMOVE OR REPLACE WHILE CIRCUIT IS LIVE UNLESS THE AREA IS KNOWN TO BE FREE OF IGNITABLE CONCENTRATIONS OF FLAMMABLE GASES OR VAPORS

Mechanical properties:

Weight: Approximately 407 g (14.3 oz.)

Size: (L x W x H): 169 x 94 x 43 mm (6.7 x 3.7 x 1.7 in.)

Electrical rating / Battery specifications:

Battery operated device

Non-rechargeable lithium-metal battery

3.6V, 19Ah nominal

Environmental properties:

Enclosure Type: IP67/IP69K

Operating Temperature Range: -40 to 85°C (-40 to 185°F)

IECEX/ATEX/cETLus Temperature Range: -40 to 70°C (-40 to 158°F)

Hazardous locations

Hazardous location markings		
IECEX	ATEX	cETLus
Ex ia IIC T4 Ga	CE 2903	Class I, Division 1, Groups A, B, C, D ; T4
Ex ia IIIC T135°C Da	Ex II 1GD	Class I, Division 2, Groups A, B, C, D ; T4
	Ex ia IIC T4 Ga	Class II, Division 1, Groups E, F, G ; T4
	Ex ia IIIC T135°C Da	Class I, Zone 0, AEx ia IIC T4 Ga
		Zone 20, AEx ia IIIC T135°C Da
		Ex ia IIC T4 Ga
		Ex ia IIIC T135°C Da

Relevant standards

Standards	
IECEX	Subject
IEC 60079-0:2017 Ed. 7	Part 0: Equipment – General requirements
IEC 60079-11:2011 Ed. 6	Part 11: Equipment protection by intrinsic safety "i"
ATEX	
EN IEC 60079-0:2018	Part 0: Equipment – General requirements
EN 60079-11:2012	Part 11: Equipment protection by intrinsic safety "i"
cETLus	
CSA C22.2 No. 60079-0:2019 UL 60079-0:2019	Part 0: Equipment – General requirements
CSA C22.2 No. 60079-11:2014 CSA C22.2 No. 60079-11:2013	Part 11: Equipment protection by intrinsic safety "i"
UL 913- 8 th Edition ANSI/ISA–12.12.01–2000	Intrinsically Safe Apparatus and Associated Apparatus for Use in Class I, II, and III, Division 1, Hazardous (Classified) Locations

Radio specifications:

No cellular modem. 915 MHz: 903~927 MHz. 2.4 GHz and mmwave support.

Radio specification	MAX radio conducted power information (EIRP):
915 MHz: 903~927 MHz	915 MHz: 18.86 dBm
2.4 GHz: 2405~2480 MHz	2.4 GHz: 19.08 dBm
mmwave: 77-81 GHz	78.82 GHz: 24.72 dBm, 78.98 GHz: 24.14 dBm

Operating temperature and humidity

The BlackBerry Radar R2 IS device is designed for the following temperature and humidity ranges:

Operation:	Storage:
Temperature: (-40 to 85°C) -40 to 185°F	Temperature: -10 to 30°C (14 to 86°F)
Humidity: 0-100%	Humidity: 0-50%

Battery safety

The device contains a non-rechargeable, Lithium Metal battery. Do not attempt to recharge the battery.

The battery might present a fire, explosion, chemical burn, or other hazard if mistreated. Do not put the battery in contact with liquids. Do not heat the battery above 100°C (212°F). Heating the battery above 100°C (212°F) could cause the battery to catch fire or explode.

Antennas



Use only the supplied integrated antennas. Unauthorized antenna modifications or attachments could damage the device and might violate U.S. Federal Communications Commission (FCC) or other regulations.

Repair and maintenance

Do not attempt to modify, disassemble, or service the device. Do not attempt to recharge the battery. Only qualified service personnel should perform repairs to the device.

Failure to observe all safety instructions contained in the user documentation for the device will void the Limited Warranty and might lead to suspension or denial of services to the offender, legal action, or both.

Device, magnet, and battery disposal

	<p>Do not dispose of the device, magnet, or battery, in household waste bins or in a fire.</p> <p>Please dispose of magnets in accordance with the laws and regulations in your area. All permanent magnets should be thermally demagnetized prior to disposal or placed in a steel container prior to disposal so the magnets do not attract waste disposal equipment or refuse container.</p>
	<p>The device and battery are recyclable where facilities exist. This symbol is not intended to indicate the use of recycled materials.</p> <p>The Lithium Metal Batteries used in BlackBerry Radar can pose risk of fire, explosion and severe burn hazard if mishandled or damaged. These batteries should never be placed in regular waste and must be recycled through appropriate e-waste or battery recycling channels. Ensure you dispose of your BlackBerry Radar device and its battery in accordance with the laws and regulations in your area. If you have an existing waste management partner, please consult with them regarding disposal, or visit BlackBerry.com/RadarSupport for more information.</p> <p>Only use BlackBerry battery BAT-63845-001 in the BlackBerry Radar R2 IS device. Refer to the BlackBerry Radar Battery Information Sheet for details on dimensions, weight, and Lithium content per battery. Safety Data Sheets can be provided upon request.</p>

Compliance information

Exposure to radio frequency signals

The device radio is a low-power radio transmitter and receiver. It is designed to comply with Federal Communications Commission (FCC) and Innovation, Science and Economic Development Canada (ISED), and The Council of the European Union guidelines and limits, as well as other relevant international guidelines regarding safety levels of radio frequency exposure for wireless devices. These guidelines were developed by independent scientific

experts, governments, and organizations including the Institute of Electrical and Electronics Engineers Standard (IEEE), National Council on Radiation Protection and Measurements (NCRP), and International Commission on Non-Ionizing Radiation Protection (ICNIRP).

FCC compliance statement (United States)

This device complies with Part 15 of the Federal Communications Commission (FCC) Rules under FCC ID: L6AITK100-1. Operation is subject to the following two conditions:

- (1) this device may not cause harmful interference, and
- (2) this device must accept any interference received, including interference that may cause undesired operation.

CAUTION:

Changes or modifications to this unit not expressly approved by the party responsible for compliance could void the user's authority to operate this equipment.

This transmitter must not be co-located or operating in conjunction with any other antenna or transmitter.

NOTE:

This equipment has been tested and found to comply with the limits for a Class B digital device, pursuant to part 15 of the FCC Rules. These limits are designed to provide reasonable protection against harmful interference in a residential installation. This equipment generates uses and can radiate radio frequency energy and, if not installed and used in accordance with the instructions, may cause harmful interference to radio communications. However, there is no guarantee that interference will not occur in a particular installation. If this equipment does cause harmful interference to radio or television reception, which can be determined by turning the equipment off and on, the user is encouraged to try to correct the interference by one or more of the following measures:

- Reorient or relocate the receiving antenna.
- Increase the separation between the equipment and receiver.
- Connect the equipment into an outlet on a circuit different from that to which the receiver is connected.
- Consult the dealer or an experienced radio/TV technician for help.

Innovation, Science and Economic Development Canada certification

This device complies with Innovation, Science and Economic Development Canada (ISED) license-exempt RSS standard(s). Operation is subject to the following conditions:

- (1) this device may not cause interference, and
- (2) this device must accept any interference, including interference that may cause undesired operation of the device.

This device complies with ISED RSS-247, RSS-102, RSS-GEN, RSS 251 and ANSI C63-10 under Certification Number 2503A-ITK1001.

Le présent appareil est conforme aux Innovation, Sciences et Développement économique Canada (ISED) applicables aux appareils radio exempts de licence. L'exploitation est autorisée aux deux conditions suivantes:

- (1) l'appareil ne doit pas produire de brouillage, et
- (2) l'utilisateur de l'appareil doit accepter tout brouillage radioélectrique subi, même si le brouillage est susceptible d'en compromettre le fonctionnement.

L'appareil est conforme aux normes ISED RSS-247, RSS 102, RSS-GEN, RSS 251 et ANSI C63-10 sous le numéro d'agrément 2503A-ITK1001.

Radiation exposure statement:

This equipment complies with FCC + ISED radiation exposure limits set forth for an uncontrolled environment. This equipment should be installed and operated with greater than 20 cm between the radiator and your body.

Déclaration d'exposition aux radiations:

Cet équipement est conforme aux limites d'exposition aux rayonnements FCC + ISED établies pour un environnement non contrôlé. Cet équipement doit être installé et utilisé à plus de 20 cm entre le radiateur et votre corps.

Class B compliance

This device complies with the Class B limits for radio noise emissions as set out in the interference-causing equipment standard entitled "Information Technology Equipment (ITE)--Limits and methods of measurement," ICES-003 of Innovation, Science and Economic Development Canada.

Additional regulatory conformance

Specific details about compliance to the standards and regulatory bodies for the device may be obtained from BlackBerry.

3 Get ready for installation

To complete the installation of your module, you will require a smartphone with internet access to download the BlackBerry Radar Installation App. This app will allow you to record the pairing of each BlackBerry Radar R2 IS module to its asset (that is, the object that the device will be installed on) and its associated BlackBerry Radar modules.

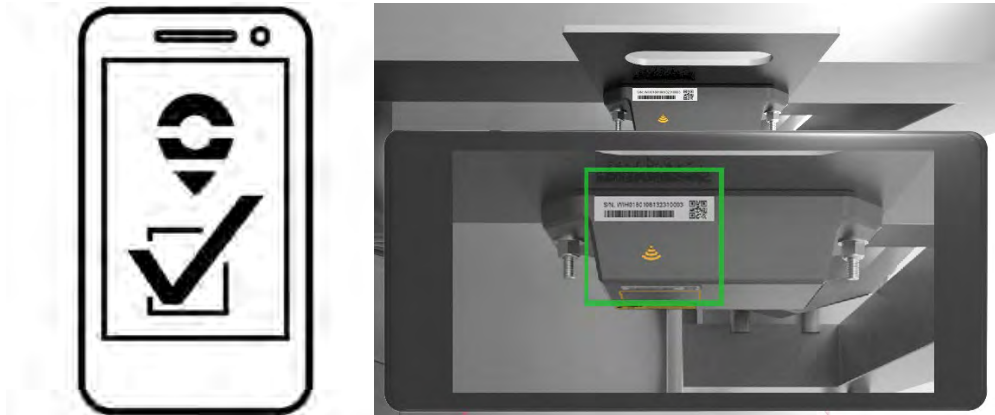

For detailed instructions on the BlackBerry Radar Installation App, log in to the BlackBerry Radar Dashboard and access “Documentation” from the main menu.

If you are unable to utilize the BlackBerry Radar Installation App during your installation, you need to obtain a worksheet where you can record the pairing of each BlackBerry Radar R2 IS accessory to its asset and associated BlackBerry Radar H2M IS modules.

For your convenience, you may quickly create a record of the module and asset identifier pairings by removing the partially attached label from the inner housing of the module and placing it on the installation worksheet, next to the asset that will be tracked by the module.

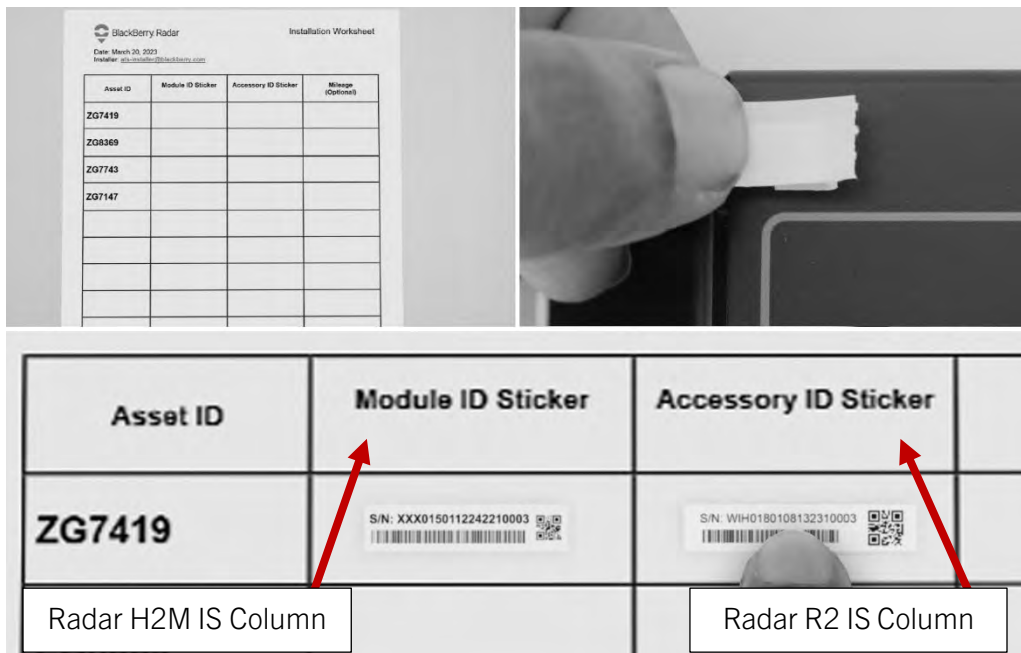

4 Installing BlackBerry Radar R2 IS modules

You may have a large number of BlackBerry Radar R2 IS modules to install. Follow the instructions in this section to:

- Match each module identifier to its asset identifier
- Install the module to the asset you wish to track.

4.1 Prepare to install

To complete the installation of the module to your assets, you will need the following components. The following components are contained in the Radar R2 IS Module and Accessory packaging.

Radar R2 IS Module and Accessory Package Contents

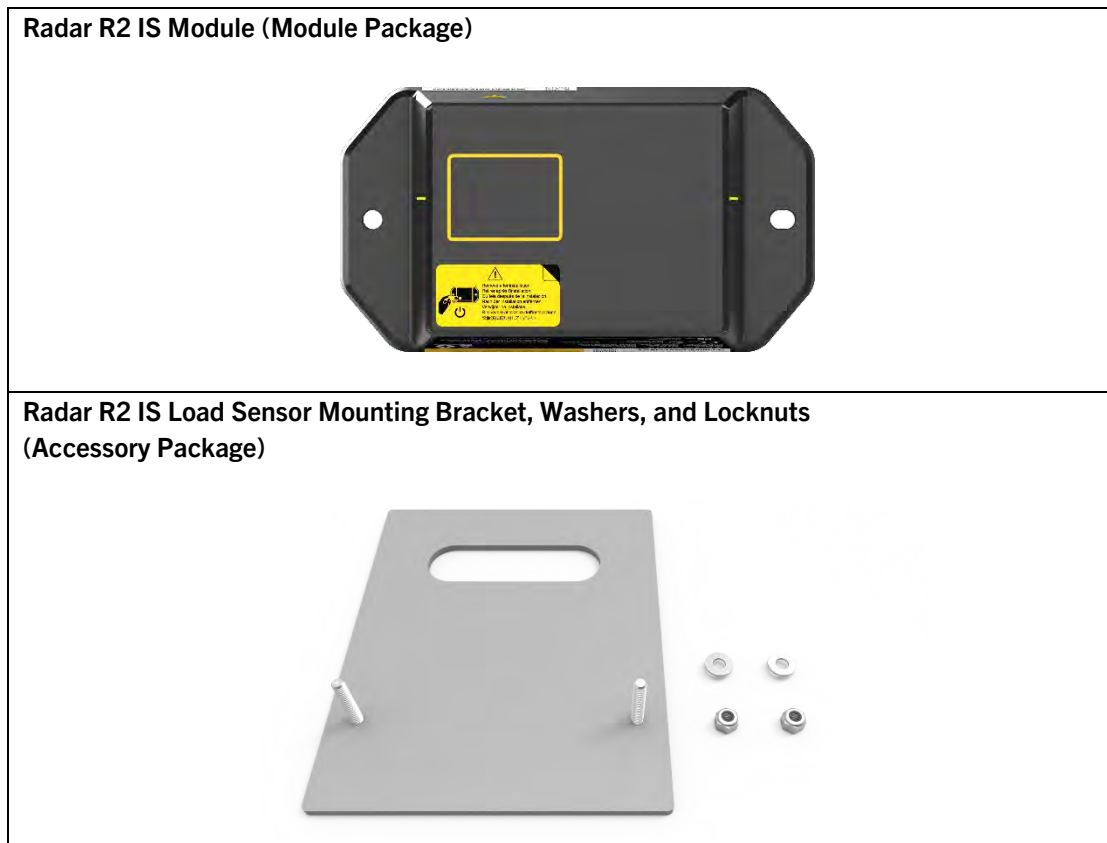

If you are missing any of the above components in your package, contact your BlackBerry Sales Representative.

Fastener Considerations—BlackBerry-Supplied Fasteners

To complete the connection of the BlackBerry Radar R2 IS module to the BlackBerry Radar R2 IS Mounting Bracket, you will need the following fasteners. The following components are contained in your Radar R2 Accessory packaging.

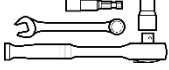
<p>Connect R2 IS to Load Sensor Mounting Bracket</p> 	<p>2 nylon insert lock nuts and washers (Lock Nut: 7/16", 1/4"-20 thread) (11mm head, M6 thread, 22mm length, M6 nut)</p> 	<p>Nut Driver/Socket/Wrench</p>  <p>7/16" (11mm)</p>
---	--	--

Attachment Considerations—Welding



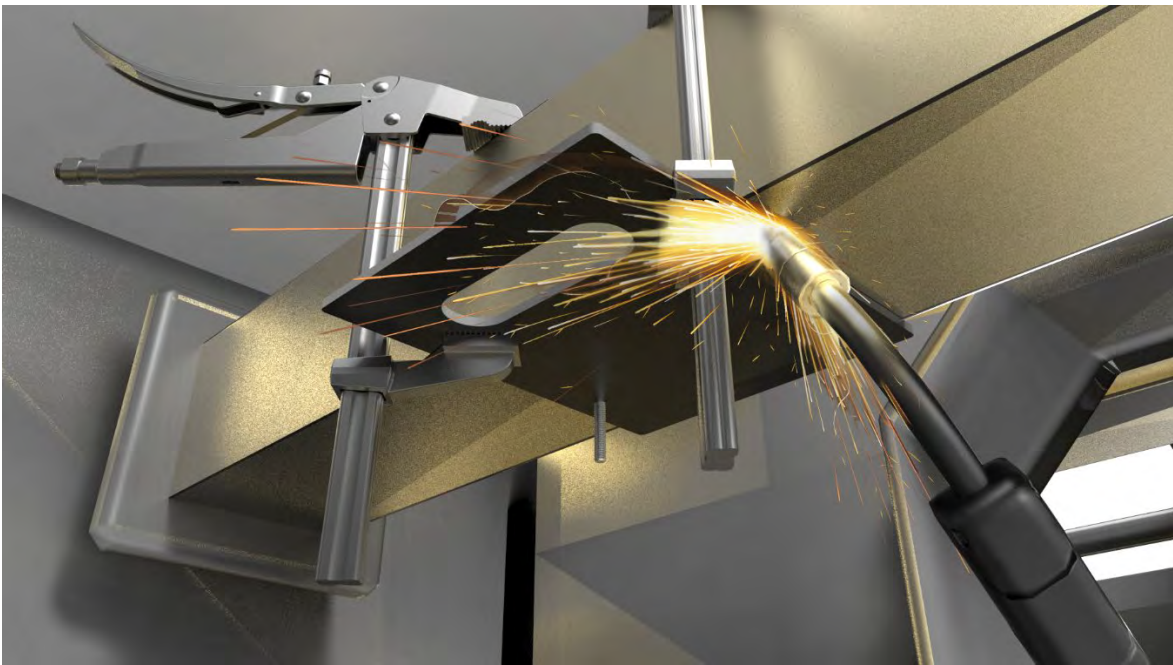

To attach the Radar R2 IS Load Sensor Mounting Bracket to your asset, welding is recommended.



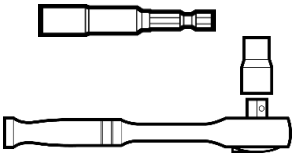
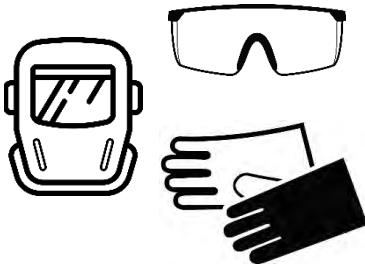

IMPORTANT: If you are welding the bracket to your asset; it is recommended to remove the Radar R2 IS module from the bracket before welding the bracket to the rail car. While the Radar R2 IS module can be mounted to the bracket, before the bracket is welded to the rail car, it is the responsibility of the installer to ensure the Radar R2 IS module is protected from weld splatter and extreme temperatures.

4.2 Installation tools

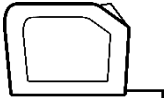
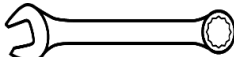
Required tools to complete the installation:

<p>Smartphone with BlackBerry Radar Installation App</p> 	<p>Welder</p> 	<p>Tape</p> 
<p>Nut Driver or Socket Wrench with Socket*</p>  <p>*Nut Driver + Drill offers fastest installation. If no Nut Driver is available, a socket wrench and socket may be used as a substitute.</p>	<p>Welding Mask/Safety Glasses/Welding Gloves</p> 	<p>Pencil or Non-Permanent Marker</p>  <p>Tape Measure</p>  <p>Wrench</p>  <p>*Required only if nuts and bolts are used.</p>

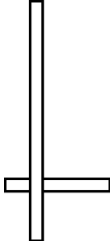
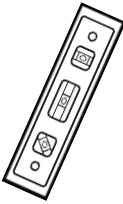
Recommended tools to complete the installation:

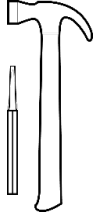
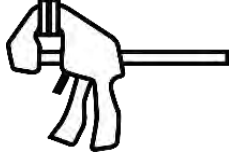
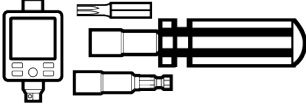
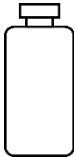
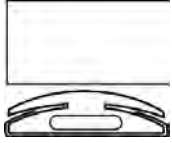
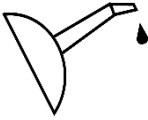
<p>T-Square</p> 	<p>Pocket Level</p> 	<p>Towel</p> 	<p>Hammer and Punch</p> 	<p>Clamps</p> 
<p>Torque Screwdriver/Adapter with Socket and Bits* (scale range of 0.4 N-m to 10 N-m, 4 in-lb to 90 in-lb)</p>  <p>*To check compliance with torque specifications for fasteners.</p>	<p>Water*</p>  <p>* If cleaning is required.</p>	<p>Sanding Tools*</p> 	<p>Touch up paint* (Recommended)</p>  <p>*If too much paint was removed from asset, in preparation for welding</p>	

4.3 Matching a module identifier to an asset identifier

In order to track an asset, the BlackBerry Radar R2 IS module that is installed on the asset must be associated with the asset in the BlackBerry Radar Dashboard. It is, therefore, very important to keep a clear record of which BlackBerry Radar R2 IS module is installed on which asset.

The Dashboard application tracks modules and assets using ‘identifiers’. The asset identifier is the name or number of the asset you wish to track. The asset identifiers are entered into the application when you add the assets and will be listed on your installation worksheet. The identifier for each Radar R2 IS module is printed on three labels—two labels attached to the front surface of the outer housing and the other label inside the battery compartment. The module identifier also serves as the serial number (S/N) for the module.

To match a module identifier with an asset identifier:

1. Locate the module identifier for your device. The module identifier is shown in two places.
 1. Externally—temporary S/N label and permanent exterior S/N label, attached to the front of the outer housing,
 2. Internally—permanent main product label, in the battery compartment.

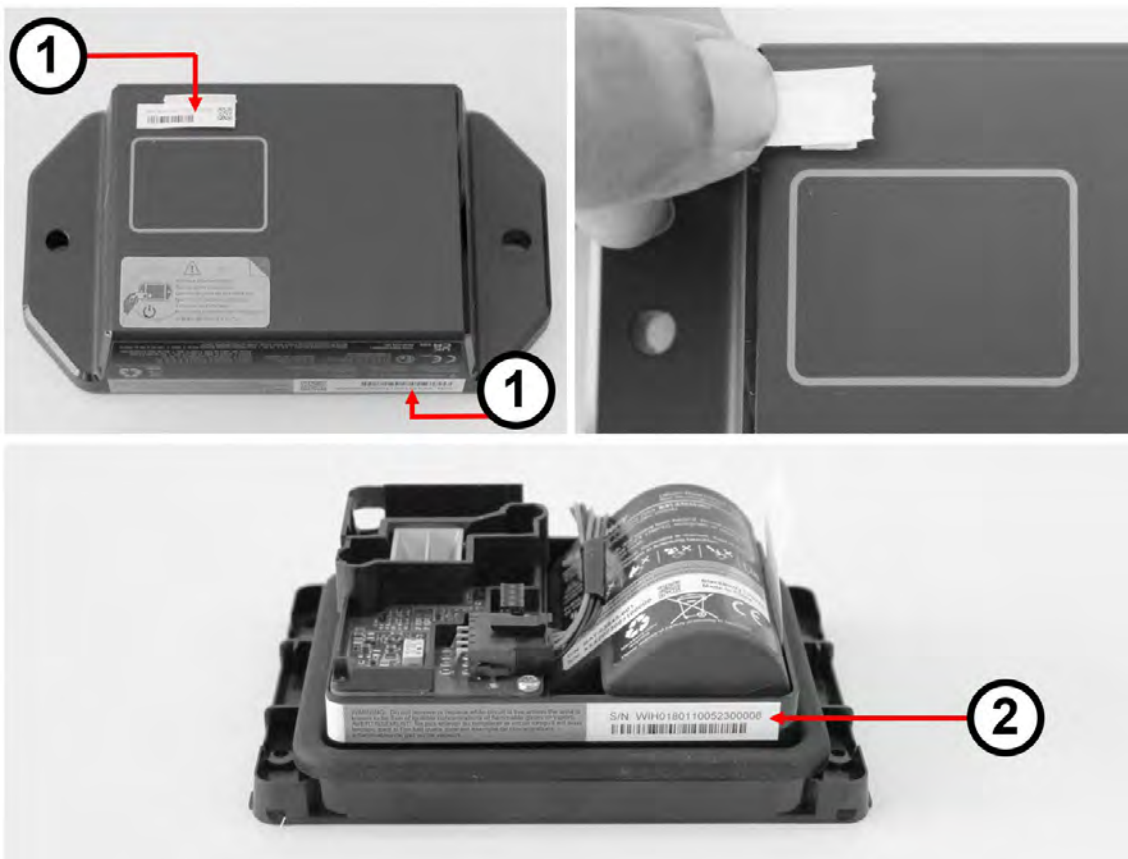

1. Once you have installed the module on the asset, create a record of the module-to-asset-to-accessory pairing within the BlackBerry Installation App by recording the asset identifier and scanning the module identifier for the BlackBerry Radar R2 IS and associated Radar H2M IS module.

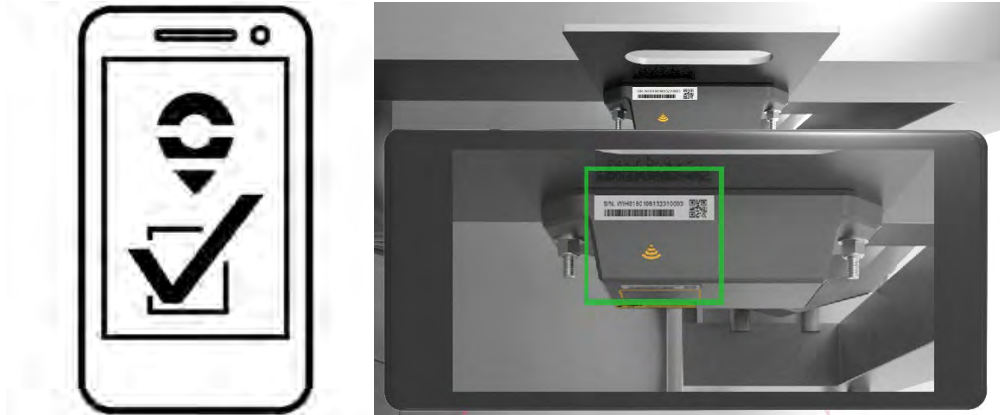

2. If you are unable to use the BlackBerry Radar Installation App during your installation, you need to obtain a worksheet where you can record the pairing of each BlackBerry Radar R2 IS to its asset and associated BlackBerry Radar H2M IS module.

For your convenience, you may quickly create a record of the module and asset identifier pairings by removing the partially attached label from the outer housing of the module and placing it on the installation worksheet, next to the asset that will be tracked by the module.



4.4 Module installation

You may install the module on any flat surface that offers enough mounting area for the bracket and allows the sensing area of the Radar R2 IS module to be positioned over the top surface of the railroad truck's side frame. When selecting a mounting location, carefully consider how the asset will be used during its normal, day-to-day operation.

Do not place the module in a location where it is susceptible to damage from:

- Normal usage activities, such as loading or unloading cargo.
- Moving parts of the asset.
- Road debris.

IMPORTANT: For accurate monitoring, orientation matters.

1. You must install the Radar R2 IS module horizontally and the long edge of the Radar R2 IS sensor module, facing the front or rear end of the rail car.
2. To monitor the rail car loading, always ensure the signal icon is pointed towards the top surface of the railroad truck's side frame.
3. For accurate sensing, the module's sensor window must be positioned directly over the center of the railroad truck's side frame. **NOTE:** Do not install where other components, or parts of the rail car body, may enter the sensing path.

This diagram illustrates the supported installation orientations for the BlackBerry Radar R2 IS module.

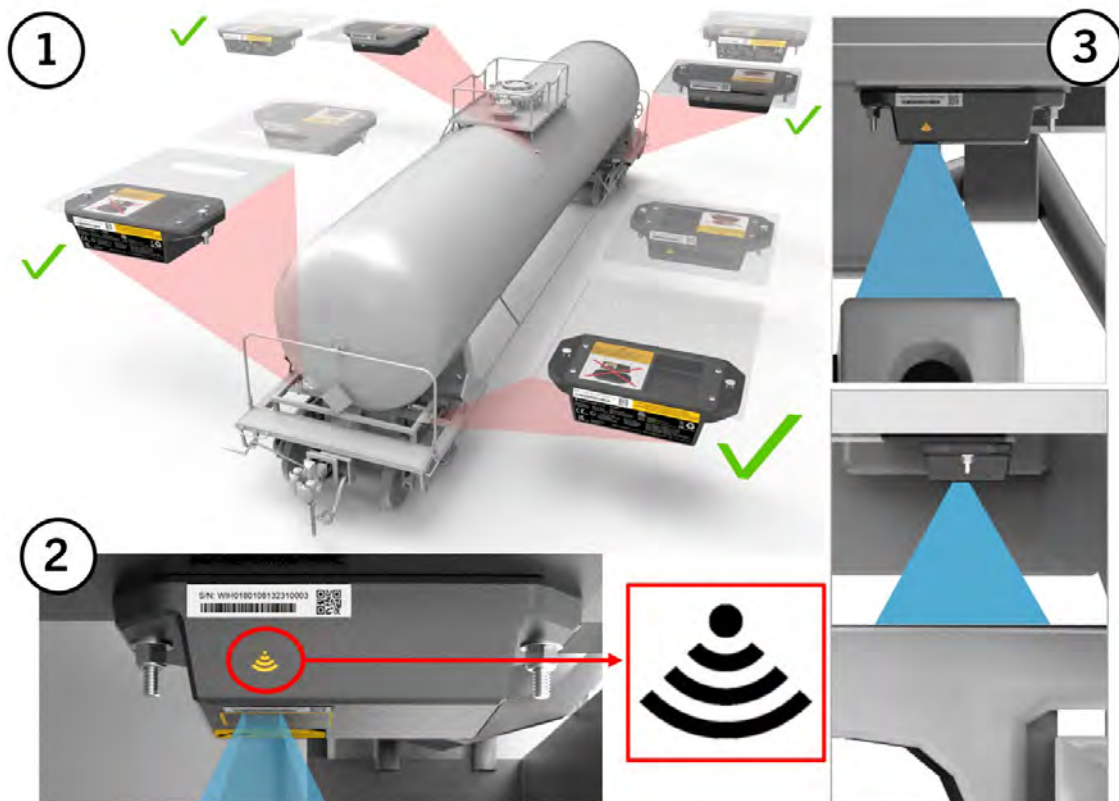

BlackBerry Radar H2M IS + BlackBerry Radar R2 IS Relationship

To use your BlackBerry Radar R2 IS, it must be paired with a BlackBerry Radar H2M IS. For detailed Radar H2M IS Installation Instructions, please review the BlackBerry Radar H2M IS Installation Guide.

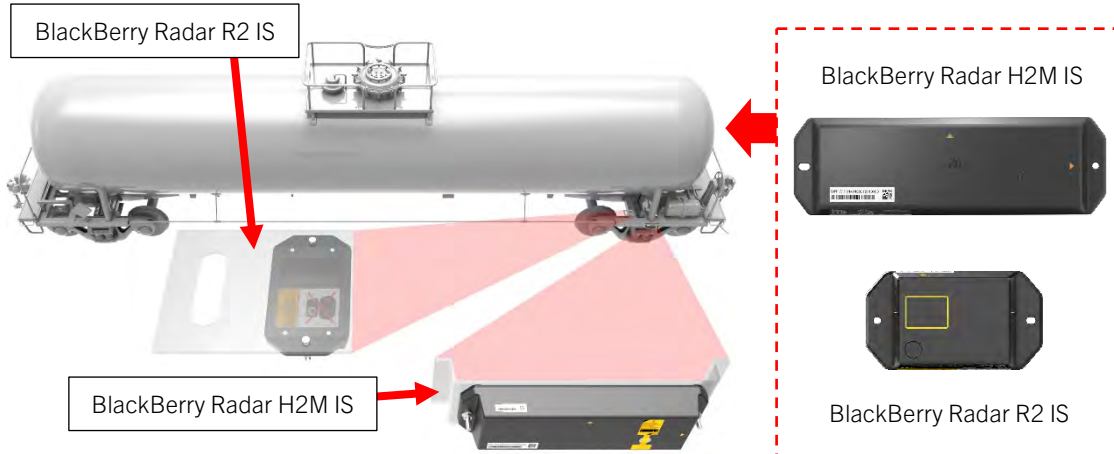

Module Placement

When looking for an installation location under the rail car, it is important to choose an installation location that will provide an unobstructed view of the railroad truck's side frame, directly below where the BlackBerry Radar R2 IS module is mounted. This unobstructed viewing area will allow your BlackBerry Radar R2 IS to accurately determine the load status of the rail car, by measuring the distance between the railroad truck's side frame and the BlackBerry Radar R2 IS module and its change when the rail car is loaded or unloaded.

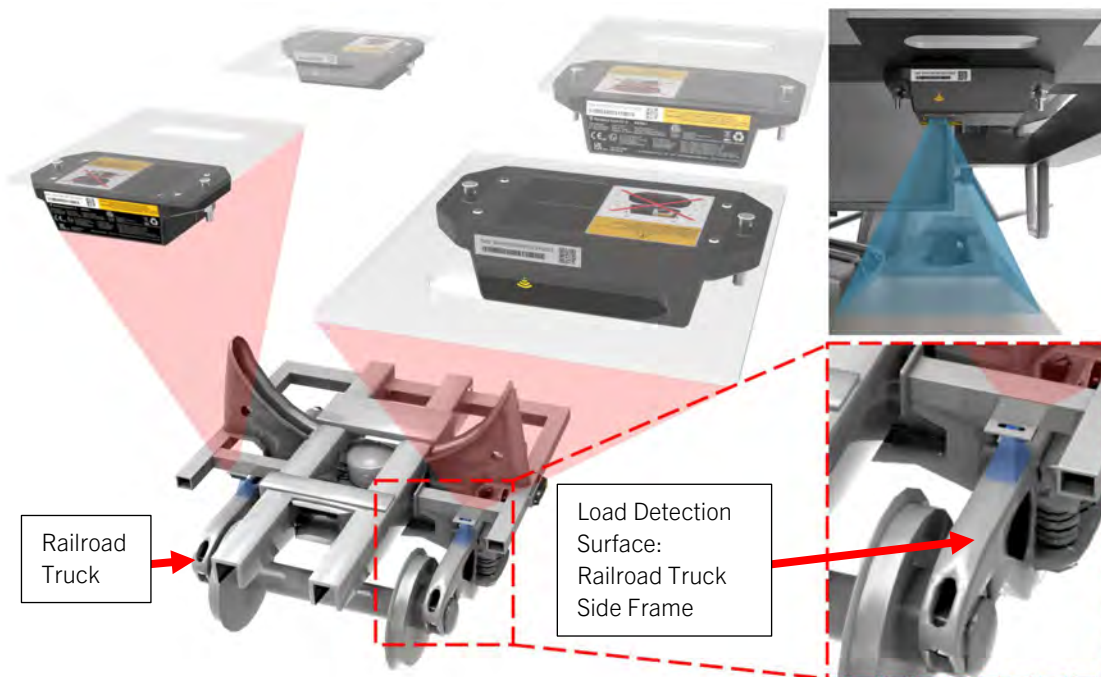

Distance Between the R2 IS Module and Detection Surface

Once you have identified a suitable mounting area on the asset, ensure there is a **minimum** 4" (10 cm) clearance between the sensing surface of the Radar R2 IS module and the top surface of the railroad truck side frame. **Do not exceed** 12" (30 cm) clearance between the sensing surface of the Radar R2 IS module and the top surface of the railroad truck side frame.

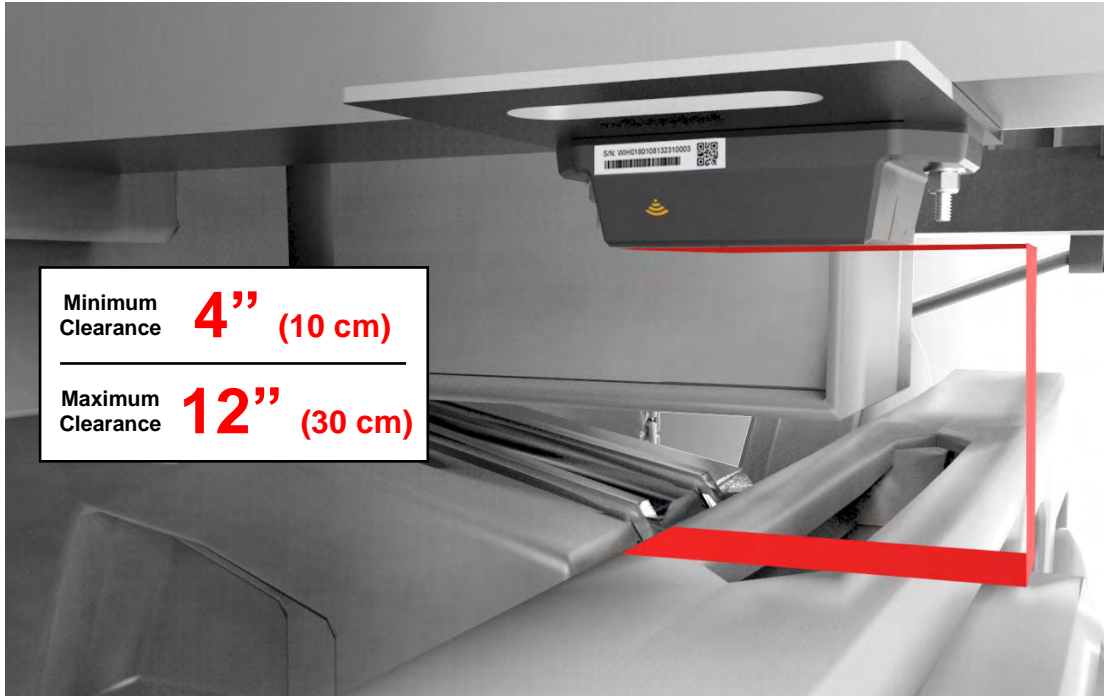

IMPORTANT: For accurate load detection, it is important to ensure there is a **minimum** clearance of 4" (10 cm) between the sensing surface of the module and the top surface of the axle.

4.4.1 Installation procedure

SPECIAL NOTE: To preserve the Intrinsic Safety of the BlackBerry Radar R2 IS accessory, if the Radar R2 IS is dropped at any point during the handling or installation process, please replace with a different module that has not been dropped.

1. Remove the module from the package and from the plastic bag.



2. Locate the Radar R2 IS Load Sensor Accessory Bracket and Fasteners.
 - Place the Radar R2 IS module onto the Load Sensor Mounting Bracket by placing the mounting holes of the R2 IS module onto the studs on the Load Bracket.
 - Secure the brackets to the module with the supplied fasteners. Do not over-tighten the fasteners (do not exceed 35 in-lb. or 4 N-m).

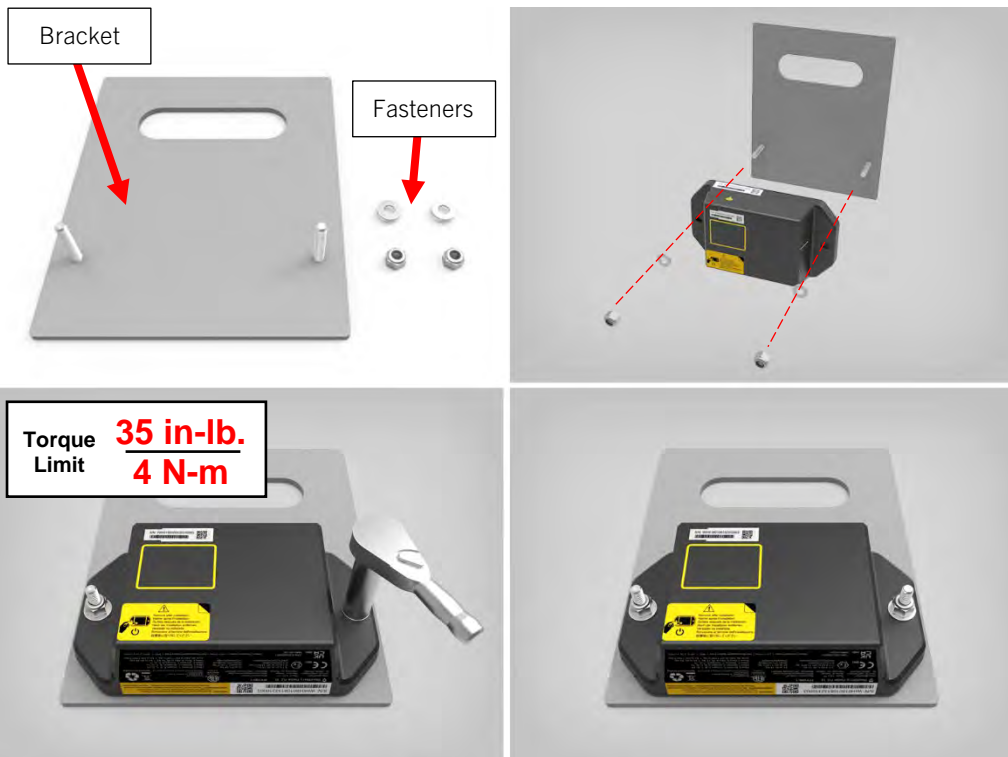

3. Study your asset's construction to determine the proper configuration for the Radar R2 IS Module and Load Sensor Bracket Assembly to facilitate Load Detection on your rail car.

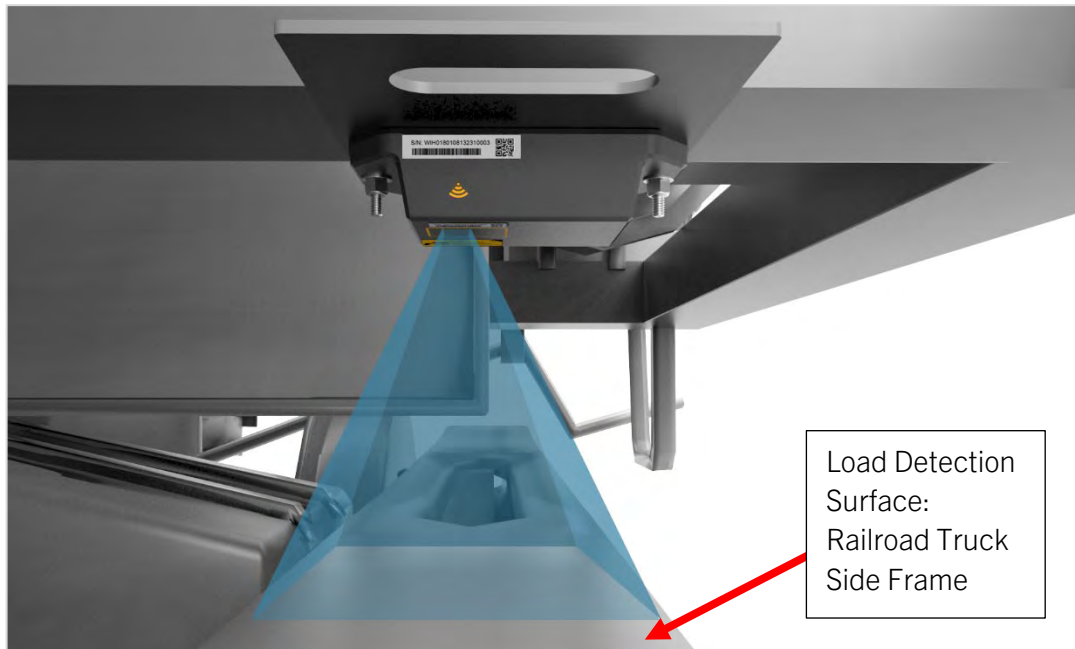
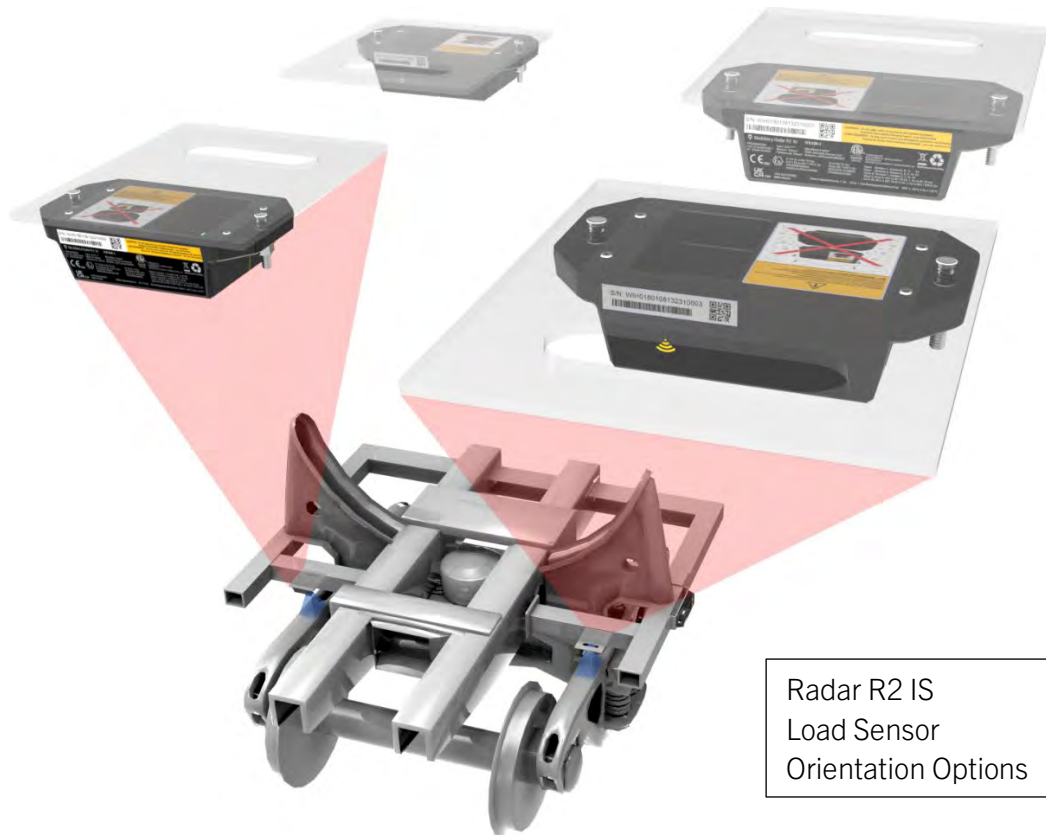

IMPORTANT: The orientation of the Radar R2 IS sensor module, relative to the orientation of the Load Sensor Bracket, will be determined by the installation position required by your rail car's construction and where the Radar R2 IS module and bracket assembly must be installed to monitor the railroad truck side frame. Multiple orientations are possible. Examples shown below.

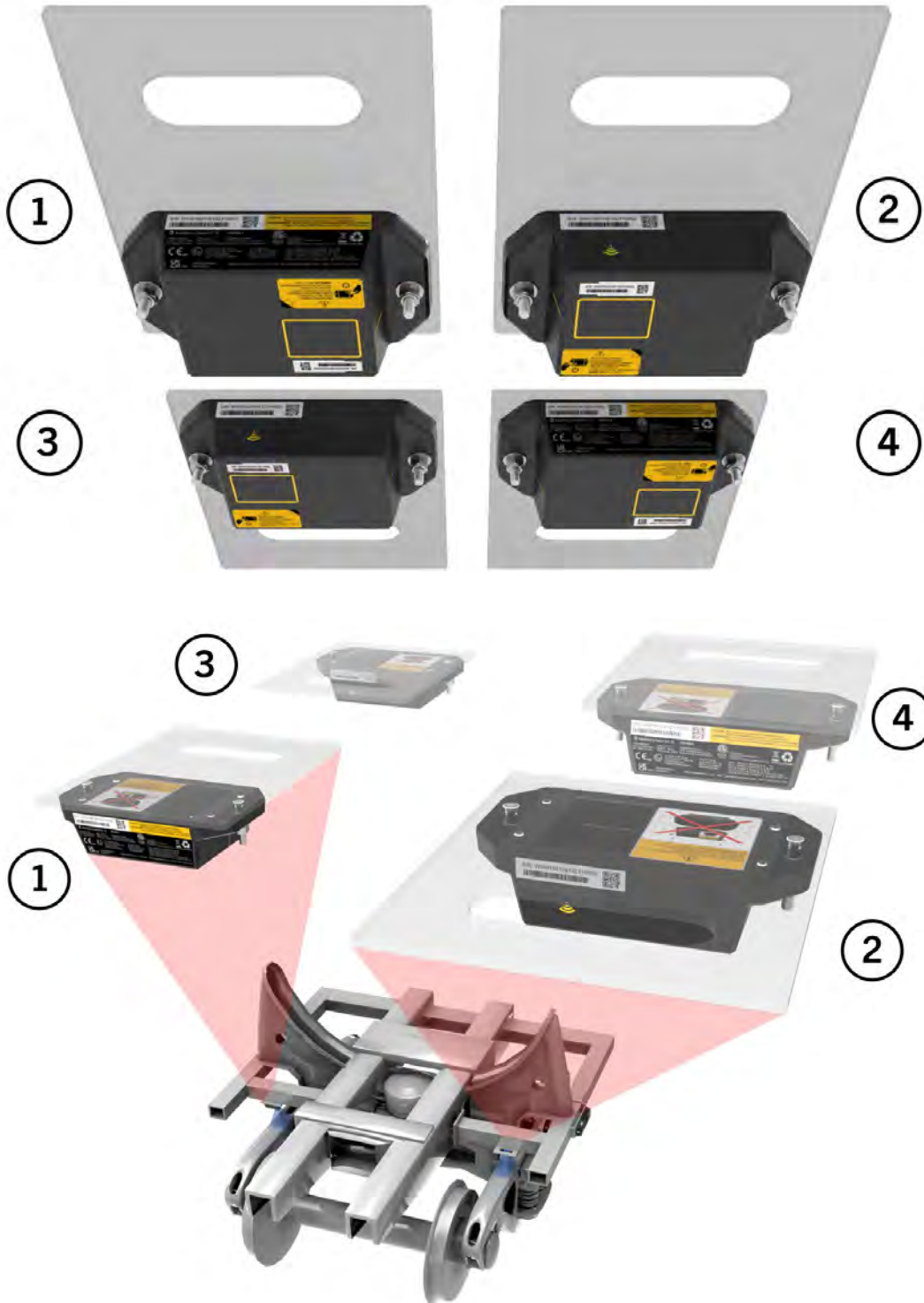

- Once you have determined the best installation location and attachment method for your Radar R2 IS module and bracket assembly, place the module and bracket assembly in your desired installation location.

To help precisely locate the Radar R2 IS sensor for load detection:

- Place the R2 IS sensor window, within the middle of the top surface of the railroad truck side frame.
- Ensure the sensor and bracket assembly is installed straight on the frame.
- Ensure the clearance between the sensing surface of the Radar R2 IS module and the top surface of the railroad truck side frame is between 4" (10 cm) and 12" (30 cm).

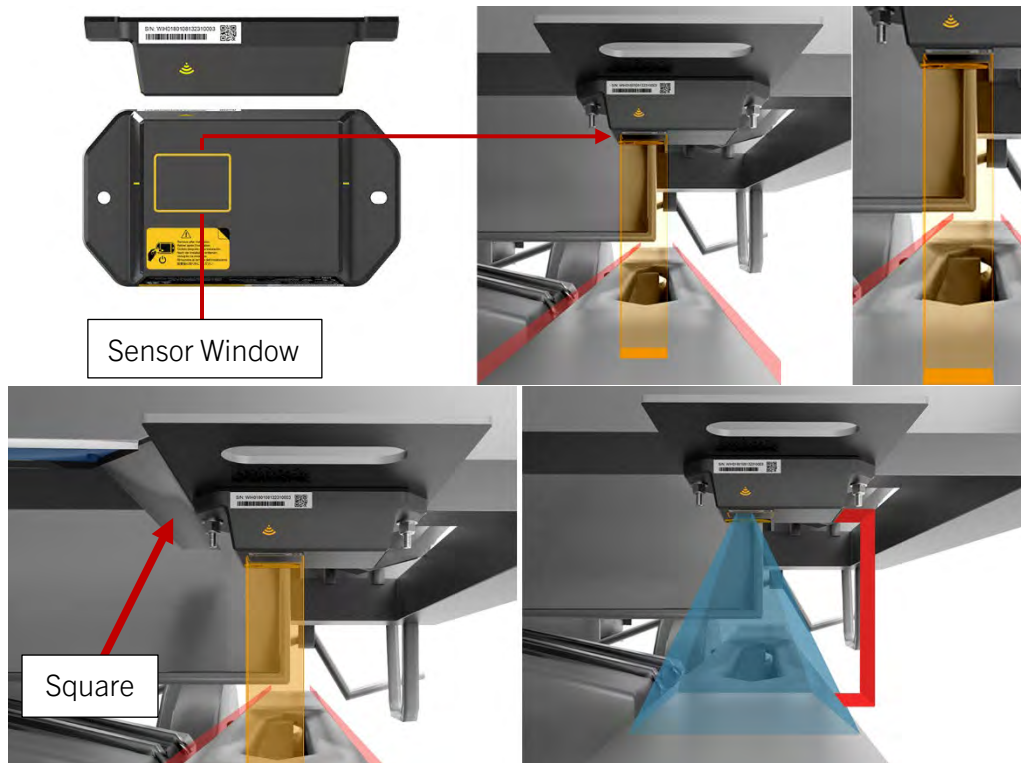

- Once placement location is confirmed, use a pencil or marker to mark the outline of bracket for welding.

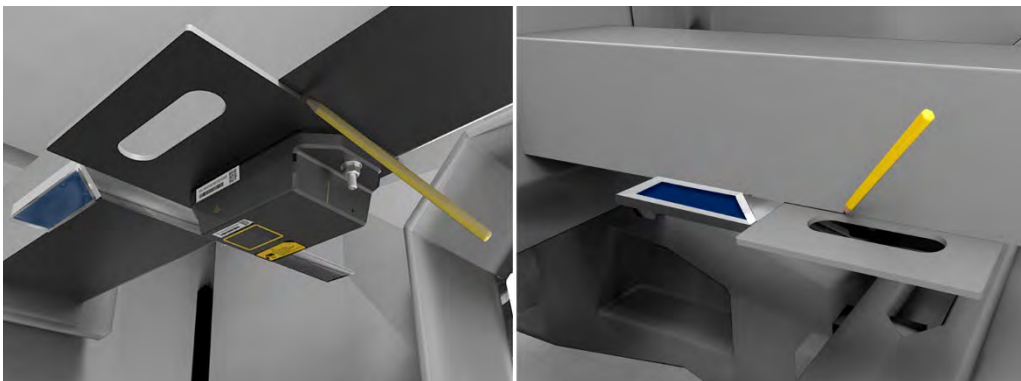

- Using a sander or grinder, remove any paint or rust from the path of the welds (indicated by the lines you marked in the previous step), before welding. If you feel too much paint is removed, during this operation, you may cover the weld and the exposed area with touch up paint, following the welding operation.



- Return the bracket to the desired installation location, apply clamps (if required), and begin welding.

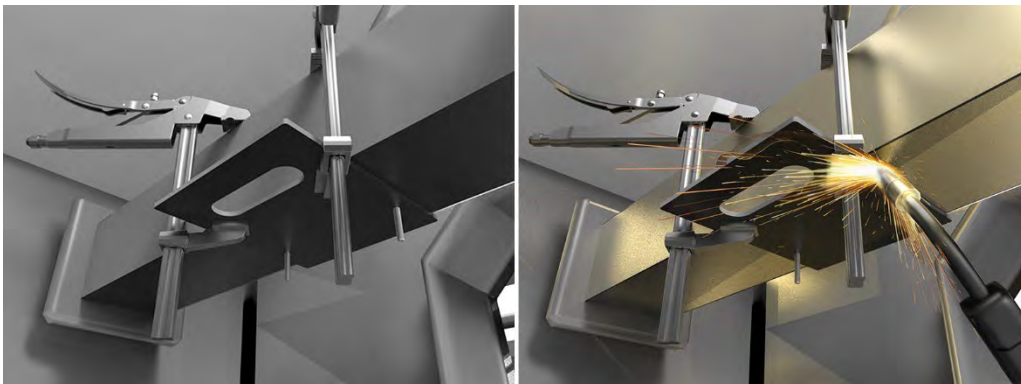

IMPORTANT: If you are welding the bracket to your asset; it is recommended to remove the Radar R2 IS module from the bracket before welding the bracket to the rail car. While the Radar R2 IS module can be mounted to the bracket, before the bracket is welded to the railcar, it is the responsibility of the installer to ensure the Radar R2 IS module is protected from weld splatter and extreme temperatures.



- If you elected to remove the device while welding the bracket to your asset, ensure the bracket has cooled before re-attaching the Radar R2 IS to the bracket. Do not tighten the fastener beyond 35 in-lb. (4 N-m).

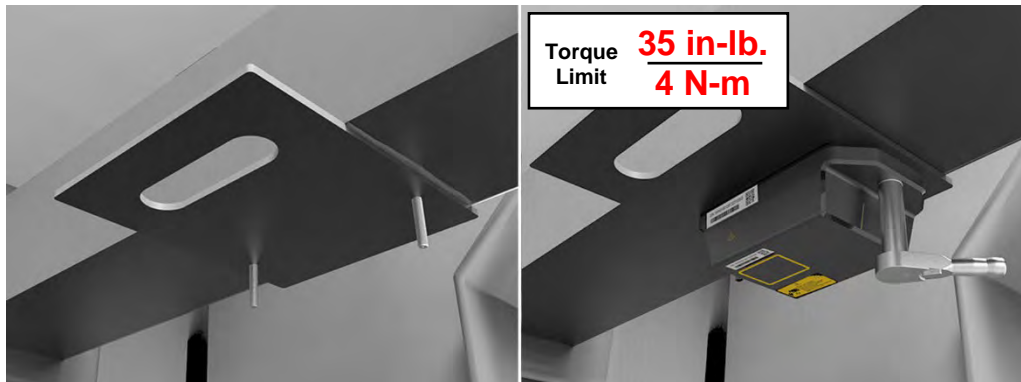

- Once you have installed the module on the asset, create a record of the module-to-asset-to-accessory pairing within the BlackBerry Installation App by recording the asset identifier and scanning the module identifier for the BlackBerry Radar R2 IS and associated Radar H2M IS module. Remove the small temporary S/N label.

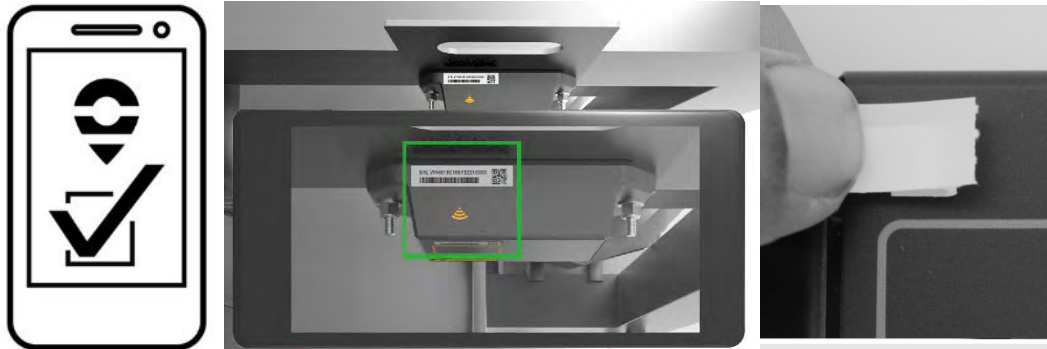

If you are unable to use the BlackBerry Radar Installation App during your installation, you need to obtain a worksheet where you can record the pairing of each BlackBerry Radar R2 IS to its asset and associated BlackBerry Radar H2M IS module.

For your convenience, you may quickly create a record of the module and asset identifier pairings by removing the partially attached label from the outer housing of the module and placing it on the installation worksheet, next to the asset that will be tracked by the module.

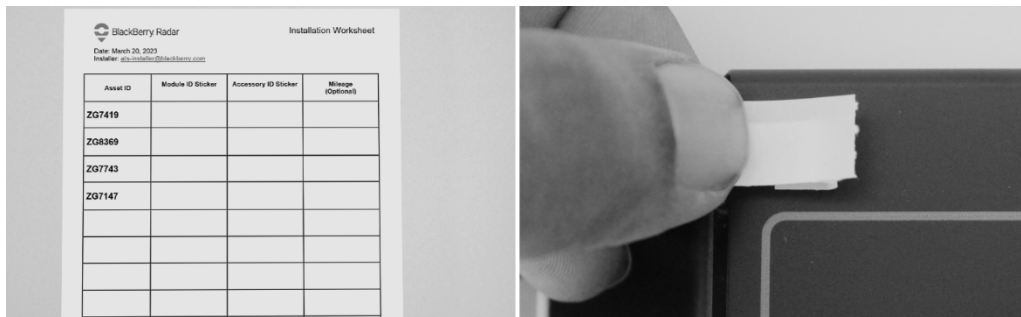

Asset ID	Module ID Sticker	Accessory ID Sticker	
ZG7419	S/N: XXX0150112242210003 	S/N: WIH0180108132310003 	
ZG8369			

10. Activate your modules, using the following process.
 - A. On the module, locate a corner of the magnet tape and lift.
 - B. Continue to lift the magnet tape and fully remove the magnet tape from the module. Lifting the magnet tape will remove the magnet from the magnet recess.

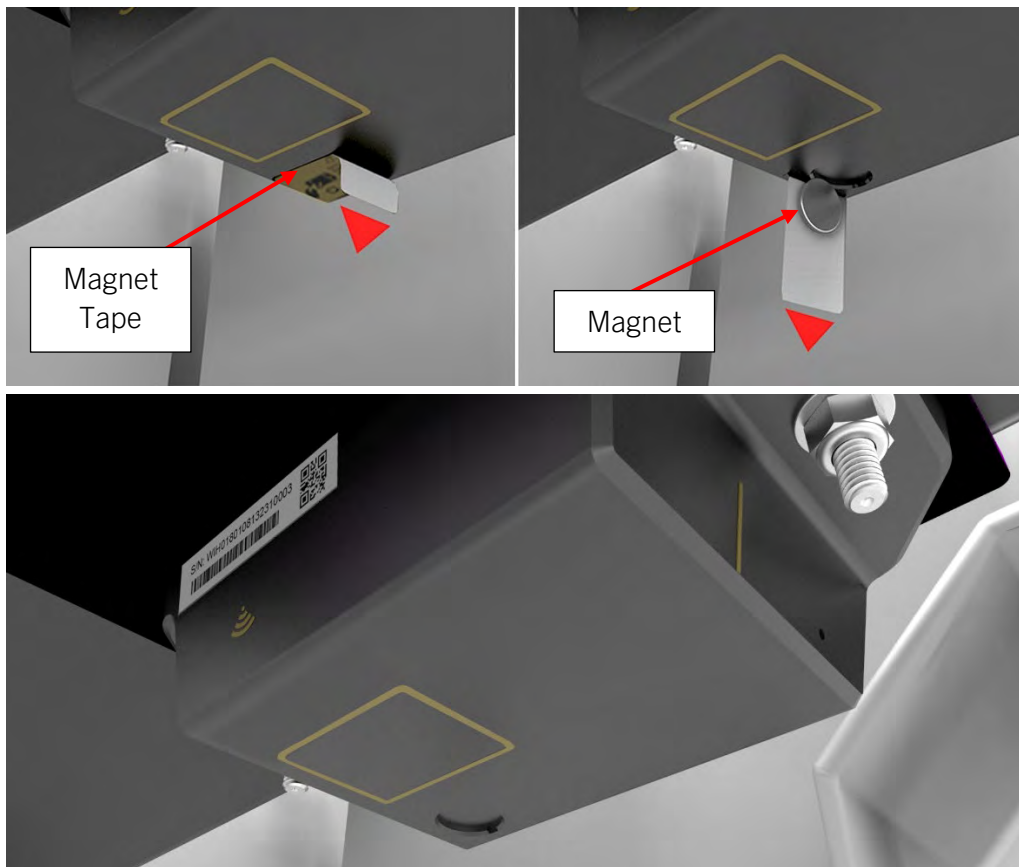

IMPORTANT: The magnet functions as the “Power” switch for the module. The magnet must be completely removed from the module for the module to operate.

IMPORTANT NOTES ON MAGNET USE

Save and Reuse your Magnets: Once the magnet is removed from the module, we recommend saving some magnets, at your service facility. Maintaining an adequate supply of these magnets can assist in the long-term operation of your device, as the magnets will be required to facilitate module resets or to shut down the device for shipping previously active Radar R2 IS modules between locations.

For a full explanation of the module reset procedure, please refer to **Section 4.4.2: Power Cycling your BlackBerry Radar R2 IS modules**. For a full explanation of the module Shipping Procedure, please refer to **Section 6.4: Preparing your BlackBerry Radar R2 IS modules for Shipping**.

11. Installation is complete.



4.4.2 Power Cycling BlackBerry Radar R2 IS modules

Use this procedure if you need to “power-cycle” your BlackBerry Radar R2 IS module.

IMPORTANT: This procedure only works on modules where the Magnet Power Control feature has been disabled in the BlackBerry Radar Dashboard.

Before attempting to power cycle your module, please consult the BlackBerry Radar Dashboard to ensure the Magnet Power Control feature is disabled for the modules you are attempting to power cycle.

1. Locate one of the magnets you removed during the installation/activation of the BlackBerry Radar R2 IS module.

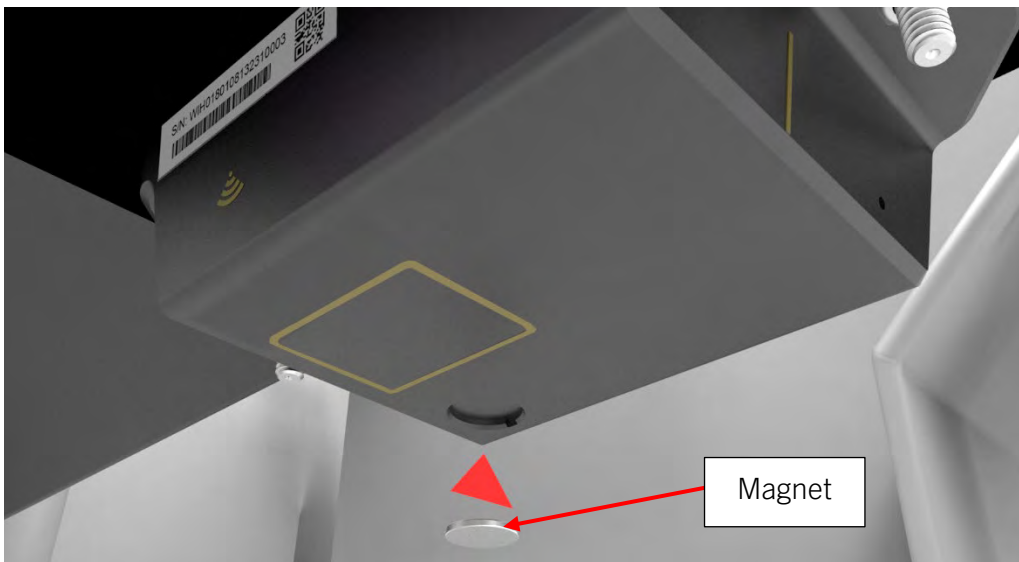

2. Place the magnet within the magnet recess on the front of the housing. Hold the magnet within the magnet ring for at least 5 seconds, then remove the magnet from the module. The module will reboot and reconnect to the **previously paired Radar H2M IS module**.

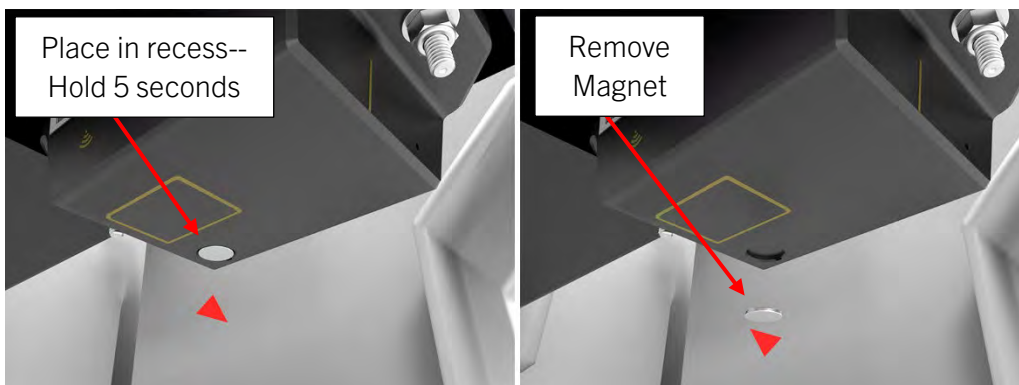

5 Cleaning BlackBerry Radar R2 IS modules

WARNING: Exposure to some solvents may degrade the sealing properties of materials used in the device. Avoid exposing your device to these solvents.

1. For best performance, regularly clean the housing on every service interval of your asset. The cleaning of this module can be performed inside and outside of a Hazardous area using a cloth, dampened with water, to avoid any Electrostatic Discharge risk.

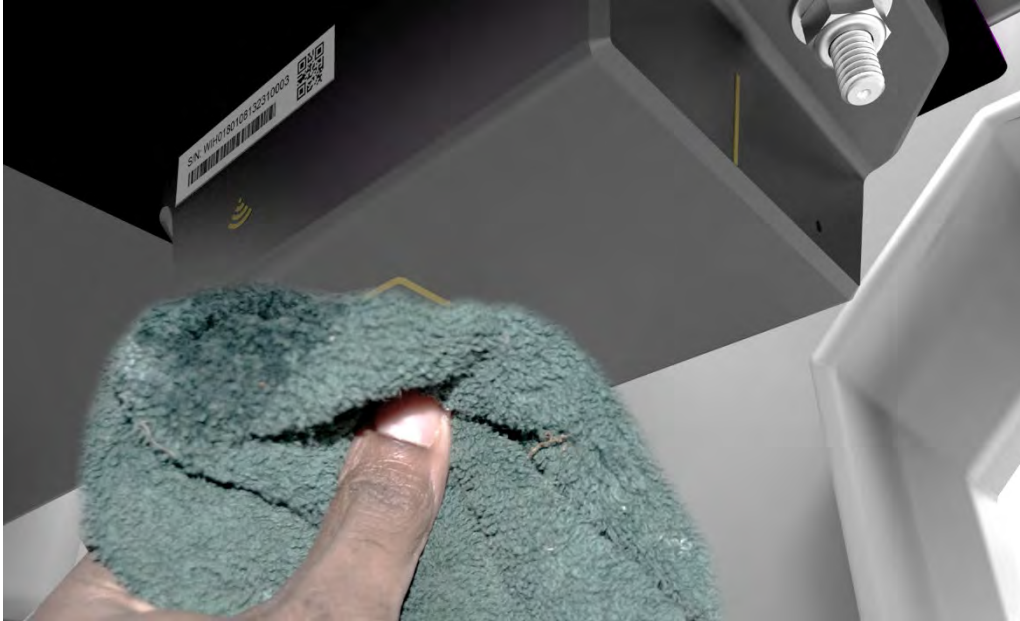

6 Removing BlackBerry Radar R2 IS modules

Use this procedure if you need to remove your BlackBerry Radar R2 IS module for servicing or recycling.

For more information on obtaining service for your devices, or recycling and safe disposal of your devices and batteries, contact your BlackBerry representative, or visit the following:



blackberry.com/RadarSupport--for information on service and the recycling and safe disposal of your device and battery.

Note: If you plan to ship your Radar R2 IS module, or Radar R2 IS battery, please be aware that the ***battery, and the module when shipped along with the battery***, is considered Fully Regulated Class 9 Dangerous Goods in all modes of transportation (Air, Ocean, and Ground) and must only be shipped in special UN certified Dangerous Goods packaging. If you are returning the battery, or battery with module to BlackBerry, you may request this UN-certified packaging from BlackBerry. The Radar R2 IS module, when shipped ***without*** the battery, is not considered Dangerous Goods and can be shipped in any package.

Also, any person who handles, offers for transport, or transports Dangerous Goods must be adequately trained and hold a training certificate; or perform those activities in the presence and under the direct supervision of a person who is adequately trained and who holds a training certificate.

Products that are considered Dangerous Goods can only move on carrier accounts that are approved for Dangerous Goods and are subject to Dangerous Goods surcharges. The Radar R2 IS module, when shipped without the battery, are not subject to these surcharges.

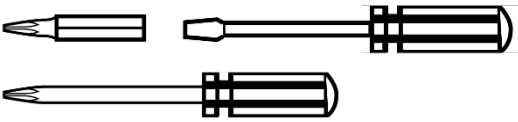
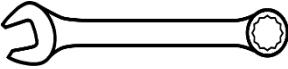
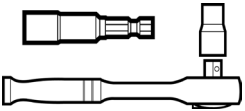
6.1 Removal Tools

<p>Torx (T10) Screwdriver or Bit + Flat Screwdriver</p> 	<p>Wrench</p> 
<p>Nut Driver or Socket Wrench with Socket*</p>  <p>*Nut Driver + Drill offers fastest removal. If Nut Driver is unavailable, a socket wrench and socket may be used.</p>	<p>Safety Glasses</p> 

6.2 Module removal

Module Removal—Welded Bracket

1. Remove the module from the bracket by removing the two fasteners from the ends of the module and remove the module.

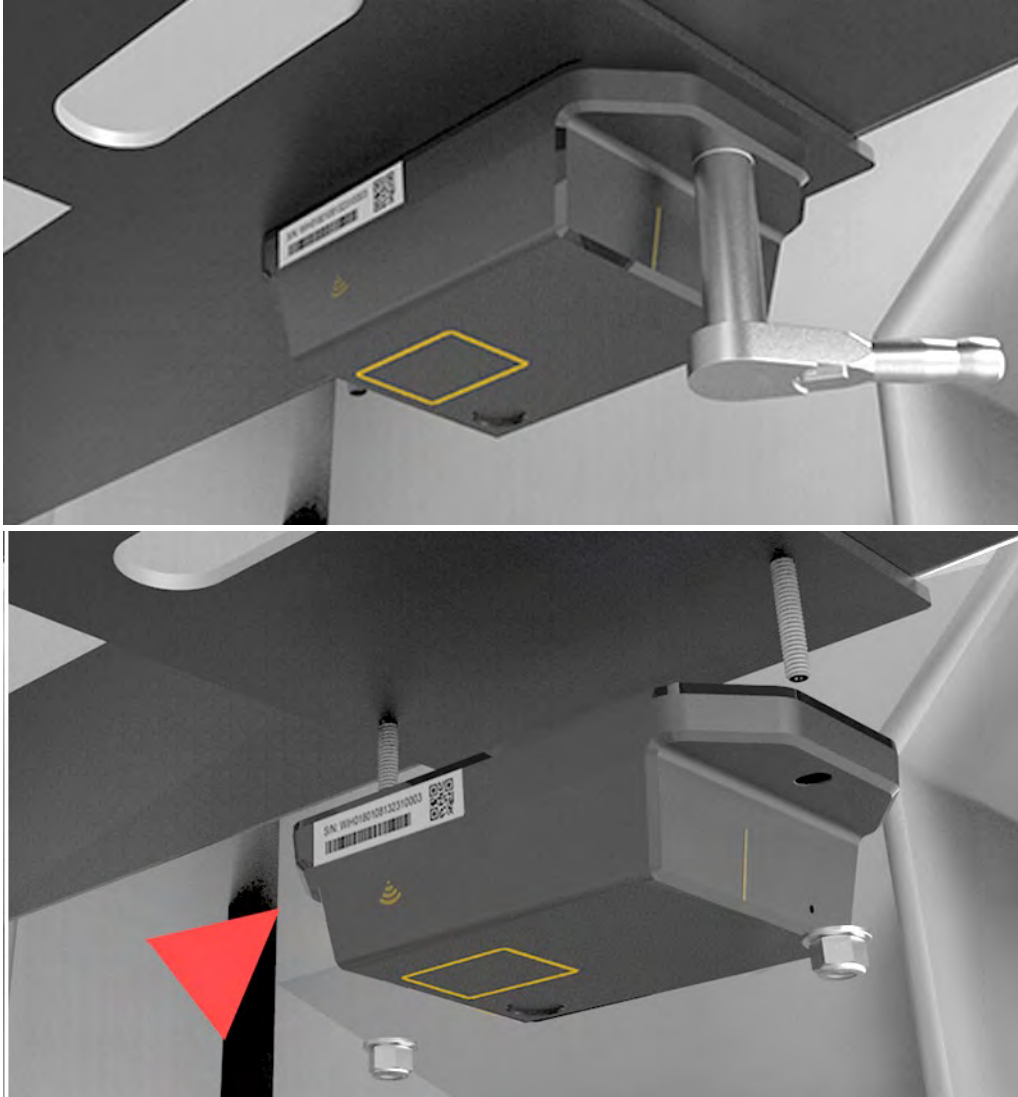

6.3 Battery removal and replacement

**WARNING: Do not open the device when an explosive atmosphere is present.
Do not attempt to replace the battery when an explosive atmosphere is present.**

Work environment

1. When replacing your battery, we recommend performing the replacement in an indoor environment, free from dust, water, and other airborne contaminants. Be mindful of electrostatic discharge. We also recommend performing the battery replacement on a flat work surface and the use of a small tray to temporarily hold the screws during the battery removal/replacement operation.



Battery removal

1. Using a T10 Torx screwdriver, remove the four screws from the back of the product to access the battery. Retain the screws as all four screws will be required to re-secure the battery door to the outer housing.

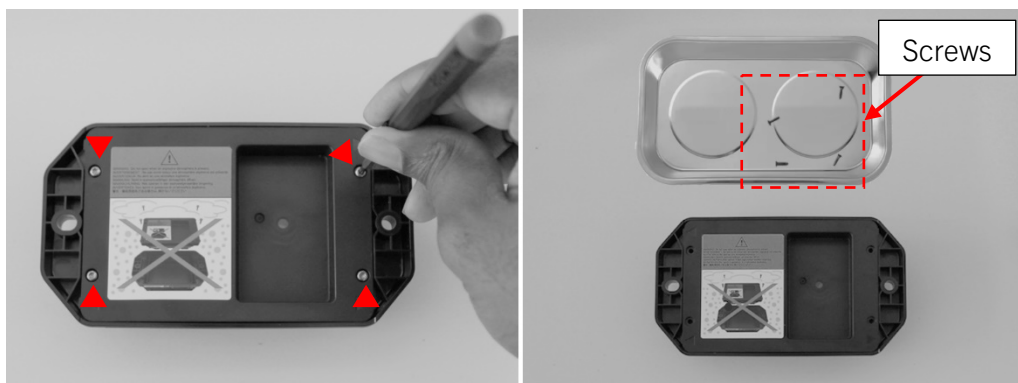

Tip: The use of a Magnetic Parts Tray is recommended to collect the screws.

2. To separate the battery door from the outer housing—begin by inserting a flat screwdriver (3-7mm width) into a slot, marked with the arrows, and pry upwards. Complete the battery door removal by working your way around the door--inserting the screwdriver into the other slots and prying upwards, until the door is free.



3. Disconnect the battery cable from the battery connector.

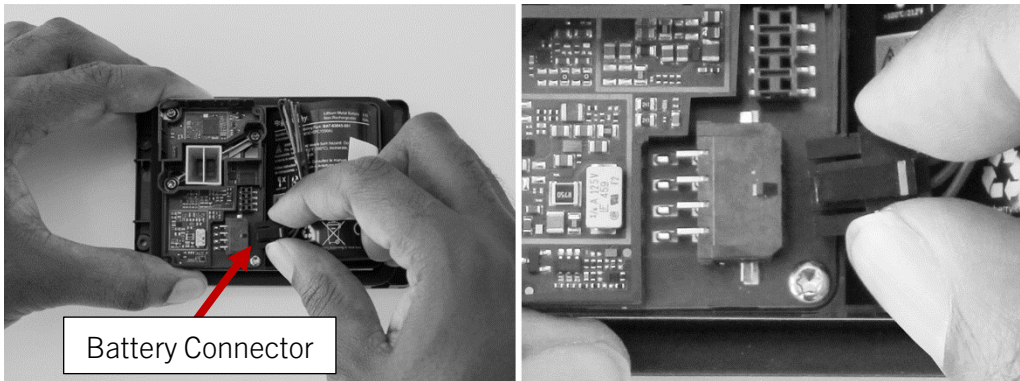

4. Remove the battery from the battery compartment by grasping the pull tab and lifting the battery out of the compartment.

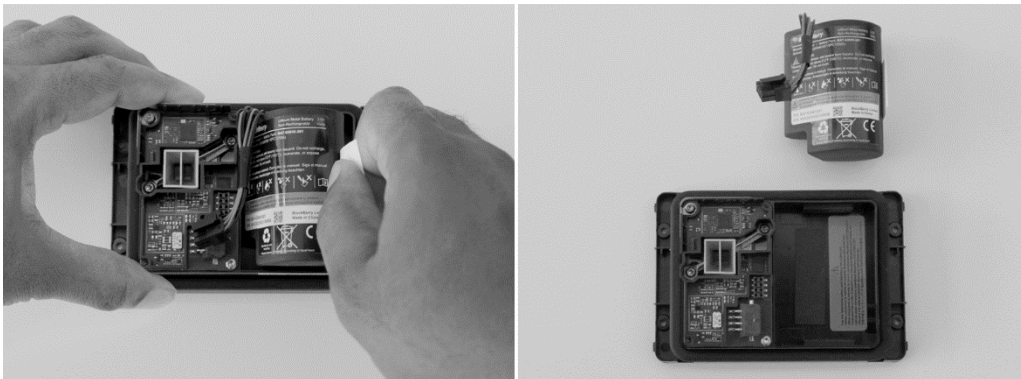

Battery replacement

WARNING: Use only replaceable battery pack Blackberry BAT-63845-001.

1. Insert the replacement battery into the battery compartment.

Tip: For easier installation, insert the left edge of the of the battery into the battery compartment, first.

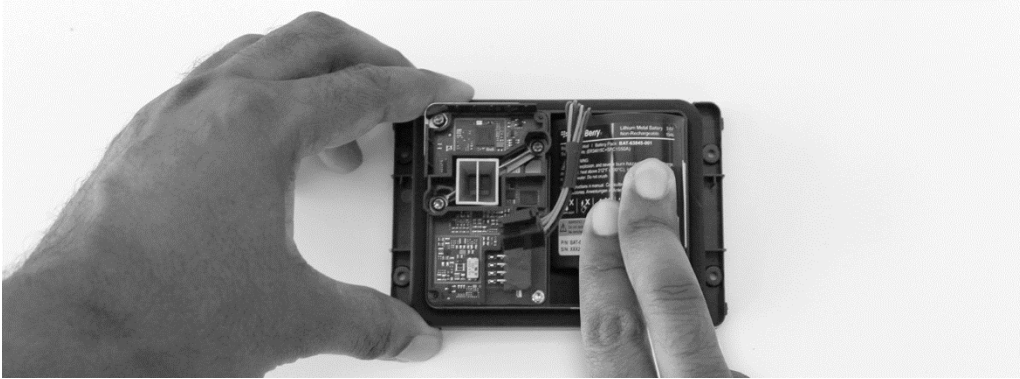

2. Connect the battery cable to the battery connector. The LED will blink to indicate the module is active. NOTE: It can take between 10-15 seconds for the blink sequence to begin. Please be patient. Once you see the LED blink, continue to the next step.

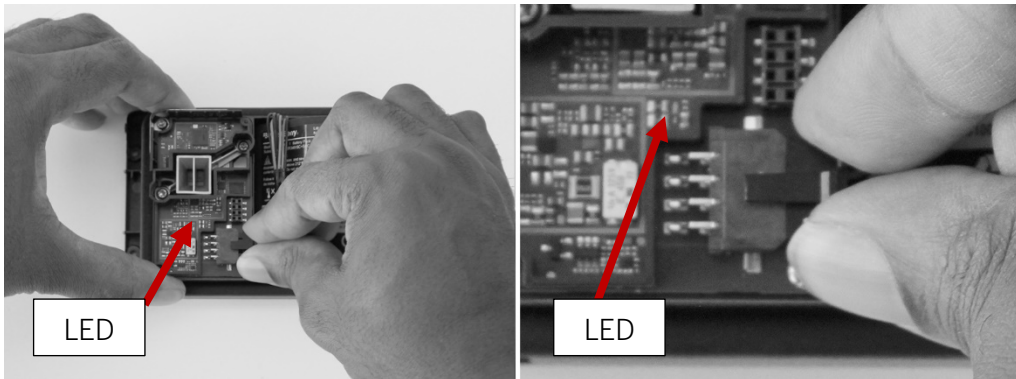

3. **IMPORTANT:** Prior to reassembly, closely inspect the clear encapsulant, over the circuit board, for any damage. If the encapsulant is damaged, replace the device.



4. Fully install the battery door.

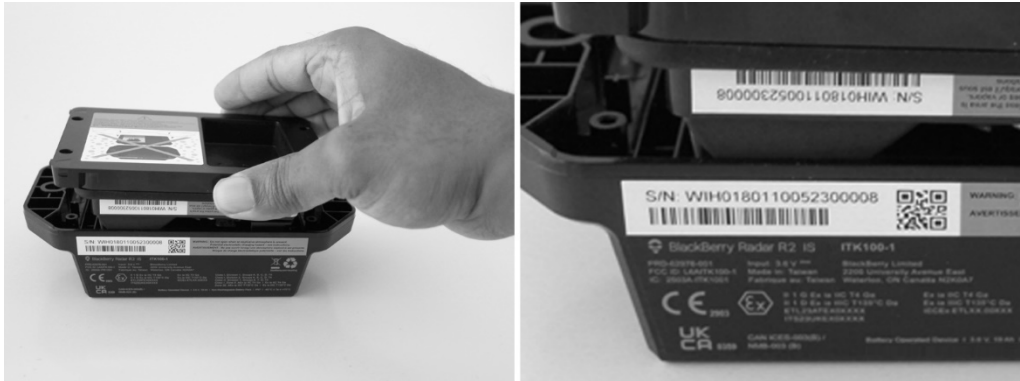

IMPORTANT: Ensure the battery door is fully seated onto the housing by firmly pressing the door at the door's corners and at each arrow embossed into the door.



5. Using a Torx T10 screwdriver, install the screws to secure the battery door.

IMPORTANT: Screw torque must be 2.6 in-lb (0.3 N-m).



6.4 Shipment prep

If you ever need to ship your BlackBerry Radar R2 IS module, there are different procedures to use. Which procedure to use, varies, based on whether you are shipping with a battery installed in the module, or not. The following is a summary of the scenarios we will cover in this Installation Guide.

Scenario 1: Shipping BlackBerry Radar R2 IS, with the battery installed and connected.

Scenario 2: Shipping BlackBerry Radar R2 IS, with the battery installed and disconnected.

Scenario 3: Shipping BlackBerry Radar R2 IS, without the battery.

Scenario 1:
Shipping BlackBerry Radar R2 IS, with the battery installed and connected

If shipping BlackBerry Radar R2 IS with the battery installed and connected, please follow this procedure.



IMPORTANT: To transport or ship your module with the battery installed and connected, the module must be powered off. By default, the magnet functions as the “Power” switch for the module.

The magnet’s ability to control the power may be disabled by enabling the Magnet Power Control feature in the BlackBerry Radar Dashboard. To ensure the magnet will power off the module—the Magnet Power Control feature must be disabled.

Before attempting to transport, or ship, your modules--please consult the BlackBerry Radar Dashboard to ensure the Magnet Power Control feature is disabled on the modules you are attempting to ship.

1. Locate the magnet that shipped with your device, and place within the magnet recess on the front of your product.

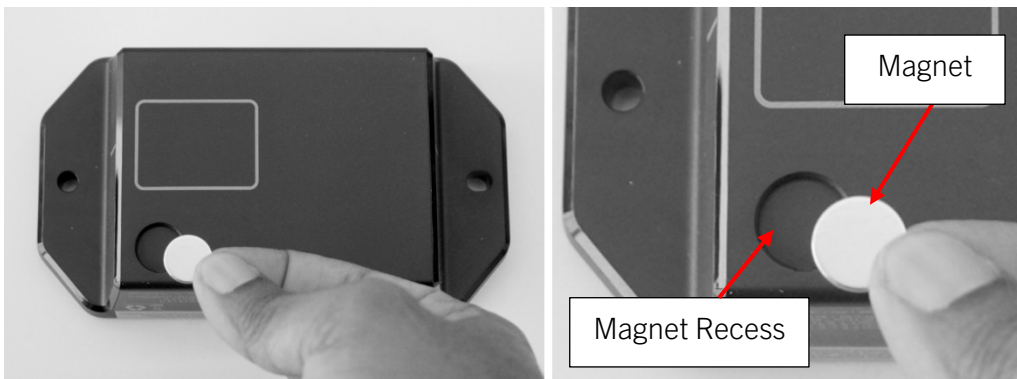

2. Apply a piece of strong tape to keep the magnet in place during transit. If you plan to do any shipping of your device, you may request a sheet of Magnet Tape from your BlackBerry representative.

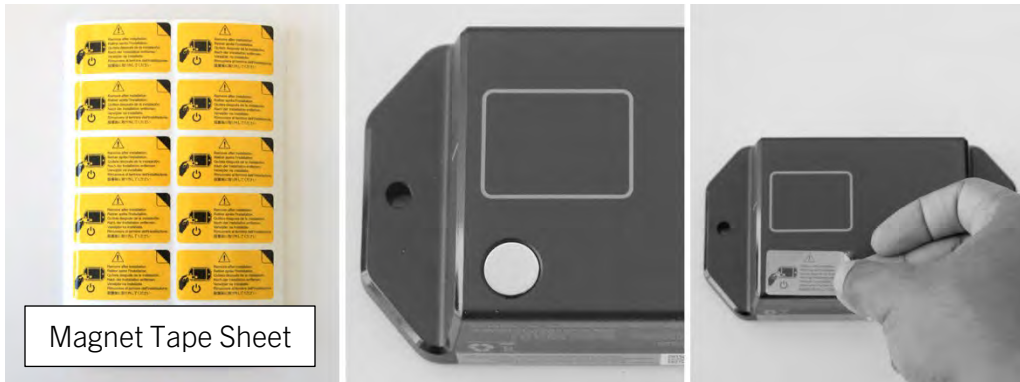

IMPORTANT: When the battery is connected, never ship the module without the magnet in place. The magnet is necessary to keep the module powered off during transit.

3. Module is now ready for placement into the UN certified Dangerous Goods packaging.



Scenario 2:
Shipping BlackBerry Radar R2 IS, with the battery installed and disconnected.

If you don't have a power on/off magnet, but need to send the module, along with the battery, follow this procedure.



IMPORTANT: To transport, or ship your module with the battery, the module must be powered off. If the battery is disconnected, there is no power to the device and the device is powered off.

Before attempting to transport, or ship, your modules according to this method—you must ensure the battery is disconnected, and the cable stowed as illustrated in these instructions.

1. Using a T10 Torx screwdriver, remove the four screws from the back of the product to access the battery. Retain the screws as all screws will be required to re-secure the inner housing to the outer housing.

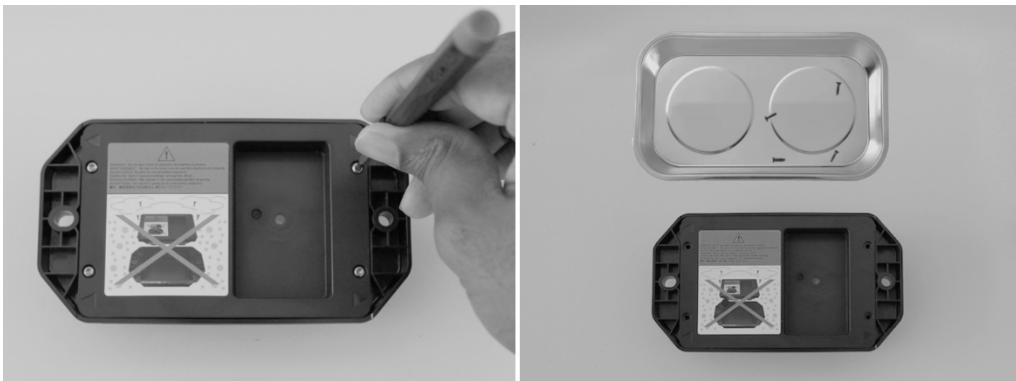

2. To separate the battery door from the outer housing—begin by inserting a flat screwdriver (3-7mm width) into a slot, marked with the arrows, and pry upwards. Complete the battery door removal by working your way around the door--inserting the screwdriver into the other slots and prying upwards, until the door is free.

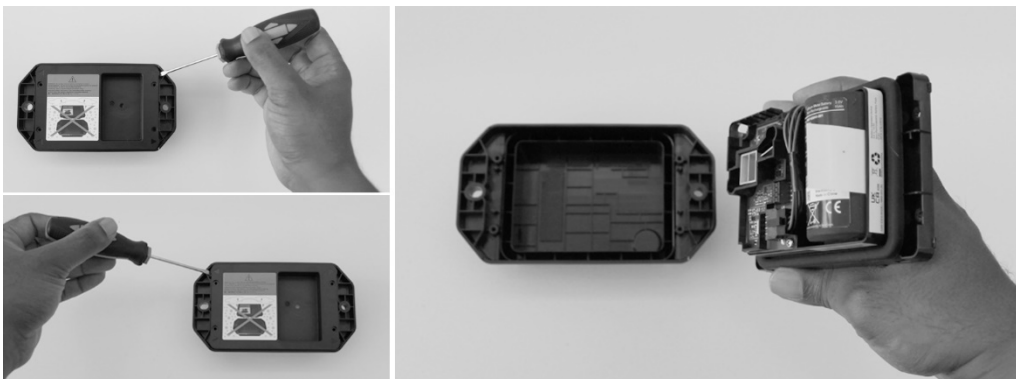

3. Disconnect the battery cable from the battery connector.

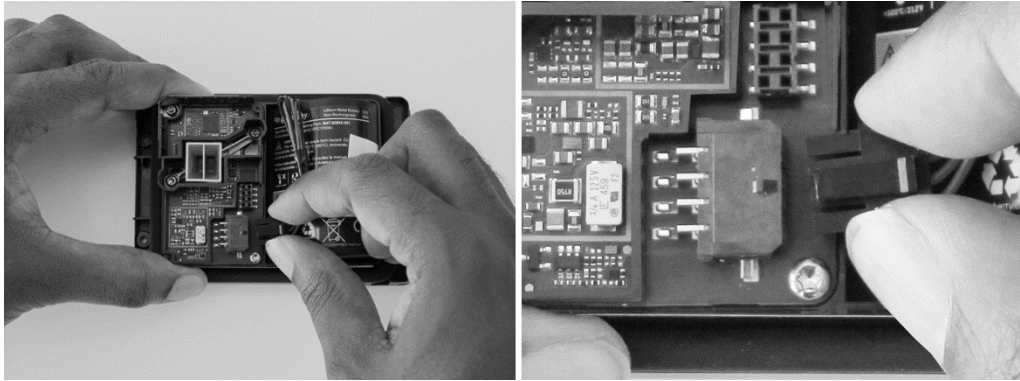

4. Store the battery cable by placing the battery cable connector in the spot below the battery. **NOTE:** Battery cable must be stowed for transit to prevent unintended contact with the battery terminals.

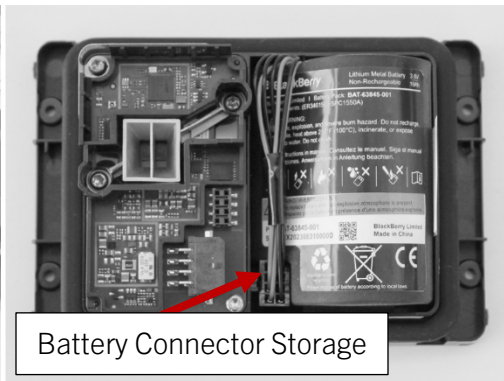
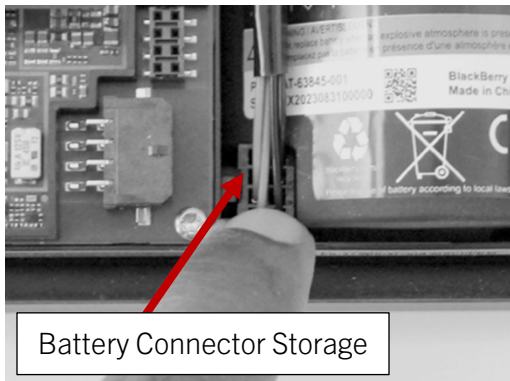

5. Place the battery cover onto the module. Place the screws in the recess on the mounting flange and cover with tape. Leaving the screws uninstalled is recommended as an indicator to the recipient that the battery is disconnected and must be connected before its next use. Module is now ready for placement into the UN certified Dangerous Goods packaging.

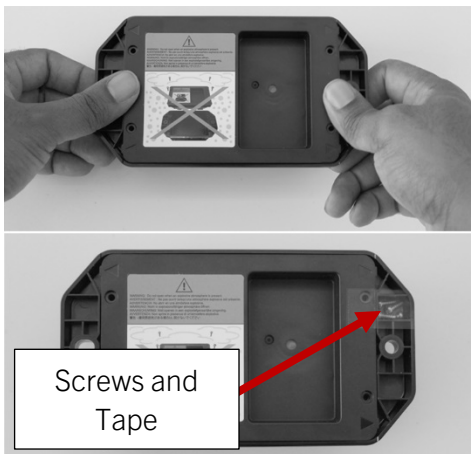

Scenario 3:
Shipping BlackBerry Radar R2 IS, without the battery.

If you only need to send the device and do not need to send the battery, follow this procedure.



IMPORTANT: To transport, or ship your module without the battery, the module must be powered off. If the battery is disconnected, there is no power to the device and the device is powered off.

Before attempting to transport, or ship, your modules according to this method—you must ensure the battery is disconnected, and the cable stowed as illustrated in these instructions.

1. Using a T10 Torx screwdriver, remove the six screws from the back of the product to access the battery. Retain the screws as all screws will be required to re-secure the inner housing to the outer housing.

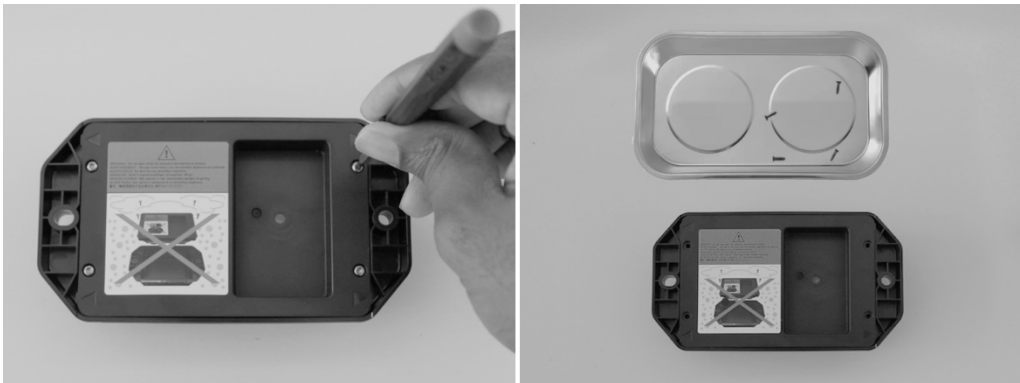

2. To separate the battery door from the outer housing—begin by inserting a flat screwdriver (3-7mm width) into a slot, marked with the arrows, and pry upwards. Complete the battery door removal by working your way around the door--inserting the screwdriver into the other slots and prying upwards, until the door is free.



3. Disconnect the battery cable from the battery connector.

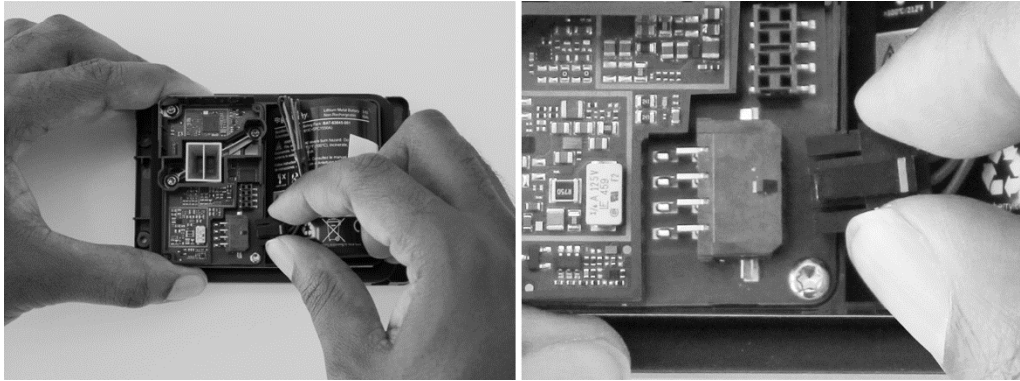

4. Remove the battery from the battery compartment by grasping the pull tab and lifting the battery out of the compartment.

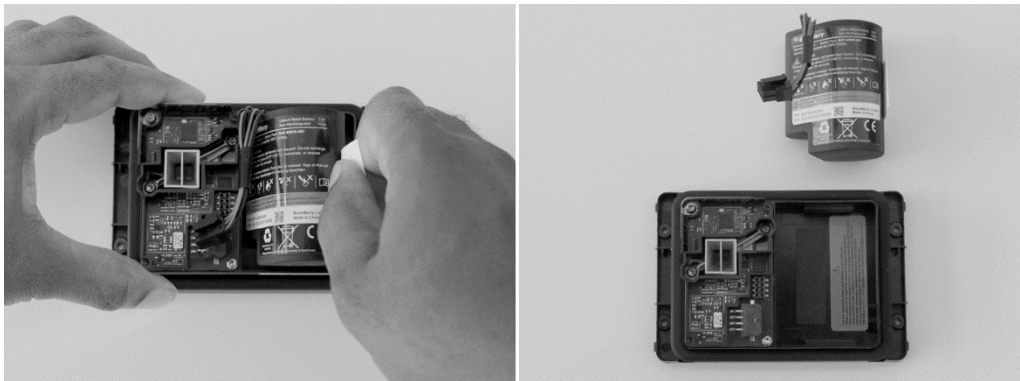

5. Without the battery installed, place the battery cover onto the module. Place the screws in the recess on the mounting flange and cover with tape. Leaving the screws uninstalled is recommended as an indicator to the recipient that there is no battery installed and must be installed before its next use. **If no battery is installed, devices may be shipped in non-Dangerous Goods packaging.**



7 Support

If you run into any problem during the installation process, contact the BlackBerry Radar support team at 1-844-RADAR-BB.

Legal notice

©2024 BlackBerry. All rights reserved. BlackBerry® and related trademarks, names, and logos are the property of BlackBerry Limited and are registered and/or used in the U.S. and countries around the world. All other trademarks are the property of their respective owners.

This documentation, including any references to third-party sources of information, hardware or software, products or services (“Third Party Products and Service”), is provided or made accessible “AS IS” and “AS AVAILABLE” and without condition, endorsement, guarantee, representation, or warranty of any kind by BlackBerry Limited and its affiliated companies (“BlackBerry”). BlackBerry assumes no responsibility for any typographical, technical, or other inaccuracies, errors, or omissions in this documentation and reserves the right to periodically change information that is contained in this documentation.

The terms of use of this documentation and any BlackBerry product or service are set out in a separate license or other agreement with BlackBerry applicable thereto. Certain features outlined in this documentation may require Third Party Products and Services and your use of Third Party Products and Services shall be governed by and subject to you agreeing to the terms of separate agreements applicable thereto with third parties.

BlackBerry Limited
2200 University Avenue East
Waterloo, Ontario
Canada N2K 0A7

Published in Canada