

FCC Test Report (Part 24 – Cat M1 B2/B25)

Report No.: RFBFKV-WTW-P23050559-3

FCC ID: L6AITH100-1

Test Model: ITH100-1

Received Date: May 23, 2023

Test Date: May 29 ~ Jun. 07, 2023

Issued Date: Jul. 07, 2023

Applicant: BlackBerry Limited

Address: 2200 University Avenue East, Waterloo, Ontario, Canada N2K 0A7

Issued By: Bureau Veritas Consumer Products Services (H.K.) Ltd., Taoyuan Branch
Lin Kou Laboratories

Lab Address: No. 47-2, 14th Ling, Chia Pau Vil., Lin Kou Dist., New Taipei City, Taiwan

Test Location (1): No. 19, Hwa Ya 2nd Rd., Wen Hwa Vil., Kwei Shan Dist., Taoyuan City
33383, Taiwan

Test Location (2): No. 70, Wenming Rd., Guishan Dist., Taoyuan City 333, Taiwan (R.O.C.)

FCC Registration /

Designation Number(1): 788550 / TW0003

FCC Registration /

Designation Number(2): 281270 / TW0032



This report is governed by, and incorporates by reference, the Conditions of Testing as posted at the date of issuance of this report at <http://www.bureauveritas.com/home/about-us/our-business/cps/about-us/terms-conditions/> and is intended for your exclusive use. Any copying or replication of this report to or for any other person or entity, or use of our name or trademark, is permitted only with our prior written permission. This report sets forth our findings solely with respect to the test samples identified herein. The results set forth in this report are not indicative or representative of the quality or characteristics of the lot from which a test sample was taken or any similar or identical product unless specifically and expressly noted. Our report includes all of the tests requested by you and the results thereof based upon the information that you provided to us. Measurement uncertainty is only provided upon request for accredited tests. Statements of conformity are based on simple acceptance criteria without taking measurement uncertainty into account, unless otherwise requested in writing. You have 60 days from date of issuance of this report to notify us of any material error or omission caused by our negligence or if you require measurement uncertainty; provided, however, that such notice shall be in writing and shall specifically address the issue you wish to raise. A failure to raise such issue within the prescribed time shall constitute your unqualified acceptance of the completeness of this report, the tests conducted and the correctness of the report contents.

Table of Contents

Release Control Record	4
1 Certificate of Conformity	5
2 Summary of Test Results	6
2.1 Measurement Uncertainty.....	6
2.2 Test Site and Instruments.....	7
3 General Information	8
3.1 General Description of EUT.....	8
3.2 Configuration of System under Test.....	10
3.2.1 Description of Support Units.....	10
3.3 Test Mode Applicability and Tested Channel Detail.....	11
3.4 EUT Operating Conditions.....	17
3.5 General Description of Applied Standards and References.....	17
4 Test Types and Results	18
4.1 Output Power Measurement.....	18
4.1.1 Limits of Output Power Measurement.....	18
4.1.2 Test Procedures.....	18
4.1.3 Test Setup.....	18
4.1.4 Test Results.....	19
4.2 Modulation Characteristics Measurement.....	27
4.2.1 Limits of Modulation Characteristics.....	27
4.2.2 Test Procedure.....	27
4.2.3 Test Setup.....	27
4.2.4 Test Results.....	28
4.3 Frequency Stability Measurement.....	29
4.3.1 Limits of Frequency Stability Measurement.....	29
4.3.2 Test Procedure.....	29
4.3.3 Test Instruments.....	29
4.3.4 Test Setup.....	29
4.3.5 Test Results.....	30
4.4 Occupied Bandwidth Measurement.....	42
4.4.1 Limits of Occupied Bandwidth Measurement.....	42
4.4.2 Test Procedure.....	42
4.4.3 Test Setup.....	42
4.4.4 Test Result.....	43
4.5 Band Edge Measurement.....	51
4.5.1 Limits of Band Edge Measurement.....	51
4.5.2 Test Setup.....	51
4.5.3 Test Procedures.....	51
4.5.4 Test Results.....	52
4.6 Peak to Average Ratio.....	64
4.6.1 Limits of Peak to Average Ratio Measurement.....	64
4.6.2 Test Setup.....	64
4.6.3 Test Procedures.....	64
4.6.4 Test Results.....	65
4.7 Conducted Spurious Emissions.....	69
4.7.1 Limits of Conducted Spurious Emissions Measurement.....	69
4.7.2 Test Setup.....	69
4.7.3 Test Procedure.....	69
4.7.4 Test Results.....	70
4.8 Radiated Emission Measurement.....	82
4.8.1 Limits of Radiated Emission Measurement.....	82
4.8.2 Test Procedure.....	82
4.8.3 Deviation from Test Standard.....	82

4.8.4 Test Setup.....	83
4.8.5 Test Results	84
Appendix – Information of the Testing Laboratories	104

Release Control Record

Issue No.	Description	Date Issued
RFBFKV-WTW-P23050559-3	Original Release	Jul. 07, 2023

1 Certificate of Conformity

Product: Radar H2M IS

Brand: BlackBerry

Test Model: ITH100-1

Sample Status: Engineering Sample

Applicant: BlackBerry Limited

Test Date: May 29 ~ Jun. 07, 2023

Standards: FCC Part 24, Subpart E

The above equipment has been tested by **Bureau Veritas Consumer Products Services (H.K.) Ltd., Taoyuan Branch**, and found compliance with the requirement of the above standards. The test record, data evaluation & Equipment Under Test (EUT) configurations represented herein are true and accurate accounts of the measurements of the sample's RF characteristics under the conditions specified in this report.

Prepared by : Pettie Chen, **Date:** Jul. 07, 2023
Pettie Chen / Senior Specialist

Approved by : Jeremy Lin, **Date:** Jul. 07, 2023
Jeremy Lin / Project Engineer

2 Summary of Test Results

Applied Standard: FCC Part 24 & Part 2			
FCC Clause	Test Item	Result	Remarks
2.1046 24.232	Equivalent Isotropically Radiated Power	Pass	Meet the requirement of limit.
2.1046 24.232 (d)	Peak To Average Ratio	Pass	Meet the requirement of limit.
2.1047	Modulation Characteristics	Pass	Meet the requirement of limit.
2.1055 24.235	Frequency Stability	Pass	Meet the requirement of limit.
2.1049	Occupied Bandwidth	Pass	Meet the requirement of limit.
24.238	Band Edge Measurements	Pass	Meet the requirement of limit.
2.1051 24.238	Conducted Spurious Emissions	Pass	Meet the requirement of limit.
2.1053 24.238	Radiated Spurious Emissions	Pass	Meet the requirement of limit. Minimum passing margin is -17.24 dB at 3765.00 MHz.

Note: Determining compliance based on the results of the compliance measurement, not taking into account measurement instrumentation uncertainty.

2.1 Measurement Uncertainty

Where relevant, the following measurement uncertainty levels have been estimated for tests performed on the EUT as specified in CISPR 16-4-2:

Measurement	Frequency	Expanded Uncertainty (k=2) (\pm)
Radiated Emissions up to 1 GHz	9kHz ~ 30MHz	3.00 dB
	30MHz ~ 200MHz	2.91 dB
	200MHz ~ 1000MHz	2.92 dB
Radiated Emissions above 1 GHz	1GHz ~ 18GHz	1.76 dB
	18GHz ~ 40GHz	1.77 dB

2.2 Test Site and Instruments

Description Manufacturer	Model No.	Serial No.	Calibrated Date	Calibrated Until
Software BV ADT	ADT_Radiated_ V7.6.15.9.5	NA	NA	NA
Antenna Tower Max-Full	MFT-151SS-0.5T	NA	NA	NA
Turn Table Max-Full	MF-7802BS	NA	NA	NA
Turn Table Controller Max-Full	MF-7802BS	MF780208674	NA	NA
EMI Test Receiver R&S	ESR3	102782	2022/12/12	2023/12/11
Signal & Spectrum Analyzer R&S	FSW43	101866	2023/1/10	2024/1/9
Loop Antenna TESEQ	HLA 6121	45745	2022/7/27	2023/7/26
Loop Antenna Electro-Metrics	EM-6879	269	2022/9/19	2023/9/18
Preamplifier EMCI	EMC001340	980201	2022/9/23	2023/9/22
RF Coaxial Cable EMCI	5D-NM-BM	140903+140902	2023/1/7	2024/1/6
Preamplifier EMCI	EMC330N	980782	2023/1/16	2024/1/15
Bi_Log Antenna Schwarzbeck	VULB 9168	9168-1213	2022/10/20	2023/10/19
RF Coaxial Cable EMCI	EMCCFD400-NM-NM-500	201233	2023/1/16	2024/1/15
RF Coaxial Cable EMCI	EMCCFD400-NM-NM-3000	201235	2023/1/16	2024/1/15
RF Coaxial Cable EMCI	EMCCFD400-NM-NM-9000	201236(with PAD)	2023/1/16	2024/1/15
Horn Antenna RFSPIN	DRH18-E	210103A18E	2022/11/13	2023/11/12
Preamplifier EMCI	EMC118A45SE	980808	2022/12/29	2023/12/28
RF Coaxial Cable EMCI	EMC104-SM-SM-1000	210102	2023/1/16	2024/1/15
RF Coaxial Cable EMCI	EMC104-SM-SM-3000	201231	2023/1/16	2024/1/15
RF Coaxial Cable EMCI	EMC104-SM-SM-9000	201243	2023/1/16	2024/1/15
Preamplifier EMCI	EMC184045SE	980788	2023/1/16	2024/1/15
Horn Antenna Schwarzbeck	BBHA 9170	9170-1049	2022/11/13	2023/11/12
RF Coaxial Cable EMCI	EMC101G-KM-KM-5000	201260	2023/1/16	2024/1/15
RF Coaxial Cable EMCI	EMC101G-KM-KM-3000	201257	2023/1/16	2024/1/15
RF Coaxial Cable EMCI	EMC101G-KM-KM-2000	201254	2023/1/16	2024/1/15
USB Wideband Power Sensor KEYSIGHT	U2021XA	MY55050005/MY55190004/ MY55190007/MY55210005	2022/7/13	2023/7/10
Boresight Antenna Fixture	FBA-01	FBA-SIP01	NA	NA

Note: 1. The calibration interval of the above test instruments is 12 months and the calibrations are traceable to NML/ROC and NIST/USA.
2. The test was performed in WM Chamber 8.

3 General Information

3.1 General Description of EUT

Product	Radar H2M IS		
Brand	BlackBerry		
Test Model	ITH100-1		
Sample Status	Engineering Sample		
Power Supply Rating	7.2Vdc from battery		
Modulation Type	QPSK, 16QAM		
Operating Frequency	Cat-M1 Band 2 (Channel Bandwidth: 1.4 MHz)	1850.7MHz ~ 1909.3MHz	
	Cat-M1 Band 2 (Channel Bandwidth: 3 MHz)	1851.5MHz ~ 1908.5MHz	
	Cat-M1 Band 2 (Channel Bandwidth: 5 MHz)	1852.5MHz ~ 1907.5MHz	
	Cat-M1 Band 2 (Channel Bandwidth: 10 MHz)	1855.0MHz ~ 1905.0MHz	
	Cat-M1 Band 2 (Channel Bandwidth: 15 MHz)	1857.5MHz ~ 1902.5MHz	
	Cat-M1 Band 2 (Channel Bandwidth: 20 MHz)	1860.0MHz ~ 1900.0MHz	
	Cat-M1 Band 25 (Channel Bandwidth: 1.4 MHz)	1850.7MHz ~ 1914.3MHz	
	Cat-M1 Band 25 (Channel Bandwidth: 3 MHz)	1851.5MHz ~ 1913.5MHz	
	Cat-M1 Band 25 (Channel Bandwidth: 5 MHz)	1852.5MHz ~ 1912.5MHz	
	Cat-M1 Band 25 (Channel Bandwidth: 10 MHz)	1855.0MHz ~ 1910.0MHz	
	Cat-M1 Band 25 (Channel Bandwidth: 15 MHz)	1857.5MHz ~ 1907.5MHz	
	Cat-M1 Band 25 (Channel Bandwidth: 20 MHz)	1860.0MHz ~ 1905.0MHz	
	Max. EIRP Power		QPSK
Cat-M1 Band 2 (Channel Bandwidth: 1.4 MHz)		457.088mW (26.60dBm)	363.078mW (25.60dBm)
Cat-M1 Band 2 (Channel Bandwidth: 3 MHz)		452.898mW (26.56dBm)	370.681mW (25.69dBm)
Cat-M1 Band 2 (Channel Bandwidth: 5 MHz)		429.536mW (26.33dBm)	404.576mW (26.07dBm)
Cat-M1 Band 2 (Channel Bandwidth: 10 MHz)		438.531mW (26.42dBm)	415.911mW (26.19dBm)
Cat-M1 Band 2 (Channel Bandwidth: 15 MHz)		453.942mW (26.57dBm)	424.620mW (26.28dBm)
Cat-M1 Band 2 (Channel Bandwidth: 20 MHz)		460.257mW (26.63dBm)	424.620mW (26.28dBm)
Cat-M1 Band 25 (Channel Bandwidth: 1.4 MHz)		415.911mW (26.19dBm)	373.250mW (25.72dBm)
Cat-M1 Band 25 (Channel Bandwidth: 3 MHz)		414.954mW (26.18dBm)	350.752mW (25.45dBm)
Cat-M1 Band 25 (Channel Bandwidth: 5 MHz)		399.025mW (26.01dBm)	368.978mW (25.67dBm)
Cat-M1 Band 25 (Channel Bandwidth: 10 MHz)		412.098mW (26.15dBm)	376.704mW (25.76dBm)
Cat-M1 Band 25 (Channel Bandwidth: 15 MHz)		411.150mW (26.14dBm)	372.392mW (25.71dBm)
Cat-M1 Band 25 (Channel Bandwidth: 20 MHz)		425.598mW (26.29dBm)	414.954mW (26.18dBm)

Emission Designator		QPSK	16QAM
	Cat-M1 Band 2 (Channel Bandwidth 1.4MHz)	1M09G7D	1M09D7W
	Cat-M1 Band 2 (Channel Bandwidth 3MHz)	1M09G7D	1M09D7W
	Cat-M1 Band 2 (Channel Bandwidth 5MHz)	1M09G7D	1M09D7W
	Cat-M1 Band 2 (Channel Bandwidth 10MHz)	1M09G7D	1M09D7W
	Cat-M1 Band 2 (Channel Bandwidth 15MHz)	1M09G7D	1M09D7W
	Cat-M1 Band 2 (Channel Bandwidth 20MHz)	1M09G7D	1M09D7W
	Cat-M1 Band 25 (Channel Bandwidth 1.4MHz)	1M09G7D	1M09D7W
	Cat-M1 Band 25 (Channel Bandwidth 3MHz)	1M08G7D	1M08D7W
	Cat-M1 Band 25 (Channel Bandwidth 5MHz)	1M09G7D	1M09D7W
	Cat-M1 Band 25 (Channel Bandwidth 10MHz)	1M10G7D	1M09D7W
	Cat-M1 Band 25 (Channel Bandwidth 15MHz)	1M09G7D	1M09D7W
	Cat-M1 Band 25 (Channel Bandwidth 20MHz)	1M09G7D	1M09D7W
Antenna Type	Refer to Note		
Antenna Connector	Refer to Note		
Accessory Device	Refer to Note		
Cable Supplied	Refer to Note		

Note:

1. The EUT consumes power from the following batteries.

Battery 1	
Brand	EVE
Model	BAT-63705-001
Power Rating	7.2V, 38Ah, 274 Wh

Battery 2	
Brand	Vitrocell
Model	BAT-63705-002
Power Rating	7.2V, 38Ah, 274 Wh

2. The antenna information for host is listed as below.

Type	Monopole with gnd resonator							
Connector	Murata MM8030-2610B/RJ3/RK0							
Antenna gain (dBi)								
Cat-M1 Band								
2	4	5	12	13	25	26	66	85
3.51	3.27	1.94	-0.33	0.69	3.51	1.94	3.84	-0.33

* Detail antenna specification please refer to antenna datasheet or an antenna gain measurement report.

3. The above EUT information is declared by manufacturer and for more detailed features description, please refer to the manufacturer's specifications or User's Manual.

3.2 Configuration of System under Test

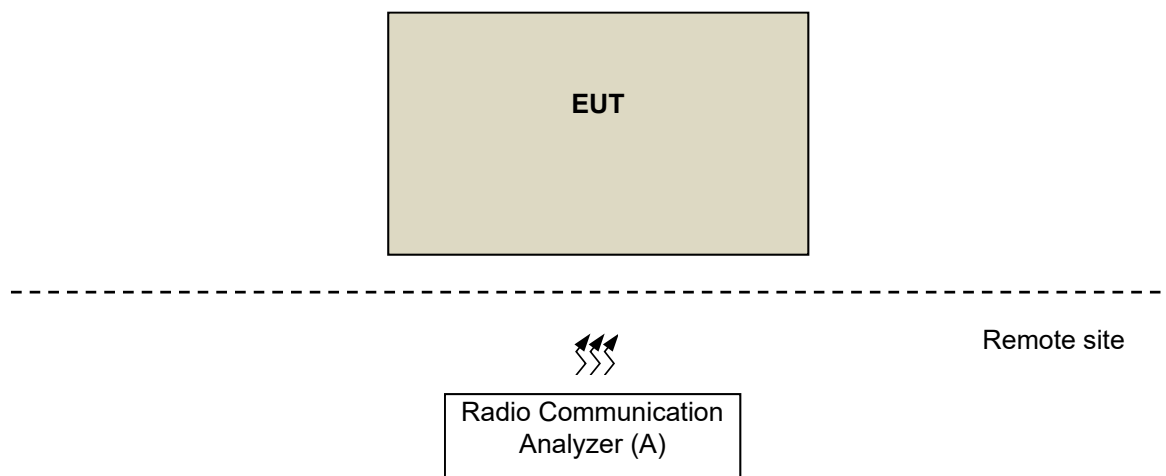

3.2.1 Description of Support Units

The EUT has been tested as an independent unit together with other necessary accessories or support units. The following support units or accessories were used to form a representative test configuration during the tests.

ID	Product	Brand	Model No.	Serial No.	FCC ID	Remarks
A	Radio Communication Analyzer	Anritsu	MT8821C	6201462755	N/A	Provided by Lab

3.3 Test Mode Applicability and Tested Channel Detail

Pre-Scan:	EUT can be used in the following ways: X-axis/ Y-axis/ Z-axis. Pre-scan these ways and find the worst case as a representative test condition.
Worst Case:	X-axis/ Y-axis/ Z-axis Worst Condition: X-axis

EUT Configure Mode	Mode	Power
	A	Power from battery 1
	B	Power from battery 2

Cat-M1 Band 2

EUT Configure Mode	Test item	Available channel	Tested Channel	Channel Bandwidth	Modulation	RB #
A	EIRP	18607 to 19193	18607 (1850.7MHz), 18900 (1880.0MHz), 19193 (1909.3MHz)	1.4MHz	QPSK / 16QAM	1 Full
		18615 to 19185	18615 (1851.5MHz), 18900 (1880.0MHz), 19185 (1908.5MHz)	3MHz	QPSK / 16QAM	1 Full
		18625 to 19175	18625 (1852.5MHz), 18900 (1880.0MHz), 19175 (1907.5MHz)	5MHz	QPSK / 16QAM	1 Full
		18650 to 19150	18650 (1855.0MHz), 18900 (1880.0MHz), 19150 (1905.0MHz)	10MHz	QPSK / 16QAM	1 Full
		18675 to 19125	18675 (1857.5MHz), 18900 (1880.0MHz), 19125 (1902.5MHz)	15MHz	QPSK / 16QAM	1 Full
		18700 to 19100	18700 (1860.0MHz), 18900 (1880.0MHz), 19100 (1900.0MHz)	20MHz	QPSK / 16QAM	1 Full
A	Modulation Characteristics	18700 to 19100	18900 (1880.0MHz)	20MHz	QPSK / 16QAM	Full
A	Frequency Stability	18607 to 19193	18607 (1850.7MHz), 19193 (1909.3MHz)	1.4MHz	QPSK	Full
		18615 to 19185	18615 (1851.5MHz), 19185 (1908.5MHz)	3MHz	QPSK	Full
		18625 to 19175	18625 (1852.5MHz), 19175 (1907.5MHz)	5MHz	QPSK	Full
		18650 to 19150	18650 (1855.0MHz), 19150 (1905.0MHz)	10MHz	QPSK	Full
		18675 to 19125	18675 (1857.5MHz), 19125 (1902.5MHz)	15MHz	QPSK	Full
		18700 to 19100	18700 (1860.0MHz), 19100 (1900.0MHz)	20MHz	QPSK	Full

EUT Configure Mode	Test item	Available channel	Tested Channel	Channel Bandwidth	Modulation	RB #
A	Occupied Bandwidth	18607 to 19193	18607 (1850.7MHz), 18900 (1880.0MHz), 19193 (1909.3MHz)	1.4MHz	QPSK / 16QAM	Full
		18615 to 19185	18615 (1851.5MHz), 18900 (1880.0MHz), 19185 (1908.5MHz)	3MHz	QPSK / 16QAM	Full
		18625 to 19175	18625 (1852.5MHz), 18900 (1880.0MHz), 19175 (1907.5MHz)	5MHz	QPSK / 16QAM	Full
		18650 to 19150	18650 (1855.0MHz), 18900 (1880.0MHz), 19150 (1905.0MHz)	10MHz	QPSK / 16QAM	Full
		18675 to 19125	18675 (1857.5MHz), 18900 (1880.0MHz), 19125 (1902.5MHz)	15MHz	QPSK / 16QAM	Full
		18700 to 19100	18700 (1860.0MHz), 18900 (1880.0MHz), 19100 (1900.0MHz)	20MHz	QPSK / 16QAM	Full
A	Band Edge	18607 to 19193	18607 (1850.7MHz), 19193 (1909.3MHz)	1.4MHz	QPSK	1 Full
		18615 to 19185	18615 (1851.5MHz), 19185 (1908.5MHz)	3MHz	QPSK	1 Full
		18625 to 19175	18625 (1852.5MHz), 19175 (1907.5MHz)	5MHz	QPSK	1 Full
		18650 to 19150	18650 (1855.0MHz), 19150 (1905.0MHz)	10MHz	QPSK	1 Full
		18675 to 19125	18675 (1857.5MHz), 19125 (1902.5MHz)	15MHz	QPSK	1 Full
		18700 to 19100	18700 (1860.0MHz), 19100 (1900.0MHz)	20MHz	QPSK	1 Full

EUT Configure Mode	Test item	Available channel	Tested Channel	Channel Bandwidth	Modulation	RB #
A	Peak to Average Ratio	18607 to 19193	18607 (1850.7MHz), 18900 (1880.0MHz), 19193 (1909.3MHz)	1.4MHz	QPSK / 16QAM	1
		18615 to 19185	18615 (1851.5MHz), 18900 (1880.0MHz), 19185 (1908.5MHz)	3MHz	QPSK / 16QAM	1
		18625 to 19175	18625 (1852.5MHz), 18900 (1880.0MHz), 19175 (1907.5MHz)	5MHz	QPSK / 16QAM	1
		18650 to 19150	18650 (1855.0MHz), 18900 (1880.0MHz), 19150 (1905.0MHz)	10MHz	QPSK / 16QAM	1
		18675 to 19125	18675 (1857.5MHz), 18900 (1880.0MHz), 19125 (1902.5MHz)	15MHz	QPSK / 16QAM	1
		18700 to 19100	18700 (1860.0MHz), 18900 (1880.0MHz), 19100 (1900.0MHz)	20MHz	QPSK / 16QAM	1
A	Conducted Emission	18607 to 19193	18607 (1850.7MHz), 18900 (1880.0MHz), 19193 (1909.3MHz)	1.4MHz	QPSK	1
		18615 to 19185	18615 (1851.5MHz), 18900 (1880.0MHz), 19185 (1908.5MHz)	3MHz	QPSK	1
		18625 to 19175	18625 (1852.5MHz), 18900 (1880.0MHz), 19175 (1907.5MHz)	5MHz	QPSK	1
		18650 to 19150	18650 (1855.0MHz), 18900 (1880.0MHz), 19150 (1905.0MHz)	10MHz	QPSK	1
		18675 to 19125	18675 (1857.5MHz), 18900 (1880.0MHz), 19125 (1902.5MHz)	15MHz	QPSK	1
		18700 to 19100	18700 (1860.0MHz), 18900 (1880.0MHz), 19100 (1900.0MHz)	20MHz	QPSK	1
A, B	Radiated Emission Below 1GHz	18700 to 19100	18900 (1880.0MHz)	20MHz	QPSK	1
A	Radiated Emission Above 1GHz	18607 to 19193	18607 (1850.7MHz), 18900 (1880.0MHz), 19193 (1909.3MHz)	1.4MHz	QPSK	1
		18625 to 19175	18625 (1852.5MHz), 18900 (1880.0MHz), 19175 (1907.5MHz)	5MHz	QPSK	1
		18700 to 19100	18700 (1860.0MHz), 18900 (1880.0MHz), 19100 (1900.0MHz)	20MHz	QPSK	1

Note:

1. This device was tested under all bandwidths, RB configurations and modulations. The worst case was found in QPSK modulation. Therefore, only EIRP, modulation characteristics, occupied bandwidth and peak to average ratio items had been tested under QPSK, 16QAM mode, the other items were performed under QPSK mode only.

2. For radiated emission below 1GHz, select the worst radiated emission channel (above 1GHz) for final testing.
3. For radiated emission above 1GHz, according to 3GPP 36.521 Section 6.6.3.1.4, choose the lowest, 5MHz & highest channel bandwidth for final test.

Cat-M1 Band 25

EUT Configure Mode	Test item	Available channel	Tested Channel	Channel Bandwidth	Modulation	RB #
A	EIRP	26047 to 26683	26047 (1850.7MHz), 26365 (1882.5MHz), 26683 (1914.3MHz)	1.4MHz	QPSK / 16QAM	1 Full
		26055 to 26675	26055 (1851.5MHz), 26365 (1882.5MHz), 26675 (1913.5MHz)	3MHz	QPSK / 16QAM	1 Full
		26065 to 26665	26065 (1852.5MHz), 26365 (1882.5MHz), 26665 (1912.5MHz)	5MHz	QPSK / 16QAM	1 Full
		26090 to 26640	26090 (1855.0MHz), 26365 (1882.5MHz), 26640 (1910.0MHz)	10MHz	QPSK / 16QAM	1 Full
		26115 to 26615	26115 (1857.5MHz), 26365 (1882.5MHz), 26615 (1907.5MHz)	15MHz	QPSK / 16QAM	1 Full
		26140 to 26590	26140 (1860.0MHz), 26365 (1882.5MHz), 26590 (1905.0MHz)	20MHz	QPSK / 16QAM	1 Full
A	Modulation Characteristics	26140 to 26590	26365 (1882.5MHz)	20MHz	QPSK / 16QAM	Full
A	Frequency Stability	26047 to 26683	26047 (1850.7MHz), 26683 (1914.3MHz)	1.4MHz	QPSK	Full
		26055 to 26675	26055 (1851.5MHz), 26675 (1913.5MHz)	3MHz	QPSK	Full
		26065 to 26665	26065 (1852.5MHz), 26665 (1912.5MHz)	5MHz	QPSK	Full
		26090 to 26640	26090 (1855.0MHz), 26640 (1910.0MHz)	10MHz	QPSK	Full
		26115 to 26615	26115 (1857.5MHz), 26615 (1907.5MHz)	15MHz	QPSK	Full
		26140 to 26590	26140 (1860.0MHz), 26590 (1905.0MHz)	20MHz	QPSK	Full

EUT Configure Mode	Test item	Available channel	Tested Channel	Channel Bandwidth	Modulation	RB #
A	Occupied Bandwidth	26047 to 26683	26047 (1850.7MHz), 26365 (1882.5MHz), 26683 (1914.3MHz)	1.4MHz	QPSK / 16QAM	Full
		26055 to 26675	26055 (1851.5MHz), 26365 (1882.5MHz), 26675 (1913.5MHz)	3MHz	QPSK / 16QAM	Full
		26065 to 26665	26065 (1852.5MHz), 26365 (1882.5MHz), 26665 (1912.5MHz)	5MHz	QPSK / 16QAM	Full
		26090 to 26640	26090 (1855.0MHz), 26365 (1882.5MHz), 26640 (1910.0MHz)	10MHz	QPSK / 16QAM	Full
		26115 to 26615	26115 (1857.5MHz), 26365 (1882.5MHz), 26615 (1907.5MHz)	15MHz	QPSK / 16QAM	Full
		26140 to 26590	26140 (1860.0MHz), 26365 (1882.5MHz), 26590 (1905.0MHz)	20MHz	QPSK / 16QAM	Full
A	Band Edge	26047 to 26683	26047 (1850.7MHz), 26683 (1914.3MHz)	1.4MHz	QPSK	1 Full
		26055 to 26675	26055 (1851.5MHz), 26675 (1913.5MHz)	3MHz	QPSK	1 Full
		26065 to 26665	26065 (1852.5MHz), 26665 (1912.5MHz)	5MHz	QPSK	1 Full
		26090 to 26640	26090 (1855.0MHz), 26640 (1910.0MHz)	10MHz	QPSK	1 Full
		26115 to 26615	26115 (1857.5MHz), 26615 (1907.5MHz)	15MHz	QPSK	1 Full
		26140 to 26590	26140 (1860.0MHz), 26590 (1905.0MHz)	20MHz	QPSK	1 Full
A	Peak to Average Ratio	26047 to 26683	26047 (1850.7MHz), 26365 (1882.5MHz), 26683 (1914.3MHz)	1.4MHz	QPSK / 16QAM	1
		26055 to 26675	26055 (1851.5MHz), 26365 (1882.5MHz), 26675 (1913.5MHz)	3MHz	QPSK / 16QAM	1
		26065 to 26665	26065 (1852.5MHz), 26365 (1882.5MHz), 26665 (1912.5MHz)	5MHz	QPSK / 16QAM	1
		26090 to 26640	26090 (1855.0MHz), 26365 (1882.5MHz), 26640 (1910.0MHz)	10MHz	QPSK / 16QAM	1
		26115 to 26615	26115 (1857.5MHz), 26365 (1882.5MHz), 26615 (1907.5MHz)	15MHz	QPSK / 16QAM	1
		26140 to 26590	26140 (1860.0MHz), 26365 (1882.5MHz), 26590 (1905.0MHz)	20MHz	QPSK / 16QAM	1

EUT Configure Mode	Test item	Available channel	Tested Channel	Channel Bandwidth	Modulation	RB #
A	Conducted Emission	26047 to 26683	26047 (1850.7MHz), 26365 (1882.5MHz), 26683 (1914.3MHz)	1.4MHz	QPSK	1
		26055 to 26675	26055 (1851.5MHz), 26365 (1882.5MHz), 26675 (1913.5MHz)	3MHz	QPSK	1
		26065 to 26665	26065 (1852.5MHz), 26365 (1882.5MHz), 26665 (1912.5MHz)	5MHz	QPSK	1
		26090 to 26640	26090 (1855.0MHz), 26365 (1882.5MHz), 26640 (1910.0MHz)	10MHz	QPSK	1
		26115 to 26615	26115 (1857.5MHz), 26365 (1882.5MHz), 26615 (1907.5MHz)	15MHz	QPSK	1
		26140 to 26590	26140 (1860.0MHz), 26365 (1882.5MHz), 26590 (1905.0MHz)	20MHz	QPSK	1
A, B	Radiated Emission Below 1GHz	26140 to 26590	26365 (1882.5MHz)	20MHz	QPSK	1
A	Radiated Emission Above 1GHz	26047 to 26683	26047 (1850.7MHz), 26365 (1882.5MHz), 26683 (1914.3MHz)	1.4MHz	QPSK	1
		26065 to 26665	26065 (1852.5MHz), 26365 (1882.5MHz), 26665 (1912.5MHz)	5MHz	QPSK	1
		26140 to 26590	26140 (1860.0MHz), 26365 (1882.5MHz), 26590 (1905.0MHz)	20MHz	QPSK	1

Note:

1. This device was tested under all bandwidths, RB configurations and modulations. The worst case was found in QPSK modulation. Therefore, only EIRP, modulation characteristics, occupied bandwidth and peak to average ratio items had been tested under QPSK, 16QAM mode, the other items were performed under QPSK mode only.
2. For radiated emission below 1GHz, select the worst radiated emission channel (above 1GHz) for final testing.
3. For radiated emission above 1GHz, according to 3GPP 36.521 Section 6.6.3.1.4, choose the lowest, 5MHz & highest channel bandwidth for final test.

Test Condition:

Test Item	Environmental Conditions	Input Power	Tested By
EIRP	25deg. C, 60%RH	7.2Vdc	Willy Cheng
Modulation Characteristics	25deg. C, 60%RH	7.2Vdc	Willy Cheng
Frequency Stability	25deg. C, 60%RH	7.2Vdc	Willy Cheng
Occupied Bandwidth	25deg. C, 60%RH	7.2Vdc	Willy Cheng
Band Edge	25deg. C, 60%RH	7.2Vdc	Willy Cheng
Peak To Average Ratio	25deg. C, 60%RH	7.2Vdc	Willy Cheng
Radiated Emission Below 1GHz	25deg. C, 60%RH	7.2Vdc	Willy Cheng
Radiated Emission Above 1GHz	20deg. C, 64%RH	7.2Vdc	Edison Lee

3.4 EUT Operating Conditions

The EUT makes a call to the communication simulator. The communication simulator station system controlled a EUT to export maximum output power under transmission mode and specific channel frequency

3.5 General Description of Applied Standards and References

The EUT is a RF Product. According to the specifications of the manufacturer, it must comply with the requirements of the following standards:

Test Standard:

FCC 47 CFR Part 2

FCC 47 CFR Part 24

ANSI/TIA/EIA-603-E 2016

ANSI 63.26-2015

References Test Guidance:

KDB 971168 D01 Power Meas License Digital Systems v03r01

All test items have been performed and recorded as per the above standards.

4 Test Types and Results

4.1 Output Power Measurement

4.1.1 Limits of Output Power Measurement

Mobile / Portable station are limited to 2 watts e.i.r.p.

4.1.2 Test Procedures

Conducted Power Measurement:

The EUT was set up for the maximum power with Cat-M1 link data modulation and link up with simulator (Built-in power meter). The average (rms) power measurement was performed on emulator and power value was measured from power function on emulator. Set the EUT to transmit under low, middle and high channel and record the power level shown on simulator.

Maximum EIRP / ERP

The relevant equation for determining the maximum ERP or EIRP from the measured RF output power is

given in Equation as follows:

$$\text{EIRP} = P_{\text{Meas}} + G_{\text{T}}$$

$$\text{ERP} = P_{\text{Meas}} + G_{\text{T}} - 2.15$$

where

ERP or EIRP effective radiated power or equivalent isotropically radiated power, respectively (expressed in the same units as P_{Meas} , e.g., dBm or dBW)

P_{Meas} measured transmitter output power or PSD, in dBm or dBW

G_{T} gain of the transmitting antenna, in dBd (ERP) or dBi (EIRP)

4.1.3 Test Setup

Conducted Power Measurement:



4.1.4 Test Results

Conducted Output Power (dBm)

Cat-M1 Band 2						
BW	MCS Index	RB Size	RB Offset	Low	Mid	High
		Channel		18607	18900	19193
		Frequency (MHz)		1850.7	1880	1909.3
1.4M	QPSK	1	0	23.04	23.09	23.01
		1	5	22.92	22.90	22.89
		6	0	20.84	21.02	20.97
	16QAM	1	0	22.01	22.04	22.09
		1	5	21.89	21.93	21.91
		6	0	20.01	20.14	20.07
BW	MCS Index	RB Size	RB Offset	Low	Mid	High
		Channel		18615	18900	19185
		Frequency (MHz)		1851.5	1880	1908.5
3M	QPSK	1	0	22.98	23.02	23.05
		1	5	22.95	23.00	22.93
		6	0	20.99	20.96	21.08
	16QAM	1	0	22.09	22.18	22.16
		1	5	21.94	22.04	22.01
		6	0	20.02	20.05	20.13
BW	MCS Index	RB Size	RB Offset	Low	Mid	High
		Channel		18625	18900	19175
		Frequency (MHz)		1852.5	1880	1907.5
5M	QPSK	1	0	22.82	22.80	22.73
		1	5	22.75	22.66	22.66
		6	0	22.03	22.02	22.08
	16QAM	1	0	22.56	22.56	22.54
		1	5	22.52	22.51	22.50
		6	0	22.07	22.12	22.16

Cat-M1 Band 2						
BW	MCS Index	RB Size	RB Offset	Low	Mid	High
		Channel		18650	18900	19150
		Frequency (MHz)		1855	1880	1905
10M	QPSK	1	0	22.79	22.91	22.78
		1	5	22.67	22.66	22.57
		6	0	22.03	22.06	22.01
	16QAM	1	0	22.68	22.62	22.64
		1	5	22.42	22.43	22.37
		6	0	22.06	22.11	22.08
BW	MCS Index	RB Size	RB Offset	Low	Mid	High
		Channel		18675	18900	19125
		Frequency (MHz)		1857.5	1880	1902.5
15M	QPSK	1	0	22.88	22.85	22.80
		1	5	22.74	22.79	22.60
		6	0	23.04	23.06	22.97
	16QAM	1	0	22.57	22.59	22.77
		1	5	22.38	22.40	22.36
		6	0	21.99	21.94	21.88
BW	MCS Index	RB Size	RB Offset	Low	Mid	High
		Channel		18700	18900	19100
		Frequency (MHz)		1860	1880	1900
20M	QPSK	1	0	23.04	23.12	22.93
		1	5	22.81	22.76	22.74
		6	0	22.97	23.02	23.06
	16QAM	1	0	22.70	22.73	22.77
		1	5	22.59	22.61	22.59
		6	0	21.95	21.92	22.14

Cat-M1 Band 25						
BW	MCS Index	RB Size	RB Offset	Low	Mid	High
		Channel		26047	26365	26683
		Frequency (MHz)		1850.7	1882.5	1914.3
1.4M	QPSK	1	0	22.55	22.62	22.68
		1	5	22.44	22.56	22.59
		6	0	20.48	20.65	20.72
	16QAM	1	0	21.48	21.69	22.21
		1	5	21.29	21.58	21.68
		6	0	19.44	19.52	19.79
BW	MCS Index	RB Size	RB Offset	Low	Mid	High
		Channel		26055	26365	26675
		Frequency (MHz)		1851.5	1882.5	1913.5
3M	QPSK	1	0	22.62	22.65	22.62
		1	5	22.50	22.62	22.67
		6	0	20.49	20.74	20.80
	16QAM	1	0	21.63	21.85	21.94
		1	5	21.47	21.70	21.79
		6	0	19.52	19.86	19.83
BW	MCS Index	RB Size	RB Offset	Low	Mid	High
		Channel		26065	26365	26665
		Frequency (MHz)		1852.5	1882.5	1912.5
5M	QPSK	1	0	22.33	22.50	22.48
		1	5	22.12	22.32	22.31
		6	0	21.48	21.76	21.75
	16QAM	1	0	21.87	22.07	22.10
		1	5	21.80	22.16	22.14
		6	0	20.95	21.22	21.42

Cat-M1 Band 25						
BW	MCS Index	RB Size	RB Offset	Low	Mid	High
		Channel		26090	26365	26640
		Frequency (MHz)		1855	1882.5	1910
10M	QPSK	1	0	22.54	22.64	22.59
		1	5	22.14	22.56	22.51
		6	0	21.59	21.78	21.77
	16QAM	1	0	22.03	22.20	22.25
		1	5	21.82	22.00	22.05
		6	0	21.13	21.09	21.17
BW	MCS Index	RB Size	RB Offset	Low	Mid	High
		Channel		26115	26365	26615
		Frequency (MHz)		1857.5	1882.5	1907.5
15M	QPSK	1	0	22.38	22.63	22.55
		1	5	22.15	22.52	22.22
		6	0	21.53	21.79	21.70
	16QAM	1	0	22.04	22.20	22.17
		1	5	21.84	22.04	21.97
		6	0	21.19	21.23	21.34
BW	MCS Index	RB Size	RB Offset	Low	Mid	High
		Channel		26140	26365	26590
		Frequency (MHz)		1860	1882.5	1905
20M	QPSK	1	0	22.48	22.62	22.78
		1	5	22.05	22.23	22.27
		6	0	22.59	22.75	22.71
	16QAM	1	0	22.14	22.24	22.32
		1	5	21.92	22.02	22.19
		6	0	22.47	22.53	22.67

EIRP Power (dBm)

Cat-M1 Band 2						
BW	MCS Index	RB Size	RB Offset	Low	Mid	High
		Channel		18607	18900	19193
		Frequency (MHz)		1850.7	1880	1909.3
1.4M	QPSK	1	0	26.55	26.60	26.52
		1	5	26.43	26.41	26.40
		6	0	24.35	24.53	24.48
	16QAM	1	0	25.52	25.55	25.60
		1	5	25.40	25.44	25.42
		6	0	23.52	23.65	23.58
BW	MCS Index	RB Size	RB Offset	Low	Mid	High
		Channel		18615	18900	19185
		Frequency (MHz)		1851.5	1880	1908.5
3M	QPSK	1	0	26.49	26.53	26.56
		1	5	26.46	26.51	26.44
		6	0	24.50	24.47	24.59
	16QAM	1	0	25.60	25.69	25.67
		1	5	25.45	25.55	25.52
		6	0	23.53	23.56	23.64
BW	MCS Index	RB Size	RB Offset	Low	Mid	High
		Channel		18625	18900	19175
		Frequency (MHz)		1852.5	1880	1907.5
5M	QPSK	1	0	26.33	26.31	26.24
		1	5	26.26	26.17	26.17
		6	0	25.54	25.53	25.59
	16QAM	1	0	26.07	26.07	26.05
		1	5	26.03	26.02	26.01
		6	0	25.58	25.63	25.67

*EIRP = Conducted + antenna gain (3.51dBi)

Cat-M1 Band 2						
BW	MCS Index	RB Size	RB Offset	Low	Mid	High
		Channel		18650	18900	19150
		Frequency (MHz)		1855	1880	1905
10M	QPSK	1	0	26.30	26.42	26.29
		1	5	26.18	26.17	26.08
		6	0	25.54	25.57	25.52
	16QAM	1	0	26.19	26.13	26.15
		1	5	25.93	25.94	25.88
		6	0	25.57	25.62	25.59
BW	MCS Index	RB Size	RB Offset	Low	Mid	High
		Channel		18675	18900	19125
		Frequency (MHz)		1857.5	1880	1902.5
15M	QPSK	1	0	26.39	26.36	26.31
		1	5	26.25	26.30	26.11
		6	0	26.55	26.57	26.48
	16QAM	1	0	26.08	26.10	26.28
		1	5	25.89	25.91	25.87
		6	0	25.50	25.45	25.39
BW	MCS Index	RB Size	RB Offset	Low	Mid	High
		Channel		18700	18900	19100
		Frequency (MHz)		1860	1880	1900
20M	QPSK	1	0	26.55	26.63	26.44
		1	5	26.32	26.27	26.25
		6	0	26.48	26.53	26.57
	16QAM	1	0	26.21	26.24	26.28
		1	5	26.10	26.12	26.10
		6	0	25.46	25.43	25.65

*EIRP = Conducted + antenna gain (3.51dBi)

Cat-M1 Band 25						
BW	MCS Index	RB Size	RB Offset	Low	Mid	High
		Channel		26047	26365	26683
		Frequency (MHz)		1850.7	1882.5	1914.3
1.4M	QPSK	1	0	26.06	26.13	26.19
		1	5	25.95	26.07	26.10
		6	0	23.99	24.16	24.23
	16QAM	1	0	24.99	25.20	25.72
		1	5	24.80	25.09	25.19
		6	0	22.95	23.03	23.30
BW	MCS Index	RB Size	RB Offset	Low	Mid	High
		Channel		26055	26365	26675
		Frequency (MHz)		1851.5	1882.5	1913.5
3M	QPSK	1	0	26.13	26.16	26.13
		1	5	26.01	26.13	26.18
		6	0	24.00	24.25	24.31
	16QAM	1	0	25.14	25.36	25.45
		1	5	24.98	25.21	25.30
		6	0	23.03	23.37	23.34
BW	MCS Index	RB Size	RB Offset	Low	Mid	High
		Channel		26065	26365	26665
		Frequency (MHz)		1852.5	1882.5	1912.5
5M	QPSK	1	0	25.84	26.01	25.99
		1	5	25.63	25.83	25.82
		6	0	24.99	25.27	25.26
	16QAM	1	0	25.38	25.58	25.61
		1	5	25.31	25.67	25.65
		6	0	24.46	24.73	24.93

*EIRP = Conducted + antenna gain (3.51dBi)

Cat-M1 Band 25						
BW	MCS Index	RB Size	RB Offset	Low	Mid	High
		Channel		26090	26365	26640
		Frequency (MHz)		1855	1882.5	1910
10M	QPSK	1	0	26.05	26.15	26.10
		1	5	25.65	26.07	26.02
		6	0	25.10	25.29	25.28
	16QAM	1	0	25.54	25.71	25.76
		1	5	25.33	25.51	25.56
		6	0	24.64	24.60	24.68
BW	MCS Index	RB Size	RB Offset	Low	Mid	High
		Channel		26115	26365	26615
		Frequency (MHz)		1857.5	1882.5	1907.5
15M	QPSK	1	0	25.89	26.14	26.06
		1	5	25.66	26.03	25.73
		6	0	25.04	25.30	25.21
	16QAM	1	0	25.55	25.71	25.68
		1	5	25.35	25.55	25.48
		6	0	24.70	24.74	24.85
BW	MCS Index	RB Size	RB Offset	Low	Mid	High
		Channel		26140	26365	26590
		Frequency (MHz)		1860	1882.5	1905
20M	QPSK	1	0	25.99	26.13	26.29
		1	5	25.56	25.74	25.78
		6	0	26.10	26.26	26.22
	16QAM	1	0	25.65	25.75	25.83
		1	5	25.43	25.53	25.70
		6	0	25.98	26.04	26.18

*EIRP = Conducted + antenna gain (3.51dBi)

4.2 Modulation Characteristics Measurement

4.2.1 Limits of Modulation Characteristics

N/A

4.2.2 Test Procedure

Connect the EUT to Communication Simulator via the antenna connector. The frequency band is set as EUT supported Modulation and Channels, the EUT output is matched with 50 ohm load, the waveform quality and constellation of the EUT was tested.

4.2.3 Test Setup

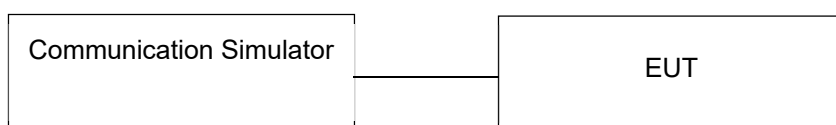

4.2.4 Test Results

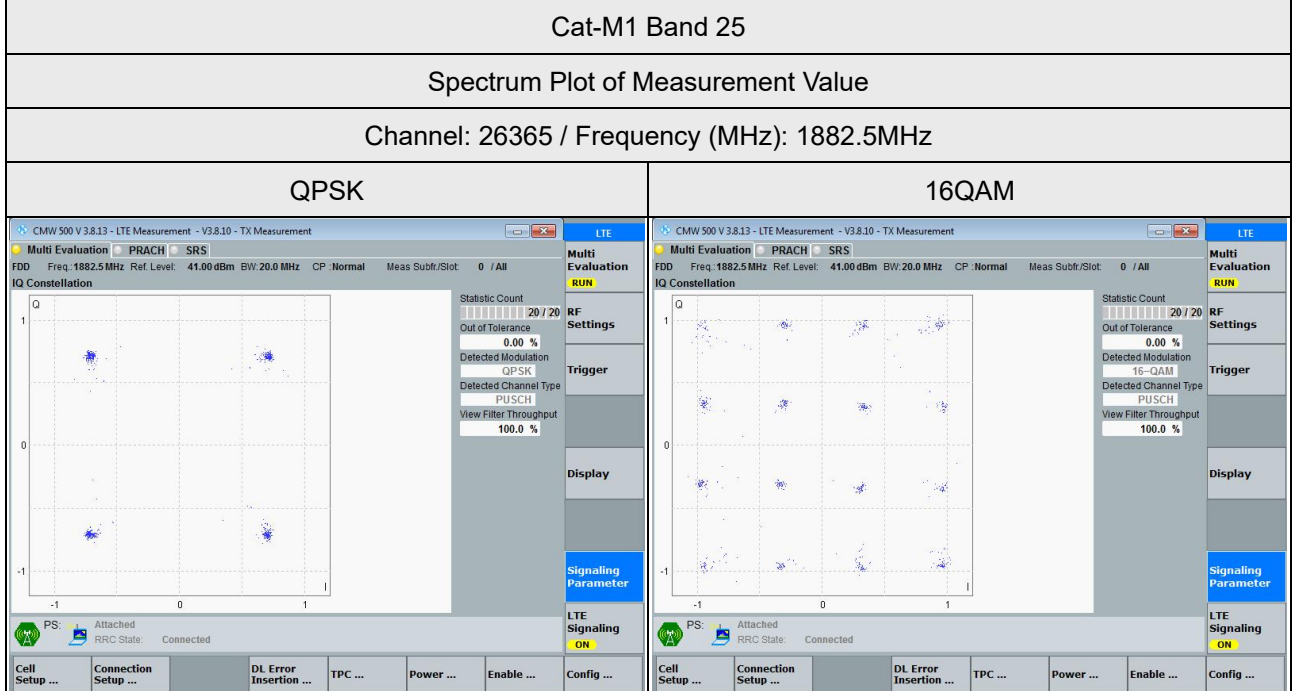
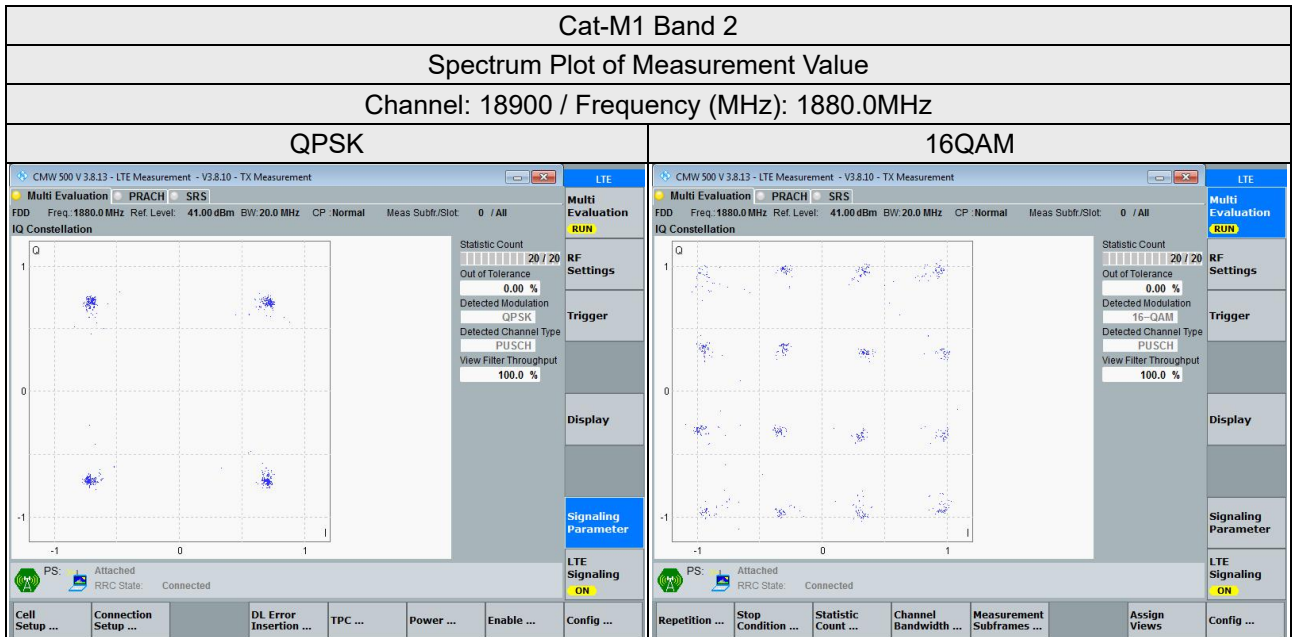

4.3 Frequency Stability Measurement

4.3.1 Limits of Frequency Stability Measurement

The frequency stability shall be sufficient to ensure that the fundamental emission stays within the authorized frequency block.

4.3.2 Test Procedure

- a. Device is placed at the oven room. The oven room could control the temperatures and humidity. Power warm up is at least 15 min and power applied should perform before recording frequency error.
- b. EUT is connected the external power supply to control the DC input power. The test voltage range is from minimum to maximum working voltage. Each step shall be record the frequency error rate.
- c. The temperature range step is 10 degrees in this test items. All temperature levels shall be hold the ± 0.5 °C during the measurement testing. The each temperature step shall be at least 0.5 hours, consider the EUT could be test under the stability condition.

Note: The frequency error was recorded frequency error from the communication simulator.

4.3.3 Test Instruments

Description & Manufacturer	Model No.	Serial No.	Cal. Date	Cal. Due
Radio Communication Analyzer Anritsu	MT8821C	6261806803	Feb. 18, 2023	Feb. 17, 2024
Temperature & Humidity Chamber TERCHY	HRM-120RF	931022	Dec. 27, 2022	Dec. 26, 2023
Digital Multimeter Fluke	87-III	70360742	Jun. 23, 2022	Jun. 22, 2023
DC Power Supply Topward	6306A	727263	NA	NA

Note: 1. The calibration interval of the above test instruments is 12 months and the calibrations are traceable to NML/ROC and NIST/USA.

4.3.4 Test Setup

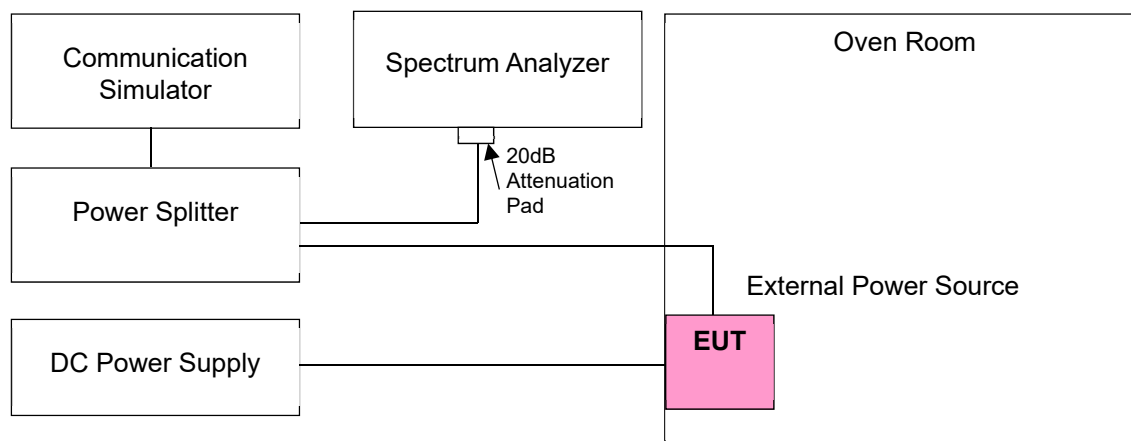

4.3.5 Test Results

Frequency Error vs. Voltage

Voltage (Vdc)	Cat-M1 Band 2			
	Channel Bandwidth 1.4 MHz			
	Low Channel		High Channel	
	Frequency (MHz)	Frequency Error (ppm)	Frequency (MHz)	Frequency Error (ppm)
6.12	1850.699997	-0.002	1909.300000	-0.002
7.2	1850.699996	-0.002	1909.300002	0.001
8.28	1850.700004	0.002	1909.300004	0.002

Note: The applicant defined the normal working voltage is from 6.12Vdc to 8.28Vdc.

Frequency Error vs. Temperature

Temp. (°C)	Cat-M1 Band 2			
	Channel Bandwidth 1.4 MHz			
	Low Channel		High Channel	
	Frequency (MHz)	Frequency Error (ppm)	Frequency (MHz)	Frequency Error (ppm)
-40	1850.6999960	-0.002	1909.2999960	-0.002
-30	1850.7000040	0.002	1909.3000040	0.002
-20	1850.6999980	-0.001	1909.2999960	-0.002
-10	1850.6999980	-0.001	1909.3000030	0.002
0	1850.6999990	-0.001	1909.2999970	-0.002
10	1850.6999960	-0.002	1909.2999970	-0.002
20	1850.7000020	0.001	1909.3000010	0.001
30	1850.6999990	-0.001	1909.3000030	0.002
40	1850.7000020	0.001	1909.3000040	0.002
50	1850.6999960	-0.002	1909.3000040	0.002
60	1850.7000020	0.001	1909.2999990	-0.001
70	1850.6999990	-0.001	1909.2999980	-0.001

Frequency Error vs. Voltage

Voltage (Vdc)	Cat-M1 Band 2			
	Channel Bandwidth 3MHz			
	Low Channel		High Channel	
	Frequency (MHz)	Frequency Error (ppm)	Frequency (MHz)	Frequency Error (ppm)
6.12	1851.500001	0.001	1908.500003	0.002
7.2	1851.499999	-0.001	1908.500004	0.002
8.28	1851.499996	-0.002	1908.499996	-0.002

Note: The applicant defined the normal working voltage is from 6.12Vdc to 8.28Vdc.

Frequency Error vs. Temperature

Temp. (°C)	Cat-M1 Band 2			
	Channel Bandwidth 3MHz			
	Low Channel		High Channel	
	Frequency (MHz)	Frequency Error (ppm)	Frequency (MHz)	Frequency Error (ppm)
-40	1851.5000020	0.001	1908.4999980	-0.001
-30	1851.5000040	0.002	1908.5000020	0.001
-20	1851.5000040	0.002	1908.5000040	0.002
-10	1851.4999960	-0.002	1908.5000040	0.002
0	1851.4999960	-0.002	1908.4999990	-0.001
10	1851.4999970	-0.002	1908.5000010	0.001
20	1851.4999970	-0.002	1908.5000020	0.001
30	1851.4999960	-0.002	1908.5000020	0.001
40	1851.4999990	-0.001	1908.5000010	0.001
50	1851.4999980	-0.001	1908.5000010	0.001
60	1851.4999990	-0.001	1908.5000020	0.001
70	1851.4999990	-0.001	1908.4999970	-0.002

Frequency Error vs. Voltage

Voltage (Vdc)	Cat-M1 Band 2			
	Channel Bandwidth 5 MHz			
	Low Channel		High Channel	
	Frequency (MHz)	Frequency Error (ppm)	Frequency (MHz)	Frequency Error (ppm)
6.12	1852.499996	-0.002	1907.500002	0.001
7.2	1852.500002	0.001	1907.500003	0.002
8.28	1852.499998	-0.001	1907.499996	-0.002

Note: The applicant defined the normal working voltage is from 6.12Vdc to 8.28Vdc.

Frequency Error vs. Temperature

Temp. (°C)	Cat-M1 Band 2			
	Channel Bandwidth 5 MHz			
	Low Channel		High Channel	
	Frequency (MHz)	Frequency Error (ppm)	Frequency (MHz)	Frequency Error (ppm)
-40	1852.4999980	-0.001	1907.4999990	-0.001
-30	1852.4999970	-0.002	1907.5000010	0.001
-20	1852.5000020	0.001	1907.4999990	-0.001
-10	1852.4999980	-0.001	1907.5000030	0.002
0	1852.5000010	0.001	1907.5000010	0.001
10	1852.5000020	0.001	1907.5000030	0.002
20	1852.4999970	-0.002	1907.4999990	-0.001
30	1852.4999990	-0.001	1907.4999970	-0.002
40	1852.5000010	0.001	1907.4999970	-0.002
50	1852.5000010	0.001	1907.5000040	0.002
60	1852.4999990	-0.001	1907.4999960	-0.002
70	1852.4999970	-0.002	1907.4999970	-0.002

Frequency Error vs. Voltage

Voltage (Vdc)	Cat-M1 Band 2			
	Channel Bandwidth 10 MHz			
	Low Channel		High Channel	
	Frequency (MHz)	Frequency Error (ppm)	Frequency (MHz)	Frequency Error (ppm)
6.12	1854.999998	-0.001	1904.999999	-0.001
7.2	1854.999996	-0.002	1905.000002	0.001
8.28	1855.000001	0.001	1904.999997	-0.002

Note: The applicant defined the normal working voltage is from 6.12Vdc to 8.28Vdc.

Frequency Error vs. Temperature

Temp. (°C)	Cat-M1 Band 2			
	Channel Bandwidth 10 MHz			
	Low Channel		High Channel	
	Frequency (MHz)	Frequency Error (ppm)	Frequency (MHz)	Frequency Error (ppm)
-40	1854.9999970	-0.002	1904.9999960	-0.002
-30	1855.0000020	0.001	1905.0000030	0.002
-20	1855.0000010	0.001	1904.9999980	-0.001
-10	1854.9999990	-0.001	1904.9999980	-0.001
0	1855.0000020	0.001	1904.9999960	-0.002
10	1854.9999970	-0.002	1905.0000030	0.002
20	1855.0000040	0.002	1905.0000020	0.001
30	1855.0000020	0.001	1904.9999990	-0.001
40	1854.9999970	-0.002	1904.9999960	-0.002
50	1854.9999980	-0.001	1904.9999970	-0.002
60	1854.9999990	-0.001	1904.9999990	-0.001
70	1854.9999990	-0.001	1905.0000010	0.001

Frequency Error vs. Voltage

Voltage (Vdc)	Cat-M1 Band 2			
	Channel Bandwidth 15 MHz			
	Low Channel		High Channel	
	Frequency (MHz)	Frequency Error (ppm)	Frequency (MHz)	Frequency Error (ppm)
6.12	1857.500001	0.001	1902.499996	-0.002
7.2	1857.499999	-0.001	1902.499999	-0.001
8.28	1857.499997	-0.002	1902.499998	-0.001

Note: The applicant defined the normal working voltage is from 6.12Vdc to 8.28Vdc.

Frequency Error vs. Temperature

Temp. (°C)	Cat-M1 Band 2			
	Channel Bandwidth 15 MHz			
	Low Channel		High Channel	
	Frequency (MHz)	Frequency Error (ppm)	Frequency (MHz)	Frequency Error (ppm)
-40	1857.4999980	-0.001	1902.5000040	0.002
-30	1857.4999970	-0.002	1902.5000030	0.002
-20	1857.4999980	-0.001	1902.5000010	0.001
-10	1857.4999990	-0.001	1902.5000030	0.002
0	1857.5000020	0.001	1902.4999970	-0.002
10	1857.5000040	0.002	1902.5000030	0.002
20	1857.4999960	-0.002	1902.4999960	-0.002
30	1857.4999980	-0.001	1902.4999960	-0.002
40	1857.4999960	-0.002	1902.5000010	0.001
50	1857.5000010	0.001	1902.4999980	-0.001
60	1857.4999970	-0.002	1902.5000030	0.002
70	1857.4999980	-0.001	1902.4999970	-0.002

Frequency Error vs. Voltage

Voltage (Vdc)	Cat-M1 Band 2			
	Channel Bandwidth 20 MHz			
	Low Channel		High Channel	
	Frequency (MHz)	Frequency Error (ppm)	Frequency (MHz)	Frequency Error (ppm)
6.12	1860.000002	0.001	1899.999999	-0.001
7.2	1859.999997	-0.002	1900.000001	0.001
8.28	1860.000004	0.002	1899.999996	-0.002

Note: The applicant defined the normal working voltage is from 6.12Vdc to 8.28Vdc.

Frequency Error vs. Temperature

Temp. (°C)	Cat-M1 Band 2			
	Channel Bandwidth 20 MHz			
	Low Channel		High Channel	
	Frequency (MHz)	Frequency Error (ppm)	Frequency (MHz)	Frequency Error (ppm)
-40	1859.9999970	-0.002	1899.9999980	-0.001
-30	1859.9999970	-0.002	1899.9999960	-0.002
-20	1860.0000040	0.002	1900.0000020	0.001
-10	1859.9999960	-0.002	1899.9999980	-0.001
0	1860.0000010	0.001	1899.9999990	-0.001
10	1859.9999980	-0.001	1900.0000010	0.001
20	1860.0000040	0.002	1899.9999960	-0.002
30	1860.0000040	0.002	1899.9999990	-0.001
40	1859.9999990	-0.001	1900.0000040	0.002
50	1859.9999980	-0.001	1899.9999970	-0.002
60	1860.0000020	0.001	1899.9999980	-0.001
70	1860.0000040	0.002	1900.0000010	0.001

Frequency Error vs. Voltage

Voltage (Vdc)	Cat-M1 Band 25			
	Channel Bandwidth 1.4 MHz			
	Low Channel		High Channel	
	Frequency (MHz)	Frequency Error (ppm)	Frequency (MHz)	Frequency Error (ppm)
6.12	1850.7000010	0.001	1914.3000020	0.001
7.2	1850.7000010	0.001	1914.2999960	-0.002
8.28	1850.7000030	0.002	1914.2999970	-0.002

Note: The applicant defined the normal working voltage is from 6.12Vdc to 8.28Vdc.

Frequency Error vs. Temperature

Temp. (°C)	Cat-M1 Band 25			
	Channel Bandwidth 1.4 MHz			
	Low Channel		High Channel	
	Frequency (MHz)	Frequency Error (ppm)	Frequency (MHz)	Frequency Error (ppm)
-40	1850.7000030	0.002	1914.2999970	-0.002
-30	1850.7000030	0.002	1914.3000020	0.001
-20	1850.6999960	-0.002	1914.2999960	-0.002
-10	1850.6999980	-0.001	1914.3000010	0.001
0	1850.7000030	0.002	1914.3000030	0.002
10	1850.6999990	-0.001	1914.3000030	0.002
20	1850.7000040	0.002	1914.2999960	-0.002
30	1850.7000020	0.001	1914.3000010	0.001
40	1850.6999990	-0.001	1914.3000040	0.002
50	1850.7000020	0.001	1914.2999960	-0.002
60	1850.7000030	0.002	1914.3000020	0.001
70	1850.7000010	0.001	1914.2999970	-0.002

Frequency Error vs. Voltage

Voltage (Vdc)	Cat-M1 Band 25			
	Channel Bandwidth 3MHz			
	Low Channel		High Channel	
	Frequency (MHz)	Frequency Error (ppm)	Frequency (MHz)	Frequency Error (ppm)
6.12	1851.5000010	0.001	1913.4999980	-0.001
7.2	1851.4999990	-0.001	1913.4999970	-0.002
8.28	1851.5000030	0.002	1913.4999960	-0.002

Note: The applicant defined the normal working voltage is from 6.12Vdc to 8.28Vdc.

Frequency Error vs. Temperature

Temp. (°C)	Cat-M1 Band 25			
	Channel Bandwidth 3MHz			
	Low Channel		High Channel	
	Frequency (MHz)	Frequency Error (ppm)	Frequency (MHz)	Frequency Error (ppm)
-40	1851.5000010	0.001	1913.4999990	-0.001
-30	1851.4999980	-0.001	1913.4999990	-0.001
-20	1851.4999960	-0.002	1913.4999980	-0.001
-10	1851.4999980	-0.001	1913.4999960	-0.002
0	1851.4999980	-0.001	1913.5000020	0.001
10	1851.4999980	-0.001	1913.4999960	-0.002
20	1851.4999990	-0.001	1913.5000020	0.001
30	1851.5000010	0.001	1913.4999960	-0.002
40	1851.4999990	-0.001	1913.4999960	-0.002
50	1851.4999980	-0.001	1913.4999980	-0.001
60	1851.5000020	0.001	1913.5000010	0.001
70	1851.4999970	-0.002	1913.5000020	0.001

Frequency Error vs. Voltage

Voltage (Vdc)	Cat-M1 Band 25			
	Channel Bandwidth 5 MHz			
	Low Channel		High Channel	
	Frequency (MHz)	Frequency Error (ppm)	Frequency (MHz)	Frequency Error (ppm)
6.12	1852.4999970	-0.002	1912.5000010	0.001
7.2	1852.5000030	0.002	1912.5000030	0.002
8.28	1852.5000010	0.001	1912.5000040	0.002

Note: The applicant defined the normal working voltage is from 6.12Vdc to 8.28Vdc.

Frequency Error vs. Temperature

Temp. (°C)	Cat-M1 Band 25			
	Channel Bandwidth 5 MHz			
	Low Channel		High Channel	
	Frequency (MHz)	Frequency Error (ppm)	Frequency (MHz)	Frequency Error (ppm)
-40	1852.4999980	-0.001	1912.4999980	-0.001
-30	1852.4999970	-0.002	1912.5000030	0.002
-20	1852.4999980	-0.001	1912.5000030	0.002
-10	1852.5000030	0.002	1912.4999970	-0.002
0	1852.5000010	0.001	1912.5000040	0.002
10	1852.5000020	0.001	1912.5000010	0.001
20	1852.4999990	-0.001	1912.4999970	-0.002
30	1852.5000020	0.001	1912.5000030	0.002
40	1852.5000040	0.002	1912.4999960	-0.002
50	1852.4999970	-0.002	1912.4999970	-0.002
60	1852.4999970	-0.002	1912.4999990	-0.001
70	1852.5000020	0.001	1912.5000030	0.002

Frequency Error vs. Voltage

Voltage (Vdc)	Cat-M1 Band 25			
	Channel Bandwidth 10 MHz			
	Low Channel		High Channel	
	Frequency (MHz)	Frequency Error (ppm)	Frequency (MHz)	Frequency Error (ppm)
6.12	1854.9999970	-0.002	1909.9999960	-0.002
7.2	1855.0000030	0.002	1910.0000020	0.001
8.28	1855.0000040	0.002	1909.9999980	-0.001

Note: The applicant defined the normal working voltage is from 6.12Vdc to 8.28Vdc.

Frequency Error vs. Temperature

Temp. (°C)	Cat-M1 Band 25			
	Channel Bandwidth 10 MHz			
	Low Channel		High Channel	
	Frequency (MHz)	Frequency Error (ppm)	Frequency (MHz)	Frequency Error (ppm)
-40	1855.0000040	0.002	1909.9999970	-0.002
-30	1854.9999990	-0.001	1909.9999970	-0.002
-20	1855.0000010	0.001	1909.9999970	-0.002
-10	1854.9999990	-0.001	1909.9999990	-0.001
0	1855.0000010	0.001	1909.9999980	-0.001
10	1855.0000030	0.002	1910.0000020	0.001
20	1855.0000040	0.002	1909.9999980	-0.001
30	1854.9999990	-0.001	1910.0000040	0.002
40	1854.9999990	-0.001	1910.0000020	0.001
50	1854.9999990	-0.001	1910.0000010	0.001
60	1854.9999960	-0.002	1909.9999970	-0.002
70	1854.9999970	-0.002	1910.0000010	0.001

Frequency Error vs. Voltage

Voltage (Vdc)	Cat-M1 Band 25			
	Channel Bandwidth 15 MHz			
	Low Channel		High Channel	
	Frequency (MHz)	Frequency Error (ppm)	Frequency (MHz)	Frequency Error (ppm)
6.12	1857.4999960	-0.002	1907.5000040	0.002
7.2	1857.4999960	-0.002	1907.5000020	0.001
8.28	1857.5000010	0.001	1907.5000040	0.002

Note: The applicant defined the normal working voltage is from 6.12Vdc to 8.28Vdc.

Frequency Error vs. Temperature

Temp. (°C)	Cat-M1 Band 25			
	Channel Bandwidth 15 MHz			
	Low Channel		High Channel	
	Frequency (MHz)	Frequency Error (ppm)	Frequency (MHz)	Frequency Error (ppm)
-40	1857.5000030	0.002	1907.4999990	-0.001
-30	1857.4999980	-0.001	1907.4999980	-0.001
-20	1857.4999990	-0.001	1907.4999990	-0.001
-10	1857.5000030	0.002	1907.4999960	-0.002
0	1857.4999960	-0.002	1907.5000010	0.001
10	1857.4999990	-0.001	1907.5000020	0.001
20	1857.5000030	0.002	1907.4999970	-0.002
30	1857.4999960	-0.002	1907.5000030	0.002
40	1857.5000040	0.002	1907.5000010	0.001
50	1857.4999990	-0.001	1907.4999960	-0.002
60	1857.5000040	0.002	1907.4999990	-0.001
70	1857.5000030	0.002	1907.5000020	0.001

Frequency Error vs. Voltage

Voltage (Vdc)	Cat-M1 Band 25			
	Channel Bandwidth 20 MHz			
	Low Channel		High Channel	
	Frequency (MHz)	Frequency Error (ppm)	Frequency (MHz)	Frequency Error (ppm)
6.12	1859.9999980	-0.001	1904.9999970	-0.002
7.2	1860.0000020	0.001	1904.9999970	-0.002
8.28	1859.9999960	-0.002	1904.9999990	-0.001

Note: The applicant defined the normal working voltage is from 6.12Vdc to 8.28Vdc.

Frequency Error vs. Temperature

Temp. (°C)	Cat-M1 Band 25			
	Channel Bandwidth 20 MHz			
	Low Channel		High Channel	
	Frequency (MHz)	Frequency Error (ppm)	Frequency (MHz)	Frequency Error (ppm)
-40	1860.0000030	0.002	1905.0000030	0.002
-30	1859.9999980	-0.001	1904.9999960	-0.002
-20	1860.0000040	0.002	1904.9999980	-0.001
-10	1859.9999960	-0.002	1904.9999980	-0.001
0	1859.9999970	-0.002	1904.9999960	-0.002
10	1860.0000010	0.001	1904.9999960	-0.002
20	1859.9999960	-0.002	1905.0000010	0.001
30	1859.9999980	-0.001	1904.9999990	-0.001
40	1860.0000030	0.002	1905.0000040	0.002
50	1860.0000030	0.002	1905.0000020	0.001
60	1859.9999960	-0.002	1905.0000020	0.001
70	1860.0000030	0.002	1904.9999980	-0.001

4.4 Occupied Bandwidth Measurement

4.4.1 Limits of Occupied Bandwidth Measurement

The occupied bandwidth (OBW), that is the frequency bandwidth such that, below its lower and above its upper frequency limits, the mean powers radiated are each equal to 0.5 % of the total mean power radiated by a given emission.

4.4.2 Test Procedure

For the 26dBc bandwidth measurement method, please refer to section 5.4.3 of ANSI C63.26.

- a) The spectrum analyzer center frequency is set to the nominal EUT channel center frequency. The span range for the spectrum analyzer shall be wide enough to see sufficient roll off of the signal to make the measurement.
- b) The nominal RBW shall be in the range of 1% to 5% of the anticipated OBW, and the VBW shall be set $\geq 3 \times \text{RBW}$.
- c) Set the reference level of the instrument as required to prevent the signal amplitude from exceeding the maximum spectrum analyzer input mixer level for linear operation. See guidance provided in 4.2.3.
- d) The dynamic range of the spectrum analyzer at the selected RBW shall be more than 10 dB below the target “-X dB” requirement, i.e., if the requirement calls for measuring the -26 dB OBW, the spectrum analyzer noise floor at the selected RBW shall be at least 36 dB below the reference level.
- e) Set spectrum analyzer detection mode to peak, and the trace mode to max hold.
- f) Determine the following reference values: Set the EUT to transmit a modulated signal. Allow the trace to stabilize. Set the spectrum analyzer marker to the highest level of the displayed trace (this is the reference value).
- g) Determine the “-X dB amplitude” as equal to (Reference Value - X). Alternatively, this calculation can be performed on the spectrum analyzer using the delta-marker measurement function.
- h) Place two markers, one at the lowest and the other at the highest frequency of the envelope of the spectral display such that each marker is at or slightly below the “-X dB amplitude” determined in step f). If a marker is below this “-X dB amplitude” value it should be as close as possible to this value. The OBW is the positive frequency difference between the two markers.
- i) The OBW shall be reported by providing plot(s) of the measuring instrument display, to include markers depicting the relevant frequency and amplitude information (e.g., marker table). The frequency and amplitude axis and scale shall be clearly labeled. Tabular data may be reported in addition to the plot(s).

For the occupied bandwidth measurement method, please refer to section 5.4.4 of ANSI C63.26.

4.4.3 Test Setup

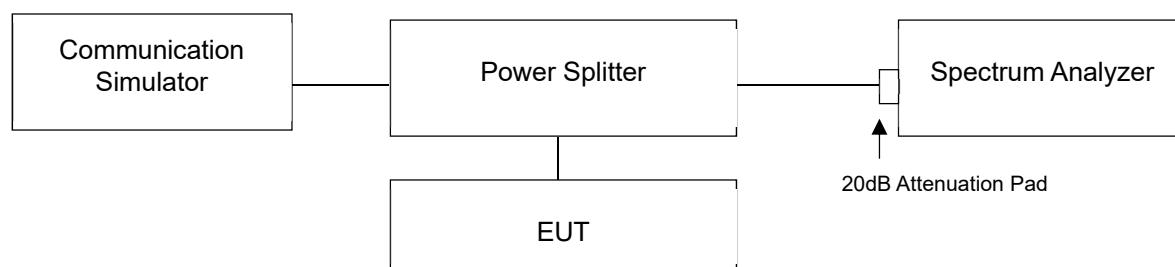

4.4.4 Test Result

Occupied Bandwidth

Cat-M1 Band 2, Channel Bandwidth 1.4MHz			
Channel	Frequency (MHz)	99% Occupied Bandwidth (MHz)	
		QPSK	16QAM
18607	1850.7	1.0845	1.0857
18900	1880.0	1.0852	1.0851
19193	1909.3	1.0853	1.0866
Cat-M1 Band 2, Channel Bandwidth 3MHz			
Channel	Frequency (MHz)	99% Occupied Bandwidth (MHz)	
		QPSK	16QAM
18615	1851.5	1.0842	1.0851
18900	1880.0	1.0860	1.0832
19185	1908.5	1.0853	1.0852
Cat-M1 Band 2, Channel Bandwidth 5MHz			
Channel	Frequency (MHz)	99% Occupied Bandwidth (MHz)	
		QPSK	16QAM
18625	1852.5	1.0888	1.0871
18900	1880.0	1.0888	1.0885
19175	1907.5	1.0868	1.0890
Cat-M1 Band 2, Channel Bandwidth 10MHz			
Channel	Frequency (MHz)	99% Occupied Bandwidth (MHz)	
		QPSK	16QAM
18650	1855.0	1.0891	1.0888
18900	1880.0	1.0903	1.0881
19150	1905.0	1.0893	1.0879
Cat-M1 Band 2, Channel Bandwidth 15MHz			
Channel	Frequency (MHz)	99% Occupied Bandwidth (MHz)	
		QPSK	16QAM
18675	1857.5	1.0886	1.0887
18900	1880.0	1.0896	1.0878
19125	1902.5	1.0899	1.0901

Cat-M1 Band 2, Channel Bandwidth 20MHz

Channel	Frequency (MHz)	99% Occupied Bandwidth (MHz)	
		QPSK	16QAM
18700	1860.0	1.0881	1.0895
18900	1880.0	1.0909	1.0892
19100	1900.0	1.0915	1.0901

Spectrum Plot of Worst Value

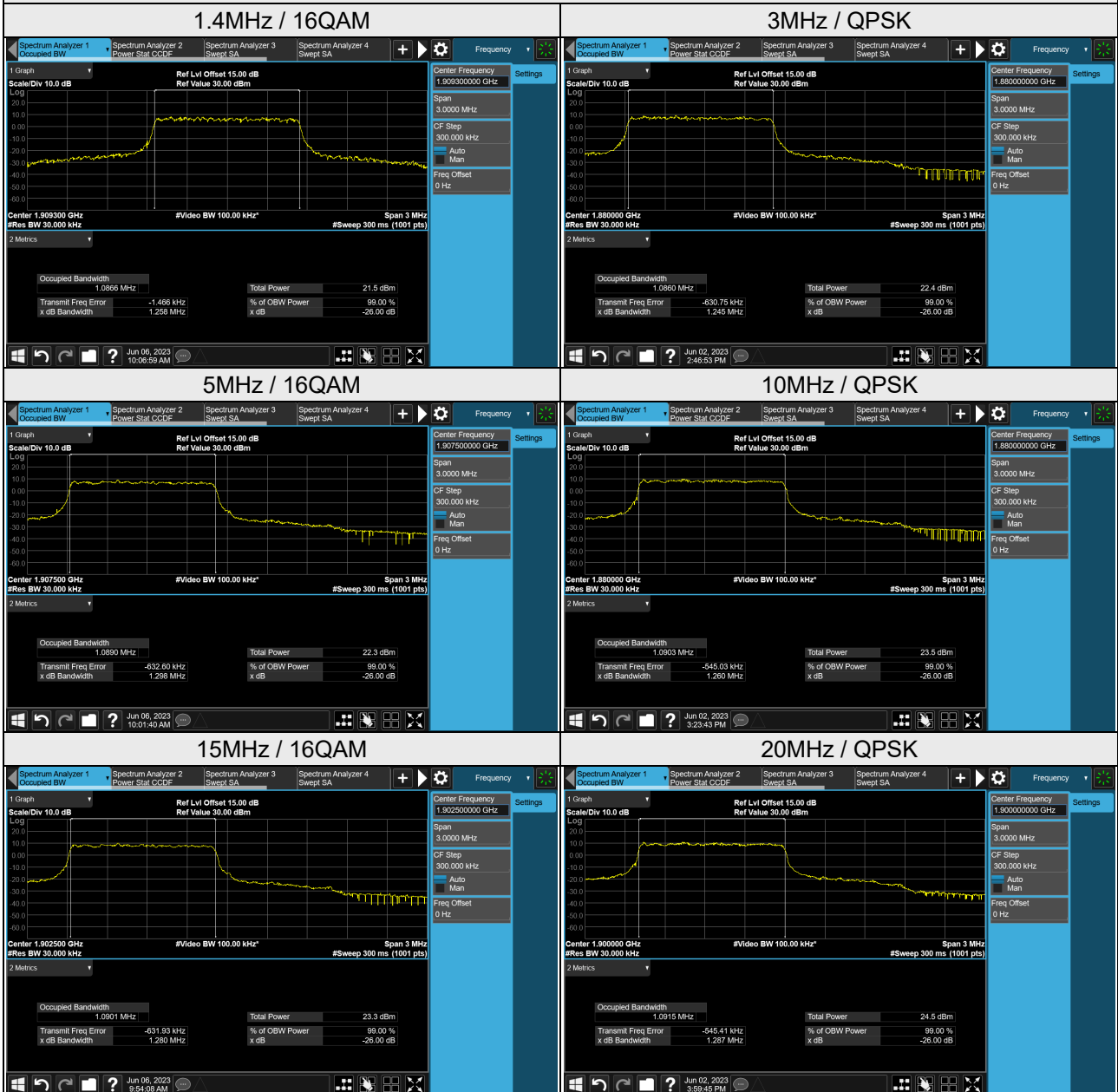

Cat-M1 Band 25, Channel Bandwidth 1.4MHz			
Channel	Frequency (MHz)	99% Occupied Bandwidth (MHz)	
		QPSK	16QAM
26047	1850.7	1.0845	1.0848
26365	1882.5	1.0867	1.0847
26683	1914.3	1.0850	1.0854
Cat-M1 Band 25, Channel Bandwidth 3MHz			
Channel	Frequency (MHz)	99% Occupied Bandwidth (MHz)	
		QPSK	16QAM
26055	1851.5	1.0839	1.0826
26365	1882.5	1.0849	1.0847
26675	1913.5	1.0849	1.0842
Cat-M1 Band 25, Channel Bandwidth 5MHz			
Channel	Frequency (MHz)	99% Occupied Bandwidth (MHz)	
		QPSK	16QAM
26065	1852.5	1.0879	1.0878
26365	1882.5	1.0885	1.0879
26665	1912.5	1.0879	1.0884
Cat-M1 Band 25, Channel Bandwidth 10MHz			
Channel	Frequency (MHz)	99% Occupied Bandwidth (MHz)	
		QPSK	16QAM
26090	1855.0	1.0872	1.0937
26365	1882.5	1.0958	1.0939
26640	1910.0	1.0888	1.0893
Cat-M1 Band 25, Channel Bandwidth 15MHz			
Channel	Frequency (MHz)	99% Occupied Bandwidth (MHz)	
		QPSK	16QAM
26115	1857.5	1.0890	1.0916
26365	1882.5	1.0895	1.0902
26615	1907.5	1.0886	1.0881

Cat-M1 Band 25, Channel Bandwidth 20MHz

Channel	Frequency (MHz)	99% Occupied Bandwidth (MHz)	
		QPSK	16QAM
26140	1860.0	1.0891	1.0883
26365	1882.5	1.0893	1.0937
26590	1905.0	1.0896	1.0929

Spectrum Plot of Worst Value

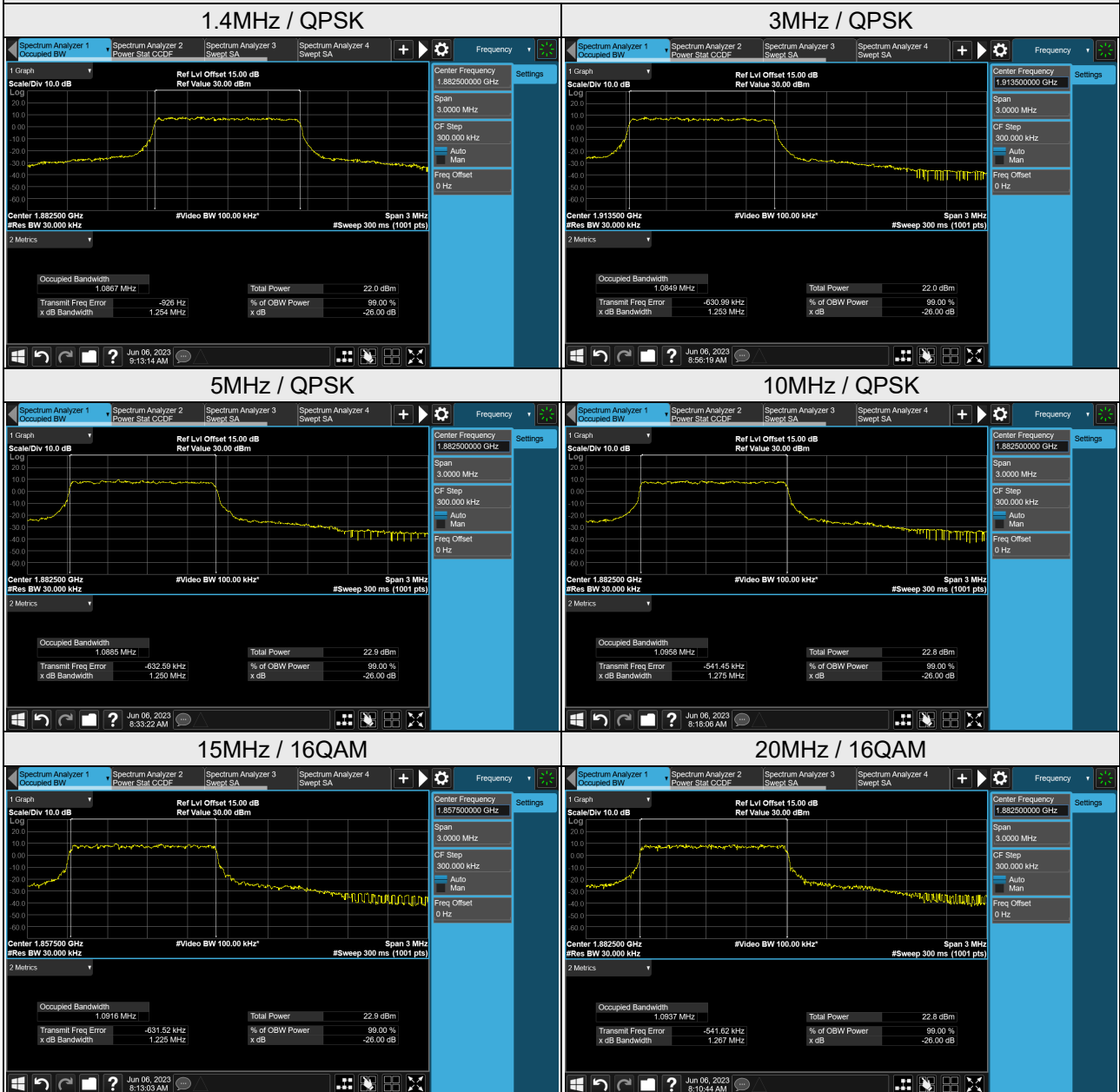

26dB Bandwidth

Cat-M1 Band 2, Channel Bandwidth 1.4MHz			
Channel	Frequency (MHz)	26dB Bandwidth (MHz)	
		QPSK	16QAM
18607	1850.7	1.257	1.263
18900	1880.0	1.259	1.250
19193	1909.3	1.247	1.258
Cat-M1 Band 2, Channel Bandwidth 3MHz			
Channel	Frequency (MHz)	26dB Bandwidth (MHz)	
		QPSK	16QAM
18615	1851.5	1.249	1.253
18900	1880.0	1.245	1.241
19185	1908.5	1.250	1.251
Cat-M1 Band 2, Channel Bandwidth 5MHz			
Channel	Frequency (MHz)	26dB Bandwidth (MHz)	
		QPSK	16QAM
18625	1852.5	1.285	1.274
18900	1880.0	1.292	1.276
19175	1907.5	1.276	1.298
Cat-M1 Band 2, Channel Bandwidth 10MHz			
Channel	Frequency (MHz)	26dB Bandwidth (MHz)	
		QPSK	16QAM
18650	1855.0	1.257	1.249
18900	1880.0	1.260	1.252
19150	1905.0	1.257	1.255
Cat-M1 Band 2, Channel Bandwidth 15MHz			
Channel	Frequency (MHz)	26dB Bandwidth (MHz)	
		QPSK	16QAM
18675	1857.5	1.309	1.281
18900	1880.0	1.317	1.280
19125	1902.5	1.311	1.280

Cat-M1 Band 2, Channel Bandwidth 20MHz

Channel	Frequency (MHz)	26dB Bandwidth (MHz)	
		QPSK	16QAM
18700	1860.0	1.280	1.259
18900	1880.0	1.285	1.260
19100	1900.0	1.287	1.258

Spectrum Plot of Worst Value

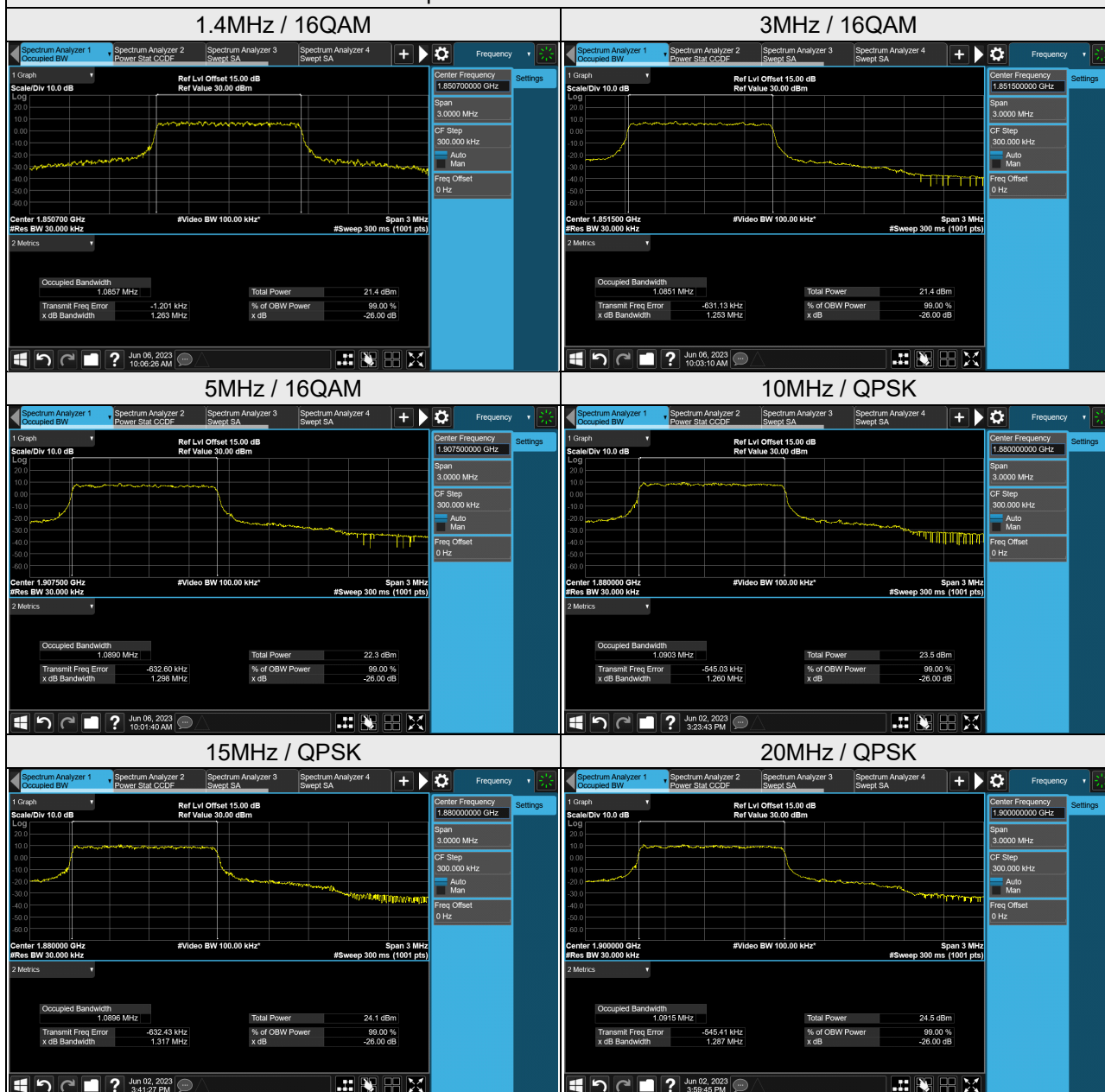

Cat-M1 Band 25, Channel Bandwidth 1.4MHz			
Channel	Frequency (MHz)	26dB Bandwidth (MHz)	
		QPSK	16QAM
26047	1850.7	1.242	1.243
26365	1882.5	1.254	1.239
26683	1914.3	1.249	1.247
Cat-M1 Band 25, Channel Bandwidth 3MHz			
Channel	Frequency (MHz)	26dB Bandwidth (MHz)	
		QPSK	16QAM
26055	1851.5	1.247	1.247
26365	1882.5	1.249	1.246
26675	1913.5	1.253	1.243
Cat-M1 Band 25, Channel Bandwidth 5MHz			
Channel	Frequency (MHz)	26dB Bandwidth (MHz)	
		QPSK	16QAM
26065	1852.5	1.248	1.235
26365	1882.5	1.250	1.246
26665	1912.5	1.253	1.240
Cat-M1 Band 25, Channel Bandwidth 10MHz			
Channel	Frequency (MHz)	26dB Bandwidth (MHz)	
		QPSK	16QAM
26090	1855.0	1.247	1.272
26365	1882.5	1.275	1.243
26640	1910.0	1.244	1.250
Cat-M1 Band 25, Channel Bandwidth 15MHz			
Channel	Frequency (MHz)	26dB Bandwidth (MHz)	
		QPSK	16QAM
26115	1857.5	1.271	1.225
26365	1882.5	1.290	1.240
26615	1907.5	1.293	1.235

Cat-M1 Band 25, Channel Bandwidth 20MHz				
Channel	Frequency (MHz)	26dB Bandwidth (MHz)		
		QPSK	16QAM	
26140	1860.0	1.255	1.263	
26365	1882.5	1.264	1.267	
26590	1905.0	1.265	1.289	

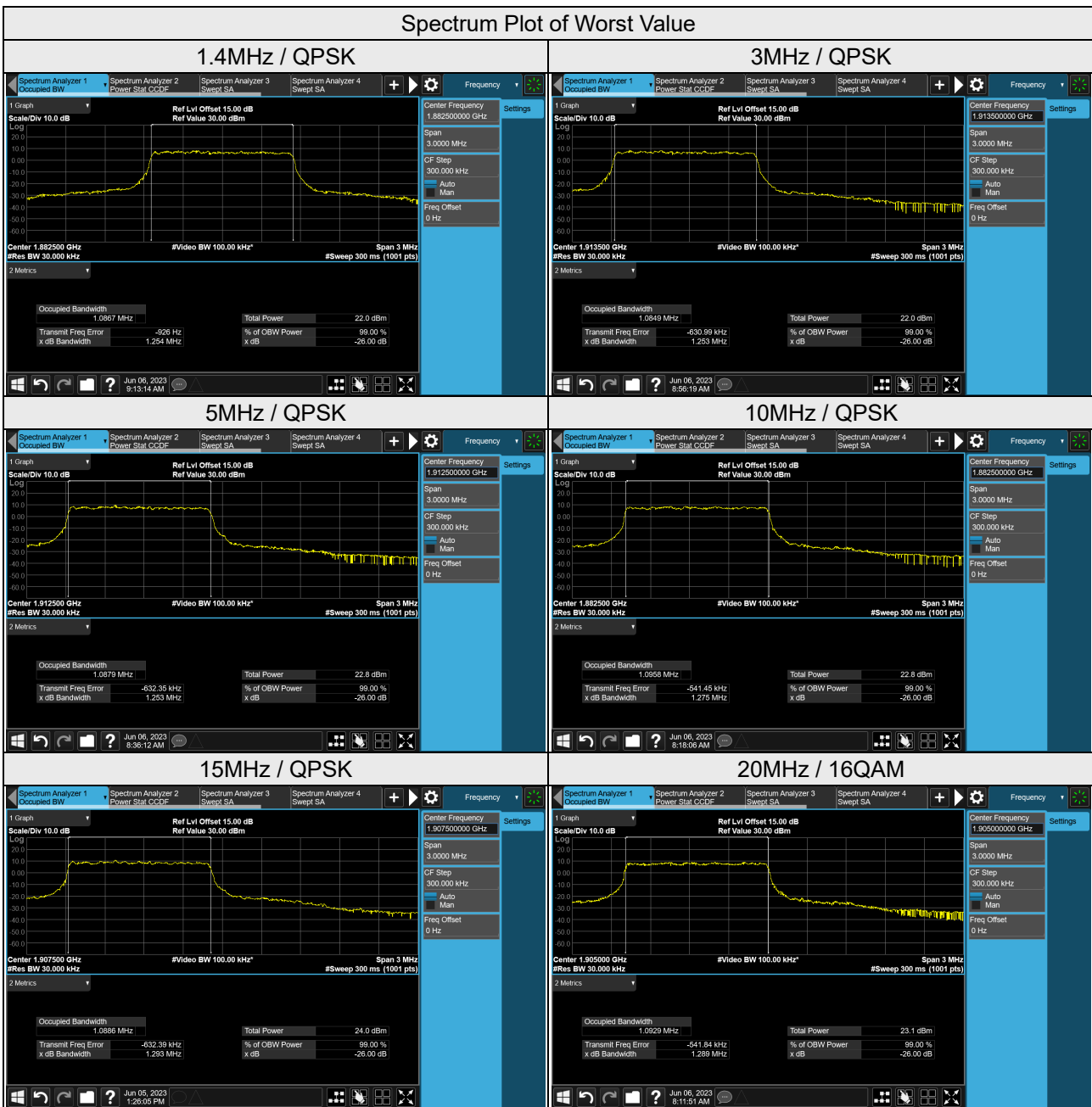

4.5 Band Edge Measurement

4.5.1 Limits of Band Edge Measurement

Power of any emission outside of the authorized operating frequency ranges must be attenuated below the transmitting power (P) by a factor of at least $43 + 10 \log(P)$ dB. In the 1 MHz bands immediately outside and adjacent to the frequency block a resolution bandwidth of at least one percent of the emission bandwidth of the fundamental emission of the transmitter may be employed.

4.5.2 Test Setup

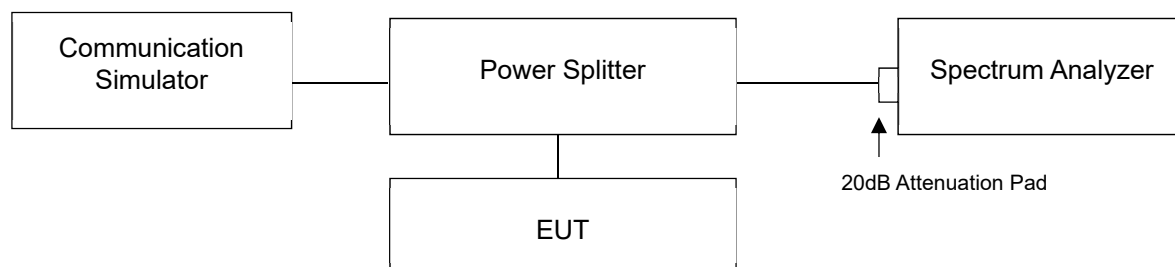

4.5.3 Test Procedures

- All measurements were done at low and high operational frequency range.
- Measurement refer to ANSI C63.26 section 5.7.
- Measuring frequency band edge, narrow RBW (no less than 1% of the OBW) is used for conducted emission measurement. $VBW \geq 3 \times RBW$, Detector = Average.
- The center frequency of spectrum is the band edge frequency and span is 2MHz. RB of the spectrum is 15kHz and VB of the spectrum is 51kHz. (For Cat-M1 Band 2)
- The center frequency of spectrum is the band edge frequency and span is 2MHz. RB of the spectrum is 30kHz and VB of the spectrum is 100kHz. (For Cat-M1 Band 25)
- Record the max trace plot into the test report.

4.5.4 Test Results

Cat-M1 Band 2 (Channel Bandwidth 1.4MHz)

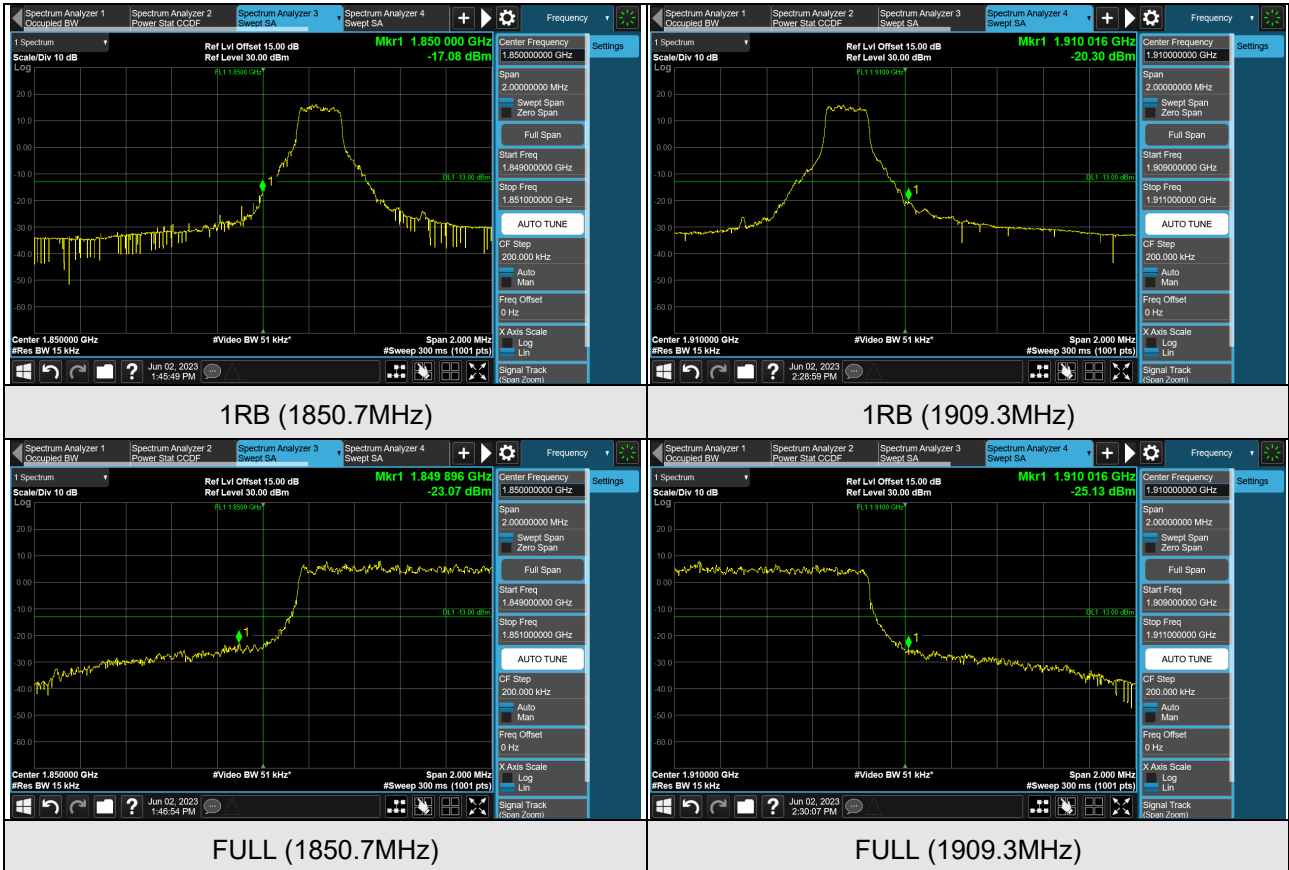

Cat-M1 Band 2 (Channel Bandwidth 3MHz)

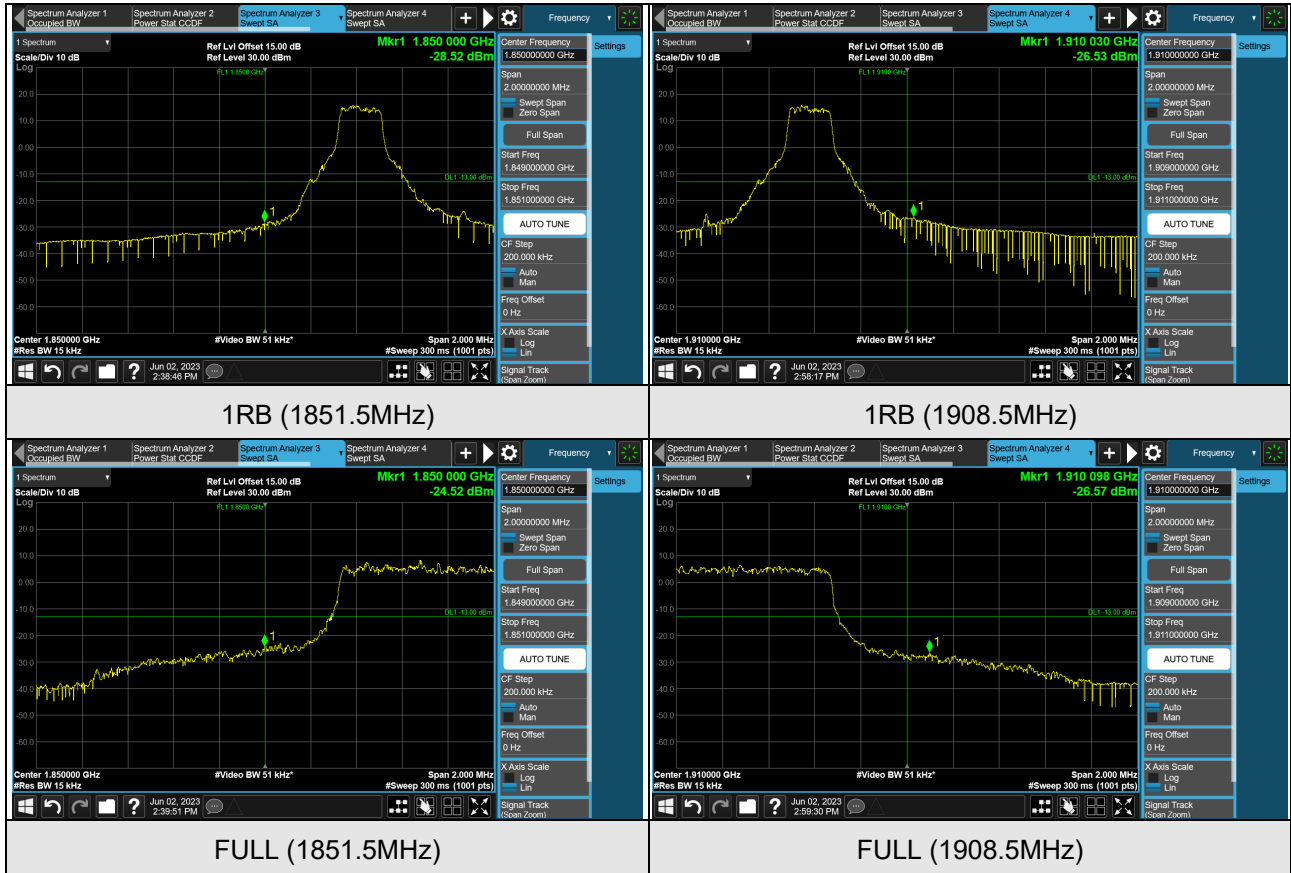

Cat-M1 Band 2 (Channel Bandwidth 5MHz)

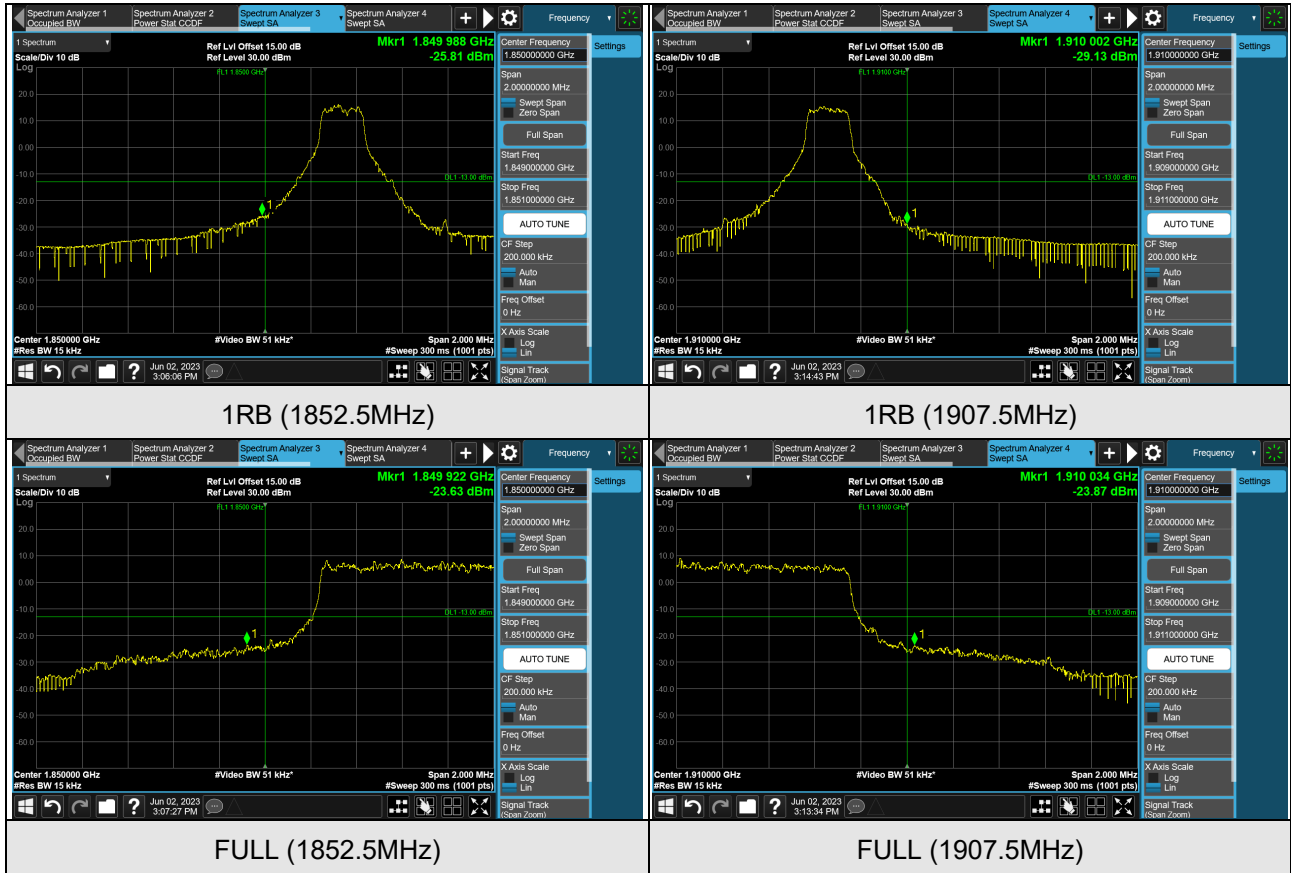

Cat-M1 Band 2 (Channel Bandwidth 10MHz)

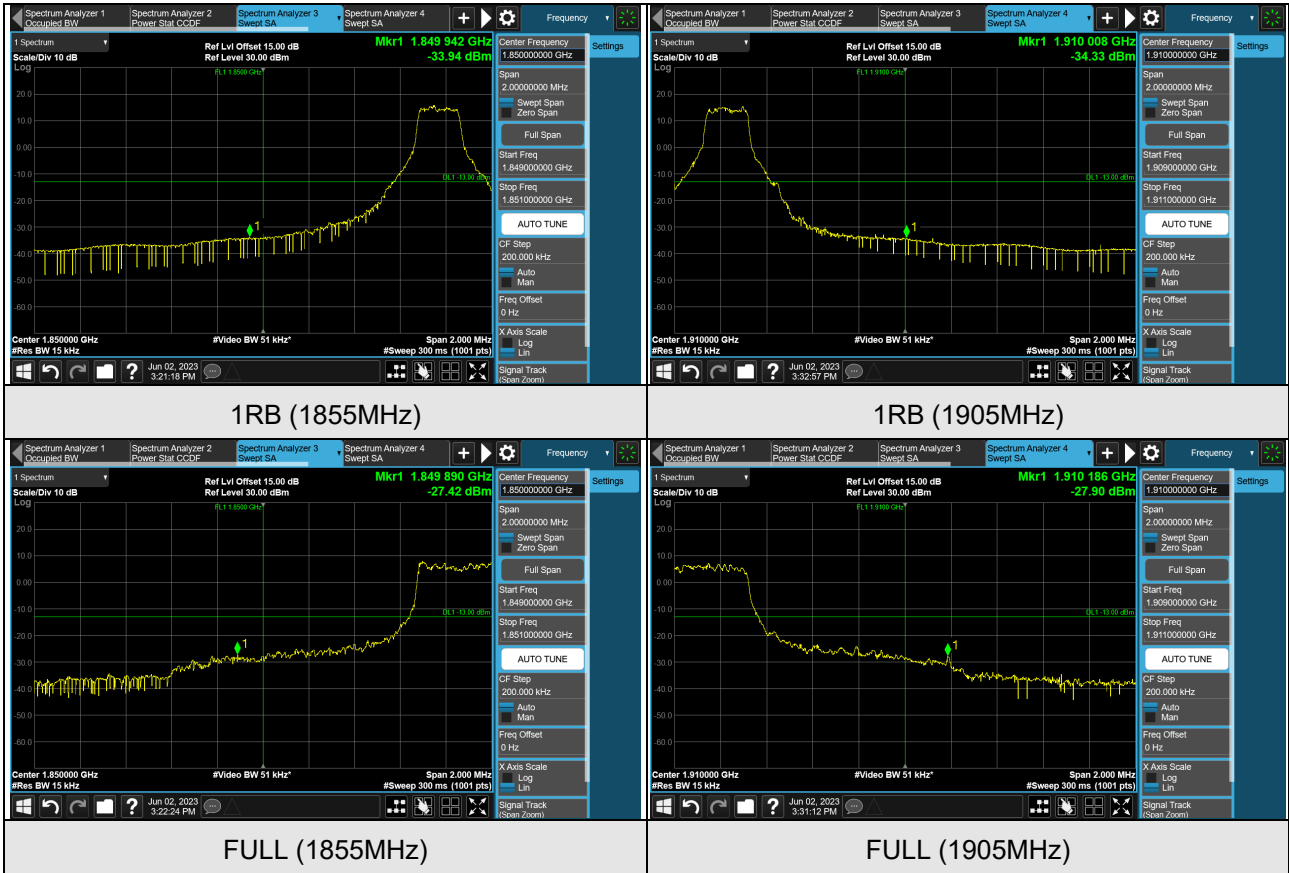

Cat-M1 Band 2 (Channel Bandwidth 15MHz)

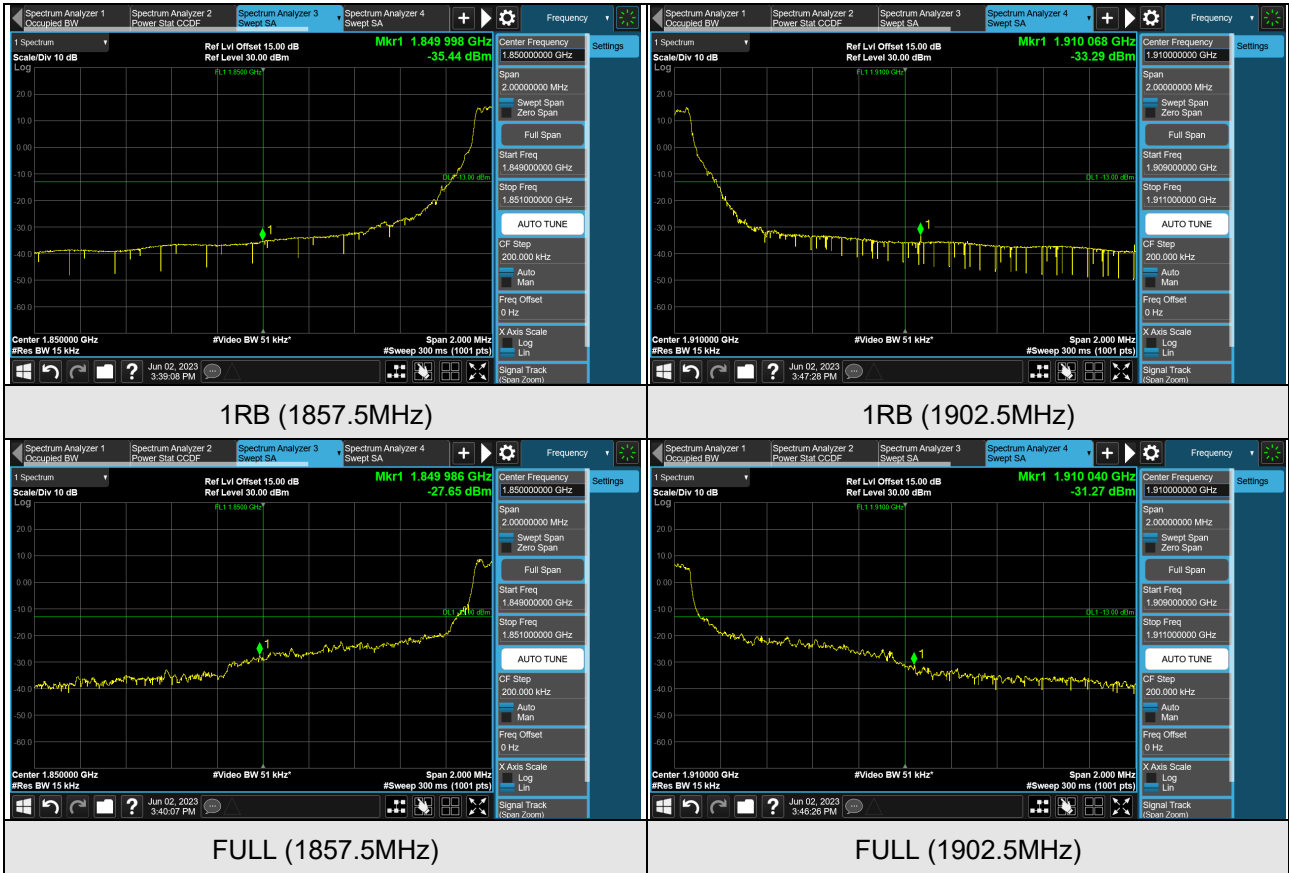

Cat-M1 Band 2 (Channel Bandwidth 20MHz)



Cat-M1 Band 25 (Channel Bandwidth 1.4MHz)

