

FCC Test Report (Part 22 – Cat M1 B5/B26)

Report No.: RFBFKV-WTW-P23050559-2

FCC ID: L6AITH100-1

Test Model: ITH100-1

Received Date: May 23, 2023

Test Date: May 30 ~ Jun. 07, 2023

Issued Date: Jul. 07, 2023

Applicant: BlackBerry Limited

Address: 2200 University Avenue East, Waterloo, Ontario, Canada N2K 0A7

Issued By: Bureau Veritas Consumer Products Services (H.K.) Ltd., Taoyuan Branch
Lin Kou Laboratories

Lab Address: No. 47-2, 14th Ling, Chia Pau Vil., Lin Kou Dist., New Taipei City, Taiwan

Test Location (1): No. 19, Hwa Ya 2nd Rd., Wen Hwa Vil., Kwei Shan Dist., Taoyuan City
33383, Taiwan

Test Location (2): No. 70, Wenming Rd., Guishan Dist., Taoyuan City 333, Taiwan (R.O.C.)

FCC Registration /

Designation Number(1): 788550 / TW0003

FCC Registration /

Designation Number(2): 281270 / TW0032



This report is governed by, and incorporates by reference, the Conditions of Testing as posted at the date of issuance of this report at <http://www.bureauveritas.com/home/about-us/our-business/cps/about-us/terms-conditions/> and is intended for your exclusive use. Any copying or replication of this report to or for any other person or entity, or use of our name or trademark, is permitted only with our prior written permission. This report sets forth our findings solely with respect to the test samples identified herein. The results set forth in this report are not indicative or representative of the quality or characteristics of the lot from which a test sample was taken or any similar or identical product unless specifically and expressly noted. Our report includes all of the tests requested by you and the results thereof based upon the information that you provided to us. Measurement uncertainty is only provided upon request for accredited tests. Statements of conformity are based on simple acceptance criteria without taking measurement uncertainty into account, unless otherwise requested in writing. You have 60 days from date of issuance of this report to notify us of any material error or omission caused by our negligence or if you require measurement uncertainty; provided, however, that such notice shall be in writing and shall specifically address the issue you wish to raise. A failure to raise such issue within the prescribed time shall constitute your unqualified acceptance of the completeness of this report, the tests conducted and the correctness of the report contents.

Table of Contents

Release Control Record	4
1 Certificate of Conformity	5
2 Summary of Test Results	6
2.1 Measurement Uncertainty.....	6
2.2 Test Site and Instruments.....	7
3 General Information	8
3.1 General Description of EUT.....	8
3.2 Configuration of System under Test.....	10
3.2.1 Description of Support Units.....	10
3.3 Test Mode Applicability and Tested Channel Detail.....	11
3.4 EUT Operating Conditions.....	16
3.5 General Description of Applied Standards and References.....	16
4 Test Types and Results	17
4.1 Output Power Measurement.....	17
4.1.1 Limits of Output Power Measurement.....	17
4.1.2 Test Procedures.....	17
4.1.3 Test Setup.....	17
4.1.4 Test Results.....	18
4.2 Modulation Characteristics Measurement.....	23
4.2.1 Limits of Modulation Characteristics.....	23
4.2.2 Test Procedure.....	23
4.2.3 Test Setup.....	23
4.2.4 Test Results.....	24
4.3 Frequency Stability Measurement.....	25
4.3.1 Limits of Frequency Stability Measurement.....	25
4.3.2 Test Procedure.....	25
4.3.3 Test Instruments.....	25
4.3.4 Test Setup.....	25
4.3.5 Test Results.....	26
4.4 Occupied Bandwidth Measurement.....	35
4.4.1 Limits of Occupied Bandwidth Measurement.....	35
4.4.2 Test Procedure.....	35
4.4.3 Test Setup.....	35
4.4.4 Test Result.....	36
4.5 Band Edge Measurement.....	44
4.5.1 Limits of Band Edge Measurement.....	44
4.5.2 Test Setup.....	44
4.5.3 Test Procedures.....	44
4.5.4 Test Results.....	45
4.6 Peak to Average Ratio.....	54
4.6.1 Limits of Peak to Average Ratio Measurement.....	54
4.6.2 Test Setup.....	54
4.6.3 Test Procedures.....	54
4.6.4 Test Results.....	55
4.7 Conducted Spurious Emissions.....	59
4.7.1 Limits of Conducted Spurious Emissions Measurement.....	59
4.7.2 Test Setup.....	59
4.7.3 Test Procedure.....	59
4.7.4 Test Results.....	60
4.8 Radiated Emission Measurement.....	69
4.8.1 Limits of Radiated Emission Measurement.....	69
4.8.2 Test Procedure.....	69
4.8.3 Deviation from Test Standard.....	69

4.8.4 Test Setup.....	70
4.8.5 Test Results	71
Appendix – Information of the Testing Laboratories	91

Release Control Record

Issue No.	Description	Date Issued
RFBFKV-WTW-P23050559-2	Original Release	Jul. 07, 2023

1 Certificate of Conformity

Product: Radar H2M IS
Brand: BlackBerry
Test Model: ITH100-1
Sample Status: Engineering Sample
Applicant: BlackBerry Limited
Test Date: May 30 ~ Jun. 07, 2023
Standards: FCC Part 22, Subpart H

The above equipment has been tested by **Bureau Veritas Consumer Products Services (H.K.) Ltd., Taoyuan Branch**, and found compliance with the requirement of the above standards. The test record, data evaluation & Equipment Under Test (EUT) configurations represented herein are true and accurate accounts of the measurements of the sample's RF characteristics under the conditions specified in this report.

Prepared by : Pettie Chen, **Date:** Jul. 07, 2023
Pettie Chen / Senior Specialist

Approved by : Jeremy Lin, **Date:** Jul. 07, 2023
Jeremy Lin / Project Engineer

2 Summary of Test Results

Applied Standard: FCC Part 22 & Part 2			
FCC Clause	Test Item	Result	Remarks
2.1046 22.913 (a)	Effective radiated power	Pass	Meet the requirement of limit.
2.1047	Modulation Characteristics	Pass	Meet the requirement of limit.
22.913 (d)	Peak To Average Ratio	Pass	Meet the requirement of limit.
2.1055 22.355	Frequency Stability	Pass	Meet the requirement of limit.
2.1049	Occupied Bandwidth	Pass	Meet the requirement of limit.
22.917	Band Edge Measurements	Pass	Meet the requirement of limit.
2.1051 22.917	Conducted Spurious Emissions	Pass	Meet the requirement of limit.
2.1053 22.917	Radiated Spurious Emissions	Pass	Meet the requirement of limit. Minimum passing margin is -21.82 dB at 1673.00 MHz.

Note: Determining compliance based on the results of the compliance measurement, not taking into account measurement instrumentation uncertainty.

2.1 Measurement Uncertainty

Where relevant, the following measurement uncertainty levels have been estimated for tests performed on the EUT as specified in CISPR 16-4-2:

Measurement	Frequency	Expanded Uncertainty (k=2) (\pm)
Radiated Emissions up to 1 GHz	9kHz ~ 30MHz	3.00 dB
	30MHz ~ 200MHz	2.91 dB
	200MHz ~ 1000MHz	2.92 dB
Radiated Emissions above 1 GHz	1GHz ~ 18GHz	1.76 dB
	18GHz ~ 40GHz	1.77 dB

2.2 Test Site and Instruments

Description Manufacturer	Model No.	Serial No.	Calibrated Date	Calibrated Until
Software BV ADT	ADT_Radiated_ V7.6.15.9.5	NA	NA	NA
Antenna Tower Max-Full	MFT-151SS-0.5T	NA	NA	NA
Turn Table Max-Full	MF-7802BS	NA	NA	NA
Turn Table Controller Max-Full	MF-7802BS	MF780208674	NA	NA
EMI Test Receiver R&S	ESR3	102782	2022/12/12	2023/12/11
Signal & Spectrum Analyzer R&S	FSW43	101866	2023/1/10	2024/1/9
Loop Antenna TESEQ	HLA 6121	45745	2022/7/27	2023/7/26
Loop Antenna Electro-Metrics	EM-6879	269	2022/9/19	2023/9/18
Preamplifier EMCI	EMC001340	980201	2022/9/23	2023/9/22
RF Coaxial Cable EMCI	5D-NM-BM	140903+140902	2023/1/7	2024/1/6
Preamplifier EMCI	EMC330N	980782	2023/1/16	2024/1/15
Bi_Log Antenna Schwarzbeck	VULB 9168	9168-1213	2022/10/20	2023/10/19
RF Coaxial Cable EMCI	EMCCFD400-NM-NM-500	201233	2023/1/16	2024/1/15
RF Coaxial Cable EMCI	EMCCFD400-NM-NM-3000	201235	2023/1/16	2024/1/15
RF Coaxial Cable EMCI	EMCCFD400-NM-NM-9000	201236(with PAD)	2023/1/16	2024/1/15
Horn Antenna RFSPIN	DRH18-E	210103A18E	2022/11/13	2023/11/12
Preamplifier EMCI	EMC118A45SE	980808	2022/12/29	2023/12/28
RF Coaxial Cable EMCI	EMC104-SM-SM-1000	210102	2023/1/16	2024/1/15
RF Coaxial Cable EMCI	EMC104-SM-SM-3000	201231	2023/1/16	2024/1/15
RF Coaxial Cable EMCI	EMC104-SM-SM-9000	201243	2023/1/16	2024/1/15
Preamplifier EMCI	EMC184045SE	980788	2023/1/16	2024/1/15
Horn Antenna Schwarzbeck	BBHA 9170	9170-1049	2022/11/13	2023/11/12
RF Coaxial Cable EMCI	EMC101G-KM-KM-5000	201260	2023/1/16	2024/1/15
RF Coaxial Cable EMCI	EMC101G-KM-KM-3000	201257	2023/1/16	2024/1/15
RF Coaxial Cable EMCI	EMC101G-KM-KM-2000	201254	2023/1/16	2024/1/15
USB Wideband Power Sensor KEYSIGHT	U2021XA	MY55050005/MY55190004/ MY55190007/MY55210005	2022/7/13	2023/7/10
Boresight Antenna Fixture	FBA-01	FBA-SIP01	NA	NA

Note: 1. The calibration interval of the above test instruments is 12 months and the calibrations are traceable to NML/ROC and NIST/USA.
2. The test was performed in WM Chamber 8.

3 General Information

3.1 General Description of EUT

Product	Radar H2M IS		
Brand	BlackBerry		
Test Model	ITH100-1		
Sample Status	Engineering Sample		
Power Supply Rating	7.2Vdc from battery		
Modulation Type	QPSK, 16QAM		
Operating Frequency	Cat-M1 Band 5 (Channel Bandwidth 1.4MHz)	824.7MHz ~ 848.3MHz	
	Cat-M1 Band 5 (Channel Bandwidth 3MHz)	825.5MHz ~ 847.5MHz	
	Cat-M1 Band 5 (Channel Bandwidth 5MHz)	826.5MHz ~ 846.5MHz	
	Cat-M1 Band 5 (Channel Bandwidth 10MHz)	829.0MHz ~ 844.0MHz	
	Cat-M1 Band 26 (Channel Bandwidth: 1.4 MHz)	824.7 ~ 848.3 MHz	
	Cat-M1 Band 26 (Channel Bandwidth: 3 MHz)	825.5 ~ 847.5 MHz	
	Cat-M1 Band 26 (Channel Bandwidth: 5 MHz)	826.5 ~ 846.5 MHz	
	Cat-M1 Band 26 (Channel Bandwidth: 10 MHz)	829 ~ 844 MHz	
	Cat-M1 Band 26 (Channel Bandwidth: 15 MHz)	831.5 ~ 841.5 MHz	
Max. ERP Power		QPSK	16QAM
	Cat-M1 Band 5 (Channel Bandwidth 1.4MHz)	210.378mW (23.23dBm)	185.780mW (22.69dBm)
	Cat-M1 Band 5 (Channel Bandwidth 3MHz)	207.970mW (23.18dBm)	168.267mW (22.26dBm)
	Cat-M1 Band 5 (Channel Bandwidth 5MHz)	206.063mW (23.14dBm)	198.153mW (22.97dBm)
	Cat-M1 Band 5 (Channel Bandwidth 10MHz)	210.863mW (23.24dBm)	195.884mW (22.92dBm)
	Cat-M1 Band 26 (Channel Bandwidth: 1.4 MHz)	190.985mW (22.81dBm)	149.279mW (21.74dBm)
	Cat-M1 Band 26 (Channel Bandwidth: 3 MHz)	191.867mW (22.83dBm)	155.597mW (21.92dBm)
	Cat-M1 Band 26 (Channel Bandwidth: 5 MHz)	190.985mW (22.81dBm)	184.077mW (22.65dBm)
	Cat-M1 Band 26 (Channel Bandwidth: 10 MHz)	190.108mW (22.79dBm)	184.927mW (22.67dBm)
	Cat-M1 Band 26 (Channel Bandwidth: 15 MHz)	192.309mW (22.84dBm)	185.780mW (22.69dBm)

Emission Designator		QPSK	16QAM
	Cat-M1 Band 5 (Channel Bandwidth 1.4MHz)	1M09G7D	1M08D7W
	Cat-M1 Band 5 (Channel Bandwidth 3MHz)	1M08G7D	1M08D7W
	Cat-M1 Band 5 (Channel Bandwidth 5MHz)	1M09G7D	1M09D7W
	Cat-M1 Band 5 (Channel Bandwidth 10MHz)	1M09G7D	1M09D7W
	Cat-M1 Band 26 (Channel Bandwidth: 1.4 MHz)	1M09G7D	1M08D7W
	Cat-M1 Band 26 (Channel Bandwidth: 3 MHz)	1M08G7D	1M08D7W
	Cat-M1 Band 26 (Channel Bandwidth: 5 MHz)	1M08G7D	1M09D7W
	Cat-M1 Band 26 (Channel Bandwidth: 10 MHz)	1M08G7D	1M09D7W
	Cat-M1 Band 26 (Channel Bandwidth: 15 MHz)	1M08G7D	1M09D7W
Antenna Type	Refer to Note		
Antenna Connector	Refer to Note		
Accessory Device	Refer to Note		
Cable Supplied	Refer to Note		

Note:

1. The EUT consumes power from the following batteries.

Battery 1	
Brand	EVE
Model	BAT-63705-001
Power Rating	7.2V, 38Ah, 274 Wh

Battery 2	
Brand	Vitrocell
Model	BAT-63705-002
Power Rating	7.2V, 38Ah, 274 Wh

2. The antenna information for host is listed as below.

Type	Monopole with gnd resonator							
Connector	Murata MM8030-2610B/RJ3/RK0							
Antenna gain (dBi)								
Cat-M1 Band								
2	4	5	12	13	25	26	66	85
3.51	3.27	1.94	-0.33	0.69	3.51	1.94	3.84	-0.33

* Detail antenna specification please refer to antenna datasheet or an antenna gain measurement report.

3. The above EUT information is declared by manufacturer and for more detailed features description, please refer to the manufacturer's specifications or User's Manual.

3.2 Configuration of System under Test

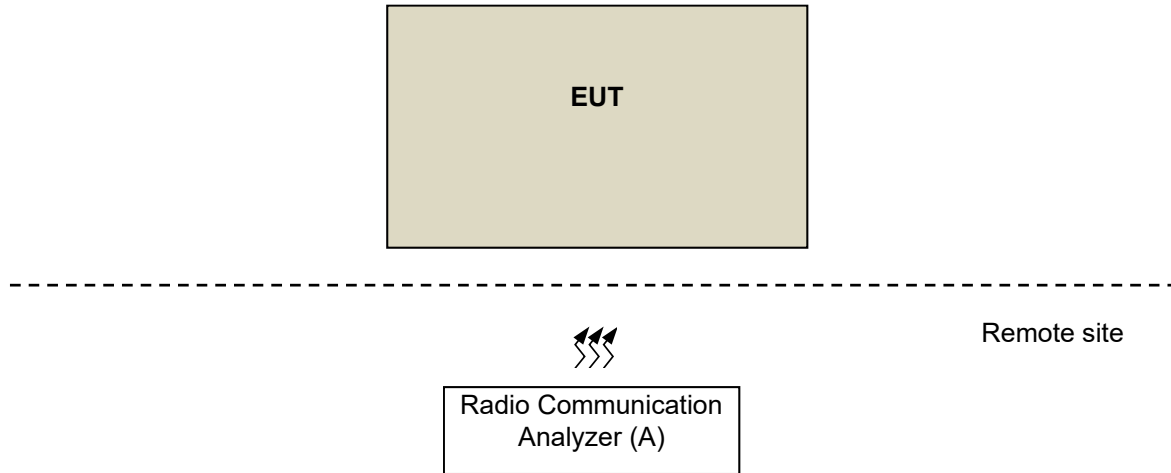

3.2.1 Description of Support Units

The EUT has been tested as an independent unit together with other necessary accessories or support units. The following support units or accessories were used to form a representative test configuration during the tests.

ID	Product	Brand	Model No.	Serial No.	FCC ID	Remarks
A	Radio Communication Analyzer	Anritsu	MT8821C	6201462755	N/A	Provided by Lab

3.3 Test Mode Applicability and Tested Channel Detail

Pre-Scan:	EUT can be used in the following ways: X-axis/ Y-axis/ Z-axis. Pre-scan these ways and find the worst case as a representative test condition.
Worst Case:	X-axis/ Y-axis/ Z-axis Worst Condition: X-axis

EUT Configure Mode	Mode	Power
	A	Power from battery 1
	B	Power from battery 2

Cat-M1 Band 5

EUT Configure Mode	Test item	Available channel	Tested channel	Channel Bandwidth	Modulation	RB #
A	ERP	20407 to 20643	20407 (824.7MHz), 20525 (836.5MHz), 20643 (848.3MHz)	1.4MHz	QPSK / 16QAM	1 Full
		20415 to 20635	20415 (825.5MHz), 20525 (836.5MHz), 20635 (847.5MHz)	3MHz	QPSK / 16QAM	1 Full
		20425 to 20625	20425 (826.5MHz), 20525 (836.5MHz), 20625 (846.5MHz)	5MHz	QPSK / 16QAM	1 Full
		20450 to 20600	20450 (829.0MHz), 20525 (836.5MHz), 20600 (844.0MHz)	10MHz	QPSK / 16QAM	1 Full
A	Modulation Characteristics	20450 to 20600	20525 (836.5MHz)	10MHz	QPSK / 16QAM	Full
A	Frequency Stability	20407 to 20643	20407 (824.7MHz), 20643 (848.3MHz)	1.4MHz	QPSK	Full
		20415 to 20635	20415 (825.5MHz), 20635 (847.5MHz)	3MHz	QPSK	Full
		20425 to 20625	20425 (826.5MHz), 20625 (846.5MHz)	5MHz	QPSK	Full
		20450 to 20600	20450 (829.0MHz), 20600 (844.0MHz)	10MHz	QPSK	Full
A	Occupied Bandwidth	20407 to 20643	20407 (824.7MHz), 20525 (836.5MHz), 20643 (848.3MHz)	1.4MHz	QPSK / 16QAM	Full
		20415 to 20635	20415 (825.5MHz), 20525 (836.5MHz), 20635 (847.5MHz)	3MHz	QPSK / 16QAM	Full
		20425 to 20625	20425 (826.5MHz), 20525 (836.5MHz), 20625 (846.5MHz)	5MHz	QPSK / 16QAM	Full
		20450 to 20600	20450 (829.0MHz), 20525 (836.5MHz), 20600 (844.0MHz)	10MHz	QPSK / 16QAM	Full

EUT Configure Mode	Test item	Available channel	Tested channel	Channel Bandwidth	Modulation	RB #
A	Band Edge	20407 to 20643	20407 (824.7MHz), 20643 (848.3MHz)	1.4MHz	QPSK	1 Full
		20415 to 20635	20415 (825.5MHz), 20635 (847.5MHz)	3MHz	QPSK	1 Full
		20425 to 20625	20425 (826.5MHz), 20625 (846.5MHz)	5MHz	QPSK	1 Full
		20450 to 20600	20450 (829.0MHz), 20600 (844.0MHz)	10MHz	QPSK	1 Full
A	Peak to Average Ratio	20407 to 20643	20407 (824.7MHz), 20525 (836.5MHz), 20643 (848.3MHz)	1.4MHz	QPSK / 16QAM	1
		20415 to 20635	20415 (825.5MHz), 20525 (836.5MHz), 20635 (847.5MHz)	3MHz	QPSK / 16QAM	1
		20425 to 20625	20425 (826.5MHz), 20525 (836.5MHz), 20625 (846.5MHz)	5MHz	QPSK / 16QAM	1
		20450 to 20600	20450 (829.0MHz), 20525 (836.5MHz), 20600 (844.0MHz)	10MHz	QPSK / 16QAM	1
A	Conducted Emission	20407 to 20643	20407 (824.7MHz), 20525 (836.5MHz), 20643 (848.3MHz)	1.4MHz	QPSK	1
		20415 to 20635	20415 (825.5MHz), 20525 (836.5MHz), 20635 (847.5MHz)	3MHz	QPSK	1
		20425 to 20625	20425 (826.5MHz), 20525 (836.5MHz), 20625 (846.5MHz)	5MHz	QPSK	1
		20450 to 20600	20450 (829.0MHz), 20525 (836.5MHz), 20600 (844.0MHz)	10MHz	QPSK	1
A, B	Radiated Emission Below 1GHz	20450 to 20600	20525 (836.5MHz)	10MHz	QPSK	1
A	Radiated Emission Above 1GHz	20407 to 20643	20407 (824.7MHz), 20525 (836.5MHz), 20643 (848.3MHz)	1.4MHz	QPSK	1
		20425 to 20625	20425 (826.5MHz), 20525 (836.5MHz), 20625 (846.5MHz)	5MHz	QPSK	1
		20450 to 20600	20450 (829.0MHz), 20525 (836.5MHz), 20600 (844.0MHz)	10MHz	QPSK	1

Note:

1. This device was tested under all bandwidths, RB configurations and modulations. The worst case was found in QPSK modulation. Therefore, only ERP, modulation characteristics, occupied bandwidth and peak to average ratio items had been tested under QPSK, 16QAM mode, the other items were performed under QPSK mode only.
2. For radiated emission below 1GHz, select the worst radiated emission channel (above 1GHz) for final testing.
3. For radiated emission above 1GHz, according to 3GPP 36.521 Section 6.6.3.1.4, choose the lowest, 5MHz & highest channel bandwidth for final test.

Cat-M1 Band 26

EUT Configure Mode	Test item	Available channel	Tested channel	Channel Bandwidth	Modulation	RB #
A	ERP	26797 to 27033	26797 (824.7MHz), 26915 (836.5MHz), 27033 (848.3MHz)	1.4MHz	QPSK / 16QAM	1 Full
		26805 to 27025	26805 (825.5MHz), 26915 (836.5MHz), 27025 (847.5MHz)	3MHz	QPSK / 16QAM	1 Full
		26815 to 27015	26815 (826.5MHz), 26915 (836.5MHz), 27015 (846.5MHz)	5MHz	QPSK / 16QAM	1 Full
		26840 to 26990	26840 (829.0MHz), 26915 (836.5MHz), 26990 (844.0MHz)	10MHz	QPSK / 16QAM	1 Full
		26865 to 26965	26865 (831.5MHz), 26915 (836.5MHz), 26965 (841.5MHz)	15MHz	QPSK / 16QAM	1 Full
A	Modulation Characteristics	26865 to 26965	26915 (836.5MHz)	15 MHz	QPSK / 16QAM	Full
A	Frequency Stability	26797 to 27033	26797 (824.7MHz), 27033 (848.3MHz)	1.4MHz	QPSK	Full
		26805 to 27025	26805 (825.5MHz), 27025 (847.5MHz)	3MHz	QPSK	Full
		26815 to 27015	26815 (826.5MHz), 27015 (846.5MHz)	5MHz	QPSK	Full
		26840 to 26990	26840 (829.0MHz), 26990 (844.0MHz)	10MHz	QPSK	Full
		26865 to 26965	26865 (831.5MHz), 26965 (841.5MHz)	15MHz	QPSK	Full
A	Occupied Bandwidth	26797 to 27033	26797 (824.7MHz), 26915 (836.5MHz), 27033 (848.3MHz)	1.4MHz	QPSK / 16QAM	Full
		26805 to 27025	26805 (825.5MHz), 26915 (836.5MHz), 27025 (847.5MHz)	3MHz	QPSK / 16QAM	Full
		26815 to 27015	26815 (826.5MHz), 26915 (836.5MHz), 27015 (846.5MHz)	5MHz	QPSK / 16QAM	Full
		26840 to 26990	26840 (829.0MHz), 26915 (836.5MHz), 26990 (844.0MHz)	10MHz	QPSK / 16QAM	Full
		26865 to 26965	26865 (831.5MHz), 26915 (836.5MHz), 26965 (841.5MHz)	15MHz	QPSK / 16QAM	Full

EUT Configure Mode	Test item	Available channel	Tested channel	Channel Bandwidth	Modulation	RB #
A	Band Edge	26797 to 27033	26797 (824.7MHz), 27033 (848.3MHz)	1.4MHz	QPSK	1 Full
		26805 to 27025	26805 (825.5MHz), 27025 (847.5MHz)	3MHz	QPSK	1 Full
		26815 to 27015	26815 (826.5MHz), 27015 (846.5MHz)	5MHz	QPSK	1 Full
		26840 to 26990	26840 (829.0MHz), 26990 (844.0MHz)	10MHz	QPSK	1 Full
		26865 to 26965	26865 (831.5MHz), 26965 (841.5MHz)	15MHz	QPSK	1 Full
A	Peak to Average Ratio	26797 to 27033	26797 (824.7MHz), 26915 (836.5MHz), 27033 (848.3MHz)	1.4MHz	QPSK / 16QAM	1
		26805 to 27025	26805 (825.5MHz), 26915 (836.5MHz), 27025 (847.5MHz)	3MHz	QPSK / 16QAM	1
		26815 to 27015	26815 (826.5MHz), 26915 (836.5MHz), 27015 (846.5MHz)	5MHz	QPSK / 16QAM	1
		26840 to 26990	26840 (829.0MHz), 26915 (836.5MHz), 26990 (844.0MHz)	10MHz	QPSK / 16QAM	1
		26865 to 26965	26865 (831.5MHz), 26915 (836.5MHz), 26965 (841.5MHz)	15MHz	QPSK / 16QAM	1
A	Conducted Emission	26797 to 27033	26797 (824.7MHz), 26915 (836.5MHz), 27033 (848.3MHz)	1.4MHz	QPSK	1
		26805 to 27025	26805 (825.5MHz), 26915 (836.5MHz), 27025 (847.5MHz)	3MHz	QPSK	1
		26815 to 27015	26815 (826.5MHz), 26915 (836.5MHz), 27015 (846.5MHz)	5MHz	QPSK	1
		26840 to 26990	26840 (829.0MHz), 26915 (836.5MHz), 26990 (844.0MHz)	10MHz	QPSK	1
		26865 to 26965	26865 (831.5MHz), 26915 (836.5MHz), 26965 (841.5MHz)	15MHz	QPSK	1

EUT Configure Mode	Test item	Available channel	Tested channel	Channel Bandwidth	Modulation	RB #
A, B	Radiated Emission Below 1GHz	26865 to 26965	26915 (836.5MHz)	15MHz	QPSK	1
A	Radiated Emission Above 1GHz	26797 to 27033	26797 (824.7MHz), 26915 (836.5MHz), 27033 (848.3MHz)	1.4MHz	QPSK	1
		26815 to 27015	26815 (826.5MHz), 26915 (836.5MHz), 27015 (846.5MHz)	5MHz	QPSK	1
		26865 to 26965	26865 (831.5MHz), 26915 (836.5MHz), 26965 (841.5MHz)	15MHz	QPSK	1

Note:

1. This device was tested under all bandwidths, RB configurations and modulations. The worst case was found in QPSK modulation. Therefore, only ERP, modulation characteristics, occupied bandwidth and peak to average ratio items had been tested under QPSK, 16QAM mode, the other items were performed under QPSK mode only.
2. For radiated emission below 1GHz, select the worst radiated emission channel (above 1GHz) for final testing.
3. For radiated emission above 1GHz, according to 3GPP 36.521 Section 6.6.3.1.4, choose the lowest, 5MHz & highest channel bandwidth for final test.

Test Condition:

Test Item	Environmental Conditions	Input Power	Tested By
ERP	25deg. C, 60%RH	7.2Vdc	Willy Cheng
Modulation Characteristics	25deg. C, 60%RH	7.2Vdc	Willy Cheng
Frequency Stability	25deg. C, 60%RH	7.2Vdc	Willy Cheng
Occupied Bandwidth	25deg. C, 60%RH	7.2Vdc	Willy Cheng
Band Edge	25deg. C, 60%RH	7.2Vdc	Willy Cheng
Peak To Average Ratio	25deg. C, 60%RH	7.2Vdc	Willy Cheng
Conducted Emission	25deg. C, 60%RH	7.2Vdc	Willy Cheng
Radiated Emission Below 1GHz	20deg. C, 64%RH	7.2Vdc	Edison Lee
Radiated Emission Above 1GHz	20deg. C, 64%RH	7.2Vdc	Edison Lee

3.4 EUT Operating Conditions

The EUT makes a call to the communication simulator. The communication simulator station system controlled a EUT to export maximum output power under transmission mode and specific channel frequency.

3.5 General Description of Applied Standards and References

The EUT is a RF Product. According to the specifications of the manufacturer, it must comply with the requirements of the following standards:

Test Standard:

FCC 47 CFR Part 2

FCC 47 CFR Part 22

ANSI/TIA/EIA-603-E 2016

ANSI 63.26-2015

References Test Guidance:

KDB 971168 D01 Power Meas License Digital Systems v03r01

All test items have been performed and recorded as per the above standards.

4 Test Types and Results

4.1 Output Power Measurement

4.1.1 Limits of Output Power Measurement

Mobile / Portable station are limited to 7 watts e.r.p.

4.1.2 Test Procedures

Conducted Power Measurement:

The EUT was set up for the maximum power with Cat-M1 link data modulation and link up with simulator (Built-in power meter). The average (rms) power measurement was performed on emulator and power value was measured from power function on emulator. Set the EUT to transmit under low, middle and high channel and record the power level shown on simulator.

Maximum EIRP / ERP

The relevant equation for determining the maximum ERP or EIRP from the measured RF output power is

given in Equation as follows:

$$\text{EIRP} = P_{\text{Meas}} + G_{\text{T}}$$

$$\text{ERP} = P_{\text{Meas}} + G_{\text{T}} - 2.15$$

where

ERP or EIRP effective radiated power or equivalent isotropically radiated power, respectively
(expressed in the same units as P_{Meas} , e.g., dBm or dBW)

P_{Meas} measured transmitter output power or PSD, in dBm or dBW

G_{T} gain of the transmitting antenna, in dBd (ERP) or dBi (EIRP)

4.1.3 Test Setup

Conducted Power Measurement:



4.1.4 Test Results

Conducted Output Power (dBm)

Cat-M1 Band 5						
BW	MCS Index	RB Size	RB Offset	Low	Mid	High
		Channel		20407	20525	20643
		Frequency (MHz)		824.7	836.5	848.3
1.4M	QPSK	1	0	23.44	22.91	23.26
		1	5	23.29	22.75	23.19
		6	0	21.49	20.91	21.37
	16QAM	1	0	22.38	21.83	22.08
		1	5	22.25	21.78	22.90
		6	0	20.39	19.88	20.56
BW	MCS Index	RB Size	RB Offset	Low	Mid	High
		Channel		20415	20525	20635
		Frequency (MHz)		825.5	836.5	847.5
3M	QPSK	1	0	23.26	23.01	23.30
		1	5	23.27	22.74	23.39
		6	0	21.47	20.93	21.34
	16QAM	1	0	22.47	22.10	22.23
		1	5	22.30	21.91	22.24
		6	0	20.34	20.03	20.46
BW	MCS Index	RB Size	RB Offset	Low	Mid	High
		Channel		20425	20525	20625
		Frequency (MHz)		826.5	836.5	846.5
5M	QPSK	1	0	23.35	23.19	23.09
		1	5	23.29	23.16	23.11
		6	0	22.42	22.09	22.21
	16QAM	1	0	23.18	22.70	22.93
		1	5	23.17	22.68	22.91
		6	0	22.24	21.49	21.32
BW	MCS Index	RB Size	RB Offset	Low	Mid	High
		Channel		20450	20525	20600
		Frequency (MHz)		829	836.5	844
10M	QPSK	1	0	23.45	23.26	23.05
		1	5	23.18	22.81	22.84
		6	0	22.49	22.17	22.08
	16QAM	1	0	23.13	22.92	22.82
		1	5	22.89	22.68	22.71
		6	0	21.75	21.26	21.07

Cat-M1 Band 26						
BW	MCS Index	RB Size	RB Offset	Low	Mid	High
		Channel		26797	26915	27033
		Frequency (MHz)		824.7	836.5	848.3
1.4M	QPSK	1	0	22.83	22.97	23.02
		1	5	22.81	22.88	22.99
		6	0	20.98	20.95	21.10
	16QAM	1	0	21.82	21.68	21.95
		1	5	21.73	21.90	21.84
		6	0	19.85	19.78	19.96
BW	MCS Index	RB Size	RB Offset	Low	Mid	High
		Channel		26805	26915	27025
		Frequency (MHz)		825.5	836.5	847.5
3M	QPSK	1	0	22.94	23.04	23.01
		1	5	22.83	22.95	23.04
		6	0	20.84	20.95	21.04
	16QAM	1	0	21.97	22.05	22.12
		1	5	21.96	21.95	22.13
		6	0	19.89	19.98	19.95
BW	MCS Index	RB Size	RB Offset	Low	Mid	High
		Channel		26815	26915	27015
		Frequency (MHz)		826.5	836.5	846.5
5M	QPSK	1	0	22.67	22.90	23.02
		1	5	22.61	22.74	22.87
		6	0	21.88	22.04	22.06
	16QAM	1	0	22.58	22.66	22.86
		1	5	22.48	22.72	22.82
		6	0	21.55	21.98	22.07
BW	MCS Index	RB Size	RB Offset	Low	Mid	High
		Channel		26840	26915	26990
		Frequency (MHz)		829	836.5	844
10M	QPSK	1	0	22.84	22.85	23.00
		1	5	22.55	22.56	22.83
		6	0	21.94	21.94	22.05
	16QAM	1	0	22.57	22.71	22.88
		1	5	22.53	22.52	22.70
		6	0	21.95	21.92	21.88
BW	MCS Index	RB Size	RB Offset	Low	Mid	High
		Channel		26865	26915	26965
		Frequency (MHz)		831.5	836.5	841.5
15M	QPSK	1	0	22.84	23.05	22.92
		1	5	22.65	22.72	22.84
		6	0	22.90	23.02	23.01
	16QAM	1	0	22.54	22.72	22.80
		1	5	22.63	22.63	22.71
		6	0	22.90	22.83	22.59

ERP Power (dBm)

Cat-M1 Band 5						
BW	MCS Index	RB Size	RB Offset	Low	Mid	High
		Channel		20407	20525	20643
		Frequency (MHz)		824.7	836.5	848.3
1.4M	QPSK	1	0	23.23	22.70	23.05
		1	5	23.08	22.54	22.98
		6	0	21.28	20.70	21.16
	16QAM	1	0	22.17	21.62	21.87
		1	5	22.04	21.57	22.69
		6	0	20.18	19.67	20.35
BW	MCS Index	RB Size	RB Offset	Low	Mid	High
		Channel		20415	20525	20635
		Frequency (MHz)		825.5	836.5	847.5
3M	QPSK	1	0	23.05	22.80	23.09
		1	5	23.06	22.53	23.18
		6	0	21.26	20.72	21.13
	16QAM	1	0	22.26	21.89	22.02
		1	5	22.09	21.70	22.03
		6	0	20.13	19.82	20.25
BW	MCS Index	RB Size	RB Offset	Low	Mid	High
		Channel		20425	20525	20625
		Frequency (MHz)		826.5	836.5	846.5
5M	QPSK	1	0	23.14	22.98	22.88
		1	5	23.08	22.95	22.90
		6	0	22.21	21.88	22.00
	16QAM	1	0	22.97	22.49	22.72
		1	5	22.96	22.47	22.70
		6	0	22.03	21.28	21.11
BW	MCS Index	RB Size	RB Offset	Low	Mid	High
		Channel		20450	20525	20600
		Frequency (MHz)		829	836.5	844
10M	QPSK	1	0	23.24	23.05	22.84
		1	5	22.97	22.60	22.63
		6	0	22.28	21.96	21.87
	16QAM	1	0	22.92	22.71	22.61
		1	5	22.68	22.47	22.50
		6	0	21.54	21.05	20.86

*ERP = Conducted + antenna gain (1.94dBi) - 2.15

Cat-M1 Band 26						
BW	MCS Index	RB Size	RB Offset	Low	Mid	High
		Channel		26797	26915	27033
		Frequency (MHz)		824.7	836.5	848.3
1.4M	QPSK	1	0	22.62	22.76	22.81
		1	5	22.60	22.67	22.78
		6	0	20.77	20.74	20.89
	16QAM	1	0	21.61	21.47	21.74
		1	5	21.52	21.69	21.63
		6	0	19.64	19.57	19.75
BW	MCS Index	RB Size	RB Offset	Low	Mid	High
		Channel		26805	26915	27025
		Frequency (MHz)		825.5	836.5	847.5
3M	QPSK	1	0	22.73	22.83	22.80
		1	5	22.62	22.74	22.83
		6	0	20.63	20.74	20.83
	16QAM	1	0	21.76	21.84	21.91
		1	5	21.75	21.74	21.92
		6	0	19.68	19.77	19.74
BW	MCS Index	RB Size	RB Offset	Low	Mid	High
		Channel		26815	26915	27015
		Frequency (MHz)		826.5	836.5	846.5
5M	QPSK	1	0	22.46	22.69	22.81
		1	5	22.40	22.53	22.66
		6	0	21.67	21.83	21.85
	16QAM	1	0	22.37	22.45	22.65
		1	5	22.27	22.51	22.61
		6	0	21.34	21.77	21.86
BW	MCS Index	RB Size	RB Offset	Low	Mid	High
		Channel		26840	26915	26990
		Frequency (MHz)		829	836.5	844
10M	QPSK	1	0	22.63	22.64	22.79
		1	5	22.34	22.35	22.62
		6	0	21.73	21.73	21.84
	16QAM	1	0	22.36	22.50	22.67
		1	5	22.32	22.31	22.49
		6	0	21.74	21.71	21.67

*ERP = Conducted + antenna gain (1.94dBi) - 2.15

Cat-M1 Band 26						
BW	MCS Index	RB Size	RB Offset	Low	Mid	High
		Channel		26865	26915	26965
		Frequency (MHz)		831.5	836.5	841.5
15M	QPSK	1	0	22.63	22.84	22.71
		1	5	22.44	22.51	22.63
		6	0	22.69	22.81	22.80
	16QAM	1	0	22.33	22.51	22.59
		1	5	22.42	22.42	22.50
		6	0	22.69	22.62	22.38

*ERP = Conducted + antenna gain (1.94dBi) - 2.15

4.2 Modulation Characteristics Measurement

4.2.1 Limits of Modulation Characteristics

N/A

4.2.2 Test Procedure

Connect the EUT to Communication Simulator via the antenna connector. The frequency band is set as EUT supported Modulation and Channels, the EUT output is matched with 50 ohm load, the waveform quality and constellation of the EUT was tested.

4.2.3 Test Setup



4.2.4 Test Results

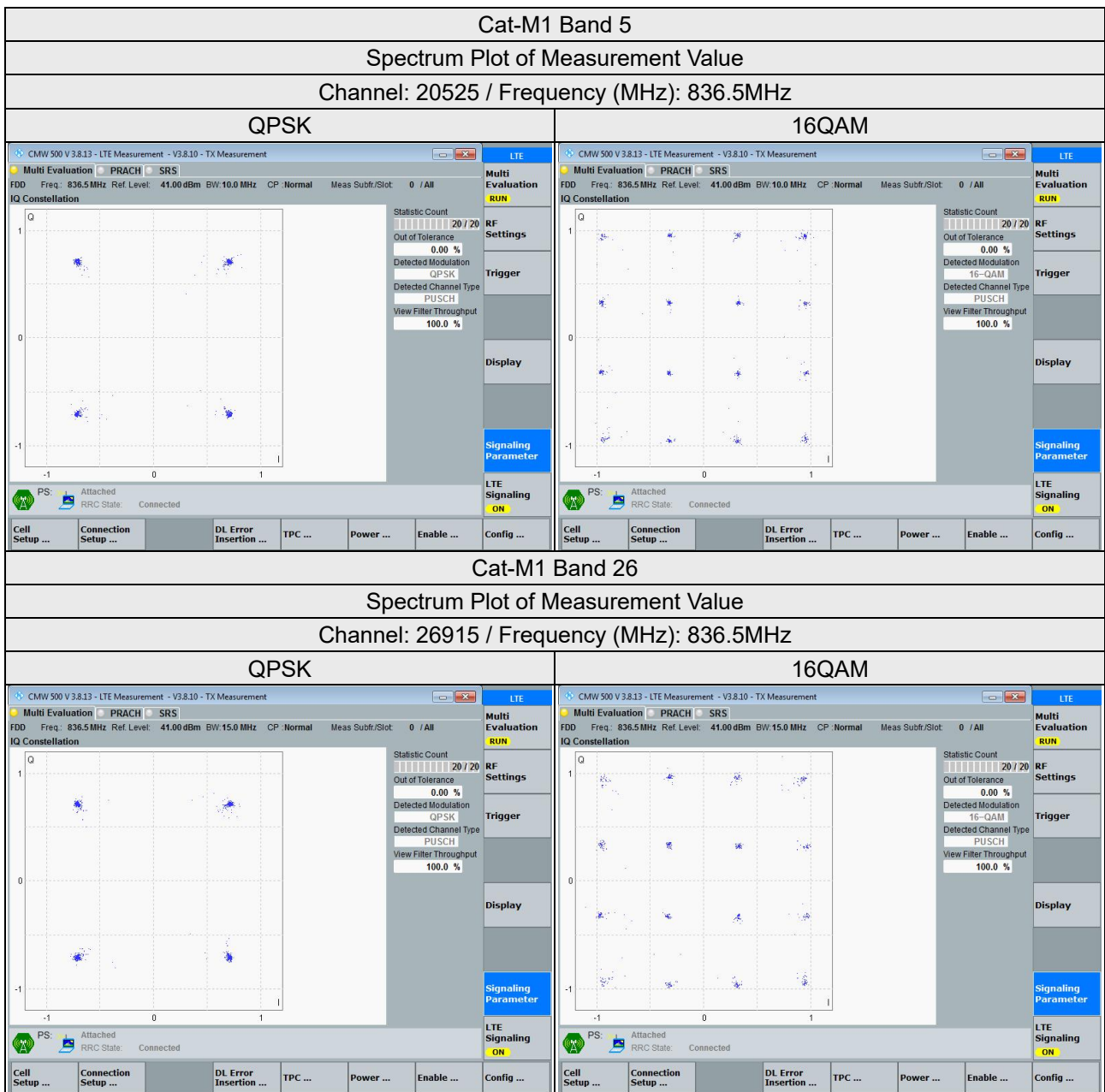

4.3 Frequency Stability Measurement

4.3.1 Limits of Frequency Stability Measurement

1.5 ppm is for base and fixed station. 2.5 ppm is for mobile station.

4.3.2 Test Procedure

- a. Device is placed at the oven room. The oven room could control the temperatures and humidity. Power warm up is at least 15 min and power applied should perform before recording frequency error.
- b. EUT is connected the external power supply to control the DC input power. The test voltage range is from minimum to maximum working voltage. Each step shall be record the frequency error rate.
- c. The temperature range step is 10 degrees in this test items. All temperature levels shall be hold the ± 0.5 °C during the measurement testing. The each temperature step shall be at least 0.5 hours, consider the EUT could be test under the stability condition.

Note: The frequency error was recorded frequency error from the communication simulator.

4.3.3 Test Instruments

Description & Manufacturer	Model No.	Serial No.	Cal. Date	Cal. Due
Radio Communication Analyzer Anritsu	MT8821C	6261806803	Feb. 18, 2023	Feb. 17, 2024
Temperature & Humidity Chamber TERCHY	HRM-120RF	931022	Dec. 27, 2022	Dec. 26, 2023
Digital Multimeter Fluke	87-III	70360742	Jun. 23, 2022	Jun. 22, 2023
DC Power Supply Topward	6306A	727263	NA	NA

Note: 1. The calibration interval of the above test instruments is 12 months and the calibrations are traceable to NML/ROC and NIST/USA.

4.3.4 Test Setup

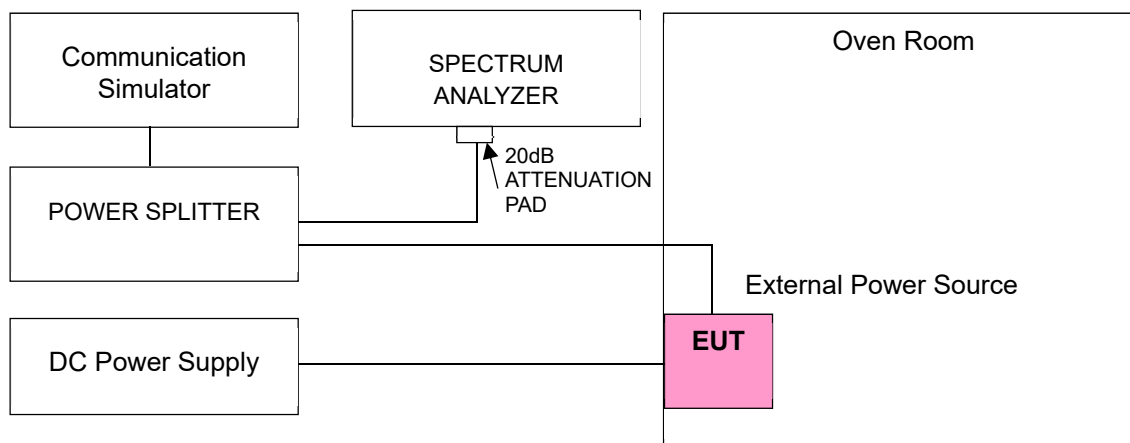

4.3.5 Test Results

Frequency Error vs. Voltage

Voltage (Vdc)	Cat-M1 Band 5			
	Channel Bandwidth 1.4 MHz			
	Low Channel		High Channel	
	Frequency (MHz)	Frequency Error (ppm)	Frequency (MHz)	Frequency Error (ppm)
6.12	824.7000020	0.002	848.2999970	-0.004
7.2	824.7000040	0.005	848.2999960	-0.005
8.28	824.7000040	0.005	848.2999980	-0.002

Note: The applicant defined the normal working voltage is from 6.12Vdc to 8.28Vdc.

Frequency Error vs. Temperature

Temp. (°C)	Cat-M1 Band 5			
	Channel Bandwidth 1.4 MHz			
	Low Channel		High Channel	
	Frequency (MHz)	Frequency Error (ppm)	Frequency (MHz)	Frequency Error (ppm)
-40	824.6999960	-0.005	848.2999990	-0.001
-30	824.7000020	0.002	848.3000020	0.002
-20	824.6999960	-0.005	848.3000010	0.001
-10	824.6999990	-0.001	848.3000020	0.002
0	824.6999970	-0.004	848.2999960	-0.005
10	824.6999990	-0.001	848.2999990	-0.001
20	824.6999990	-0.001	848.2999960	-0.005
30	824.6999960	-0.005	848.3000030	0.004
40	824.6999990	-0.001	848.2999970	-0.004
50	824.7000010	0.001	848.3000040	0.005
60	824.7000030	0.004	848.2999990	-0.001
70	824.6999960	-0.005	848.3000010	0.001

Frequency Error vs. Voltage

Voltage (Vdc)	Cat-M1 Band 5			
	Channel Bandwidth 3 MHz			
	Low Channel		High Channel	
	Frequency (MHz)	Frequency Error (ppm)	Frequency (MHz)	Frequency Error (ppm)
6.12	825.5000040	0.005	847.4999970	-0.004
7.2	825.5000010	0.001	847.5000010	0.001
8.28	825.4999980	-0.002	847.5000020	0.002

Note: The applicant defined the normal working voltage is from 6.12Vdc to 8.28Vdc.

Frequency Error vs. Temperature

Temp. (°C)	Cat-M1 Band 5			
	Channel Bandwidth 3 MHz			
	Low Channel		High Channel	
	Frequency (MHz)	Frequency Error (ppm)	Frequency (MHz)	Frequency Error (ppm)
-40	825.4999970	-0.004	847.4999960	-0.005
-30	825.4999970	-0.004	847.5000010	0.001
-20	825.5000040	0.005	847.4999960	-0.005
-10	825.5000030	0.004	847.4999970	-0.004
0	825.4999960	-0.005	847.4999970	-0.004
10	825.5000020	0.002	847.5000030	0.004
20	825.5000030	0.004	847.5000030	0.004
30	825.5000020	0.002	847.4999990	-0.001
40	825.4999980	-0.002	847.4999960	-0.005
50	825.5000020	0.002	847.5000040	0.005
60	825.5000020	0.002	847.5000030	0.004
70	825.4999960	-0.005	847.4999970	-0.004

Frequency Error vs. Voltage

Voltage (Vdc)	Cat-M1 Band 5			
	Channel Bandwidth 5 MHz			
	Low Channel		High Channel	
	Frequency (MHz)	Frequency Error (ppm)	Frequency (MHz)	Frequency Error (ppm)
6.12	826.5000010	0.001	846.5000040	0.005
7.2	826.5000040	0.005	846.4999960	-0.005
8.28	826.4999990	-0.001	846.4999990	-0.001

Note: The applicant defined the normal working voltage is from 6.12Vdc to 8.28Vdc.

Frequency Error vs. Temperature

Temp. (°C)	Cat-M1 Band 5			
	Channel Bandwidth 5 MHz			
	Low Channel		High Channel	
	Frequency (MHz)	Frequency Error (ppm)	Frequency (MHz)	Frequency Error (ppm)
-40	826.4999980	-0.002	846.4999970	-0.004
-30	826.4999970	-0.004	846.4999980	-0.002
-20	826.5000010	0.001	846.5000030	0.004
-10	826.5000040	0.005	846.5000010	0.001
0	826.4999980	-0.002	846.5000020	0.002
10	826.4999980	-0.002	846.5000010	0.001
20	826.5000010	0.001	846.4999970	-0.004
30	826.4999970	-0.004	846.5000040	0.005
40	826.4999980	-0.002	846.4999980	-0.002
50	826.4999980	-0.002	846.4999960	-0.005
60	826.4999990	-0.001	846.5000020	0.002
70	826.4999990	-0.001	846.5000040	0.005

Frequency Error vs. Voltage

Voltage (Vdc)	Cat-M1 Band 5			
	Channel Bandwidth 10 MHz			
	Low Channel		High Channel	
	Frequency (MHz)	Frequency Error (ppm)	Frequency (MHz)	Frequency Error (ppm)
6.12	828.9999970	-0.004	843.9999970	-0.004
7.2	828.9999990	-0.001	844.0000020	0.002
8.28	829.0000010	0.001	844.0000040	0.005

Note: The applicant defined the normal working voltage is from 6.12Vdc to 8.28Vdc.

Frequency Error vs. Temperature

Temp. (°C)	Cat-M1 Band 5			
	Channel Bandwidth 10 MHz			
	Low Channel		High Channel	
	Frequency (MHz)	Frequency Error (ppm)	Frequency (MHz)	Frequency Error (ppm)
-40	829.0000020	0.002	844.0000040	0.005
-30	828.9999980	-0.002	844.0000020	0.002
-20	828.9999990	-0.001	843.9999970	-0.004
-10	828.9999970	-0.004	844.0000010	0.001
0	829.0000040	0.005	844.0000020	0.002
10	829.0000040	0.005	844.0000040	0.005
20	829.0000040	0.005	844.0000010	0.001
30	829.0000010	0.001	844.0000030	0.004
40	828.9999960	-0.005	844.0000040	0.005
50	829.0000010	0.001	843.9999960	-0.005
60	829.0000010	0.001	843.9999960	-0.005
70	829.0000040	0.005	844.0000040	0.005

Frequency Error vs. Voltage

Voltage (Vdc)	Cat-M1 Band 26			
	Channel Bandwidth: 1.4 MHz			
	Low Channel		High Channel	
	Frequency (MHz)	Frequency Error (ppm)	Frequency (MHz)	Frequency Error (ppm)
6.12	824.6999970	-0.004	848.3000030	0.004
7.2	824.7000030	0.004	848.3000040	0.005
8.28	824.7000010	0.001	848.2999970	-0.004

Note: The applicant defined the normal working voltage is from 6.12Vdc to 8.28Vdc.

Frequency Error vs. Temperature

Temp. (°C)	Cat-M1 Band 26			
	Channel Bandwidth: 1.4 MHz			
	Low Channel		High Channel	
	Frequency (MHz)	Frequency Error (ppm)	Frequency (MHz)	Frequency Error (ppm)
-40	824.7000020	0.002	848.2999960	-0.005
-30	824.6999970	-0.004	848.3000020	0.002
-20	824.7000020	0.002	848.2999970	-0.004
-10	824.6999960	-0.005	848.2999970	-0.004
0	824.6999990	-0.001	848.3000030	0.004
10	824.6999970	-0.004	848.2999980	-0.002
20	824.7000030	0.004	848.3000030	0.004
30	824.6999990	-0.001	848.3000020	0.002
40	824.7000010	0.001	848.3000040	0.005
50	824.7000030	0.004	848.3000030	0.004
60	824.6999970	-0.004	848.3000010	0.001
70	824.7000020	0.002	848.2999970	-0.004

Frequency Error vs. Voltage

Voltage (Vdc)	Cat-M1 Band 26			
	Channel Bandwidth: 3 MHz			
	Low Channel		High Channel	
	Frequency (MHz)	Frequency Error (ppm)	Frequency (MHz)	Frequency Error (ppm)
6.12	825.4999960	-0.005	847.4999980	-0.002
7.2	825.5000040	0.005	847.4999990	-0.001
8.28	825.4999980	-0.002	847.4999990	-0.001

Note: The applicant defined the normal working voltage is from 6.12Vdc to 8.28Vdc.

Frequency Error vs. Temperature

Temp. (°C)	Cat-M1 Band 26			
	Channel Bandwidth: 3 MHz			
	Low Channel		High Channel	
	Frequency (MHz)	Frequency Error (ppm)	Frequency (MHz)	Frequency Error (ppm)
-40	825.4999990	-0.001	847.4999990	-0.001
-30	825.5000030	0.004	847.5000020	0.002
-20	825.5000030	0.004	847.5000030	0.004
-10	825.4999990	-0.001	847.4999960	-0.005
0	825.5000030	0.004	847.4999980	-0.002
10	825.5000040	0.005	847.5000040	0.005
20	825.4999990	-0.001	847.5000020	0.002
30	825.5000040	0.005	847.4999960	-0.005
40	825.4999960	-0.005	847.4999980	-0.002
50	825.5000030	0.004	847.4999970	-0.004
60	825.4999980	-0.002	847.5000010	0.001
70	825.5000040	0.005	847.5000020	0.002

Frequency Error vs. Voltage

Voltage (Vdc)	Cat-M1 Band 26			
	Channel Bandwidth: 5 MHz			
	Low Channel		High Channel	
	Frequency (MHz)	Frequency Error (ppm)	Frequency (MHz)	Frequency Error (ppm)
6.12	826.4999980	-0.002	846.4999990	-0.001
7.2	826.5000040	0.005	846.4999980	-0.002
8.28	826.4999960	-0.005	846.4999970	-0.004

Note: The applicant defined the normal working voltage is from 6.12Vdc to 8.28Vdc.

Frequency Error vs. Temperature

Temp. (°C)	Cat-M1 Band 26			
	Channel Bandwidth: 5 MHz			
	Low Channel		High Channel	
	Frequency (MHz)	Frequency Error (ppm)	Frequency (MHz)	Frequency Error (ppm)
-40	826.5000020	0.002	846.4999960	-0.005
-30	826.4999980	-0.002	846.4999980	-0.002
-20	826.4999990	-0.001	846.4999990	-0.001
-10	826.4999960	-0.005	846.4999960	-0.005
0	826.4999990	-0.001	846.4999980	-0.002
10	826.4999970	-0.004	846.4999990	-0.001
20	826.5000040	0.005	846.5000010	0.001
30	826.5000030	0.004	846.5000030	0.004
40	826.4999990	-0.001	846.4999970	-0.004
50	826.4999960	-0.005	846.4999960	-0.005
60	826.4999970	-0.004	846.5000010	0.001
70	826.5000010	0.001	846.5000010	0.001

Frequency Error vs. Voltage

Voltage (Vdc)	Cat-M1 Band 26			
	Channel Bandwidth: 10 MHz			
	Low Channel		High Channel	
	Frequency (MHz)	Frequency Error (ppm)	Frequency (MHz)	Frequency Error (ppm)
6.12	829.0000030	0.004	843.9999960	-0.005
7.2	828.9999970	-0.004	844.0000020	0.002
8.28	828.9999960	-0.005	844.0000030	0.004

Note: The applicant defined the normal working voltage is from 6.12Vdc to 8.28Vdc.

Frequency Error vs. Temperature

Temp. (°C)	Cat-M1 Band 26			
	Channel Bandwidth: 10 MHz			
	Low Channel		High Channel	
	Frequency (MHz)	Frequency Error (ppm)	Frequency (MHz)	Frequency Error (ppm)
-40	828.9999960	-0.005	843.9999960	-0.005
-30	828.9999980	-0.002	843.9999990	-0.001
-20	829.0000040	0.005	843.9999960	-0.005
-10	828.9999980	-0.002	843.9999970	-0.004
0	828.9999980	-0.002	843.9999960	-0.005
10	828.9999980	-0.002	844.0000030	0.004
20	829.0000040	0.005	844.0000030	0.004
30	828.9999980	-0.002	844.0000020	0.002
40	829.0000020	0.002	843.9999980	-0.002
50	828.9999990	-0.001	844.0000010	0.001
60	829.0000020	0.002	844.0000030	0.004
70	828.9999990	-0.001	844.0000010	0.001

Frequency Error vs. Voltage

Voltage (Vdc)	Cat-M1 Band 26			
	Channel Bandwidth: 15 MHz			
	Low Channel		High Channel	
	Frequency (MHz)	Frequency Error (ppm)	Frequency (MHz)	Frequency Error (ppm)
6.12	831.5000010	0.001	841.4999960	-0.005
7.2	831.4999980	-0.002	841.5000040	0.005
8.28	831.5000020	0.002	841.4999990	-0.001

Note: The applicant defined the normal working voltage is from 6.12Vdc to 8.28Vdc.

Frequency Error vs. Temperature

Temp. (°C)	Cat-M1 Band 26			
	Channel Bandwidth: 15 MHz			
	Low Channel		High Channel	
	Frequency (MHz)	Frequency Error (ppm)	Frequency (MHz)	Frequency Error (ppm)
-40	831.4999980	-0.002	841.5000030	0.004
-30	831.5000010	0.001	841.5000020	0.002
-20	831.5000040	0.005	841.4999960	-0.005
-10	831.4999980	-0.002	841.5000040	0.005
0	831.4999960	-0.005	841.5000040	0.005
10	831.4999960	-0.005	841.5000020	0.002
20	831.4999980	-0.002	841.4999960	-0.005
30	831.5000040	0.005	841.5000040	0.005
40	831.5000020	0.002	841.4999960	-0.005
50	831.4999970	-0.004	841.4999980	-0.002
60	831.5000010	0.001	841.4999960	-0.005
70	831.5000020	0.002	841.5000020	0.002

4.4 Occupied Bandwidth Measurement

4.4.1 Limits of Occupied Bandwidth Measurement

The occupied bandwidth (OBW), that is the frequency bandwidth such that, below its lower and above its upper frequency limits, the mean powers radiated are each equal to 0.5 % of the total mean power radiated by a given emission.

4.4.2 Test Procedure

For the 26dBc bandwidth measurement method, please refer to section 5.4.3 of ANSI C63.26.

- a) The spectrum analyzer center frequency is set to the nominal EUT channel center frequency. The span range for the spectrum analyzer shall be wide enough to see sufficient roll off of the signal to make the measurement.
- b) The nominal RBW shall be in the range of 1% to 5% of the anticipated OBW, and the VBW shall be set $\geq 3 \times \text{RBW}$.
- c) Set the reference level of the instrument as required to prevent the signal amplitude from exceeding the maximum spectrum analyzer input mixer level for linear operation. See guidance provided in 4.2.3.
- d) The dynamic range of the spectrum analyzer at the selected RBW shall be more than 10 dB below the target “-X dB” requirement, i.e., if the requirement calls for measuring the -26 dB OBW, the spectrum analyzer noise floor at the selected RBW shall be at least 36 dB below the reference level.
- e) Set spectrum analyzer detection mode to peak, and the trace mode to max hold.
- f) Determine the following reference values: Set the EUT to transmit a modulated signal. Allow the trace to stabilize. Set the spectrum analyzer marker to the highest level of the displayed trace (this is the reference value).
- g) Determine the “-X dB amplitude” as equal to (Reference Value - X). Alternatively, this calculation can be performed on the spectrum analyzer using the delta-marker measurement function.
- h) Place two markers, one at the lowest and the other at the highest frequency of the envelope of the spectral display such that each marker is at or slightly below the “-X dB amplitude” determined in step f). If a marker is below this “-X dB amplitude” value it should be as close as possible to this value. The OBW is the positive frequency difference between the two markers.
- i) The OBW shall be reported by providing plot(s) of the measuring instrument display, to include markers depicting the relevant frequency and amplitude information (e.g., marker table). The frequency and amplitude axis and scale shall be clearly labeled. Tabular data may be reported in addition to the plot(s).

For the occupied bandwidth measurement method, please refer to section 5.4.4 of ANSI C63.26.

4.4.3 Test Setup

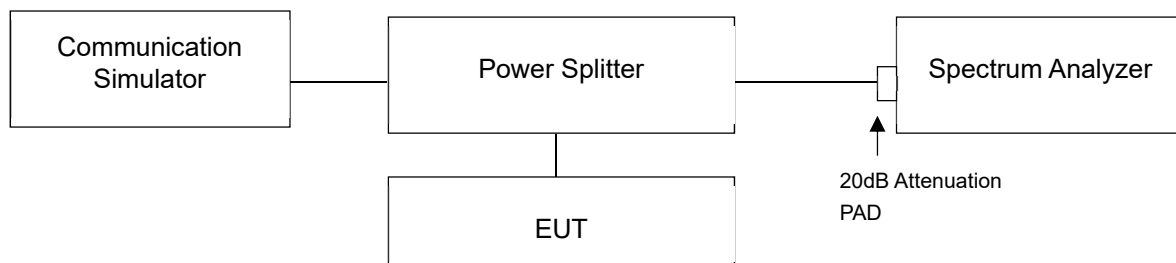

4.4.4 Test Result

Occupied Bandwidth

Cat-M1 Band 5, Channel Bandwidth 1.4MHz			
Channel	Frequency (MHz)	99% Occupied Bandwidth (MHz)	
		QPSK	16QAM
20407	824.7	1.0855	1.0835
20525	836.5	1.0834	1.0825
20643	848.3	1.0834	1.0839
Cat-M1 Band 5, Channel Bandwidth 3MHz			
Channel	Frequency (MHz)	99% Occupied Bandwidth (MHz)	
		QPSK	16QAM
20415	825.5	1.0833	1.0840
20525	836.5	1.0838	1.0831
20635	847.5	1.0825	1.0834
Cat-M1 Band 5, Channel Bandwidth 5MHz			
Channel	Frequency (MHz)	99% Occupied Bandwidth (MHz)	
		QPSK	16QAM
20425	826.5	1.0875	1.0873
20525	836.5	1.0876	1.0878
20625	846.5	1.0874	1.0879
Cat-M1 Band 5, Channel Bandwidth 10MHz			
Channel	Frequency (MHz)	99% Occupied Bandwidth (MHz)	
		QPSK	16QAM
20450	829.0	1.0879	1.0874
20525	836.5	1.0873	1.0876
20600	844.0	1.0892	1.0872

Spectrum Plot of Worst Value

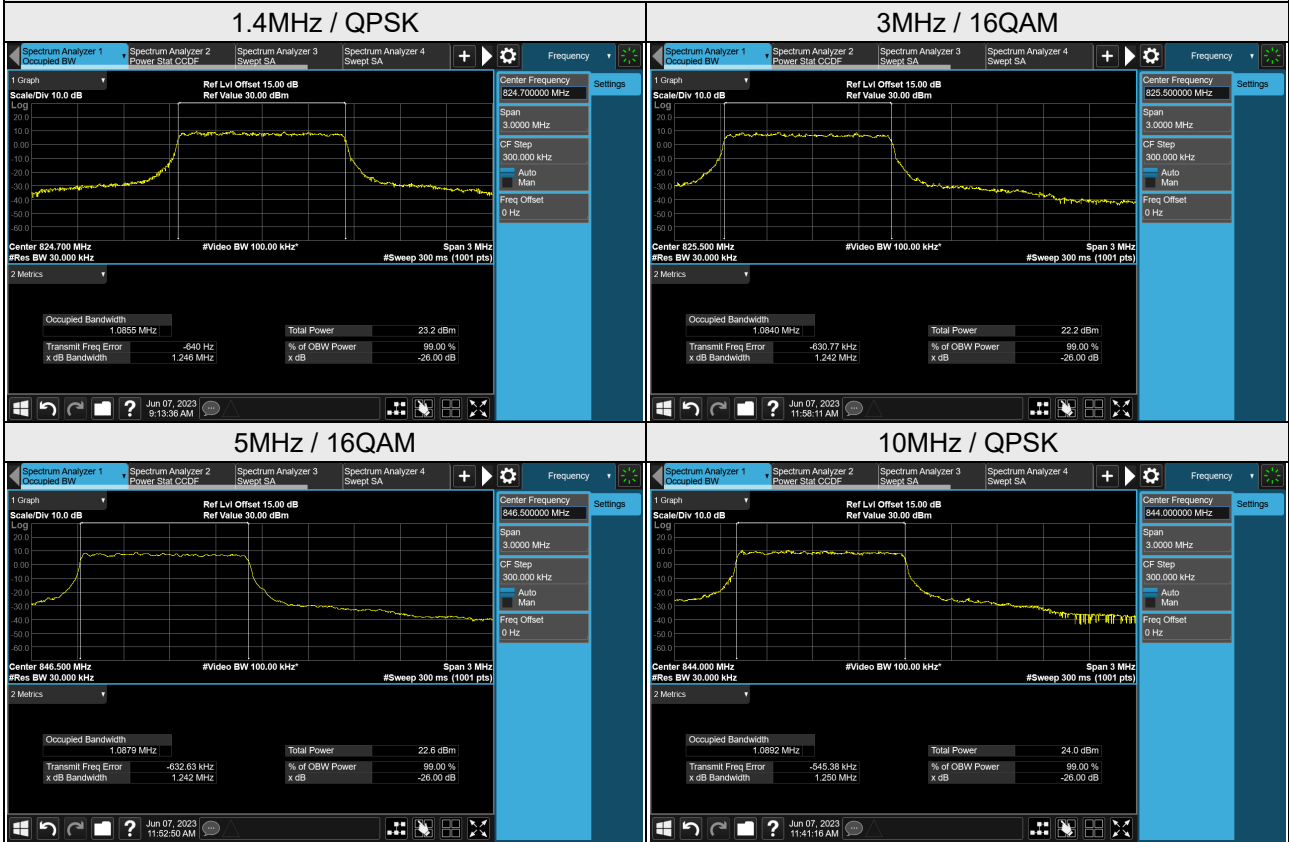

Cat-M1 Band 26, Channel Bandwidth 1.4MHz			
Channel	Frequency (MHz)	99% Occupied Bandwidth (MHz)	
		QPSK	16QAM
26797	824.7	1.0859	1.0832
26915	836.5	1.0855	1.0843
27033	848.3	1.0856	1.0840
Cat-M1 Band 26, Channel Bandwidth 3MHz			
Channel	Frequency (MHz)	99% Occupied Bandwidth (MHz)	
		QPSK	16QAM
26805	825.5	1.0818	1.0836
26915	836.5	1.0847	1.0843
27025	847.5	1.0840	1.0832
Cat-M1 Band 26, Channel Bandwidth 5MHz			
Channel	Frequency (MHz)	99% Occupied Bandwidth (MHz)	
		QPSK	16QAM
26815	826.5	1.0771	1.0861
26915	836.5	1.0773	1.0849
27015	846.5	1.0760	1.0865
Cat-M1 Band 26, Channel Bandwidth 10MHz			
Channel	Frequency (MHz)	99% Occupied Bandwidth (MHz)	
		QPSK	16QAM
26840	829.0	1.0775	1.0872
26915	836.5	1.0757	1.0877
26990	844.0	1.0777	1.0887
Cat-M1 Band 26, Channel Bandwidth 15MHz			
Channel	Frequency (MHz)	99% Occupied Bandwidth (MHz)	
		QPSK	16QAM
26865	831.5	1.0773	1.0872
26915	836.5	1.0781	1.0859
26965	841.5	1.0770	1.0879

Spectrum Plot of Worst Value

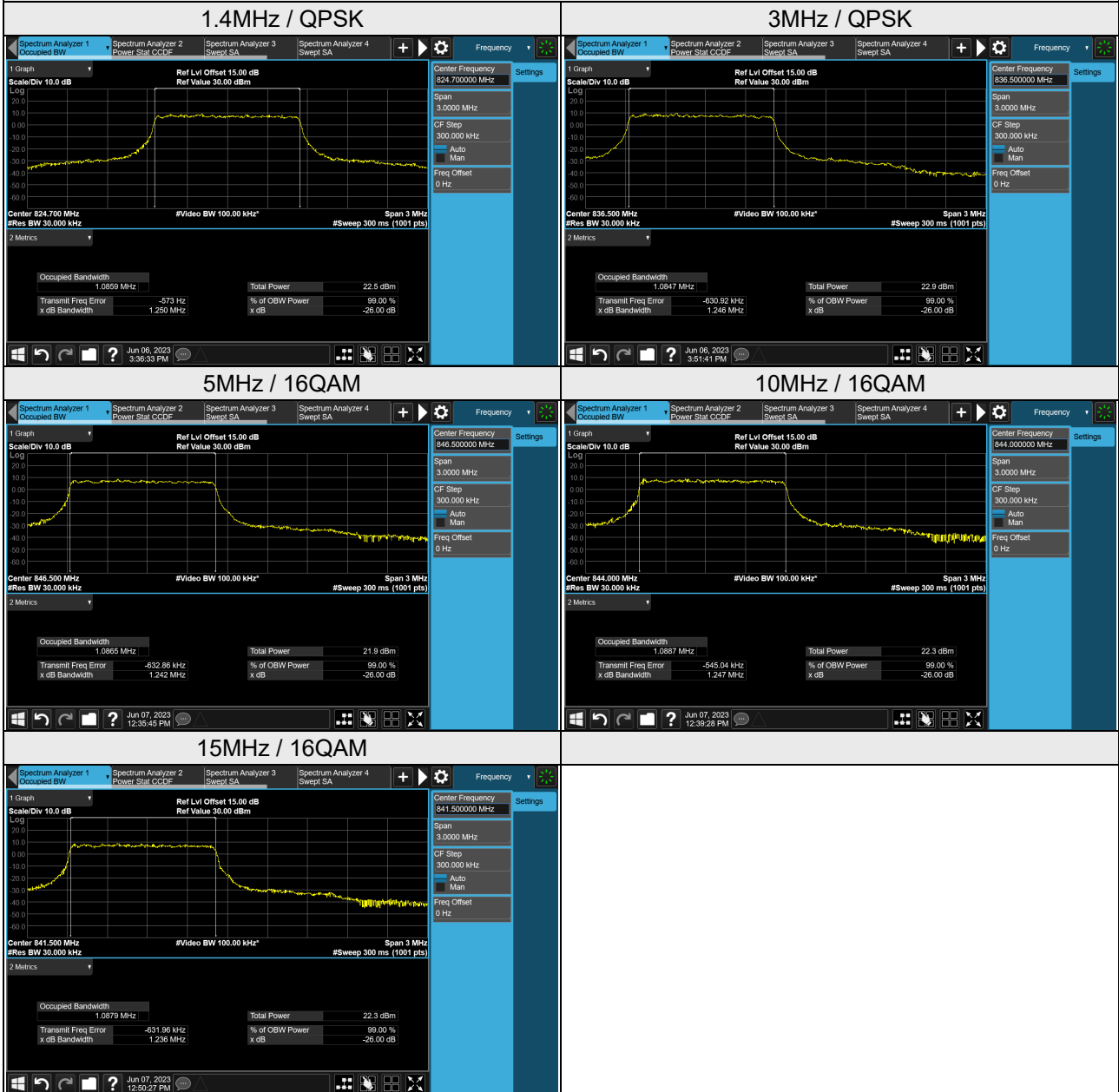

26dB Bandwidth

Cat-M1 Band 5, Channel Bandwidth 1.4MHz			
Channel	Frequency (MHz)	26dB Bandwidth (MHz)	
		QPSK	16QAM
20407	824.7	1.246	1.243
20525	836.5	1.247	1.230
20643	848.3	1.242	1.246
Cat-M1 Band 5, Channel Bandwidth 3MHz			
Channel	Frequency (MHz)	26dB Bandwidth (MHz)	
		QPSK	16QAM
20415	825.5	1.238	1.242
20525	836.5	1.248	1.248
20635	847.5	1.243	1.242
Cat-M1 Band 5, Channel Bandwidth 5MHz			
Channel	Frequency (MHz)	26dB Bandwidth (MHz)	
		QPSK	16QAM
20425	826.5	1.259	1.267
20525	836.5	1.256	1.235
20625	846.5	1.259	1.242
Cat-M1 Band 5, Channel Bandwidth 10MHz			
Channel	Frequency (MHz)	26dB Bandwidth (MHz)	
		QPSK	16QAM
20450	829.0	1.252	1.248
20525	836.5	1.255	1.251
20600	844.0	1.250	1.248

Spectrum Plot of Worst Value

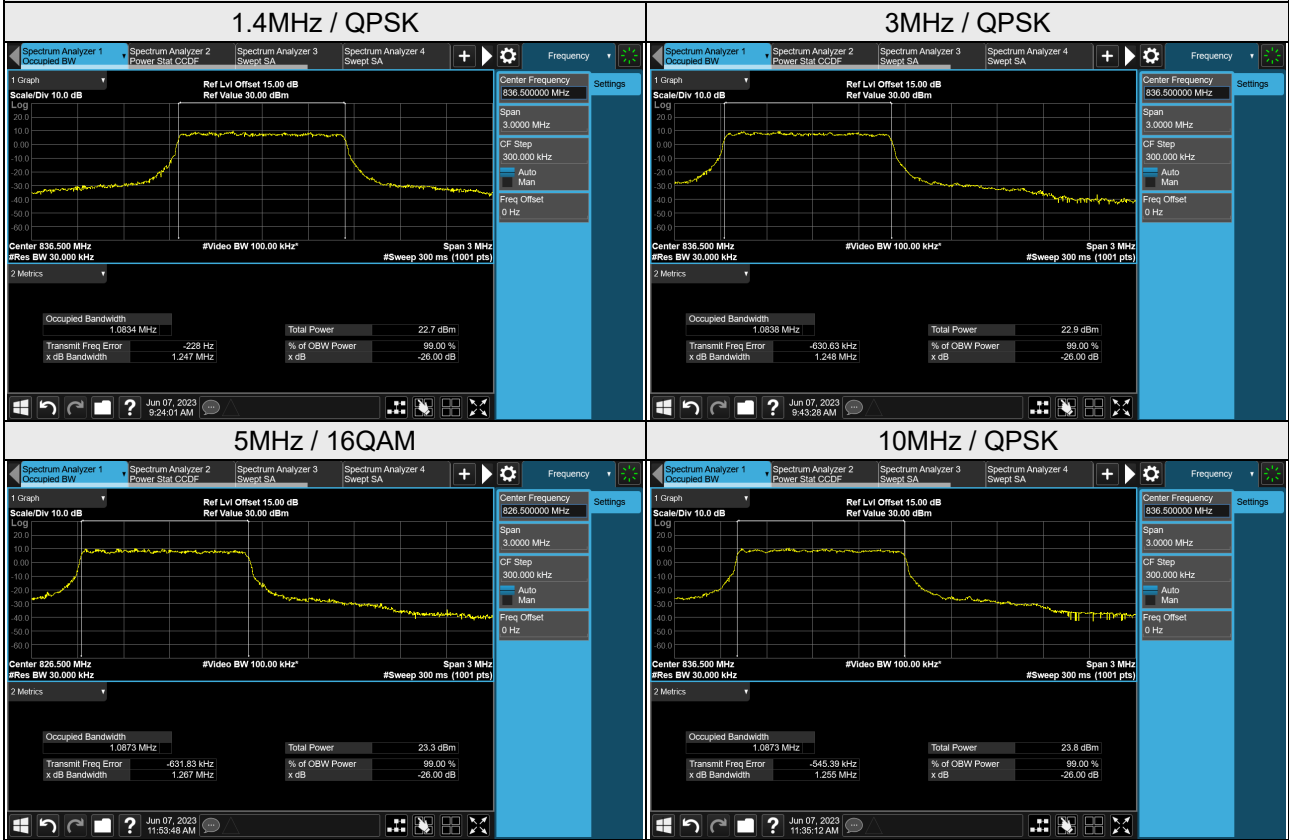

Cat-M1 Band 26, Channel Bandwidth 1.4MHz			
Channel	Frequency (MHz)	26dB Bandwidth (MHz)	
		QPSK	16QAM
26797	824.7	1.250	1.247
26915	836.5	1.247	1.246
27033	848.3	1.246	1.243
Cat-M1 Band 26, Channel Bandwidth 3MHz			
Channel	Frequency (MHz)	26dB Bandwidth (MHz)	
		QPSK	16QAM
26805	825.5	1.242	1.246
26915	836.5	1.246	1.237
27025	847.5	1.247	1.246
Cat-M1 Band 26, Channel Bandwidth 5MHz			
Channel	Frequency (MHz)	26dB Bandwidth (MHz)	
		QPSK	16QAM
26815	826.5	1.215	1.259
26915	836.5	1.213	1.240
27015	846.5	1.218	1.242
Cat-M1 Band 26, Channel Bandwidth 10MHz			
Channel	Frequency (MHz)	26dB Bandwidth (MHz)	
		QPSK	16QAM
26840	829.0	1.237	1.247
26915	836.5	1.233	1.240
26990	844.0	1.245	1.247
Cat-M1 Band 26, Channel Bandwidth 15MHz			
Channel	Frequency (MHz)	26dB Bandwidth (MHz)	
		QPSK	16QAM
26865	831.5	1.283	1.238
26915	836.5	1.254	1.232
26965	841.5	1.219	1.236

Spectrum Plot of Worst Value

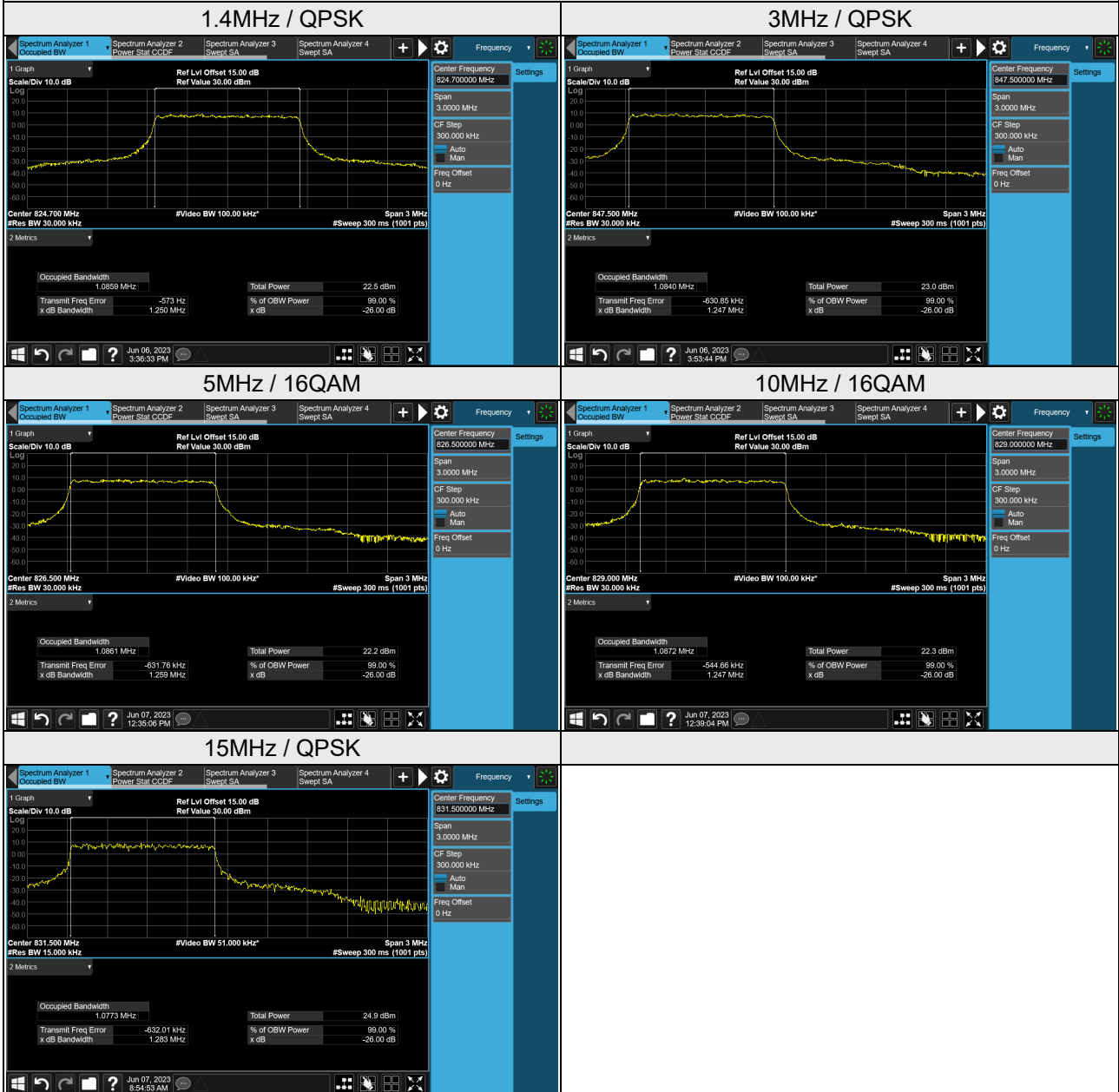

4.5 Band Edge Measurement

4.5.1 Limits of Band Edge Measurement

Power of any emission outside of the authorized operating frequency ranges must be attenuated below the transmitting power (P) by a factor of at least $43 + 10 \log(P)$ dB. In the 1 MHz bands immediately outside and adjacent to the frequency block a resolution bandwidth of at least one percent of the emission bandwidth of the fundamental emission of the transmitter may be employed.

4.5.2 Test Setup

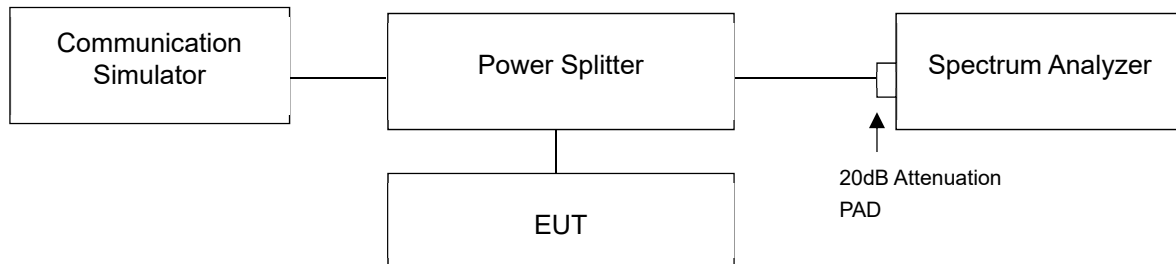

4.5.3 Test Procedures

- All measurements were done at low and high operational frequency range.
- Measurement refer to ANSI C63.26 section 5.7.
- Measuring frequency band edge, narrow RBW (no less than 1% of the OBW) is used for conducted emission measurement. $VBW \geq 3 \times RBW$, Detector = Average.
- The center frequency of spectrum is the band edge frequency and span is 2MHz. RB of the spectrum is 15kHz and VB of the spectrum is 51kHz.
- Record the max trace plot into the test report.

4.5.4 Test Results

Cat-M1 Band 5 (Channel Bandwidth 1.4MHz)

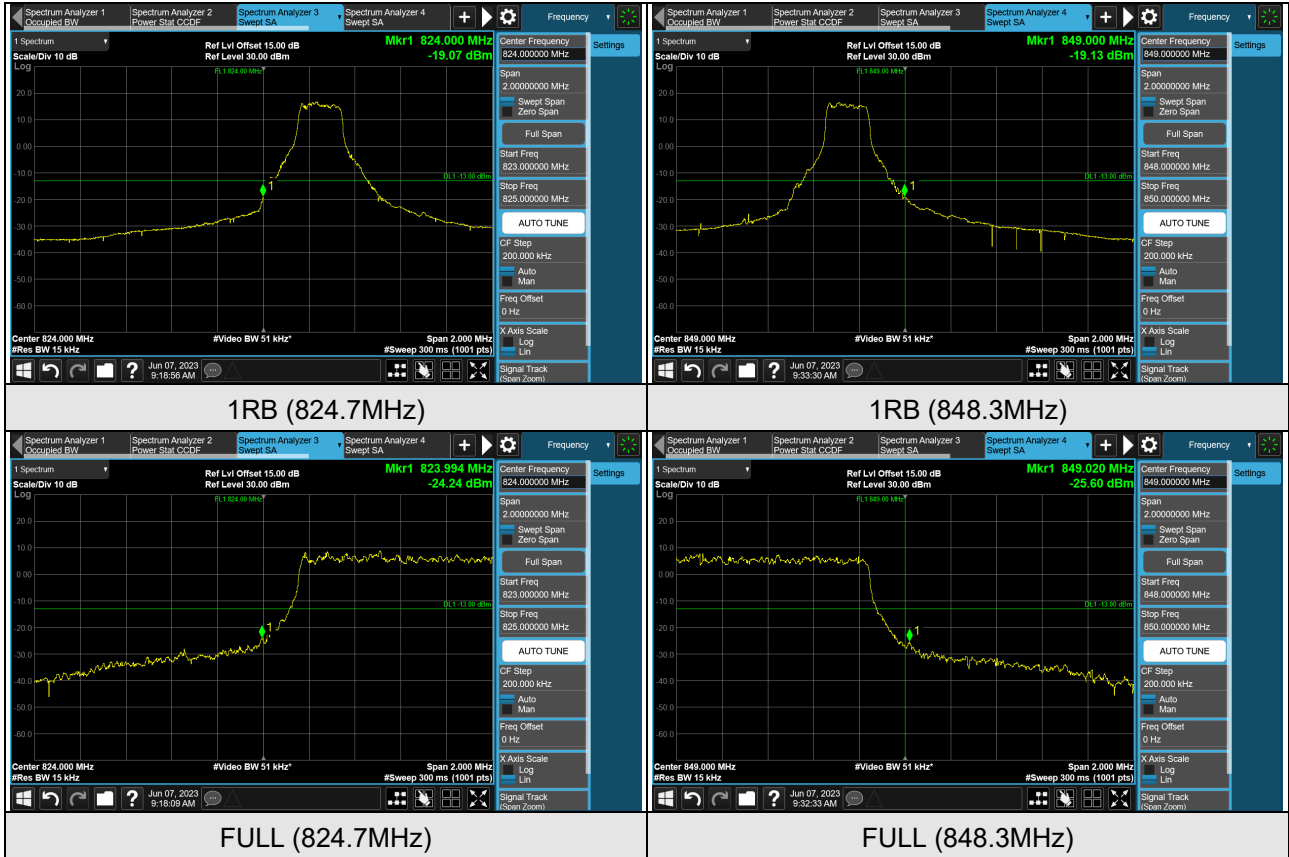



Cat-M1 Band 5 (Channel Bandwidth 3MHz)





Cat-M1 Band 5 (Channel Bandwidth 5MHz)

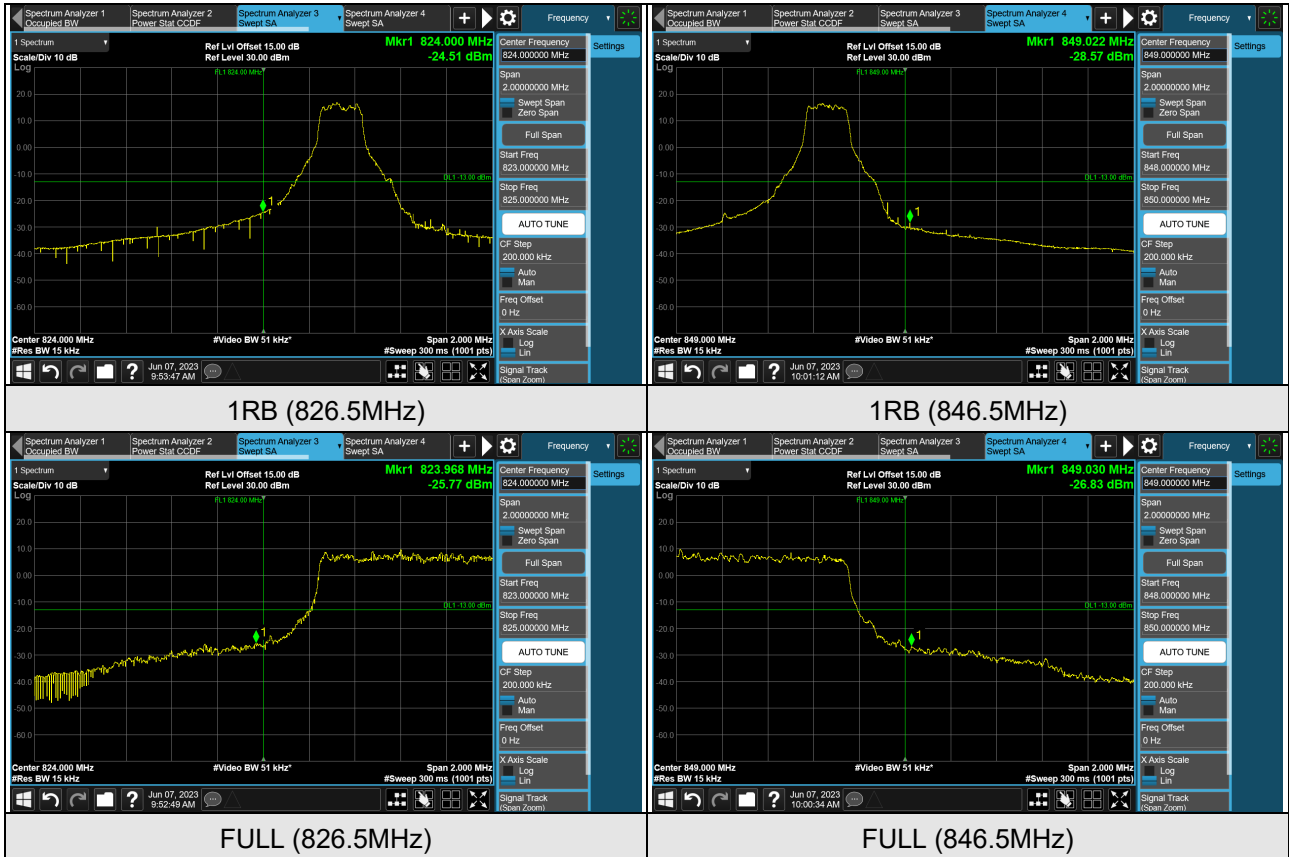

Cat-M1 Band 5 (Channel Bandwidth 10MHz)

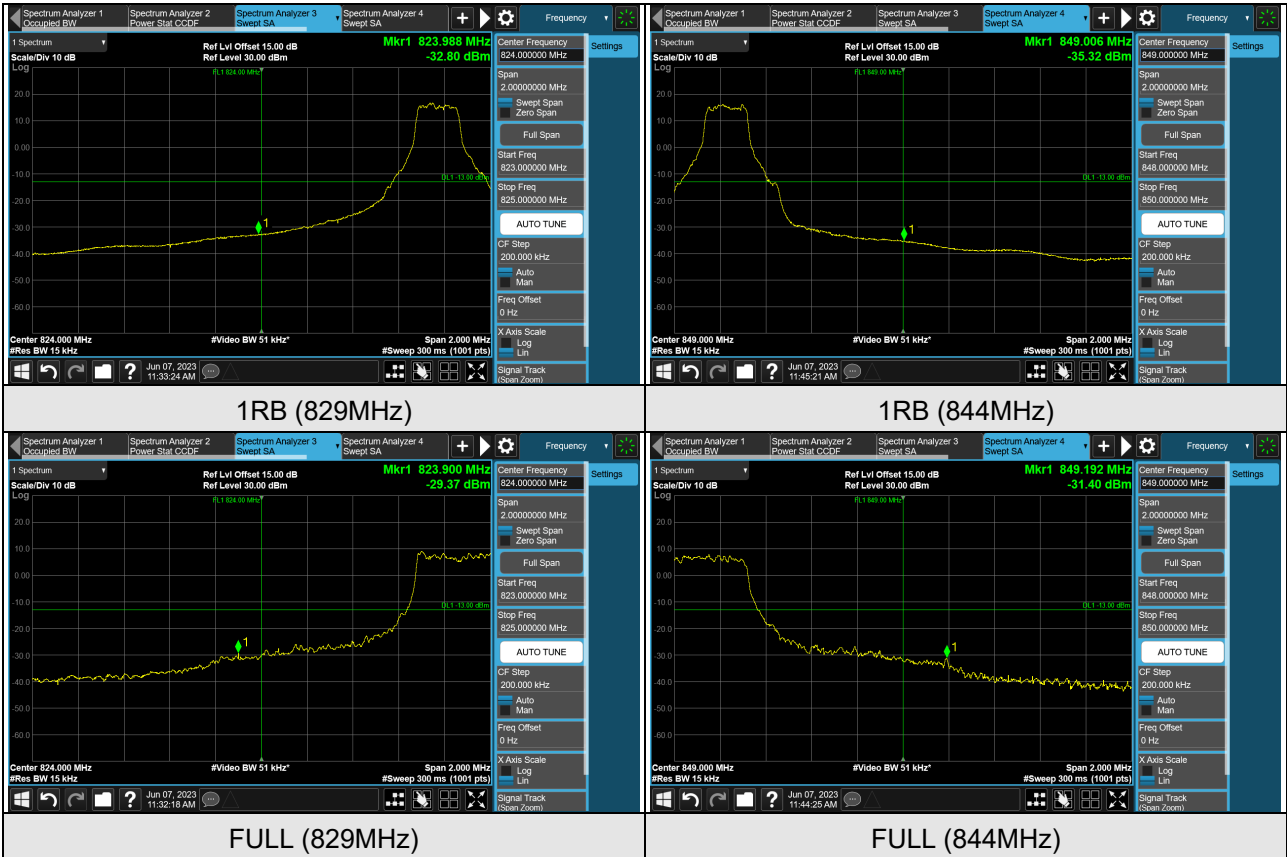



Cat-M1 Band 26 (Channel Bandwidth 1.4MHz)

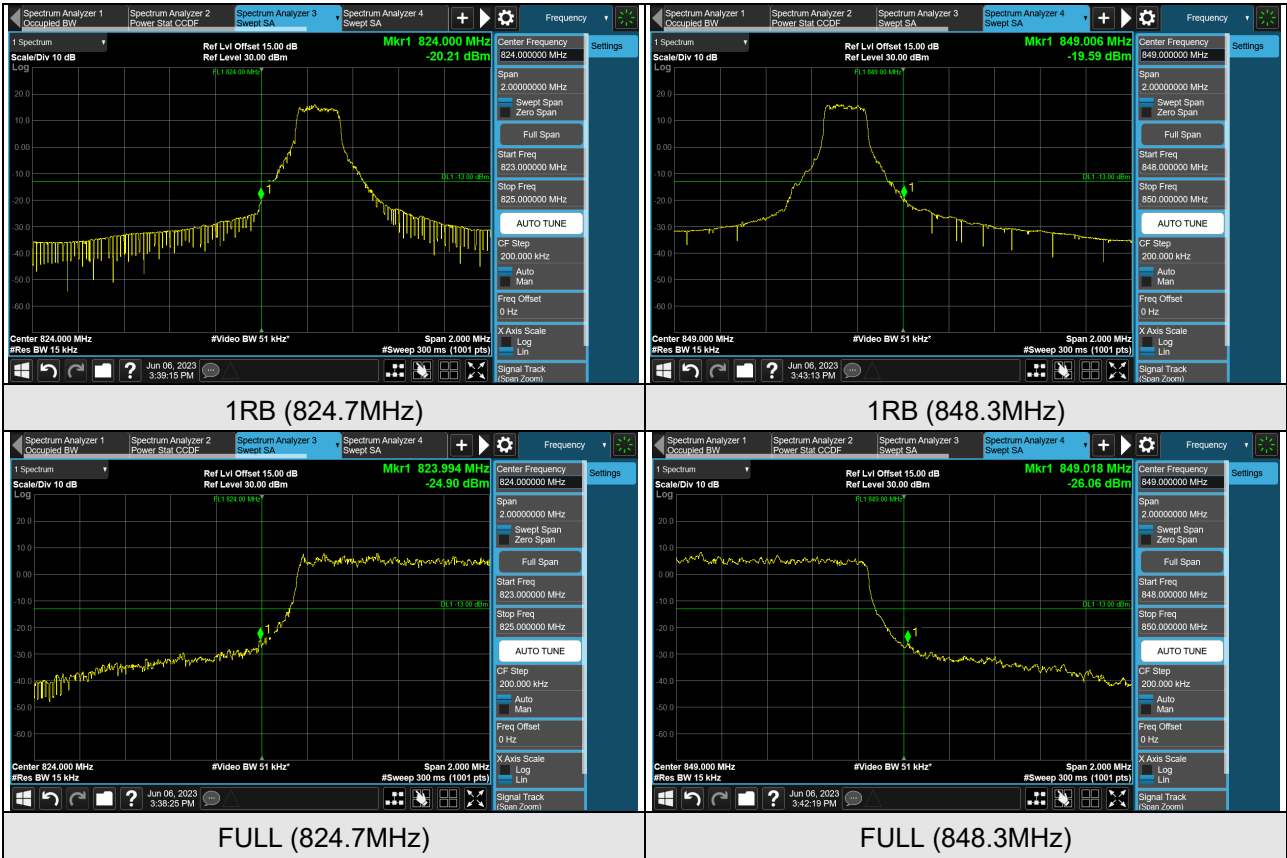

Cat-M1 Band 26 (Channel Bandwidth 3MHz)

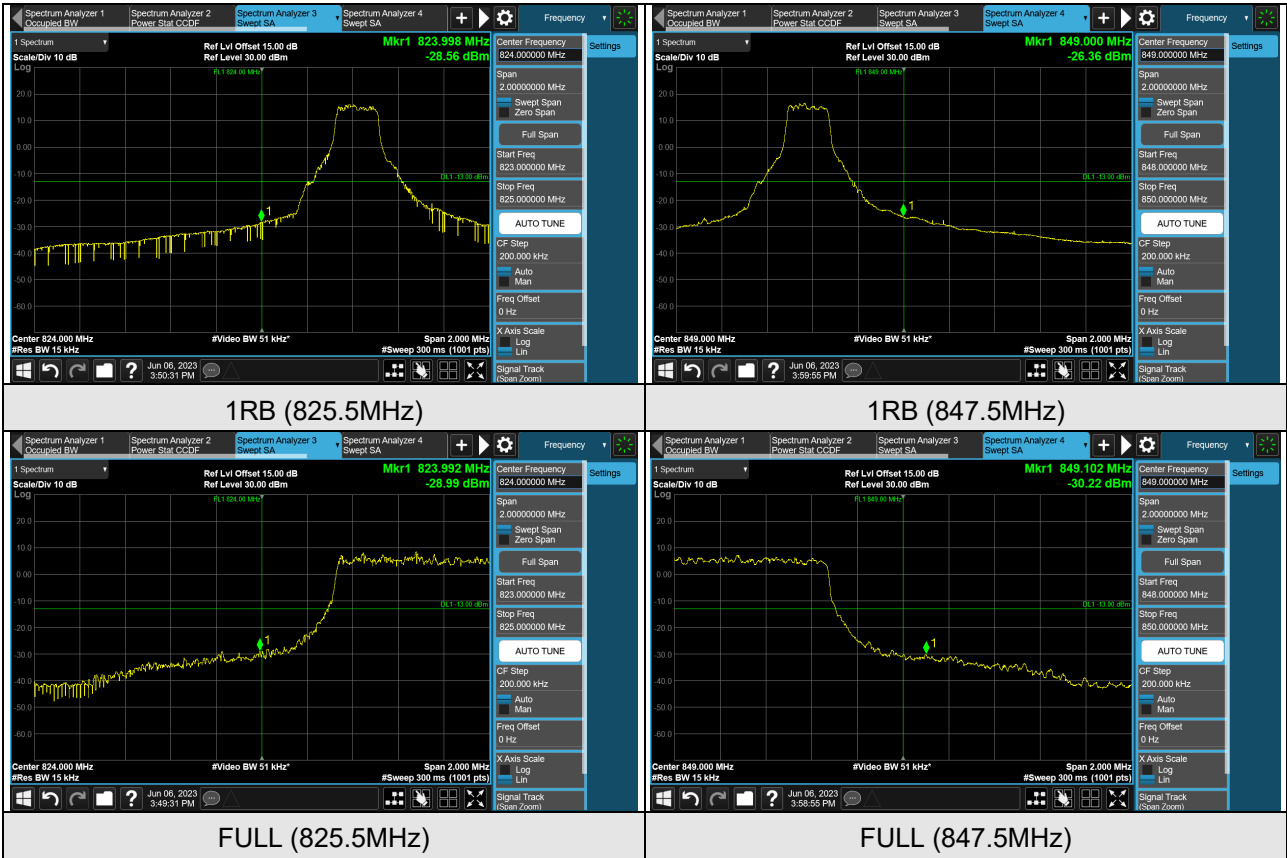



Cat-M1 Band 26 (Channel Bandwidth 5MHz)

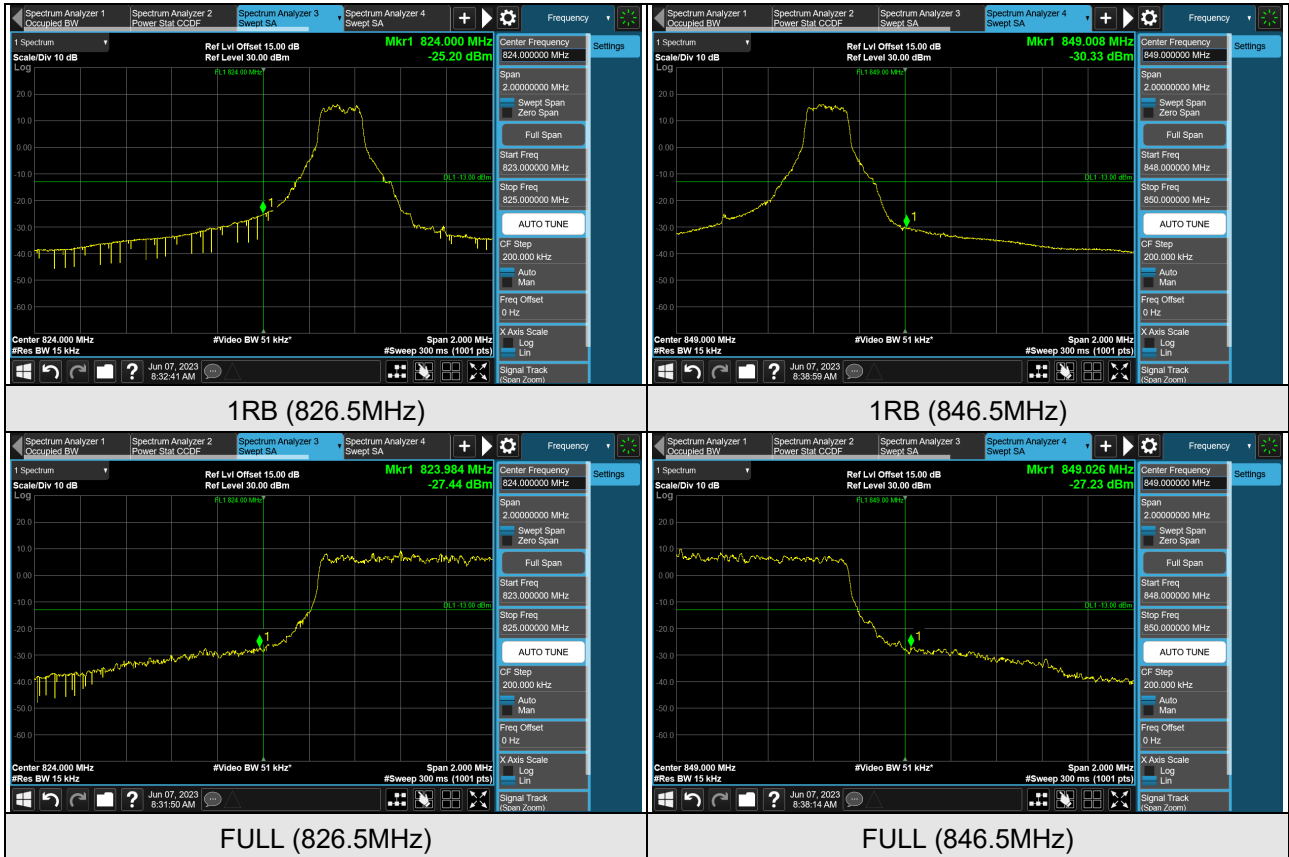

Cat-M1 Band 26 (Channel Bandwidth 10MHz)

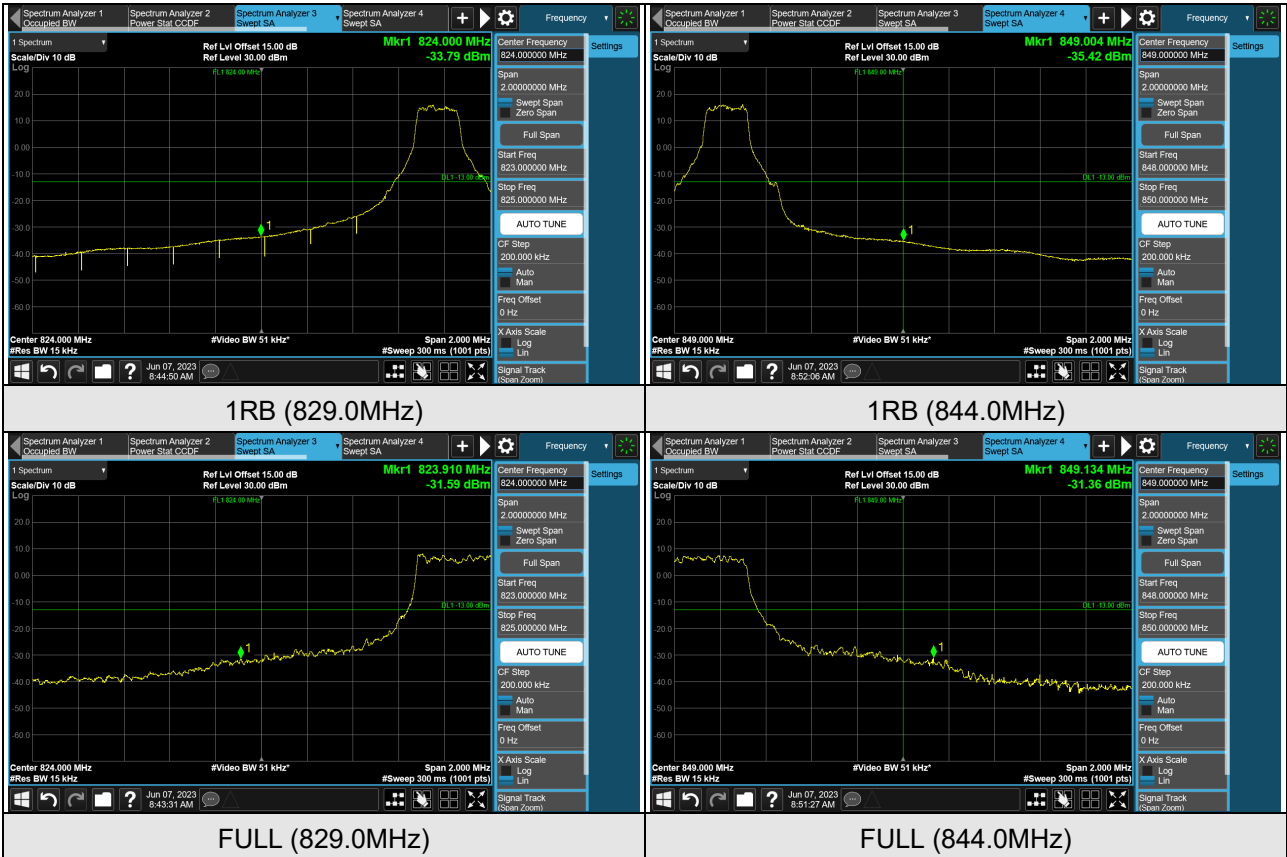



Cat-M1 Band 26 (Channel Bandwidth 15MHz)

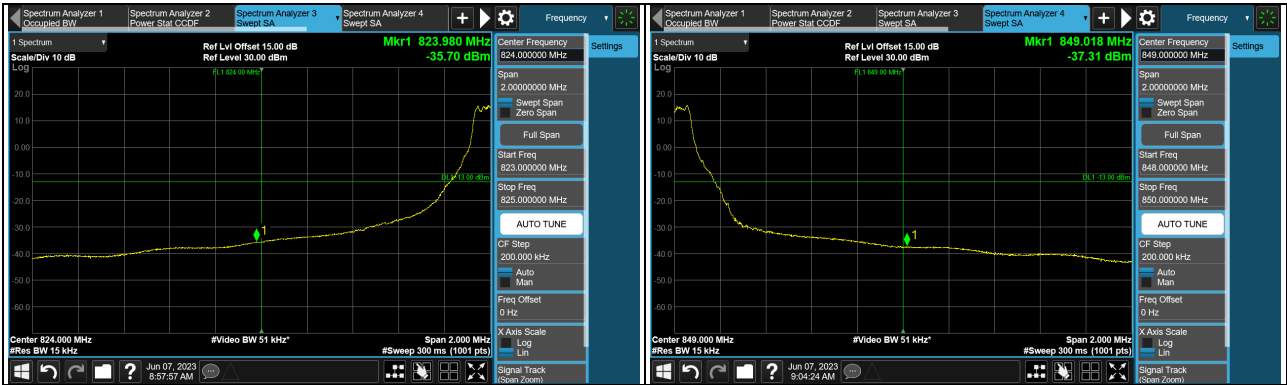

1RB (831.5MHz)

1RB (841.5MHz)

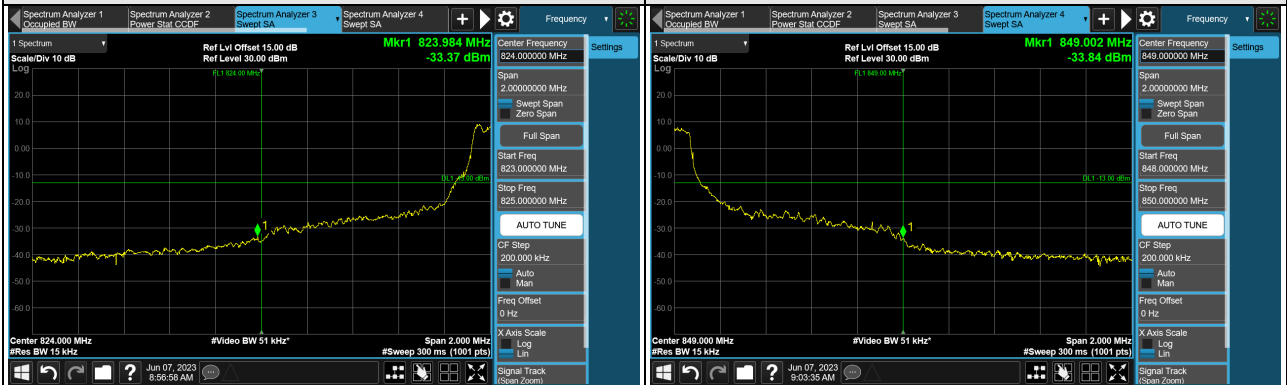

FULL (831.5MHz)

FULL (841.5MHz)

4.6 Peak to Average Ratio

4.6.1 Limits of Peak to Average Ratio Measurement

In measuring transmissions in this band using an average power technique, the peak to-average ratio (PAR) of the transmission may not exceed 13 dB

4.6.2 Test Setup

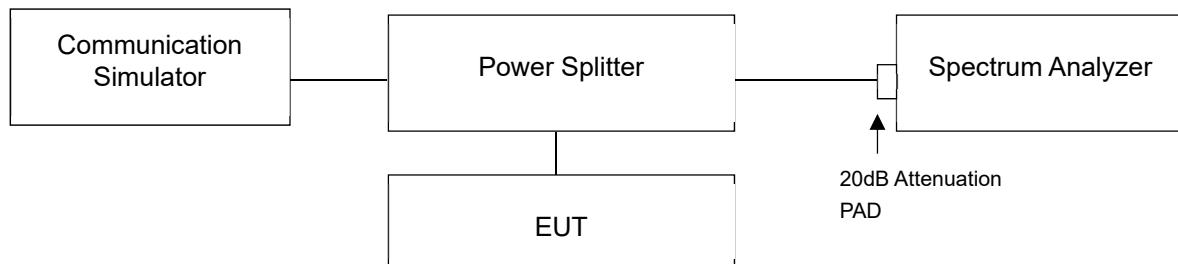

4.6.3 Test Procedures

- Set resolution/measurement bandwidth \geq signal's occupied bandwidth;
- Set the number of counts to a value that stabilizes the measured CCDF curve;
- Record the maximum PAPR level associated with a probability of 0.1%.

4.6.4 Test Results

Cat-M1 Band 5, Channel Bandwidth 1.4MHz			
Channel	Frequency (MHz)	Peak To Average Ratio (dB)	
		QPSK	16QAM
20407	824.7	4.26	5.20
20525	836.5	4.36	5.32
20643	848.3	4.34	5.25
Cat-M1 Band 5, Channel Bandwidth 3MHz			
Channel	Frequency (MHz)	Peak To Average Ratio (dB)	
		QPSK	16QAM
20415	825.5	4.26	5.19
20525	836.5	4.31	5.27
20635	847.5	4.29	5.22
Cat-M1 Band 5, Channel Bandwidth 5MHz			
Channel	Frequency (MHz)	Peak To Average Ratio (dB)	
		QPSK	16QAM
20425	826.5	4.31	5.24
20525	836.5	4.38	5.28
20625	846.5	4.39	5.25
Cat-M1 Band 5, Channel Bandwidth 10MHz			
Channel	Frequency (MHz)	Peak To Average Ratio (dB)	
		QPSK	16QAM
20450	829.0	4.36	5.03
20525	836.5	4.39	5.16
20600	844.0	4.36	5.12

Spectrum Plot of Worst Value

1.4MHz / 16QAM

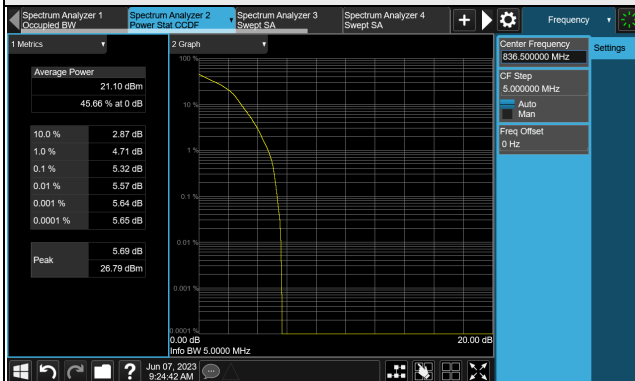

3MHz / 16QAM

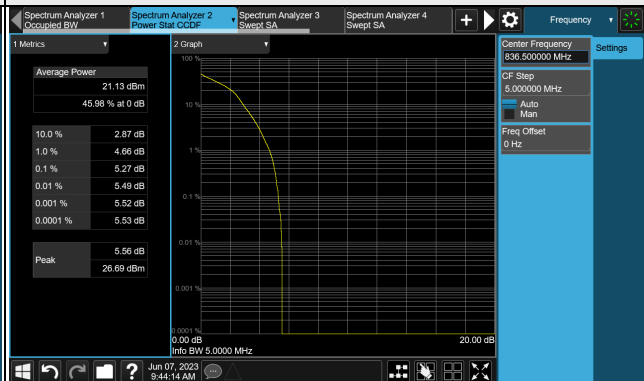

5MHz / 16QAM

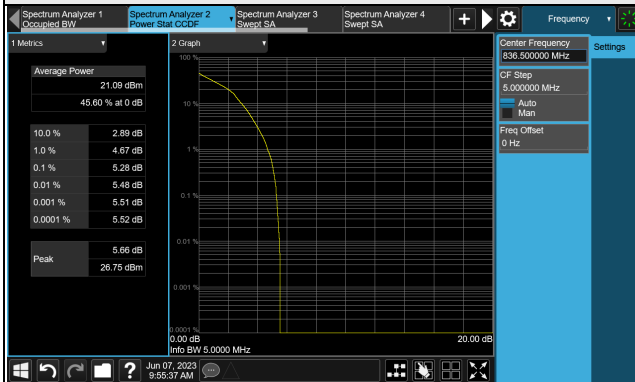

10MHz / 16QAM

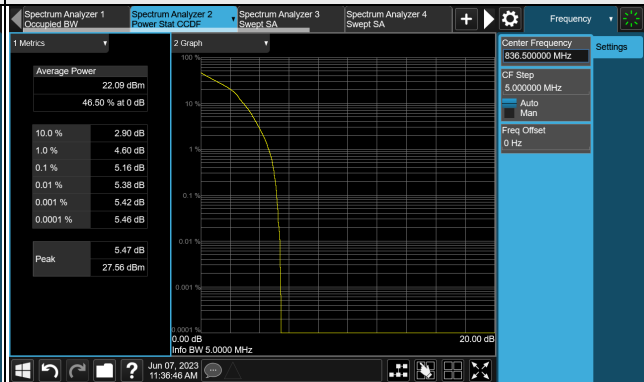

Cat-M1 Band 26, Channel Bandwidth 1.4MHz			
Channel	Frequency (MHz)	Peak To Average Ratio (dB)	
		QPSK	16QAM
26797	824.7	4.28	5.22
26915	836.5	4.29	5.24
27033	848.3	4.31	5.24
Cat-M1 Band 26, Channel Bandwidth 3MHz			
Channel	Frequency (MHz)	Peak To Average Ratio (dB)	
		QPSK	16QAM
26805	825.5	4.32	5.22
26915	836.5	4.31	5.21
27025	847.5	4.32	5.21
Cat-M1 Band 26, Channel Bandwidth 5MHz			
Channel	Frequency (MHz)	Peak To Average Ratio (dB)	
		QPSK	16QAM
26815	826.5	4.42	5.37
26915	836.5	4.38	5.31
27015	846.5	4.38	5.26
Cat-M1 Band 26, Channel Bandwidth 10MHz			
Channel	Frequency (MHz)	Peak To Average Ratio (dB)	
		QPSK	16QAM
26840	829.0	4.38	5.12
26915	836.5	4.34	5.10
26990	844.0	4.34	5.31
Cat-M1 Band 26, Channel Bandwidth 15MHz			
Channel	Frequency (MHz)	Peak To Average Ratio (dB)	
		QPSK	16QAM
26865	831.5	4.19	4.83
26915	836.5	4.13	4.80
26965	841.5	4.12	4.78



Spectrum Plot of Worst Value

1.4MHz / 16QAM

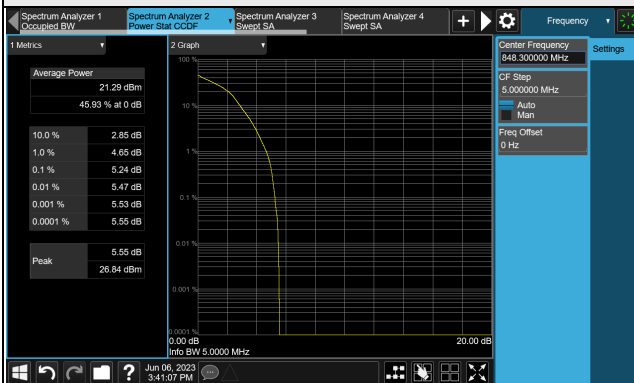

3MHz / 16QAM

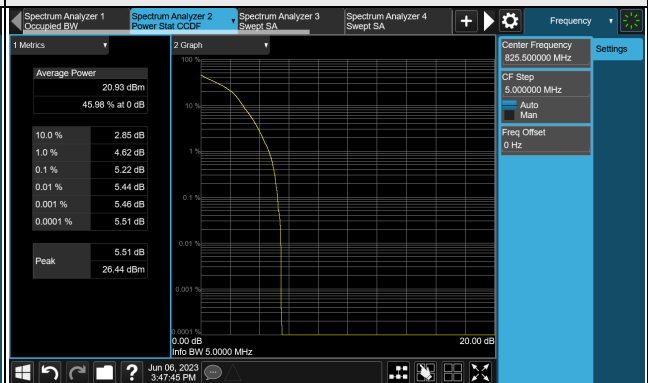

5MHz / 16QAM

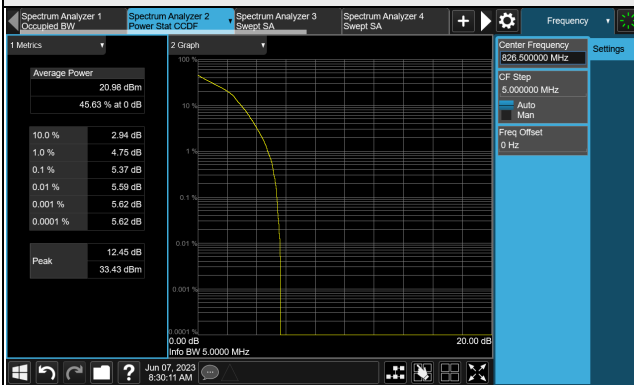

10MHz / 16QAM

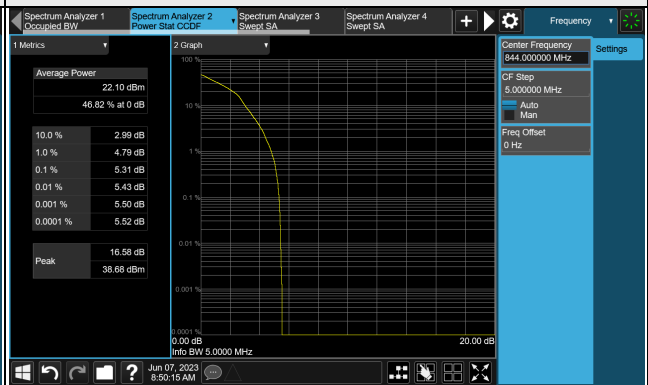

15MHz / 16QAM

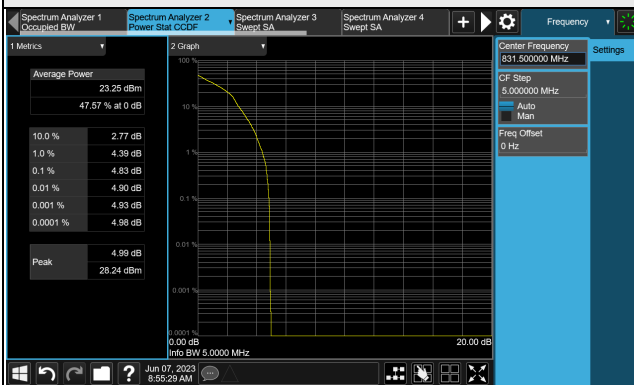

4.7 Conducted Spurious Emissions

4.7.1 Limits of Conducted Spurious Emissions Measurement

The power of any emission outside of the authorized operating frequency ranges must be attenuated below the transmitting power (P) by a factor of at least $43 + 10 \log(P)$ dB. The emission limit equal to -13dBm .

4.7.2 Test Setup

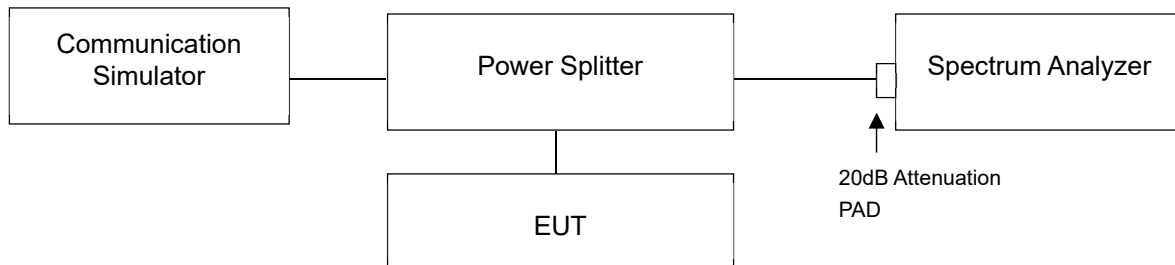

4.7.3 Test Procedure

- The EUT makes a phone call to the communication simulator. All measurements were done at low, middle and high operational frequency range.
- Measurement refer to ANSI C63.26 section 5.7.
- Measuring frequency range is from 9kHz to 10GHz. 20dB attenuation pad is connected with spectrum. Detector = Average, RBW=1MHz and VBW=3MHz are used for Cat-M1 band conducted emission measurement.

4.7.4 Test Results

Cat-M1 Band 5, Channel Bandwidth 1.4MHz

Channel 20407 (824.7MHz)

Frequency Range : 9kHz ~ 1GHz

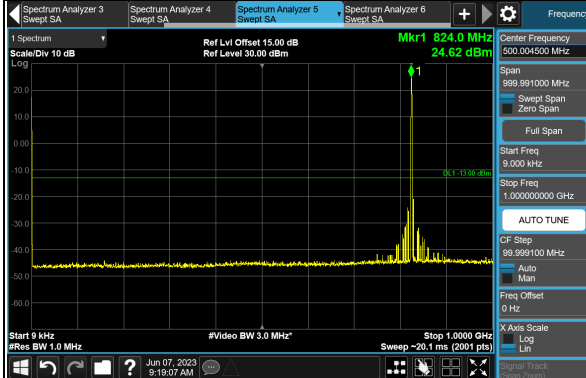

Frequency Range : 1GHz ~ 10GHz

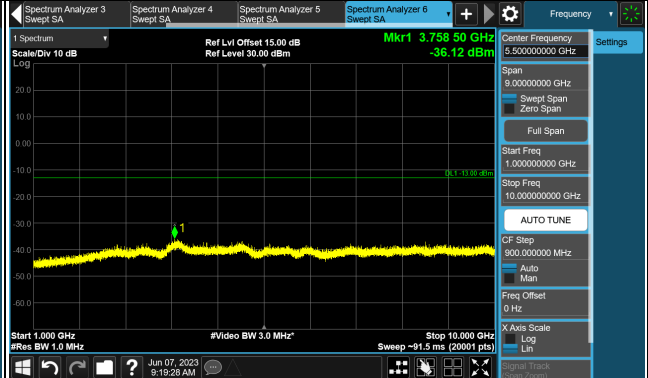

Channel 20525 (836.5MHz)

Frequency Range : 9kHz ~ 1GHz

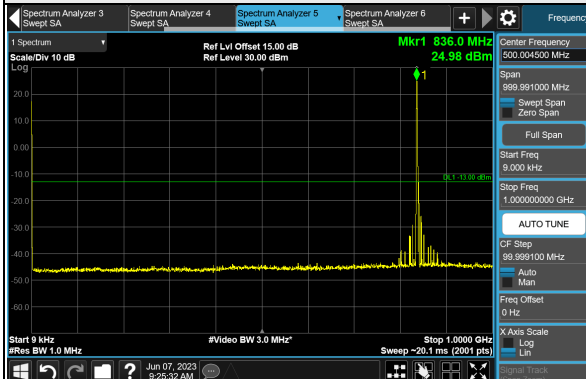

Frequency Range : 1GHz ~ 10GHz

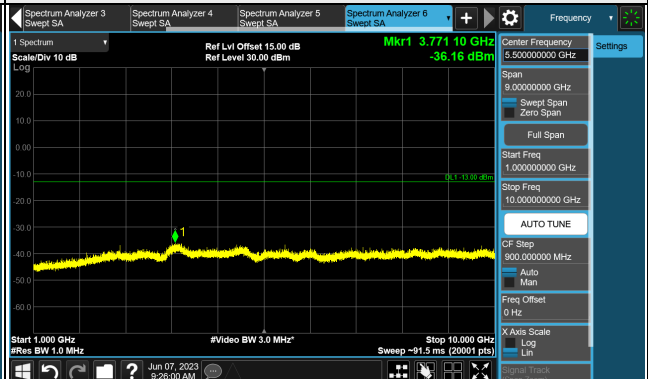

Channel 20643 (848.3MHz)

Frequency Range : 9kHz ~ 1GHz

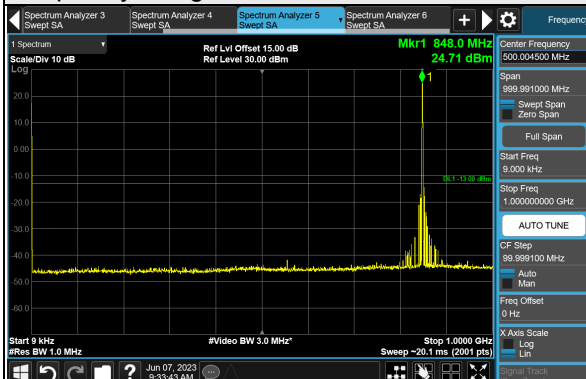

Frequency Range : 1GHz ~ 10GHz

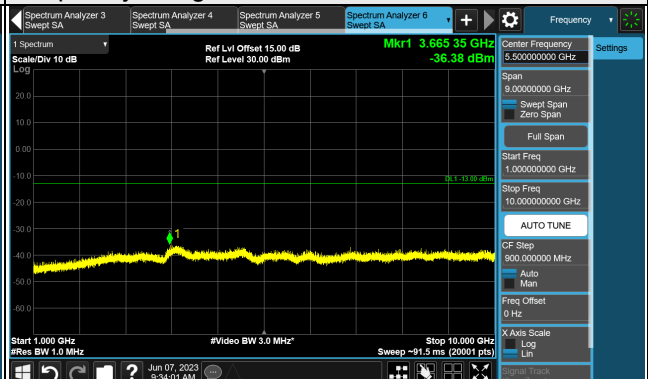

*The 9kHz signal over the limit is from Spectrum.