

AUT Report

B014

ISM 869MHz – 915MHz

Table of Contents

1. Test Personnel.....	3
2. Test Date	3
3. Test setup description.....	3
4. Measurement Procedure	4
4.1. Far-field measurement	4
4.2. Return loss measurement.....	4
5. Test Equipment and Calibration	5
6. Performance Specifications	6
7. Far-Field Radiation Patterns	7

1. Test Personnel

Name: Thomas Man

2. Test Date

Date: April 27, 2023

3. Test setup description

ETS SISO antenna measurement system AMS-8923-150 includes a high-performance 13'-0" x 13'-0" x 13'-0" (4.0m x 4.0m x 4.0m) RF-shielded anechoic chamber, multi-antenna array, positioning system, and EMQuest™ EMQ-100 Antenna Measurement Software. It is used for antenna performance test, which is based on the conical cut test method defined by CTIA. The angle of elevation in the long axis of the EUT is referred to as the theta angle, and the azimuth angle of the EUT is referred to as the phi angle. The axis of turntable rotation will measure along the phi axis for the Conical Cut method.

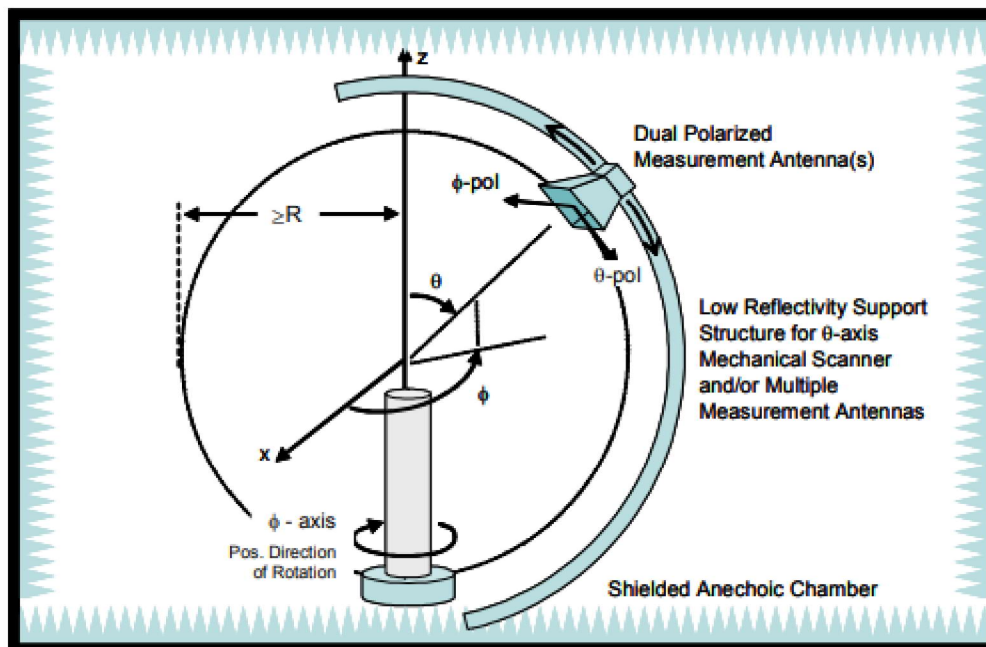

Figure 1. Conical antenna measurement system defined by CTIA.

4. Measurement Procedure

4.1. Far-field measurement

1. Place the AUT on the styrofoam support structure and connect the feeding cable to the antenna port
2. Set the measurement parameters such as frequency range and sampling angles on EMQuest test software
3. Perform passive antenna test and obtain far-field data such as radiation pattern, gain and efficiency

4.2. Return loss measurement

1. Connect Port 1 of the network analyzer to the antenna under test using the coaxial cable
2. Measure and record the S11 response

5. Test Equipment and Calibration

Network analyzer and reference dipole antennas are used for chamber calibration. Path loss and cable loss for different frequency bands can be checked and calculated.

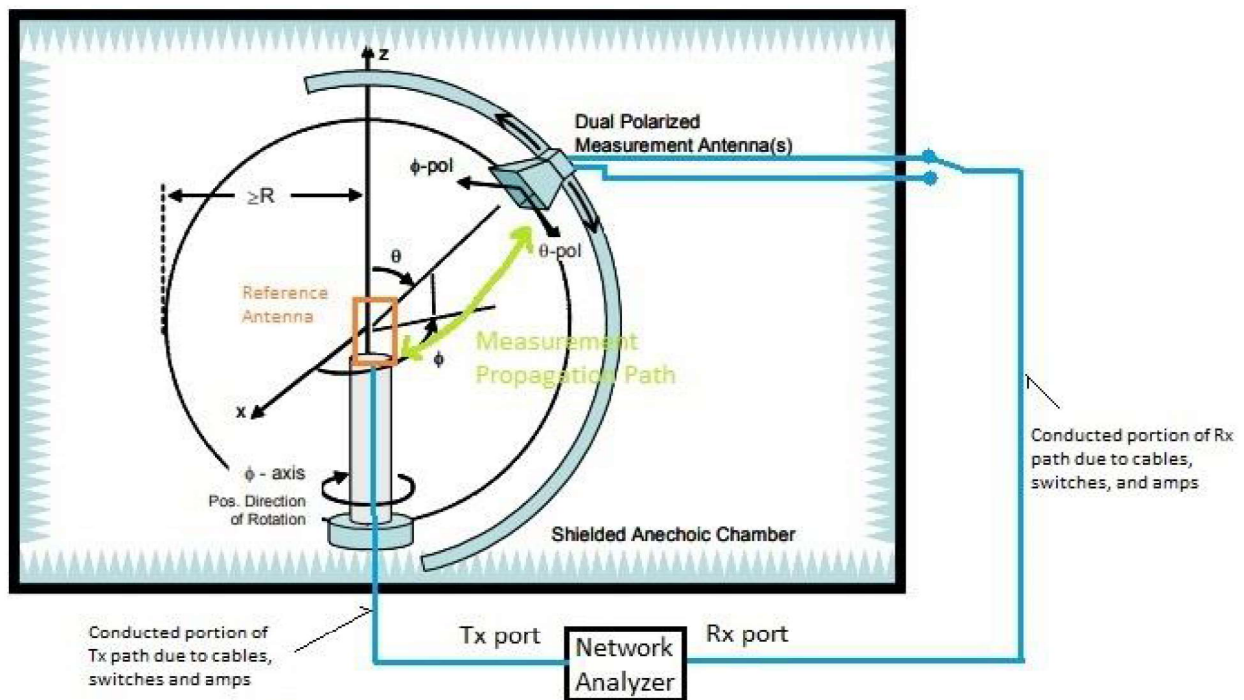

Instrument	Brand	Characteristics	Model No.	Serial No.	Cal due date
Network Analyzer	Agilent	13MHz-13.5GHz	PNA N5241A	MY49411166	Apr 02, 2024
Precision Sleeve Dipole	ETS-Lindgren	700MHz-850MHz	3126-700	154283	Mar 24, 2024
Precision Sleeve Dipole	ETS-Lindgren	800MHz-950MHz	3126-800	154290	Mar 24, 2024
Precision Sleeve Dipole	ETS-Lindgren	900MHz-1000MHz	3126-900	151536	Mar 24, 2024
Precision Sleeve Dipole	ETS-Lindgren	1700MHz-2000MHz	3126-1850	154363	Mar 24, 2024

Precision Sleeve Dipole	ETS-Lindgren	2000MHz-2300MHz	3126-2150	154419	Mar 24, 2024
Precision Sleeve Dipole	ETS-Lindgren	2300MHz-2600MHz	3126-2450	028370	Mar 24, 2024

6. Performance Specifications

Frequency (MHz)	868-915
Peak Gain (dBi)	+2.00
Efficiency (%)	72
Return Loss (dB)	<-8
Impedance (ohm)	50
Polarization	Linear
Dimensions (mm)	32x17
Material	FR4
Operation Temperature	-40°C to +85°C
ROHs Compliant	Yes

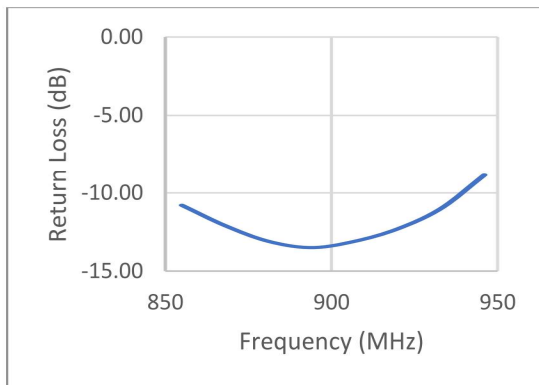

(a)

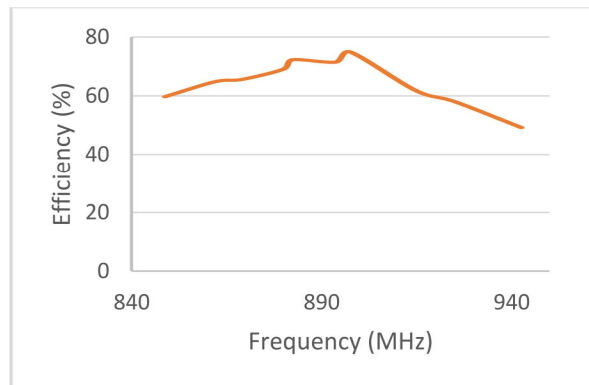

(b)

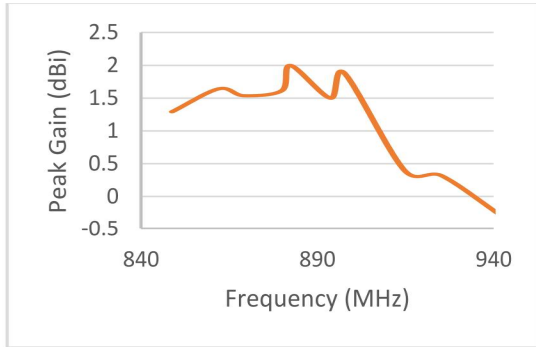

(c)

Figure 2. (a) Return Loss of ISM 900MHz Antenna; (b) Efficiency of ISM 900MHz Antenna; (c) Peak Gain of ISM 900MHz Antenna

7. Far-Field Radiation Patterns

868MHz

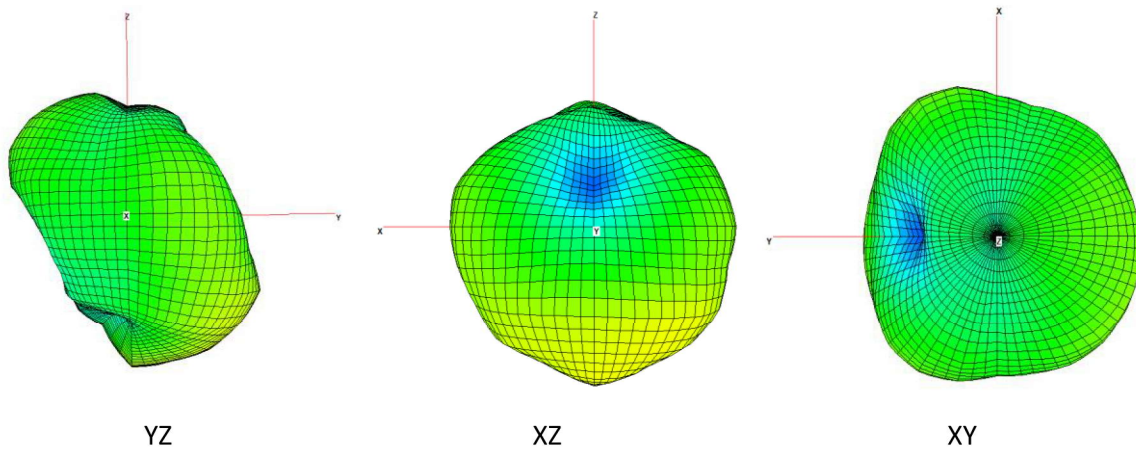

915MHz

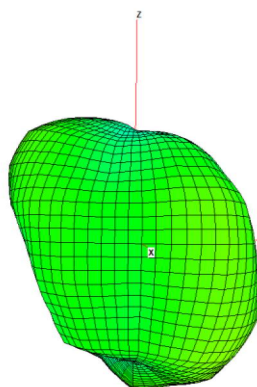

YZ

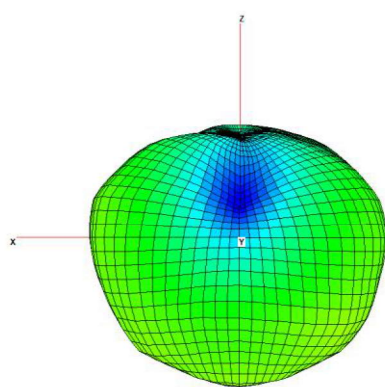

XZ

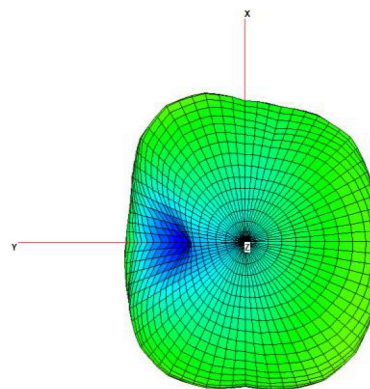

XY