



BLACKBERRY RADAR H2

ITC100 – 1, ITC100 – 2,

ITF100 – 3, ITF100 – 2, ITF100 – 3

August 2021

Dry Van, Insulated Trailers (Barn Doors)

Installation Guide

Table of contents

1	Overview	3
2	Get ready for installation	4
3	Installing BlackBerry Radar H2 modules	5
3.1	Prepare to install.....	5
3.2	Installation tools	7
3.3	Matching a module identifier to an asset identifier	8
3.4	Module installation.....	10
3.4.1	Prepare module for installation--Battery connection	11
3.4.2	Installing module on an asset.....	14
3.4.3	Dry van installation procedure	15
4	Removing BlackBerry Radar H2 modules	23
4.1	Removal tools	23
4.2	Module removal	24
4.3	Battery removal and replacement.....	25
4.4	Door Repair.....	30
5	Support	33
	Legal notice	34

1 Overview

This guide provides detailed instructions for installing and activating new BlackBerry Radar H2 modules. It includes three main tasks:

Task 1: Get ready for installation (see Section 2)

Task 2: Install a BlackBerry Radar H2 module (see Section 3)

- Match the module identifier with the asset identifier on the installation worksheet.
- Install the module onto the asset.

Task 3: Uninstall a module (see Section 4)

- Remove the module from the asset.
- Remove/replace the battery and prepare the device for shipping.
- Post-removal door repair.

Complete BlackBerry Radar documentation is available online when you log in to BlackBerry Radar Dashboard. For instructions on how to configure the BlackBerry Radar Dashboard or how to activate newly installed devices, see the online documentation.

2 Get ready for installation

To get ready for installation, you need to obtain a worksheet where you can record the pairing of each BlackBerry Radar H2 module to its asset (that is, the trailer/container that the module will be installed on).

For detailed instructions, log in to the BlackBerry Radar Dashboard and access documentation from the main menu.

3 Installing BlackBerry Radar H2 modules

You may have a large number of BlackBerry Radar H2 modules to install. Follow the instructions in this section to:

- Match each module identifier to its asset identifier
- Install the module to the asset you wish to track.

3.1 Prepare to install

To complete the installation of the module to your assets, you will need the following components. The following components are contained in the module packaging.

Radar H2 Module Package Contents

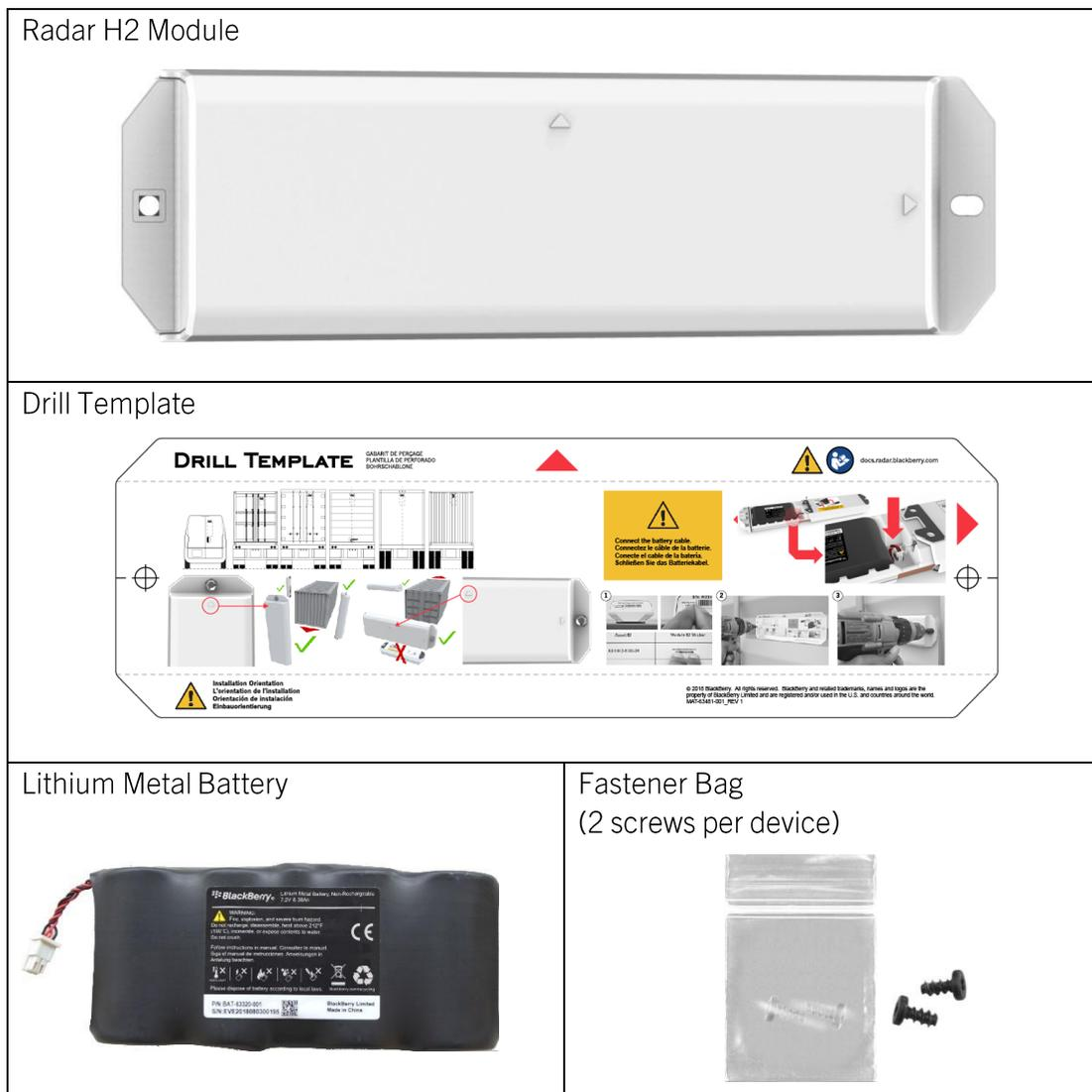

If you are missing any of the above components in your package, contact your BlackBerry Sales Representative.

To attach the module to the asset you wish to track, you must supply your own fasteners. Depending on the construction of your mounting location, you may wish to use the following types of fasteners. Please Note: Your choice of fastener will influence the size of the tools required to create the mounting holes (i.e. drill bits) and install or remove the fasteners (i.e. wrenches/sockets/drivers). An example of this is provided below. The actual length of the fasteners will be determined by the thickness of your mounting surface.

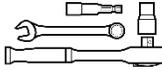
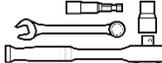
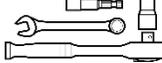
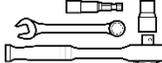
<p>IMPORTANT: The maximum fastener thread diameter supported by this product is 1/4" or M6 (6 mm). For most secure fastening, we do not recommend using fasteners with a diameter less than that of a 1/4" or M6 fastener.</p>		
<p>Box Section (+3mm wall thickness)</p> 	<p>2 self-tapping screws and washers (3/8" head, 1/4"-14 thread, 1-1/2" length)</p> 	<p>Drill Bit 3/16" (5mm)</p> <p>Nut Driver/Socket/Wrench 3/8" (10mm)</p> 
<p>I-Beam / Panel Section (with rear access)</p> 	<p>2 hex bolts, nuts, and 4 washers (7/16" head, 1/4"-20 thread, 1/4"-20 nut, 2" length) (11mm head, M6 thread, 50mm length, M6 nut)</p> 	<p>Drill Bit 1/4" (6mm)</p> <p>Nut Driver/Socket/Wrench 7/16" (11mm)</p> 
<p>Panel doors (plywood/MDF/foam cores)</p> 	<p>2 hex bolts, nuts, and 4 washers (7/16" head, 1/4"-20 thread, 2 1/2"-4" length, 1/4"-20 nut) (11mm head, M6 thread, 65-120mm length, M6 nut)</p> 	<p>Drill Bit 1/4" (6mm)</p> <p>Nut Driver/Socket/Wrench 7/16" (11mm)</p> 
<p>Insulated Trailer Doors (with no rear access)</p> 	<p>2 hex bolts, washers, and well nuts Bolt: 7/16" head, 1/4"-20 thread, 1-1/2" length Insert: 1/4"-20 thread</p> 	<p>Drill Bit 1/2" (13mm)</p> <p>Nut Driver/Socket/Wrench 7/16" (11mm)</p> 

3.2 Installation tools

Required tools to complete the installation:

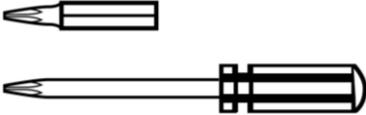
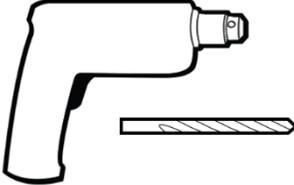
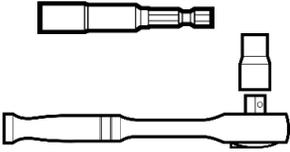
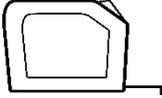
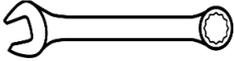
<p>Phillips (PH2) Screwdriver or Bit</p> 	<p>Drill and Drill Bits</p> 	<p>Tape</p> 
<p>Nut Driver or Socket Wrench with Socket*</p>  <p>*Nut Driver + Drill offers fastest installation. If no Nut Driver is available, a socket wrench and socket may be used as a substitute.</p>	<p>Safety Glasses</p> 	<p>Pencil or Non-Permanent Marker</p>  <p>Tape Measure</p>  <p>Wrench</p>  <p>*Required only if nuts and bolts are used.</p>

Recommended tools to complete the installation:

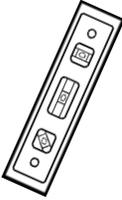
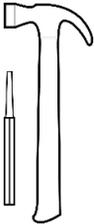
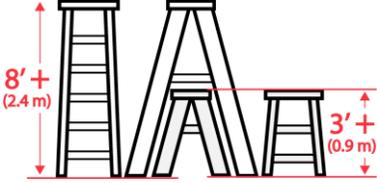
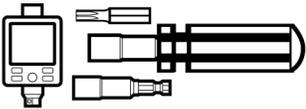
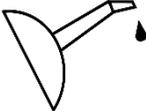
<p>T-Square</p> 	<p>Pocket Level</p> 	<p>Towel</p> 	<p>Hammer and Punch</p> 	<p>Ladders*</p>  <p>*Tall ladder for installation on taller vehicles and containers. Small ladder for installation inside of containers or the exterior of smaller vehicles.</p>
<p>Torque Screwdriver/Adapter with Socket and Bits* (scale range of 0.4 N-m to 4.5 N-m, 4 in-lb. to 40 in-lb.)</p>  <p>*To check compliance with torque specifications for fasteners.</p>	<p>70% Rubbing Alcohol</p> 	<p>File</p> 	<p>Cutting Lubricant* (Recommended)</p>  <p>*Recommended for faster drilling speed on thicker metals and longer drill bit life.</p>	

- Once you are ready to install the module to the asset, remove the partially attached label from the front surface of the inner housing and place it on your worksheet, next to the asset identifier the module will be paired with.

BlackBerry radar Installation Worksheet

Date: August 28, 2018
 Installer: ats-dev-admin@blackberry.com

Asset ID	Module ID Sticker	Accessory ID Sticker	Mileage (Optional)
ZG7419			
New Asset again			
Completely New Asset			
KR8369			
CSV_ASSET_2001			
Empty Flatty			

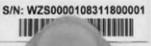

Date: August 28, 2018
 Installer: ats-dev-admin@blackberry.com

Asset ID	Module ID Sticker
ZG7419	
New Asset again	

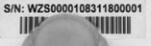

Date: August 28, 2018
 Installer: ats-dev-admin@blackberry.com

Asset ID	Module ID Sticker	Accessory ID Sticker	Mileage (Optional)
ZG7419			

3.4 Module installation

You may install the module on any flat, vertical or horizontal surface that offers enough mounting area for the module. When selecting a mounting location, carefully consider how the asset will be used during its normal, day-to-day operation.

Do not place the module in a location where it is susceptible to damage from:

- Normal usage activities, such as loading or unloading cargo.
- Moving parts of the asset.
- Road debris.

IMPORTANT: For accurate tracking, orientation matters.

1. You may install the module horizontally or vertically.
2. When mounting on a vertical surface, always ensure the module is installed with the triangle for your desired orientation, pointing up.
3. Full 360° rotation around vertical axis are supported.

NOTE: Installation on the front surface of a trailer or container is not recommended. Vibration from the tractor's engine or trailer mounted refrigeration, heating and generator units may result in false motion alerts.

4. You may also rotate the module 90 degrees along the horizontal axis, and mount on an upward facing surface of the asset, with a clear view to the sky. This is helpful for installing on roofs, fender surfaces, etc.
5. Do not install the module on the asset with the front of the module facing the ground. This will result in reduced product performance.

This diagram illustrates the supported installation orientations for the BlackBerry Radar H2 module.

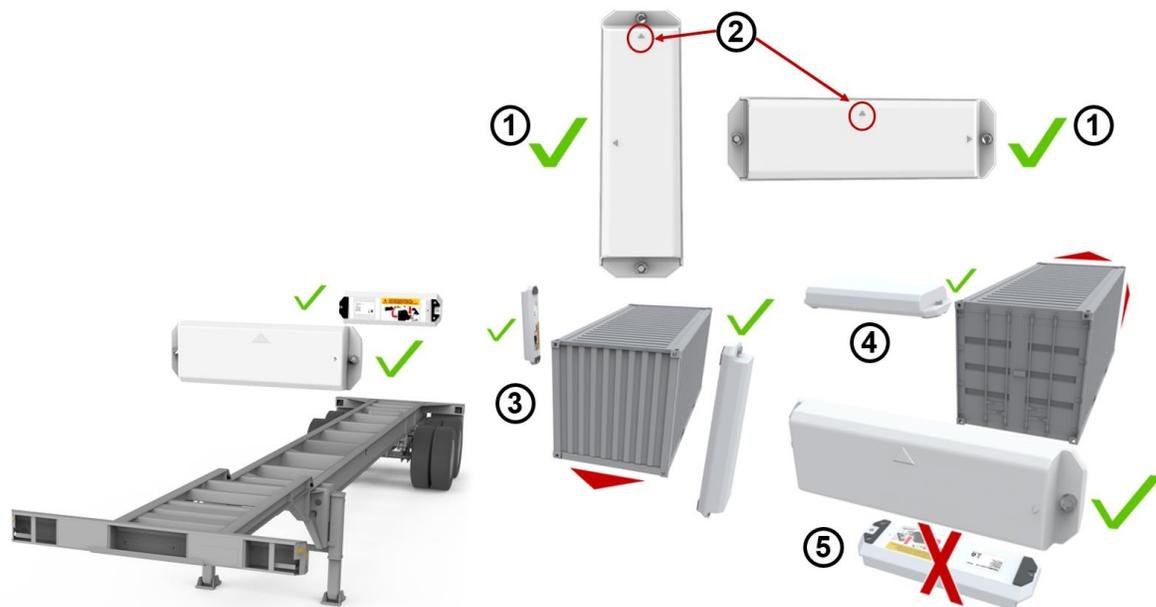

3.4.1 Prepare module for installation—Battery connection

IMPORTANT: Please do not perform the battery connection process until you are ready to install and associate the BlackBerry Radar modules on your asset. Once the battery is connected, please complete the module installation and association, as soon as you can, to conserve battery life.

1. Remove the module from the package and from the plastic bag. Detach the fastener bag from the end of the module and keep nearby. You will require these screws to complete the module assembly process.



2. Turning the module bottom side up, grasp the end of the module's inner housing. Pull to separate the inner housing from the outer housing.



Tip: If you find it difficult to remove the inner housing from the outer housing, you may insert a tool, such as a screwdriver or long bolt, through the hole in the inner housing. Grasp the tool and the outer housing, then pull the two housings apart.



- Remove the battery connector from the connector recess and connect the battery cable to the battery connector. The LED will blink to indicate the module is active.
 NOTE: It can take between 20-30 seconds for the blink sequence to begin. Please be patient. Once you see the LED blink, you may continue to the next step.

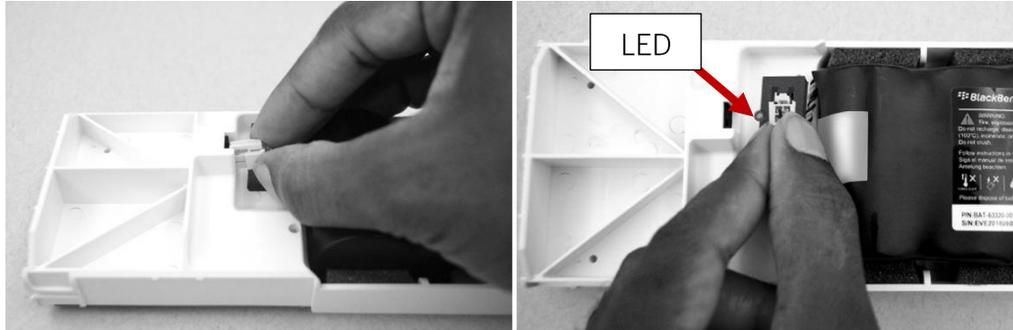

IMPORTANT: When connecting the battery cable to the battery connector, do not remove the Battery Connector Retaining Foam Retaining Tab or place the tab outside of the battery connector opening area. The Battery Connector Retaining Foam Retaining Tab is designed to fit within the battery connector opening area and provide a secure fit for the battery connector latch. Please refer to the following images for the proper orientation of the Battery Connector Retaining Foam Retaining Tab once the battery cable is connected to the battery connector.

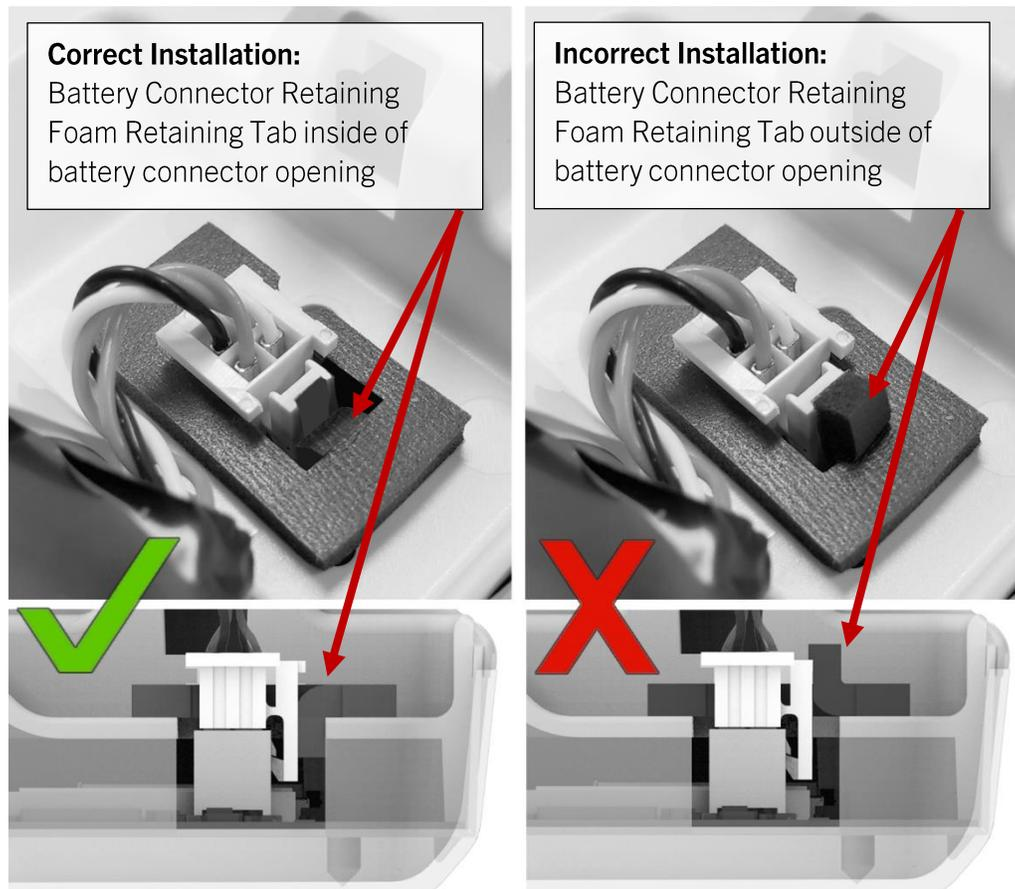

4. Completely insert the inner housing into the outer housing.

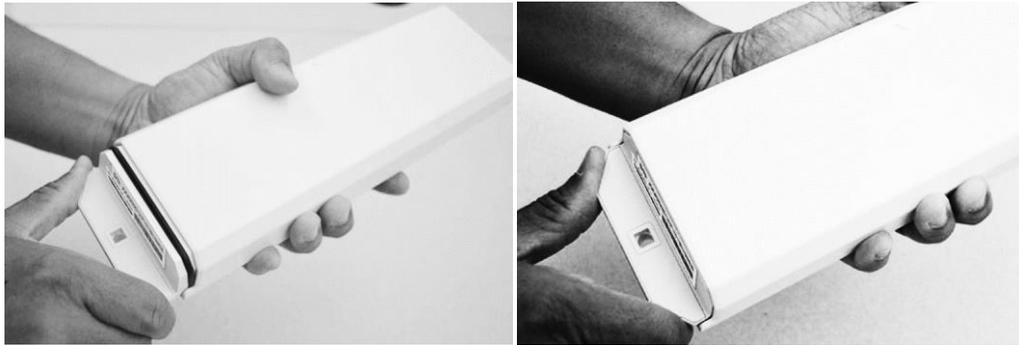

5. Locate the Fastener Bag and remove the two screws. Using a Phillips screwdriver, install the screws to secure the inner housing to the outer housing. **IMPORTANT:** Screw torque must be 3-3.5 in-lb. (0.35-0.4 N-m).



The module is prepared for installation on the asset.

3.4.2 Installing the module on an asset

1. As indicated in Section 3.3 of this guide, record the module identifier and the asset identifier the module will be paired with. For your convenience, you may quickly create a record of the module and asset identifier pairings by removing the partially attached label from the inner housing of the module and placing it on the installation worksheet, next to the asset that will be tracked by the module.



Tip: For modules that have previously been transferred to new assets, the temporary S/N label may no longer be in place. If this is the case, you will need to write the module identifier (S/N) for each module on the installation worksheet.

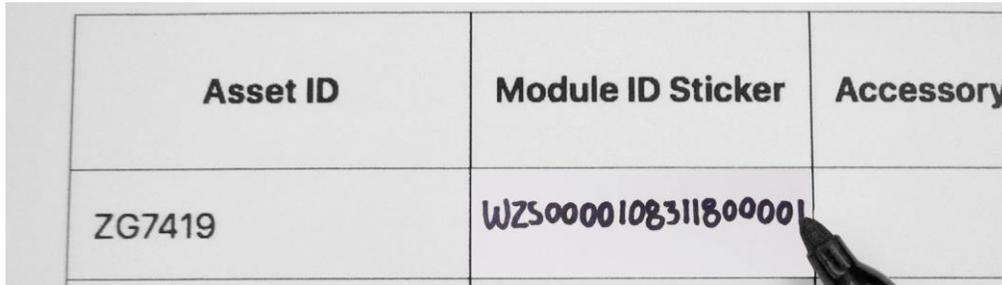

The following sections of this guide will illustrate recommended installation methods for various asset scenarios.

3.4.3 Dry van/insulated trailer installation procedure

If you wish to monitor door open/close events with your BlackBerry Radar H2 module, you will need to mount it on the door. Recommended module placement on dry vans, with barn doors, are as follows:

- The module should be placed on the **right-hand** door and as close to the inside edge of this door as the door construction allows. If your door has external locking bars, ensure there is approximately 1-2" (2.5-5cm) of clearance space between the left side of the unit and the right edge of the locking bar. Mounting the module in this position is critical for proper door detection and ensures all door open/close events are registered--even in instances where only one door is opened.
- The module should be placed as high on the door as possible for optimum antenna performance. The exact placement height will be influenced, in part, by various factors including: the height of the ladder used for the install, door construction and trailer logos.

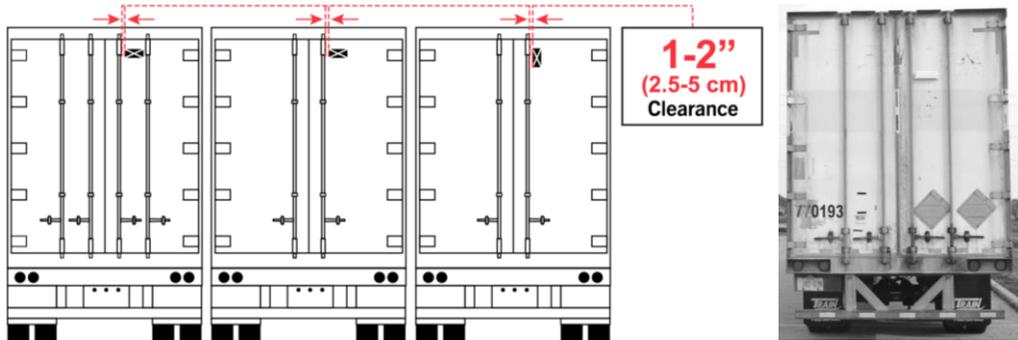

IMPORTANT: If you intend to pair your BlackBerry Radar H2 module with a BlackBerry Radar A2 Cargo Accessory, please ensure you do not install the BlackBerry Radar H2 module at a height that prevents the installation of the Radar A2 Cargo Accessory at the required placement heights in the illustration, below.

- Installing the Radar A2 Cargo Accessory at these heights is important for Radar A2 Cargo Accessory sensor accuracy.
- Staggering the installation height of the Radar H2 module and Radar A2 will avoid damaging the installed device when installing the other device.

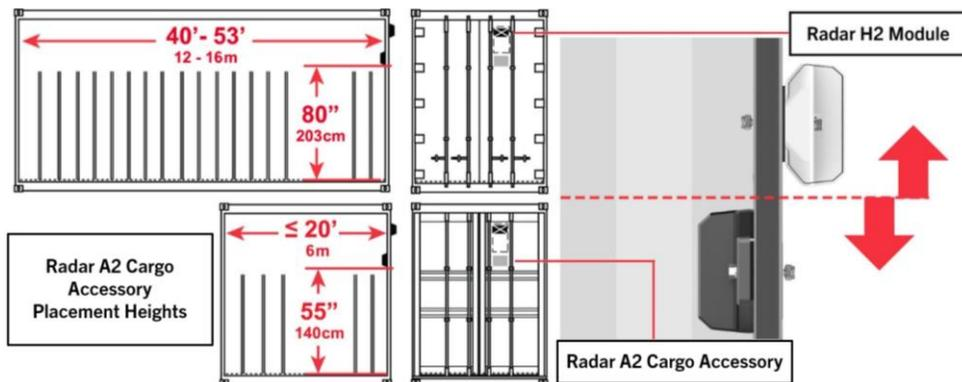

- If your trailer is insulated (i.e., a reefer or heater) and you wish to avoid thermal losses caused from drilling through the door completely, we recommend limiting the depth of drilling and using Well Nuts, along with shorter bolts, to secure the device to the asset.

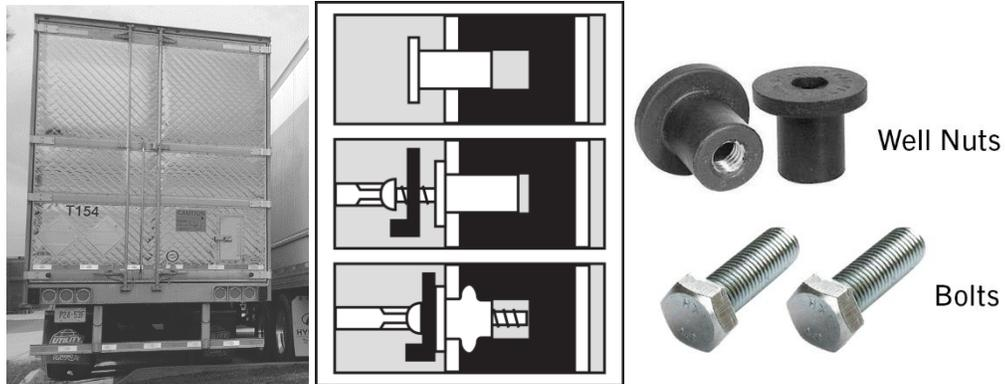

Threaded fastener selection considerations

- Well nuts are threaded fasteners, with a metal insert encased in rubber. When a bolt is inserted and tightened, the fastener compresses, gripping the rear surface of the mounting surface. At the same time, the rubber casing provides added protection against water entering the hole on the door. The diagram below shows how the well nut works.

Well nuts require no special tools to install and can be easily removed from the installation when no longer required.

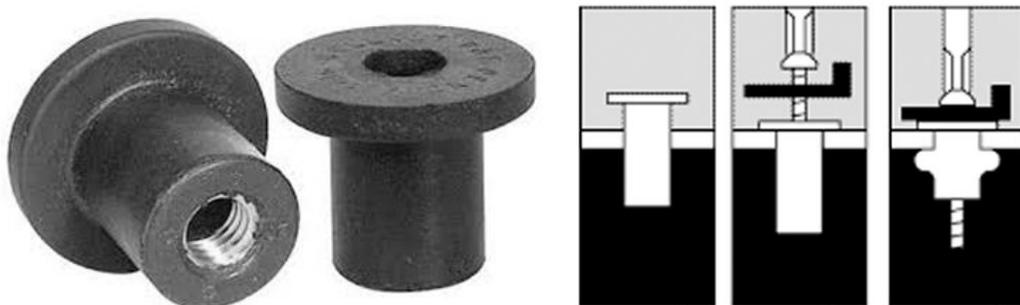

As you will need to supply two fasteners, you may determine which fastener is most suitable for your needs. Note: Your choice of fastener will influence the size of the tools required to create the mounting holes (i.e. drill bits) and install or remove the fasteners (i.e. wrenches/sockets/drivers). Likewise, the actual length of the fasteners will be determined by the thickness of your mounting surface and the fasteners selected. An example of this provided below.

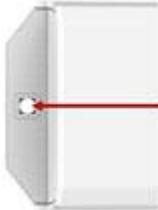
<p>IMPORTANT: The maximum fastener thread diameter supported by this product is 1/4" or M6 (6 mm). For most secure fastening, we do not recommend using fasteners with a diameter less than that of a 1/4" or M6 fastener.</p>	 <p>MAX Ø 1/4" (0.25") M6 (6 mm)</p>
--	--

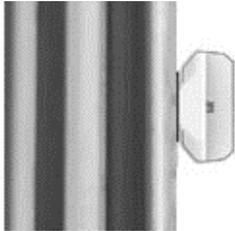
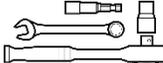
<p>Insulated Trailer Doors (with no rear access)</p> 	<p>2 bolts and well nuts Bolt: 7/16" head, 1/4"-20 thread, 1-1/2" length Well Nut Insert: 1/4"-20 thread</p> 	<p>Drill Bit  1/2" (13mm)</p> <p>Nut Driver/Socket/Wrench  7/16" (11mm)</p>
---	--	---

1. As indicated in Section 3.3 of this guide, record the module identifier and the asset identifier the module will be paired with. For your convenience, you may quickly create a record of the module and asset identifier pairings by removing the partially attached label from the inner housing of the module and placing it on the installation worksheet, next to the asset that will be tracked by this module.



2. Mark the height where the device will be installed on the door of the trailer/container.
 - The unit should be level.
 - The unit should be installed as close to the center of the asset as possible. When installing on assets with door bars, ensure there is approximately 1-2" (2.5-5cm) of clearance between the left side of the unit and the edge of the locking bar.



3. Remove the liner from the rear of the template and place the template in the desired installation location.

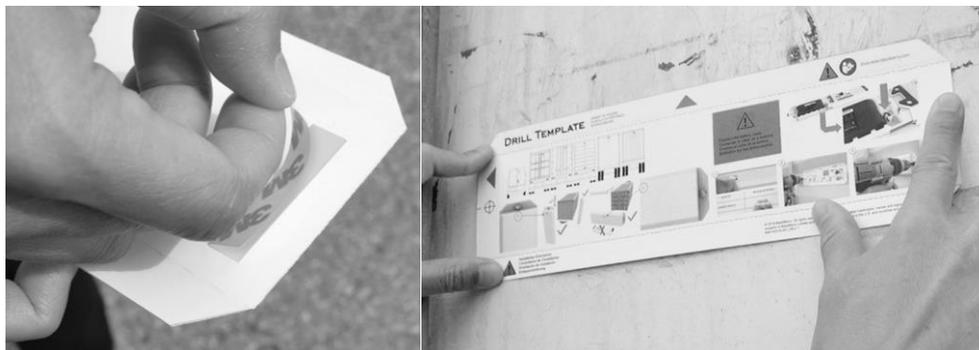

It is recommended that you install the module as level as possible on the asset. Angled installations are not supported. To help ensure the module is level, you may try one of the following techniques.

Technique 1: Position the T-square along the edge of the door. Using the T-square as a guide, draw a horizontal line approximately 5” (13 cm) in length, in the area you plan to install the device, with your pencil or marker. Align the bottom edge of the template to the line.



Tip: To avoid leaving a permanent mark on your trailer or container after the device installation is complete, we recommend using a pencil or non-permanent marker to create the guideline.

Technique 2: Visually, place the template in the desired installation location. Using a level, check that the template is level.

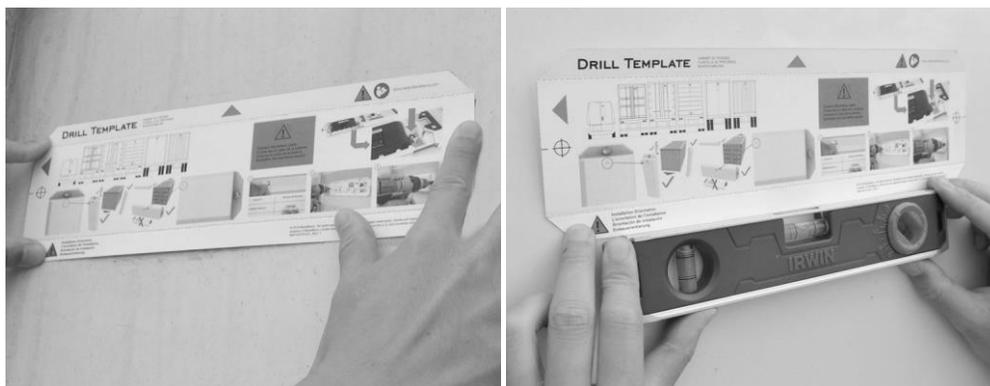

- Using a drill bit, drill a hole through each of the cross hairs on the template. This will create two holes you will use to mount the module.

Tip: If your asset is insulated (i.e., a reefer or heater) and you wish to avoid thermal losses caused from drilling through the door completely, we recommend limiting the depth of the drilling to a depth shallow enough to insert the well nut.



- Remove the template. You now have two holes in the door. If there are any burrs around the holes, remove them at this time. Also, remove any dust or debris left over from the drilling or de-burring operations and ensure surface is clean and dry.



Tip: If you are planning to use well nuts as part of your installation, you may insert the well nuts in the holes, at this time. Skip to Step 7, as you will not need to use the mounting adhesive to install the module.



6. Remove the liner from the mounting pads, to reveal the adhesive. Place the module on the door, aligning the holes on the module with the holes you drilled into the door.
IMPORTANT: This adhesive is intended only for temporary assistance during product installation. **Do not attempt long term product usage without the use of fasteners.**

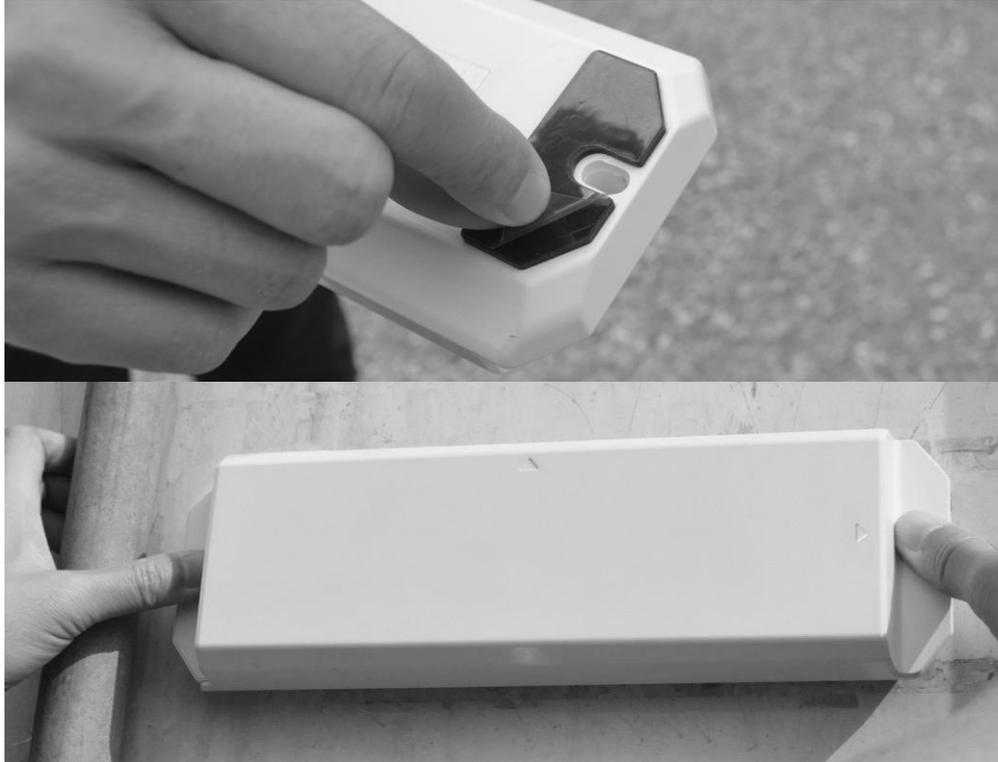

7. Insert your fastener of choice into the holes and use the appropriate tools to secure the module to the asset.



Do not over-tighten the fastener. Over-tightening can over-compress the mounting pad, which can damage the pad. Do not tighten fastener beyond 35 in-lb. (4N-m).

Tips for well nut installation

Tip 1: For fastest installation, we recommend using a drill and nut driver to install the bolt into the well nut. To avoid over tightening, use the lowest speed to install the bolt.

Tip 2: To avoid spinning the well nut during the install, we recommend pressing the module against the door while installing each fastener.

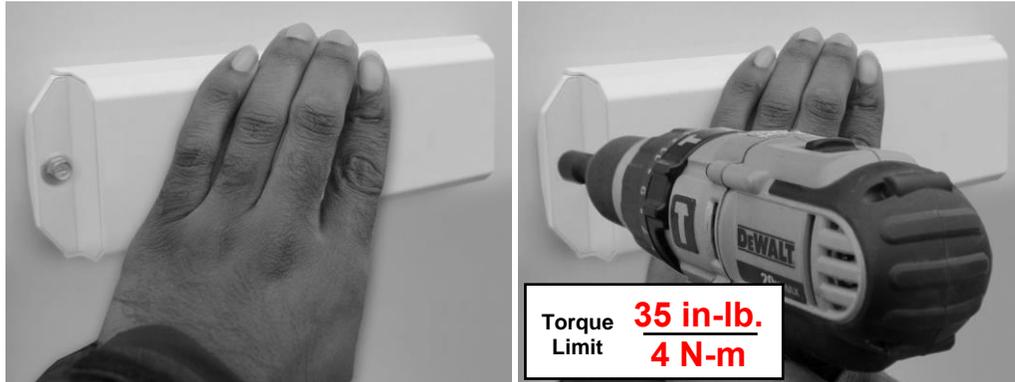

Do not over-tighten the fastener. Over-tightening can over-compress the mounting pad, which can damage the pad. Do not tighten fastener beyond 35 in-lb. (4N-m).

8. Close both doors. Installation is complete.



4 Removing BlackBerry Radar H2 modules

Use this procedure if you need to remove your BlackBerry Radar H2 module for servicing or recycling.

For more information on obtaining service for your devices, or recycling and safe disposal of your devices and batteries, contact your BlackBerry representative, or visit the following:

blackberry.com/RadarSupport--for information on service and the recycling and safe disposal of your device and battery.

Note: If you plan to ship your Radar H2 module, or Radar H2 battery, please be aware that the ***battery, and the module when shipped along with the battery***, is considered Fully Regulated Class 9 Dangerous Goods in all modes of transportation (Air, Ocean, and Ground) and must only be shipped in special UN certified Dangerous Goods packaging. If you are returning the battery, or battery with module to BlackBerry, you may request this UN-certified packaging from BlackBerry. The Radar H2 module, when shipped ***without*** the battery, is not considered Dangerous Goods and can be shipped in any package.

Also, any person who handles, offers for transport, or transports Dangerous Goods must be adequately trained and hold a training certificate; or perform those activities in the presence and under the direct supervision of a person who is adequately trained and who holds a training certificate.

Products that are considered Dangerous Goods can only move on carrier accounts that are approved for Dangerous Goods and are subject to Dangerous Goods surcharges. The Radar H2 module, when shipped without the battery, are not subject to these surcharges.

4.1 Removal Tools

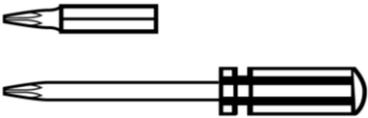
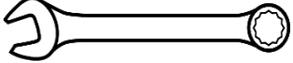
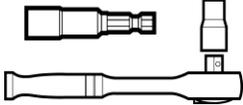
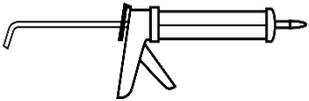
<p>Phillips (PH2) Screwdriver or Bit</p> 	<p>Drill</p> 	<p>Wrench</p>  <p><small>*Required only if nuts and bolts are used.</small></p>
<p>Nut Driver or Socket Wrench with Socket*</p>  <p><small>*Nut Driver + Drill offers fastest removal. If Nut Driver is unavailable, a socket wrench and socket may be used.</small></p>	<p>Safety Glasses</p> 	<p>Caulking Gun and Polyurethane Sealant</p>  <p><small>*Recommended for sealing holes.</small></p>

4.2 Module removal

1. Remove the module from the asset by removing the two fasteners from the ends of the module and remove the module.



4.3 Battery removal and replacement

Battery removal

1. Remove the two screws from the back of the product and separate the inner housing from the outer housing to access the battery. Retain the screws as both screws will be required to re-secure the inner housing to the outer housing

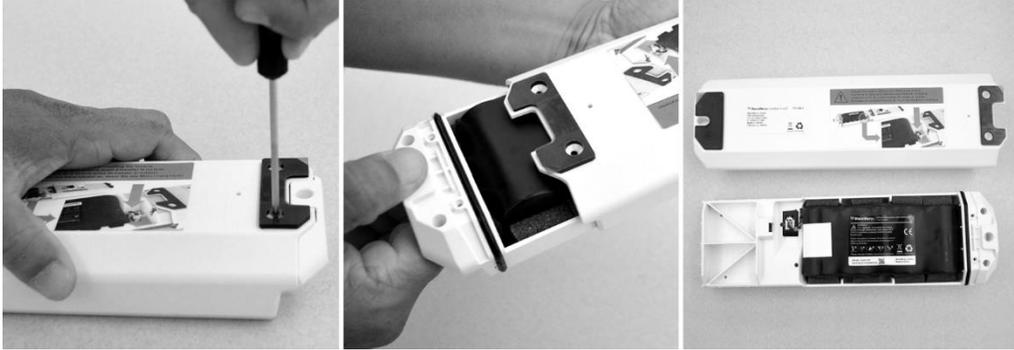

2. Disconnect the battery cable from the battery connector.



3. Remove the battery from the battery compartment by grasping the pull tab and lifting the battery out of the compartment.

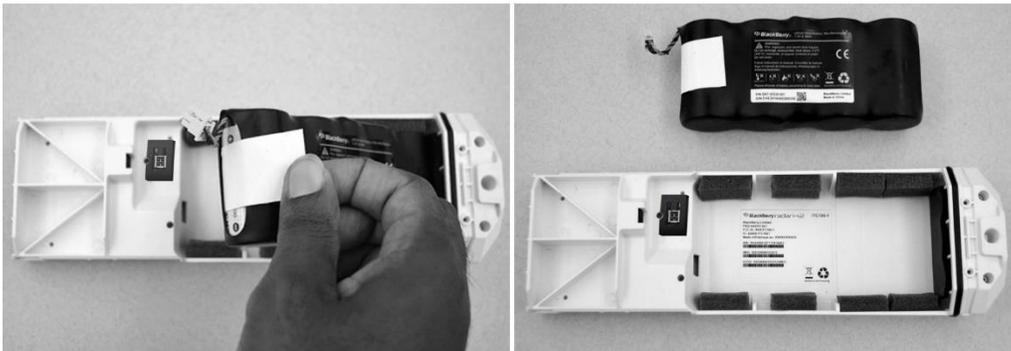

Battery replacement

The BlackBerry Radar H2 batteries are designed to provide long life between battery replacement intervals. When replacing your battery, we recommend the application of Silicone Based O-Ring Lubricant to the O-Ring during each battery replacement cycle.

One tube of Silicone Based O-Ring Lubricant is included with each box of Replacement Batteries ordered through BlackBerry. Each tube contains enough lubricant to service 10 devices.

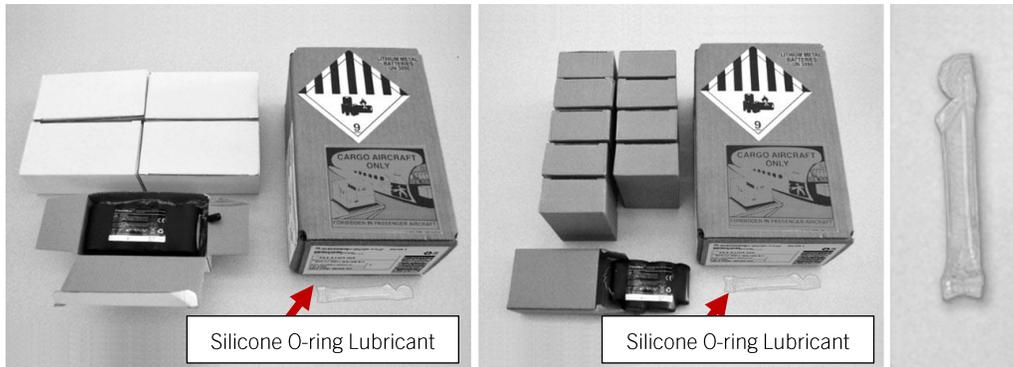

1. Insert the replacement battery into the battery compartment.



2. Connect the battery cable to the battery connector. The LED will blink to indicate the module is active. NOTE: It can take between 20-30 seconds for the blink sequence to begin. Please be patient. Once you see the LED blink, continue to the next step.



IMPORTANT: When connecting the battery cable to the battery connector, do not remove the Battery Connector Retaining Foam Retaining Tab or place the tab outside of the battery connector opening area. The Battery Connector Retaining Foam Retaining Tab is designed to fit within the battery connector opening area and provide a secure fit for the battery connector latch. Please refer to the following images for the proper orientation of the Battery Connector Retaining Foam Retaining Tab once the battery cable is connected to the battery connector.

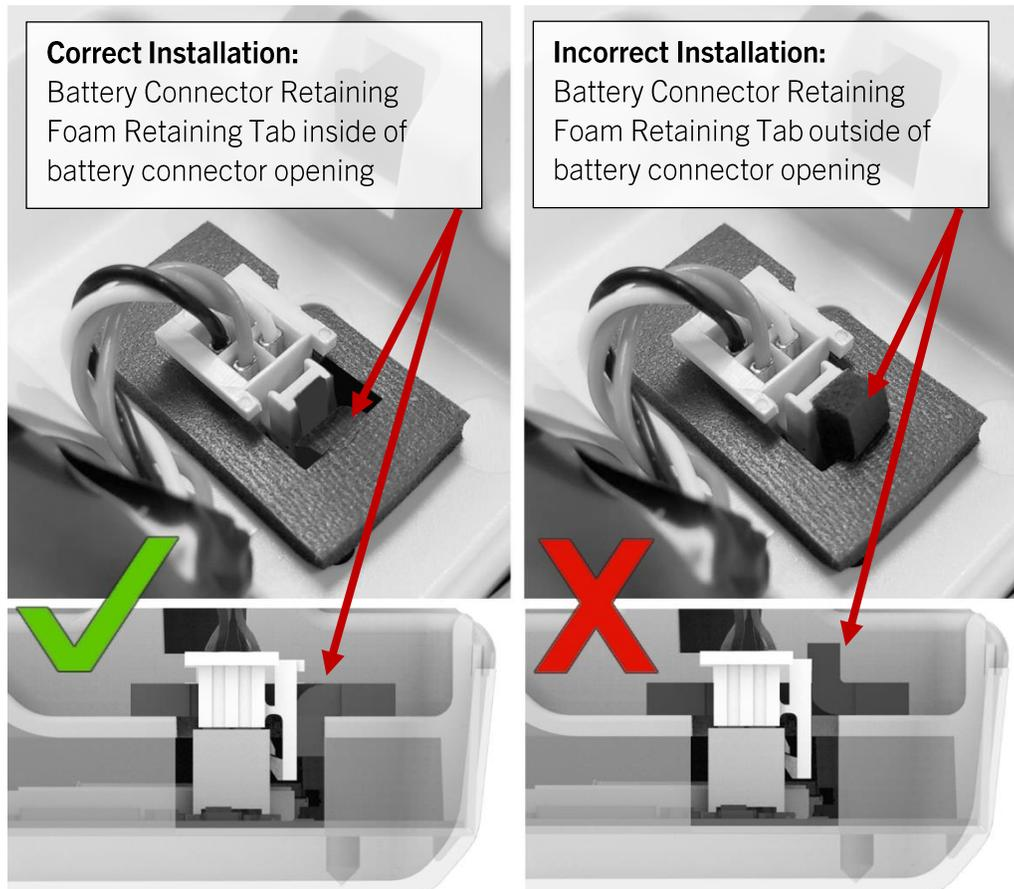

3. Locate the inner housing assembly (with the connected battery) and the Silicone O-ring Lubricant that was included in the package.



- (1) Select an appropriate applicator for applying the lubricant to the O-ring. You may use a small brush or your finger. If you do choose to apply the lubricant with your finger, we do recommend the use of rubber gloves.
- (2) Using a “pea-sized” amount of lubricant, fully coat all sides of the O-ring.

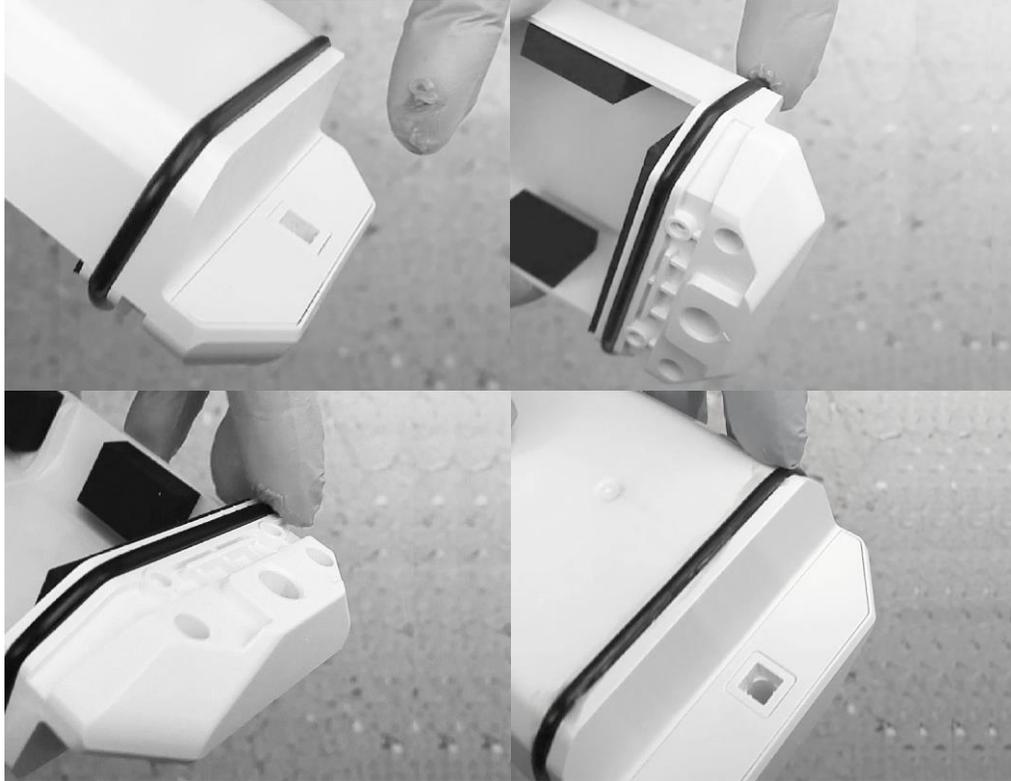

4. Completely insert the inner housing into the outer housing. Use the two screws that were provided with the device to secure the housing. **IMPORTANT:** Screw torque must be 3-3.5 in-lb. (0.35-0.4 N-m).

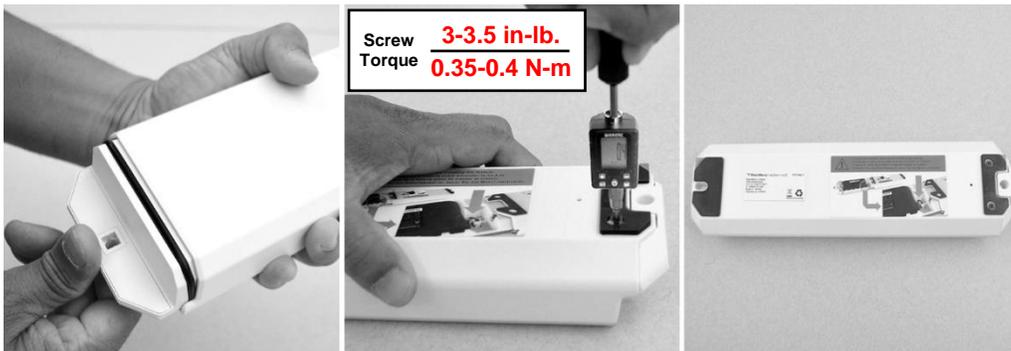

Preparing battery for shipment

If you do need to ship the battery, along with the module, please follow this procedure.

IMPORTANT: Never ship the device with the battery cable connected. Battery must be shipped inside the module with battery cable disconnected and the battery cable placed inside the connector nest.

1. Remove the two screws from the back of the product and separate the inner housing from the outer housing to access the battery. Retain the screws as both screws will be required to re-secure the inner housing to the outer housing

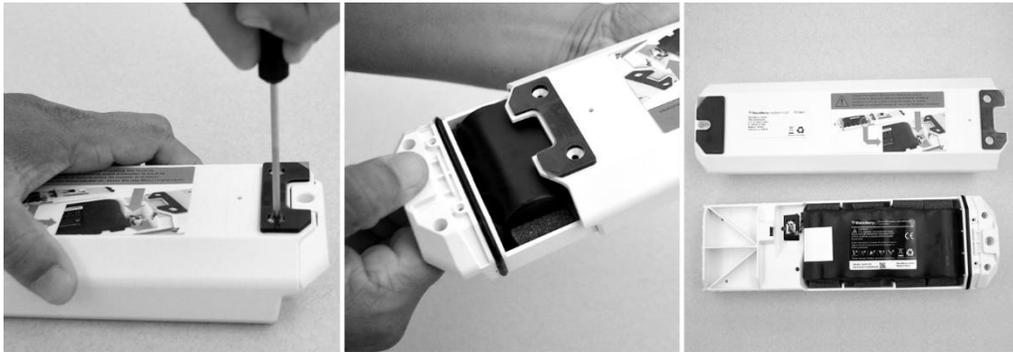

2. Ensure the battery cable is disconnected from the battery connector. Place the battery cable in the battery connector nest.

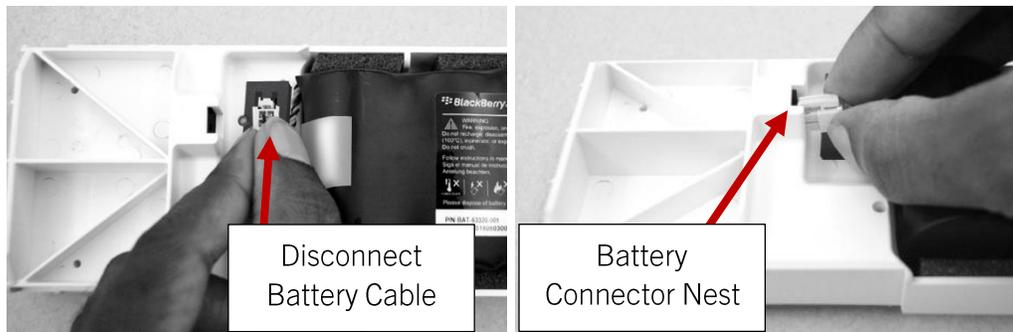

3. Place the battery cover onto the module and install both screws. Module is now ready for placement into the UN certified Dangerous Goods packaging.



4.4 Door repair

After the module has been removed from the door, there will be holes in the door. There are various techniques that can be used to repair the holes. This section will discuss some approaches you may wish to use.

Method 1: Hole Plugs

1. With the module removed, measure the size of the holes.



2. Source a set of nylon or rubber plugs, of the appropriate diameter, to fill the holes. These plugs can be sourced from hardware or auto supply stores. Insert the plugs into the holes. If desired, you may add 100% Silicone Exterior Grade caulk to the rear of the plug for extra protection to seal any gaps against water entry.



Method 2: Sealant

Note: This method works particularly well with thicker doors like dry van and roll-up doors.

1. With the module removed, you'll have two holes.



2. Fill the holes with a weatherproof sealant. If desired, you may use 100% Silicone Exterior Grade caulk or Polyurethane Sealant.



Tip: For an improved appearance, you may use a sealant that matches the door color.

Method 3: Fasteners

Note: This method works particularly well with thicker doors like dry van and roll-up doors.

1. With the module removed, you'll have two holes.



2. Insert the nuts and bolts into the holes. For added protection, place a washer between the bolt and the door surface.

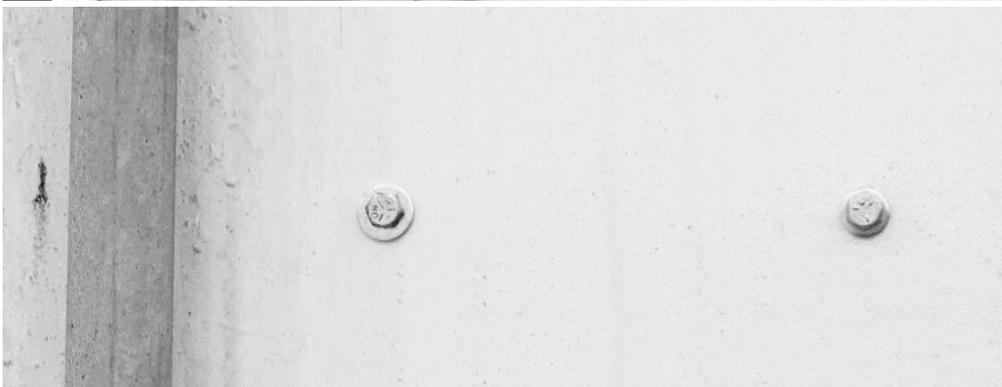

5 Support

If you run into any problem during the installation process, contact the BlackBerry Radar support team at 1-844-RADAR-BB.

Legal notice

©2021 BlackBerry. All rights reserved. BlackBerry® and related trademarks, names, and logos are the property of BlackBerry Limited and are registered and/or used in the U.S. and countries around the world. All other trademarks are the property of their respective owners.

This documentation, including any references to third-party sources of information, hardware or software, products or services (“Third Party Products and Service”), is provided or made accessible “AS IS” and “AS AVAILABLE” and without condition, endorsement, guarantee, representation, or warranty of any kind by BlackBerry Limited and its affiliated companies (“BlackBerry”). BlackBerry assumes no responsibility for any typographical, technical, or other inaccuracies, errors, or omissions in this documentation and reserves the right to periodically change information that is contained in this documentation.

The terms of use of this documentation and any BlackBerry product or service are set out in a separate license or other agreement with BlackBerry applicable thereto. Certain features outlined in this documentation may require Third Party Products and Services and your use of Third Party Products and Services shall be governed by and subject to you agreeing to the terms of separate agreements applicable thereto with third parties.

BlackBerry Limited
2200 University Avenue East
Waterloo, Ontario
Canada N2K 0A7

Published in Canada