

FCC Test Report

(PART 22)

Report No.: RFBFKV-WTW-P21060810

FCC ID: L6AITF100-2

Test Model: ITF100-2, ITF100-3 (Refer to item 3.1 for more details)

Received Date: Jul. 10, 2021

Test Date: Sep. 30, 2021 ~ Oct. 06, 2021

Issued Date: Oct. 27, 2021

Applicant: BlackBerry Limited

Address: 2200 University Avenue East, Waterloo, Ontario, Canada N2K 0A7

Issued By: Bureau Veritas Consumer Products Services (H.K.) Ltd., Taoyuan Branch
Lin Kou Laboratories

Lab Address: No. 47-2, 14th Ling, Chia Pau Vil., Lin Kou Dist., New Taipei City, Taiwan

Test Location: No.19, Hwa Ya 2nd Rd., Wen Hwa Vil., Kwei Shan Dist., Taoyuan City
33383, Taiwan

**FCC Registration /
Designation Number:** 788550 / TW0003



This report is for your exclusive use. Any copying or replication of this report to or for any other person or entity, or use of our name or trademark, is permitted only with our prior written permission. This report sets forth our findings solely with respect to the test samples identified herein. The results set forth in this report are not indicative or representative of the quality or characteristics of the lot from which a test sample was taken or any similar or identical product unless specifically and expressly noted. Our report includes all of the tests requested by you and the results thereof based upon the information that you provided to us. You have 60 days from date of issuance of this report to notify us of any material error or omission caused by our negligence, provided, however, that such notice shall be in writing and shall specifically address the issue you wish to raise. A failure to raise such issue within the prescribed time shall constitute your unqualified acceptance of the completeness of this report, the tests conducted and the correctness of the report contents. Unless specific mention, the uncertainty of measurement has been explicitly taken into account to declare the compliance or non-compliance to the specification.

Table of Contents

Release Control Record	4
1 Certificate of Conformity	5
2 Summary of Test Results	6
2.1 Measurement Uncertainty	6
2.2 Test Site and Instruments	7
3 General Information	9
3.1 General Description of EUT	9
3.2 Configuration of System under Test	11
3.2.1 Description of Support Units	11
3.3 Test Mode Applicability and Tested Channel Detail	11
3.4 EUT Operating Conditions	14
3.5 General Description of Applied Standards and references	14
4 Test Types and Results	15
4.1 Output Power Measurement	15
4.1.1 Limits of Output Power Measurement	15
4.1.2 Test Procedures	15
4.1.3 Test Setup	16
4.1.4 Test Results	17
4.2 Modulation Characteristics Measurement	23
4.2.1 Limits of Modulation Characteristics	23
4.2.2 Test Setup	23
4.2.3 Test Procedure	23
4.2.4 Test Results	24
4.3 Frequency Stability Measurement	25
4.3.1 Limits of Frequency Stability Measurement	25
4.3.2 Test Procedure	25
4.3.3 Test Setup	25
4.3.4 Test Results	26
4.4 Occupied Bandwidth Measurement	33
4.4.1 Test Procedure	33
4.4.2 Test Setup	33
4.4.3 Test Result	34
4.5 Band Edge Measurement	38
4.5.1 Limits of Band Edge Measurement	38
4.5.2 Test Setup	38
4.5.3 Test Procedures	38
4.5.4 Test Results	39
4.6 Peak to Average Ratio	44
4.6.1 Limits of Peak to Average Ratio Measurement	44
4.6.2 Test Setup	44
4.6.3 Test Procedures	44
4.6.4 Test Results	45
4.7 Conducted Spurious Emissions	48
4.7.1 Limits of Conducted Spurious Emissions Measurement	48
4.7.2 Test Setup	48
4.7.3 Test Procedure	48
4.7.4 Test Results	49
4.8 Radiated Emission Measurement	56
4.8.1 Limits of Radiated Emission Measurement	56
4.8.2 Test Procedure	56
4.8.3 Deviation from Test Standard	56
4.8.4 Test Setup	57
4.8.5 Test Results	58

5 Pictures of Test Arrangements.....	78
Appendix – Information of the Testing Laboratories	79

Release Control Record

Issue No.	Description	Date Issued
RFBFKV-WTW-P21060810	Original Release	Oct. 27, 2021

1 Certificate of Conformity

Product: Radar H2

Brand: BlackBerry

Test Model: ITF100-2, ITF100-3 (Refer to item 3.1 for more details)

Sample Status: Identical Prototype

Applicant: BlackBerry Limited

Test Date: Sep. 30, 2021 ~ Oct. 06, 2021

Standards: FCC Part 22, Subpart H

The above equipment has been tested by **Bureau Veritas Consumer Products Services (H.K.) Ltd., Taoyuan Branch**, and found compliance with the requirement of the above standards. The test record, data evaluation & Equipment Under Test (EUT) configurations represented herein are true and accurate accounts of the measurements of the sample's RF characteristics under the conditions specified in this report.

Prepared by : Lena Wang , **Date:** Oct. 27, 2021
Lena Wang / Specialist

Approved by : Dylan Chiou , **Date:** Oct. 27, 2021
Dylan Chiou / Senior Engineer

2 Summary of Test Results

Applied Standard: FCC Part 22 & Part 2			
FCC Clause	Test Item	Result	Remarks
2.1046 22.913 (a)	Effective Radiated Power	Pass	Meet the requirement of limit.
2.1047	Modulation Characteristics	Pass	Meet the requirement.
22.913 (d)	Peak to Average Ratio	Pass	Meet the requirement of limit.
2.1055 22.355	Frequency Stability	Pass	Meet the requirement of limit.
2.1049	Occupied Bandwidth	Pass	Meet the requirement of limit.
22.917	Band Edge Measurements	Pass	Meet the requirement of limit.
2.1051 22.917	Conducted Spurious Emissions	Pass	Meet the requirement of limit.
2.1053 22.917	Radiated Spurious Emissions	Pass	Meet the requirement of limit. Minimum passing margin is -24.36 dB at 1696.60 MHz.

Note: Determining compliance based on the results of the compliance measurement, not taking into account measurement instrumentation uncertainty.

2.1 Measurement Uncertainty

Where relevant, the following measurement uncertainty levels have been estimated for tests performed on the EUT as specified in CISPR 16-4-2:

Measurement	Frequency	Expanded Uncertainty (k=2) (\pm)
Radiated Emissions up to 1 GHz	9 kHz ~ 30 MHz	3.04 dB
	30 MHz ~ 200 MHz	2.93 dB
	200 MHz ~ 1000 MHz	2.95 dB
Radiated Emissions above 1 GHz	1 GHz ~ 18 GHz	2.26 dB
	18 GHz ~ 40 GHz	1.94 dB

2.2 Test Site and Instruments

Description & Manufacturer	Model No.	Serial No.	Date of Calibration	Due Date of Calibration
Test Receiver KEYSIGHT	N9038A	MY55420137	Apr. 09, 2021	Apr. 08, 2022
Spectrum Analyzer ROHDE & SCHWARZ	FSP40	100039	Jun. 10, 2021	Jun. 09, 2022
BILOG Antenna SCHWARZBECK	VULB9168	9168-160	Nov. 06, 2020	Nov. 05, 2021
BILOG Antenna SCHWARZBECK	VULB9168	9168-472	Nov. 06, 2020	Nov. 05, 2021
HORN Antenna SCHWARZBECK	BBHA 9120 D	9120D-1169	Nov. 22, 2020	Nov. 21, 2021
HORN Antenna SCHWARZBECK	BBHA 9170	BBHA9170241	Nov. 22, 2020	Nov. 21, 2021
Preamplifier Agilent (Below 1GHz)	8447D	2944A10638	Jun. 05, 2021	Jun. 04, 2022
Preamplifier Agilent (Above 1GHz)	8449B	3008A02367	Feb. 17, 2021	Feb. 16, 2022
RF signal cable HUBER+SUHNER&EMCI	SUCOFLEX 104 & EMC104-SM- SM8000	CABLE-CH9-02 (248780+171006)	Jan. 16, 2021	Jan. 15, 2022
RF signal cable HUBER+SUHNER	SUCOFLEX 104	CABLE-CH9- (250795/4)	Jan. 16, 2021	Jan. 15, 2022
RF signal cable Woken	8D-FB	Cable-CH9-01	Jun. 05, 2021	Jun. 04, 2022
Software BV ADT	ADT_Radiated_ V7.6.15.9.5	NA	NA	NA
Antenna Tower & Turn BV ADT	AT100	AT93021705	NA	NA
Turn Table BV ADT	TT100	TT93021705	NA	NA
Turn Table Controller BV ADT	SC100	SC93021705	NA	NA
Boresight Antenna Fixture	FBA-01	FBA-SIP01	NA	NA
Standard Temperature And Humidity Chamber TERCHY	MHU-225AU	920842	Jun. 15, 2021	Jun. 14, 2022
JFW 20dB attenuation	50HF-020-SMA	NA	NA	NA
True RMS Clamp Meter Fluke	325	31130711WS	Jun. 02, 2021	Jun. 01, 2022
Radio Communication Analyzer Anritsu	MT8820C	6201300640	Aug. 26, 2021	Aug. 25, 2022
Radio Communication Analyzer Anritsu	MT8821C	6201462755	Feb. 07, 2021	Feb. 06, 2022
Radio Communication Tester ROHDE & SCHWARZ	CMU200	101095	Nov. 18, 2020	Nov. 17, 2021
DC power supply Keysight	U8002A	MY56330015	NA	NA

- Note: 1. The calibration interval of the above test instruments is 12 / 24months and the calibrations are traceable to NML/ROC and NIST/USA.
2. The test was performed in HwaYa Chamber 9.

3 General Information

3.1 General Description of EUT

Product	Radar H2		
Brand	BlackBerry		
Test Model	ITF100-2, ITF100-3		
Model Difference	Refer to Note as below		
Status of EUT	Identical Prototype		
Power Supply Rating	7.2 Vdc (battery)		
Modulation Type	GPRS	GMSK	
	EDGE	GMSK, 8PSK	
	WCDMA	QPSK	
	LTE	QPSK, 16QAM	
Frequency Range	GPRS/EDGE	824.2 ~ 848.8 MHz	
	WCDMA	826.4 ~ 846.6 MHz	
	LTE 5 (Channel Bandwidth: 1.4 MHz)	824.7 ~ 848.3 MHz	
	LTE 5 (Channel Bandwidth: 3 MHz)	825.5 ~ 847.5 MHz	
	LTE 5 (Channel Bandwidth: 5 MHz)	826.5 ~ 846.5 MHz	
	LTE 5 (Channel Bandwidth: 10 MHz)	829 ~ 844 MHz	
Max. ERP Power	GPRS	993.116 mW (29.97 dBm)	
	EDGE	831.764 mW (29.20 dBm)	
	WCDMA	143.880 mW (21.58 dBm)	
		QPSK	16QAM
	LTE 5 (Channel Bandwidth: 1.4 MHz)	127.057 mW (21.04 dBm)	102.094 mW (20.09 dBm)
	LTE 5 (Channel Bandwidth: 3 MHz)	128.825 mW (21.10 dBm)	101.391 mW (20.06 dBm)
	LTE 5 (Channel Bandwidth: 5 MHz)	127.057 mW (21.04 dBm)	102.565 mW (20.11 dBm)
	LTE 5 (Channel Bandwidth: 10 MHz)	129.420 mW (21.12 dBm)	101.158 mW (20.05 dBm)
Emission Designator	GPRS	250KGXW	
	EDGE	248KG7W	
	WCDMA	4M16F9W	
	LTE 5 (Channel Bandwidth: 1.4 MHz)	1M09D7W	
	LTE 5 (Channel Bandwidth: 3 MHz)	2M70G7D	
	LTE 5 (Channel Bandwidth: 5 MHz)	4M49G7D	
	LTE 5 (Channel Bandwidth: 10 MHz)	8M98D7W	
Antenna Type	Refer to Note as below		
Accessory Device	Refer to Note as below		
Data Cable Supplied	Refer to Note as below		

Note:

1. All models are listed as below.

Mode	Brand	Supplier Code	Model	Difference
A	BlackBerry	B13	ITF100-3	with battery model 63320-001 /7.2V,38Ah
B		B12	ITF100-2	with battery model 63318-001 /7.2V,19Ah

2. The EUT contains following accessory devices.

Product	Brand	Model	Description	Remark
Battery 1	BlackBerry	BAT-63320-001	7.2 Vdc, 38 A	(for ITF100-3)
Battery 2	BlackBerry	BAT-63318-001	7.2 Vdc, 19 A	(for ITF100-2)

*The both difference are only in battery, therefore ITF100-2 only verifies the Radiated Spurious Emissions below 1GHz

3. The antenna information is listed as below.

Antenna Type	Monopole with gnd resonator
Band	GSM 850 / WCDMA / LTE
	5
Gain (dBi)	0.57

4. The above Antenna information is declared by manufacturer and for more detailed features description, please refer to the manufacturer's specifications, the laboratory shall not be held responsible.

5. The above EUT information is declared by manufacturer and for more detailed features description, please refers to the manufacturer's specifications or user's manual.

3.2 Configuration of System under Test

<Radiated Emission Test> & <E.R.P. Test>

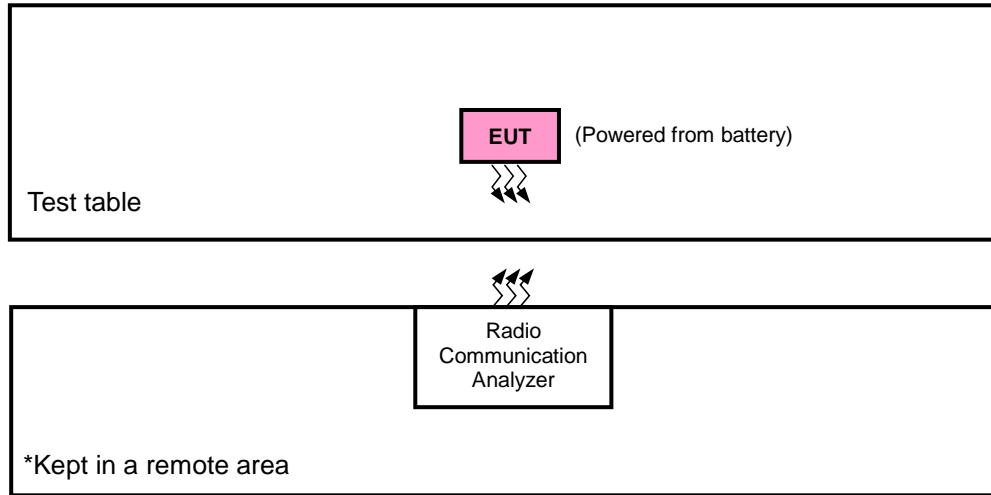

3.2.1 Description of Support Units

The EUT has been tested as an independent unit together with other necessary accessories or support units.

3.3 Test Mode Applicability and Tested Channel Detail

Pre-Scan has been conducted to determine the worst-case mode from all possible combinations between available modulations, data rates, XYZ axis, and antenna ports.

The worst case was found when positioned as the table below. Following channel(s) was (were) selected for the final test as listed below:

For Mode A

Band	Radiated Emission
GSM 850	Z-axis
WCDMA	Z-axis
LTE Band 5	Z-axis

For Mode B

Band	Radiated Emission
GSM 850	X-axis
WCDMA	X-axis
LTE Band 5	X-axis

GSM 850

EUT Configure Mode	Test Item	Available Channel	Tested Channel	Mode
A	ERP	128 to 251	128, 189, 251	GPRS, EDGE
A	Modulation Characteristics	128 to 251	189	GPRS, EDGE
A	Frequency Stability	128 to 251	128, 251	GPRS, EDGE
A	Occupied Bandwidth	128 to 251	128, 189, 251	GPRS, EDGE
A	Band Edge	128 to 251	128, 251	GPRS, EDGE
A	Peak to Average Ratio	128 to 251	128, 189, 251	GPRS, EDGE
A	Conducted Emission	128 to 251	128, 189, 251	GPRS, EDGE
A, B	Radiated Emission	128 to 251	128, 189, 251	GPRS

Note:

1. According ERP power test, pre-tested GPRS, EDGE modulation type and found GPRS was the worst. For radiated emission test, pre-tested GPRS, EDGE modulation type and found GPRS was the worst, therefore chosen for the final test.
2. For radiated emissions below 1 GHz, select the worst radiated emission channel for final testing.
3. For Mode B only radiated emissions below 1 GHz test had been performed and presented in this report.

WCDMA

EUT Configure Mode	Test Item	Available Channel	Tested Channel	Mode
A	ERP	4132 to 4233	4132, 4182, 4233	WCDMA
A	Modulation Characteristics	4132 to 4233	4182	WCDMA
A	Frequency Stability	4132 to 4233	4132, 4233	WCDMA
A	Occupied Bandwidth	4132 to 4233	4132, 4182, 4233	WCDMA
A	Band Edge	4132 to 4233	4132, 4233	WCDMA
A	Peak to Average Ratio	4132 to 4233	4132, 4182, 4233	WCDMA
A	Conducted Emission	4132 to 4233	4132, 4182, 4233	WCDMA
A, B	Radiated Emission	4132 to 4233	4132, 4182, 4233	WCDMA

Note:

1. For radiated emissions below 1 GHz, select the worst radiated emission channel for final testing.
2. For Mode B only radiated emissions below 1 GHz test had been performed and presented in this report.

LTE Band 5

EUT Configure Mode	Test Item	Available Channel	Tested Channel	Channel Bandwidth	Modulation	Mode		
A	ERP	20407 to 20643	20407, 20525, 20643	1.4 MHz	QPSK, 16QAM	1 RB / 0 RB Offset		
		20415 to 20635	20415, 20525, 20635	3 MHz	QPSK, 16QAM	1 RB / 7 RB Offset		
		20425 to 20625	20425, 20525, 20625	5 MHz	QPSK, 16QAM	1 RB / 12 RB Offset		
		20450 to 20600	20450, 20525, 20600	10 MHz	QPSK, 16QAM	1 RB / 24 RB Offset		
A	Modulation Characteristics	20450 to 20600	20525	10 MHz	QPSK, 16QAM	50 RB / 0 RB Offset		
A	Frequency Stability	20407 to 20643	20407, 20643	1.4 MHz	QPSK	6 RB / 0 RB Offset		
		20415 to 20635	20415, 20635	3 MHz	QPSK	15 RB / 0 RB Offset		
		20425 to 20625	20425, 20625	5 MHz	QPSK	25 RB / 0 RB Offset		
		20450 to 20600	20450, 20600	10 MHz	QPSK	50 RB / 0 RB Offset		
A	Occupied Bandwidth	20407 to 20643	20407, 20525, 20643	1.4 MHz	QPSK, 16QAM	6 RB / 0 RB Offset		
		20415 to 20635	20415, 20525, 20635	3 MHz	QPSK, 16QAM	15 RB / 0 RB Offset		
		20425 to 20625	20425, 20525, 20625	5 MHz	QPSK, 16QAM	25 RB / 0 RB Offset		
		20450 to 20600	20450, 20525, 20600	10 MHz	QPSK, 16QAM	50 RB / 0 RB Offset		
A	Band Edge	20407 to 20643	20407	1.4MHz	QPSK	1 RB / 0 RB Offset 6 RB / 0 RB Offset		
			20643	1.4MHz	QPSK	1 RB / 5 RB Offset 6 RB / 0 RB Offset		
		20415 to 20635	20415	3 MHz	QPSK	1 RB / 0 RB Offset 15 RB / 0 RB Offset		
			20635	3 MHz	QPSK	1 RB / 14 RB Offset 15 RB / 0 RB Offset		
		20425 to 20625	20425	5 MHz	QPSK	1 RB / 0 RB Offset 25 RB / 0 RB Offset		
			20625	5 MHz	QPSK	1 RB / 24 RB Offset 25 RB / 0 RB Offset		
		20450 to 20600	20450	10 MHz	QPSK	1 RB / 0 RB Offset 50 RB / 0 RB Offset		
			20600	10 MHz	QPSK	1 RB / 49 RB Offset 50 RB / 0 RB Offset		
		A	Peak to Average Ratio	20407 to 20643	20407, 20525, 20643	1.4 MHz	QPSK, 16QAM	1 RB / 0 RB Offset
				20415 to 20635	20415, 20525, 20635	3 MHz	QPSK, 16QAM	1 RB / 7 RB Offset
				20425 to 20625	20425, 20525, 20625	5 MHz	QPSK, 16QAM	1 RB / 12 RB Offset
				20450 to 20600	20450, 20525, 20600	10 MHz	QPSK, 16QAM	1 RB / 24 RB Offset
A	Conducted Emission	20407 to 20643	20407, 20525, 20643	1.4 MHz	QPSK	1 RB / 0 RB Offset		
		20415 to 20635	20415, 20525, 20635	3 MHz	QPSK	1 RB / 7 RB Offset		
		20425 to 20625	20425, 20525, 20625	5 MHz	QPSK	1 RB / 12 RB Offset		
		20450 to 20600	20450, 20525, 20600	10 MHz	QPSK	1 RB / 24 RB Offset		
A, B	Radiated Emission	20407 to 20643	20407, 20525, 20643	1.4 MHz	QPSK	1 RB / 0 RB Offset		
		20425 to 20625	20425, 20525, 20625	5 MHz	QPSK	1 RB / 12 RB Offset		
		20450 to 20600	20450, 20525, 20600	10 MHz	QPSK	1 RB / 24 RB Offset		

Note:

1. This device was tested under all bandwidths, RB configurations and modulations. The worst case was found in QPSK modulation. Therefore, only ERP, modulation characteristics, occupied bandwidth and peak to average ratio items had been tested under QPSK, 16QAM mode, the other items were performed under QPSK mode only.
2. For radiated emission above 1 GHz, according to 3GPP 36.521 Section 6.6.3.1.4, choose the lowest, 5 MHz & highest channel bandwidth for final test.

3. For radiated emissions below 1 GHz, select the worst radiated emission channel for final testing.
4. For Mode B only radiated emissions below 1 GHz test had been performed and presented in this report.

Test Condition:

Test Item	Environmental Conditions	Input Power	Tested By
ERP	25 deg. C, 65 % RH	7.2 Vdc	Noah Chen
Modulation Characteristics	25 deg. C, 65 % RH	7.2 Vdc	Noah Chen
Frequency Stability	25 deg. C, 65 % RH	7.2 Vdc	Noah Chen
Occupied Bandwidth	25 deg. C, 65 % RH	7.2 Vdc	Noah Chen
Band Edge	25 deg. C, 65 % RH	7.2 Vdc	Noah Chen
Peak to Average Ratio	25 deg. C, 65 % RH	7.2 Vdc	Noah Chen
Conducted Emission	25 deg. C, 65 % RH	7.2 Vdc	Noah Chen
Radiated Emission	25 deg. C, 65 % RH	7.2 Vdc	Greg Lin, Rex Wang

3.4 EUT Operating Conditions

The EUT makes a call to the communication simulator. The communication simulator station system controlled a EUT to export maximum output power under transmission mode and specific channel frequency.

3.5 General Description of Applied Standards and references

The EUT is a RF Product. According to the specifications of the manufacturer, it must comply with the requirements of the following standards and references:

Test Standard:

FCC 47 CFR Part 2

FCC 47 CFR Part 22

ANSI 63.26-2015

Note: All test items have been performed and recorded as per the above standards.

References Test Guidance:

KDB 971168 D01 Power Meas License Digital Systems v03r01

ANSI/TIA/EIA-603-E 2016

Note: All test items have been performed as a reference to the above KDB test guidance.

4 Test Types and Results

4.1 Output Power Measurement

4.1.1 Limits of Output Power Measurement

Mobile / Portable station are limited to 7 watts e.r.p.

4.1.2 Test Procedures

Conducted Power Measurement:

The EUT was set up for the maximum power with GSM, WCDMA, LTE link data modulation and link up with simulator. Set the EUT to transmit under low, middle and high channel and record the power level shown on simulator.

Maximum EIRP / ERP

The relevant equation for determining the maximum ERP or EIRP from the measured RF output power is given in Equation as follows:

$$\text{EIRP} = P_{\text{Meas}} + G_{\text{T}}$$

$$\text{ERP} = P_{\text{Meas}} + G_{\text{T}} - 2.15$$

where

ERP or EIRP effective radiated power or equivalent isotropically radiated power, respectively
(expressed in the same units as P_{Meas} , e.g., dBm or dBW)

P_{Meas} measured transmitter output power or PSD, in dBm or dBW

G_{T} gain of the transmitting antenna, in dBd (ERP) or dBi (EIRP)

4.1.3 Test Setup

EIRP / ERP Measurement:

<Radiated Emission above 1 GHz>

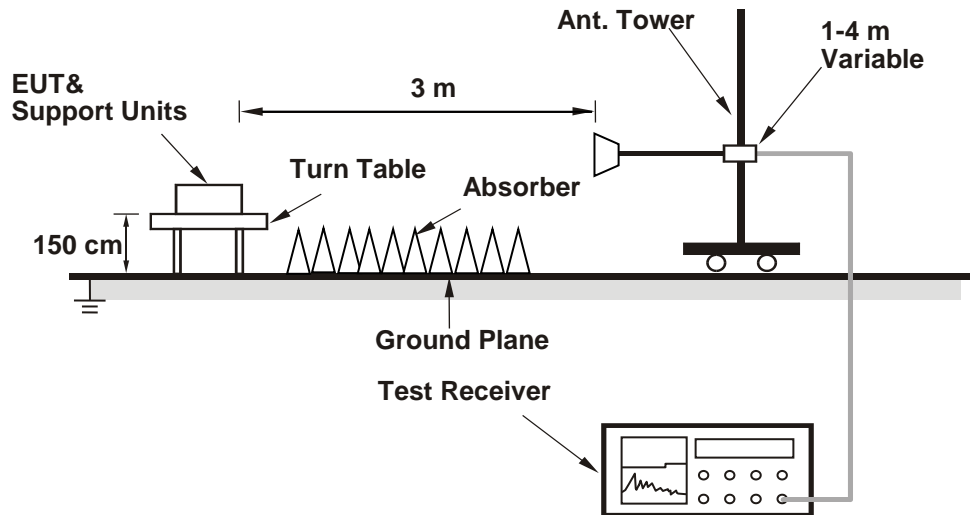

For the actual test configuration, please refer to the attached file (Test Setup Photo).

Conducted Power Measurement:

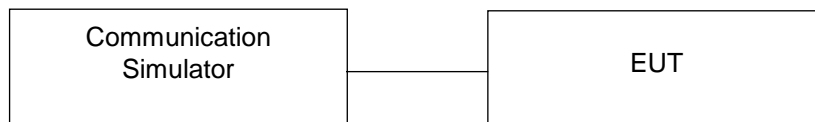

4.1.4 Test Results

Conducted Output Power (dBm)

Band	GSM850		
Channel	128	189	251
Frequency (MHz)	824.2	836.4	848.8
GPRS 8	31.55	31.37	31.30
GPRS 10	31.26	31.42	31.49
GPRS 11	31.35	31.34	31.27
GPRS 12	31.43	31.41	31.29
GPRS 30	31.30	31.29	31.43
GPRS 31	31.41	31.41	31.27
GPRS 32	31.29	31.28	31.44
GPRS 33	31.33	31.40	31.42
GPRS 34	31.28	31.44	31.41
DTM 9 (GPRS)	31.39	31.36	31.42
DTM 11 (GPRS)	31.30	31.39	31.41
EDGE 8 (MCS9)	30.76	30.67	30.72
EDGE 10 (MCS9)	30.67	30.69	30.57
EDGE 11 (MCS9)	30.63	30.65	30.64
EDGE 12 (MCS9)	30.59	30.51	30.70
EDGE 30 (MCS9)	30.59	30.56	30.76
EDGE 31 (MCS9)	30.66	30.56	30.65
EDGE 32 (MCS9)	30.71	30.64	30.64
EDGE 33 (MCS9)	30.58	30.78	30.62
EDGE 34 (MCS9)	30.60	30.61	30.57
DTM 9 (EDGE)	30.58	30.66	30.69
DTM 11 (EDGE)	30.59	30.68	30.73

Band	WCDMA V		
Channel	4132	4182	4233
Frequency (MHz)	826.4	836.4	846.6
RMC 12.2K	23.15	23.03	23.16
HSDPA Subtest-1	22.56	22.35	22.32
HSDPA Subtest-2	22.47	22.38	22.46
HSDPA Subtest-3	22.49	22.24	22.53
HSDPA Subtest-4	22.47	22.48	22.49
HSUPA Subtest-1	21.67	21.72	21.72
HSUPA Subtest-2	21.74	21.86	21.76
HSUPA Subtest-3	21.84	21.69	21.68
HSUPA Subtest-4	21.81	21.67	21.82
HSUPA Subtest-5	21.60	21.69	21.67

LTE Band 5						
BW	MCS Index	RB Size	RB Offset	Low	Mid	High
		Channel		20407	20525	20643
		Frequency (MHz)		824.7	836.5	848.3
1.4M	QPSK	1	0	22.49	22.55	22.61
		1	2	22.45	22.60	22.45
		1	5	22.59	22.44	22.62
		3	0	21.44	21.29	21.52
		3	1	21.33	21.39	21.61
		3	3	21.62	21.29	21.48
		6	0	21.45	21.53	21.37
	16QAM	1	0	21.48	21.67	21.52
		1	2	21.50	21.53	21.42
		1	5	21.42	21.56	21.53
		3	0	20.36	20.41	20.55
		3	1	20.36	20.46	20.53
		3	3	20.53	20.25	20.47
		6	0	20.51	20.52	20.42
BW	MCS Index	RB Size	RB Offset	Low	Mid	High
		Channel		20415	20525	20635
		Frequency (MHz)		825.5	836.5	847.5
3M	QPSK	1	0	22.49	22.62	22.55
		1	7	22.47	22.68	22.50
		1	14	22.42	22.40	22.62
		8	0	21.33	21.36	21.44
		8	3	21.40	21.28	21.56
		8	7	21.56	21.24	21.49
		15	0	21.49	21.64	21.23
	16QAM	1	0	21.34	21.64	21.59
		1	7	21.31	21.63	21.39
		1	14	21.53	21.48	21.43
		8	0	20.33	20.27	20.40
		8	3	20.37	20.34	20.59
		8	7	20.58	20.30	20.35
		15	0	20.46	20.61	20.24

LTE Band 5						
BW	MCS Index	RB Size	RB Offset	Low	Mid	High
		Channel		20425	20525	20625
		Frequency (MHz)		826.5	836.5	846.5
5M	QPSK	1	0	22.57	22.48	22.49
		1	12	22.31	22.23	22.62
		1	24	22.62	22.60	22.43
		12	0	21.35	21.43	21.58
		12	6	21.49	21.61	21.26
		12	13	21.52	21.70	21.44
		25	0	21.40	21.31	21.37
	16QAM	1	0	21.43	21.60	21.55
		1	12	21.38	21.33	21.69
		1	24	21.48	21.56	21.43
		12	0	20.46	20.54	20.57
		12	6	20.42	20.61	20.40
		12	13	20.53	20.54	20.43
		25	0	20.29	20.41	20.39
BW	MCS Index	RB Size	RB Offset	Low	Mid	High
		Channel		20450	20525	20600
		Frequency (MHz)		829	836.5	844
10M	QPSK	1	0	22.56	22.28	22.36
		1	24	22.27	22.70	22.53
		1	49	22.42	22.56	22.57
		25	0	21.61	21.31	21.36
		25	12	21.58	21.28	21.53
		25	25	21.37	21.37	21.33
		50	0	21.45	21.32	21.40
	16QAM	1	0	21.54	21.42	21.34
		1	24	21.38	21.63	21.55
		1	49	21.50	21.48	21.48
		25	0	20.55	20.40	20.45
		25	12	20.63	20.33	20.68
		25	25	20.45	20.41	20.29
		50	0	20.36	20.42	20.46

ERP Power (dBm)

Band	GSM850		
	128	189	251
Channel	128	189	251
Frequency (MHz)	824.2	836.4	848.8
GPRS 8	29.97	29.79	29.72
GPRS 10	29.68	29.84	29.91
GPRS 11	29.77	29.76	29.69
GPRS 12	29.85	29.83	29.71
GPRS 30	29.72	29.71	29.85
GPRS 31	29.83	29.83	29.69
GPRS 32	29.71	29.70	29.86
GPRS 33	29.75	29.82	29.84
GPRS 34	29.70	29.86	29.83
DTM 9 (GPRS)	29.81	29.78	29.84
DTM 11 (GPRS)	29.72	29.81	29.83
EDGE 8 (MCS9)	29.18	29.09	29.14
EDGE 10 (MCS9)	29.09	29.11	28.99
EDGE 11 (MCS9)	29.05	29.07	29.06
EDGE 12 (MCS9)	29.01	28.93	29.12
EDGE 30 (MCS9)	29.01	28.98	29.18
EDGE 31 (MCS9)	29.08	28.98	29.07
EDGE 32 (MCS9)	29.13	29.06	29.06
EDGE 33 (MCS9)	29.00	29.20	29.04
EDGE 34 (MCS9)	29.02	29.03	28.99
DTM 9 (EDGE)	29.00	29.08	29.11
DTM 11 (EDGE)	29.01	29.10	29.15

*ERP = Conducted + antenna gain (0.57dBi)-2.15

Band	WCDMA V		
	4132	4182	4233
TX Channel	4132	4182	4233
Rx Channel	4357	4407	4458
Frequency (MHz)	826.4	836.4	846.6
RMC 12.2K	21.57	21.45	21.58
HSDPA Subtest-1	20.98	20.77	20.74
HSDPA Subtest-2	20.89	20.80	20.88
HSDPA Subtest-3	20.91	20.66	20.95
HSDPA Subtest-4	20.89	20.90	20.91
HSUPA Subtest-1	20.09	20.14	20.14
HSUPA Subtest-2	20.16	20.28	20.18
HSUPA Subtest-3	20.26	20.11	20.10
HSUPA Subtest-4	20.23	20.09	20.24

*ERP = Conducted + antenna gain (0.57dBi)-2.15

LTE Band 5						
BW	MCS Index	RB Size	RB Offset	Low	Mid	High
		Channel		20407	20525	20643
		Frequency (MHz)		824.7	836.5	848.3
1.4M	QPSK	1	0	20.91	20.97	21.03
		1	2	20.87	21.02	20.87
		1	5	21.01	20.86	21.04
		3	0	19.86	19.71	19.94
		3	1	19.75	19.81	20.03
		3	3	20.04	19.71	19.90
		6	0	19.87	19.95	19.79
	16QAM	1	0	19.90	20.09	19.94
		1	2	19.92	19.95	19.84
		1	5	19.84	19.98	19.95
		3	0	18.78	18.83	18.97
		3	1	18.78	18.88	18.95
		3	3	18.95	18.67	18.89
		6	0	18.93	18.94	18.84
BW	MCS Index	RB Size	RB Offset	Low	Mid	High
		Channel		20415	20525	20635
		Frequency (MHz)		825.5	836.5	847.5
3M	QPSK	1	0	20.91	21.04	20.97
		1	7	20.89	21.10	20.92
		1	14	20.84	20.82	21.04
		8	0	19.75	19.78	19.86
		8	3	19.82	19.70	19.98
		8	7	19.98	19.66	19.91
		15	0	19.91	20.06	19.65
	16QAM	1	0	19.76	20.06	20.01
		1	7	19.73	20.05	19.81
		1	14	19.95	19.90	19.85
		8	0	18.75	18.69	18.82
		8	3	18.79	18.76	19.01
		8	7	19.00	18.72	18.77
		15	0	18.88	19.03	18.66

*ERP = Conducted + antenna gain (0.57dBi)-2.15

LTE Band 5						
BW	MCS Index	RB Size	RB Offset	Low	Mid	High
		Channel		20425	20525	20625
		Frequency (MHz)		826.5	836.5	846.5
5M	QPSK	1	0	20.99	20.90	20.91
		1	12	20.73	20.65	21.04
		1	24	21.04	21.02	20.85
		12	0	19.77	19.85	20.00
		12	6	19.91	20.03	19.68
		12	13	19.94	20.12	19.86
		25	0	19.82	19.73	19.79
	16QAM	1	0	19.85	20.02	19.97
		1	12	19.80	19.75	20.11
		1	24	19.90	19.98	19.85
		12	0	18.88	18.96	18.99
		12	6	18.84	19.03	18.82
		12	13	18.95	18.96	18.85
		25	0	18.71	18.83	18.81
BW	MCS Index	RB Size	RB Offset	Low	Mid	High
		Channel		20450	20525	20600
		Frequency (MHz)		829	836.5	844
10M	QPSK	1	0	20.98	20.70	20.78
		1	24	20.69	21.12	20.95
		1	49	20.84	20.98	20.99
		25	0	20.03	19.73	19.78
		25	12	20.00	19.70	19.95
		25	25	19.79	19.79	19.75
		50	0	19.87	19.74	19.82
	16QAM	1	0	19.96	19.84	19.76
		1	24	19.80	20.05	19.97
		1	49	19.92	19.90	19.90
		25	0	18.97	18.82	18.87
		25	12	19.05	18.75	19.10
		25	25	18.87	18.83	18.71
		50	0	18.78	18.84	18.88

*ERP = Conducted + antenna gain (0.57dBi)-2.15

4.2 Modulation Characteristics Measurement

4.2.1 Limits of Modulation Characteristics

N/A

4.2.2 Test Setup

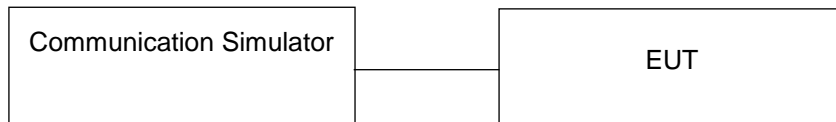

4.2.3 Test Procedure

Connect the EUT to Communication Simulator via the antenna connector. The frequency band is set as EUT supported Modulation and Channels, the EUT output is matched with 50 ohm load, the waveform quality and constellation of the EUT was tested.

4.2.4 Test Results

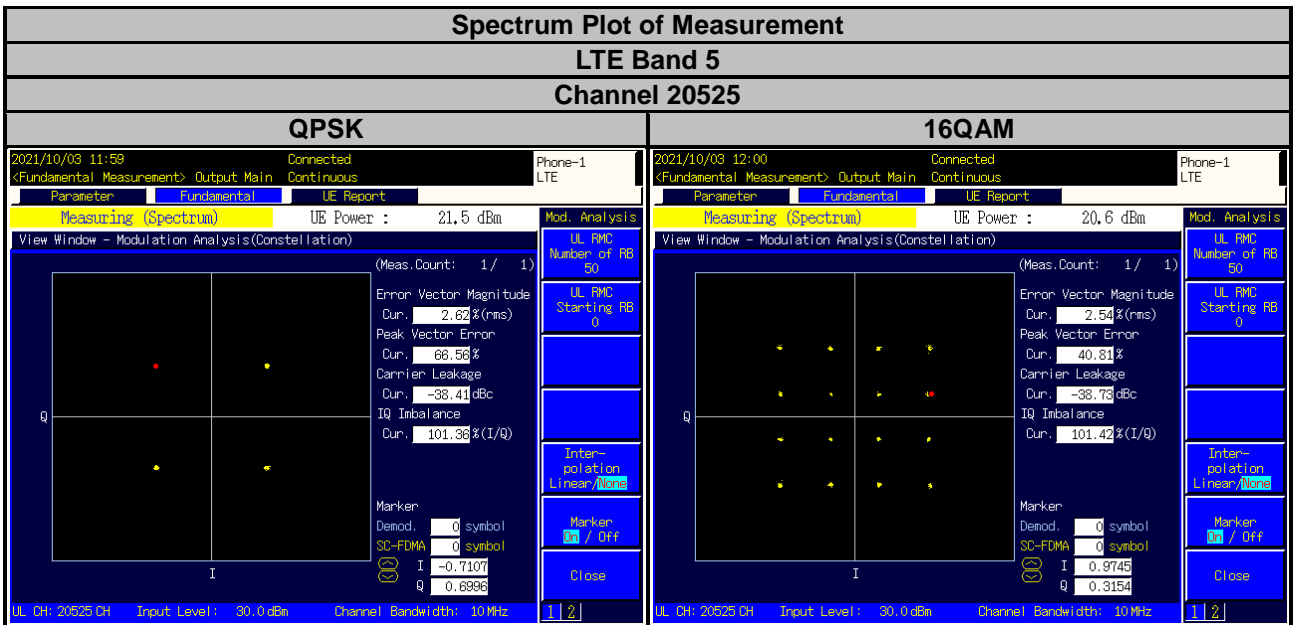
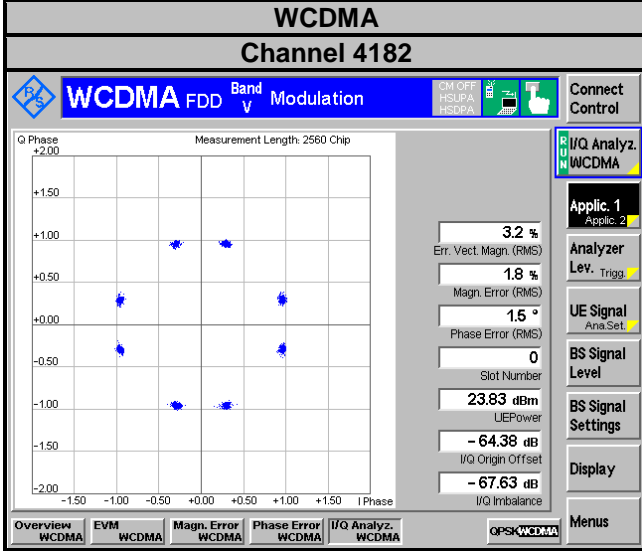
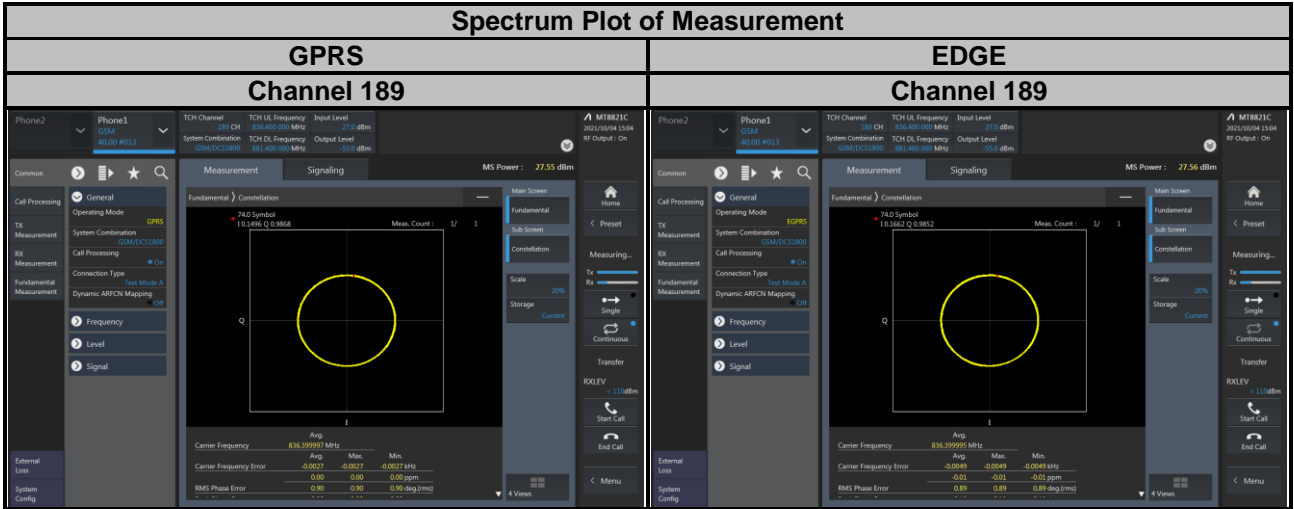

4.3 Frequency Stability Measurement

4.3.1 Limits of Frequency Stability Measurement

1.5 ppm is for base and fixed station. 2.5 ppm is for mobile station.

4.3.2 Test Procedure

- Device is placed at the oven room. The oven room could control the temperatures and humidity. Power warm up is at least 15 min and power applied should perform before recording frequency error.
- EUT is connected the external power supply to control the DC input power. The test voltage range is from minimum to maximum working voltage. Each step shall be record the frequency error rate.
- The temperature range step is 10 degrees in this test items. All temperature levels shall be hold the ± 0.5 °C during the measurement testing. The each temperature step shall be at least 0.5 hours, consider the EUT could be test under the stability condition.

NOTE: The frequency error was recorded frequency error from the communication simulator.

4.3.3 Test Setup

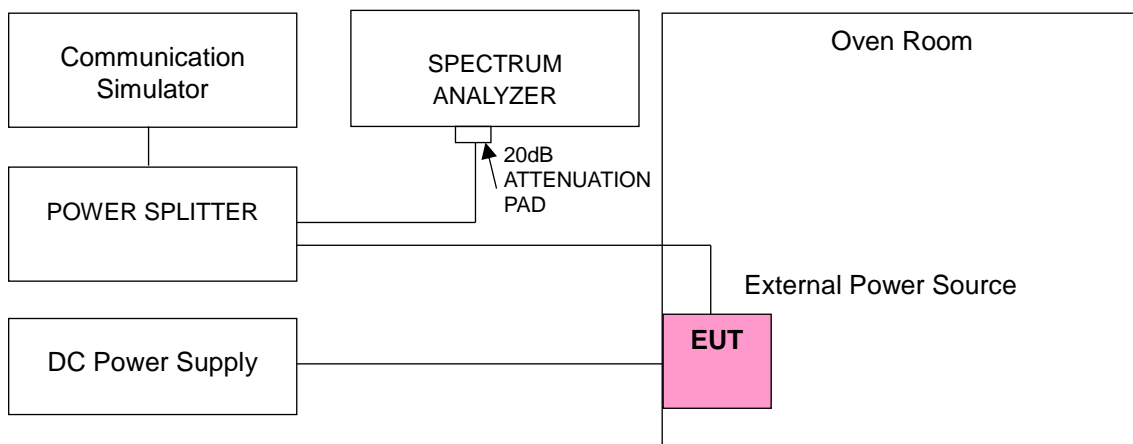

4.3.4 Test Results

Frequency Error vs. Voltage

Voltage (Volts)	GPRS				Limit (ppm)
	Low Channel		High Channel		
	Frequency (MHz)	Frequency Error (ppm)	Frequency (MHz)	Frequency Error (ppm)	
7.2	824.200001	0.001	848.800002	0.003	2.5
6.12	824.200003	0.004	848.800003	0.003	2.5
8.28	824.200002	0.003	848.800002	0.003	2.5

Note: The applicant defined the normal working voltage of the battery is from 6.12 Vdc to 8.28 Vdc.

Frequency Error vs. Temperature

Temp. (°C)	GPRS				Limit (ppm)
	Low Channel		High Channel		
	Frequency (MHz)	Frequency Error (ppm)	Frequency (MHz)	Frequency Error (ppm)	
-40	824.200001	0.001	848.800003	0.003	2.5
-30	824.200002	0.002	848.800003	0.004	2.5
-20	824.200004	0.005	848.800003	0.004	2.5
-10	824.200002	0.002	848.800001	0.002	2.5
0	824.200003	0.003	848.800003	0.004	2.5
10	824.200002	0.002	848.800002	0.003	2.5
20	824.200002	0.002	848.800002	0.003	2.5
30	824.199999	-0.002	848.799999	-0.002	2.5
40	824.199998	-0.002	848.799999	-0.002	2.5
50	824.199999	-0.002	848.799997	-0.003	2.5
60	824.199998	-0.002	848.799998	-0.003	2.5
70	824.199999	-0.001	848.799999	-0.002	2.5
85	824.199997	-0.004	848.799999	-0.002	2.5

Frequency Error vs. Voltage

Voltage (Volts)	EDGE				Limit (ppm)
	Low Channel		High Channel		
	Frequency (MHz)	Frequency Error (ppm)	Frequency (MHz)	Frequency Error (ppm)	
7.2	824.200001	0.001	848.800001	0.002	2.5
6.12	824.200001	0.001	848.800002	0.002	2.5
8.28	824.200001	0.001	848.800001	0.001	2.5

Note: The applicant defined the normal working voltage of the battery is from 6.12 Vdc to 8.28 Vdc.

Frequency Error vs. Temperature

Temp. (°C)	EDGE				Limit (ppm)
	Low Channel		High Channel		
	Frequency (MHz)	Frequency Error (ppm)	Frequency (MHz)	Frequency Error (ppm)	
-40	824.200001	0.001	848.800002	0.003	2.5
-30	824.200003	0.004	848.800004	0.004	2.5
-20	824.200002	0.002	848.800002	0.003	2.5
-10	824.200004	0.004	848.800004	0.004	2.5
0	824.200001	0.001	848.800002	0.002	2.5
10	824.200002	0.002	848.800002	0.002	2.5
20	824.200001	0.001	848.800002	0.003	2.5
30	824.199998	-0.002	848.799999	-0.002	2.5
40	824.199999	-0.001	848.799996	-0.004	2.5
50	824.199997	-0.004	848.799996	-0.005	2.5
60	824.199998	-0.003	848.799999	-0.001	2.5
70	824.199999	-0.001	848.799997	-0.004	2.5
85	824.199996	-0.004	848.799997	-0.004	2.5

Frequency Error vs. Voltage

Voltage (Volts)	WCDMA				Limit (ppm)
	Low Channel		High Channel		
	Frequency (MHz)	Frequency Error (ppm)	Frequency (MHz)	Frequency Error (ppm)	
7.2	826.400002	0.002	846.600004	0.004	2.5
6.12	826.400003	0.003	846.600001	0.001	2.5
8.28	826.400003	0.004	846.600001	0.002	2.5

Note: The applicant defined the normal working voltage of the battery is from 6.12 Vdc to 8.28 Vdc.

Frequency Error vs. Temperature

Temp. (°C)	WCDMA				Limit (ppm)
	Low Channel		High Channel		
	Frequency (MHz)	Frequency Error (ppm)	Frequency (MHz)	Frequency Error (ppm)	
-40	826.400003	0.004	846.600001	0.002	2.5
-30	826.400002	0.003	846.600002	0.002	2.5
-20	826.400002	0.003	846.600003	0.003	2.5
-10	826.400003	0.004	846.600004	0.005	2.5
0	826.400002	0.003	846.600001	0.002	2.5
10	826.400001	0.002	846.600003	0.004	2.5
20	826.400002	0.002	846.600003	0.004	2.5
30	826.399997	-0.004	846.599997	-0.004	2.5
40	826.399997	-0.003	846.599996	-0.005	2.5
50	826.399997	-0.004	846.599996	-0.004	2.5
60	826.399996	-0.005	846.599997	-0.004	2.5
70	826.399996	-0.004	846.599998	-0.002	2.5
85	826.399996	-0.005	846.599998	-0.002	2.5

Frequency Error vs. Voltage

Voltage (Volts)	LTE Band 5				Limit (ppm)
	Channel Bandwidth: 1.4 MHz				
	Low Channel		High Channel		
	Frequency (MHz)	Frequency Error (ppm)	Frequency (MHz)	Frequency Error (ppm)	
7.2	824.700003	0.003	848.300002	0.002	2.5
6.12	824.700002	0.002	848.300001	0.001	2.5
8.28	824.700004	0.005	848.300003	0.004	2.5

Note: The applicant defined the normal working voltage of the battery is from 6.12 Vdc to 8.28 Vdc.

Frequency Error vs. Temperature

Temp. (°C)	LTE Band 5				Limit (ppm)
	Channel Bandwidth: 1.4 MHz				
	Low Channel		High Channel		
	Frequency (MHz)	Frequency Error (ppm)	Frequency (MHz)	Frequency Error (ppm)	
-40	824.700004	0.005	848.300002	0.003	2.5
-30	824.700004	0.005	848.300004	0.004	2.5
-20	824.700003	0.004	848.300001	0.001	2.5
-10	824.700004	0.004	848.300002	0.002	2.5
0	824.700002	0.003	848.300004	0.005	2.5
10	824.700003	0.003	848.300004	0.004	2.5
20	824.700002	0.002	848.300002	0.003	2.5
30	824.699999	-0.001	848.300003	0.004	2.5
40	824.699997	-0.004	848.299997	-0.004	2.5
50	824.699999	-0.002	848.299997	-0.003	2.5
60	824.699998	-0.002	848.299998	-0.002	2.5
70	824.699998	-0.003	848.299996	-0.005	2.5
85	824.699997	-0.004	848.299996	-0.004	2.5

Frequency Error vs. Voltage

Voltage (Volts)	LTE Band 5				Limit (ppm)
	Channel Bandwidth: 3 MHz				
	Low Channel		High Channel		
	Frequency (MHz)	Frequency Error (ppm)	Frequency (MHz)	Frequency Error (ppm)	
7.2	825.500003	0.004	847.500003	0.004	2.5
6.12	825.500001	0.001	847.500004	0.004	2.5
8.28	825.500003	0.004	847.500002	0.003	2.5

Note: The applicant defined the normal working voltage of the battery is from 6.12 Vdc to 8.28 Vdc.

Frequency Error vs. Temperature

Temp. (°C)	LTE Band 5				Limit (ppm)
	Channel Bandwidth: 3 MHz				
	Low Channel		High Channel		
	Frequency (MHz)	Frequency Error (ppm)	Frequency (MHz)	Frequency Error (ppm)	
-40	825.500003	0.004	847.500003	0.003	2.5
-30	825.500004	0.004	847.500003	0.004	2.5
-20	825.500001	0.001	847.500003	0.003	2.5
-10	825.500002	0.003	847.500003	0.003	2.5
0	825.500002	0.003	847.500003	0.003	2.5
10	825.500003	0.004	847.500004	0.004	2.5
20	825.499999	-0.002	847.500004	0.005	2.5
30	825.499999	-0.001	847.500002	0.002	2.5
40	825.499998	-0.002	847.499998	-0.002	2.5
50	825.499997	-0.004	847.499997	-0.003	2.5
60	825.499997	-0.003	847.499998	-0.002	2.5
70	825.499997	-0.004	847.499997	-0.004	2.5
85	825.499997	-0.003	847.499998	-0.002	2.5

Frequency Error vs. Voltage

Voltage (Volts)	LTE Band 5				Limit (ppm)
	Channel Bandwidth: 5 MHz				
	Low Channel		High Channel		
	Frequency (MHz)	Frequency Error (ppm)	Frequency (MHz)	Frequency Error (ppm)	
7.2	826.500001	0.001	846.500002	0.002	2.5
6.12	826.500002	0.002	846.500001	0.002	2.5
8.28	826.500003	0.004	846.500001	0.001	2.5

Note: The applicant defined the normal working voltage of the battery is from 6.12 Vdc to 8.28 Vdc.

Frequency Error vs. Temperature

Temp. (°C)	LTE Band 5				Limit (ppm)
	Channel Bandwidth: 5 MHz				
	Low Channel		High Channel		
	Frequency (MHz)	Frequency Error (ppm)	Frequency (MHz)	Frequency Error (ppm)	
-40	826.500003	0.004	846.500002	0.002	2.5
-30	826.500003	0.003	846.500003	0.004	2.5
-20	826.500002	0.003	846.500004	0.005	2.5
-10	826.500002	0.003	846.500003	0.004	2.5
0	826.500002	0.002	846.500003	0.003	2.5
10	826.500003	0.003	846.500003	0.003	2.5
20	826.500002	0.002	846.500001	0.002	2.5
30	826.499998	-0.003	846.500002	0.002	2.5
40	826.499999	-0.002	846.499998	-0.003	2.5
50	826.499998	-0.003	846.499999	-0.002	2.5
60	826.499998	-0.002	846.499996	-0.005	2.5
70	826.499999	-0.002	846.499996	-0.005	2.5
85	826.499999	-0.001	846.499997	-0.004	2.5

Frequency Error vs. Voltage

Voltage (Volts)	LTE Band 5				Limit (ppm)
	Channel Bandwidth: 10 MHz				
	Low Channel		High Channel		
	Frequency (MHz)	Frequency Error (ppm)	Frequency (MHz)	Frequency Error (ppm)	
7.2	829.000004	0.005	844.000004	0.004	2.5
6.12	829.000001	0.001	844.000003	0.004	2.5
8.28	829.000001	0.001	844.000002	0.002	2.5

Note: The applicant defined the normal working voltage of the battery is from 6.12 Vdc to 8.28 Vdc.

Frequency Error vs. Temperature

Temp. (°C)	LTE Band 5				Limit (ppm)
	Channel Bandwidth: 10 MHz				
	Low Channel		High Channel		
	Frequency (MHz)	Frequency Error (ppm)	Frequency (MHz)	Frequency Error (ppm)	
-40	829.000003	0.004	844.000002	0.002	2.5
-30	829.000003	0.003	844.000003	0.004	2.5
-20	829.000003	0.003	844.000001	0.002	2.5
-10	829.000002	0.003	844.000003	0.004	2.5
0	829.000004	0.005	844.000003	0.004	2.5
10	829.000002	0.002	844.000001	0.002	2.5
20	829.000004	0.005	844.000002	0.002	2.5
30	828.999996	-0.005	844.000001	0.001	2.5
40	828.999998	-0.003	843.999998	-0.002	2.5
50	828.999997	-0.004	843.999998	-0.002	2.5
60	828.999998	-0.002	843.999996	-0.005	2.5
70	828.999997	-0.004	843.999997	-0.004	2.5
85	828.999997	-0.004	843.999998	-0.002	2.5

4.4 Occupied Bandwidth Measurement

4.4.1 Test Procedure

The EUT makes a call to the communication simulator. All measurements were done at low, middle and high operational frequency range. The communication simulator station system controlled a EUT to export maximum output power under transmission mode and specific channel frequency. Refer to ANSI C63.26 section 5.4.4. Use OBW measurement function of Spectrum analyzer to measure 99 % occupied bandwidth. For the 26dBc bandwidth measurement method, please refer to section 5.4.3 of ANSI C63.26.

4.4.2 Test Setup

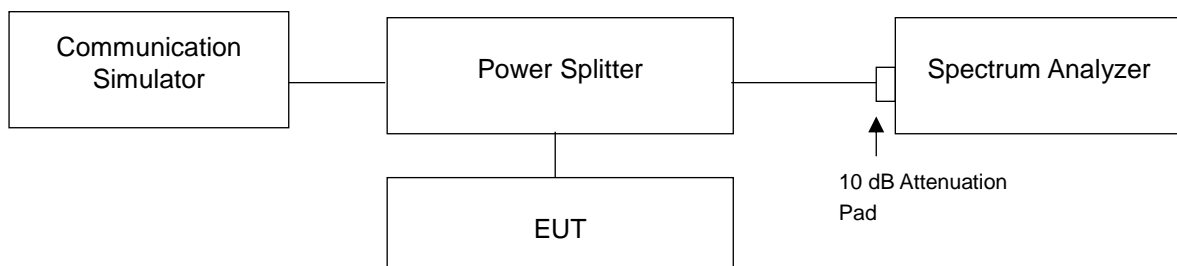

4.4.3 Test Result

GPRS				EDGE			
Channel	Frequency (MHz)	99 % Occupied Bandwidth (kHz)	26 dB Bandwidth (kHz)	Channel	Frequency (MHz)	99 % Occupied Bandwidth (kHz)	26 dB Bandwidth (kHz)
128	824.2	247.38	319.20	128	824.2	247.82	318.80
189	836.4	247.51	318.50	189	836.4	247.51	321.20
251	848.8	249.55	315.60	251	848.8	248.35	318.30

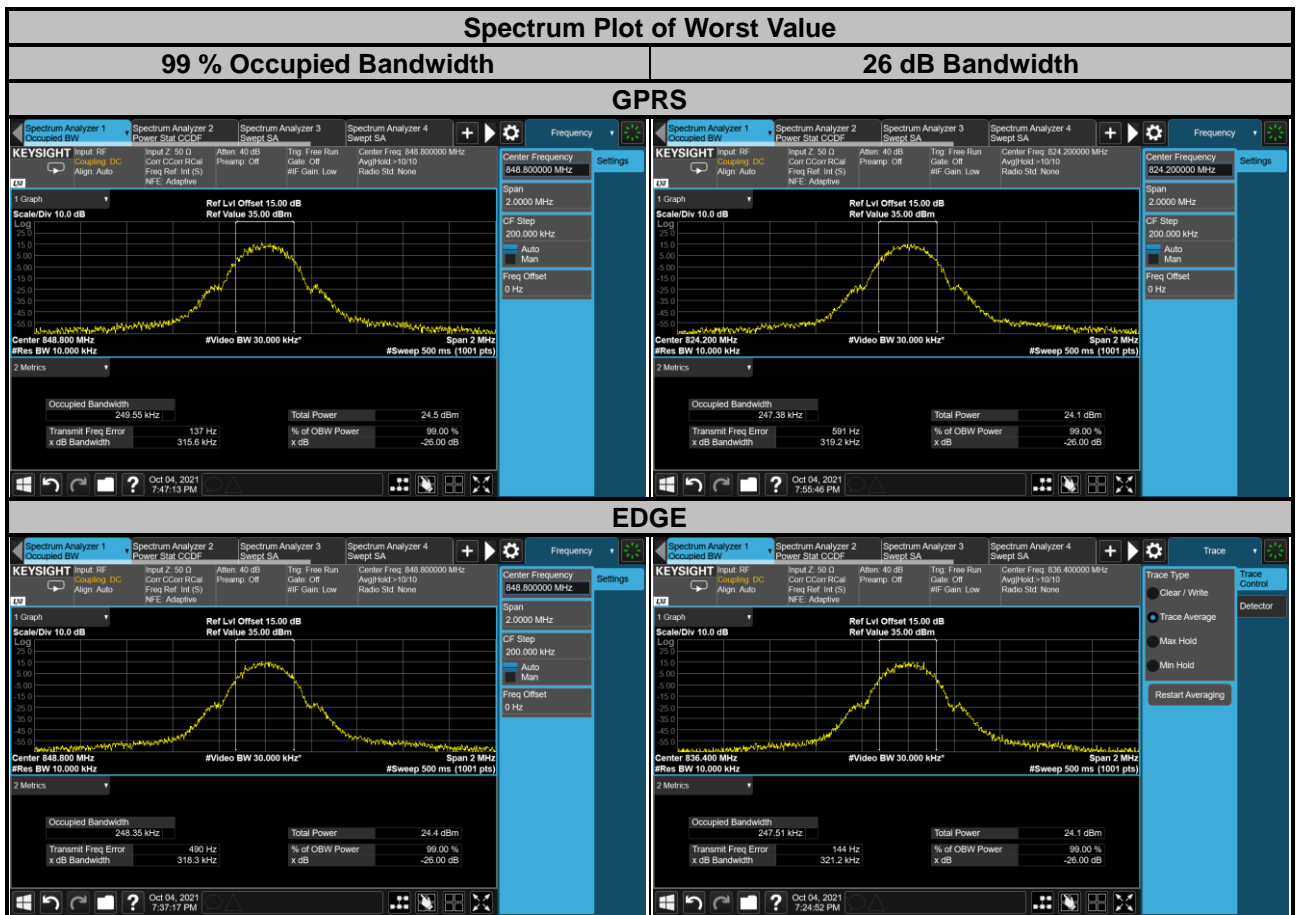

WCDMA			
Channel	Frequency (MHz)	99 % Occupied Bandwidth (kHz)	26 dB Bandwidth (kHz)
4132	826.4	4.15	4.73
4182	836.4	4.15	4.73
4233	846.6	4.16	4.74

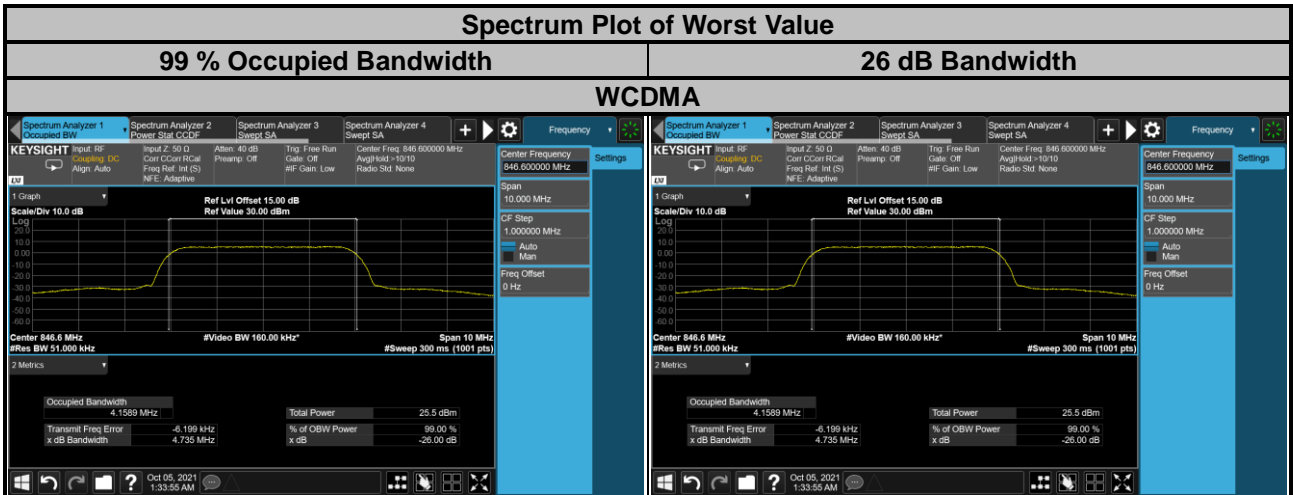

LTE Band 5					
Channel Bandwidth: 1.4 MHz					
Channel	Frequency (MHz)	99 % Occupied Bandwidth (MHz)		26 dB Bandwidth (MHz)	
		QPSK	16QAM	QPSK	16QAM
20407	824.7	1.09	1.09	1.21	1.22
20525	836.5	1.09	1.09	1.21	1.21
20643	848.3	1.09	1.09	1.21	1.21
Channel Bandwidth: 3 MHz					
Channel	Frequency (MHz)	99 % Occupied Bandwidth (MHz)		26 dB Bandwidth (MHz)	
		QPSK	16QAM	QPSK	16QAM
20415	825.5	2.70	2.70	2.93	2.92
20525	836.5	2.70	2.69	2.92	2.93
20635	847.5	2.70	2.70	2.91	2.92

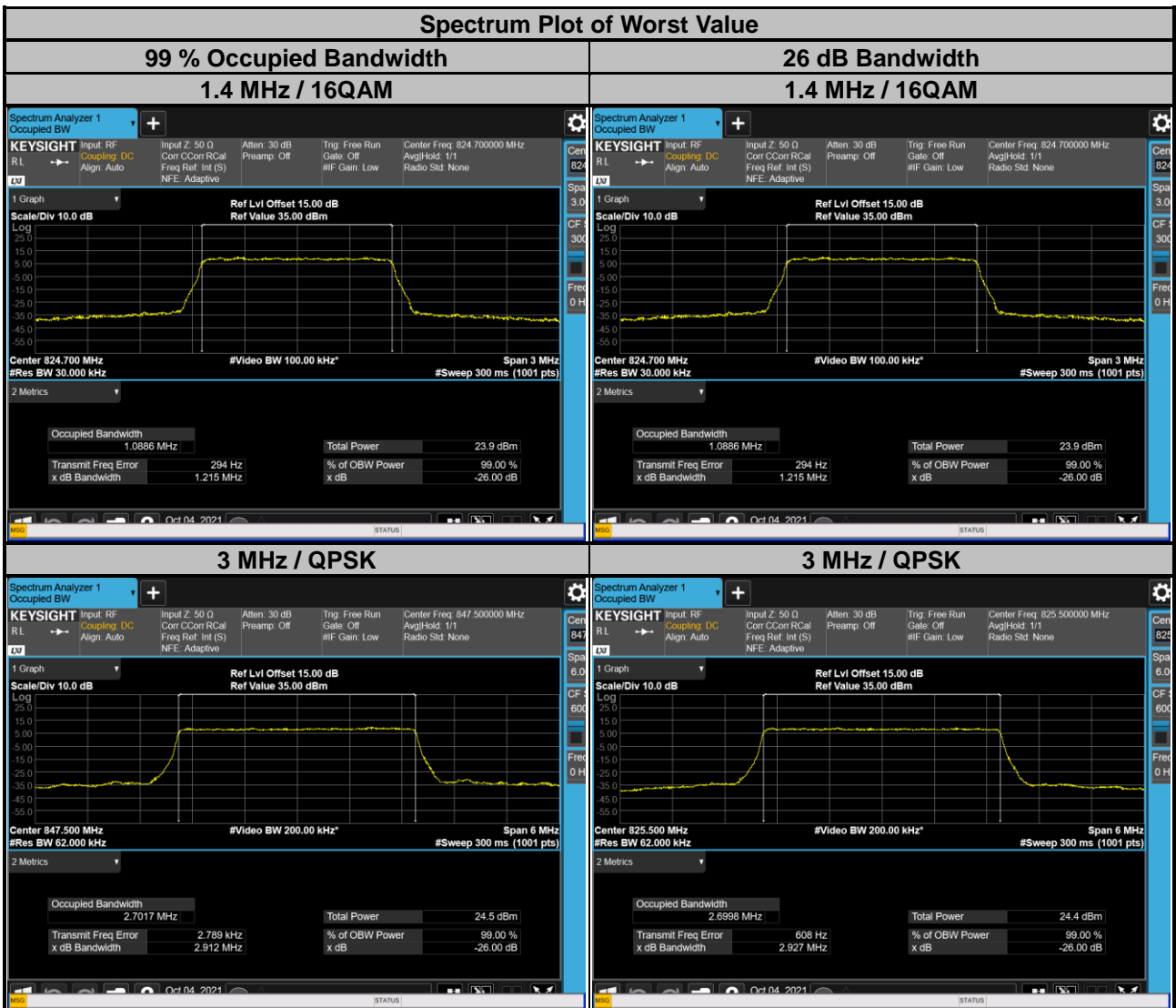

LTE Band 5					
Channel Bandwidth: 5 MHz					
Channel	Frequency (MHz)	99 % Occupied Bandwidth (MHz)		26 dB Bandwidth (MHz)	
		QPSK	16QAM	QPSK	16QAM
20425	826.5	4.49	4.49	4.79	4.80
20525	836.5	4.49	4.49	4.81	4.79
20625	846.5	4.49	4.49	4.81	4.81

Channel Bandwidth: 10 MHz					
Channel	Frequency (MHz)	99 % Occupied Bandwidth (MHz)		26 dB Bandwidth (MHz)	
		QPSK	16QAM	QPSK	16QAM
20450	829.0	8.97	8.98	9.50	9.51
20525	836.5	8.96	8.96	9.49	9.51
20600	844.0	8.97	8.97	9.49	9.50

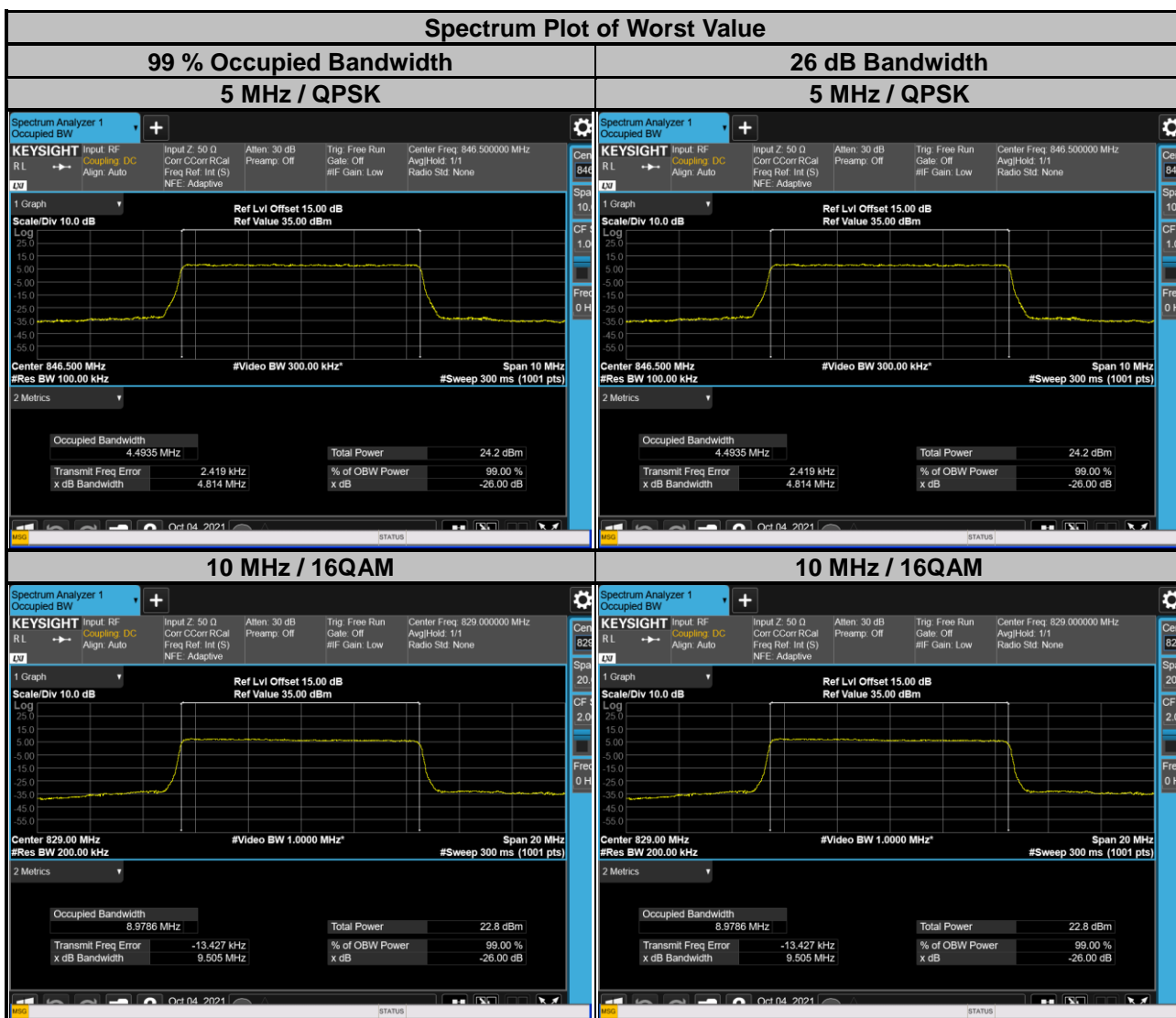

4.5 Band Edge Measurement

4.5.1 Limits of Band Edge Measurement

Power of any emission outside of the authorized operating frequency ranges must be attenuated below the transmitting power (P) by a factor of at least $43 + 10 \log(P)$ dB. In the 1 MHz bands immediately outside and adjacent to the frequency block a resolution bandwidth of at least one percent of the emission bandwidth of the fundamental emission of the transmitter may be employed.

4.5.2 Test Setup

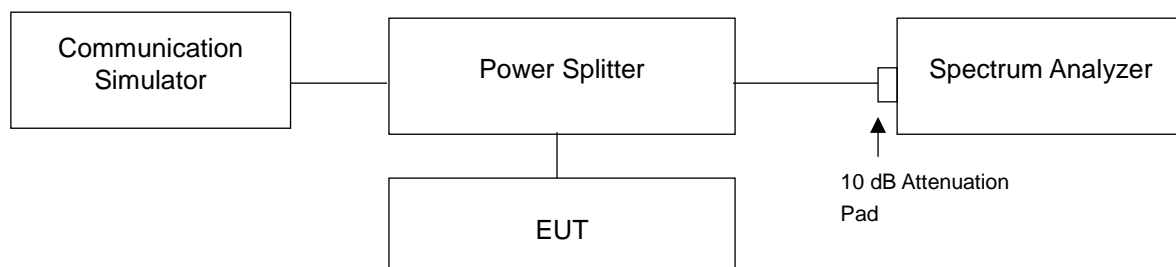

4.5.3 Test Procedures

- a. All measurements were done at low and high operational frequency range.
- b. The center frequency of spectrum is the band edge frequency and span is 2 MHz. RB of the spectrum is 10 kHz and VB of the spectrum is 30 kHz (GPRS/EDGE).
- c. The center frequency of spectrum is the band edge frequency and span is 2 MHz. RB of the spectrum is 51 kHz and VB of the spectrum is 160 kHz (WCDMA).
- d. The center frequency of spectrum is the band edge frequency and span is 1 MHz. RB of the spectrum is 15 kHz and VB of the spectrum is 51 kHz (LTE Bandwidth 1.4 MHz).
- e. The center frequency of spectrum is the band edge frequency and span is 1 MHz. RB of the spectrum is 30 kHz and VB of the spectrum is 100 kHz (LTE Bandwidth 3 MHz).
- f. The center frequency of spectrum is the band edge frequency and span is 1 MHz. RB of the spectrum is 51 kHz and VB of the spectrum is 160kHz (LTE Bandwidth 5 MHz).
- g. The center frequency of spectrum is the band edge frequency and span is 1 MHz. RB of the spectrum is 100 kHz and VB of the spectrum is 300 kHz (LTE Bandwidth 10 MHz).
- h. Record the max trace plot into the test report.

4.5.4 Test Results

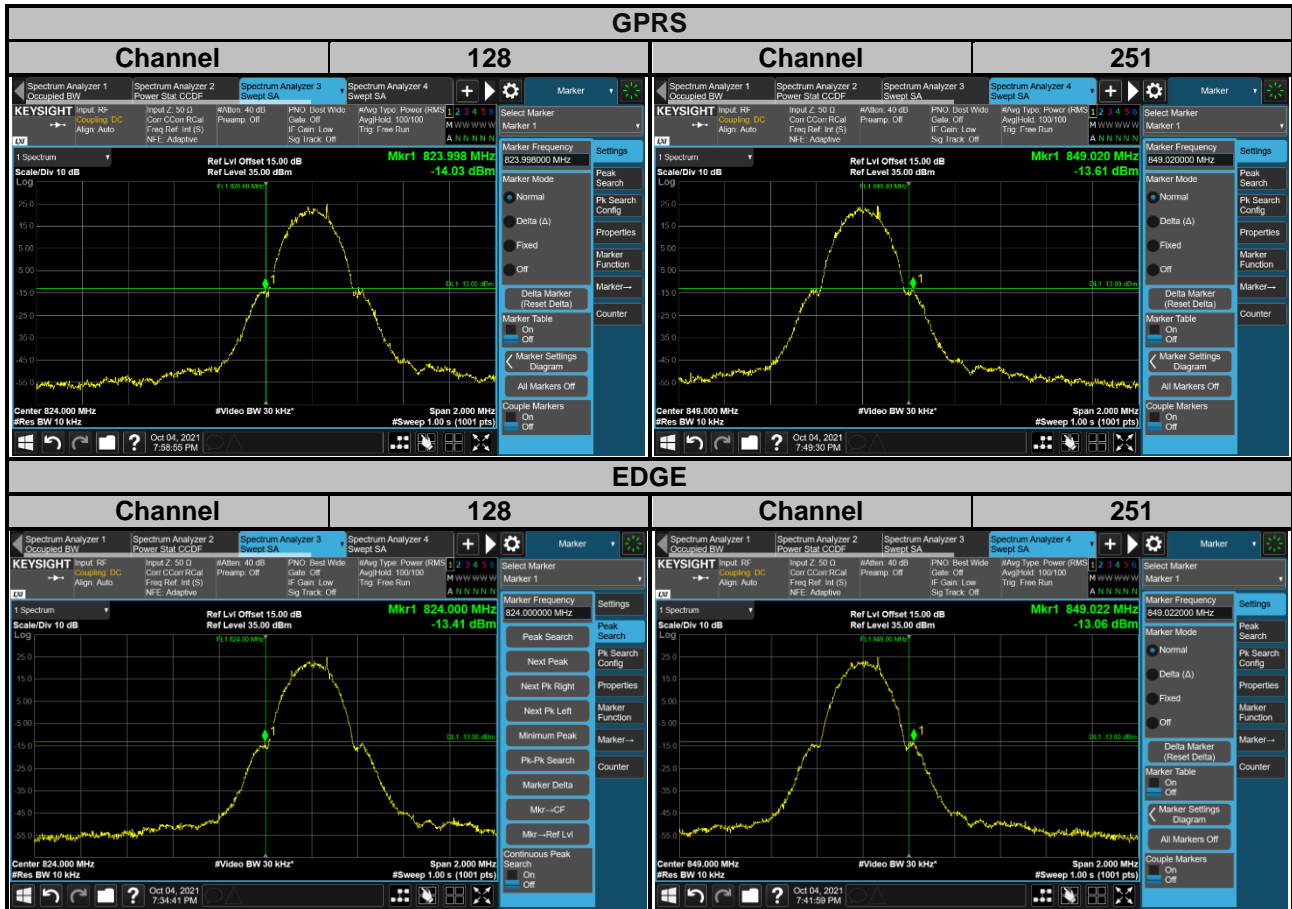

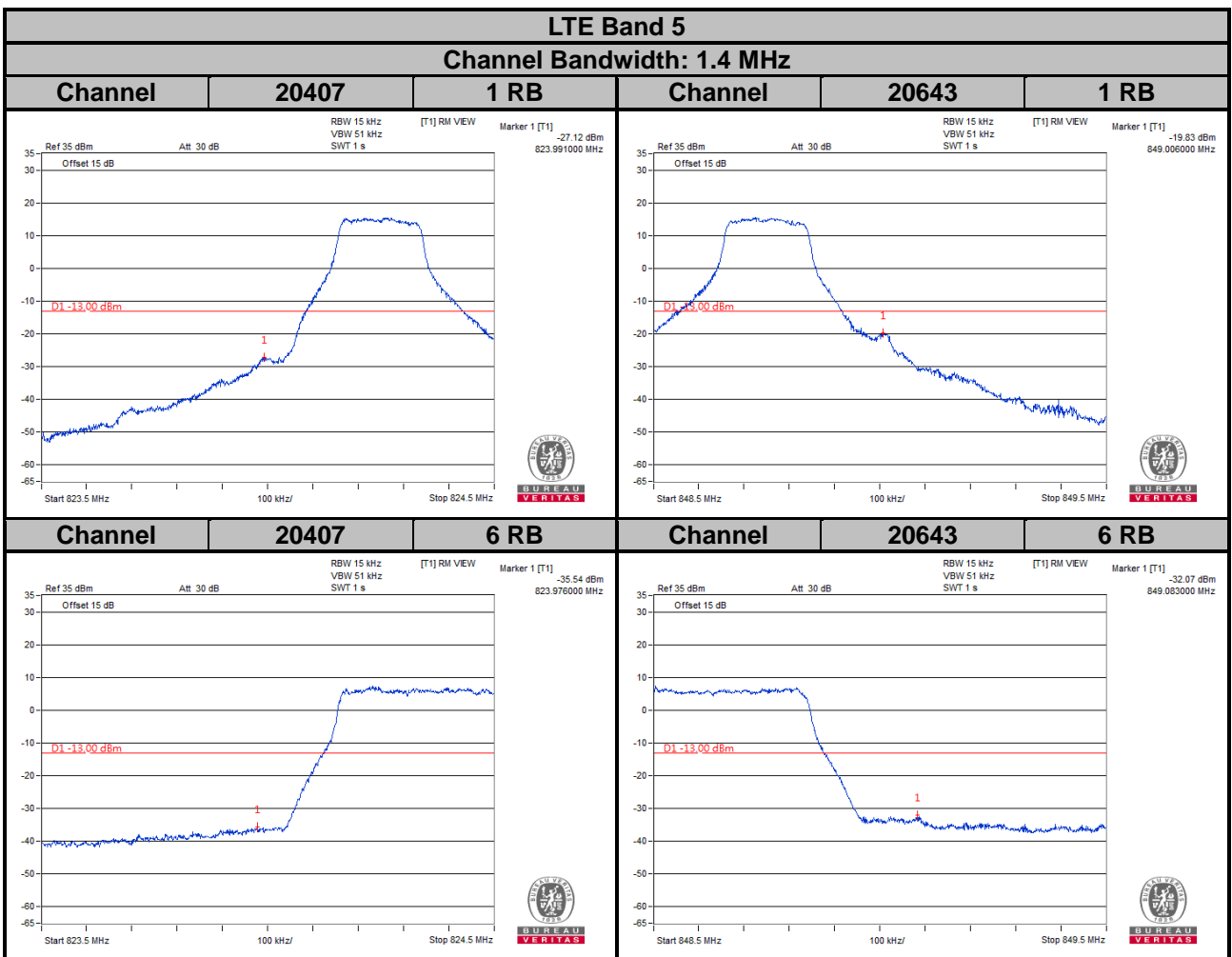
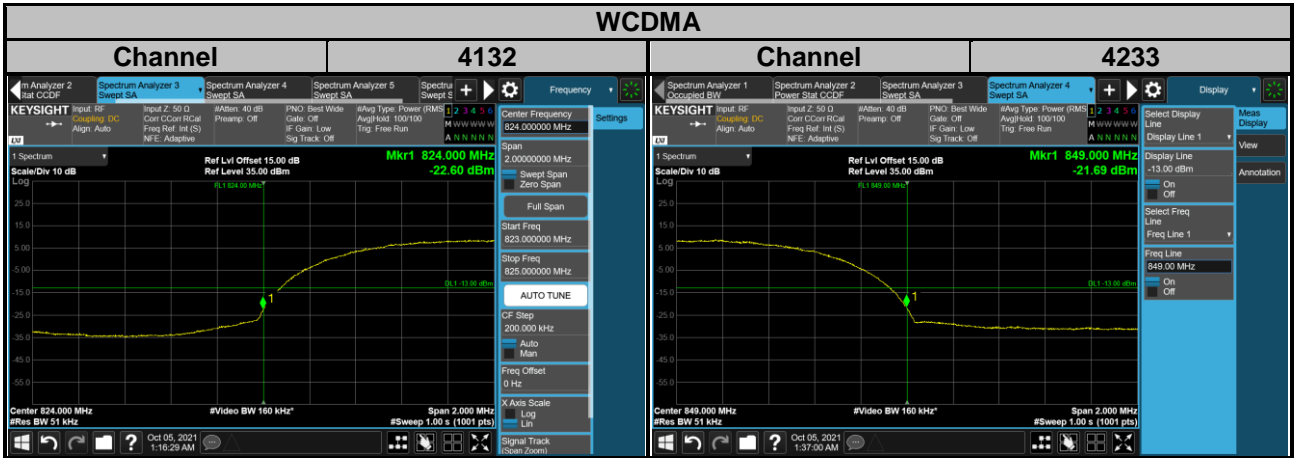

LTE Band 5
Channel Bandwidth: 3 MHz

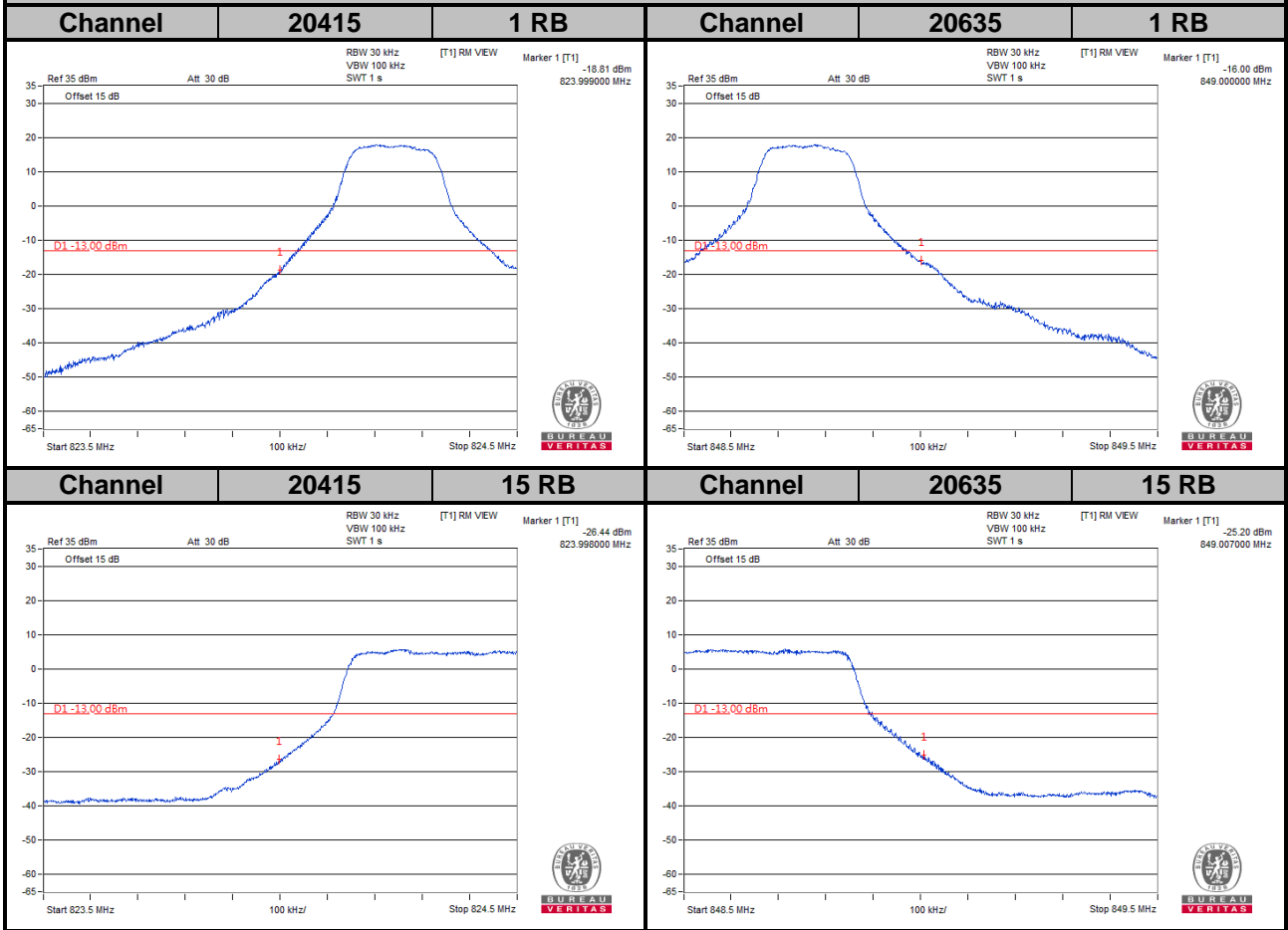

LTE Band 5
Channel Bandwidth: 5 MHz

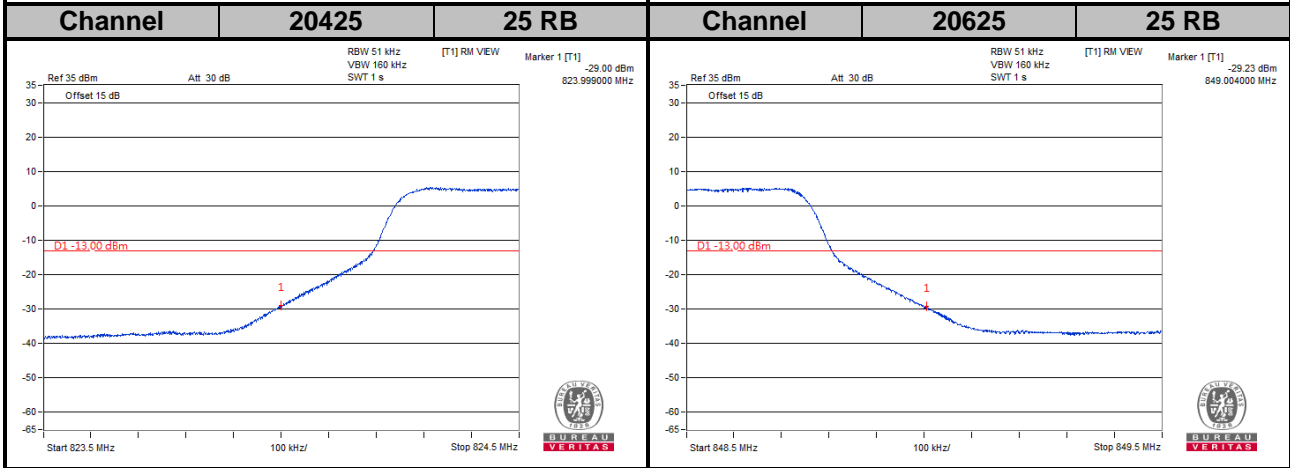
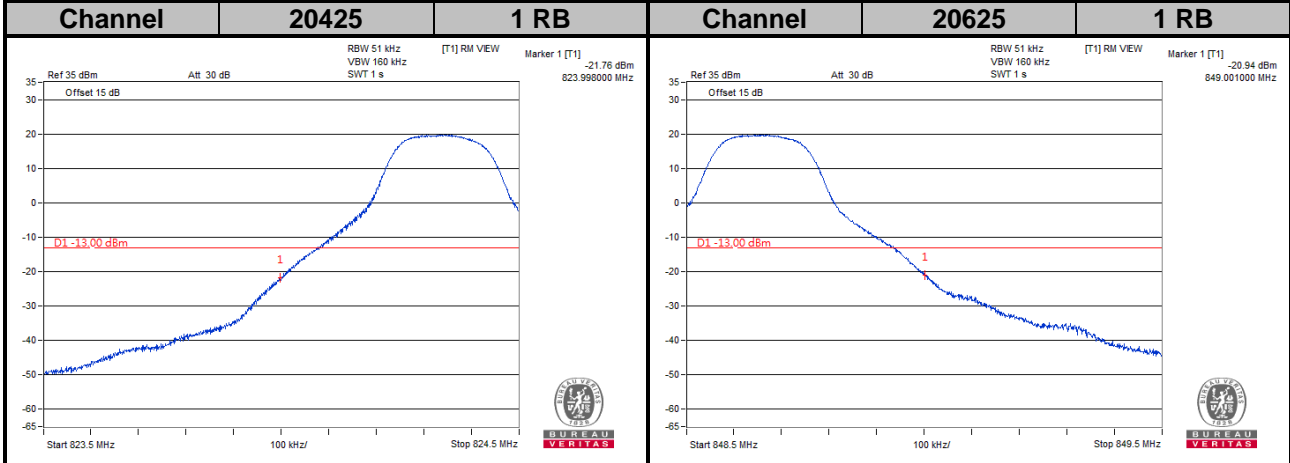

LTE Band 5
Channel Bandwidth: 10 MHz

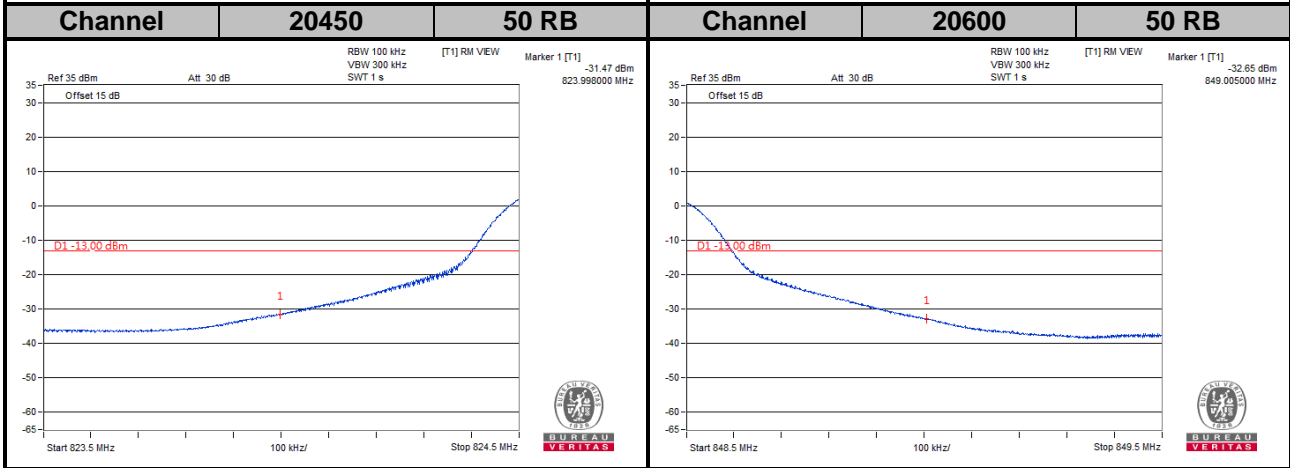
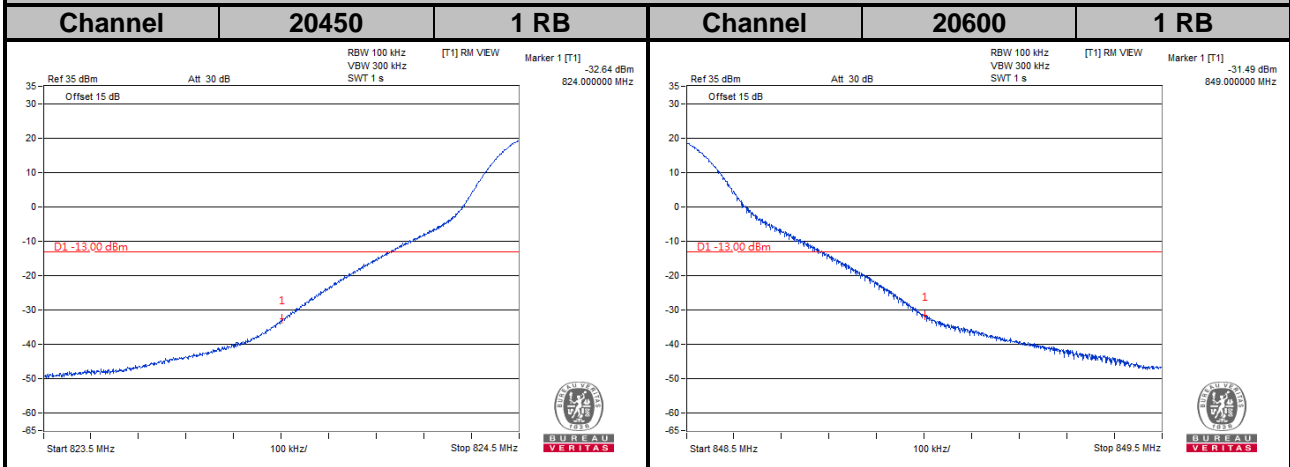

4.6 Peak to Average Ratio

4.6.1 Limits of Peak to Average Ratio Measurement

In measuring transmissions in this band using an average power technique, the peak to-average ratio (PAR) of the transmission may not exceed 13 dB.

4.6.2 Test Setup

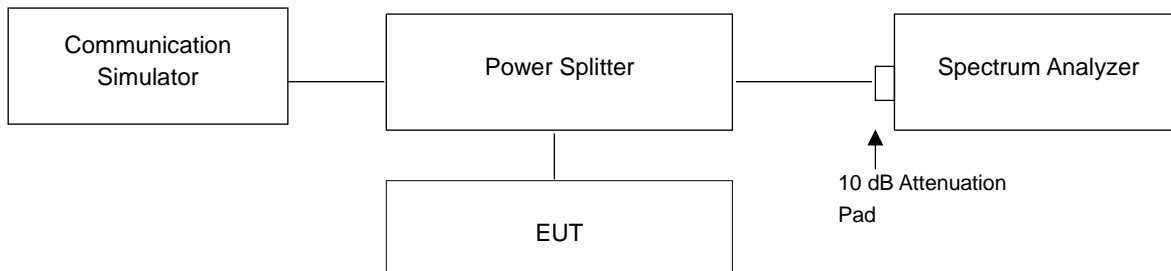

4.6.3 Test Procedures

1. Set resolution/measurement bandwidth \geq signal's occupied bandwidth;
2. Set the number of counts to a value that stabilizes the measured CCDF curve;
3. Record the maximum PAPR level associated with a probability of 0.1 %.

4.6.4 Test Results

Channel	Frequency (MHz)	Peak to Average Ratio (dB)		Channel	Frequency (MHz)	Peak to Average Ratio (dB)
		GPRS	EDGE			
128	824.2	2.78	2.77	4132	826.4	2.77
189	836.4	2.77	2.77	4182	836.4	2.73
251	848.8	2.77	2.77	4233	846.6	2.70

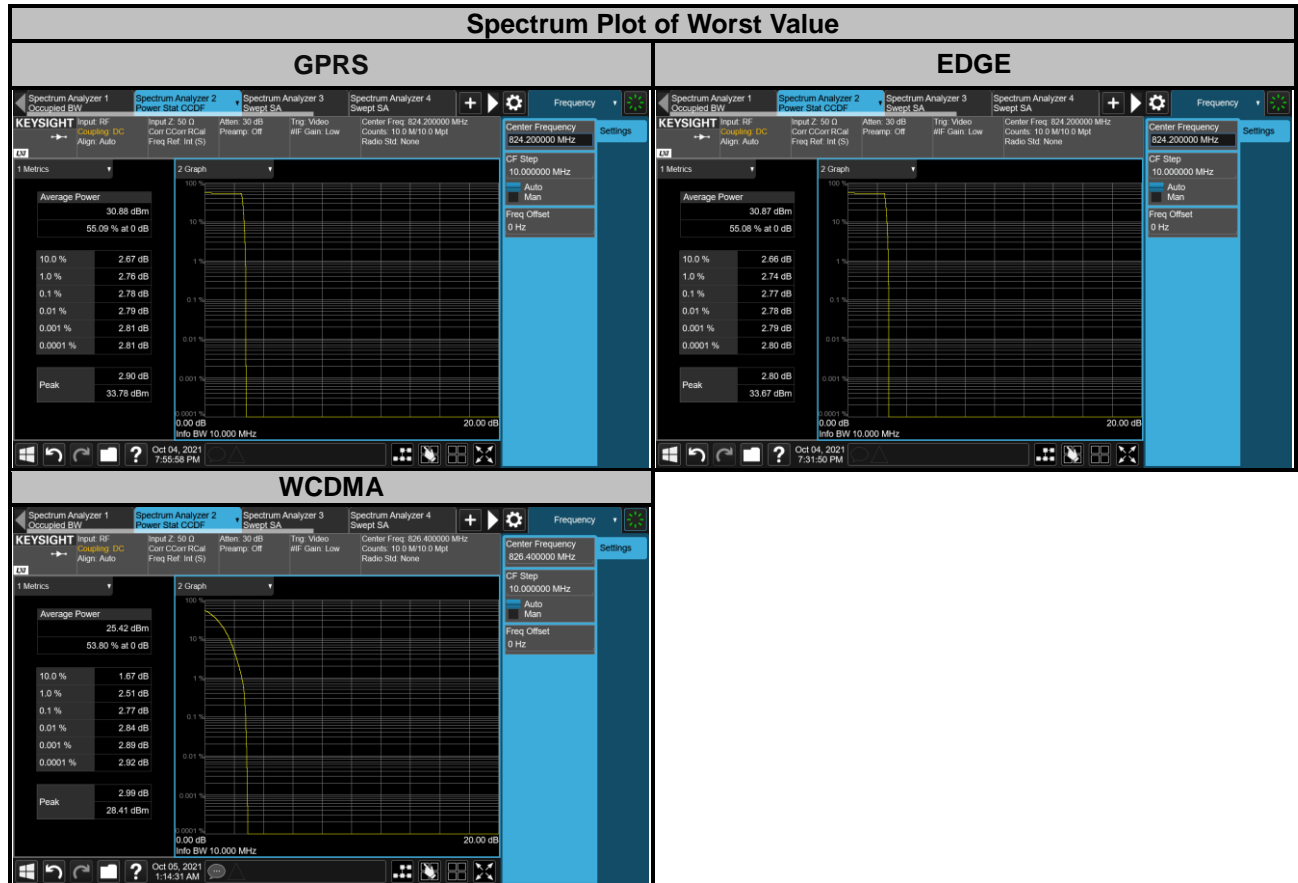

LTE Band 5							
Channel Bandwidth: 1.4 MHz				Channel Bandwidth: 3 MHz			
Channel	Frequency (MHz)	Peak to Average Ratio (dB)		Channel	Frequency (MHz)	Peak to Average Ratio (dB)	
		QPSK	16QAM			QPSK	16QAM
20407	824.7	4.33	5.09	20415	825.5	4.22	4.98
20525	836.5	4.62	5.43	20525	836.5	4.47	5.27
20643	848.3	4.17	4.96	20635	847.5	4.28	5.05

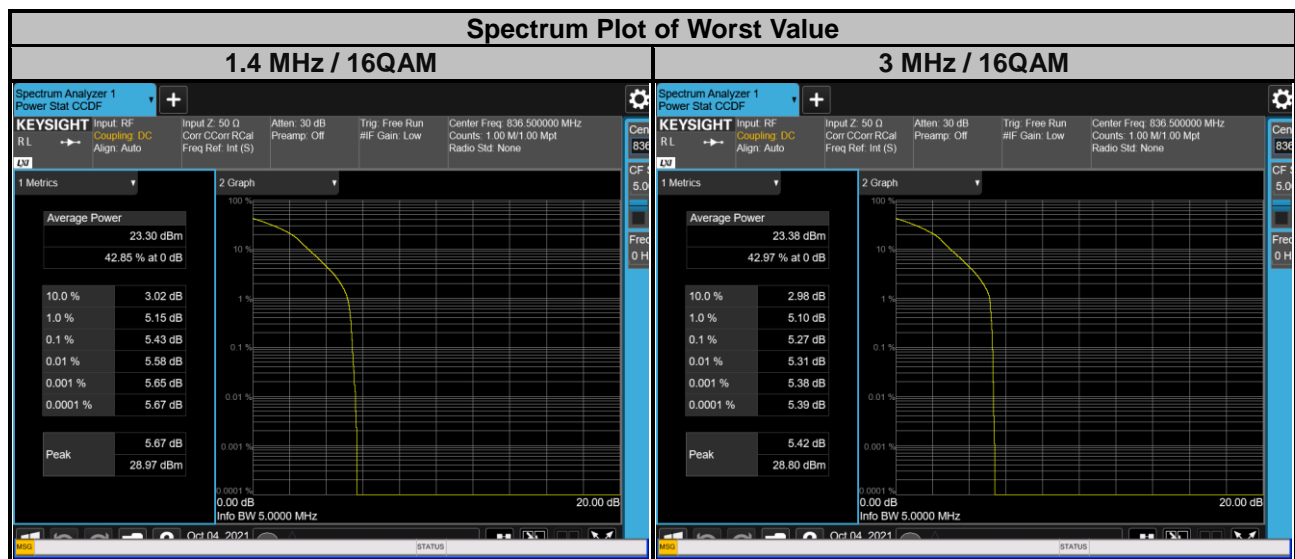

LTE Band 5							
Channel Bandwidth: 5 MHz				Channel Bandwidth: 10 MHz			
Channel	Frequency (MHz)	Peak to Average Ratio (dB)		Channel	Frequency (MHz)	Peak to Average Ratio (dB)	
		QPSK	16QAM			QPSK	16QAM
20425	826.5	4.19	4.94	20450	829.0	4.16	4.91
20525	836.5	4.45	5.22	20525	836.5	4.40	5.13
20625	846.5	4.09	4.86	20600	844.0	4.22	4.93

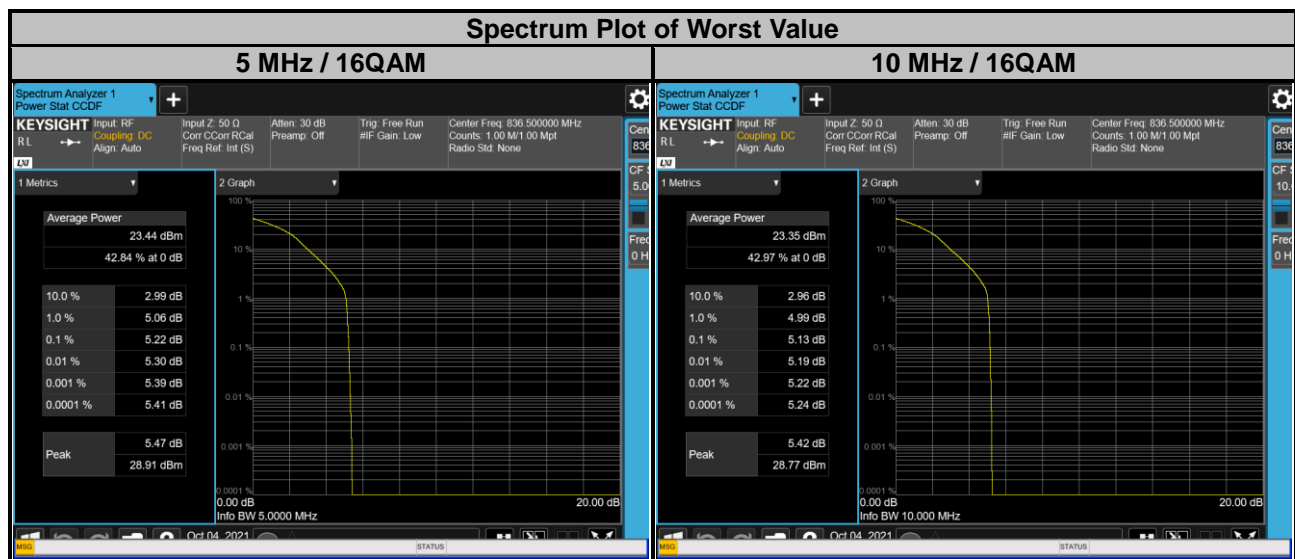

4.7 Conducted Spurious Emissions

4.7.1 Limits of Conducted Spurious Emissions Measurement

The power of any emission outside of the authorized operating frequency ranges must be attenuated below the transmitting power (P) by a factor of at least $43 + 10 \log(P)$ dB. The emission limit equal to -13 dBm.

4.7.2 Test Setup

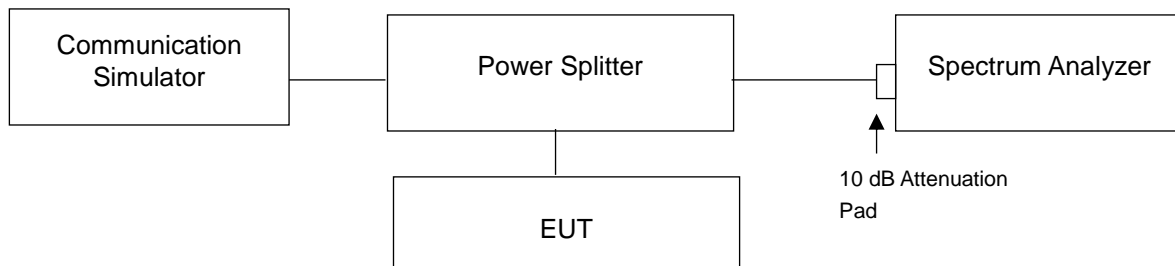

4.7.3 Test Procedure

- The EUT makes a phone call to the communication simulator. All measurements were done at low, middle and high operational frequency range.
- Measuring frequency range is from 9 kHz to 1 GHz. 10 dB attenuation pad is connected with spectrum. RBW = 100 kHz or 1 MHz and VBW = 300 kHz or 3 MHz is used for conducted emission measurement.
- Measuring frequency range is from 1 GHz to 9 GHz / 10 GHz. 10 dB attenuation pad is connected with spectrum. RBW = 1 MHz and VBW = 3 MHz is used for conducted emission measurement.

4.7.4 Test Results

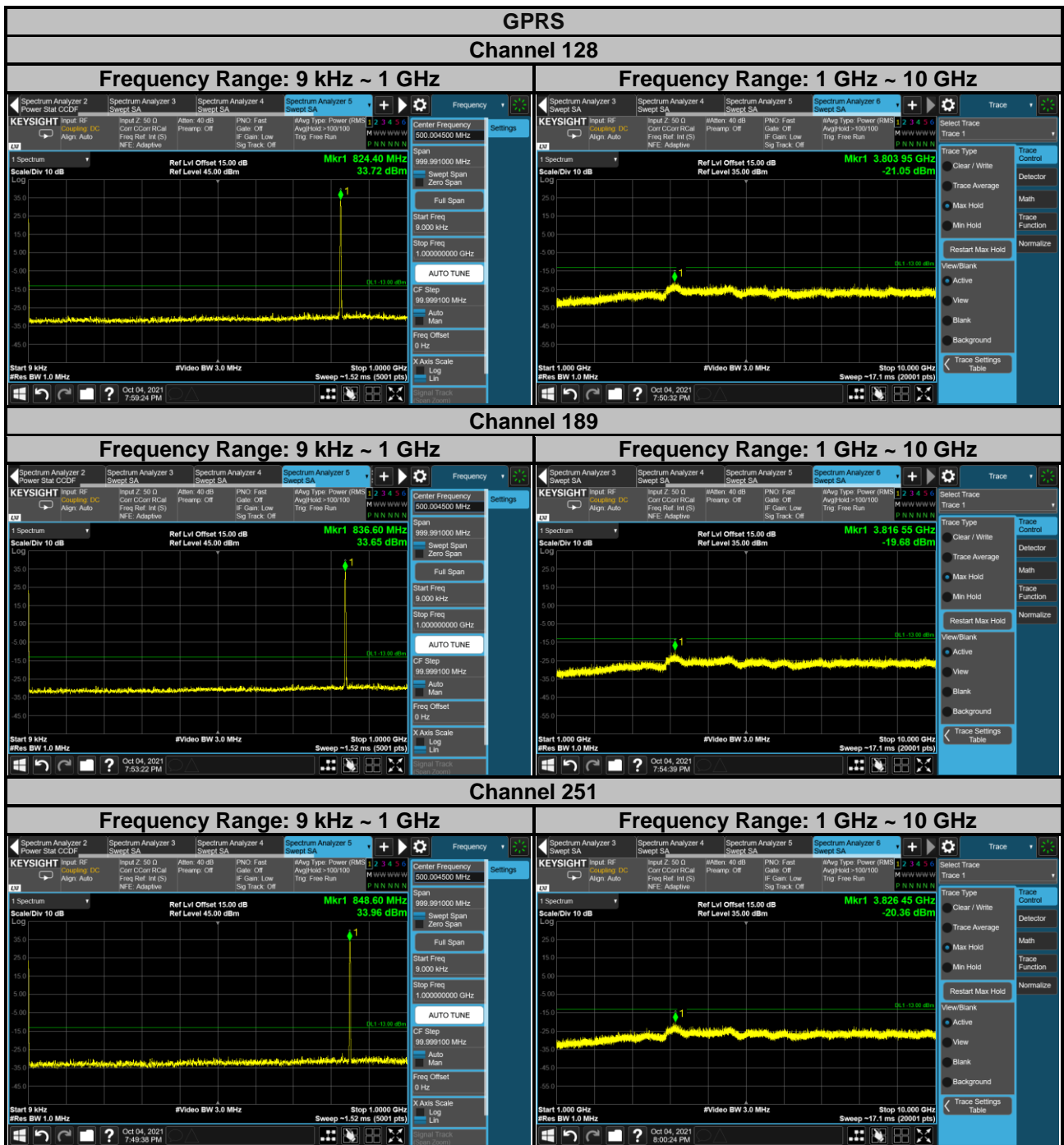

Note: The signal over the limit in 9 kHz is from spectrum analyzer.

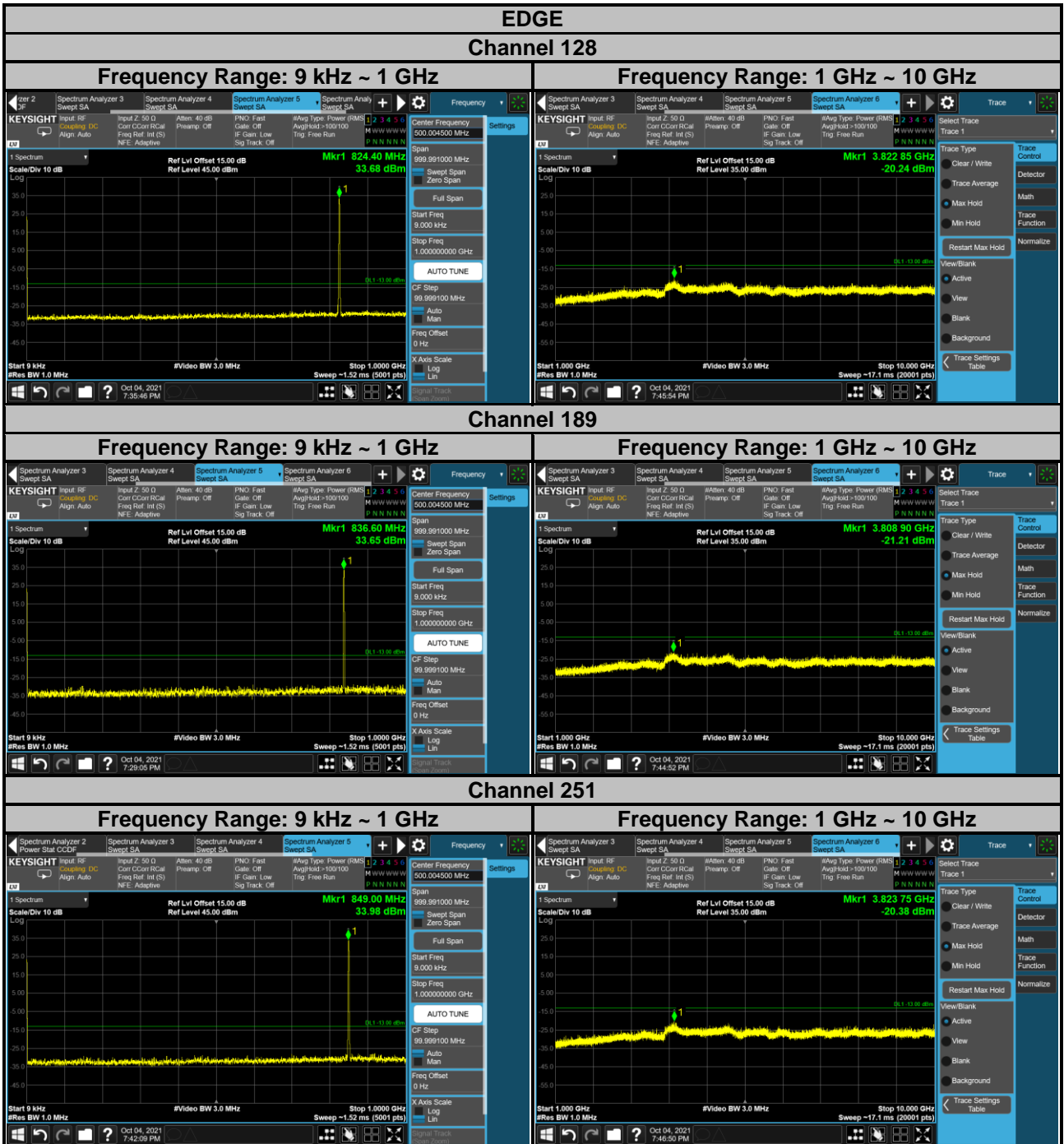

Note: The signal over the limit in 9 kHz is from spectrum analyzer.

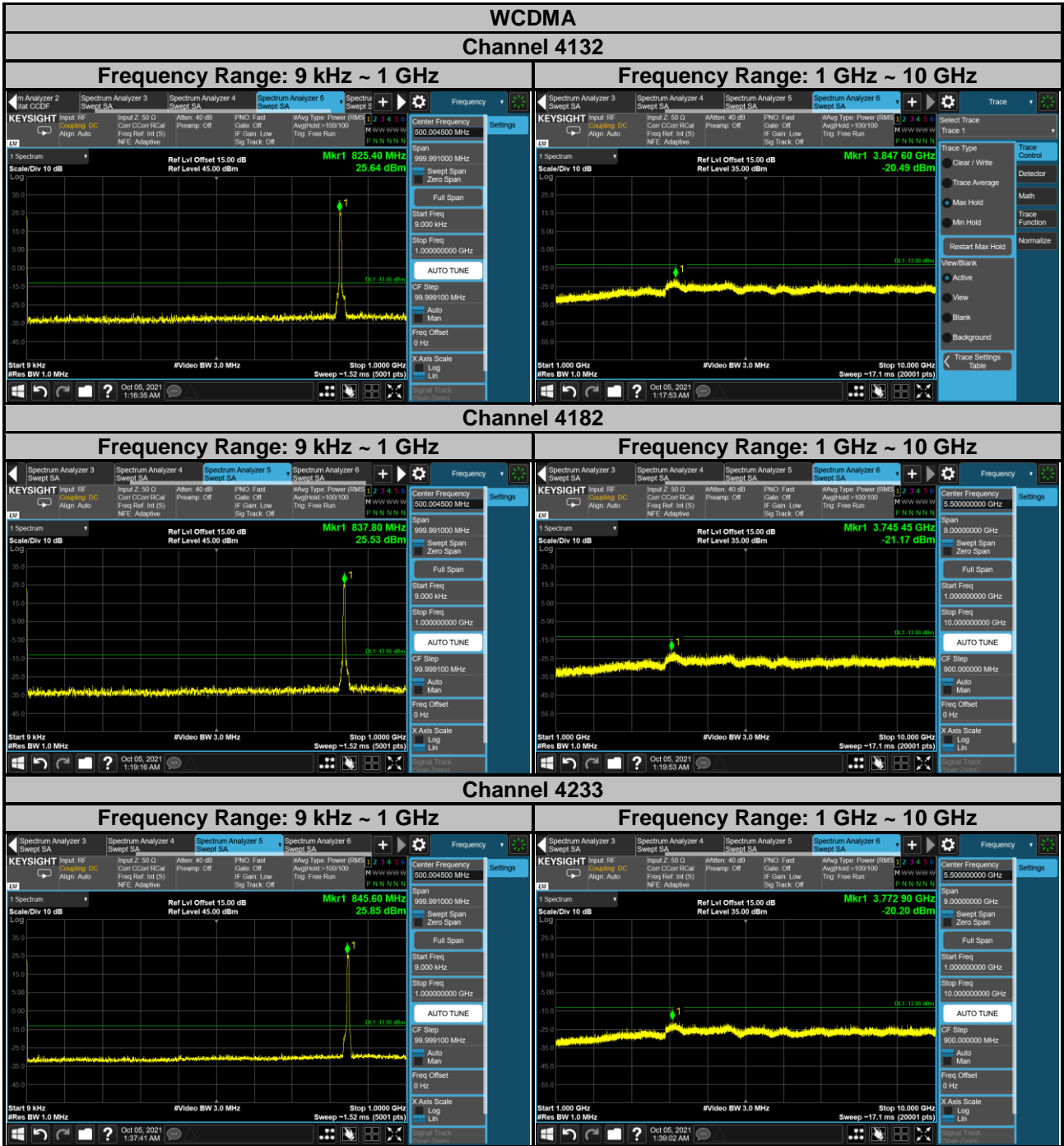

Note: The signal over the limit in 9 kHz is from spectrum analyzer.

LTE Band 5
Channel Bandwidth: 1.4 MHz
Channel 20407

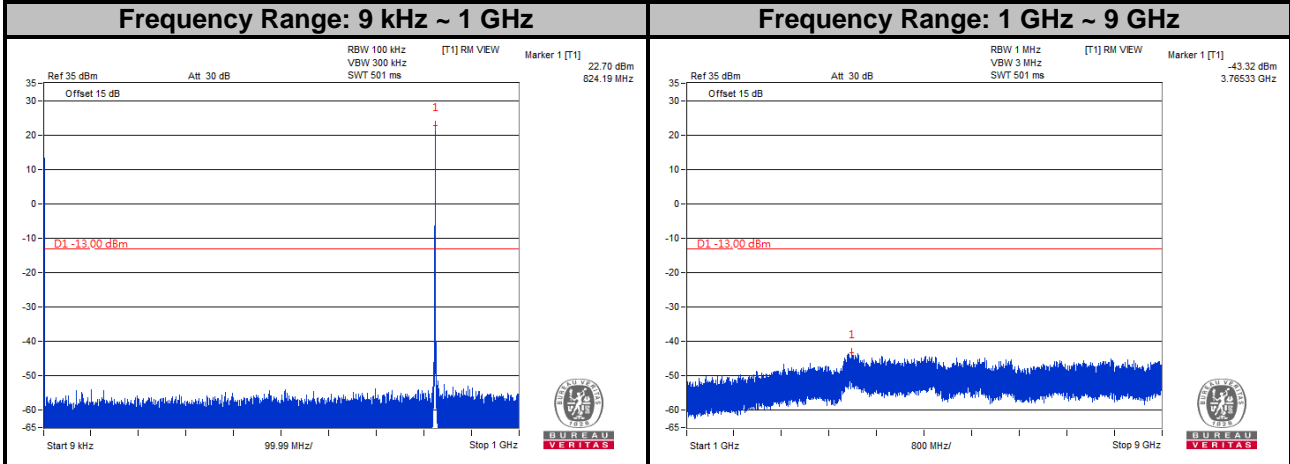

Channel 20525

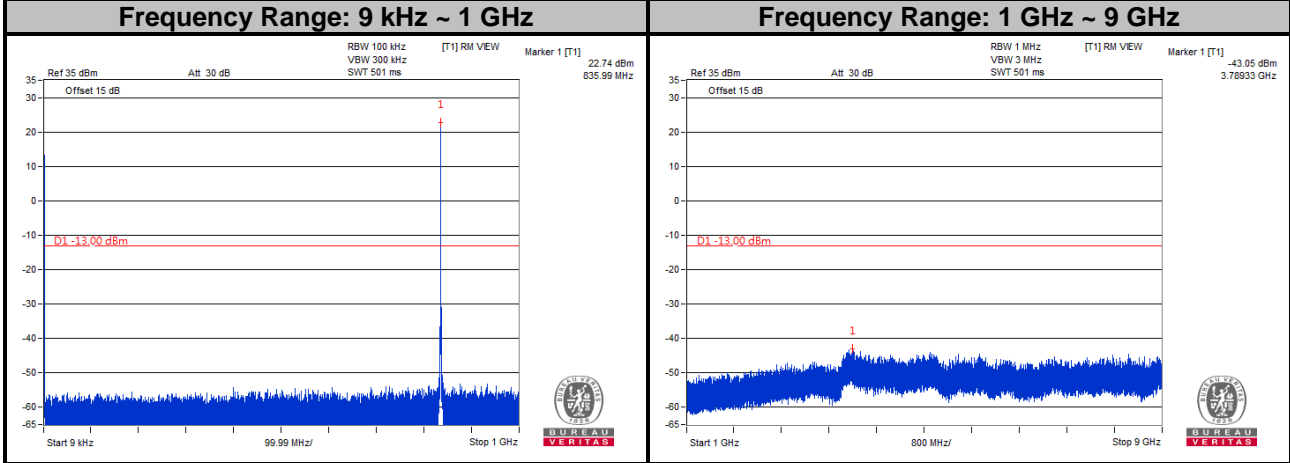

Channel 20643

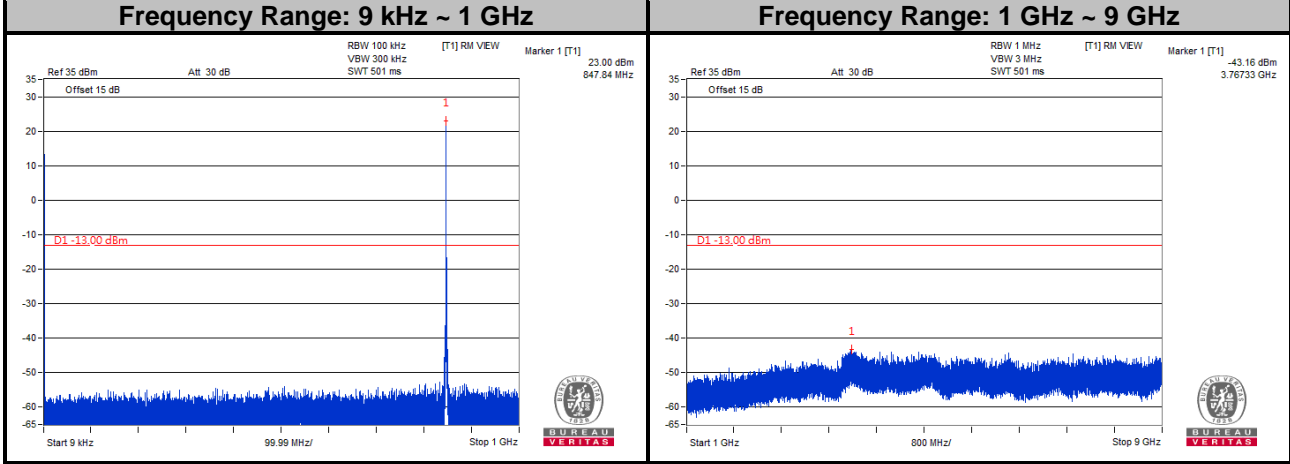

Note: The signal over the limit in 9 kHz is from spectrum analyzer.

LTE Band 5
Channel Bandwidth: 3 MHz
Channel 20415

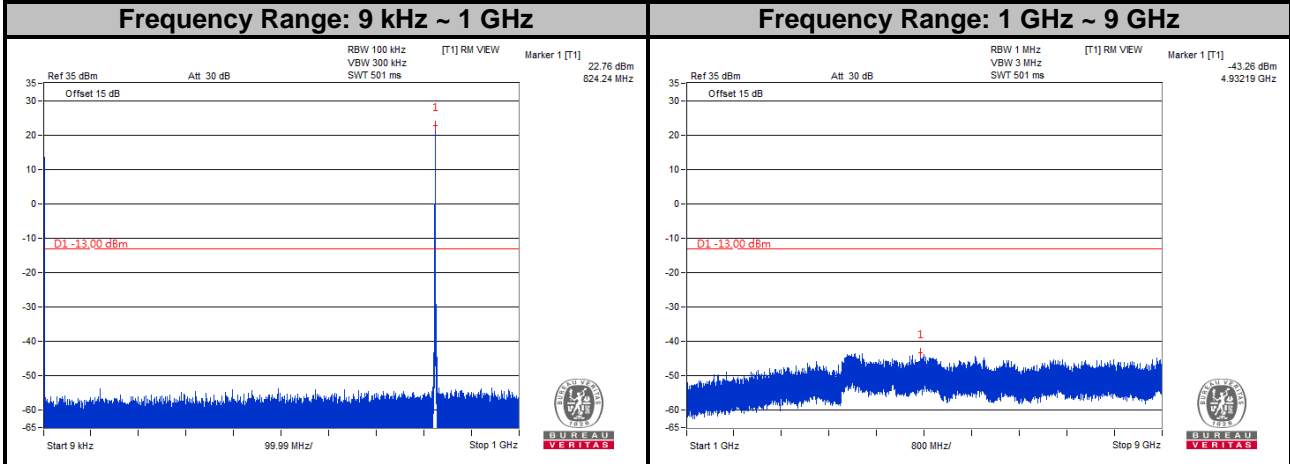

Channel 20525

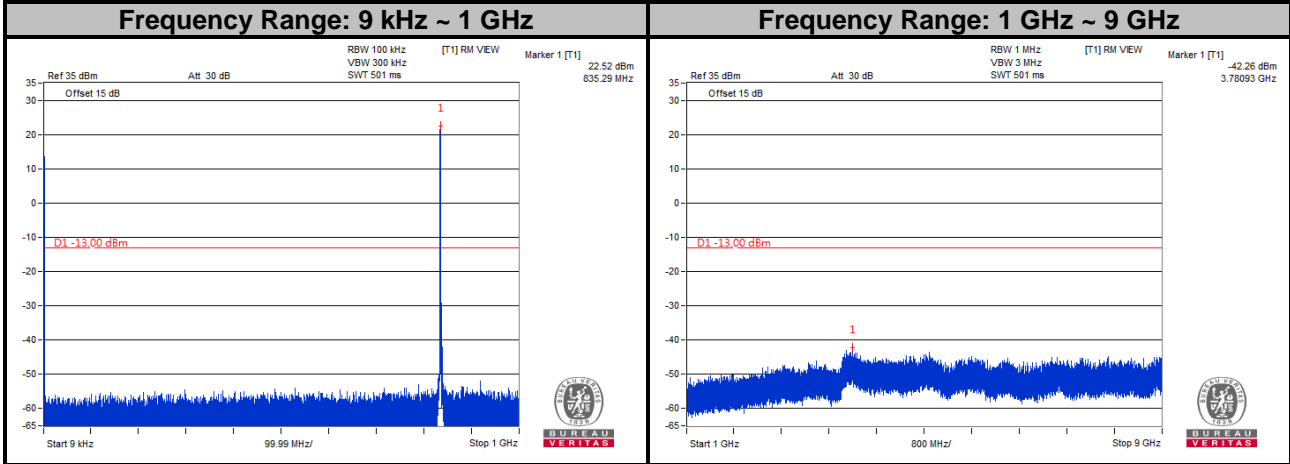

Channel 20635

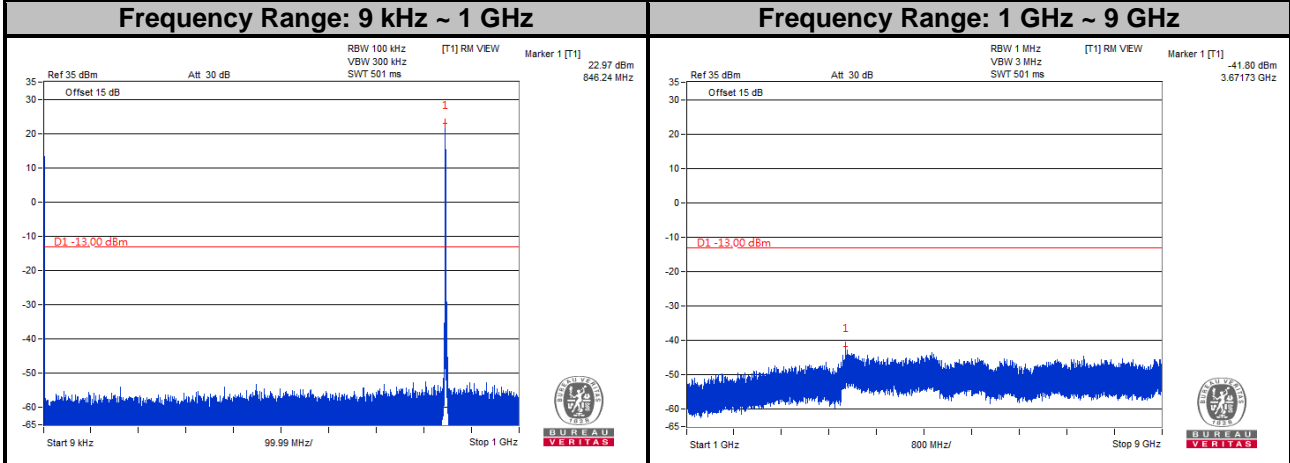

Note: The signal over the limit in 9 kHz is from spectrum analyzer.

LTE Band 5
Channel Bandwidth: 5 MHz
Channel 20425

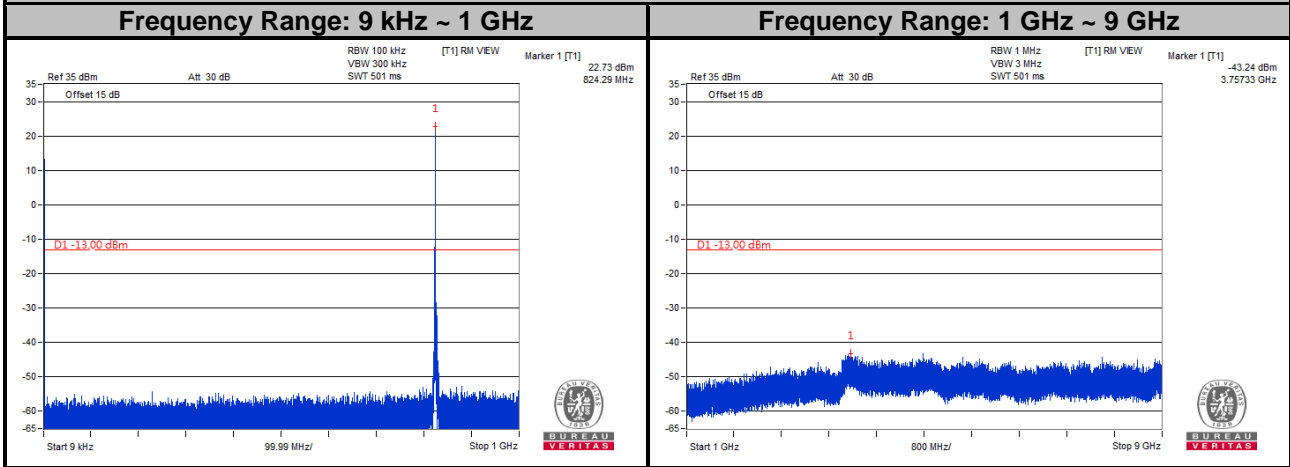

Channel 20525

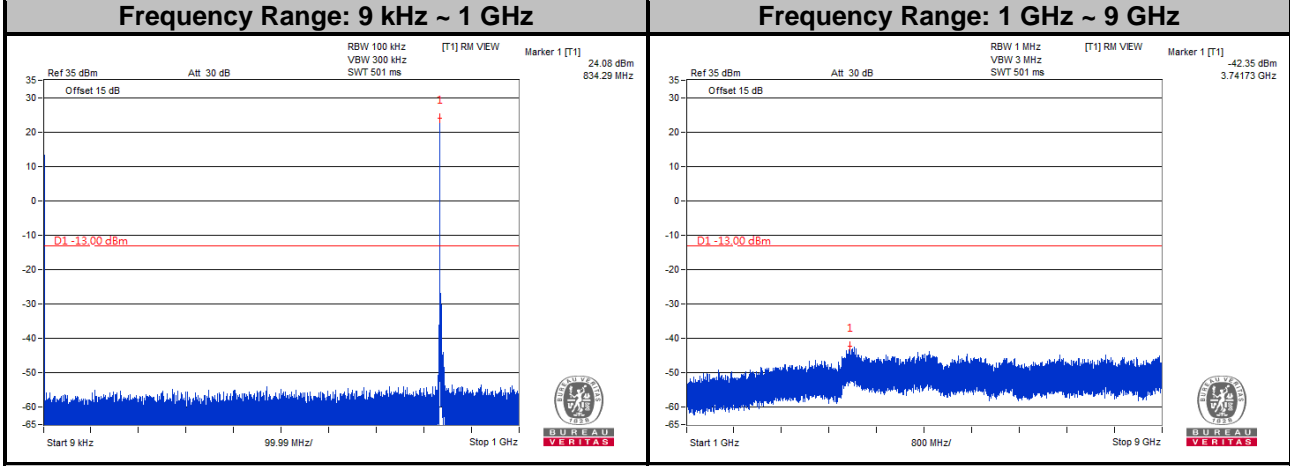

Channel Bandwidth: 5 MHz
Channel 20625

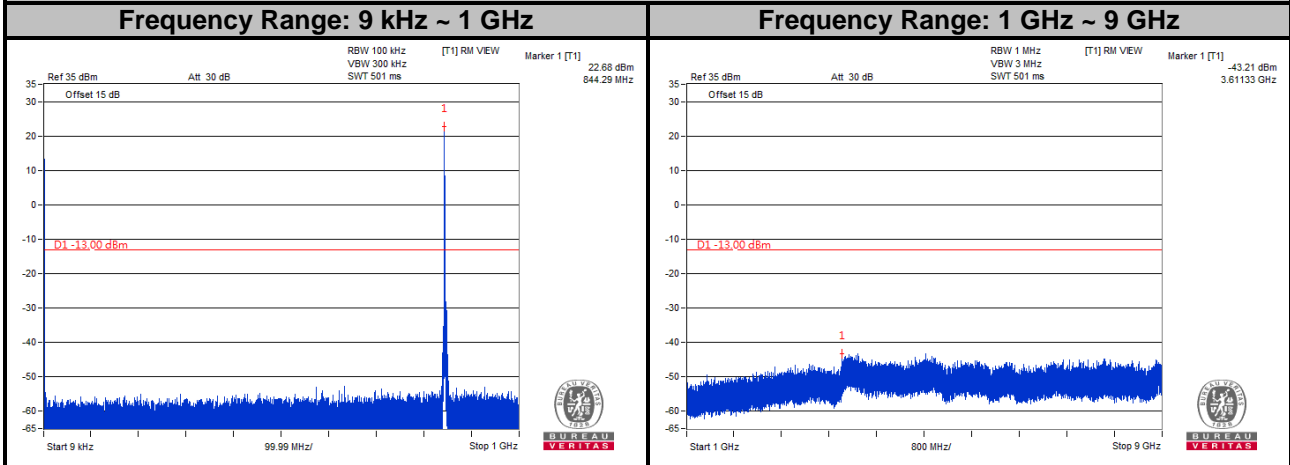

Note: The signal over the limit in 9 kHz is from spectrum analyzer.

LTE Band 5
Channel Bandwidth: 10 MHz
Channel 20450

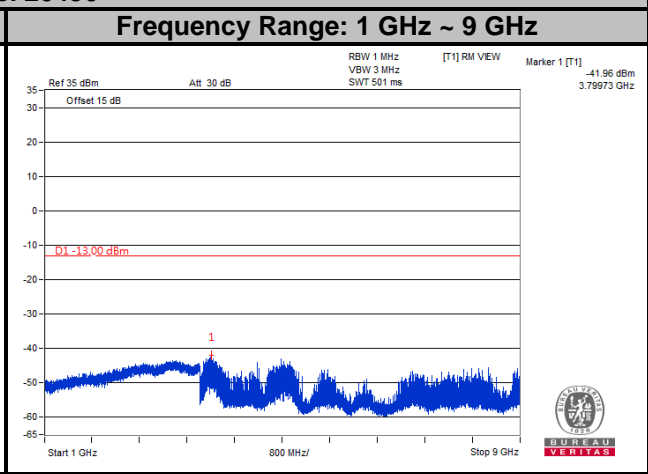
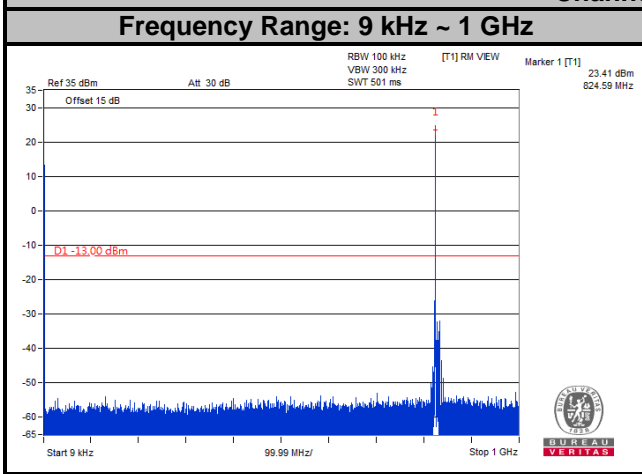

Channel 20525

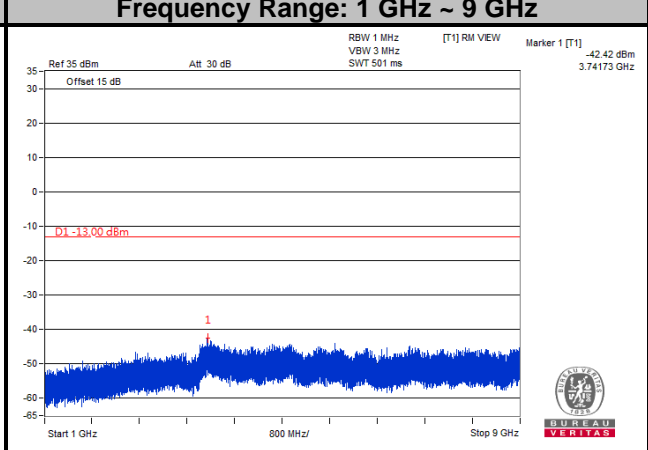
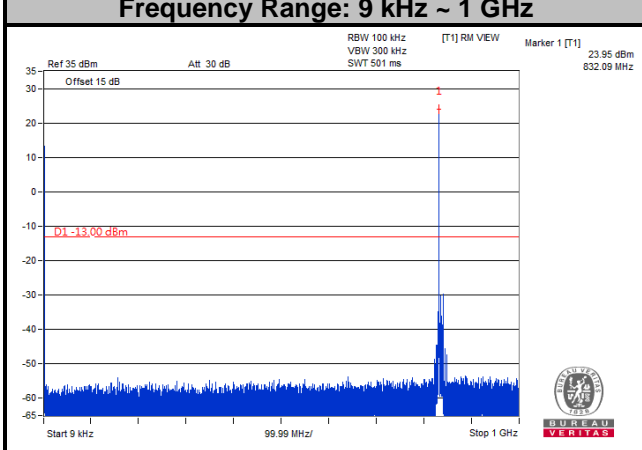

Channel 20600

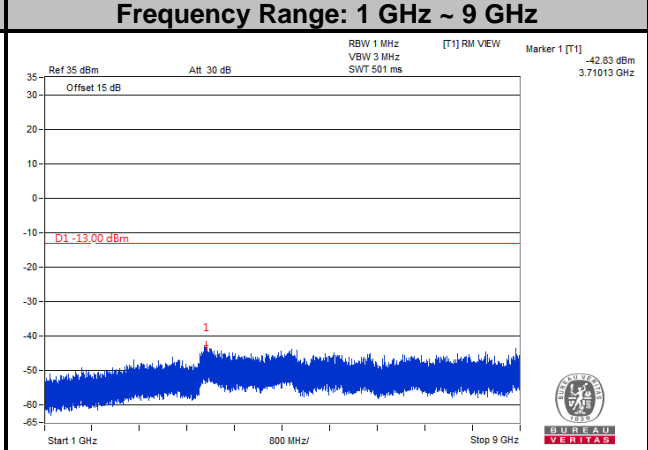
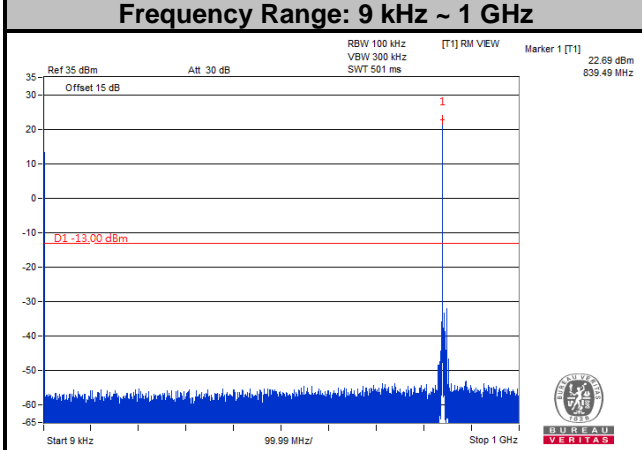

Note: The signal over the limit in 9 kHz is from spectrum analyzer.

4.8 Radiated Emission Measurement

4.8.1 Limits of Radiated Emission Measurement

The power of any emission outside of the authorized operating frequency ranges must be attenuated below the transmitting power (P) by a factor of at least $43 + 10 \log(P)$ dB. The emission limit is equal to -13 dBm.

4.8.2 Test Procedure

- a. E.I.R.P measurement. In the semi-anechoic chamber, EUT placed on the 0.8m(below or equal 1GHz) and/or 1.5m(above 1GHz) height of Turn Table, rotated the table around 360 degrees to search the maximum radiation power and receiver antenna shall be rotated vertical and horizontal polarization and moved height from 1m to 4m to find the maximum polar radiated power. The "Read Value" is the spectrum reading the maximum power value.
- b. The height of antenna is varied from one meter to four meters above the ground to determine the maximum value of the field strength. Both horizontal and vertical polarizations of the antenna are set to make the measurement.
- c. Perform a field strength measurement and record the worse read value, is the field strength value via a spectrum reading obtained corrected for antenna factor, cable loss and pre-amplifier factor and then mathematically convert the measured field strength level to EIRP/ERP level.
- d. Following C63.26 section 5.5 and 5.2.7
 $EIRP \text{ (dBm)} = E \text{ (dB}\mu\text{V/m)} + 20\log(D) - 104.8$; where D is the measurement distance (in the far field region) in m.
 $ERP \text{ (dBm)} = E \text{ (dB}\mu\text{V/m)} + 20\log(D) - 104.8 - 2.15$; where D is the measurement distance (in the far field region) in m.

NOTE:

1. The resolution bandwidth and video bandwidth of test receiver/spectrum analyzer is 1 MHz/3 MHz.
2. The emission levels were against the limit of frequency range 9 kHz ~ 30 MHz:

The amplitude of spurious emissions attenuated more than 20 dB below the permissible value is not required to be report.

4.8.3 Deviation from Test Standard

No deviation.

4.8.4 Test Setup

<Radiated Emission below or equal 1 GHz>

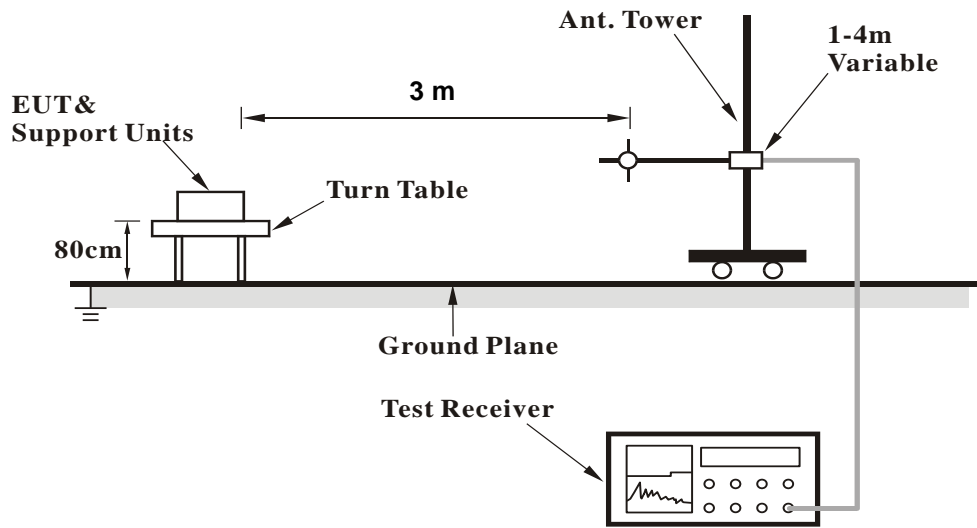

<Radiated Emission above 1 GHz>

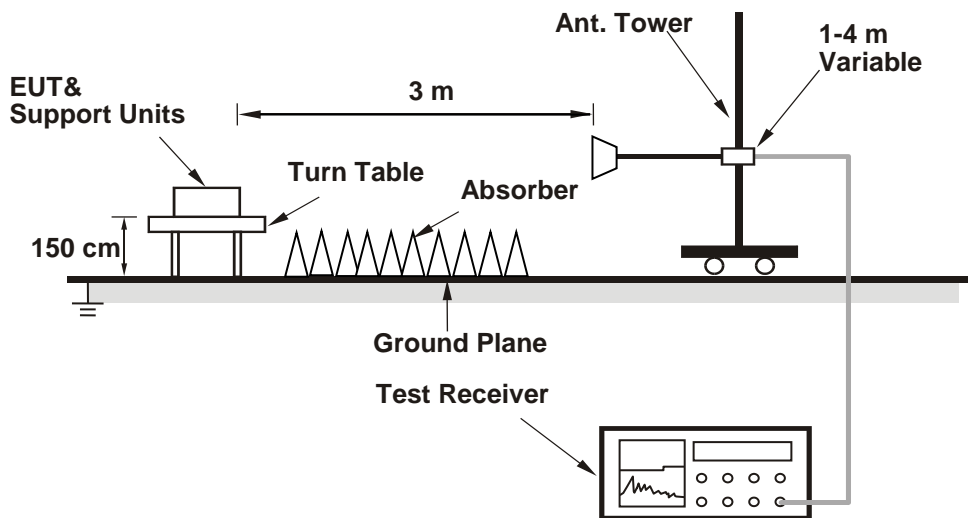

For the actual test configuration, please refer to the attached file (Test Setup Photo).

4.8.5 Test Results

Below 1GHz

Mode A

RF Mode	TX GSM 850	Channel	CH 189 : 836.4 MHz
Frequency Range	30MHz ~ 1GHz		

Antenna Polarity & Test Distance : Horizontal at 3 m								
No	Frequency (MHz)	ERP (dBm)	Limit (dBm)	Margin (dB)	Antenna Height (m)	Table Angle (Degree)	Raw Value (dBuV)	Correction Factor (dB/m)
1	47.46	-55.90	-13.00	-42.90	1.50 H	174	50.47	-106.37
2	89.17	-51.62	-13.00	-38.62	1.00 H	18	60.34	-111.96
3	166.77	-62.60	-13.00	-49.60	1.25 H	190	43.50	-106.10
4	296.75	-66.56	-13.00	-53.56	1.00 H	146	37.67	-104.23
5	480.08	-62.90	-13.00	-49.90	1.25 H	274	37.21	-100.11
6	615.88	-61.29	-13.00	-48.29	1.00 H	187	36.03	-97.32

Remarks:

1. $ERP(dBm) = Raw\ Value(dBuV) + Correction\ Factor(dB/m)$
2. $Correction\ Factor(dB/m) = Antenna\ Factor(dB/m) + Cable\ Factor(dB) - Pre-Amplifier\ Factor(dB) + 20\log(D) - 104.8 - 2.15$
3. $Margin\ value = ERP - Limit\ value$
4. The other ERP levels were very low against the limit.

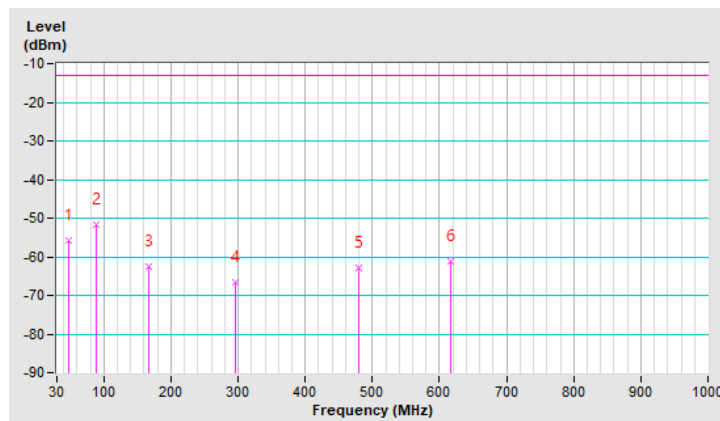

RF Mode	TX GSM 850	Channel	CH 189 : 836.4 MHz
Frequency Range	30MHz ~ 1GHz		

Antenna Polarity & Test Distance : Vertical at 3 m								
No	Frequency (MHz)	ERP (dBm)	Limit (dBm)	Margin (dB)	Antenna Height (m)	Table Angle (Degree)	Raw Value (dBuV)	Correction Factor (dB/m)
1	43.58	-64.30	-13.00	-51.30	1.25 V	18	42.32	-106.62
2	190.05	-63.61	-13.00	-50.61	1.00 V	301	44.99	-108.60
3	277.35	-61.60	-13.00	-48.60	1.50 V	20	43.18	-104.78
4	484.93	-62.61	-13.00	-49.61	1.00 V	353	37.43	-100.04
5	676.99	-57.50	-13.00	-44.50	1.25 V	341	39.00	-96.50
6	909.79	-51.42	-13.00	-38.42	1.00 V	280	40.09	-91.51

Remarks:

1. $ERP(dBm) = Raw\ Value(dBuV) + Correction\ Factor(dB/m)$
2. $Correction\ Factor(dB/m) = Antenna\ Factor(dB/m) + Cable\ Factor(dB) - Pre-Amplifier\ Factor(dB) + 20\log(D) - 104.8 - 2.15$
3. $Margin\ value = ERP - Limit\ value$
4. The other ERP levels were very low against the limit.

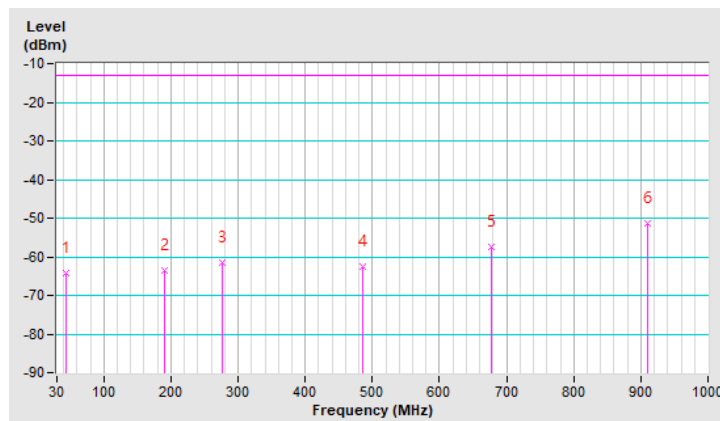

RF Mode	TX WCDMA Band V	Channel	CH 4132 : 826.4 MHz
Frequency Range	30MHz ~ 1GHz		

Antenna Polarity & Test Distance : Horizontal at 3 m								
No	Frequency (MHz)	ERP (dBm)	Limit (dBm)	Margin (dB)	Antenna Height (m)	Table Angle (Degree)	Raw Value (dBuV)	Correction Factor (dB/m)
1	52.31	-55.44	-13.00	-42.44	1.25 H	23	50.89	-106.33
2	165.80	-61.69	-13.00	-48.69	1.00 H	57	44.43	-106.12
3	288.99	-65.84	-13.00	-52.84	1.50 H	270	38.59	-104.43
4	389.87	-61.51	-13.00	-48.51	1.00 H	91	40.74	-102.25
5	523.73	-60.34	-13.00	-47.34	1.25 H	288	38.87	-99.21
6	676.99	-58.39	-13.00	-45.39	1.50 H	62	38.11	-96.50

Remarks:

1. $ERP(dBm) = Raw\ Value(dBuV) + Correction\ Factor(dB/m)$
2. $Correction\ Factor(dB/m) = Antenna\ Factor(dB/m) + Cable\ Factor(dB) - Pre-Amplifier\ Factor(dB) + 20\log(D) - 104.8 - 2.15$
3. $Margin\ value = ERP - Limit\ value$
4. The other ERP levels were very low against the limit.

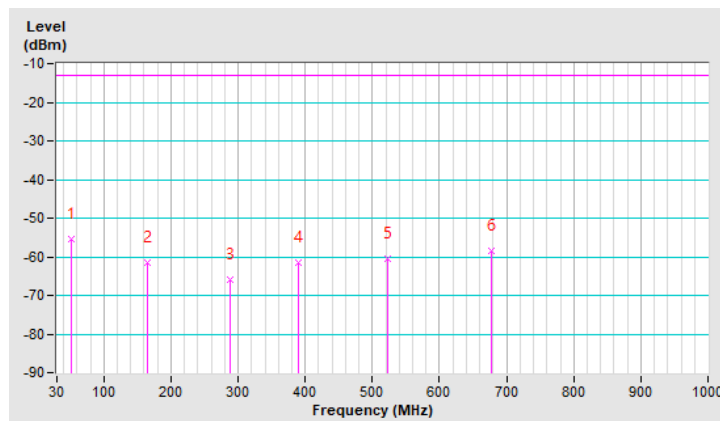

RF Mode	TX WCDMA Band V	Channel	CH 4132 : 826.4 MHz
Frequency Range	30MHz ~ 1GHz		

Antenna Polarity & Test Distance : Vertical at 3 m								
No	Frequency (MHz)	ERP (dBm)	Limit (dBm)	Margin (dB)	Antenna Height (m)	Table Angle (Degree)	Raw Value (dBuV)	Correction Factor (dB/m)
1	60.07	-57.26	-13.00	-44.26	1.00 V	160	49.58	-106.84
2	107.60	-57.18	-13.00	-44.18	1.50 V	159	52.40	-109.58
3	166.77	-57.78	-13.00	-44.78	2.00 V	14	48.32	-106.10
4	281.23	-59.98	-13.00	-46.98	1.25 V	282	44.68	-104.66
5	577.08	-58.88	-13.00	-45.88	1.00 V	2	39.29	-98.17
6	890.39	-52.21	-13.00	-39.21	1.00 V	193	40.00	-92.21

Remarks:

1. $ERP(dBm) = Raw\ Value(dBuV) + Correction\ Factor(dB/m)$
2. $Correction\ Factor(dB/m) = Antenna\ Factor(dB/m) + Cable\ Factor(dB) - Pre-Amplifier\ Factor(dB) + 20\log(D) - 104.8 - 2.15$
3. $Margin\ value = ERP - Limit\ value$
4. The other ERP levels were very low against the limit.

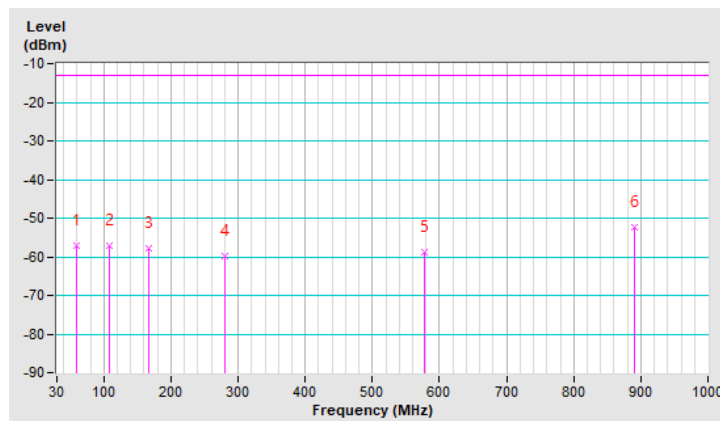

RF Mode	TX LTE Band V-1.4MHz	Channel	CH 20643 : 848.3 MHz
Frequency Range	30MHz ~ 1GHz		

Antenna Polarity & Test Distance : Horizontal at 3 m								
No	Frequency (MHz)	ERP (dBm)	Limit (dBm)	Margin (dB)	Antenna Height (m)	Table Angle (Degree)	Raw Value (dBuV)	Correction Factor (dB/m)
1	70.74	-53.49	-13.00	-40.49	1.00 H	42	54.96	-108.45
2	91.11	-56.13	-13.00	-43.13	1.25 H	306	55.83	-111.96
3	222.06	-50.10	-13.00	-37.10	1.00 H	112	58.23	-108.33
4	406.36	-63.59	-13.00	-50.59	1.25 H	348	38.41	-102.00
5	698.33	-60.66	-13.00	-47.66	1.50 H	283	35.57	-96.23
6	890.39	-55.28	-13.00	-42.28	1.00 H	139	36.93	-92.21

Remarks:

1. $ERP(dBm) = Raw\ Value(dBuV) + Correction\ Factor(dB/m)$
2. $Correction\ Factor(dB/m) = Antenna\ Factor(dB/m) + Cable\ Factor(dB) - Pre-Amplifier\ Factor(dB) + 20\log(D) - 104.8 - 2.15$
3. $Margin\ value = ERP - Limit\ value$
4. The other ERP levels were very low against the limit.

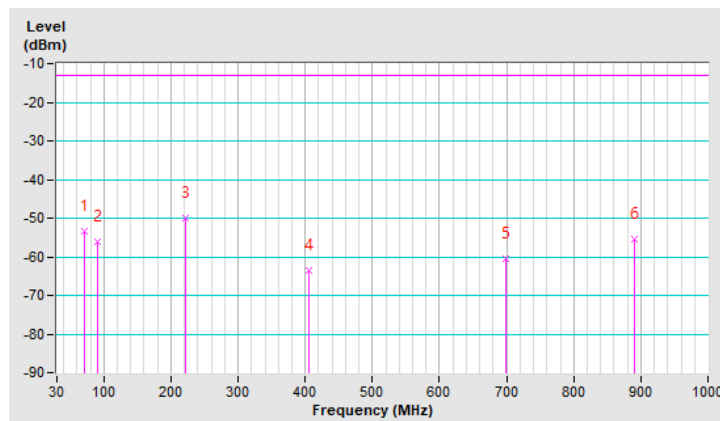

RF Mode	TX LTE Band V-1.4MHz	Channel	CH 20643 : 848.3 MHz
Frequency Range	30MHz ~ 1GHz		

Antenna Polarity & Test Distance : Vertical at 3 m								
No	Frequency (MHz)	ERP (dBm)	Limit (dBm)	Margin (dB)	Antenna Height (m)	Table Angle (Degree)	Raw Value (dBuV)	Correction Factor (dB/m)
1	32.91	-51.43	-13.00	-38.43	1.00 V	10	56.35	-107.78
2	80.44	-55.42	-13.00	-42.42	1.00 V	108	55.54	-110.96
3	198.78	-60.47	-13.00	-47.47	1.25 V	108	48.39	-108.86
4	617.82	-67.36	-13.00	-54.36	1.25 V	10	29.92	-97.28
5	824.43	-64.71	-13.00	-51.71	1.50 V	35	28.79	-93.50
6	968.96	-64.67	-13.00	-51.67	1.25 V	30	26.12	-90.79

Remarks:

1. $ERP(dBm) = Raw\ Value(dBuV) + Correction\ Factor(dB/m)$
2. $Correction\ Factor(dB/m) = Antenna\ Factor(dB/m) + Cable\ Factor(dB) - Pre-Amplifier\ Factor(dB) + 20\log(D) - 104.8 - 2.15$
3. $Margin\ value = ERP - Limit\ value$
4. The other ERP levels were very low against the limit.

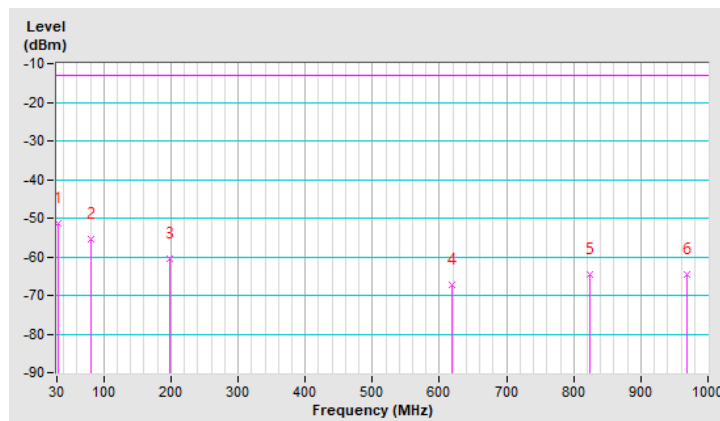

Mode B

RF Mode	TX GSM 850	Channel	CH 189 : 836.4 MHz
Frequency Range	30MHz ~ 1GHz		

Antenna Polarity & Test Distance : Horizontal at 3 m								
No	Frequency (MHz)	ERP (dBm)	Limit (dBm)	Margin (dB)	Antenna Height (m)	Table Angle (Degree)	Raw Value (dBuV)	Correction Factor (dB/m)
1	30.00	-60.52	-13.00	-47.52	1.25 H	1	47.11	-107.63
2	98.87	-58.92	-13.00	-45.92	1.00 H	159	52.10	-111.02
3	251.16	-61.74	-13.00	-48.74	1.50 H	146	44.41	-106.15
4	594.54	-60.14	-13.00	-47.14	1.00 H	16	37.58	-97.72
5	786.60	-57.56	-13.00	-44.56	1.00 H	81	36.47	-94.03
6	929.19	-54.63	-13.00	-41.63	1.25 H	41	36.44	-91.07

Remarks:

1. ERP(dBm) = Raw Value(dBuV) + Correction Factor(dB/m)
2. Correction Factor(dB/m) = Antenna Factor(dB/m) + Cable Factor(dB) – Pre-Amplifier Factor(dB) + 20log(D) – 104.8 – 2.15
3. Margin value = ERP – Limit value
4. The other ERP levels were very low against the limit.

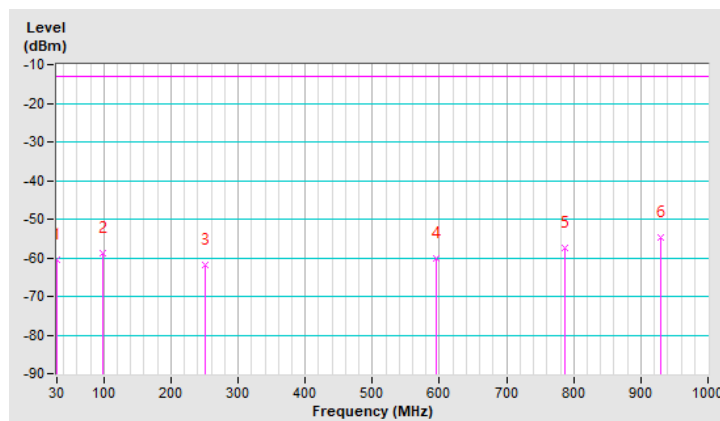

RF Mode	TX GSM 850	Channel	CH 189 : 836.4 MHz
Frequency Range	30MHz ~ 1GHz		

Antenna Polarity & Test Distance : Vertical at 3 m								
No	Frequency (MHz)	ERP (dBm)	Limit (dBm)	Margin (dB)	Antenna Height (m)	Table Angle (Degree)	Raw Value (dBuV)	Correction Factor (dB/m)
1	33.88	-52.79	-13.00	-39.79	1.00 V	300	54.66	-107.45
2	111.48	-57.23	-13.00	-44.23	1.50 V	55	52.02	-109.25
3	218.18	-44.12	-13.00	-31.12	1.00 V	55	64.17	-108.29
4	491.72	-61.74	-13.00	-48.74	1.25 V	346	38.14	-99.88
5	673.11	-59.83	-13.00	-46.83	1.00 V	350	36.75	-96.58
6	943.74	-55.22	-13.00	-42.22	1.25 V	186	35.80	-91.02

Remarks:

1. $ERP(dBm) = Raw\ Value(dBuV) + Correction\ Factor(dB/m)$
2. $Correction\ Factor(dB/m) = Antenna\ Factor(dB/m) + Cable\ Factor(dB) - Pre-Amplifier\ Factor(dB) + 20\log(D) - 104.8 - 2.15$
3. $Margin\ value = ERP - Limit\ value$
4. The other ERP levels were very low against the limit.

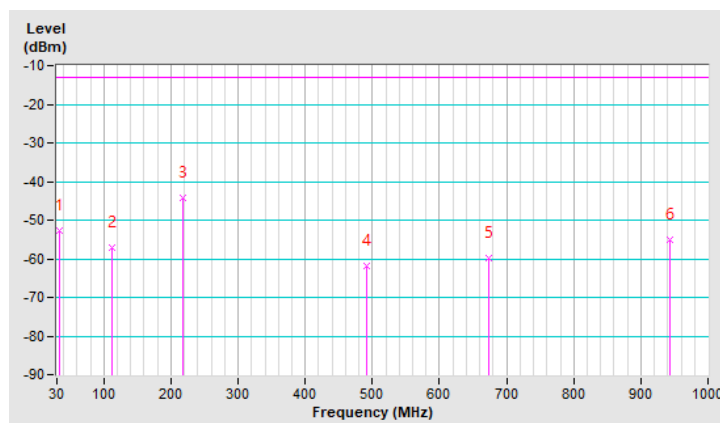

RF Mode	TX WCDMA Band V	Channel	CH 4132 : 826.4 MHz
Frequency Range	30MHz ~ 1GHz		

Antenna Polarity & Test Distance : Horizontal at 3 m								
No	Frequency (MHz)	ERP (dBm)	Limit (dBm)	Margin (dB)	Antenna Height (m)	Table Angle (Degree)	Raw Value (dBuV)	Correction Factor (dB/m)
1	30.00	-60.52	-13.00	-47.52	1.50 H	1	47.11	-107.63
2	70.74	-56.80	-13.00	-43.80	1.00 H	146	51.65	-108.45
3	277.35	-64.79	-13.00	-51.79	1.25 H	198	39.99	-104.78
4	577.08	-61.20	-13.00	-48.20	1.00 H	28	36.97	-98.17
5	737.13	-58.85	-13.00	-45.85	1.50 H	244	36.60	-95.45
6	873.90	-56.84	-13.00	-43.84	1.25 H	223	35.68	-92.52

Remarks:

1. $ERP(dBm) = Raw\ Value(dBuV) + Correction\ Factor(dB/m)$
2. $Correction\ Factor(dB/m) = Antenna\ Factor(dB/m) + Cable\ Factor(dB) - Pre-Amplifier\ Factor(dB) + 20\log(D) - 104.8 - 2.15$
3. $Margin\ value = ERP - Limit\ value$
4. The other ERP levels were very low against the limit.

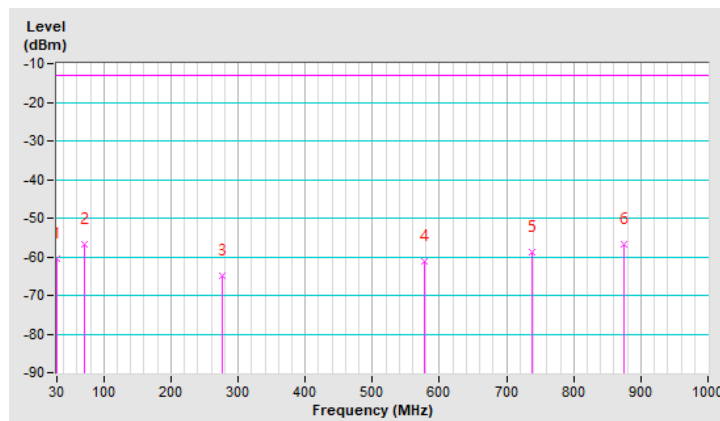

RF Mode	TX WCDMA Band V	Channel	CH 4132 : 826.4 MHz
Frequency Range	30MHz ~ 1GHz		

Antenna Polarity & Test Distance : Vertical at 3 m								
No	Frequency (MHz)	ERP (dBm)	Limit (dBm)	Margin (dB)	Antenna Height (m)	Table Angle (Degree)	Raw Value (dBuV)	Correction Factor (dB/m)
1	30.00	-45.87	-13.00	-32.87	1.50 V	317	61.76	-107.63
2	149.31	-60.10	-13.00	-47.10	1.25 V	55	46.00	-106.10
3	338.46	-66.71	-13.00	-53.71	1.50 V	243	36.52	-103.23
4	579.02	-60.93	-13.00	-47.93	1.00 V	103	37.18	-98.11
5	737.13	-58.13	-13.00	-45.13	1.00 V	271	37.32	-95.45
6	971.87	-55.58	-13.00	-42.58	1.25 V	66	35.22	-90.80

Remarks:

1. $ERP(dBm) = Raw\ Value(dBuV) + Correction\ Factor(dB/m)$
2. $Correction\ Factor(dB/m) = Antenna\ Factor(dB/m) + Cable\ Factor(dB) - Pre-Amplifier\ Factor(dB) + 20\log(D) - 104.8 - 2.15$
3. $Margin\ value = ERP - Limit\ value$
4. The other ERP levels were very low against the limit.

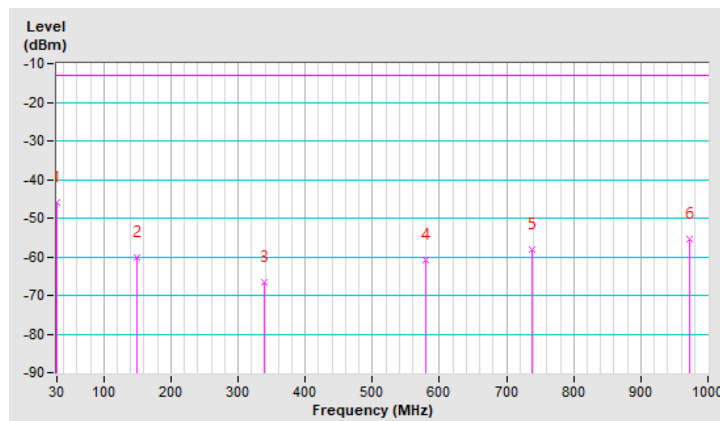

RF Mode	TX LTE Band V-1.4MHz	Channel	CH 20643 : 848.3 MHz
Frequency Range	30MHz ~ 1GHz		

Antenna Polarity & Test Distance : Horizontal at 3 m								
No	Frequency (MHz)	ERP (dBm)	Limit (dBm)	Margin (dB)	Antenna Height (m)	Table Angle (Degree)	Raw Value (dBuV)	Correction Factor (dB/m)
1	50.37	-55.66	-13.00	-42.66	1.25 H	2	50.64	-106.30
2	98.87	-58.92	-13.00	-45.92	1.00 H	159	52.10	-111.02
3	205.57	-67.35	-13.00	-54.35	1.50 H	144	41.36	-108.71
4	534.40	-62.28	-13.00	-49.28	1.25 H	128	36.84	-99.12
5	770.11	-58.32	-13.00	-45.32	1.00 H	267	36.12	-94.44
6	957.32	-55.18	-13.00	-42.18	1.00 H	14	35.76	-90.94

Remarks:

1. $ERP(dBm) = Raw\ Value(dBuV) + Correction\ Factor(dB/m)$
2. $Correction\ Factor(dB/m) = Antenna\ Factor(dB/m) + Cable\ Factor(dB) - Pre-Amplifier\ Factor(dB) + 20\log(D) - 104.8 - 2.15$
3. $Margin\ value = ERP - Limit\ value$
4. The other ERP levels were very low against the limit.

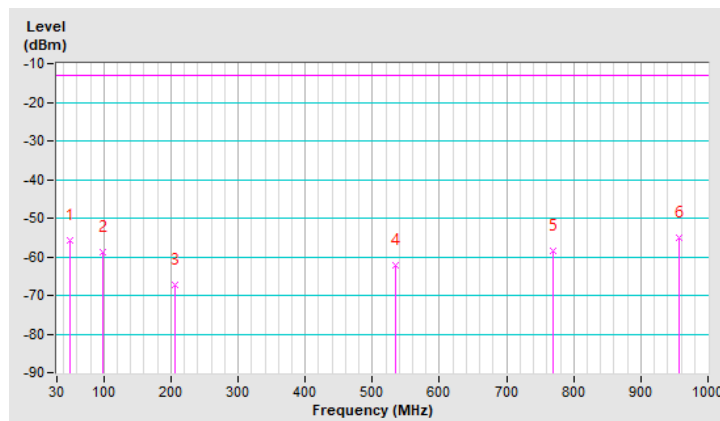

RF Mode	TX LTE Band V-1.4MHz	Channel	CH 20643 : 848.3 MHz
Frequency Range	30MHz ~ 1GHz		

Antenna Polarity & Test Distance : Vertical at 3 m								
No	Frequency (MHz)	ERP (dBm)	Limit (dBm)	Margin (dB)	Antenna Height (m)	Table Angle (Degree)	Raw Value (dBuV)	Correction Factor (dB/m)
1	30.00	-50.01	-13.00	-37.01	1.00 V	160	57.62	-107.63
2	128.94	-62.53	-13.00	-49.53	1.25 V	354	45.06	-107.59
3	170.65	-61.79	-13.00	-48.79	1.50 V	308	44.57	-106.36
4	503.36	-60.44	-13.00	-47.44	1.00 V	277	39.18	-99.62
5	628.49	-57.18	-13.00	-44.18	1.00 V	181	39.89	-97.07
6	841.89	-54.66	-13.00	-41.66	1.00 V	183	38.54	-93.20

Remarks:

1. $ERP(dBm) = Raw\ Value(dBuV) + Correction\ Factor(dB/m)$
2. $Correction\ Factor(dB/m) = Antenna\ Factor(dB/m) + Cable\ Factor(dB) - Pre-Amplifier\ Factor(dB) + 20\log(D) - 104.8 - 2.15$
3. $Margin\ value = ERP - Limit\ value$
4. The other ERP levels were very low against the limit.

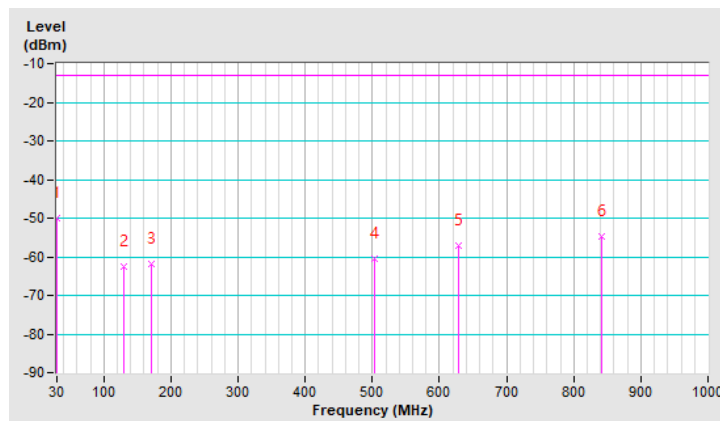

Above 1GHz
GSM Mode

RF Mode	TX GSM 850	Channel	CH 128 : 824.2 MHz
Frequency Range	1GMHz ~ 18GHz		

Antenna Polarity & Test Distance : Horizontal at 3 m								
No	Frequency (MHz)	ERP (dBm)	Limit (dBm)	Margin (dB)	Antenna Height (m)	Table Angle (Degree)	Raw Value (dBuV)	Correction Factor (dB/m)
1	1648.40	-46.90	-13.00	-33.90	2.56 H	147	55.13	-102.03
Antenna Polarity & Test Distance : Vertical at 3 m								
No	Frequency (MHz)	ERP (dBm)	Limit (dBm)	Margin (dB)	Antenna Height (m)	Table Angle (Degree)	Raw Value (dBuV)	Correction Factor (dB/m)
1	1648.40	-50.84	-13.00	-37.84	1.28 V	314	51.19	-102.03

Remarks:

1. ERP(dBm) = Raw Value(dBuV) + Correction Factor(dB/m)
2. Correction Factor(dB/m) = Antenna Factor(dB/m) + Cable Factor(dB) – Pre-Amplifier Factor(dB) + 20log(D) – 104.8 – 2.15
3. Margin value = ERP – Limit value
4. The other ERP levels were very low against the limit.

RF Mode	TX GSM 850	Channel	CH 189 : 836.4 MHz
Frequency Range	1GMHz ~ 18GHz		

Antenna Polarity & Test Distance : Horizontal at 3 m								
No	Frequency (MHz)	ERP (dBm)	Limit (dBm)	Margin (dB)	Antenna Height (m)	Table Angle (Degree)	Raw Value (dBuV)	Correction Factor (dB/m)
1	1672.80	-47.67	-13.00	-34.67	2.48 H	139	54.29	-101.96
Antenna Polarity & Test Distance : Vertical at 3 m								
No	Frequency (MHz)	ERP (dBm)	Limit (dBm)	Margin (dB)	Antenna Height (m)	Table Angle (Degree)	Raw Value (dBuV)	Correction Factor (dB/m)
1	1672.80	-50.37	-13.00	-37.37	1.34 V	304	51.59	-101.96

Remarks:

1. ERP(dBm) = Raw Value(dBuV) + Correction Factor(dB/m)
2. Correction Factor(dB/m) = Antenna Factor(dB/m) + Cable Factor(dB) – Pre-Amplifier Factor(dB) + 20log(D) – 104.8 – 2.15
3. Margin value = ERP – Limit value
4. The other ERP levels were very low against the limit.

RF Mode	TX GSM 850	Channel	CH 251 : 848.8 MHz
Frequency Range	1GMHz ~ 18GHz		

Antenna Polarity & Test Distance : Horizontal at 3 m								
No	Frequency (MHz)	ERP (dBm)	Limit (dBm)	Margin (dB)	Antenna Height (m)	Table Angle (Degree)	Raw Value (dBuV)	Correction Factor (dB/m)
1	1697.60	-47.78	-13.00	-34.78	2.51 H	154	54.10	-101.88
Antenna Polarity & Test Distance : Vertical at 3 m								
No	Frequency (MHz)	ERP (dBm)	Limit (dBm)	Margin (dB)	Antenna Height (m)	Table Angle (Degree)	Raw Value (dBuV)	Correction Factor (dB/m)
1	1697.60	-50.34	-13.00	-37.34	1.34 V	302	51.54	-101.88

Remarks:

1. ERP(dBm) = Raw Value(dBuV) + Correction Factor(dB/m)
2. Correction Factor(dB/m) = Antenna Factor(dB/m) + Cable Factor(dB) – Pre-Amplifier Factor(dB) + 20log(D) – 104.8 – 2.15
3. Margin value = ERP – Limit value
4. The other ERP levels were very low against the limit.

WCDMA Band 5

RF Mode	TX WCDMA Band V	Channel	CH 4132 : 826.4 MHz
Frequency Range	1GMHz ~ 18GHz		

Antenna Polarity & Test Distance : Horizontal at 3 m								
No	Frequency (MHz)	ERP (dBm)	Limit (dBm)	Margin (dB)	Antenna Height (m)	Table Angle (Degree)	Raw Value (dBuV)	Correction Factor (dB/m)
1	1652.80	-47.93	-13.00	-34.93	2.59 H	141	54.10	-102.03
Antenna Polarity & Test Distance : Vertical at 3 m								
No	Frequency (MHz)	ERP (dBm)	Limit (dBm)	Margin (dB)	Antenna Height (m)	Table Angle (Degree)	Raw Value (dBuV)	Correction Factor (dB/m)
1	1652.80	-50.34	-13.00	-37.34	1.26 V	303	51.69	-102.03

Remarks:

1. ERP(dBm) = Raw Value(dBuV) + Correction Factor(dB/m)
2. Correction Factor(dB/m) = Antenna Factor(dB/m) + Cable Factor(dB) – Pre-Amplifier Factor(dB) + 20log(D) – 104.8 – 2.15
3. Margin value = ERP – Limit value
4. The other ERP levels were very low against the limit.

RF Mode	TX WCDMA Band V	Channel	CH 4182 : 836.4 MHz
Frequency Range	1GMHz ~ 18GHz		

Antenna Polarity & Test Distance : Horizontal at 3 m

No	Frequency (MHz)	ERP (dBm)	Limit (dBm)	Margin (dB)	Antenna Height (m)	Table Angle (Degree)	Raw Value (dBuV)	Correction Factor (dB/m)
1	1672.80	-48.38	-13.00	-35.38	2.49 H	150	53.58	-101.96

Antenna Polarity & Test Distance : Vertical at 3 m

No	Frequency (MHz)	ERP (dBm)	Limit (dBm)	Margin (dB)	Antenna Height (m)	Table Angle (Degree)	Raw Value (dBuV)	Correction Factor (dB/m)
1	1672.80	-50.87	-13.00	-37.87	1.36 V	307	51.09	-101.96

Remarks:

1. ERP(dBm) = Raw Value(dBuV) + Correction Factor(dB/m)
2. Correction Factor(dB/m) = Antenna Factor(dB/m) + Cable Factor(dB) – Pre-Amplifier Factor(dB) + 20log(D) – 104.8 – 2.15
3. Margin value = ERP – Limit value
4. The other ERP levels were very low against the limit.

RF Mode	TX WCDMA Band V	Channel	CH 4233 : 846.6 MHz
Frequency Range	1GMHz ~ 18GHz		

Antenna Polarity & Test Distance : Horizontal at 3 m

No	Frequency (MHz)	ERP (dBm)	Limit (dBm)	Margin (dB)	Antenna Height (m)	Table Angle (Degree)	Raw Value (dBuV)	Correction Factor (dB/m)
1	1693.20	-47.94	-13.00	-34.94	2.63 H	157	53.96	-101.90

Antenna Polarity & Test Distance : Vertical at 3 m

No	Frequency (MHz)	ERP (dBm)	Limit (dBm)	Margin (dB)	Antenna Height (m)	Table Angle (Degree)	Raw Value (dBuV)	Correction Factor (dB/m)
1	1693.20	-50.48	-13.00	-37.48	1.19 V	326	51.42	-101.90

Remarks:

1. ERP(dBm) = Raw Value(dBuV) + Correction Factor(dB/m)
2. Correction Factor(dB/m) = Antenna Factor(dB/m) + Cable Factor(dB) – Pre-Amplifier Factor(dB) + 20log(D) – 104.8 – 2.15
3. Margin value = ERP – Limit value
4. The other ERP levels were very low against the limit.

LTE Band 5, Channel Bandwidth: 1.4MHz

RF Mode	TX LTE Band V-1.4MHz	Channel	CH 20407 : 824.7 MHz
Frequency Range	1GMHz ~ 18GHz		

Antenna Polarity & Test Distance : Horizontal at 3 m

No	Frequency (MHz)	ERP (dBm)	Limit (dBm)	Margin (dB)	Antenna Height (m)	Table Angle (Degree)	Raw Value (dBuV)	Correction Factor (dB/m)
1	1649.40	-38.38	-13.00	-25.38	3.18 H	204	63.65	-102.03

Antenna Polarity & Test Distance : Vertical at 3 m

No	Frequency (MHz)	ERP (dBm)	Limit (dBm)	Margin (dB)	Antenna Height (m)	Table Angle (Degree)	Raw Value (dBuV)	Correction Factor (dB/m)
1	1649.40	-37.84	-13.00	-24.84	1.59 V	87	64.19	-102.03

Remarks:

1. ERP(dBm) = Raw Value(dBuV) + Correction Factor(dB/m)
2. Correction Factor(dB/m) = Antenna Factor(dB/m) + Cable Factor(dB) – Pre-Amplifier Factor(dB) + 20log(D) – 104.8 – 2.15
3. Margin value = ERP – Limit value
4. The other ERP levels were very low against the limit.

RF Mode	TX LTE Band V-1.4MHz	Channel	CH 20525 : 836.5 MHz
Frequency Range	1GMHz ~ 18GHz		

Antenna Polarity & Test Distance : Horizontal at 3 m

No	Frequency (MHz)	ERP (dBm)	Limit (dBm)	Margin (dB)	Antenna Height (m)	Table Angle (Degree)	Raw Value (dBuV)	Correction Factor (dB/m)
1	1673.00	-38.84	-13.00	-25.84	3.11 H	209	63.12	-101.96

Antenna Polarity & Test Distance : Vertical at 3 m

No	Frequency (MHz)	ERP (dBm)	Limit (dBm)	Margin (dB)	Antenna Height (m)	Table Angle (Degree)	Raw Value (dBuV)	Correction Factor (dB/m)
1	1673.00	-37.79	-13.00	-24.79	1.57 V	73	64.17	-101.96

Remarks:

1. ERP(dBm) = Raw Value(dBuV) + Correction Factor(dB/m)
2. Correction Factor(dB/m) = Antenna Factor(dB/m) + Cable Factor(dB) – Pre-Amplifier Factor(dB) + 20log(D) – 104.8 – 2.15
3. Margin value = ERP – Limit value
4. The other ERP levels were very low against the limit.

RF Mode	TX LTE Band V-1.4MHz	Channel	CH 20643 : 848.3 MHz
Frequency Range	1GMHz ~ 18GHz		

Antenna Polarity & Test Distance : Horizontal at 3 m								
No	Frequency (MHz)	ERP (dBm)	Limit (dBm)	Margin (dB)	Antenna Height (m)	Table Angle (Degree)	Raw Value (dBuV)	Correction Factor (dB/m)
1	1696.60	-38.93	-13.00	-25.93	3.08 H	215	62.96	-101.89
Antenna Polarity & Test Distance : Vertical at 3 m								
No	Frequency (MHz)	ERP (dBm)	Limit (dBm)	Margin (dB)	Antenna Height (m)	Table Angle (Degree)	Raw Value (dBuV)	Correction Factor (dB/m)
1	1696.60	-37.36	-13.00	-24.36	1.69 V	82	64.53	-101.89

Remarks:

1. ERP(dBm) = Raw Value(dBuV) + Correction Factor(dB/m)
2. Correction Factor(dB/m) = Antenna Factor(dB/m) + Cable Factor(dB) – Pre-Amplifier Factor(dB) + 20log(D) – 104.8 – 2.15
3. Margin value = ERP – Limit value
4. The other ERP levels were very low against the limit.

LTE Band 5, Channel Bandwidth: 5MHz

RF Mode	TX LTE Band V-5MHz	Channel	CH 20425 : 826.5 MHz
Frequency Range	1GMHz ~ 18GHz		

Antenna Polarity & Test Distance : Horizontal at 3 m								
No	Frequency (MHz)	ERP (dBm)	Limit (dBm)	Margin (dB)	Antenna Height (m)	Table Angle (Degree)	Raw Value (dBuV)	Correction Factor (dB/m)
1	1653.00	-38.24	-13.00	-25.24	3.06 H	217	63.79	-102.03
Antenna Polarity & Test Distance : Vertical at 3 m								
No	Frequency (MHz)	ERP (dBm)	Limit (dBm)	Margin (dB)	Antenna Height (m)	Table Angle (Degree)	Raw Value (dBuV)	Correction Factor (dB/m)
1	1653.00	-37.73	-13.00	-24.73	1.43 V	74	64.30	-102.03

Remarks:

1. ERP(dBm) = Raw Value(dBuV) + Correction Factor(dB/m)
2. Correction Factor(dB/m) = Antenna Factor(dB/m) + Cable Factor(dB) – Pre-Amplifier Factor(dB) + 20log(D) – 104.8 – 2.15
3. Margin value = ERP – Limit value
4. The other ERP levels were very low against the limit.

RF Mode	TX LTE Band V-5MHz	Channel	CH 20525 : 836.5 MHz
Frequency Range	1GMHz ~ 18GHz		

Antenna Polarity & Test Distance : Horizontal at 3 m								
No	Frequency (MHz)	ERP (dBm)	Limit (dBm)	Margin (dB)	Antenna Height (m)	Table Angle (Degree)	Raw Value (dBuV)	Correction Factor (dB/m)
1	1673.00	-39.14	-13.00	-26.14	3.26 H	212	62.82	-101.96
Antenna Polarity & Test Distance : Vertical at 3 m								
No	Frequency (MHz)	ERP (dBm)	Limit (dBm)	Margin (dB)	Antenna Height (m)	Table Angle (Degree)	Raw Value (dBuV)	Correction Factor (dB/m)
1	1673.00	-37.84	-13.00	-24.84	1.46 V	96	64.12	-101.96

Remarks:

1. ERP(dBm) = Raw Value(dBuV) + Correction Factor(dB/m)
2. Correction Factor(dB/m) = Antenna Factor(dB/m) + Cable Factor(dB) – Pre-Amplifier Factor(dB) + 20log(D) – 104.8 – 2.15
3. Margin value = ERP – Limit value
4. The other ERP levels were very low against the limit.

RF Mode	TX LTE Band V-5MHz	Channel	CH 20625 : 846.5 MHz
Frequency Range	1GMHz ~ 18GHz		

Antenna Polarity & Test Distance : Horizontal at 3 m								
No	Frequency (MHz)	ERP (dBm)	Limit (dBm)	Margin (dB)	Antenna Height (m)	Table Angle (Degree)	Raw Value (dBuV)	Correction Factor (dB/m)
1	1693.00	-38.92	-13.00	-25.92	3.38 H	216	62.98	-101.90
Antenna Polarity & Test Distance : Vertical at 3 m								
No	Frequency (MHz)	ERP (dBm)	Limit (dBm)	Margin (dB)	Antenna Height (m)	Table Angle (Degree)	Raw Value (dBuV)	Correction Factor (dB/m)
1	1693.00	-38.32	-13.00	-25.32	1.52 V	73	63.58	-101.90

Remarks:

1. ERP(dBm) = Raw Value(dBuV) + Correction Factor(dB/m)
2. Correction Factor(dB/m) = Antenna Factor(dB/m) + Cable Factor(dB) – Pre-Amplifier Factor(dB) + 20log(D) – 104.8 – 2.15
3. Margin value = ERP – Limit value
4. The other ERP levels were very low against the limit.

LTE Band 5, Channel Bandwidth: 10MHz

RF Mode	TX LTE Band V-10MHz	Channel	CH 20450 : 829 MHz
Frequency Range	1GMHz ~ 18GHz		

Antenna Polarity & Test Distance : Horizontal at 3 m								
No	Frequency (MHz)	ERP (dBm)	Limit (dBm)	Margin (dB)	Antenna Height (m)	Table Angle (Degree)	Raw Value (dBuV)	Correction Factor (dB/m)
1	1658.00	-38.16	-13.00	-25.16	3.07 H	214	63.85	-102.01
Antenna Polarity & Test Distance : Vertical at 3 m								
No	Frequency (MHz)	ERP (dBm)	Limit (dBm)	Margin (dB)	Antenna Height (m)	Table Angle (Degree)	Raw Value (dBuV)	Correction Factor (dB/m)
1	1658.00	-37.46	-13.00	-24.46	1.36 V	84	64.55	-102.01

Remarks:

1. ERP(dBm) = Raw Value(dBuV) + Correction Factor(dB/m)
2. Correction Factor(dB/m) = Antenna Factor(dB/m) + Cable Factor(dB) – Pre-Amplifier Factor(dB) + 20log(D) – 104.8 – 2.15
3. Margin value = ERP – Limit value
4. The other ERP levels were very low against the limit.

RF Mode	TX LTE Band V-10MHz	Channel	CH 20525 : 836.5 MHz
Frequency Range	1GMHz ~ 18GHz		

Antenna Polarity & Test Distance : Horizontal at 3 m								
No	Frequency (MHz)	ERP (dBm)	Limit (dBm)	Margin (dB)	Antenna Height (m)	Table Angle (Degree)	Raw Value (dBuV)	Correction Factor (dB/m)
1	1673.00	-38.64	-13.00	-25.64	3.26 H	202	63.32	-101.96
Antenna Polarity & Test Distance : Vertical at 3 m								
No	Frequency (MHz)	ERP (dBm)	Limit (dBm)	Margin (dB)	Antenna Height (m)	Table Angle (Degree)	Raw Value (dBuV)	Correction Factor (dB/m)
1	1673.00	-38.07	-13.00	-25.07	1.32 V	76	63.89	-101.96

Remarks:

1. ERP(dBm) = Raw Value(dBuV) + Correction Factor(dB/m)
2. Correction Factor(dB/m) = Antenna Factor(dB/m) + Cable Factor(dB) – Pre-Amplifier Factor(dB) + 20log(D) – 104.8 – 2.15
3. Margin value = ERP – Limit value
4. The other ERP levels were very low against the limit.

RF Mode	TX LTE Band V-10MHz	Channel	CH 20600 : 844 MHz
Frequency Range	1GMHz ~ 18GHz		

Antenna Polarity & Test Distance : Horizontal at 3 m								
No	Frequency (MHz)	ERP (dBm)	Limit (dBm)	Margin (dB)	Antenna Height (m)	Table Angle (Degree)	Raw Value (dBuV)	Correction Factor (dB/m)
1	1688.00	-38.92	-13.00	-25.92	3.21 H	218	62.99	-101.91
Antenna Polarity & Test Distance : Vertical at 3 m								
No	Frequency (MHz)	ERP (dBm)	Limit (dBm)	Margin (dB)	Antenna Height (m)	Table Angle (Degree)	Raw Value (dBuV)	Correction Factor (dB/m)
1	1688.00	-37.62	-13.00	-24.62	1.33 V	92	64.29	-101.91

Remarks:

1. $ERP(dBm) = Raw\ Value(dBuV) + Correction\ Factor(dB/m)$
2. $Correction\ Factor(dB/m) = Antenna\ Factor(dB/m) + Cable\ Factor(dB) - Pre-Amplifier\ Factor(dB) + 20\log(D) - 104.8 - 2.15$
3. $Margin\ value = ERP - Limit\ value$
4. The other ERP levels were very low against the limit.

5 Pictures of Test Arrangements

Please refer to the attached file (Test Setup Photo).

Appendix – Information of the Testing Laboratories

We, Bureau Veritas Consumer Products Services (H.K.) Ltd., Taoyuan Branch, were founded in 1988 to provide our best service in EMC, Radio, Telecom and Safety consultation. Our laboratories are FCC recognized accredited test firms and accredited according to ISO/IEC 17025.

If you have any comments, please feel free to contact us at the following:

Lin Kou EMC/RF Lab

Tel: 886-2-26052180

Fax: 886-2-26051924

Hsin Chu EMC/RF/Telecom Lab

Tel: 886-3-6668565

Fax: 886-3-6668323

Hwa Ya EMC/RF/Safety Lab

Tel: 886-3-3183232

Fax: 886-3-3270892

Email: service.adt@tw.bureauveritas.com

Web Site: www.bureauveritas-adt.com

The address and road map of all our labs can be found in our web site also.

--- END ---