

## Variant FCC Test Report

**Report No.:** RFBFKV-WTW-P20100027

**FCC ID:** L6AITC100-1

**Test Model:** ITC100-1

**Received Date:** Oct. 06, 2020

**Test Date:** Jan. 15 ~ Jan. 21, 2021

**Issued Date:** Jan. 26, 2021

**Applicant:** BlackBerry Limited

**Address:** 2200 University Avenue East Waterloo, Ontario N2K 0A7 Canada

**Issued By:** Bureau Veritas Consumer Products Services (H.K.) Ltd., Taoyuan Branch  
Lin Kou Laboratories

**Lab Address:** No. 47-2, 14th Ling, Chia Pau Vil., Lin Kou Dist., New Taipei City, Taiwan

**Test Location:** No.19, Hwa Ya 2nd Rd., Wen Hwa Vil., Kwei Shan Dist., Taoyuan City  
33383, Taiwan

**FCC Registration /  
Designation Number:** 788550 / TW0003



This report is for your exclusive use. Any copying or replication of this report to or for any other person or entity, or use of our name or trademark, is permitted only with our prior written permission. This report sets forth our findings solely with respect to the test samples identified herein. The results set forth in this report are not indicative or representative of the quality or characteristics of the lot from which a test sample was taken or any similar or identical product unless specifically and expressly noted. Our report includes all of the tests requested by you and the results thereof based upon the information that you provided to us. You have 60 days from date of issuance of this report to notify us of any material error or omission caused by our negligence, provided, however, that such notice shall be in writing and shall specifically address the issue you wish to raise. A failure to raise such issue within the prescribed time shall constitute your unqualified acceptance of the completeness of this report, the tests conducted and the correctness of the report contents. Unless specific mention, the uncertainty of measurement has been explicitly taken into account to declare the compliance or non-compliance to the specification.

## Table of Contents

<b>Release Control Record</b> .....	<b>4</b>
<b>1 Certificate of Conformity</b> .....	<b>5</b>
<b>2 Summary of Test Results</b> .....	<b>6</b>
2.1 Measurement Uncertainty .....	6
2.2 Modification Record .....	6
<b>3 General Information</b> .....	<b>7</b>
3.1 General Description of EUT .....	7
3.2 Description of Test Modes .....	8
3.2.1 Test Mode Applicability and Tested Channel Detail .....	9
3.3 Duty Cycle of Test Signal .....	10
3.4 Description of Support Units .....	11
3.4.1 Configuration of System under Test .....	11
3.5 General Description of Applied Standards and References .....	11
<b>4 Test Types and Results</b> .....	<b>12</b>
4.1 Radiated Emission and Bandedge Measurement .....	12
4.1.1 Limits of Radiated Emission and Bandedge Measurement .....	12
4.1.2 Test Instruments .....	13
4.1.3 Test Procedures .....	14
4.1.4 Deviation from Test Standard .....	14
4.1.5 Test Set Up .....	15
4.1.6 EUT Operating Conditions .....	16
4.1.7 Test Results .....	17
4.2 6 dB Bandwidth Measurement .....	26
4.2.1 Limits of 6 dB Bandwidth Measurement .....	26
4.2.2 Test Setup .....	26
4.2.3 Test Instruments .....	26
4.2.4 Test Procedure .....	26
4.2.5 Deviation from Test Standard .....	26
4.2.6 EUT Operating Conditions .....	26
4.2.7 Test Results .....	27
4.3 Occupied Bandwidth Measurement .....	28
4.3.1 Test Setup .....	28
4.3.2 Test Instruments .....	28
4.3.3 Test Procedure .....	28
4.3.4 Deviation from Test Standard .....	28
4.3.5 EUT Operating Conditions .....	28
4.3.6 Test Results .....	29
4.4 Conducted Output Power Measurement .....	30
4.4.1 Limits of Conducted Output Power Measurement .....	30
4.4.2 Test Setup .....	30
4.4.3 Test Instruments .....	30
4.4.4 Test Procedures .....	30
4.4.5 Deviation from Test Standard .....	30
4.4.6 EUT Operating Conditions .....	30
4.4.7 Test Results .....	30
4.5 Power Spectral Density Measurement .....	31
4.5.1 Limits of Power Spectral Density Measurement .....	31
4.5.2 Test Setup .....	31
4.5.3 Test Instruments .....	31
4.5.4 Test Procedure .....	31
4.5.5 Deviation from Test Standard .....	31
4.5.6 EUT Operating Condition .....	31
4.5.7 Test Results .....	32

4.6	Conducted Out of Band Emission Measurement .....	33
4.6.1	Limits of Conducted Out of Band Emission Measurement.....	33
4.6.2	Test Setup.....	33
4.6.3	Test Instruments .....	33
4.6.4	Test Procedure .....	33
4.6.5	Deviation from Test Standard .....	33
4.6.6	EUT Operating Condition .....	33
4.6.7	Test Results .....	34
<b>5</b>	<b>Pictures of Test Arrangements.....</b>	<b>36</b>
	<b>Appendix – Information on the Testing Laboratories .....</b>	<b>37</b>



### Release Control Record

Issue No.	Description	Date Issued
RFBFKV-WTW-P20100027	Original Release	Jan. 26, 2021



## 2 Summary of Test Results

47 CFR FCC Part 15, Subpart C (Section 15.247)			
FCC Clause	Test Item	Result	Remarks
15.207	AC Power Conducted Emission	N/A	Without AC port of EUT
15.205 & 209	Radiated Emissions	Pass	Meet the requirement of limit. Minimum passing margin is -6.5 dB at 863.23 MHz.
15.247(d)	Band Edge Measurement	Pass	Meet the requirement of limit.
15.247(d)	Antenna Port Emission	Pass	Meet the requirement of limit.
15.247(a)(2)	6 dB Bandwidth	Pass	Meet the requirement of limit.
---	Occupied Bandwidth Measurement	Pass	Reference only
15.247(b)	Conducted Power	Pass	Meet the requirement of limit.
15.247(e)	Power Spectral Density	Pass	Meet the requirement of limit.
15.203	Antenna Requirement	Pass	No antenna connector is used.

N/A: Not Applicable

**Note:** Determining compliance based on the results of the compliance measurement, not taking into account measurement instrumentation uncertainty.

### 2.1 Measurement Uncertainty

Where relevant, the following measurement uncertainty levels have been estimated for tests performed on the EUT as specified in CISPR 16-4-2:

Measurement	Frequency	Expanded Uncertainty (k=2) ( $\pm$ )
Conducted Emissions at mains ports	150 kHz ~ 30 MHz	2.79 dB
Radiated Emissions up to 1 GHz	9 kHz ~ 30 MHz	3.04 dB
	30 MHz ~ 200 MHz	3.59 dB
	200 MHz ~ 1000 MHz	3.60 dB
Radiated Emissions above 1 GHz	1 GHz ~ 18 GHz	2.29 dB
	18 GHz ~ 40 GHz	2.29 dB

### 2.2 Modification Record

There were no modifications required for compliance.

### 3 General Information

#### 3.1 General Description of EUT

<b>Product</b>	Asset Tracker
<b>Brand</b>	BlackBerry
<b>Test Model</b>	ITC100-1
<b>Status of EUT</b>	Identical Prototype
<b>Power Supply Rating</b>	7.2 Vdc (Battery)
<b>Modulation Type</b>	2GFSK, OQPSK ,half-sine shaped OQPSK
<b>Transfer Rate</b>	Refer to Note as below
<b>Operating Frequency</b>	904 ~ 926 MHz
<b>Number of Channel</b>	23
<b>Output Power</b>	28.119 mW
<b>Antenna Type</b>	Monopole Antenna with -5.4 dBi gain
<b>Antenna Connector</b>	N/A
<b>Accessory Device</b>	Refer to Note as below
<b>Data Cable Supplied</b>	N/A

Note:

1. This report is prepared for FCC class II permissive change. This report is issued as a supplementary report to BV CPS report no. RF180904C01. The difference compared with original report is adding more radio configurations by SW and changing Operating Frequency (904 ~ 926 MHz), therefore the EUT is re-tested in this report.

	Transfer Rate
Original Rate	50 kbps, 150 kbps, 500 kbps
Add Rate	32 kbps, 40 kbps, 48 kbps, 50 kbps, 56 kbps, 75 kbps, 80bps, 100bps, 150bps, 250bps, 500 kbps, 800 kbps,

2. The EUT contains following accessory devices.

Product	Brand	Model	Description
Battery 1	BlackBerry	BAT-63320-001	7.2 Vdc, 38 Ah, Non-rechargeable Manufacturer: EVE Energy Co., Ltd.
Battery 2	BlackBerry	BAT-63318-001	7.2 Vdc, 19 Ah, Non-rechargeable Manufacturer: EVE Energy Co., Ltd.

- Above batteries had been pre-tested, and the worst case was found when EUT with Battery 1. Therefore, only this configuration was as a representative for final test.
3. The above Antenna information is declared by manufacturer and for more detailed features description, please refer to the manufacturer's specifications, the laboratory shall not be held responsible.
  4. The above EUT information is declared by manufacturer and for more detailed features description, please refers to the manufacturer's specifications or user's manual.

### 3.2 Description of Test Modes

23 channels are provided to this EUT:

Channel	Freq. (MHz)	Channel	Freq. (MHz)	Channel	Freq. (MHz)
1	904	10	913	19	922
2	905	11	914	20	923
3	906	12	915	21	924
4	907	13	916	22	925
5	908	14	917	23	926
6	909	15	918		
7	910	16	919		
8	911	17	920		
9	912	18	921		



### 3.2.1 Test Mode Applicability and Tested Channel Detail

EUT Configure Mode	Applicable To				Description
	RE $\geq$ 1G	RE $<$ 1G	PLC	APCM	
-	√	√	-	√	-

Where **RE $\geq$ 1G**: Radiated Emission above 1 GHz      **RE $<$ 1G**: Radiated Emission below 1 GHz  
**PLC**: Power Line Conducted Emission      **APCM**: Antenna Port Conducted Measurement

**Note:** 1. The EUT had been pre-tested on the positioned of each 3 axis. The worst case was found when positioned on **X-plane**.  
2. "-" means no effect.  
3. For radiated emission test, pre-tested 2GFSK, 4GFSK modulation type and found 2GFSK was the worse, therefore chosen for the final test and presented in the test report.

#### **Radiated Emission Test (Above 1 GHz):**

- Pre-Scan has been conducted to determine the worst-case mode from all possible combinations between available modulations, data rates and antenna ports (if EUT with antenna diversity architecture).
- Following channel(s) was (were) selected for the final test as listed below.

EUT Configure Mode	Available Channel	Tested Channel	Modulation Type	Data Rate (kbps)
-	1 to 23	1, 12, 23	2GFSK	500

#### **Radiated Emission Band Edge Measurement:**

- Pre-Scan has been conducted to determine the worst-case mode from all possible combinations between available modulations, data rates and antenna ports (if EUT with antenna diversity architecture).
- Following channel(s) was (were) selected for the final test as listed below.

EUT Configure Mode	Available Channel	Tested Channel	Modulation Type	Data Rate (kbps)
-	1 to 23	1, 23	2GFSK	500

#### **Radiated Emission Test (Below 1 GHz):**

- Pre-Scan has been conducted to determine the worst-case mode from all possible combinations between available modulations, data rates and antenna ports (if EUT with antenna diversity architecture).
- Following channel(s) was (were) selected for the final test as listed below.

EUT Configure Mode	Available Channel	Tested Channel	Modulation Type	Data Rate (kbps)
-	1 to 23	12	2GFSK	500

**Antenna Port Conducted Measurement:**

- This item includes all test value of each mode, but only includes spectrum plot of worst value of each mode.
- Pre-Scan has been conducted to determine the worst-case mode from all possible combinations between available modulations, data rates and antenna ports (if EUT with antenna diversity architecture).
- Following channel(s) was (were) selected for the final test as listed below.

EUT Configure Mode	Available Channel	Tested Channel	Modulation Type	Data Rate (kbps)
-	1 to 23	1, 12, 23	2GFSK	500

**Test Condition:**

Applicable To	Environmental Conditions	Input Power	Tested by
RE≥1G	25 deg. C, 65 % RH	7.2 Vdc	Rex Wang
RE<1G	25 deg. C, 65 % RH	7.2 Vdc	Rex Wang
APCM	25 deg. C, 65 % RH	7.2 Vdc	Frank FL Liu

**3.3 Duty Cycle of Test Signal**

Duty cycle of test signal is 100 %, duty factor is not required.

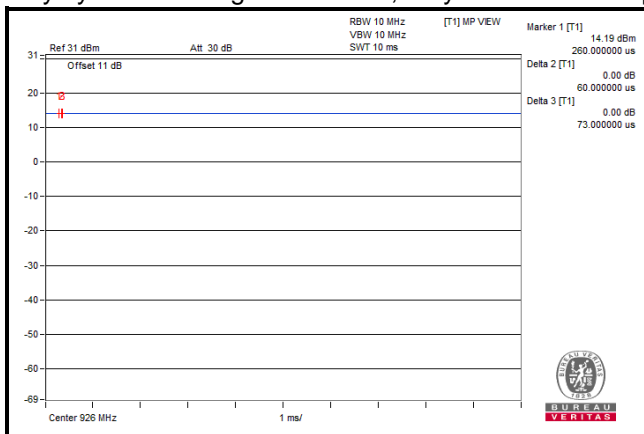

### 3.4 Description of Support Units

The EUT has been tested as an independent unit together with other necessary accessories or support units.

#### 3.4.1 Configuration of System under Test

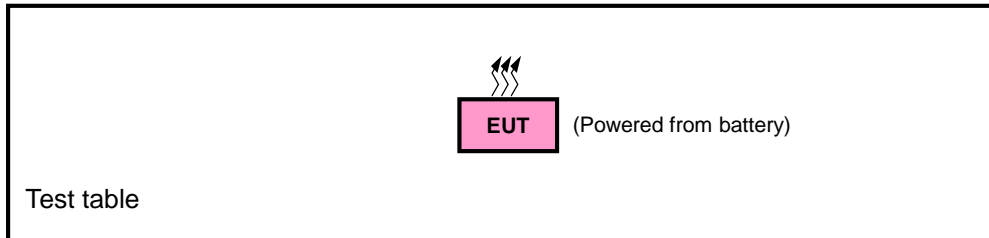

### 3.5 General Description of Applied Standards and References

The EUT is a RF Product. According to the specifications of the manufacturer, it must comply with the requirements of the following standards and references:

#### Test Standard:

##### **FCC Part 15, Subpart C (15.247)**

ANSI C63.10-2013

All test items have been performed and recorded as per the above standards.

#### References Test Guidance:

##### **KDB 558074 D01 Meas Guidance v05r02**

All test items have been performed as a reference to the above KDB test guidance.

## 4 Test Types and Results

### 4.1 Radiated Emission and Bandedge Measurement

#### 4.1.1 Limits of Radiated Emission and Bandedge Measurement

Radiated emissions which fall in the restricted bands must comply with the radiated emission limits specified as below table. Other emissions shall be at least 30 dB below the highest level of the desired power:

Frequencies (MHz)	Field Strength (microvolts/meter)	Measurement Distance (meters)
0.009 ~ 0.490	2400/F (kHz)	300
0.490 ~ 1.705	24000/F (kHz)	30
1.705 ~ 30.0	30	30
30 ~ 88	100	3
88 ~ 216	150	3
216 ~ 960	200	3
Above 960	500	3

**Note:**

1. The lower limit shall apply at the transition frequencies.
2. Emission level (dBuV/m) = 20 log Emission level (uV/m).
3. For frequencies above 1000 MHz, the field strength limits are based on average detector, however, the peak field strength of any emission shall not exceed the maximum permitted average limits, specified above by more than 20 dB under any condition of modulation.

#### 4.1.2 Test Instruments

Description & Manufacturer	Model No.	Serial No.	Date of Calibration	Due Date of Calibration
Test Receiver KEYSIGHT	N9038A	MY55420137	Apr. 16, 2020	Apr. 15, 2021
Spectrum Analyzer ROHDE & SCHWARZ	FSV40	100979	Mar. 18, 2020	Mar. 17, 2021
Spectrum Analyzer ROHDE & SCHWARZ	FSP40	100039	Jun. 12, 2020	Jun. 11, 2021
BILOG Antenna SCHWARZBECK	VULB9168	9168-160	Nov. 06, 2020	Nov. 05, 2021
HORN Antenna SCHWARZBECK	BBHA 9120 D	9120D-1169	Nov. 22, 2020	Nov. 21, 2021
HORN Antenna SCHWARZBECK	BBHA 9170	BBHA9170241	Nov. 22, 2020	Nov. 21, 2021
Loop Antenna TESEQ	HLA 6121	45745	Jul. 06, 2020	Jul. 05, 2021
Preamplifier Agilent (Below 1GHz)	8447D	2944A10638	Jun. 08, 2020	Jun. 07, 2021
Preamplifier Agilent (Above 1GHz)	8449B	3008A02367	Feb. 18, 2020	Feb. 17, 2021
RF signal cable HUBER+SUHNER&EMCI	SUCOFLEX 104 & EMC104-SM- SM8000	CABLE-CH9-02 (248780+171006)	Jan. 18, 2020	Jan. 17, 2021
			Jan. 16, 2021	Jan. 15, 2022
RF signal cable HUBER+SUHNER	SUCOFLEX 104	CABLE-CH9- (250795/4)	Jan. 18, 2020	Jan. 17, 2021
			Jan. 16, 2021	Jan. 15, 2022
RF signal cable Woken	8D-FB	Cable-CH9-01	Jun. 08, 2020	Jun. 07, 2021
Software BV ADT	ADT_Radiated_ V7.6.15.9.5	NA	NA	NA
Antenna Tower EMCO	2070/2080	512.835.4684	NA	NA
Turn Table EMCO	2087-2.03	NA	NA	NA
Antenna Tower & Turn BV ADT	AT100	AT93021705	NA	NA
Turn Table BV ADT	TT100	TT93021705	NA	NA
Turn Table Controller BV ADT	SC100	SC93021705	NA	NA
Boresight Antenna Fixture	FBA-01	FBA-SIP01	NA	NA
USB Wideband Power Sensor KEYSIGHT	U2021XA	MY55050005/MY 55190004/MY551 90007/MY552100 05	Jul. 13, 2020	Jul. 12, 2021

Note: 1. The calibration interval of the above test instruments is 12 months and the calibrations are traceable to NML/ROC and NIST/USA.

2. The test was performed in HwaYa Chamber 9.

#### 4.1.3 Test Procedures

##### **For Radiated Emission below 30 MHz**

- a. The EUT was placed on the top of a rotating table 0.8 meters above the ground at a 3 meter chamber room. The table was rotated 360 degrees to determine the position of the highest radiation.
- b. The EUT was set 3 meters away from the interference-receiving antenna, which was mounted on the top of a variable-height antenna tower.
- c. Parallel, perpendicular, and ground-parallel orientations of the antenna are set to make the measurement.
- d. For each suspected emission, the EUT was arranged to its worst case and the rotatable table was turned from 0 degrees to 360 degrees to find the maximum reading.
- e. The test-receiver system was set to Quasi-Peak Detect Function and Specified Bandwidth with Maximum Hold Mode.

##### **Note:**

1. The resolution bandwidth and video bandwidth of test receiver/spectrum analyzer is 9 kHz at frequency below 30 MHz.

##### **For Radiated Emission above 30 MHz**

- a. The EUT was placed on the top of a rotating table 0.8 meters (for 30 MHz ~ 1 GHz) / 1.5 meters (for above 1 GHz) above the ground at 3 meter chamber room for test. The table was rotated 360 degrees to determine the position of the highest radiation.
- b. The EUT was set 3 meters away from the interference-receiving antenna, which was mounted on the top of a variable-height antenna tower.
- c. The height of antenna is varied from one meter to four meters above the ground to determine the maximum value of the field strength. Both horizontal and vertical polarizations of the antenna are set to make the measurement.
- d. For each suspected emission, the EUT was arranged to its worst case and then the antenna was tuned to heights from 1 meter to 4 meters and the rotatable table was turned from 0 degrees to 360 degrees to find the maximum reading.
- e. The test-receiver system was set to quasi-peak detect function and specified bandwidth with maximum hold mode when the test frequency is below 1 GHz.
- f. The test-receiver system was set to peak and average detected function and specified bandwidth with maximum hold mode when the test frequency is above 1 GHz. If the peak reading value also meets average limit, measurement with the average detector is unnecessary.

##### **Note:**

1. The resolution bandwidth and video bandwidth of test receiver/spectrum analyzer is 120 kHz for Quasi-peak detection (QP) or Peak detection (PK) at frequency below 1 GHz.
2. The resolution bandwidth of test receiver/spectrum analyzer is 1 MHz and the video bandwidth is 3 MHz for Peak detection (PK) at frequency above 1 GHz.
3. The resolution bandwidth of test receiver/spectrum analyzer is 1 MHz and the video bandwidth is  $\geq 1/T$  (Duty cycle < 98 %) or 10 Hz (Duty cycle  $\geq 98$  %) for Average detection (AV) at frequency above 1 GHz. (RBW = 1 MHz, VBW = 10 Hz)
4. All modes of operation were investigated and the worst-case emissions are reported.

#### 4.1.4 Deviation from Test Standard

No deviation.

4.1.5 Test Set Up

<Radiated Emission below 30 MHz>

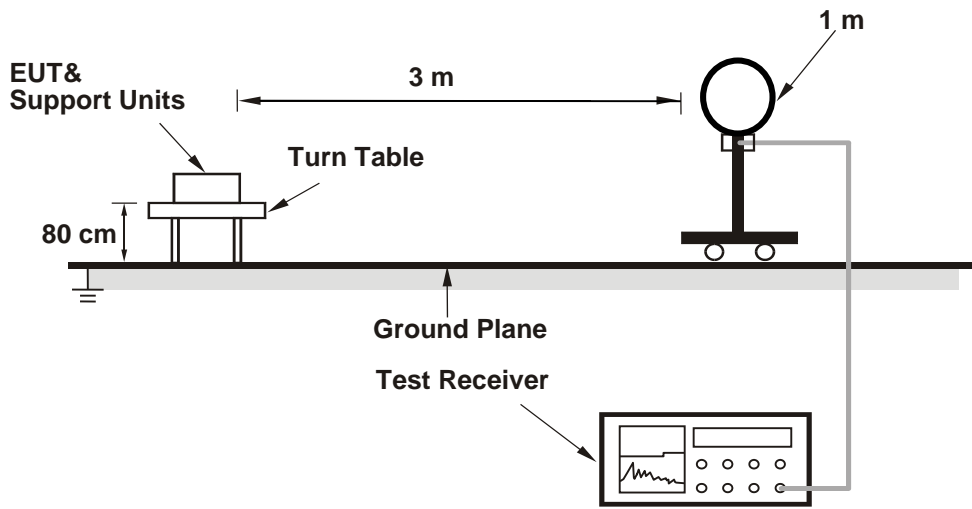

<Radiated Emission 30 MHz to 1 GHz>

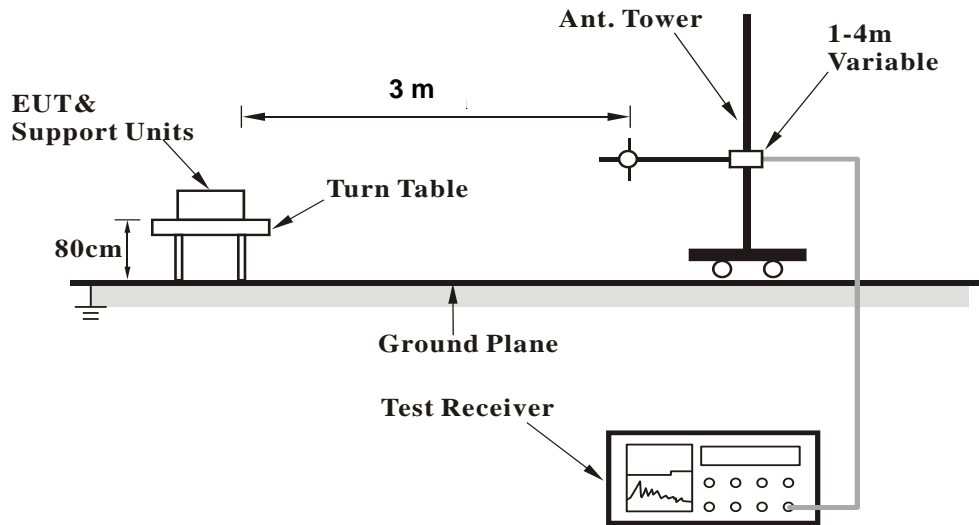

### <Radiated Emission above 1 GHz>

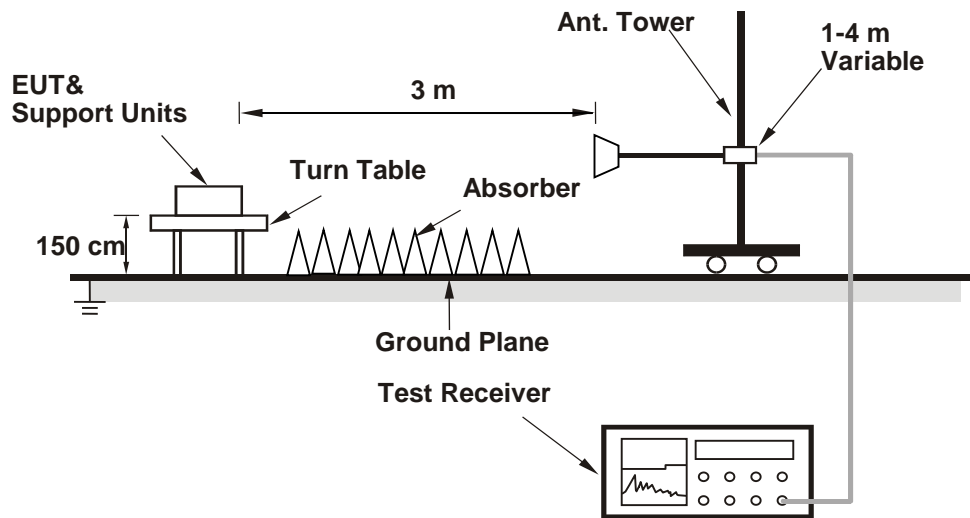

For the actual test configuration, please refer to the attached file (Test Setup Photo).

#### 4.1.6 EUT Operating Conditions

- a. Placed the EUT on the testing table.
- b. Set the EUT under transmission condition continuously at specific channel frequency.



4.1.7 Test Results

**Above 1 GHz Data:**

EUT Test Condition		Measurement Detail	
Channel	Channel 1	Frequency Range	1 GHz ~ 10 GHz
Input Power	7.2 Vdc	Detector Function	Peak (PK) Average (AV)
Environmental Conditions	22 deg. C, 68 % RH	Tested By	Rex Wang

Antenna Polarity & Test Distance : Horizontal at 3 m								
No	Frequency (MHz)	Emission Level (dBuV/m)	Limit (dBuV/m)	Margin (dB)	Antenna Height (m)	Table Angle (Degree)	Raw Value (dBuV)	Correction Factor (dB/m)
1	1808.00	41.0 PK	74.0	-33.0	1.64 H	167	46.6	-5.6
2	1808.00	29.8 AV	54.0	-24.2	1.64 H	167	35.4	-5.6
Antenna Polarity & Test Distance : Vertical at 3 m								
No	Frequency (MHz)	Emission Level (dBuV/m)	Limit (dBuV/m)	Margin (dB)	Antenna Height (m)	Table Angle (Degree)	Raw Value (dBuV)	Correction Factor (dB/m)
1	1808.00	43.5 PK	74.0	-30.5	2.80 V	13	49.1	-5.6
2	1808.00	25.9 AV	54.0	-28.1	2.80 V	13	31.5	-5.6

Remarks:

- Emission Level = Read Level + Antenna Factor + Cable Loss - Preamp Factor  
Margin value = Emission level – Limit value
- The emission levels of other frequencies were very low against the limit.

EUT Test Condition		Measurement Detail	
Channel	Channel 12	Frequency Range	1 GHz ~ 10 GHz
Input Power	7.2 Vdc	Detector Function	Peak (PK) Average (AV)
Environmental Conditions	22 deg. C, 68 % RH	Tested By	Rex Wang

Antenna Polarity & Test Distance : Horizontal at 3 m								
No	Frequency (MHz)	Emission Level (dBuV/m)	Limit (dBuV/m)	Margin (dB)	Antenna Height (m)	Table Angle (Degree)	Raw Value (dBuV)	Correction Factor (dB/m)
1	1830.00	41.0 PK	74.0	-33.0	1.42 H	183	46.4	-5.4
2	1830.00	30.0 AV	54.0	-24.0	1.42 H	183	35.4	-5.4
Antenna Polarity & Test Distance : Vertical at 3 m								
No	Frequency (MHz)	Emission Level (dBuV/m)	Limit (dBuV/m)	Margin (dB)	Antenna Height (m)	Table Angle (Degree)	Raw Value (dBuV)	Correction Factor (dB/m)
1	1830.00	39.6 PK	74.0	-34.4	2.92 V	4	45.0	-5.4
2	1830.00	24.5 AV	54.0	-29.5	2.92 V	4	29.9	-5.4

Remarks:

- Emission Level = Read Level + Antenna Factor + Cable Loss - Preamp Factor  
Margin value = Emission level – Limit value
- The emission levels of other frequencies were very low against the limit.

EUT Test Condition		Measurement Detail	
Channel	Channel 23	Frequency Range	1 GHz ~ 10 GHz
Input Power	7.2 Vdc	Detector Function	Peak (PK) Average (AV)
Environmental Conditions	22 deg. C, 68 % RH	Tested By	Rex Wang

Antenna Polarity & Test Distance : Horizontal at 3 m								
No	Frequency (MHz)	Emission Level (dBuV/m)	Limit (dBuV/m)	Margin (dB)	Antenna Height (m)	Table Angle (Degree)	Raw Value (dBuV)	Correction Factor (dB/m)
1	1852.00	40.5 PK	74.0	-33.5	1.50 H	170	45.8	-5.3
2	1852.00	29.2 AV	54.0	-24.8	1.50 H	170	34.5	-5.3
Antenna Polarity & Test Distance : Vertical at 3 m								
No	Frequency (MHz)	Emission Level (dBuV/m)	Limit (dBuV/m)	Margin (dB)	Antenna Height (m)	Table Angle (Degree)	Raw Value (dBuV)	Correction Factor (dB/m)
1	1852.00	40.2 PK	74.0	-33.8	2.74 V	8	45.5	-5.3
2	1852.00	24.6 AV	54.0	-29.4	2.74 V	8	29.9	-5.3

Remarks:

- Emission Level = Read Level + Antenna Factor + Cable Loss - Preamp Factor  
Margin value = Emission level – Limit value
- The emission levels of other frequencies were very low against the limit.

**9 kHz ~ 30 MHz Data:**

The amplitude of spurious emissions attenuated more than 20 dB below the permissible value is not required to be report.

**30 MHz ~ 1 GHz Data:**

**<Spurious Emissions Measurement>**

EUT Test Condition		Measurement Detail	
Channel	Channel 12	Frequency Range	30 MHz ~ 1 GHz
Input Power	7.2 Vdc	Detector Function	Peak (PK) Quasi-peak (QP)
Environmental Conditions	22 deg. C, 68 % RH	Tested By	Rex Wang

**Horizontal**

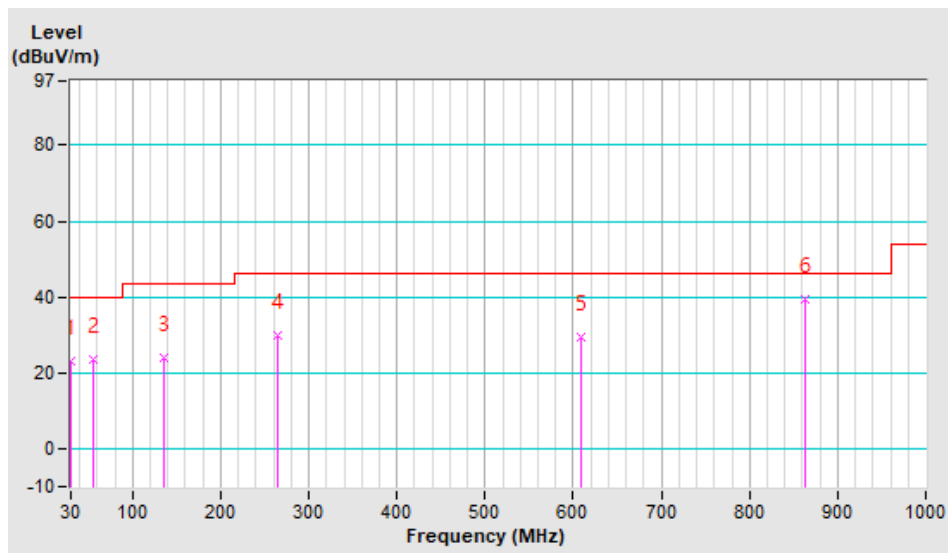

**Vertical**

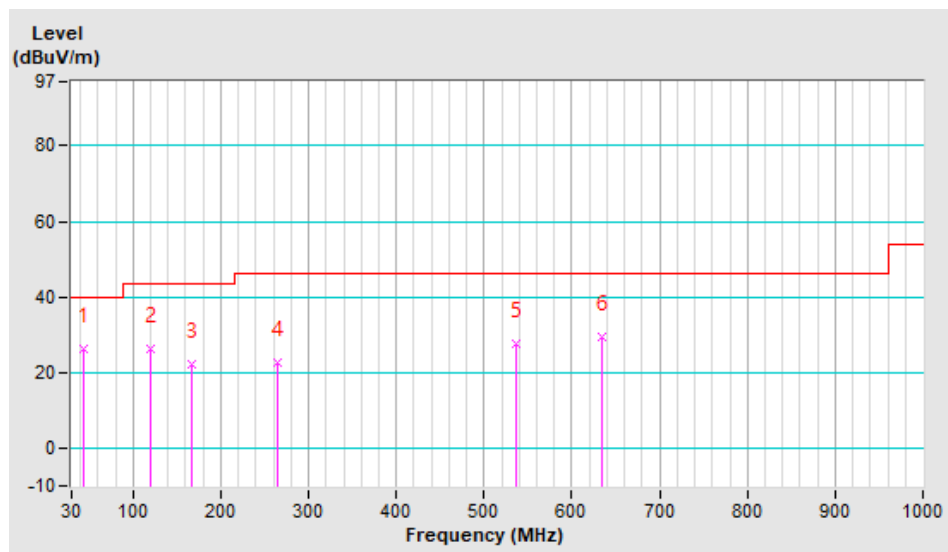

Antenna Polarity & Test Distance : Horizontal at 3 m								
No	Frequency (MHz)	Emission Level (dBuV/m)	Limit (dBuV/m)	Margin (dB)	Antenna Height (m)	Table Angle (Degree)	Raw Value (dBuV)	Correction Factor (dB/m)
1	30.00	23.1 QP	40.0	-16.9	1.25 H	86	33.4	-10.3
2	56.19	23.6 QP	40.0	-16.4	2.00 H	53	32.6	-9.0
3	135.73	24.1 QP	43.5	-19.4	1.00 H	5	33.4	-9.3
4	263.77	30.0 QP	46.0	-16.0	1.50 H	5	38.0	-8.0
5	609.09	29.4 QP	46.0	-16.6	1.25 H	256	29.7	-0.3
6	863.23	39.5 QP	46.0	-6.5	1.00 H	179	35.4	4.1

Antenna Polarity & Test Distance : Vertical at 3 m								
No	Frequency (MHz)	Emission Level (dBuV/m)	Limit (dBuV/m)	Margin (dB)	Antenna Height (m)	Table Angle (Degree)	Raw Value (dBuV)	Correction Factor (dB/m)
1	43.58	26.2 QP	40.0	-13.8	1.50 V	303	35.5	-9.3
2	120.21	26.2 QP	43.5	-17.3	2.00 V	218	37.0	-10.8
3	167.74	22.0 QP	43.5	-21.5	1.50 V	247	30.5	-8.5
4	263.77	22.5 QP	46.0	-23.5	1.00 V	47	30.5	-8.0
5	536.34	27.5 QP	46.0	-18.5	1.25 V	99	29.6	-2.1
6	633.34	29.3 QP	46.0	-16.7	1.00 V	356	29.1	0.2

Remarks:

- Emission Level = Read Level + Antenna Factor + Cable Loss - Preamp Factor  
Margin value = Emission level – Limit value
- The emission levels of other frequencies were very low against the limit.

### <Band Edge Measurement>

EUT Test Condition		Measurement Detail	
Channel	Channel 1	Frequency Range	902 MHz ~ 928 MHz
Input Power	7.2 Vdc	Detector Function	Quasi-peak (QP)
Environmental Conditions	22 deg. C, 68 % RH	Tested By	Rex Wang

#### Horizontal

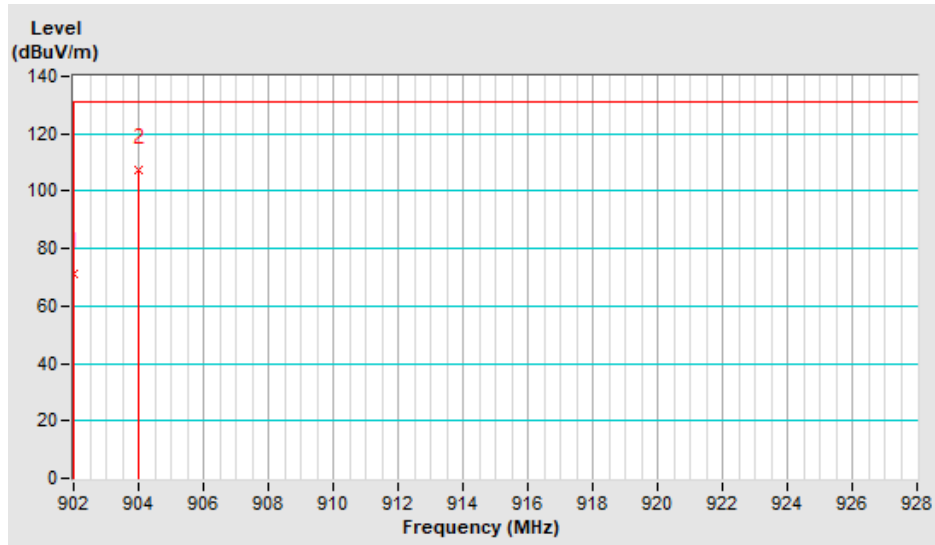

#### Vertical

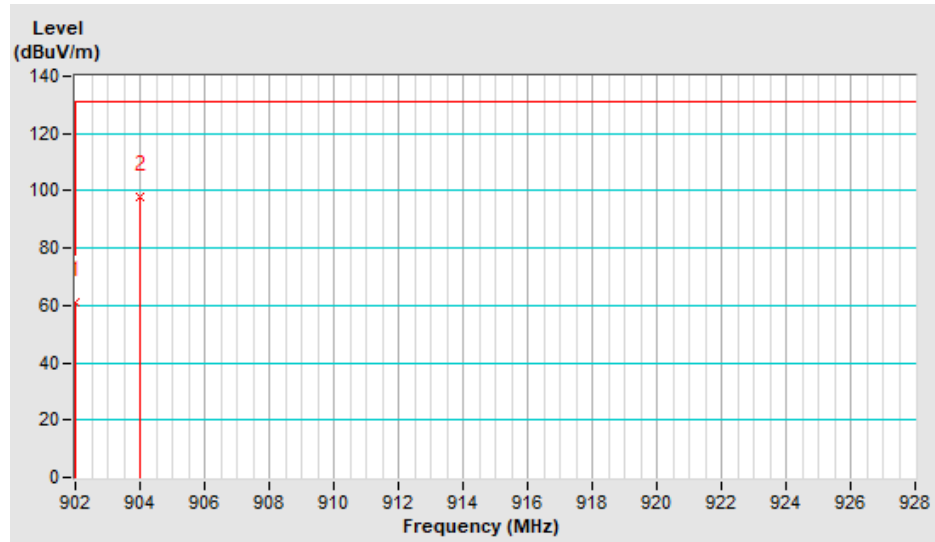

Antenna Polarity & Test Distance : Horizontal at 3 m								
No	Frequency (MHz)	Emission Level (dBuV/m)	Limit (dBuV/m)	Margin (dB)	Antenna Height (m)	Table Angle (Degree)	Raw Value (dBuV)	Correction Factor (dB/m)
1	902.00	71.1 QP	87.2	-16.1	1.49 H	301	38.2	32.9
2	904.00	107.2 QP			1.49 H	301	74.2	33.0
Antenna Polarity & Test Distance : Vertical at 3m								
No	Frequency (MHz)	Emission Level (dBuV/m)	Limit (dBuV/m)	Margin (dB)	Antenna Height (m)	Table Angle (Degree)	Raw Value (dBuV)	Correction Factor (dB/m)
1	902.00	61.1 QP	77.8	-16.7	1.43 V	51	28.2	32.9
2	904.00	97.8 QP			1.43 V	51	64.8	33.0

Remarks:

- Emission Level = Read Level + Antenna Factor + Cable Loss - Preamp Factor  
Margin value = Emission level – Limit value
- The emission levels of other frequencies were very low against the limit.
- \*: Out of Restricted Band

EUT Test Condition		Measurement Detail	
Channel	Channel 23	Frequency Range	902 MHz ~ 928 MHz
Input Power	7.2 Vdc	Detector Function	Quasi-peak (QP)
Environmental Conditions	22 deg. C, 68 % RH	Tested By	Rex Wang

### Horizontal

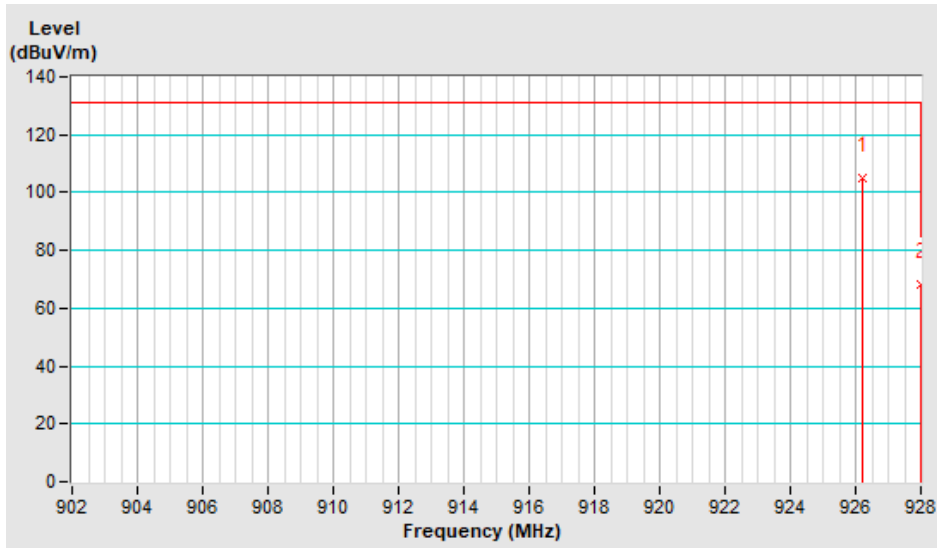

### Vertical

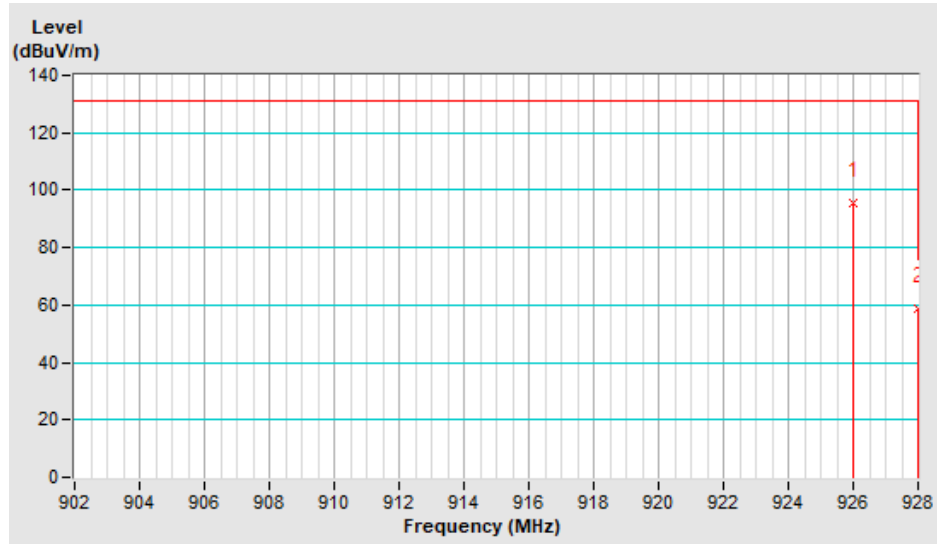



Antenna Polarity & Test Distance : Horizontal at 3 m								
No	Frequency (MHz)	Emission Level (dBuV/m)	Limit (dBuV/m)	Margin (dB)	Antenna Height (m)	Table Angle (Degree)	Raw Value (dBuV)	Correction Factor (dB/m)
1	926.00	104.8 QP			1.42 H	299	71.4	33.4
2	928.00	68.3 QP	84.8	-16.5	1.42 H	299	34.9	33.4
Antenna Polarity & Test Distance : Vertical at 3m								
No	Frequency (MHz)	Emission Level (dBuV/m)	Limit (dBuV/m)	Margin (dB)	Antenna Height (m)	Table Angle (Degree)	Raw Value (dBuV)	Correction Factor (dB/m)
1	926.00	95.8 QP			1.42 V	46	62.5	33.3
2	928.00	58.7 QP	75.8	-17.1	1.42 V	46	25.3	33.4

Remarks:

- Emission Level = Read Level + Antenna Factor + Cable Loss - Preamp Factor  
Margin value = Emission level – Limit value
- The emission levels of other frequencies were very low against the limit.
- \*: Out of Restricted Band

## 4.2 6 dB Bandwidth Measurement

### 4.2.1 Limits of 6 dB Bandwidth Measurement

The minimum of 6 dB Bandwidth Measurement is 0.5 MHz.

### 4.2.2 Test Setup

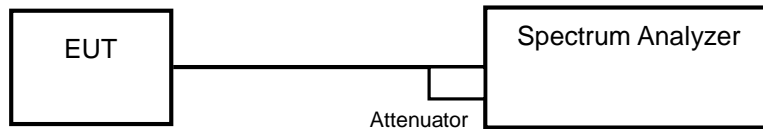

### 4.2.3 Test Instruments

Refer to section 4.1.2 to get information of above instrument.

### 4.2.4 Test Procedure

- Set resolution bandwidth (RBW) = 100 kHz
- Set the video bandwidth (VBW)  $\geq 3 \times$  RBW, Detector = Peak.
- Trace mode = max hold.
- Sweep = auto couple.
- Measure the maximum width of the emission that is constrained by the frequencies associated with the two amplitude points (upper and lower) that are attenuated by 6 dB relative to the maximum level measured in the fundamental emission

### 4.2.5 Deviation from Test Standard

No deviation.

### 4.2.6 EUT Operating Conditions

The software provided by client to enable the EUT under transmission condition continuously at lowest, middle and highest channel frequencies individually.

4.2.7 Test Results

Channel	Frequency (MHz)	6 dB Bandwidth (MHz)	Minimum Limit (MHz)	Pass / Fail
1	904	1.64	0.5	Pass
12	915	1.64	0.5	Pass
23	926	1.62	0.5	Pass

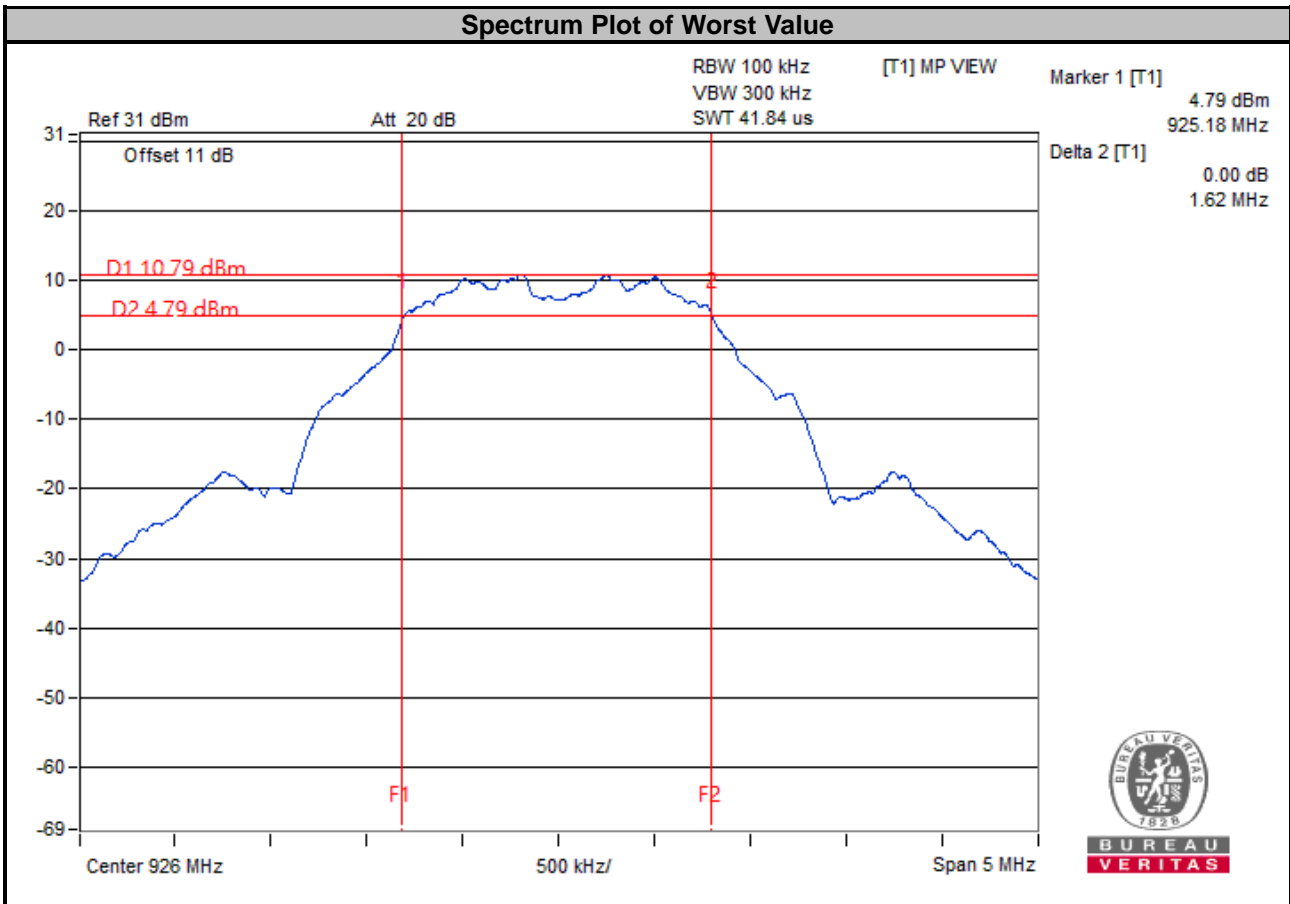

### 4.3 Occupied Bandwidth Measurement

#### 4.3.1 Test Setup

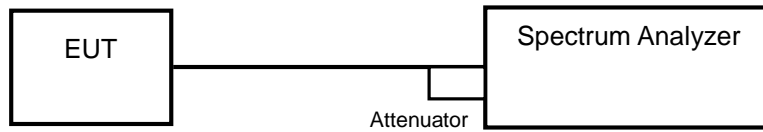

#### 4.3.2 Test Instruments

Refer to section 4.1.2 to get information of above instrument.

#### 4.3.3 Test Procedure

The transmitter output was connected to the spectrum analyzer through an attenuator. The bandwidth of the fundamental frequency was measured by spectrum analyzer with resolution bandwidth in the range of 1 % to 5 % of the anticipated emission bandwidth, and a video bandwidth at least 3x the resolution bandwidth and set the detector to SAMPLE. The width of a frequency band such that, below the lower and above the upper frequency limits, the mean powers emitted are each equal to a specified percentage 0.5 % of the total mean power of a given emission.

#### 4.3.4 Deviation from Test Standard

No deviation.

#### 4.3.5 EUT Operating Conditions

The software provided by client to enable the EUT under transmission condition continuously at lowest, middle and highest channel frequencies individually.

### 4.3.6 Test Results

Channel	Frequency (MHz)	Occupied Bandwidth (MHz)	Pass / Fail
1	904	2.09	Pass
12	915	2.09	Pass
23	926	2.08	Pass

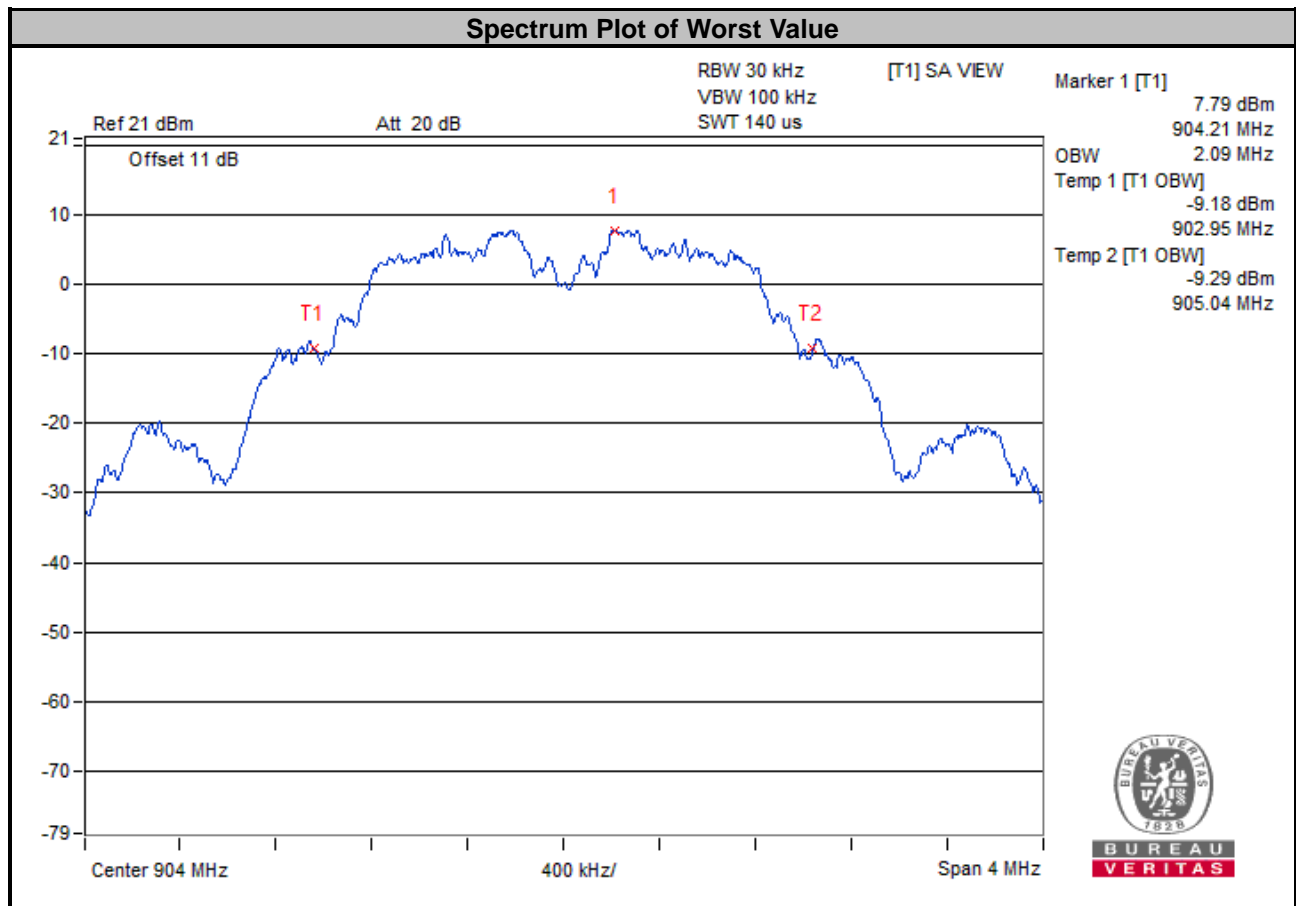

#### 4.4 Conducted Output Power Measurement

##### 4.4.1 Limits of Conducted Output Power Measurement

For systems using digital modulation in the 902-928 MHz bands: 1 Watt (30 dBm)

##### 4.4.2 Test Setup

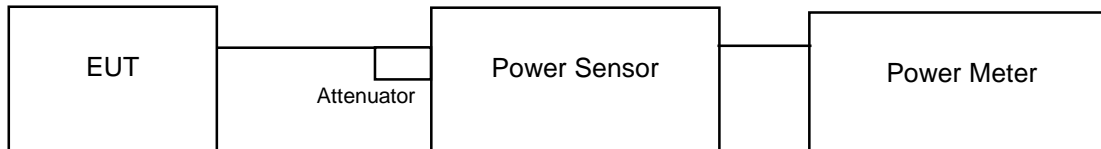

##### 4.4.3 Test Instruments

Refer to section 4.1.2 to get information of above instrument.

##### 4.4.4 Test Procedures

A peak power sensor was used on the output port of the EUT. A power meter was used to read the response of the peak power sensor. Record the power level.

Average power sensor was used to perform output power measurement, trigger and gating function of wide band power meter is enabled to measure max output power of TX on burst. Duty factor is not added to measured value.

##### 4.4.5 Deviation from Test Standard

No deviation.

##### 4.4.6 EUT Operating Conditions

The software provided by client to enable the EUT under transmission condition continuously at lowest, middle and highest channel frequencies individually.

##### 4.4.7 Test Results

Channel	Frequency (MHz)	Peak Power (mW)	Peak Power (dBm)	Average Power (mW)	Average Power (dBm)	Limit (dBm)	Pass / Fail
1	904	28.119	14.49	27.479	14.39	30	Pass
12	915	20.512	13.12	19.815	12.97	30	Pass
23	926	27.416	14.38	26.792	14.28	30	Pass

## 4.5 Power Spectral Density Measurement

### 4.5.1 Limits of Power Spectral Density Measurement

The Maximum of Power Spectral Density Measurement is 8 dBm in any 3 kHz band during any time interval of continuous transmission.

### 4.5.2 Test Setup

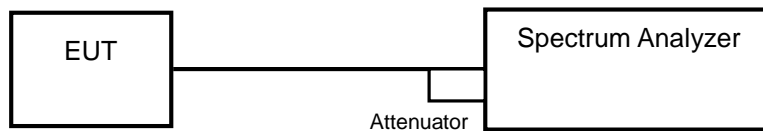

### 4.5.3 Test Instruments

Refer to section 4.1.2 to get information of above instrument.

### 4.5.4 Test Procedure

- a) Set instrument center frequency to DTS channel center frequency.
- b) Set span to at least 1.5 times the OBW.
- c) Set RBW to:  $3 \text{ kHz} \leq \text{RBW} \leq 100 \text{ kHz}$ .
- d) Set VBW  $\geq 3 \times \text{RBW}$ .
- e) Detector = power averaging (RMS) or sample detector (when RMS not available).
- f) Ensure that the number of measurement points in the sweep  $\geq 2 \times \text{span}/\text{RBW}$ .
- g) Sweep time = auto couple.
- h) Employ trace averaging (RMS) mode over a minimum of 100 traces.
- i) Use the peak marker function to determine the maximum amplitude level.

### 4.5.5 Deviation from Test Standard

No deviation.

### 4.5.6 EUT Operating Condition

The software provided by client to enable the EUT under transmission condition continuously at lowest, middle and highest channel frequencies individually.

4.5.7 Test Results

Channel	Frequency (MHz)	PSD (dBm/3 kHz)	Limit (dBm/3 kHz)	Pass / Fail
1	904	-0.32	8	Pass
12	915	-0.30	8	Pass
23	926	-1.07	8	Pass

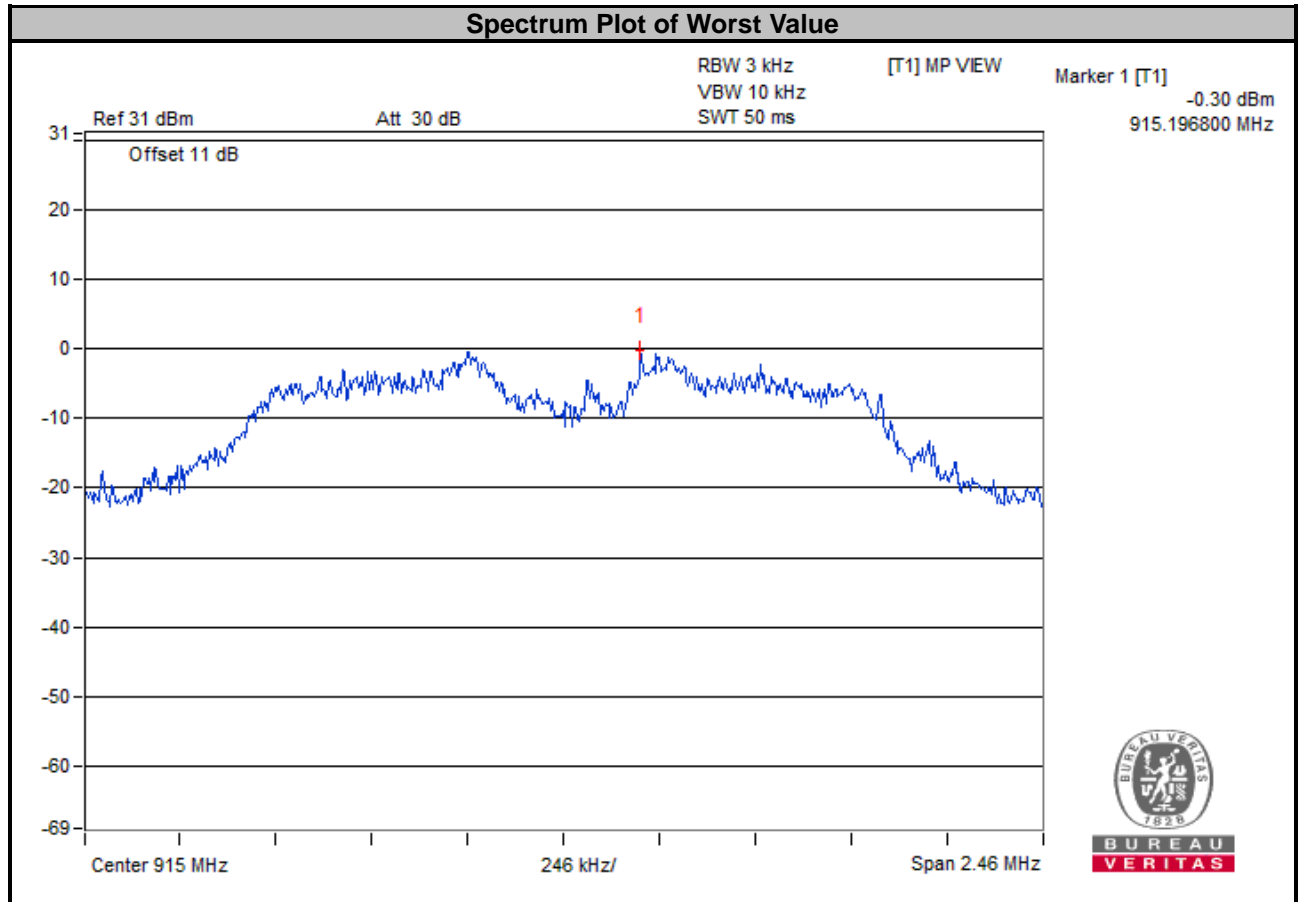



## 4.6 Conducted Out of Band Emission Measurement

### 4.6.1 Limits of Conducted Out of Band Emission Measurement

Below  $-20$  dB of the highest emission level of operating band (in 100 kHz Resolution Bandwidth).

### 4.6.2 Test Setup

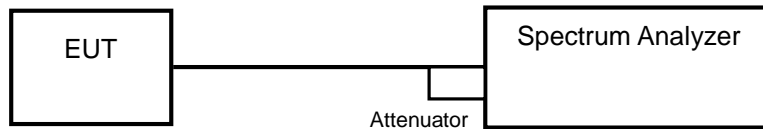

### 4.6.3 Test Instruments

Refer to section 4.1.2 to get information of above instrument.

### 4.6.4 Test Procedure

#### MEASUREMENT PROCEDURE REF

1. Set the RBW = 100 kHz.
2. Set the VBW  $\geq$  300 kHz.
3. Detector = peak.
4. Sweep time = auto couple.
5. Trace mode = max hold.
6. Allow trace to fully stabilize.
7. Use the peak marker function to determine the maximum power level in any 100 kHz band segment within the fundamental EBW.

#### MEASUREMENT PROCEDURE OOBE

1. Set RBW = 100 kHz.
2. Set VBW  $\geq$  300 kHz.
3. Detector = peak.
4. Sweep = auto couple.
5. Trace Mode = max hold.
6. Allow trace to fully stabilize.
7. Use the peak marker function to determine the maximum amplitude level.

### 4.6.5 Deviation from Test Standard

No deviation.

### 4.6.6 EUT Operating Condition

The software provided by client to enable the EUT under transmission condition continuously at lowest, middle and highest channel frequencies individually.

### 4.6.7 Test Results

The spectrum plots are attached on the following pages. D1 line indicates the highest level, and D2 line indicates the 20dB offset below D1. It shows compliance with the requirement.

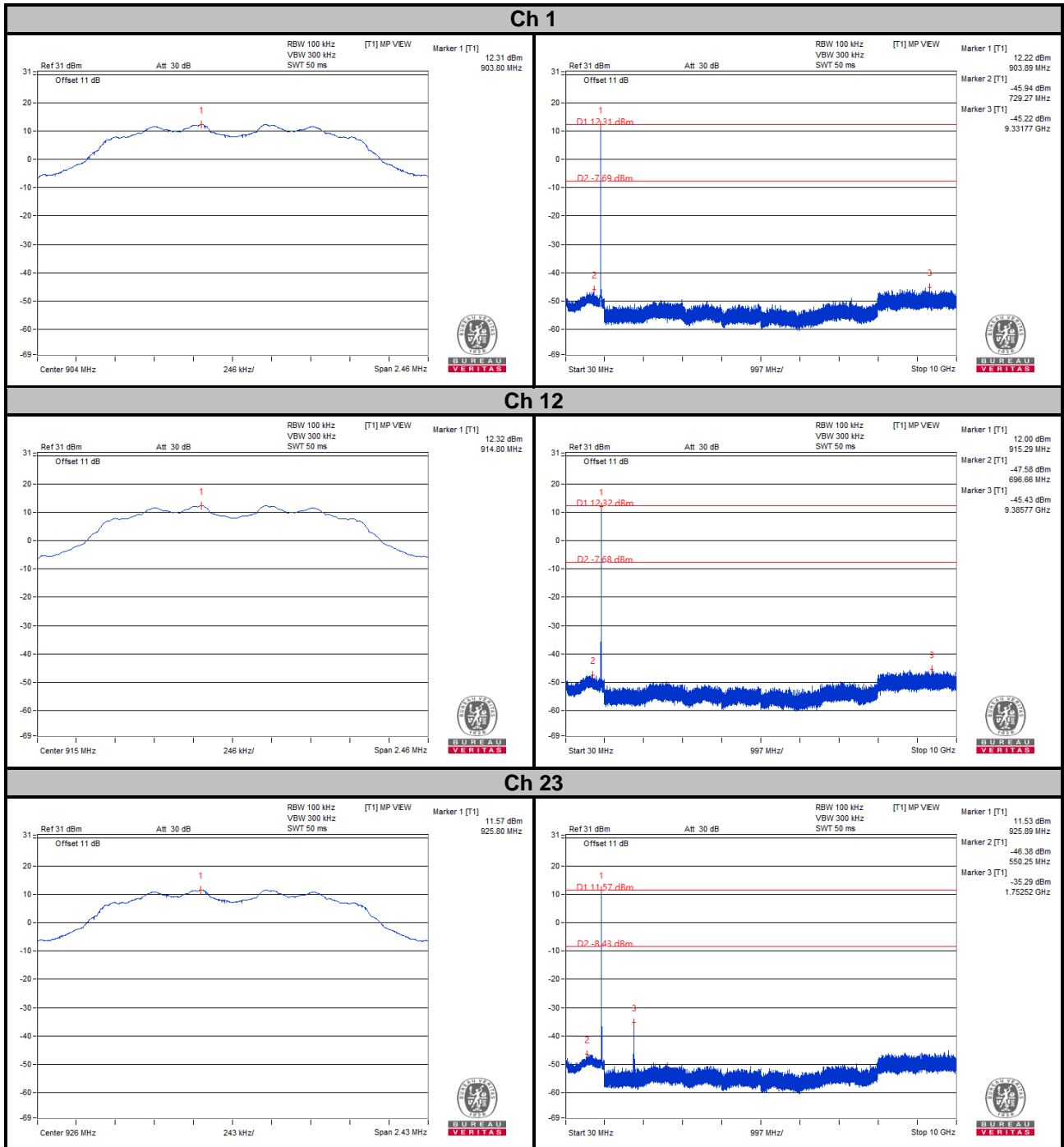

### Ch 1 Band Edge

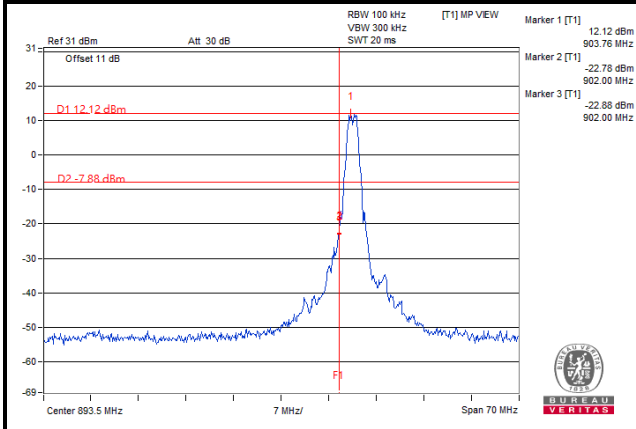

### Ch 12 Band Edge

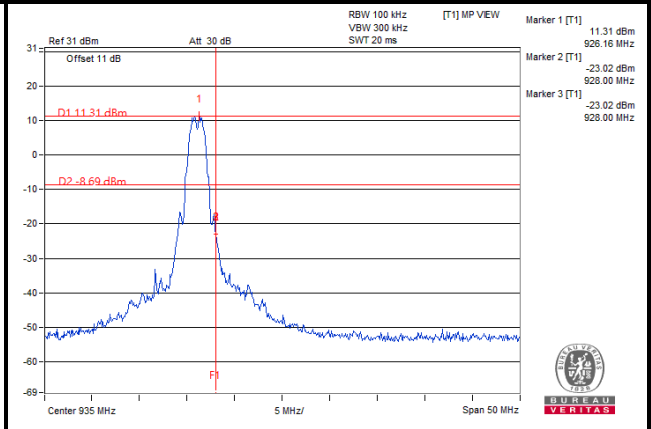

## 5 Pictures of Test Arrangements

Please refer to the attached file (Test Setup Photo).

## Appendix – Information on the Testing Laboratories

We, Bureau Veritas Consumer Products Services (H.K.) Ltd., Taoyuan Branch, were founded in 1988 to provide our best service in EMC, Radio, Telecom and Safety consultation. Our laboratories are FCC recognized accredited test firms and accredited according to ISO/IEC 17025.

If you have any comments, please feel free to contact us at the following:

**Linko EMC/RF Lab**

Tel: 886-2-26052180

Fax: 886-2-26051924

**Hsin Chu EMC/RF/Telecom Lab**

Tel: 886-3-6668565

Fax: 886-3-6668323

**Hwa Ya EMC/RF/Safety**

Tel: 886-3-3183232

Fax: 886-3-3270892

**Email:** [service.adt@tw.bureauveritas.com](mailto:service.adt@tw.bureauveritas.com)

**Web Site:** [www.bureauveritas-adt.com](http://www.bureauveritas-adt.com)

The address and road map of all our labs can be found in our web site also.

--- END ---