

FCC Test Report

(PART 22)

Report No.: RF170808C04

FCC ID: L6AITB100-1

Test Model: ITB100-1

Received Date: Aug. 08, 2017

Test Date: Aug. 14, 2017

Issued Date: Aug. 23, 2017

Applicant: BlackBerry Limited

Address: WAT-A
2200 University Avenue East Waterloo, Ontario N2K 0A7 Canada

Issued By: Bureau Veritas Consumer Products Services (H.K.) Ltd., Taoyuan Branch

Lab Address: No. 47-2, 14th Ling, Chia Pau Vil., Lin Kou Dist., New Taipei City, Taiwan
(R.O.C)

Test Location (1): No. 19, Hwa Ya 2nd Rd, Wen Hwa Tsuen, Kwei Shan Hsiang, Taoyuan
Hsien 333, Taiwan, R.O.C.

Test Location (2): No.215, Sec. 3, Beixin Rd., Xindian Dist., New Taipei City 231, Taiwan,
R.O.C



This report is for your exclusive use. Any copying or replication of this report to or for any other person or entity, or use of our name or trademark, is permitted only with our prior written permission. This report sets forth our findings solely with respect to the test samples identified herein. The results set forth in this report are not indicative or representative of the quality or characteristics of the lot from which a test sample was taken or any similar or identical product unless specifically and expressly noted. Our report includes all of the tests requested by you and the results thereof based upon the information that you provided to us. You have 60 days from date of issuance of this report to notify us of any material error or omission caused by our negligence, provided, however, that such notice shall be in writing and shall specifically address the issue you wish to raise. A failure to raise such issue within the prescribed time shall constitute your unqualified acceptance of the completeness of this report, the tests conducted and the correctness of the report contents. Unless specific mention, the uncertainty of measurement has been explicitly taken into account to declare the compliance or non-compliance to the specification. The report must not be used by the client to claim product certification, approval, or endorsement by TAF or any government agencies

Table of Contents

Release Control Record	3
1 Certificate of Conformity	4
2 Summary of Test Results	5
2.1 Measurement Uncertainty	5
2.2 Test Site and Instruments	6
3 General Information	7
3.1 General Description of EUT	7
3.2 Configuration of System under Test	8
3.2.1 Description of Support Units	8
3.3 Test Mode Applicability and Tested Channel Detail	9
3.4 EUT Operating Conditions	10
3.5 General Description of Applied Standards	10
4 Test Types and Results	11
4.1 Output Power Measurement	11
4.1.1 Limits of Output Power Measurement	11
4.1.2 Test Procedures	11
4.1.3 Test Setup	12
4.1.4 Test Results	13
4.2 Frequency Stability Measurement	15
4.2.1 Limits of Frequency Stability Measurement	15
4.2.2 Test Procedure	15
4.2.3 Test Setup	15
4.2.4 Test Results	16
4.3 Occupied Bandwidth Measurement	19
4.3.1 Test Procedure	19
4.3.2 Test Setup	19
4.3.3 Test Result	20
4.4 Band Edge Measurement	21
4.4.1 Limits of Band Edge Measurement	21
4.4.2 Test Setup	21
4.4.3 Test Procedures	21
4.4.4 Test Results	22
4.5 Peak to Average Ratio	23
4.5.1 Limits of Peak to Average Ratio Measurement	23
4.5.2 Test Setup	23
4.5.3 Test Procedures	23
4.5.4 Test Results	24
4.6 Conducted Spurious Emissions	25
4.6.1 Limits of Conducted Spurious Emissions Measurement	25
4.6.2 Test Setup	25
4.6.3 Test Procedure	25
4.6.4 Test Results	26
4.7 Radiated Emission Measurement	29
4.7.1 Limits of Radiated Emission Measurement	29
4.7.2 Test Procedure	29
4.7.3 Deviation from Test Standard	29
4.7.4 Test Setup	29
4.7.5 Test Results	30
5 Pictures of Test Arrangements	48
Appendix – Information on the Testing Laboratories	49

Release Control Record

Issue No.	Description	Date Issued
RF170808C04	Original Release	Aug. 23, 2017

1 Certificate of Conformity

Product: Asset Tracker

Brand: BlackBerry

Test Model: ITB100-1

Sample Status: Identical Prototype

Applicant: BlackBerry Limited

Test Date: Aug. 14, 2017

Standards: FCC Part 22, Subpart H

The above equipment has been tested by **Bureau Veritas Consumer Products Services (H.K.) Ltd., Taoyuan Branch**, and found compliance with the requirement of the above standards. The test record, data evaluation & Equipment Under Test (EUT) configurations represented herein are true and accurate accounts of the measurements of the sample's EMC characteristics under the conditions specified in this report.

Prepared by : Evonne Liu , **Date:** Aug. 23, 2017
Evonne Liu / Specialist

Approved by : David Huang , **Date:** Aug. 23, 2017
David Huang / Project Engineer

2 Summary of Test Results

Applied Standard: FCC Part 22 & Part 2			
FCC Clause	Test Item	Result	Remarks
2.1046 22.913 (a)	Effective Radiated Power	Pass	Meet the requirement of limit.
---	Peak to Average Ratio	Pass	Meet the requirement of limit.
2.1055 22.355	Frequency Stability	Pass	Meet the requirement of limit.
2.1049	Occupied Bandwidth	Pass	Meet the requirement of limit.
22.917	Band Edge Measurements	Pass	Meet the requirement of limit.
2.1051 22.917	Conducted Spurious Emissions	Pass	Meet the requirement of limit.
2.1053 22.917	Radiated Spurious Emissions	Pass	Meet the requirement of limit. Minimum passing margin is -38.66 dB at 1697.60 MHz.

2.1 Measurement Uncertainty

Where relevant, the following measurement uncertainty levels have been estimated for tests performed on the EUT as specified in CISPR 16-4-2:

Measurement	Frequency	Expanded Uncertainty (k=2) (±)
Conducted Emissions at mains ports	150 kHz ~ 30 MHz	2.44 dB
Radiated Emissions up to 1 GHz	30 MHz ~ 200 MHz	2.0153 dB
	200 MHz ~ 1000 MHz	2.0224 dB
Radiated Emissions above 1 GHz	1 GHz ~ 18 GHz	1.0121 dB
	18 GHz ~ 40 GHz	1.1508 dB

2.2 Test Site and Instruments

Description & Manufacturer	Model No.	Serial No.	Date of Calibration	Due Date of Calibration
Test Receiver Agilent Technologies	N9038A	MY52260177	Jul. 05, 2017	Jul. 04, 2018
Spectrum Analyzer ROHDE & SCHWARZ	FSU43	101261	Dec. 13, 2016	Dec. 12, 2017
BILOG Antenna SCHWARZBECK	VULB9168	9168-472	Dec. 16, 2016	Dec. 15, 2017
HORN Antenna ETS-Lindgren	3117	00143293	Dec. 29, 2016	Dec. 28, 2017
Double Ridge Guide Horn Antenna EMCO	3115	5619	Dec. 27, 2016	Dec. 26, 2017
BILOG Antenna SCHWARZBECK	VULB 9168	9168-153	Dec. 13, 2016	Dec. 12, 2017
Communications Tester-Wireless Agilent	8960 Series 10	MY53201073	Jun. 28, 2017	Jun. 27, 2019
Preamplifier Agilent	310N	187226	Jun. 23, 2017	Jun. 22, 2018
Preamplifier Agilent	83017A	MY39501357	Jun. 23, 2017	Jun. 22, 2018
Power Meter Anritsu	ML2495A	1232002	Sep. 08, 2016	Sep. 07, 2017
Power Sensor Anritsu	MA2411B	1207325	Sep. 08, 2016	Sep. 07, 2017
RF signal cable ETS-LINDGREN	5D-FB	Cable-CH1-01(R FC-SMS-100-SM S-120+RFC-SMS -100-SMS-400)	Jun. 23, 2017	Jun. 22, 2018
RF signal cable ETS-LINDGREN	8D-FB	Cable-CH1-02(R FC-SMS-100-SM S-24)	Jun. 23, 2017	Jun. 22, 2018
Software BV ADT	E3 8.130425b	NA	NA	NA
Antenna Tower MF	NA	NA	NA	NA
Turn Table MF	NA	NA	NA	NA
Antenna Tower & Turn Table Controller MF	MF-7802	NA	NA	NA
Radio Communication Analyzer Anritsu	MT8820C	6201300640	Aug. 10, 2015	Aug. 09, 2017

Note: 1. The calibration interval of the above test instruments is 12 / 24 months and the calibrations are traceable to NML/ROC and NIST/USA.

2. The test was performed in HsinTien Chamber 1.

3. The horn antenna and preamplifier (model: 83017A) are used only for the measurement of emission frequency above 1 GHz if tested.

4. The IC Site Registration No. is IC7450I-1.

3 General Information

3.1 General Description of EUT

Product	Asset Tracker	
Brand	BlackBerry	
Test Model	ITB100-1	
Status of EUT	Identical Prototype	
Power Supply Rating	10.8 Vdc (Battery)	
Modulation Type	GSM/GPRS	GMSK
	EDGE	GMSK, 8PSK
	WCDMA	QPSK
Frequency Range	GSM/GPRS/EDGE	824.2 ~ 848.8 MHz
	WCDMA	826.4 ~ 846.6 MHz
Max. ERP Power	GSM/GPRS	408.51 mW
	EDGE	113.29 mW
	WCDMA	51.17 mW
Emission Designator	GSM/GPRS	244KGXW
	EDGE	255KG7W
	WCDMA	4M08F9W
Antenna Type	PCB Antenna	
Accessory Device	Refer to Note as below	
Data Cable Supplied	Refer to Note as below	

Note:

1. The above EUT information is declared by manufacturer and for more detailed features description, please refer to the manufacturer's specifications or user's manual.

3.2 Configuration of System under Test

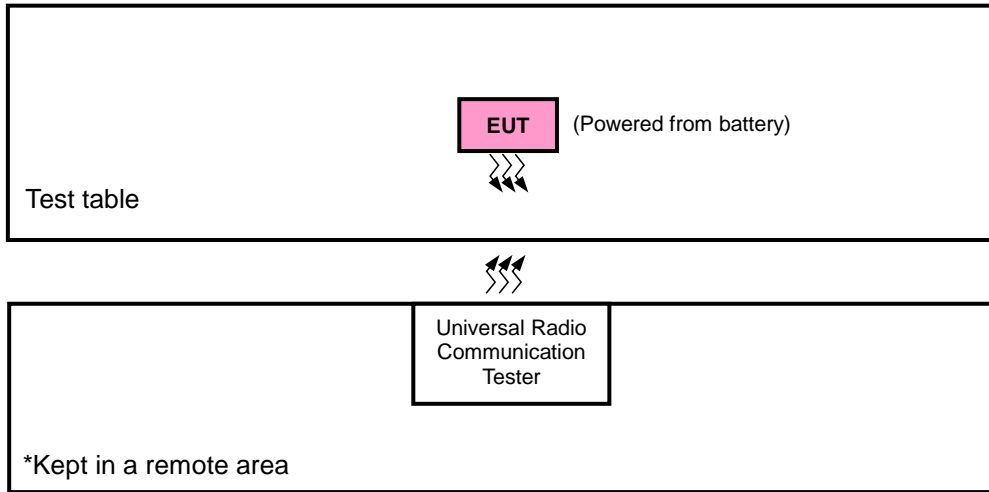

3.2.1 Description of Support Units

The EUT has been tested as an independent unit together with other necessary accessories or support units. The following support units or accessories were used to form a representative test configuration during the tests.

No.	Product	Brand	Model No.	Serial No.	FCC ID
1.	Universal Radio Communication Tester	R&S	CMU200	123295	N/A
2.	Battery	N/A	N/A	N/A	N/A

No.	Signal Cable Description Of The Above Support Units
1.	N/A
2.	N/A

Note:

1. All power cords of the above support units are non-shielded (1.8m).
2. Items 1 acted as communication partners to transfer data.

3.3 Test Mode Applicability and Tested Channel Detail

Pre-Scan has been conducted to determine the worst-case mode from all possible combinations between available modulations, data rates, XYZ axis, and antenna ports.

The worst case was found when positioned as the table below. Following channel(s) was (were) selected for the final test as listed below:

Band	ERP	Radiated Emission
GSM	Y-plane	X-axis
EDGE	Y-plane	X-axis
WCDMA	Y-plane	X-axis

GSM

EUT Configure Mode	Test Item	Available Channel	Tested Channel	Mode
-	ERP	128 to 251	128, 189, 251	GSM, EDGE
-	Frequency Stability	128 to 251	128, 251	GSM, EDGE
-	Occupied Bandwidth	128 to 251	128, 189, 251	GSM, EDGE
-	Band Edge	128 to 251	128, 251	GSM, EDGE
-	Peak to Average Ratio	128 to 251	128, 189, 251	GSM, EDGE
-	Conducuted Emission	128 to 251	128, 189, 251	GSM, EDGE
-	Radiated Emission	128 to 251	128, 189, 251	GSM, EDGE

WCDMA

EUT Configure Mode	Test Item	Available Channel	Tested Channel	Mode
-	ERP	4132 to 4233	4132, 4182, 4233	WCDMA
-	Frequency Stability	4132 to 4233	4132, 4233	WCDMA
-	Occupied Bandwidth	4132 to 4233	4132, 4182, 4233	WCDMA
-	Band Edge	4132 to 4233	4132, 4233	WCDMA
-	Peak to Average Ratio	4132 to 4233	4132, 4182, 4233	WCDMA
-	Conducuted Emission	4132 to 4233	4132, 4182, 4233	WCDMA
-	Radiated Emission	4132 to 4233	4132, 4182, 4233	WCDMA

Test Condition:

Test Item	Environmental Conditions	Input Power	Tested By
ERP	25 deg. C, 65 % RH	10.8 Vdc	Gavin Wu
Frequency Stability	25 deg. C, 65 % RH	10.8 Vdc	Gavin Wu
Occupied Bandwidth	25 deg. C, 65 % RH	10.8 Vdc	Gavin Wu
Band Edge	25 deg. C, 65 % RH	10.8 Vdc	Gavin Wu
Peak to Average Ratio	25 deg. C, 65 % RH	10.8 Vdc	Gavin Wu
Condcudeted Emission	25 deg. C, 65 % RH	10.8 Vdc	Gavin Wu
Radiated Emission	25 deg. C, 65 % RH	120 Vac, 60 Hz	Harry Hsueh

3.4 EUT Operating Conditions

The EUT makes a call to the communication simulator. The communication simulator station system controlled a EUT to export maximum output power under transmission mode and specific channel frequency.

3.5 General Description of Applied Standards

The EUT is a RF Product. According to the specifications of the manufacturer, it must comply with the requirements of the following standards:

FCC 47 CFR Part 2

FCC 47 CFR Part 22

KDB 971168 D01 Power Meas License Digital Systems v02r02

ANSI/TIA/EIA-603-D 2010

Note: All test items have been performed and recorded as per the above standards.

4 Test Types and Results

4.1 Output Power Measurement

4.1.1 Limits of Output Power Measurement

Mobile / Portable station are limited to 7 watts e.r.p.

4.1.2 Test Procedures

EIRP / ERP Measurement:

- a. All measurements were done at low, middle and high operational frequency range. RBW and VBW is 1 MHz for GSM, GPRS & EDGE, and 5 MHz for WCDMA and CDMA, and 10 MHz for LTE mode.
- b. Substitution method is used for E.I.R.P measurement. In the semi-anechoic chamber, EUT placed on the 0.8 m height of Turn Table, rotated the table around 360 degrees to search the maximum radiation power and receiver antenna shall be rotated vertical and horizontal polarization and moved height from 1 m to 4 m to find the maximum polar radiated power. The "Read Value" is the spectrum reading the maximum power value.
- c. The substitution horn antenna is substituted for EUT at the same position and signals generator export the CW signal to the substitution antenna via a tx cable. Rotated the Turn Table and moved receiving antenna to find the maximum radiation power. Adjust output power level of S.G to get a Value of spectrum reading equal to "Read Value" of step b. Record the power level of S.G.
- d. $EIRP = \text{Output power level of S.G} - \text{TX cable loss} + \text{Antenna gain of substitution horn}$. E.R.P power can be calculated form E.I.R.P power by subtracting the gain of dipole, $E.R.P \text{ power} = E.I.P.R \text{ power} - 2.15 \text{ dBi}$.

Conducted Power Measurement:

The EUT was set up for the maximum power with GSM, GPRS, EDGE, WCDMA, CDMA, and LTE link data modulation and link up with simulator. Set the EUT to transmit under low, middle and high channel and record the power level shown on simulator.

4.1.3 Test Setup

EIRP / ERP Measurement:

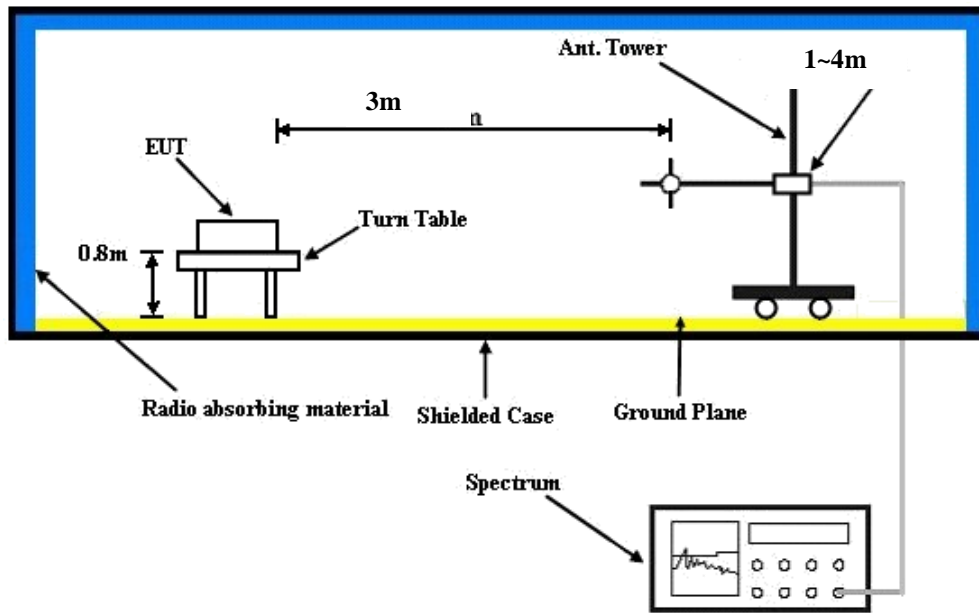

For the actual test configuration, please refer to the attached file (Test Setup Photo).

Conducted Power Measurement:

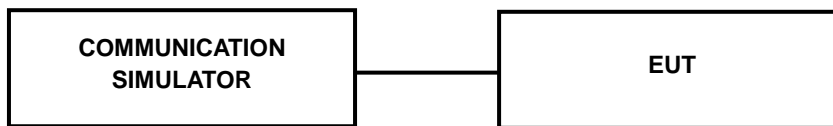

4.1.4 Test Results

Conducted Output Power (dBm)

Band	GSM850		
Channel	128	189	251
Frequency (MHz)	824.2	836.4	848.8
GSM (GMSK, 1Tx-slot)	30.01	29.96	30.02
GPRS (GMSK, 1Tx-slot)	29.95	29.94	29.99
GPRS (GMSK, 2Tx-slot)	29.90	29.91	29.95
GPRS (GMSK, 3Tx-slot)	29.24	29.26	29.30
GPRS (GMSK, 4Tx-slot)	28.05	28.07	28.12
EDGE (8PSK, 1Tx-slot)	26.09	25.76	26.43
EDGE (8PSK, 2Tx-slot)	26.08	25.75	26.38
EDGE (8PSK, 3Tx-slot)	25.19	24.88	25.55
EDGE (8PSK, 4Tx-slot)	24.00	23.66	24.29

Band	WCDMA V		
Channel	4132	4182	4233
Frequency (MHz)	826.4	836.4	846.6
RMC 12.2K	23.93	23.68	23.74
HSDPA Subtest-1	23.70	22.75	23.26
HSDPA Subtest-2	22.90	22.53	22.45
HSDPA Subtest-3	22.53	22.18	22.10
HSDPA Subtest-4	22.24	21.88	21.82
HSUPA Subtest-1	22.88	22.52	22.46
HSUPA Subtest-2	20.78	20.37	20.48
HSUPA Subtest-3	21.58	21.20	21.14
HSUPA Subtest-4	21.14	20.65	20.68
HSUPA Subtest-5	22.95	22.57	22.54

ERP Power (dBm)

GSM							
Plane	Channel	Frequency (MHz)	LVL (dBm)	Correction Factor (dB)	ERP (dBm)	ERP (mW)	Polarization (H/V)
Y	128	824.2	-3.02	31.208	26.04	401.61	H
	189	836.4	-3.12	31.3	26.03	400.87	
	251	848.8	-2.96	31.222	26.11	408.51	
	128	824.2	-9.20	31.504	20.15	103.61	V
	189	836.4	-8.92	31.117	20.05	101.09	
	251	848.8	-9.75	31.922	20.02	100.51	

EDGE							
Plane	Channel	Frequency (MHz)	LVL (dBm)	Correction Factor (dB)	ERP (dBm)	ERP (mW)	Polarization (H/V)
Y	128	824.2	-8.52	31.208	20.54	113.19	H
	189	836.4	-8.68	31.3	20.47	111.43	
	251	848.8	-8.53	31.222	20.54	113.29	
	128	824.2	-14.86	31.504	14.49	28.14	V
	189	836.4	-14.43	31.117	14.54	28.42	
	251	848.8	-15.24	31.922	14.53	28.39	

WCDMA							
Plane	Channel	Frequency (MHz)	LVL (dBm)	Correction Factor (dB)	ERP (dBm)	ERP (mW)	Polarization (H/V)
Y	4132	826.4	-12.00	31.208	17.06	50.79	H
	4182	836.4	-12.06	31.3	17.09	51.17	
	4233	846.6	-12.02	31.222	17.05	50.72	
	4132	826.4	-18.26	31.504	11.09	12.86	V
	4182	836.4	-17.95	31.117	11.02	12.64	
	4233	846.6	-18.70	31.922	11.07	12.80	

4.2 Frequency Stability Measurement

4.2.1 Limits of Frequency Stability Measurement

1.5 ppm is for base and fixed station. 2.5 ppm is for mobile station.

4.2.2 Test Procedure

- Device is placed at the oven room. The oven room could control the temperatures and humidity. Power warm up is at least 15 min and power applied should perform before recording frequency error.
- EUT is connected the external power supply to control the DC input power. The test voltage range is from minimum to maximum working voltage. Each step shall be record the frequency error rate.
- The temperature range step is 10 degrees in this test items. All temperature levels shall be hold the ± 0.5 °C during the measurement testing. The each temperature step shall be at least 0.5 hours, consider the EUT could be test under the stability condition.

NOTE: The frequency error was recorded frequency error from the communication simulator.

4.2.3 Test Setup

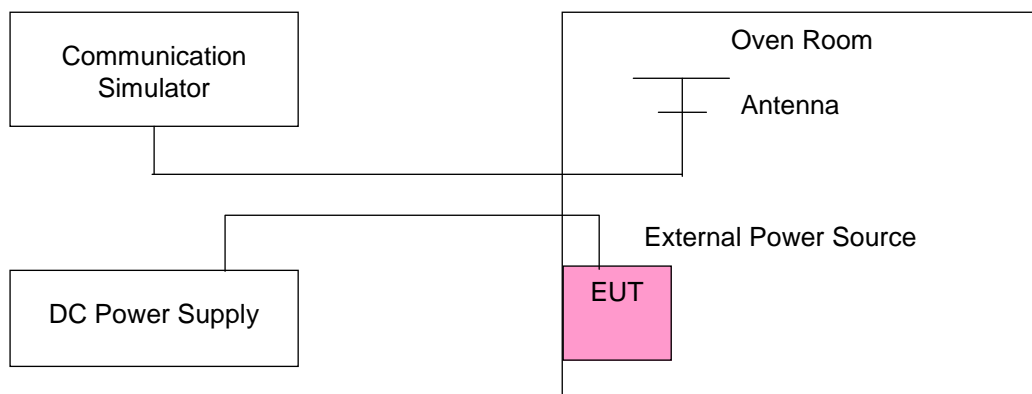

4.2.4 Test Results

Frequency Error vs. Voltage

Voltage (Volts)	GSM				Limit (ppm)
	Low Channel		High Channel		
	Frequency (MHz)	Frequency Error (ppm)	Frequency (MHz)	Frequency Error (ppm)	
10.8	824.200001	0.001	848.800002	0.002	2.5
9.72	824.200003	0.004	848.800004	0.004	2.5
11.88	824.200002	0.003	848.800002	0.002	2.5

Note: The applicant defined the normal working voltage of the battery is from 9.72 Vdc to 11.88 Vdc.

Frequency Error vs. Temperature

Temp. (°C)	GSM				Limit (ppm)
	Low Channel		High Channel		
	Frequency (MHz)	Frequency Error (ppm)	Frequency (MHz)	Frequency Error (ppm)	
-40	824.200002	0.002	848.800004	0.005	2.5
-30	824.200004	0.004	848.800004	0.005	2.5
-20	824.200002	0.002	848.800003	0.004	2.5
-10	824.200001	0.001	848.800001	0.002	2.5
0	824.200002	0.002	848.800003	0.004	2.5
10	824.200001	0.001	848.800003	0.003	2.5
20	824.200004	0.004	848.800001	0.001	2.5
30	824.199999	-0.001	848.799996	-0.005	2.5
40	824.199997	-0.004	848.799998	-0.002	2.5
50	824.199996	-0.005	848.799999	-0.001	2.5
60	824.199998	-0.003	848.799998	-0.002	2.5
70	824.199999	-0.001	848.799999	-0.002	2.5
80	824.199998	-0.003	848.799998	-0.002	2.5
85	824.199999	-0.002	848.799998	-0.002	2.5

Note:

1. The applicant declared that the normal operating temperature of the EUT is from -40°C to 85°C.
2. The EUT would shut down automatically as below -40°C.

Frequency Error vs. Voltage

Voltage (Volts)	EDGE				Limit (ppm)
	Low Channel		High Channel		
	Frequency (MHz)	Frequency Error (ppm)	Frequency (MHz)	Frequency Error (ppm)	
10.8	824.200004	0.004	848.800003	0.003	2.5
9.72	824.200004	0.004	848.800001	0.001	2.5
11.88	824.200002	0.002	848.800004	0.005	2.5

Note: The applicant defined the normal working voltage of the battery is from 9.72 Vdc to 11.88 Vdc.

Frequency Error vs. Temperature

Temp. (°C)	EDGE				Limit (ppm)
	Low Channel		High Channel		
	Frequency (MHz)	Frequency Error (ppm)	Frequency (MHz)	Frequency Error (ppm)	
-40	824.200002	0.003	848.800003	0.003	2.5
-30	824.200004	0.005	848.800003	0.003	2.5
-20	824.200001	0.001	848.800001	0.001	2.5
-10	824.200002	0.002	848.800001	0.002	2.5
0	824.200001	0.001	848.800002	0.002	2.5
10	824.200002	0.002	848.800002	0.003	2.5
20	824.200003	0.004	848.800004	0.005	2.5
30	824.199999	-0.002	848.799999	-0.002	2.5
40	824.199997	-0.003	848.799998	-0.002	2.5
50	824.199998	-0.002	848.799998	-0.003	2.5
60	824.199998	-0.002	848.799996	-0.004	2.5
70	824.199999	-0.001	848.799999	-0.001	2.5
80	824.199997	-0.004	848.799997	-0.003	2.5
85	824.199997	-0.004	848.799996	-0.004	2.5

Note:

1. The applicant declared that the normal operating temperature of the EUT is from -40°C to 85°C.
2. The EUT would shut down automatically as below -40°C.

Frequency Error vs. Voltage

Voltage (Volts)	WCDMA				Limit (ppm)
	Low Channel		High Channel		
	Frequency (MHz)	Frequency Error (ppm)	Frequency (MHz)	Frequency Error (ppm)	
10.8	826.400003	0.003	846.600002	0.003	2.5
9.72	826.400002	0.003	846.600004	0.004	2.5
11.88	826.400003	0.004	846.600003	0.004	2.5

Note: The applicant defined the normal working voltage of the battery is from 9.72 Vdc to 11.88 Vdc.

Frequency Error vs. Temperature

Temp. (°C)	WCDMA				Limit (ppm)
	Low Channel		High Channel		
	Frequency (MHz)	Frequency Error (ppm)	Frequency (MHz)	Frequency Error (ppm)	
-40	824.200003	0.003	848.800002	0.003	2.5
-30	826.400004	0.004	846.600003	0.004	2.5
-20	826.400004	0.005	846.600003	0.004	2.5
-10	826.400004	0.005	846.600004	0.004	2.5
0	826.400004	0.005	846.600002	0.002	2.5
10	826.400004	0.004	846.600002	0.002	2.5
20	826.400002	0.002	846.600001	0.001	2.5
30	826.399997	-0.003	846.599999	-0.002	2.5
40	826.399996	-0.004	846.599997	-0.004	2.5
50	824.199997	-0.003	848.799999	-0.001	2.5
60	824.199996	-0.005	848.799998	-0.003	2.5
70	824.199997	-0.003	848.799999	-0.001	2.5
80	824.199997	-0.004	848.799997	-0.004	2.5
85	824.199996	-0.004	848.799996	-0.004	2.5

Note:

1. The applicant declared that the normal operating temperature of the EUT is from -40°C to 85°C.
2. The EUT would shut down automatically as below -40°C.

4.3 Occupied Bandwidth Measurement

4.3.1 Test Procedure

The EUT makes a call to the communication simulator. All measurements were done at low, middle and high operational frequency range. The communication simulator station system controlled a EUT to export maximum output power under transmission mode and specific channel frequency. Use OBW measurement function of Spectrum analyzer to measure 99 % occupied bandwidth.

4.3.2 Test Setup

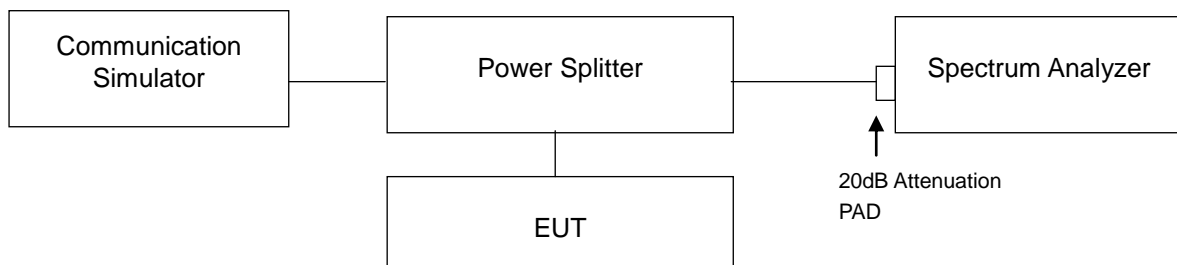

4.3.3 Test Result

Channel	Frequency (MHz)	99 % Occupied Bandwidth (kHz)		Channel	Frequency (MHz)	99 % Occupied Bandwidth (MHz)
		GSM	EDGE			WCDMA
128	824.2	242.22	251.34	4132	826.4	4.0883
189	836.4	243.52	255.09	4182	836.4	4.0890
251	848.8	244.54	252.27	4233	846.6	4.0815

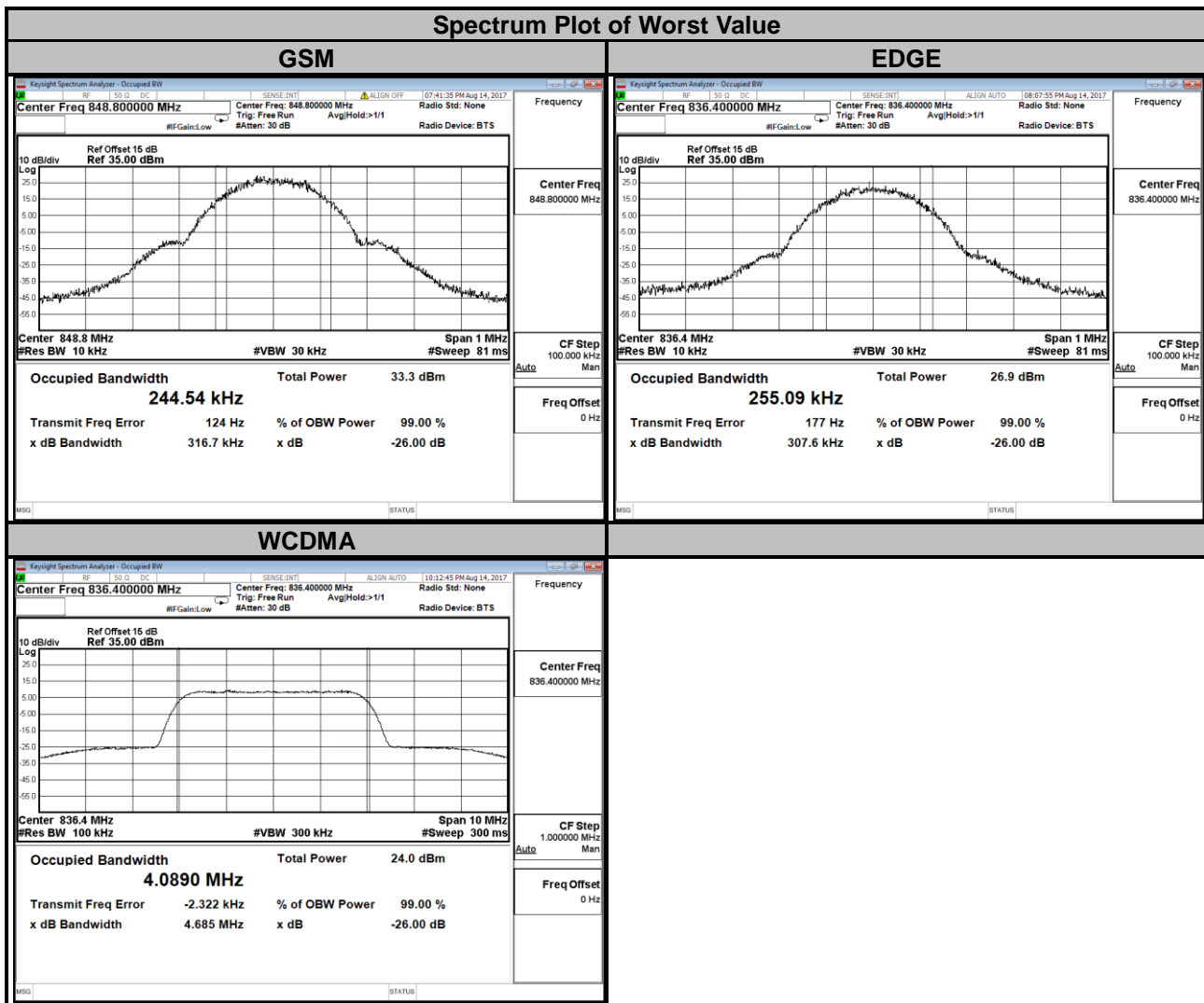

4.4 Band Edge Measurement

4.4.1 Limits of Band Edge Measurement

Power of any emission outside of the authorized operating frequency ranges must be attenuated below the transmitting power (P) by a factor of at least $43 + 10 \log(P)$ dB. In the 1 MHz bands immediately outside and adjacent to the frequency block a resolution bandwidth of at least one percent of the emission bandwidth of the fundamental emission of the transmitter may be employed.

4.4.2 Test Setup

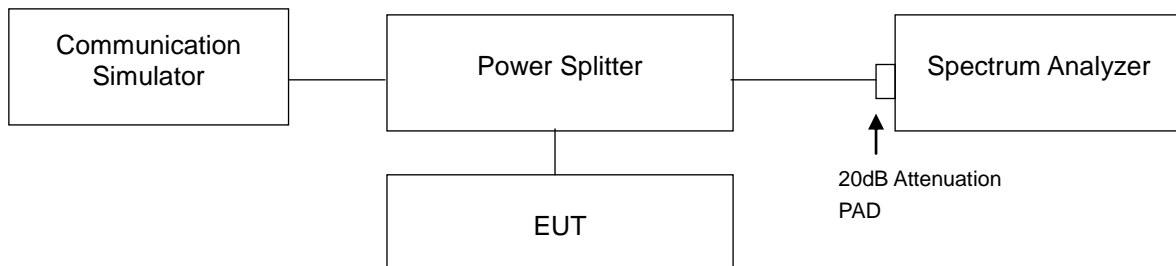

4.4.3 Test Procedures

- All measurements were done at low and high operational frequency range.
- The center frequency of spectrum is the band edge frequency and span is 1 MHz. RB of the spectrum is 10 kHz and VB of the spectrum is 30 kHz (GSM/GPRS/EDGE).
- The center frequency of spectrum is the band edge frequency and span is 5 MHz. RB of the spectrum is 100 kHz and VB of the spectrum is 300 kHz (WCDMA).
- Record the max trace plot into the test report.

4.4.4 Test Results

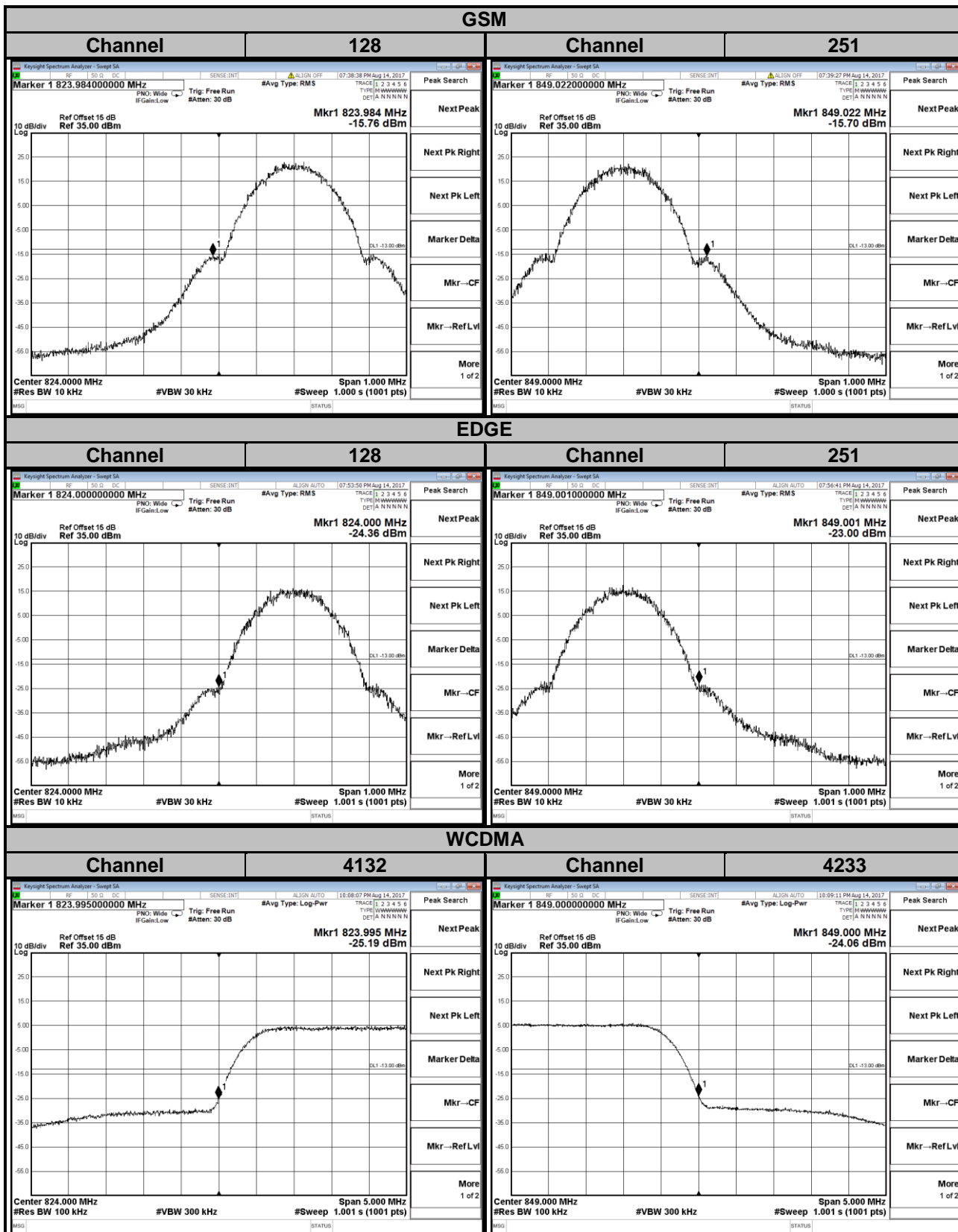

4.5 Peak to Average Ratio

4.5.1 Limits of Peak to Average Ratio Measurement

In measuring transmissions in this band using an average power technique, the peak to-average ratio (PAR) of the transmission may not exceed 13 dB.

4.5.2 Test Setup

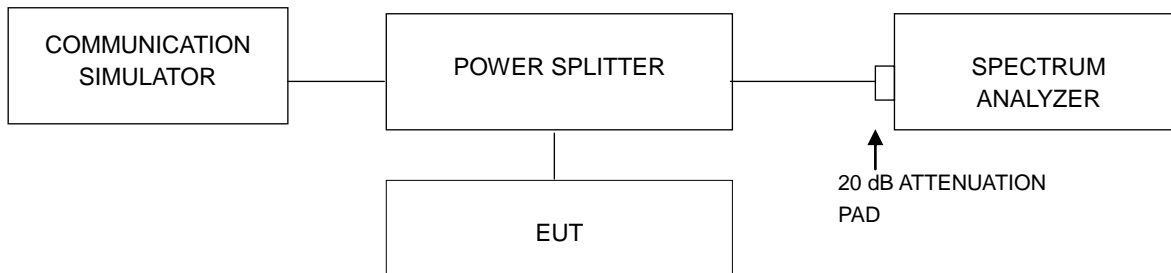

4.5.3 Test Procedures

1. Set resolution/measurement bandwidth \geq signal's occupied bandwidth;
2. Set the number of counts to a value that stabilizes the measured CCDF curve;
3. Record the maximum PAPR level associated with a probability of 0.1 %.

4.5.4 Test Results

Channel	Frequency (MHz)	Peak to Average Ratio (dB)		Channel	Frequency (MHz)	Peak to Average Ratio (dB)
		GSM	EDGE			
128	824.2	0.11	2.77	4132	826.4	2.84
189	836.4	0.11	2.76	4182	836.4	2.82
251	848.8	0.11	2.73	4233	846.6	2.84

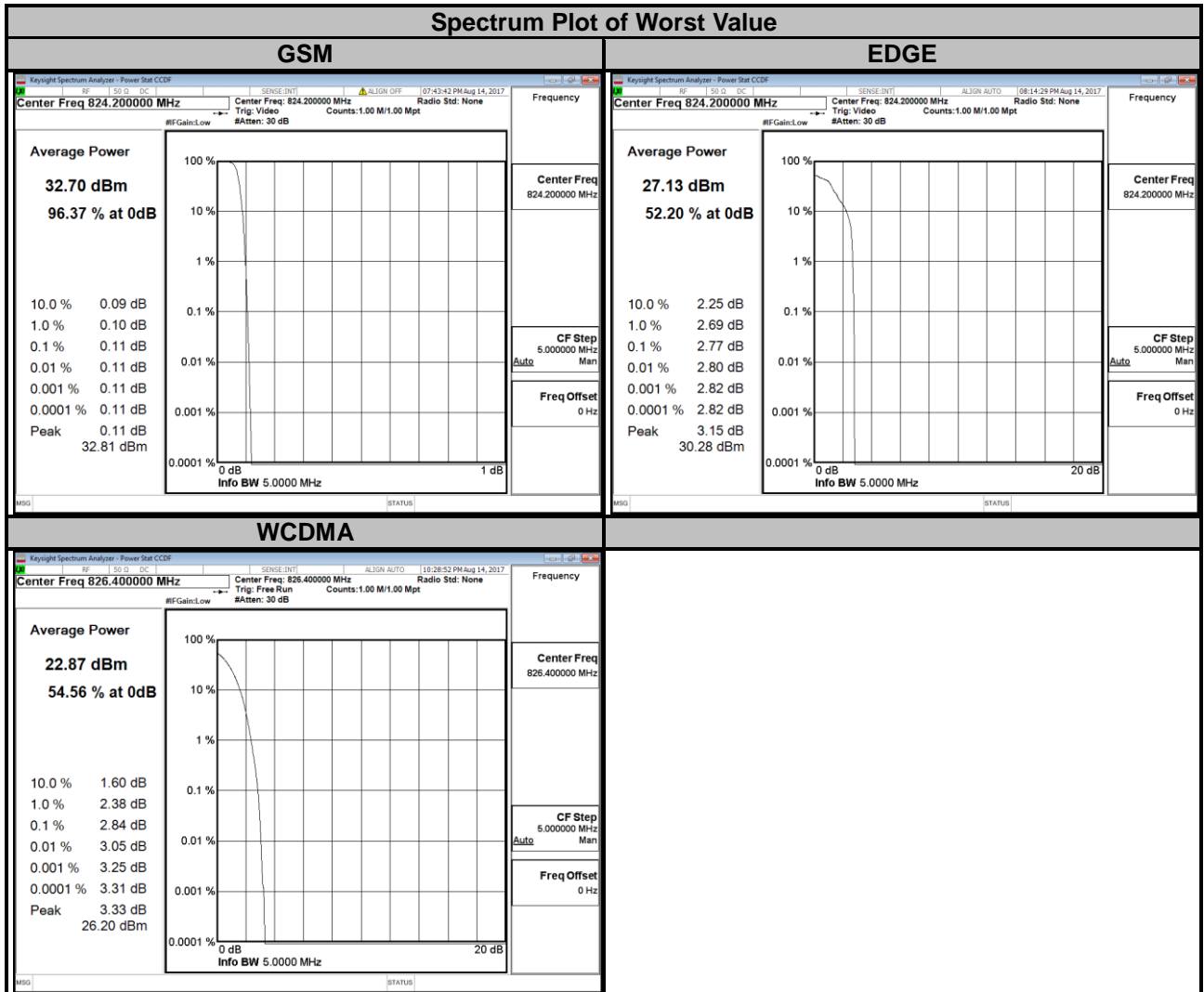

4.6 Conducted Spurious Emissions

4.6.1 Limits of Conducted Spurious Emissions Measurement

The power of any emission outside of the authorized operating frequency ranges must be attenuated below the transmitting power (P) by a factor of at least $43 + 10 \log(P)$ dB. The emission limit equal to -13 dBm.

4.6.2 Test Setup

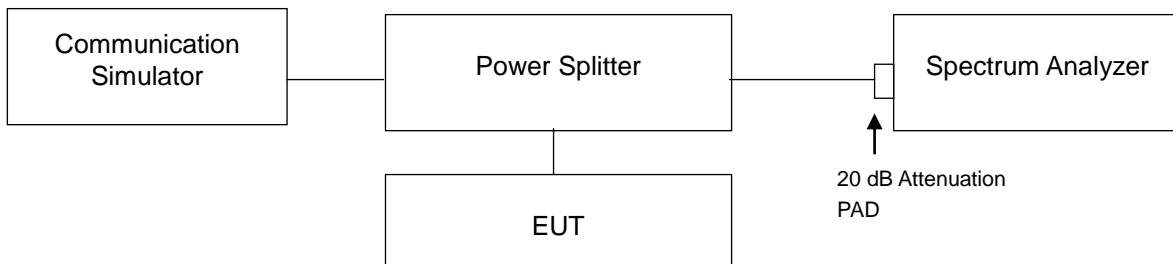

4.6.3 Test Procedure

- The EUT makes a phone call to the communication simulator. All measurements were done at low, middle and high operational frequency range.
- Measuring frequency range is from 9 kHz to 9 GHz. 20 dB attenuation pad is connected with spectrum. RBW=1 MHz and VBW=3 MHz is used for conducted emission measurement.

4.6.4 Test Results

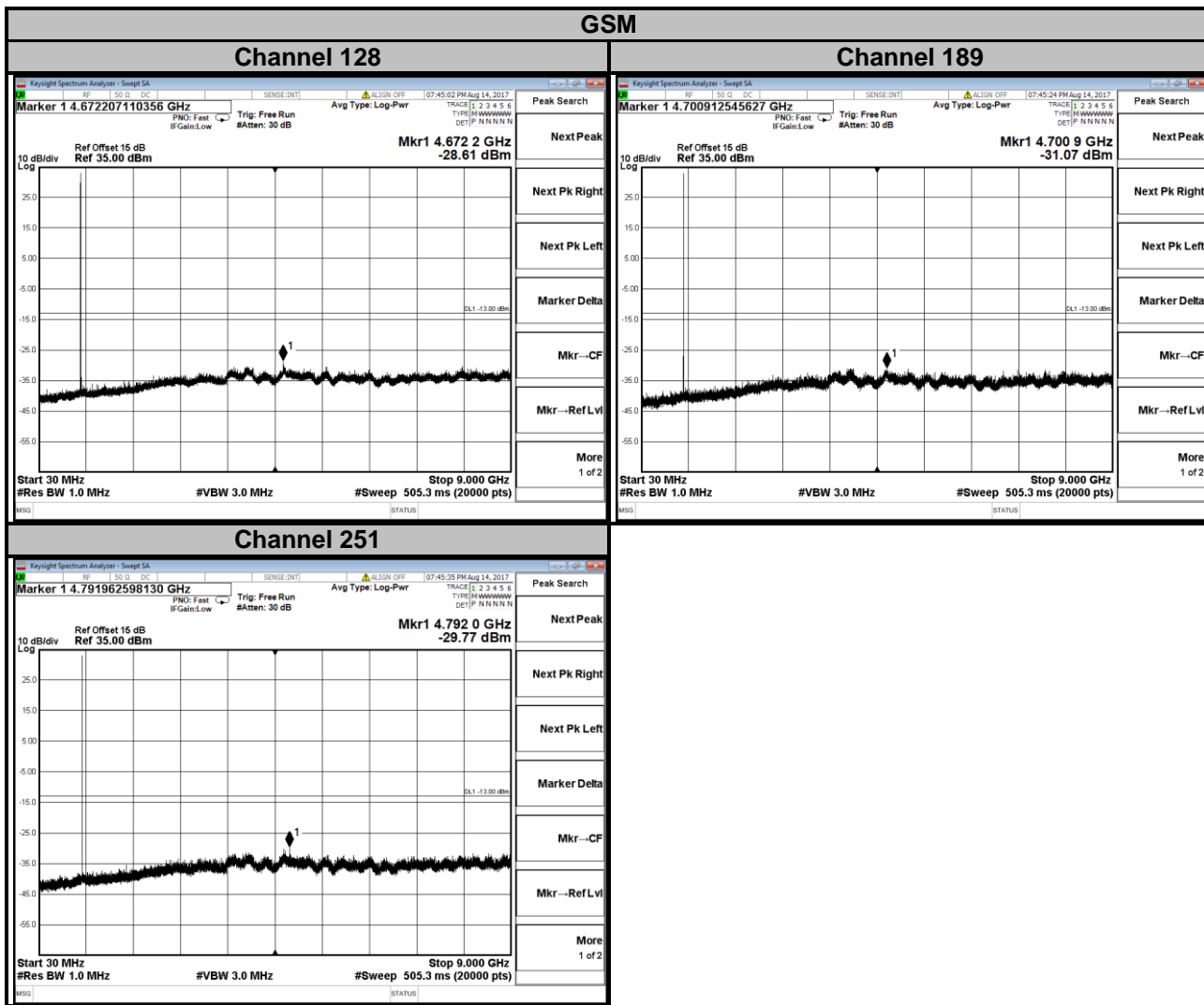

EDGE

Channel 128

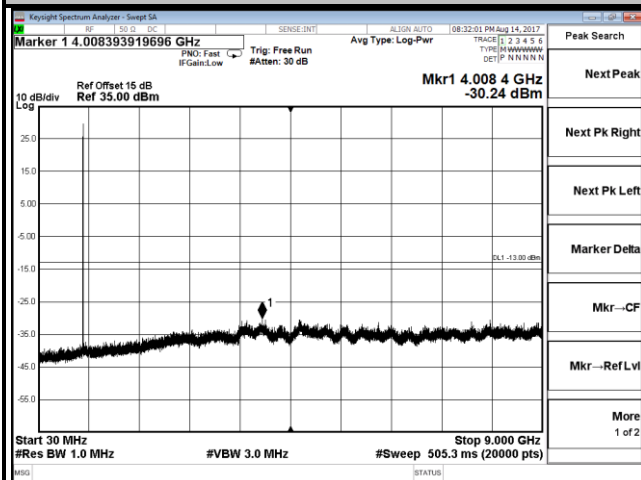

Channel 189

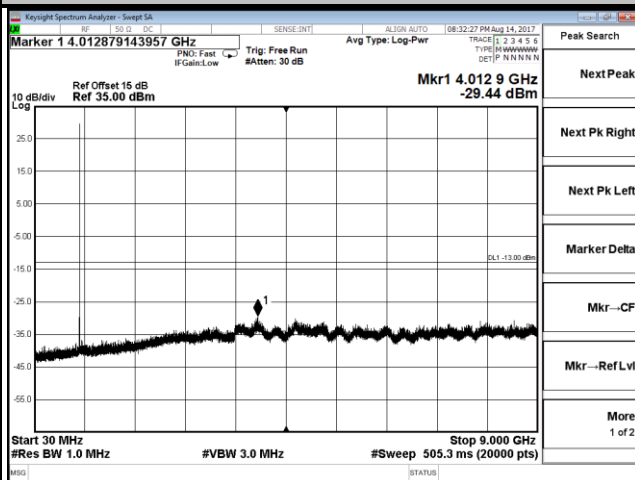

Channel 251

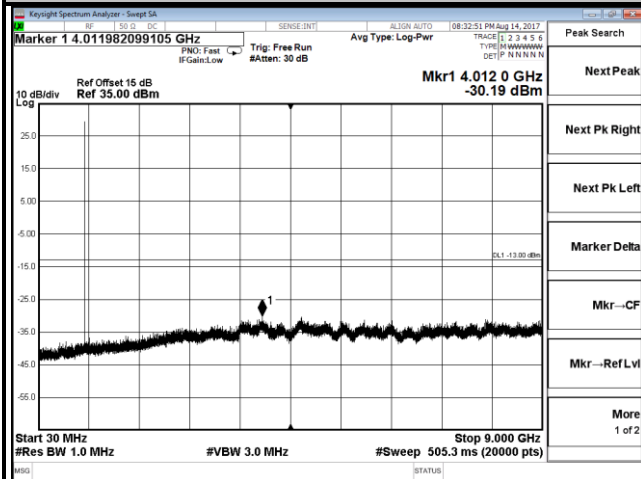

WCDMA

Channel 4132

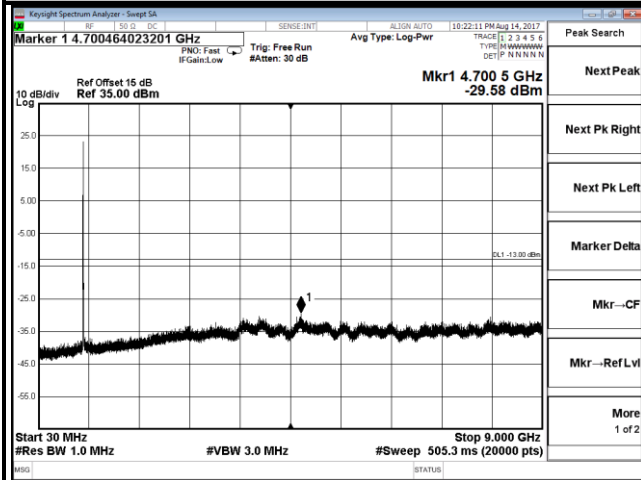

Channel 4182

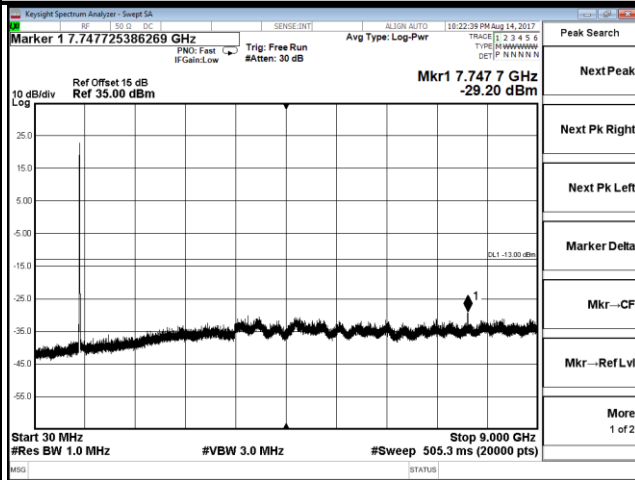

Channel 4233

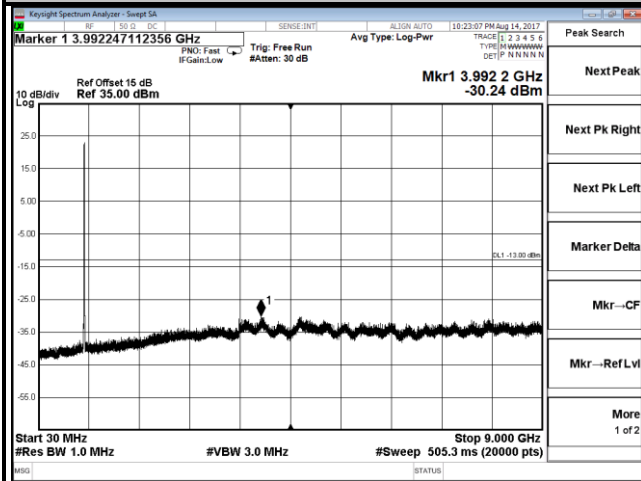

4.7 Radiated Emission Measurement

4.7.1 Limits of Radiated Emission Measurement

The power of any emission outside of the authorized operating frequency ranges must be attenuated below the transmitting power (P) by a factor of at least $43 + 10 \log(P)$ dB. The emission limit is equal to -13 dBm.

4.7.2 Test Procedure

- Substitution method is used for E.I.R.P measurement. In the semi-anechoic chamber, EUT placed on the 0.8 m height of Turn Table, rotated the table around 360 degrees to search the maximum radiation power and receiver antenna shall be rotated vertical and horizontal polarization and moved height from 1 m to 4 m to find the maximum polar radiated power. The "Read Value" is the spectrum reading the maximum power value.
- The substitution horn antenna is substituted for EUT at the same position and signals generator export the CW signal to the substitution antenna via a TX cable. Rotated the Turn Table and moved receiving antenna to find the maximum radiation power. Adjust output power level of S.G to get a Value of spectrum reading equal to "Read Value" of step a. Record the power level of S.G
- $EIRP = \text{Output power level of S.G} - \text{TX cable loss} + \text{Antenna gain of substitution horn.}$
- E.R.P power can be calculated form E.I.R.P power by subtracting the gain of dipole, $E.R.P \text{ power} = E.I.P.R \text{ power} - 2.15 \text{ dBi.}$

NOTE: The resolution bandwidth and video bandwidth of test receiver/spectrum analyzer is 1 MHz/3 MHz.

4.7.3 Deviation from Test Standard

No deviation.

4.7.4 Test Setup

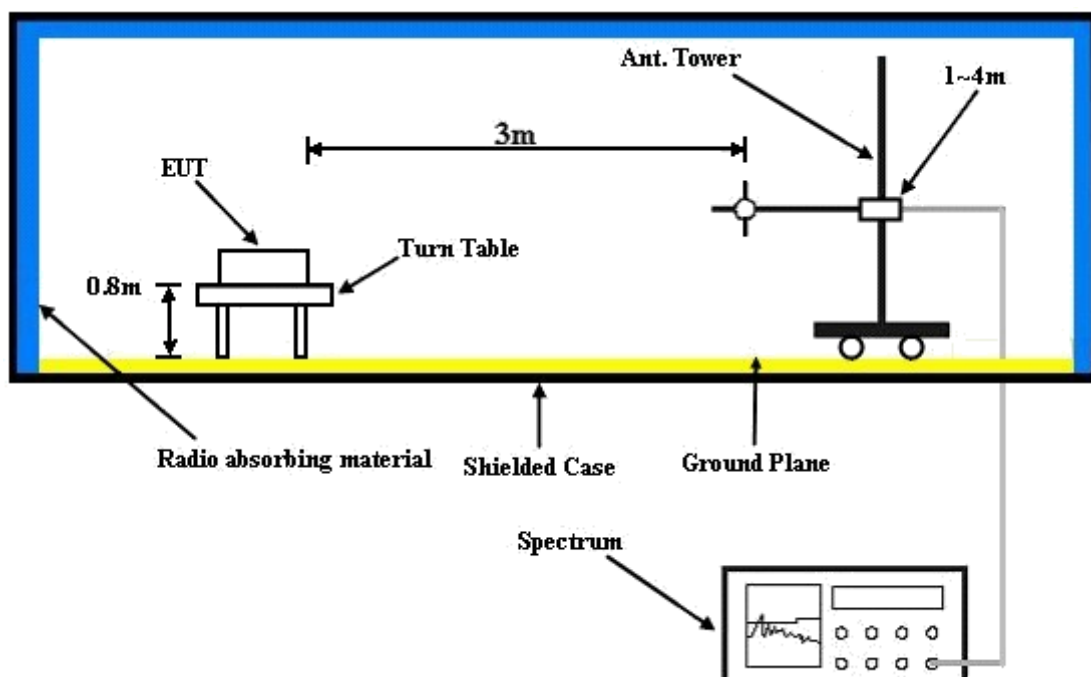

For the actual test configuration, please refer to the attached file (Test Setup Photo).

4.7.5 Test Results

GSM:
Low Channel



Bureau Veritas Consumer Products Services Ltd., Taoyuan Branch

A D T

Data: 5

Date: 2017-08-14

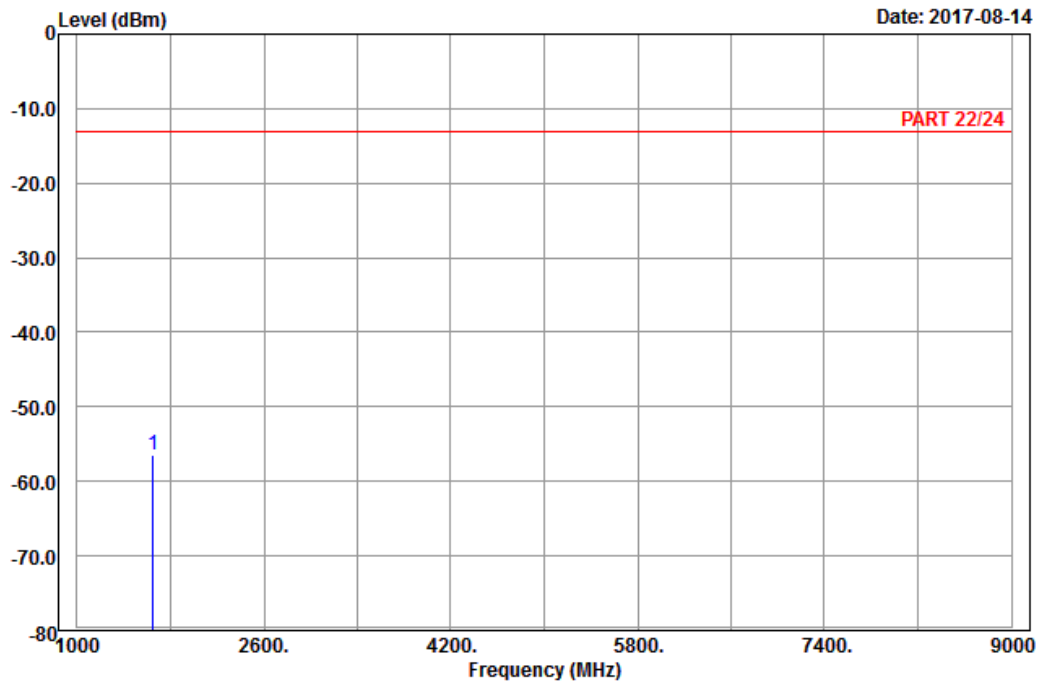

Site : 966 chamber 1
Condition: PART 22/24 Horizontal
Remark : GPRS 850_Link_CH128
Tested by: Harry Hsueh

	Freq	Level	Read Level	Limit Line	Over Limit	Factor	Remark
	MHz	dBm	dBm	dBm	dB	dB	
1	pp 1648.40	-56.43	-64.16	-13.00	-43.43	7.73	Peak



Bureau Veritas Consumer Products Services Ltd., Taoyuan Branch

A D T

Data: 6

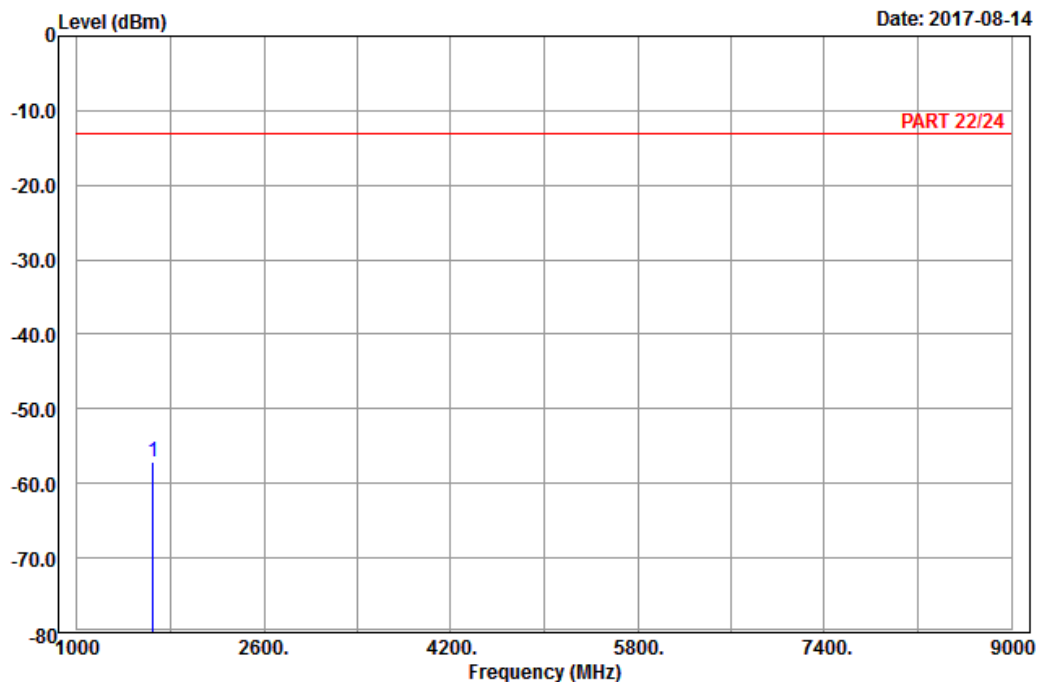

Site : 966 chamber 1
 Condition: PART 22/24 Vertical
 Remark : GPRS 850_Link_CH128
 Tested by: Harry Hsueh

Freq	Level	Read Level	Limit Line	Over Limit	Factor	Remark
MHz	dBm	dBm	dBm	dB	dB	
1 pp 1648.40	-57.14	-64.87	-13.00	-44.14	7.73	Peak

Frequency (MHz)	ERP(dBm)	Limit(dBm)	Over Limit (dB)	SPA. Reading (dBm)	S.G. Power (dBm)	TX Cable loss (dB)	TX Antenna Gain (dBi)	Polarization (H/V)	Result
1648.4	-56.43	-13	-43.43	-61.99	-56.21	3.704	5.63	H	Pass
1648.4	-57.14	-13	-44.14	-62.69	-56.92	3.704	5.63	V	Pass

Middle Channel



Bureau Veritas Consumer Products Services Ltd., Taoyuan Branch

A D T

Data: 5

Date: 2017-08-14

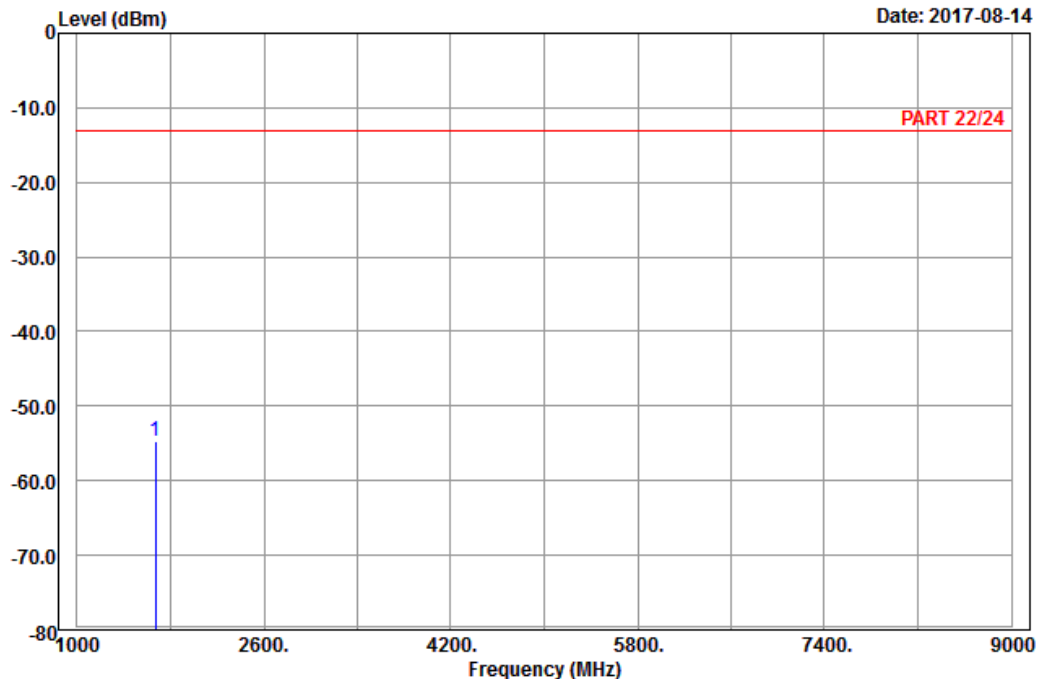

Site : 966 chamber 1
 Condition: PART 22/24 Horizontal
 Remark : GPRS 850_Link_CH189
 Tested by: Harry Hsueh

	Read	Limit	Over			
Freq	Level	Level	Line	Limit	Factor	Remark
MHz	dBm	dBm	dBm	dB	dB	
1 pp 1672.80	-54.73	-62.64	-13.00	-41.73	7.91	Peak



Bureau Veritas Consumer Products Services Ltd., Taoyuan Branch

A D T

Data: 6

Date: 2017-08-14

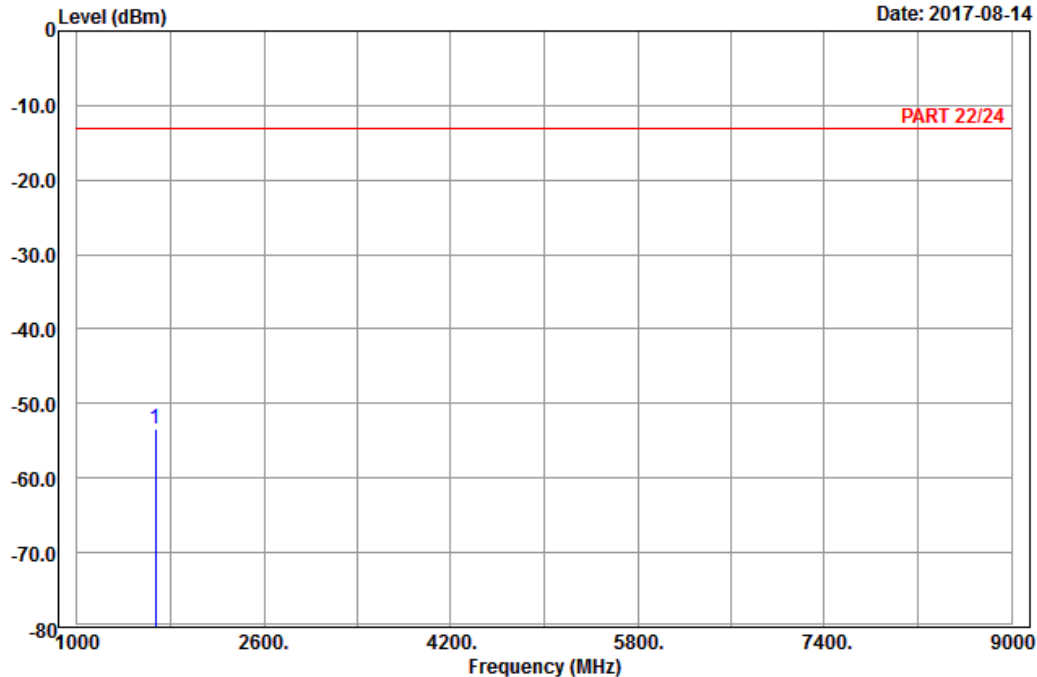

Site : 966 chamber 1
 Condition: PART 22/24 Vertical
 Remark : GPRS 850_Link_CH189
 Tested by: Harry Hsueh

	Freq	Level	Read Level	Limit Line	Over Limit	Factor	Remark
	MHz	dBm	dBm	dBm	dB	dB	
1 pp	1672.80	-53.45	-61.36	-13.00	-40.45	7.91	Peak

Frequency (MHz)	ERP(dBm)	Limit(dBm)	Over Limit (dB)	SPA. Reading (dBm)	S.G. Power (dBm)	TX Cable loss (dB)	TX Antenna Gain (dBi)	Polarization (H/V)	Result
1672.8	-54.73	-13	-41.73	-60.52	-54.51	3.704	5.63	H	Pass
1672.8	-53.45	-13	-40.45	-59.24	-53.23	3.704	5.63	V	Pass

High Channel



Bureau Veritas Consumer Products Services Ltd., Taoyuan Branch

A D T

Data: 9

Date: 2017-08-14

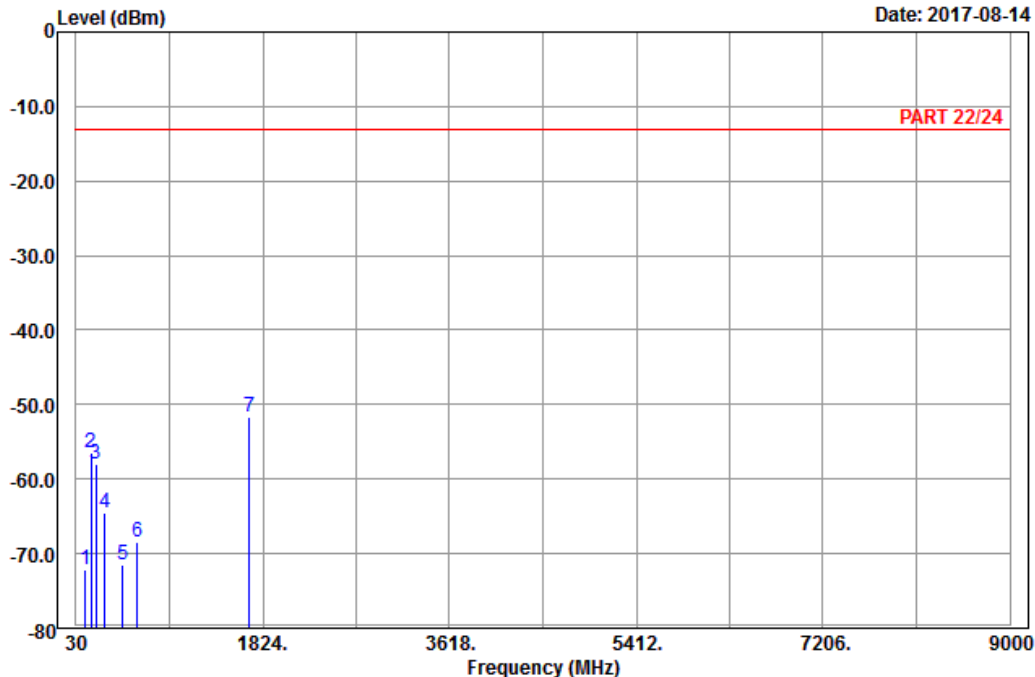

Site : 966 chamber 1
 Condition: PART 22/24 Horizontal
 Remark : GPRS 850_Link_CH251
 Tested by: Harry Hsueh

	Freq	Level	Read Level	Limit Line	Over Limit	Factor	Remark
	MHz	dBm	dBm	dBm	dB	dB	
1	119.91	-72.05	-63.80	-13.00	-59.05	-8.25	Peak
2	175.26	-56.35	-50.26	-13.00	-43.35	-6.09	Peak
3	222.24	-58.03	-52.15	-13.00	-45.03	-5.88	Peak
4	304.20	-64.49	-58.59	-13.00	-51.49	-5.90	Peak
5	479.90	-71.40	-66.70	-13.00	-58.40	-4.70	Peak
6	622.00	-68.40	-68.58	-13.00	-55.40	0.18	Peak
7 pp	1697.60	-51.66	-59.80	-13.00	-38.66	8.14	Peak



Bureau Veritas Consumer Products Services Ltd., Taoyuan Branch

A D T

Data: 10

Date: 2017-08-14

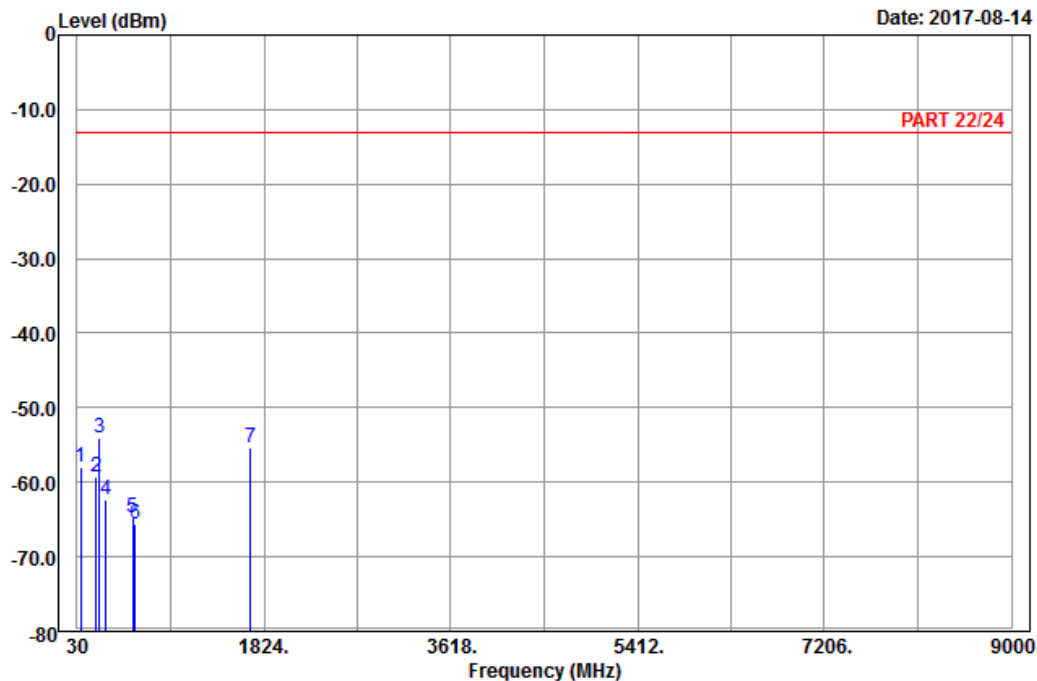

Site : 966 chamber 1
 Condition: PART 22/24 Vertical
 Remark : GPRS 850_Link_CH251
 Tested by: Harry Hsueh

	Freq	Level	Read Level	Limit Line	Over Limit	Factor	Remark
	MHz	dBm	dBm	dBm	dB	dB	
1	66.99	-58.07	-44.97	-13.00	-45.07	-13.10	Peak
2	212.52	-59.29	-53.28	-13.00	-46.29	-6.01	Peak
3	247.35	-54.15	-48.60	-13.00	-41.15	-5.55	Peak
4	308.40	-62.40	-56.54	-13.00	-49.40	-5.86	Peak
5	561.80	-64.76	-63.58	-13.00	-51.76	-1.18	Peak
6	589.80	-65.69	-65.68	-13.00	-52.69	-0.01	Peak
7	1697.60	-55.31	-63.45	-13.00	-42.31	8.14	Peak

Frequency (MHz)	ERP(dBm)	Limit(dBm)	Over Limit (dB)	SPA. Reading (dBm)	S.G. Power (dBm)	TX Cable loss (dB)	TX Antenna Gain (dBi)	Polarization (H/V)	Result
1697.6	-51.66	-13	-38.66	-57.67	-51.44	3.704	5.63	H	Pass
1697.6	-55.31	-13	-42.31	-61.25	-55.09	3.704	5.63	V	Pass

EDGE:
Low Channel



Bureau Veritas Consumer Products Services Ltd., Taoyuan Branch

A D T

Data: 5

Date: 2017-08-14

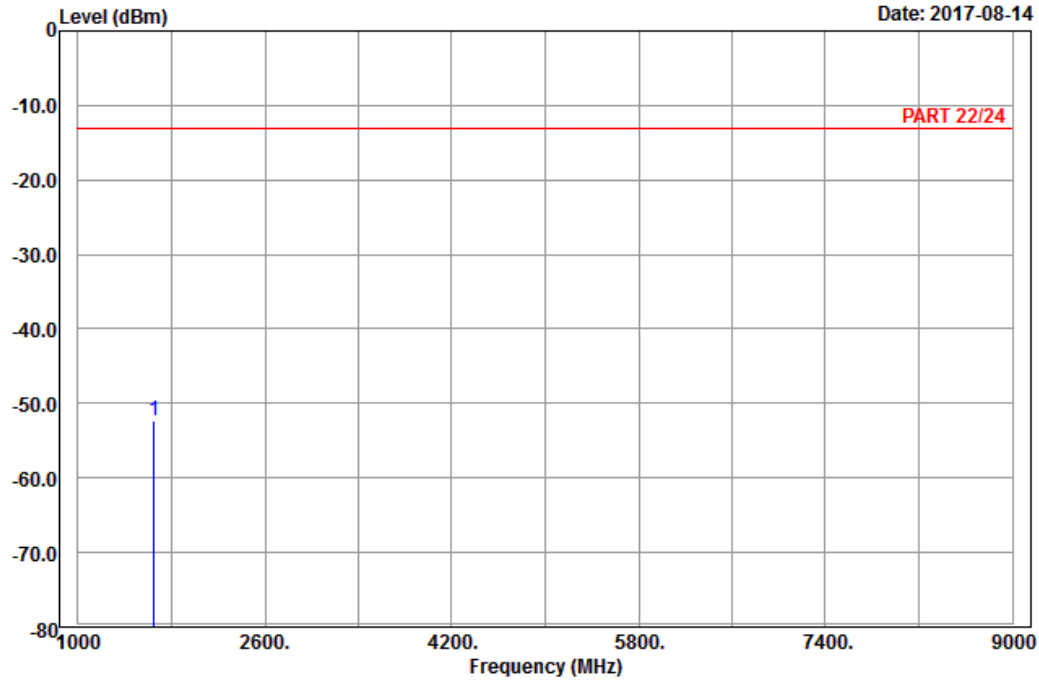

Site : 966 chamber 1
Condition: PART 22/24 Horizontal
Remark : EDGE 850_Link_CH128
Tested by: Harry Hsueh

	Freq	Level	Read Level	Limit Line	Over Limit	Factor	Remark
	MHz	dBm	dBm	dBm	dB	dB	
1	pp 1648.40	-52.27	-60.00	-13.00	-39.27	7.73	Peak



Bureau Veritas Consumer Products Services Ltd., Taoyuan Branch

A D T

Data: 6

Date: 2017-08-14

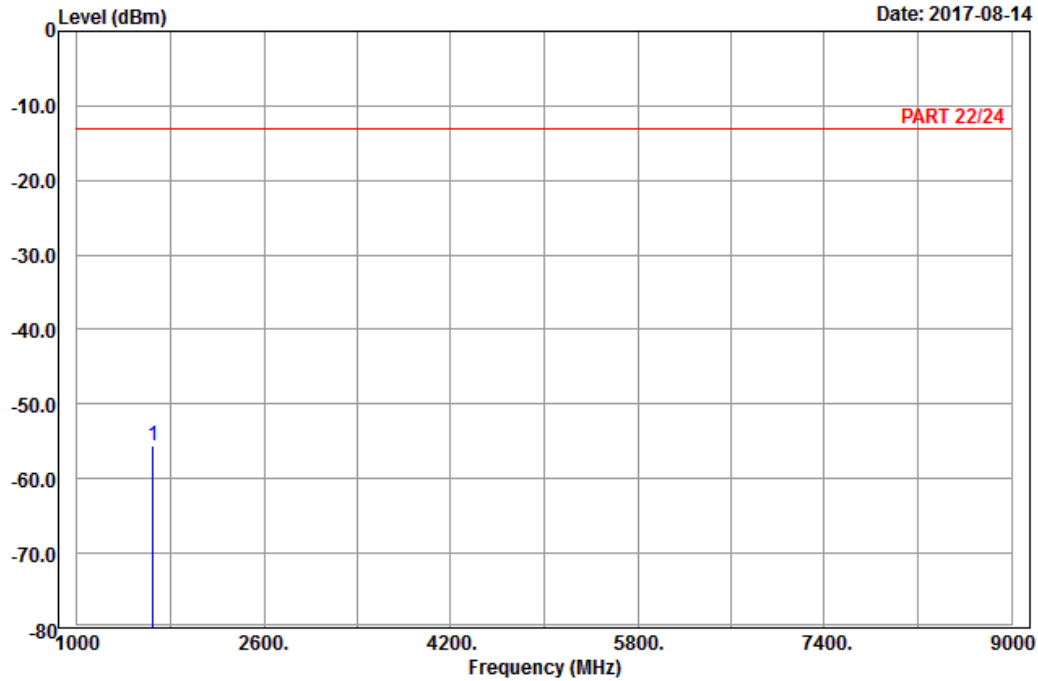

Site : 966 chamber 1
 Condition: PART 22/24 Vertical
 Remark : EDGE 850_Link_CH128
 Tested by: Harry Hsueh

Freq	Level	Read Level	Limit Line	Over Limit	Factor	Remark
MHz	dBm	dBm	dBm	dB	dB	
1 pp 1648.40	-55.52	-63.25	-13.00	-42.52	7.73	Peak

Frequency (MHz)	ERP(dBm)	Limit(dBm)	Over Limit (dB)	SPA. Reading (dBm)	S.G. Power (dBm)	TX Cable loss (dB)	TX Antenna Gain (dBi)	Polarization (H/V)	Result
1648.4	-52.27	-13	-39.27	-57.84	-52.05	3.704	5.63	H	Pass
1648.4	-55.52	-13	-42.52	-61.12	-55.3	3.704	5.63	V	Pass

Middle Channel



Bureau Veritas Consumer Products Services Ltd., Taoyuan Branch

A D T

Data: 5

Date: 2017-08-14

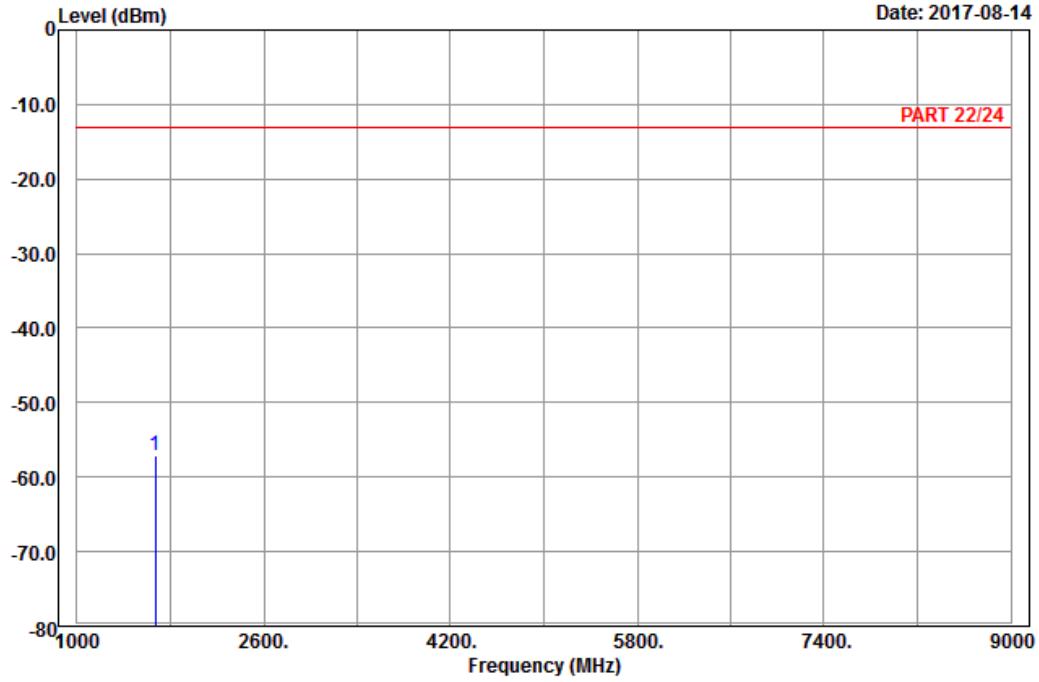

Site : 966 chamber 1
 Condition: PART 22/24 Horizontal
 Remark : EDGE 850_Link_CH189
 Tested by: Harry Hsueh

	Read	Limit	Over			
Freq	Level	Level	Line	Limit	Factor	Remark
MHz	dBm	dBm	dBm	dB	dB	
1 pp 1672.80	-57.14	-65.05	-13.00	-44.14	7.91	Peak



Bureau Veritas Consumer Products Services Ltd., Taoyuan Branch

A D T

Data: 6

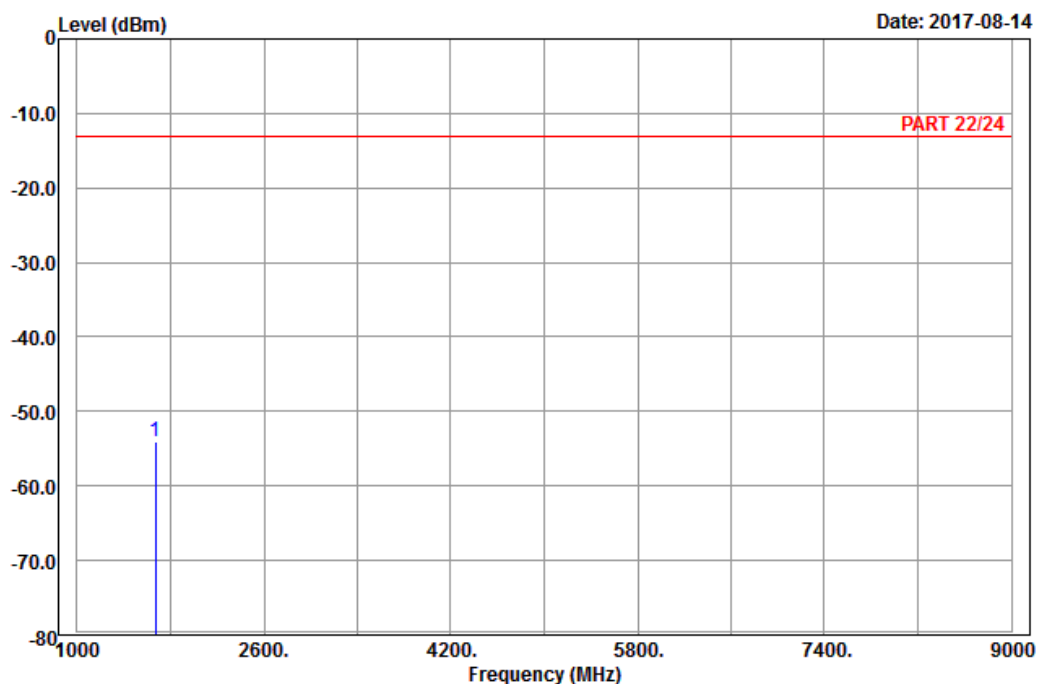

Site : 966 chamber 1
 Condition: PART 22/24 Vertical
 Remark : EDGE 850_Link_CH189
 Tested by: Harry Hsueh

Freq	Level	Read Level	Limit	Over Limit	Factor	Remark
MHz	dBm	dBm	dBm	dB	dB	
1 pp 1672.80	-54.13	-62.04	-13.00	-41.13	7.91	Peak

Frequency (MHz)	ERP(dBm)	Limit(dBm)	Over Limit (dB)	SPA. Reading (dBm)	S.G. Power (dBm)	TX Cable loss (dB)	TX Antenna Gain (dBi)	Polarization (H/V)	Result
1672.8	-57.14	-13	-44.14	-62.86	-56.92	3.704	5.63	H	Pass
1672.8	-54.13	-13	-41.13	-59.85	-53.91	3.704	5.63	V	Pass

High Channel



Bureau Veritas Consumer Products Services Ltd., Taoyuan Branch

A D T

Data: 5

Date: 2017-08-14

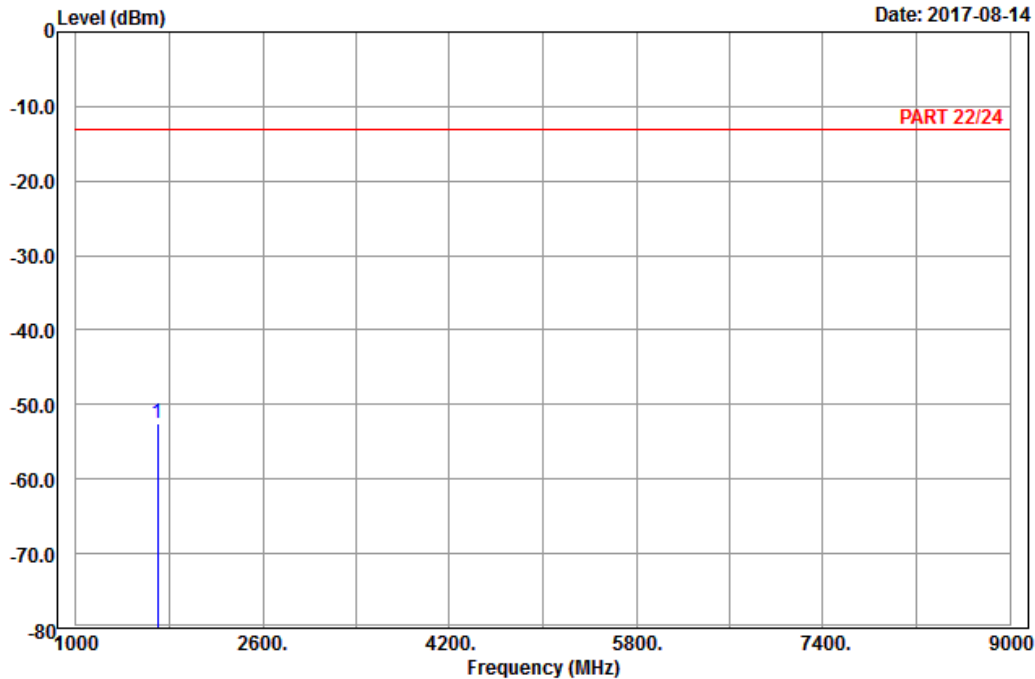

Site : 966 chamber 1
 Condition: PART 22/24 Horizontal
 Remark : EDGE 850_Link_CH251
 Tested by: Harry Hsueh

Freq	Level	Read Level	Limit Line	Over Limit	Factor	Remark
MHz	dBm	dBm	dBm	dB	dB	
1 pp 1697.60	-52.43	-60.57	-13.00	-39.43	8.14	Peak



Bureau Veritas Consumer Products Services Ltd., Taoyuan Branch

A D T

Data: 6

Date: 2017-08-14

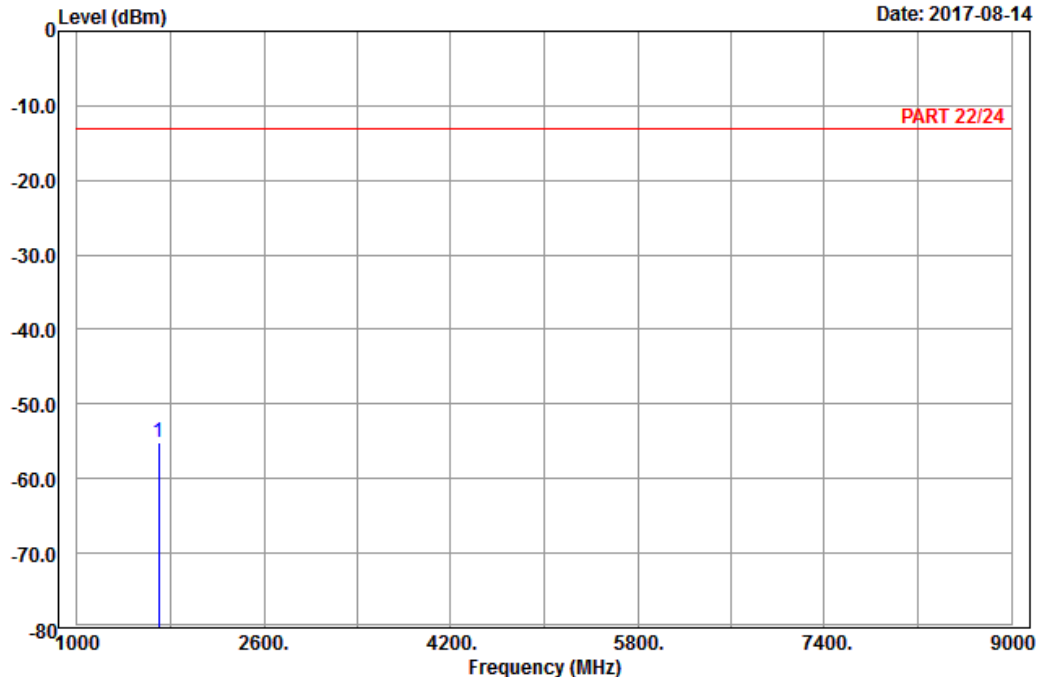

Site : 966 chamber 1
 Condition: PART 22/24 Vertical
 Remark : EDGE 850_Link_CH251
 Tested by: Harry Hsueh

Freq	Level	Read Level	Limit Line	Over Limit	Factor	Remark
MHz	dBm	dBm	dBm	dB	dB	
1 pp 1697.60	-55.08	-63.22	-13.00	-42.08	8.14	Peak

Frequency (MHz)	ERP(dBm)	Limit(dBm)	Over Limit (dB)	SPA. Reading (dBm)	S.G. Power (dBm)	TX Cable loss (dB)	TX Antenna Gain (dBi)	Polarization (H/V)	Result
1697.6	-52.43	-13	-39.43	-58.41	-52.21	3.704	5.63	H	Pass
1697.6	-55.08	-13	-42.08	-61.05	-54.86	3.704	5.63	V	Pass

WCDMA:
Low Channel



Bureau Veritas Consumer Products Services Ltd., Taoyuan Branch

A D T

Data: 5

Date: 2017-08-14

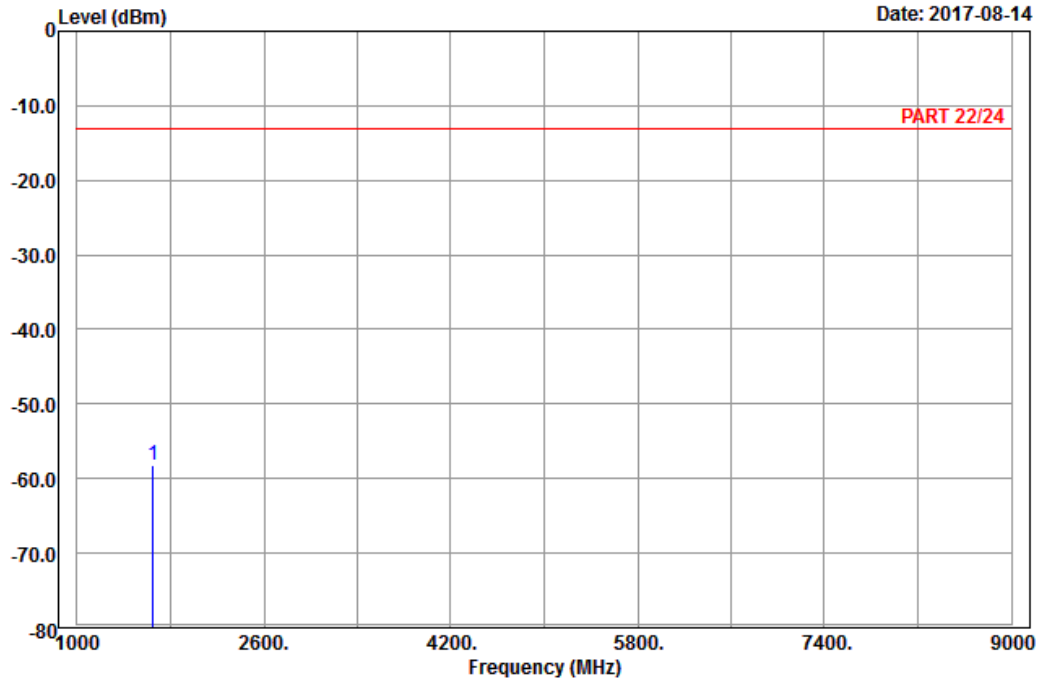

Site : 966 chamber 1
Condition: PART 22/24 Horizontal
Remark : Band V_Link_CH4132
Tested by: Harry Hsueh

	Read	Limit	Over			
Freq	Level	Level	Line	Limit	Factor	Remark
MHz	dBm	dBm	dBm	dB	dB	
1 pp 1652.80	-58.27	-66.00	-13.00	-45.27	7.73	Peak



Bureau Veritas Consumer Products Services Ltd., Taoyuan Branch

A D T

Data: 6

Date: 2017-08-14

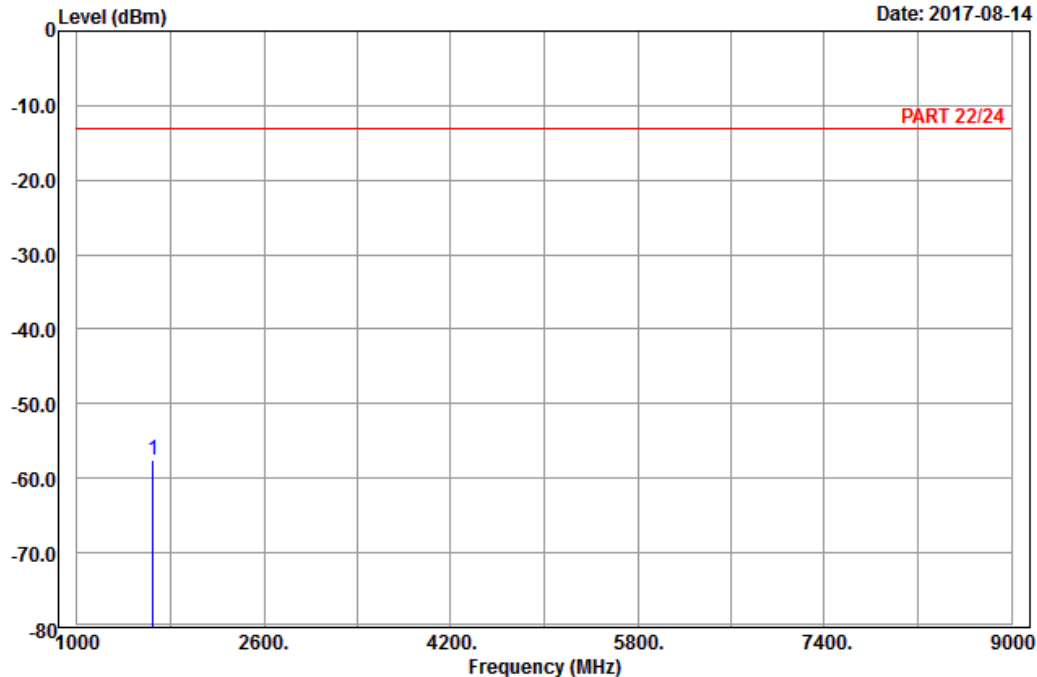

Site : 966 chamber 1
 Condition: PART 22/24 Vertical
 Remark : Band V_Link_CH4132
 Tested by: Harry Hsueh

	Freq	Level	Read Level	Limit Line	Over Limit	Factor	Remark
	MHz	dBm	dBm	dBm	dB	dB	
1 pp	1652.80	-57.44	-65.17	-13.00	-44.44	7.73	Peak

Frequency (MHz)	ERP(dBm)	Limit(dBm)	Over Limit (dB)	SPA. Reading (dBm)	S.G. Power (dBm)	TX Cable loss (dB)	TX Antenna Gain (dBi)	Polarization (H/V)	Result
1652.8	-58.27	-13	-45.27	-63.82	-58.05	3.704	5.63	H	Pass
1652.8	-57.44	-13	-44.44	-62.99	-57.22	3.704	5.63	V	Pass

Middle Channel



Bureau Veritas Consumer Products Services Ltd., Taoyuan Branch

A D T

Data: 5

Date: 2017-08-14

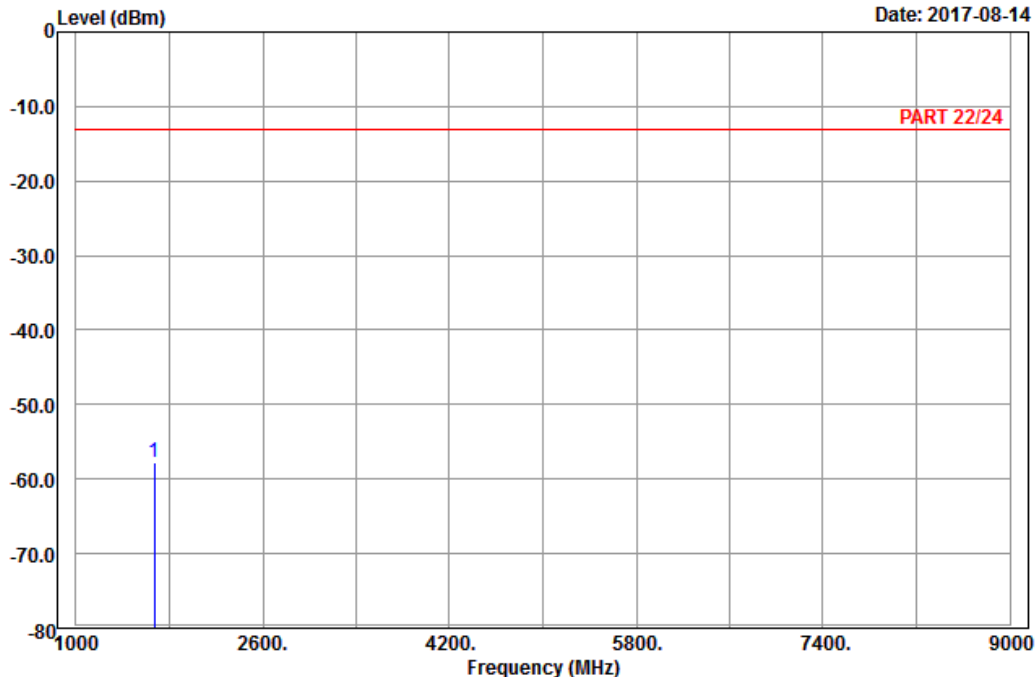

Site : 966 chamber 1
 Condition: PART 22/24 Horizontal
 Remark : Band V_Link_CH4182
 Tested by: Harry Hsueh

	Read	Limit	Over			
Freq	Level	Level	Line	Limit	Factor	Remark
MHz	dBm	dBm	dBm	dB	dB	
1 pp 1672.80	-57.87	-65.78	-13.00	-44.87	7.91	Peak



Bureau Veritas Consumer Products Services Ltd., Taoyuan Branch

A D T

Data: 6

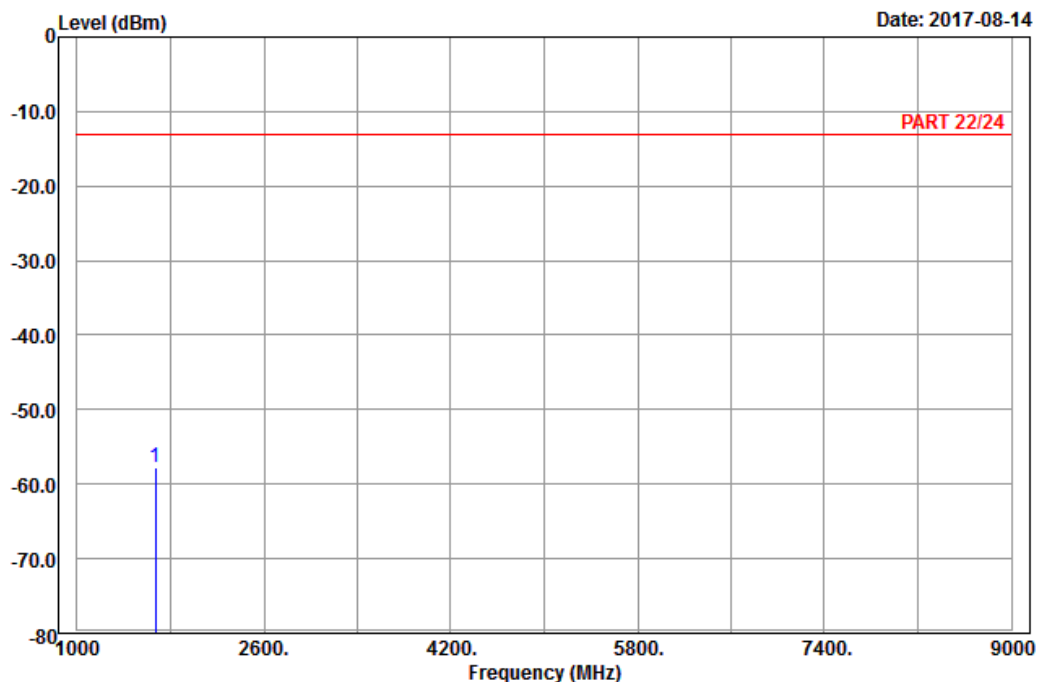

Site : 966 chamber 1
 Condition: PART 22/24 Vertical
 Remark : Band V_Link_CH4182
 Tested by: Harry Hsueh

Freq	Level	Read Level	Limit	Over Limit	Factor	Remark
MHz	dBm	dBm	dBm	dB	dB	
1 pp 1672.80	-57.83	-65.74	-13.00	-44.83	7.91	Peak

Frequency (MHz)	ERP(dBm)	Limit(dBm)	Over Limit (dB)	SPA. Reading (dBm)	S.G. Power (dBm)	TX Cable loss (dB)	TX Antenna Gain (dBi)	Polarization (H/V)	Result
1672.8	-57.87	-13	-44.87	-63.60	-57.65	3.704	5.63	H	Pass
1672.8	-57.83	-13	-44.83	-63.52	-57.61	3.704	5.63	V	Pass

High Channel



Bureau Veritas Consumer Products Services Ltd., Taoyuan Branch

A D T

Data: 5

Date: 2017-08-14

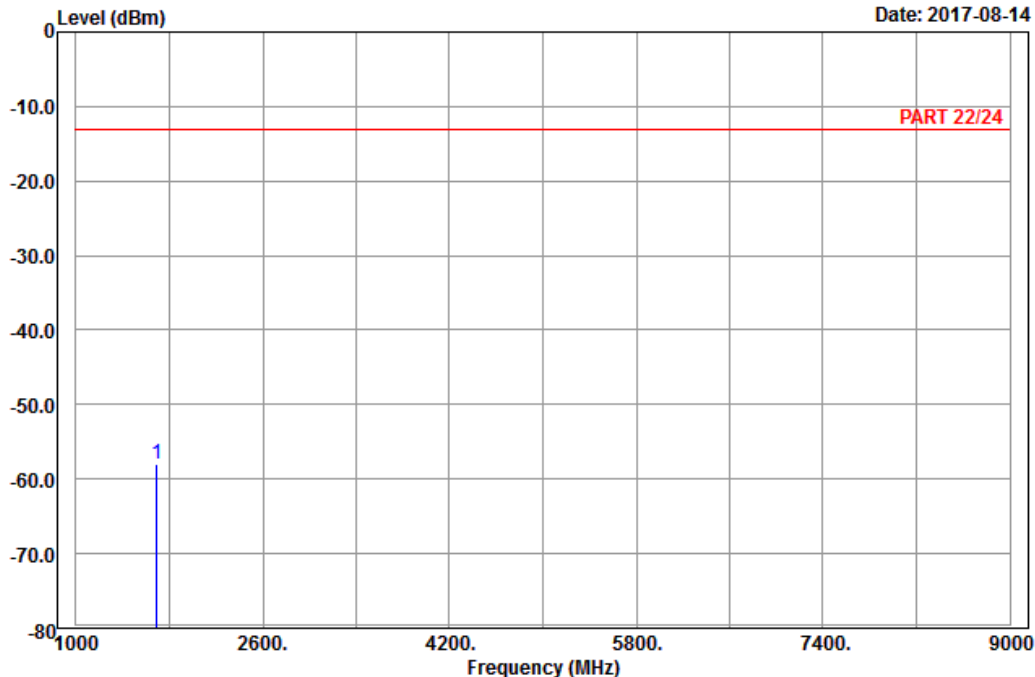

Site : 966 chamber 1
 Condition: PART 22/24 Horizontal
 Remark : Band V_Link_CH4233
 Tested by: Harry Hsueh

Freq	Level	Read Level	Limit	Over	Factor	Remark
MHz	dBm	dBm	dBm	dB	dB	
1 pp 1693.20	-57.93	-66.07	-13.00	-44.93	8.14	Peak



Bureau Veritas Consumer Products Services Ltd., Taoyuan Branch

A D T

Data: 6

Date: 2017-08-14

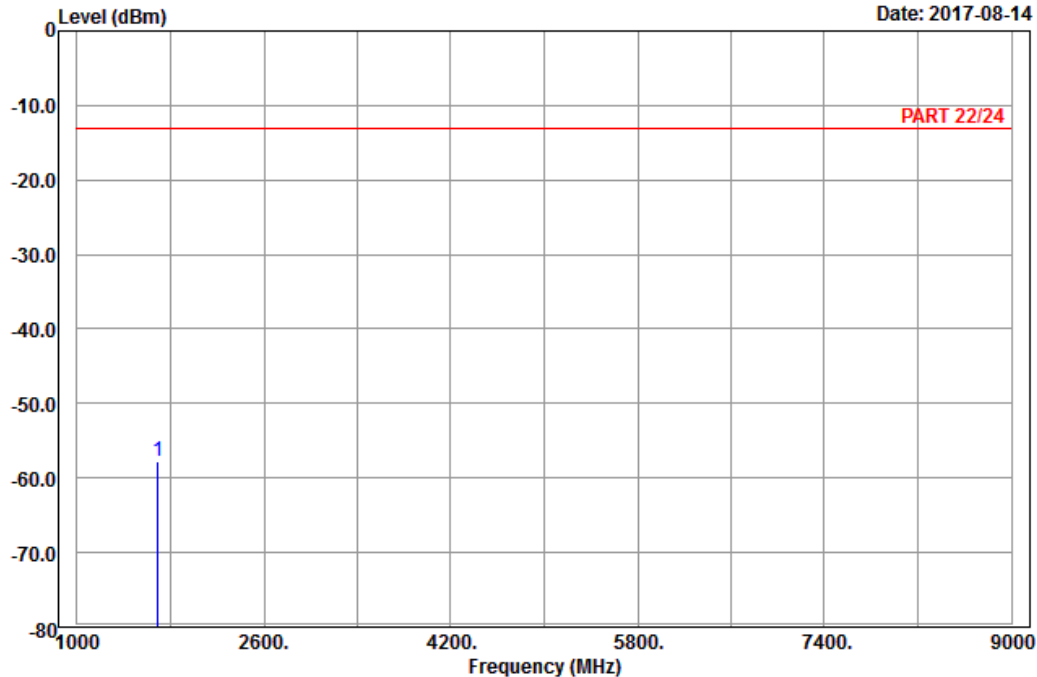

Site : 966 chamber 1
 Condition: PART 22/24 Vertical
 Remark : Band V_Link_CH4233
 Tested by: Harry Hsueh

	Freq	Level	Read Level	Limit Line	Over Limit	Factor	Remark
	MHz	dBm	dBm	dBm	dB	dB	
1 pp	1693.20	-57.81	-65.95	-13.00	-44.81	8.14	Peak

Frequency (MHz)	ERP(dBm)	Limit(dBm)	Over Limit (dB)	SPA. Reading (dBm)	S.G. Power (dBm)	TX Cable loss (dB)	TX Antenna Gain (dBi)	Polarization (H/V)	Result
1693.2	-57.93	-13	-44.93	-63.89	-57.71	3.704	5.63	H	Pass
1693.2	-57.81	-13	-44.81	-63.76	-57.59	3.704	5.63	V	Pass

5 Pictures of Test Arrangements

Please refer to the attached file (Test Setup Photo).

Appendix – Information on the Testing Laboratories

We, Bureau Veritas Consumer Products Services (H.K.) Ltd., Taoyuan Branch, were founded in 1988 to provide our best service in EMC, Radio, Telecom and Safety consultation. Our laboratories are FCC recognized accredited test firms and accredited according to ISO/IEC 17025.

If you have any comments, please feel free to contact us at the following:

Linko EMC/RF Lab

Tel: 886-2-26052180

Fax: 886-2-26051924

Hsin Chu EMC/RF/Telecom Lab

Tel: 886-3-6668565

Fax: 886-3-6668323

Hwa Ya EMC/RF/Safety

Tel: 886-3-3183232

Fax: 886-3-3270892

Email: service.adt@tw.bureauveritas.com

Web Site: www.bureauveritas-adt.com

The address and road map of all our labs can be found in our web site also.

--- END ---