

# Hearing Aid Compatibility (HAC) RF Emissions Test Report

APPLICANT : BlackBerry Ltd.  
EQUIPMENT : GSM Quad-band/HSPA-UMTS  
Penta-band/LTE Deca-band mobile phone  
BRAND NAME : BlackBerry  
MODEL NAME : BBA100-1  
MARKETING NAME : DTEK60  
FCC ID : L6ABBA1001  
STANDARD : FCC 47 CFR §20.19  
ANSI C63.19-2011

We, SPORTON INTERNATIONAL (KUNSHAN) INC., would like to declare that the tested sample has been evaluated in accordance with the procedures and had been in compliance with the applicable technical standards.

The test results in this report apply exclusively to the tested model / sample. Without written approval of SPORTON INTERNATIONAL (KUNSHAN) INC., the test report shall not be reproduced except in full.



Prepared by: Mark Qu / Manager



Approved by: Jones Tsai / Manager



**SPORTON INTERNATIONAL (KUNSHAN) INC.**  
No. 3-2, PingXiang Road, Kunshan, Jiangsu Province, P. R. China



**Table of Contents**

1. **Attestation of Test Results**..... 4

2. **Administration Data**..... 4

3. **Equipment Under Test Information** ..... 5

    3.1 General Information..... 5

    3.2 Accessories and Support Equipment..... 6

    3.3 Air Interface and Operating Mode..... 7

    3.4 Applied Standards ..... 7

4. **HAC RF Emission**..... 8

5. **Measurement System Specification**..... 9

    5.1 Test Arch Phantom ..... 9

    5.2 E-Field Probe System .....10

    5.3 System Hardware .....10

    5.4 Data Storage and Evaluation.....11

    5.5 Test Equipment List .....12

6. **Measurement System Validation** .....13

    6.1 Purpose of System Performance Check.....13

    6.2 System Setup.....13

    6.3 Verification Results .....14

7. **RF Emissions Test Procedure**.....15

8. **Modulation Interference Factor**.....18

9. **Low-power Exemption**.....20

10. **Conducted RF Output Power (Unit: dBm)**.....22

11. **HAC RF Emission Test Results**.....23

12. **Uncertainty Assessment** .....24

13. **References**.....26

- Appendix A. Plots of System Performance Check
- Appendix B. Plots of RF Emission Measurement
- Appendix C. DASY Calibration Certificate
- Appendix D. Test Setup Photos





### 1. Attestation of Test Results

Applicant Name	BlackBerry Ltd.
Equipment Name	GSM Quad-band/HSPA-UMTS Penta-band/LTE Deca-band mobile phone
Brand Name	BlackBerry
Model Name	BBA100-1
Marketing Name	DTEK60
FCC ID	L6ABBA1001
IMEI Code	004402243144304
HW Version	PIO
SW Version	AAF884
EUT Stage	Identical Prototype
Exposure category	General Population/Uncontrolled Exposure
HAC Rating	M4
Date Tested	2016/8/15
Test Result	Pass

This device is compliance with HAC limits specified in guidelines FCC 47 CFR §20.19 and ANSI Standard ANSI C63.19.

### 2. Administration Data

Testing Laboratory	
Test Site	SPORTON INTERNATIONAL (KUNSHAN) INC.
Test Site Location	No. 3-2, PingXiang Road, Kunshan, Jiangsu Province, P. R. China TEL: +86-0512-5790-0158 FAX: +86-0512-5790-0958
Test Site No.	<b>Sporton Site No. :</b> SAR01-KS
Applicant	
Company Name	BlackBerry Ltd.
Address	2200 University Ave E., Waterloo, ON, CAN. N2K0A7
Manufacturer	
Company Name	TCL Communication Ltd.
Address	5F, C building, No. 232, Liang Jing Road ZhangJiang High-Tech Park, Pudong Area Shanghai, P.R. China. 201203

**3. Equipment Under Test Information**

**3.1 General Information**

Product Feature & Specification	
<b>Frequency Band</b>	GSM850: 824.2 MHz ~ 848.8 MHz GSM1900: 1850.2 MHz ~ 1909.8 MHz WCDMA Band II: 1852.4 MHz ~ 1907.6 MHz WCDMA Band IV: 1712.4 MHz ~ 1752.6 MHz WCDMA Band V: 826.4 MHz ~ 846.6 MHz LTE Band 2: 1850 MHz ~ 1910 MHz LTE Band 4: 1710 MHz ~ 1755 MHz LTE Band 5: 824.7 MHz ~ 848.3 MHz LTE Band 7: 2500 MHz ~ 2570 MHz LTE Band 12: 699.7 MHz ~ 715.3 MHz LTE Band 17: 704 MHz ~ 716 MHz WLAN 2.4GHz Band: 2412 MHz ~ 2462 MHz WLAN 5.2GHz Band: 5180 MHz ~ 5240 MHz WLAN 5.3GHz Band: 5260 MHz ~ 5320 MHz WLAN 5.5GHz Band: 5500 MHz ~ 5720 MHz WLAN 5.8GHz Band: 5745 MHz ~ 5825 MHz Bluetooth: 2402 MHz ~ 2480 MHz NFC : 13.56 MHz
<b>Mode</b>	<ul style="list-style-type: none"> <li>· GSM/GPRS/EGPRS</li> <li>· RMC/AMR 12.2Kbps</li> <li>· HSDPA</li> <li>· HSUPA</li> <li>· DC-HSDPA</li> <li>· HSPA+ (16QAM uplink is not supported)</li> <li>· LTE: QPSK, 16QAM</li> <li>· 802.11b/g/n HT20</li> <li>· 802.11a/n HT20/HT40</li> <li>· 802.11ac VHT20/VHT40/VHT80</li> <li>· Bluetooth v3.0+EDR, Bluetooth v4.0 LE, Bluetooth 4.2 LE</li> <li>· NFC: ASK</li> </ul>
<b>Note:</b>	
1. This device supports VoLTE function. 2. When the phone is in talking mode and receiver worked, then power reduction will be implemented immediately in WLAN 2.4GHz, WLAN5GHz, but all WWAN power are full power. 3. When the phone receiver is not worked, GSM1900/WCDMA Band II/IV/LTE Band 2/4 with reduced power, others WWAN band and all WLAN 2.4GHz and WLAN 5GHz are full power.	



**3.2 Accessories and Support Equipment**

Specification of Accessory				
AC Adapter 1	Brand Name	N/A	Model Name	QC10US
	Power Rating	I/P: 100-240Vac, 500mA, O/P: 5Vdc, 2000mA/9Vdc, 1670mA		
	Manufacturer	BYD	S/N	CBA0060AGHC1
AC Adapter 2	Brand Name	N/A	Model Name	QC10EU
	Power Rating	I/P: 100-240Vac, 500mA, O/P: 5Vdc, 2000mA/9Vdc, 1670mA		
	Manufacturer	BYD	S/N	CBA0060AAHC1
AC Adapter 3	Brand Name	N/A	Model Name	QC10UK
	Power Rating	I/P: 100-240Vac, 500mA, O/P: 5Vdc, 2000mA/9Vdc, 1670mA		
	Manufacturer	BYD	S/N	CBA0060ABHC1
AC Adapter 4	Brand Name	N/A	Model Name	QC10AU
	Power Rating	I/P: 100-240Vac, 500mA, O/P: 5Vdc, 2000mA/9Vdc, 1670mA		
	Manufacturer	BYD	S/N	CBA0060ACHC1
Battery 1	Brand Name	N/A	Model Name	TLp030F2
	Power Rating	3.84Vdc, 3000mAh		
	Manufacturer	SCUD	S/N	CAC3000027C2
Battery 2	Brand Name	N/A	Model Name	TLp030F1
	Power Rating	3.84Vdc, 3000mAh		
	Manufacturer	BYD	S/N	CAC3000026C1
USB Cable	Brand Name	N/A	Model Name	CDA0000078CF
	Signal Line Type	1.00m shielded without core		
Earphone	Brand Name	N/A	Model Name	CCB0045A16C3
	Signal Line Type	1.24m non-shielded without core		



**3.3 Air Interface and Operating Mode**

Air Interface	Band MHz	Type	C63.19 Tested	Simultaneous Transmitter	OTT	Power Reduction
GSM	850	VO	Yes	WLAN, BT	NA	No
	1900			WLAN, BT	NA	Yes
	GPRS/EDGE	DT	No	WLAN, BT	Yes	Yes
WCDMA	Band V	VO	No <sup>(1)</sup>	WLAN, BT	NA	No
	Band IV			WLAN, BT	NA	Yes
	Band II			WLAN, BT	NA	Yes
	HSPA	DT	No	WLAN, BT	Yes	Yes
LTE	Band 2	VD	No <sup>(1,3)</sup>	WLAN, BT	Yes	Yes
	Band 4			WLAN, BT		Yes
	Band 5			WLAN, BT		No
	Band 7			WLAN, BT		No
	Band 12			WLAN, BT		No
	Band 17			WLAN, BT		No
WLAN	2450	VD	No <sup>(2,3)</sup>	GSM, WCDMA, LTE	Yes	Yes
	5200			GSM, WCDMA, LTE		Yes
	5300			GSM, WCDMA, LTE		Yes
	5500			GSM, WCDMA, LTE		Yes
	5800			GSM, WCDMA, LTE		Yes
BT	2450	DT	No	GSM, WCDMA, LTE	NA	No

VO=CMRS Voice Service  
 DT=Digital Transport  
 VD=CMRS IP Voice Service and Digital Transport

Remark:

- WCDMA and LTE is exempted from testing by low power exemption that its average antenna input power plus its MIF is  $\leq 17$  dBm, and is rated as M4
- For 2.4GHz WLAN RF emissions testing exemption shall be applied to an RF air interface technology in a device whose Peak antenna input power, averaged over intervals  $\leq 50 \mu s$ , is  $\leq 23$  dBm.
- No Associated T-Coil measurement has been made in accordance with KDB 285076 D02 T-Coil testing for CMRS IP

**3.4 Applied Standards**

- FCC CFR47 Part 20.19
- ANSI C63.19 2011-version
- FCC KDB 285076 D01 HAC Guidance v04r01
- FCC KDB 285076 D02 T Coil testing for CMRS IP v02

**4. HAC RF Emission**

FCC wireless hearing aid compatibility rules ensure that consumers with hearing loss are able to access wireless communications services through a wide selection of handsets without experiencing disabling radio frequency (RF) interference or other technical obstacles.

To define and measure the hearing aid compatibility of handsets, in CFR47 part 20.19 ANSI C63.19 is referenced. A handset is considered hearing aid-compatible for acoustic coupling if it meets a rating of at least M3 under ANSI C63.19, and A handset is considered hearing aid compatible for inductive coupling if it meets a rating of at least T3.

According to ANSI C63.19 2011 version, for acoustic coupling, the RF electric field emissions of wireless communication devices should be measured and rated according to the emission level as below.

Emission Categories	E-field emissions	
	<960Mhz	>960Mhz
<b>M1</b>	<b>50 to 55 dB (V/m)</b>	<b>40 to 45 dB (V/m)</b>
<b>M2</b>	<b>45 to 50 dB (V/m)</b>	<b>35 to 40 dB (V/m)</b>
<b>M3</b>	<b>40 to 45 dB (V/m)</b>	<b>30 to 35 dB (V/m)</b>
<b>M4</b>	<b>&lt;40 dB (V/m)</b>	<b>&lt;30 dB (V/m)</b>

**Table 4.1 Telephone near-field categories in linear units**



### 5. Measurement System Specification

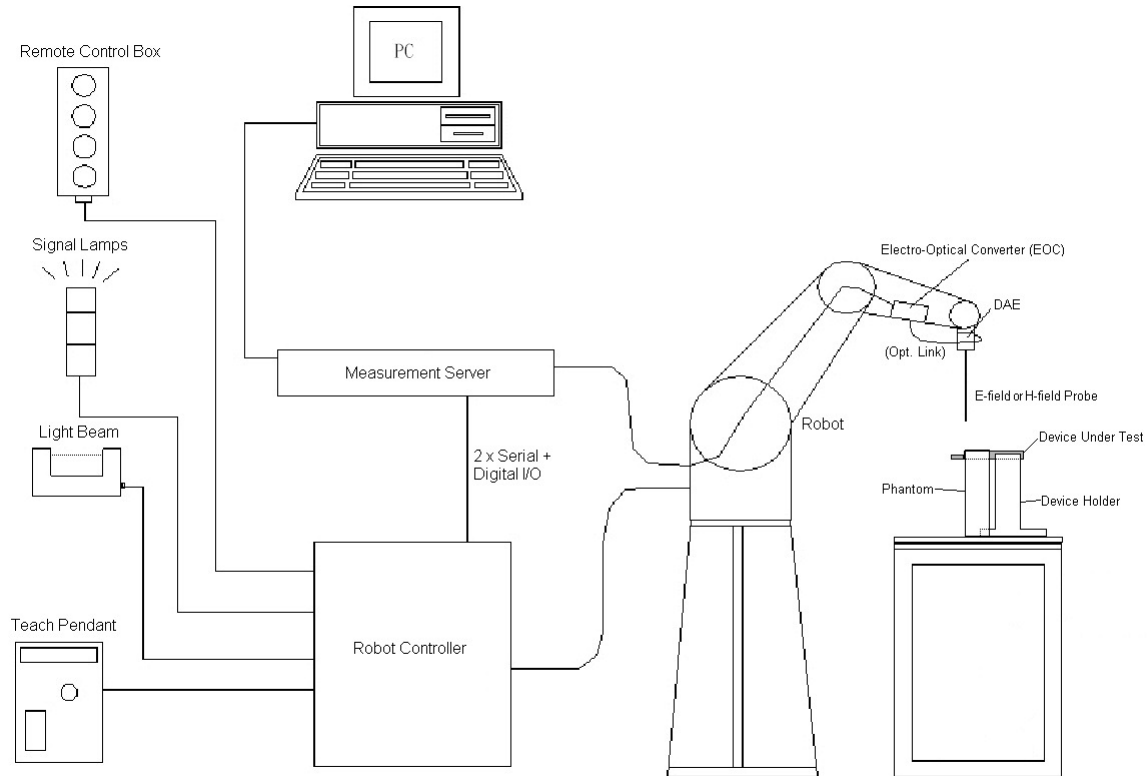

Fig 5.1 SPEAG DASY5 System Configurations

#### 5.1 Test Arch Phantom

<b>Construction :</b>	Enables easy and well defined positioning of the phone and validation dipoles as well as simple teaching of the robot.	
<b>Dimensions :</b>	370x 370 x 370 mm	

Fig 5.8 Photo of Arch Phantom

**5.2 E-Field Probe System**

**E-Field Probe Specification**

<ER3DV6>

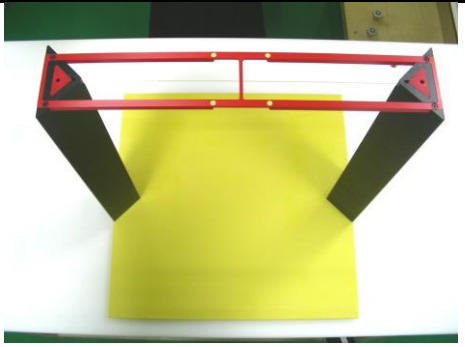
<b>Construction</b>	One dipole parallel, two dipoles normal to probe axis Built-in shielding against static charges
<b>Calibration</b>	In air from 100 MHz to 3.0 GHz (absolute accuracy $\pm 6.0\%$ , $k=2$ )
<b>Frequency</b>	100 MHz to 6 GHz; Linearity: $\pm 2.0$ dB (100 MHz to 3 GHz)
<b>Directivity</b>	$\pm 0.2$ dB in air (rotation around probe axis) $\pm 0.4$ dB in air (rotation normal to probe axis)
<b>Dynamic Range</b>	2 V/m to 1000 V/m (M3 or better device readings fall well below diode compression point)
<b>Linearity</b>	$\pm 0.2$ dB
<b>Dimensions</b>	Overall length: 330 mm (Tip: 16 mm) Tip diameter: 8 mm (Body: 12 mm) Distance from probe tip to dipole centers: 2.5 mm



**Fig 5.2 Photo of E-field Probe**

**Probe Tip Description:**

HAC field measurements take place in the close near field with high gradients. Increasing the measuring distance from the source will generally decrease the measured field values (in case of the validation dipole approx. 10% per mm).

**5.3 System Hardware**

**DAE**

The data acquisition electronics (DAE) consists of a highly sensitive electrometer-grade preamplifier with auto-zeroing, a channel and gain-switching multiplexer, a fast 16 bit AD-converter and a command decoder and control logic unit.

**Robot**

The SPEAG DASY system uses the high precision robots (DASY5: TX90XL) type from Stäubli SA (France). For the 6-axis controller system, the robot controller version (DASY5: CS8c) from Stäubli is used.

**5.4 Data Storage and Evaluation**

The DASY software stores the assessed data from the data acquisition electronics as raw data (in microvolt readings from the probe sensors), together with all the necessary software parameters for the data evaluation (probe calibration data, and device frequency and modulation data) in measurement files.

<b>Probe parameters :</b>	- Sensitivity	Norm <sub>i</sub> , a <sub>i0</sub> , a <sub>i1</sub> , a <sub>i2</sub>
	- Conversion factor	ConvF <sub>i</sub>
	- Diode compression point	dcp <sub>i</sub>
<b>Device parameters :</b>	- Frequency	f
	- Crest factor	cf
<b>Media parameters :</b>	- Conductivity	σ
	- Density	ρ

The formula for each channel can be given as :

$$V_i = U_i + U_i^2 \cdot \frac{cf}{dcp_i}$$

- with V<sub>i</sub> = compensated signal of channel i, (i = x, y, z)
- U<sub>i</sub> = input signal of channel i, (i = x, y, z)
- cf = crest factor of exciting field (DASY parameter)
- dcp<sub>i</sub> = diode compression point (DASY parameter)

From the compensated input signals, the primary field data for each channel can be evaluated :

$$\text{E-field Probes : } E_i = \sqrt{\frac{V_i}{\text{Norm}_i \cdot \text{ConvF}}}$$

- with V<sub>i</sub> = compensated signal of channel i, (i = x, y, z)
- Norm<sub>i</sub> = sensor sensitivity of channel i, (i = x, y, z), μV/(V/m)<sup>2</sup> for E-field Probes
- ConvF = sensitivity enhancement in solution
- f = carrier frequency [GHz]
- E<sub>i</sub> = electric field strength of channel i in V/m

The RSS value of the field components gives the total field strength (Hermitian magnitude) :

$$E_{\text{tot}} = \sqrt{E_x^2 + E_y^2 + E_z^2}$$

The primary field data are used to calculate the derived field units.



5.5 Test Equipment List

Manufacturer	Name of Equipment	Type/Model	Serial Number	Calibration	
				Last Cal.	Due Date
SPEAG	Dipole	CD835V3	1171	Jan. 27, 2016	Jan. 26, 2017
SPEAG	Dipole	CD1880V3	1155	Jan. 27, 2016	Jan. 26, 2017
SPEAG	Data Acquisition Electronics	DAE4	1210	May 18, 2016	May 17, 2017
SPEAG	Probe	ER3DV6	2476	Nov. 25, 2015	Nov. 24, 2016
SPEAG	Test Arch Phantom	Par phantom	1105	NCR	NCR
SPEAG	Phone Positioner	N/A	N/A	NCR	NCR
Agilent	Wireless Communication Test Set	E5515C	MY52102706	Apr. 22, 2016	Apr. 21, 2017
Anritsu	Radio communication analyzer	MT8820C	6201300654	Aug. 08, 2016	Aug. 07, 2017
AR	Amplifier	551G4	333096	NCR	NCR
Anritsu	Power Sensor	MA2411B	0917070	Jan. 20, 2016	Jan. 19, 2017
Anritsu	Power Meter	ML2495A	1005002	Jan. 20, 2016	Jan. 19, 2017
ARRA	Power Divider	A3200-2	N/A	NA	NA
MCL	Attenuation	BW-S10W5	N/A	NA	NA

Table 5.1 Test Equipment List

Note: NCR: "No-Calibration Required".

## 6. Measurement System Validation

Each DASY system is equipped with one or more system validation kits. These units, together with the predefined measurement procedures within the DASY software, enable the user to conduct the system performance check and system validation. System validation kit includes a dipole, tripod holder to fix it underneath the test Arch and a corresponding distance holder.

### 6.1 Purpose of System Performance Check

The system performance check verifies that the system operates within its specifications. System and operator errors can be detected and corrected. It is recommended that the system performance check be performed prior to any usage of the system in order to guarantee reproducible results. The system performance check uses normal HAC measurements in a simplified setup with a well characterized source. This setup was selected to give a high sensitivity to all parameters that might fail or vary over time. The system check does not intend to replace the calibration of the components, but indicates situations where the system uncertainty is exceeded due to drift or failure.

### 6.2 System Setup

1. In the simplified setup for system evaluation, the EUT is replaced by a calibrated dipole and the power source is replaced by a continuous wave which comes from a signal generator.
2. The center point of the probe element(s) is 15mm from the closest surface of the dipole elements.
3. The calibrated dipole must be placed beneath the arch phantom. The equipment setup is shown below:

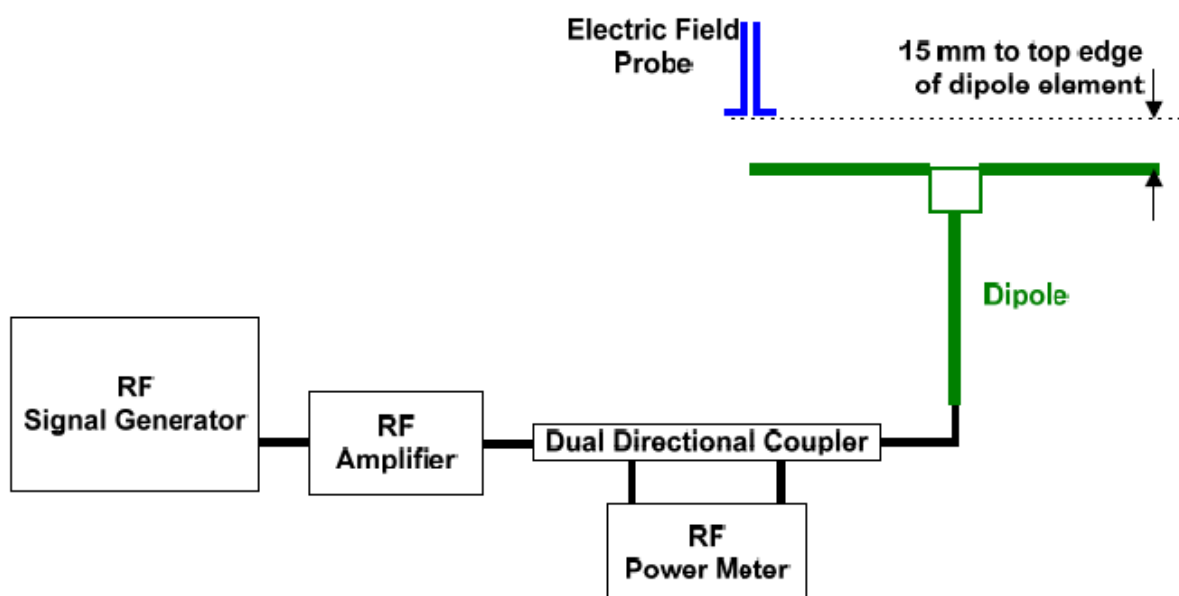
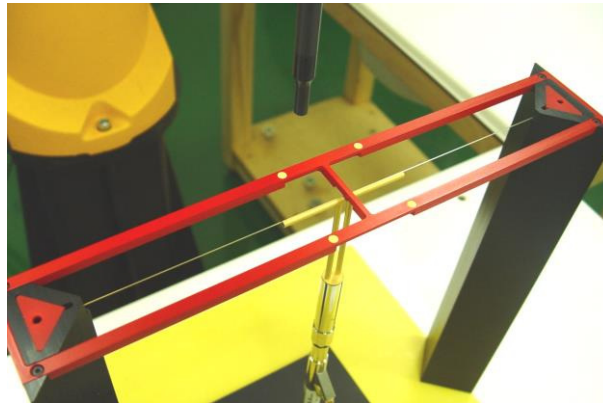

Fig. 6.1 System Validation Setup

The output power on dipole port must be calibrated to 20dBm (100mW) before dipole is connected.



**Fig 7.2 Dipole Setup**

**6.3 Verification Results**

Comparing to the original E-field value provided by SPEAG, the verification data should be within its specification of 25 %. Table 6.1 shows the target value and measured value. The table below indicates the system performance check can meet the variation criterion and the plots can be referred to appendix A of this report.

Frequency (MHz)	Input Power (dBm)	Target Value (V/m)	E-Field above high end (V/m)	E-Field above low end (V/m)	Average Value (V/m)	Deviation (%)	Date
835	20	106	108.5	99.44	103.97	-1.92	Aug. 15, 2016
1880	20	89.1	86.94	86.56	86.75	-2.64	Aug. 15, 2016

**Table 6.1 Test Results of System Validation**

**Note: Deviation = ((Average E-field Value) - (Target value)) / (Target value) \* 100%**



## 7. RF Emissions Test Procedure

Referenced from ANSI C63.19 -2011 section 5.5.1

- a) Confirm the proper operation of the field probe, probe measurement system, and other instrumentation and the positioning system.
- b) Position the WD in its intended test position.
- c) Set the WD to transmit a fixed and repeatable combination of signal power and modulation characteristic that is representative of the worst case (highest interference potential) encountered in normal use. Transiently occurring start-up, changeover, or termination conditions, or other operations likely to occur less than 1% of the time during normal operation, may be excluded from consideration.
- d) The center sub-grid shall be centered on the T-Coil mode perpendicular measurement point or the acoustic output, as appropriate. Locate the field probe at the initial test position in the 50 mm by 50 mm grid, which is contained in the measurement plane, refer to illustrated in Figure 8.2. If the field alignment method is used, align the probe for maximum field reception.
- e) Record the reading at the output of the measurement system.
- f) Scan the entire 50 mm by 50 mm region in equality spaced increments and record the reading at each measurement point, The distance between measurement points shall be sufficient to assure the identification of the maximum reading.
- g) Identify the five contiguous sub-grids around the center sub-grid whose maximum reading is the lowest of all available choices. This eliminates the three sub-grids with the maximum readings. Thus, the six areas to be used to determine the WD's highest emissions are identified.
- h) Identify the maximum reading within the non-excluded sub-grids identified in step g).
- i) *Indirect measurement method*  
The RF audio interference level in dB (V/m) is obtained by adding the MIF (in dB) to the maximum steady-state rms field-strength reading, in dB (V/m)
- j) Compare this RF audio interference level with the categories in ANSI C63.19-2011 clause 8 and record the resulting WD category rating.
- k) For the T-Coil mode M-rating assessment, determine whether the chosen perpendicular measurement point is contained in an included sub-grid of the first scan. If so, then a second scan is not necessary. The first scan and resultant category rating may be used for the T-Coil mode M rating.

Otherwise, repeat step a) through step i), with the grid shifted so that it is centered on the perpendicular measurement point. Record the WD category rating.

### Test Instructions

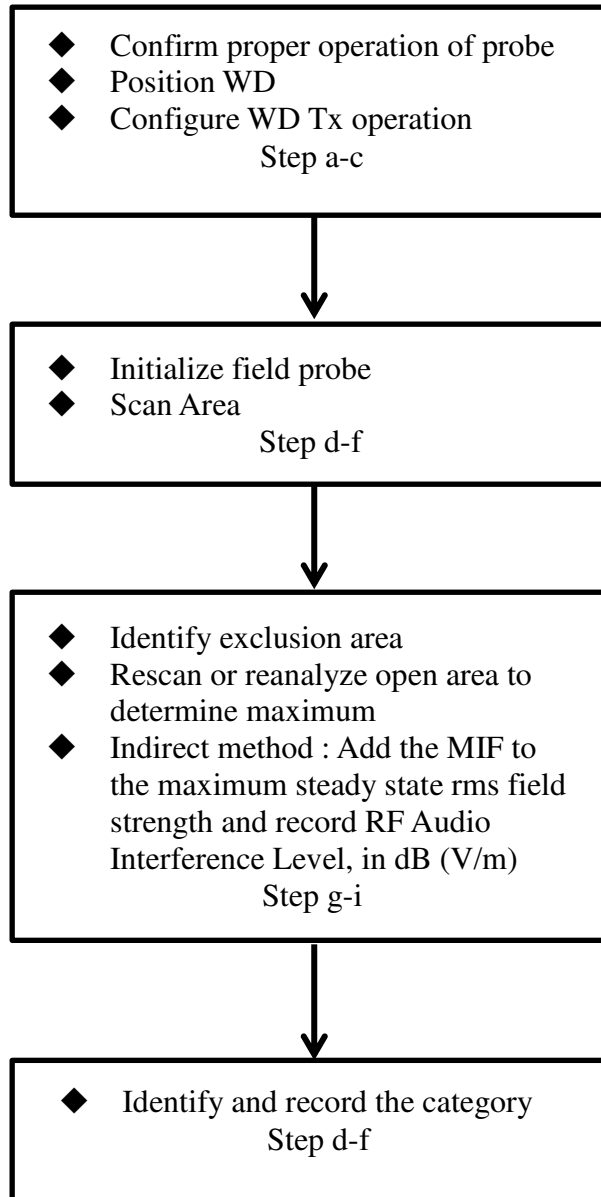

Fig 8.1 Flow Chart of HAC RF Emission





Fig 8.2 EUT reference and plane for HAC RF emission measurements

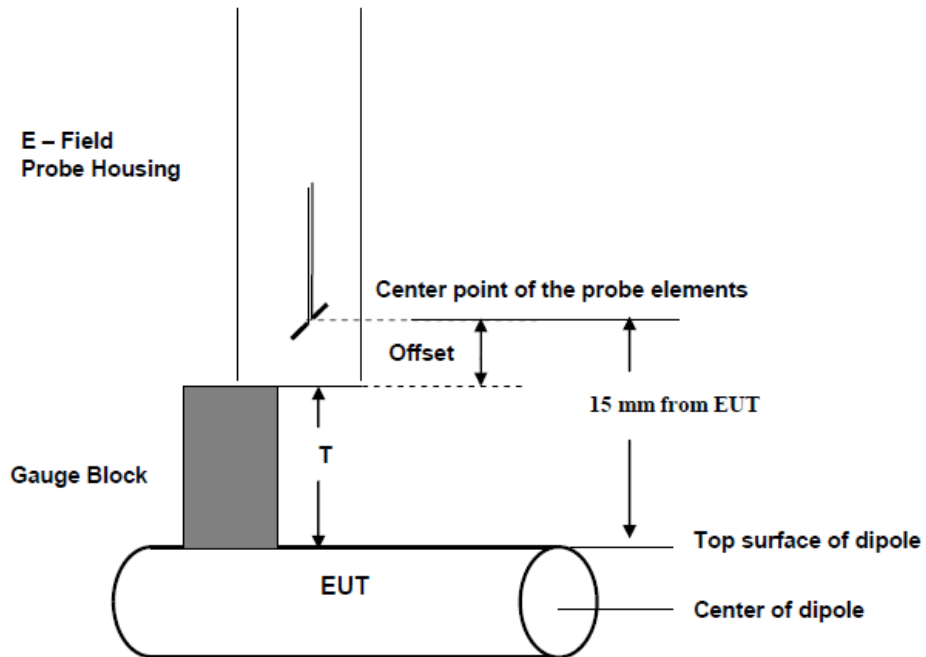

Fig. 8.3 Gauge block with E-field probe



## 8. Modulation Interference Factor

For any specific fixed and repeatable modulated signal, a modulation interference factor (MIF, expressed in dB) may be determined that relates its interference potential to its steady-state RMS signal level or average power level. This factor is a function only of the audio-frequency amplitude modulation characteristics of the signal and is the same for field-strength and conducted power measurements. The MIF is valid only for a specific repeatable audio-frequency amplitude modulation characteristic; any change in modulation characteristic requires determination and application of a new MIF.

The MIF may be determined using a radiated RF field or a conducted RF signal:

- 1). Using RF illumination or conducted coupling, apply the specific modulated signal in question to the measurement system at a level within its confirmed operating dynamic range.
- 2). Measure the steady-state RMS level at the output of the fast probe or sensor.
- 3). Measure the steady-state average level at the weighting output.
- 4). Without changing the square-law detector or weighting system, and using RF illumination or conducted coupling, substitute for the specific modulated signal a 1 kHz, 80% amplitude modulated carrier at the same frequency and adjust its strength until the level at the weighting output equals the step c) measurement.
- 5). Without changing the carrier level from step d), remove the 1 kHz modulation and again measure the steady-state RMS level indicated at the output of the fast probe or sensor.
- 6). The MIF for the specific modulation characteristic is provided by the ratio of the step e) measurement to the step b) measurement, expressed in dB ( $20 \times \log[(\text{step e})/(\text{step b})]$ ).

The following procedure was used to measure the MIF using the SPEAG Audio Interference Analyzer

- 1). The device was placed into a simulated call using a base station simulator or set to transmit using test software for a given mode.
- 2). The device was then set to continuously transmit at maximum power.
- 3). Using a coupler if needed, the device output signal was connected to the RF In port of the Audio Interference Analyzer, which was connected to a desktop computer. Alternatively, a radiated RF signal may be used with the Audio Interference Analyzer's built-in antenna.
- 4). The MIF measurement procedure in the DASY software was run, and the resulting MIF value was recorded.
- 5). Steps 1-4 were repeated for all CMRS air interfaces, frequency bands, and modulations.

The modulation interference factors obtained were applied to readings taken of the actual wireless device in order to obtain an accurate audio interference level reading using the formula:

$$\text{Audio Interference Level [dB(V/m)]} = 20 * \log[\text{Raw Field Value (V/m)}] + \text{MIF (dB)}$$

Because the MIF value is output power independent, MIF values for a given mode should be constant across all devices; however, per C63.19-2011 §D.7, MIF values should be measured for each device being evaluated. The voice modes for this device have been investigated in this section of the report.



**Measured Modulation Interference Factors**

Mode	GSM850			GSM1900		
	128	189	251	512	661	810
GSM	3.53	3.53	3.53	3.50	3.50	3.51

Mode	UMTS Band V			UMTS Band II			UMTS Band IV		
	4132	4182	4233	9262	9400	9538	1312	1413	1513
AMR 12.2kbps	-22.06	-19.66	-20.13	-18.07	-18.32	-18.19	-18.47	-20.44	-18.52

LTE Band	Frequency	Channel	Bandwidth	Mode	RB Size	RB Offset	MIF
2	1880	18900	20MHz	QPSK	1	0	-14.42
4	1732.5	20175	20MHz	QPSK	1	0	-14.16
5	836.5	20525	10MHz	QPSK	1	0	-14.54
7	2535	21100	20MHz	QPSK	1	0	-14.31
12	707.5	23095	10MHz	QPSK	1	0	-14.2
17	710	23790	10MHz	QPSK	1	0	-14.08
17	710	23790	10MHz	16QAM	1	0	-11.01
17	710	23790	10MHz	16QAM	1	25	-10.74
17	710	23790	10MHz	16QAM	1	49	-10.82
17	710	23790	10MHz	16QAM	25	0	-15.36
17	710	23790	10MHz	16QAM	50	0	-17.21
17	710	23790	5MHz	16QAM	1	12	-10.79
2	1880	18900	20MHz	16QAM	1	50	-10.47
4	1732.5	20175	20MHz	16QAM	1	50	-10.45
5	836.5	20525	10MHz	16QAM	1	25	-10.06
7	2535	21100	20MHz	16QAM	1	50	-10.46
12	707.5	23095	10MHz	16QAM	1	25	-10.91



**9. Low-power Exemption**

Receiver Worked:

<Full Power Max Tune-up Limit>

Mode		Average Power (dBm)
GSM	GSM850	33.50
	GSM1900	31.00
WCDMA	Band V	24.00
	Band IV	24.50
	Band II	24.30
LTE	Band 2	24.00
	Band 4	24.50
	Band 5	24.00
	Band 7	24.50
	Band 12	24.00
	Band 17	24.00
2.4GHz WLAN		18.50
5.2GHz WLAN		15.50
5.3GHz WLAN		15.50
5.5GHz WLAN		17.00
5.8GHz WLAN		17.00

Receiver Not Worked:

< Reduced Power Max Tune-up Limit>

Mode		Average Power (dBm)
GSM	GSM1900	29.00
WCDMA	Band IV	21.30
	Band II	20.50
LTE	Band 2	20.00
	Band 4	21.50
2.4GHz WLAN		14.50
5.2GHz WLAN		12.50
5.3GHz WLAN		13.00
5.5GHz WLAN		10.50
5.8GHz WLAN		10.50



<Low Power Exemption>

Air Interface	Max Average Antenna Input Power (dBm)	Worst Case MIF (dB)	Power + MIF(dB)	C63.19 test required
GSM850	33.50	3.53	37.03	Yes
GSM1900	31.00	3.51	34.51	Yes
WCDMA Band V	24.00	-19.66	4.34	No
WCDMA Band IV	24.50	-18.47	6.03	No
WCDMA Band II	24.30	-18.07	6.23	No
LTE Band 2	24.00	-10.06	13.94	No
LTE Band 4	24.50	-10.06	14.44	No
LTE Band 5	24.00	-10.06	13.94	No
LTE Band 7	24.50	-10.06	14.44	No
LTE Band 12	24.00	-10.06	13.94	No
LTE Band 17	24.00	-10.06	13.94	No
2.4GHz WLAN	18.50			No
5.2GHz WLAN	15.00			No
5.3GHz WLAN	15.50			No
5.5GHz WLAN	17.00			No
5.8GHz WLAN	17.00			No

**General Note:**

1. According to ANSI C63.19 2011-version, for WWAN RF air interface technology of a device is exempt from testing when its average antenna input power plus its MIF is  $\leq 17$  dBm for any of its operating modes.
2. For WCDMA and LTE operation the worst case MIF plus the worst case average antenna input power for all modes are investigated to determine the testing requirements for this device.
3. According to ANSI C63.19 2011, for WLAN RF emissions testing exemption shall be applied to an RF air interface technology in a device whose Peak antenna input power, averaged over intervals  $\leq 50 \mu s$ , is  $\leq 23$  dBm.
4. HAC RF rating is M4 for the air interface which meets the low power exemption.



### 10. Conducted RF Output Power (Unit: dBm)

**Full Power:**

Average Antenna Input Power(dBm)						
Band	GSM850			GSM1900		
Channel	128	189	251	512	661	810
Frequency (MHz)	824.2	836.4	848.8	1850.2	1880.0	1909.8
GSM (GMSK, 1 Tx slot)	33.35	33.40	<b>33.45</b>	30.29	<b>30.61</b>	30.60

Band	WCDMA II			WCDMA IV			WCDMA V			
TX Channel	9262	9400	9538	1312	1413	1513	4132	4182	4233	
Rx Channel	9662	9800	9938	1537	1638	1738	4357	4407	4458	
Frequency (MHz)	1852.4	1880	1907.6	1712.4	1732.6	1752.6	826.4	836.4	846.6	
3GPP Rel 99	AMR 12.2Kbps	23.41	23.56	<b>23.73</b>	23.34	23.40	<b>23.60</b>	<b>23.67</b>	23.64	23.51

**Reduced Power Mode:**

Band	GSM1900		
Channel	512	661	810
Frequency (MHz)	1850.2	1880.0	1909.8
GSM (GMSK, 1 Tx slot)	28.63	<b>28.87</b>	28.81

Band	WCDMA II			WCDMA IV			
TX Channel	9262	9400	9538	1312	1413	1513	
Rx Channel	9662	9800	9938	1537	1638	1738	
Frequency (MHz)	1852.4	1880	1907.6	1712.4	1732.6	1752.6	
3GPP Rel 99	AMR 12.2Kbps	19.38	19.34	<b>19.60</b>	20.29	20.21	<b>20.37</b>



### 11. HAC RF Emission Test Results

Plot No.	Air Interface	Operating Mode	Channel	Power reduction	Average Antenna Input Power (dBm)	MIF	RF audio interference level dB(V/m)	Margin to FCC M3 limit (dB)	Battery	M-Rating
01	GSM850	GSM Voice	128	Off	33.35	3.53	34.29	10.71	#1	M4
02	GSM850	GSM Voice	128	Off	33.35	3.53	30.15	14.85	#2	M4
03	GSM850	GSM Voice	189	Off	33.40	3.53	34.00	11.00	#1	M4
04	GSM850	GSM Voice	251	Off	33.45	3.53	33.80	11.20	#1	M4
05	GSM1900	GSM Voice	512	Off	30.29	3.50	23.44	11.56	#1	M4
06	GSM1900	GSM Voice	661	Off	30.61	3.50	23.71	11.29	#1	M4
07	GSM1900	GSM Voice	810	Off	30.60	3.51	24.28	10.72	#1	M4
08	GSM1900	GSM Voice	810	Off	30.60	3.51	19.87	15.13	#2	M4

**Remark:**

1. The HAC measurement system applies MIF value onto the measured RMS E-field, which is indirect method in ANSI C63.19 2011 version, and reports the RF audio interference level.
2. The uncertainty is 0.2dB of MIF ranges from -7dB to +5dB. GSM850 band with rating M4, GSM1900 band with rating M4 would not be affected considering the MIF uncertainty.
3. Chose full power test can representative reduced power.
4. There is special HAC mode software on this EUT.
5. Test Engineer: Luke Lu.



## **12. Uncertainty Assessment**

The component of uncertainty may generally be categorized according to the methods used to evaluate them. The evaluation of uncertainty by the statistical analysis of a series of observations is termed a Type A evaluation of uncertainty. The evaluation of uncertainty by means other than the statistical analysis of a series of observation is termed a Type B evaluation of uncertainty. Each component of uncertainty, however evaluated, is represented by an estimated standard deviation, termed standard uncertainty, which is determined by the positive square root of the estimated variance.

The combined standard uncertainty of the measurement result represents the estimated standard deviation of the result. It is obtained by combining the individual standard uncertainties of both Type A and Type B evaluation using the usual “root-sum-squares” (RSS) methods of combining standard deviations by taking the positive square root of the estimated variances. Expanded uncertainty is a measure of uncertainty that defines an interval about the measurement result within which the measured value is confidently believed to lie. It is obtained by multiplying the combined standard uncertainty by a coverage factor. For purpose of this document, a coverage factor two is used, which corresponds to confidence interval of about 95 %. The DASY uncertainty Budget is showed in Table 12.1.





Error Description	Uncertainty Value (±%)	Probability Distribution	Divisor	Ci (E)	Standard Uncertainty (E)
<b>Measurement System</b>					
Probe Calibration	5.1	Normal	1	1	± 5.1 %
Axial Isotropy	4.7	Rectangular	√3	1	± 2.7 %
Sensor Displacement	16.5	Rectangular	√3	1	± 9.5 %
Boundary Effects	2.4	Rectangular	√3	1	± 1.4 %
Phantom Boundary Effects	7.2	Rectangular	√3	1	± 4.1 %
Linearity	4.7	Rectangular	√3	1	± 2.7 %
Scaling with PMF Calibration	10.0	Rectangular	√3	1	± 5.77 %
System Detection Limit	1.0	Rectangular	√3	1	± 0.6 %
Readout Electronics	0.3	Normal	1	1	± 0.3 %
Response Time	0.8	Rectangular	√3	1	± 0.5 %
Integration Time	2.6	Rectangular	√3	1	± 1.5 %
RF Ambient Conditions	3.0	Rectangular	√3	1	± 1.7 %
RF Reflections	12.0	Rectangular	√3	1	± 6.9 %
Probe Positioner	1.2	Rectangular	√3	1	± 0.7 %
Probe Positioning	4.7	Rectangular	√3	1	± 2.7 %
Extrap. and Interpolation	1.0	Rectangular	√3	1	± 0.6 %
<b>Test Sample Related</b>					
Device Positioning Vertical	4.7	Rectangular	√3	1	± 2.7 %
Device Positioning Lateral	1.0	Rectangular	√3	1	± 0.6 %
Device Holder and Phantom	2.4	Rectangular	√3	1	± 1.4 %
Power Drift	5.0	Rectangular	√3	1	± 2.9 %
<b>Phantom and Setup Related</b>					
Phantom Thickness	2.4	Rectangular	√3	1	± 1.4 %
<b>Combined Standard Uncertainty</b>					± 16.30 %
<b>Coverage Factor for 95 %</b>					K = 2
<b>Expanded Std. Uncertainty on Power</b>					± 32.6 %
<b>Expanded Std. Uncertainty on Field</b>					± 16.3 %

Table 12.1 Uncertainty Budget of HAC free field assessment

**Remark:**

Worst-Case uncertainty budget for HAC free field assessment according to ANSIC63.19 [1], [2]. The budget is valid for the frequency range 700 MHz - 3 GHz and represents a worst case analysis.



### **13. References**

- [1] ANSI C63.19-2011, "American National Standard for Methods of Measurement of Compatibility between Wireless Communications Devices and Hearing Aids", 27 May 2011.
- [2] FCC KDB 285076 D01v04r01, "Equipment Authorization Guidance for Hearing Aid Compatibility", Apr 2016
- [3] FCC KDB 285076 D02v02, "Guidance for Performing T-Coil tests for Air Interfaces Supporting Voice over IP", Apr 2016
- [4] SPEAG DASY System Handbook



---

## **Appendix A. Plots of System Performance Check**

The plots are shown as follows.

**HAC\_E\_Dipole\_835\_160815**

**DUT: HAC Dipole 835 MHz**

Communication System: UID 0, CW; Frequency: 835 MHz; Duty Cycle: 1:1

Medium: Air Medium parameters used:  $\sigma = 0$  S/m,  $\epsilon_r = 1$ ;  $\rho = 0$  kg/m<sup>3</sup>

Ambient Temperature : 23.2 °C

**DASY5 Configuration:**

- Probe: ER3DV6 - SN2476; ConvF(1, 1, 1); Calibrated: 2015.11.25;
- Sensor-Surface: (Fix Surface)
- Electronics: DAE4 Sn1210; Calibrated: 2016.5.18
- Phantom: HAC Test Arch with AMCC; Type: SD HAC P01 BA;
- Measurement SW: DASY52, Version 52.8 (8); SEMCAD X Version 14.6.10 (7331)

**E Scan - measurement distance from the probe sensor center to CD835 = 15mm/Hearing Aid Compatibility Test at 15mm distance (41x361x1):** Interpolated grid:

dx=0.5000 mm, dy=0.5000 mm

Device Reference Point: 0, 0, -6.3 mm

Reference Value = 96.55 V/m; Power Drift = 0.11 dB

PMR not calibrated. PMF = 1.000 is applied.

E-field emissions = 108.5 V/m

Average value of Total=(108.5+99.44)/2=103.97 V/m

PMF scaled E-field

Grid 1 <b>M4</b> <b>107.5 V/m</b>	Grid 2 <b>M4</b> <b>108.5 V/m</b>	Grid 3 <b>M4</b> <b>105.5 V/m</b>
Grid 4 <b>M4</b> <b>67.27 V/m</b>	Grid 5 <b>M4</b> <b>67.55 V/m</b>	Grid 6 <b>M4</b> <b>65.50 V/m</b>
Grid 7 <b>M4</b> <b>98.51 V/m</b>	Grid 8 <b>M4</b> <b>99.44 V/m</b>	Grid 9 <b>M4</b> <b>97.11 V/m</b>

**Cursor:**

Total = 108.5 V/m

E Category: M4

Location: 1, -69.5, 9.7 mm

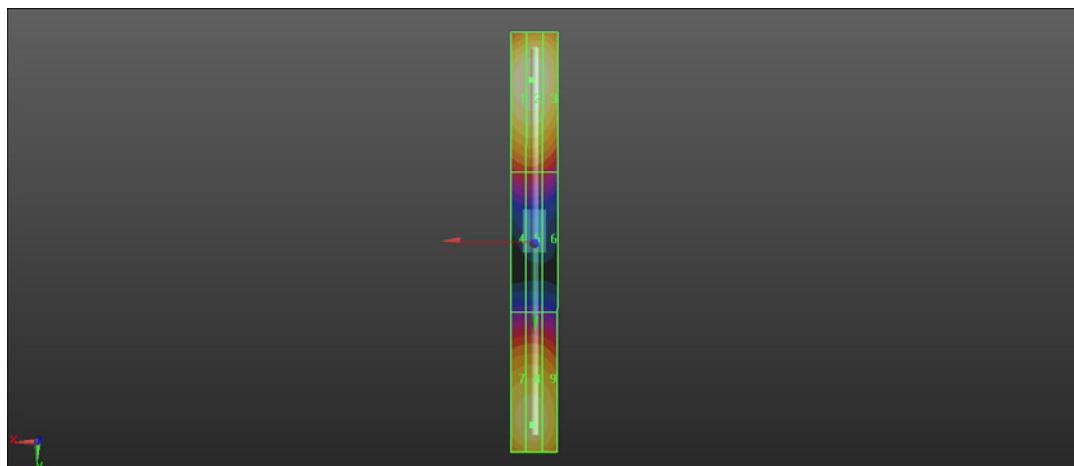
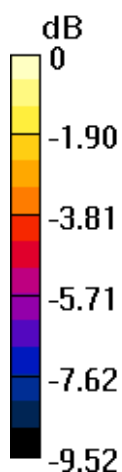

0 dB = 105.9 V/m = 40.50 dBV/m

**HAC\_E\_Dipole\_1880\_160815**

**DUT: HAC Dipole 1880 MHz**

Communication System: UID 0, CW (0); Frequency: 1880 MHz; Duty Cycle: 1:1

Medium: Air Medium parameters used:  $\sigma = 0$  S/m,  $\epsilon_r = 1$ ;  $\rho = 0$  kg/m<sup>3</sup>

Ambient Temperature : 23.2 °C

**DASY5 Configuration:**

- Probe: ER3DV6 - SN2476; ConvF(1, 1, 1); Calibrated: 2015.11.25;
- Sensor-Surface: (Fix Surface)
- Electronics: DAE4 Sn1210; Calibrated: 2016.5.18
- Phantom: HAC Test Arch with AMCC; Type: SD HAC P01 BA;
- Measurement SW: DASY52, Version 52.8 (8); SEMCAD X Version 14.6.10 (7331)

**E Scan - measurement distance from the probe sensor center to CD1880 = 15mm/Hearing Aid Compatibility Test at 15mm distance (41x181x1): Interpolated grid:**

dx=0.5000 mm, dy=0.5000 mm

Device Reference Point: 0, 0, -6.3 mm

Reference Value = 141.7 V/m; Power Drift = -0.12 dB

PMR not calibrated. PMF = 1.000 is applied.

E-field emissions = 86.97 V/m

Average value of Total=(86.94+86.56)/2=86.75 V/m

PMF scaled E-field

Grid 1 <b>M3</b> <b>85.04 V/m</b>	Grid 2 <b>M3</b> <b>86.94 V/m</b>	Grid 3 <b>M3</b> <b>85.34 V/m</b>
Grid 4 <b>M3</b> <b>71.45 V/m</b>	Grid 5 <b>M3</b> <b>72.72 V/m</b>	Grid 6 <b>M3</b> <b>71.23 V/m</b>
Grid 7 <b>M3</b> <b>84.88 V/m</b>	Grid 8 <b>M3</b> <b>86.56 V/m</b>	Grid 9 <b>M3</b> <b>84.20 V/m</b>

**Cursor:**

Total = 86.94 V/m

E Category: M3

Location: 0.5, -30, 9.7 mm

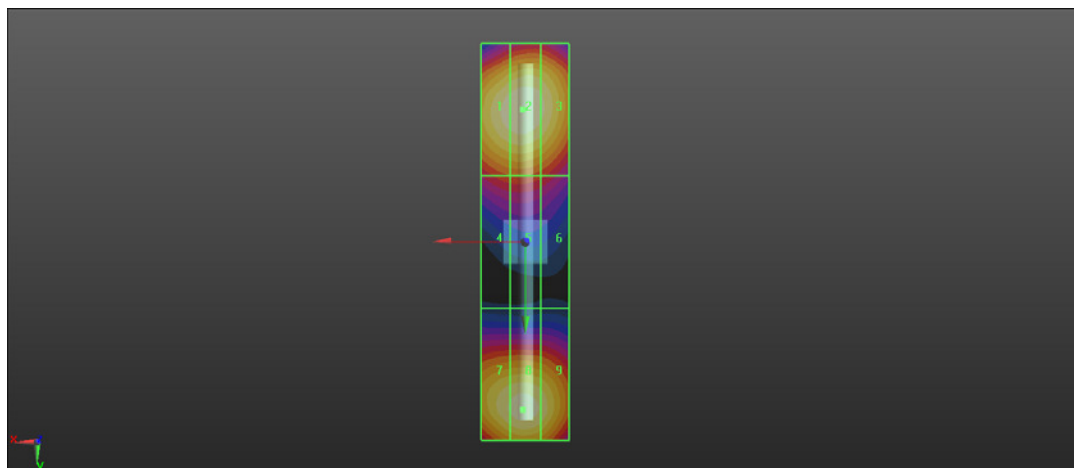
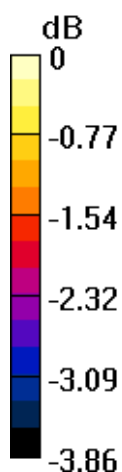

0 dB = 83.11 V/m = 38.39 dBV/m



---

**Appendix B. Plots of RF Emission Measurement**

The plots are shown as follows.

**1 HAC RF GSM850\_Voice\_Ch128\_E**

Communication System: UID 10021 - DAB, GSM-FDD (TDMA, GMSK); Frequency: 824.2 MHz; Duty Cycle: 1:8.3

Medium: Air Medium parameters used:  $\sigma = 0$  S/m,  $\epsilon_r = 1$ ;  $\rho = 0$  kg/m<sup>3</sup>

Ambient Temperature : 23.2 °C

DASY5 Configuration:

- Probe: ER3DV6 - SN2476; ConvF(1, 1, 1); Calibrated: 2015.11.25;
- Sensor-Surface: (Fix Surface)
- Electronics: DAE4 Sn1210; Calibrated: 2016.5.18
- Phantom: HAC Test Arch with AMCC; Type: SD HAC P01 BA;
- Measurement SW: DASY52, Version 52.8 (8); SEMCAD X Version 14.6.10 (7331)

**Ch128/Hearing Aid Compatibility Test (101x101x1):** Interpolated grid: dx=0.5000 mm, dy=0.5000 mm

Device Reference Point: 0, 0, -6.3 mm

Reference Value = 44.40 V/m; Power Drift = -0.01 dB

Applied MIF = 3.53 dB

RF audio interference level = 34.29 dBV/m

**Emission category: M4**

MIF scaled E-field

<b>Grid 1 M4</b> <b>32.5 dBV/m</b>	<b>Grid 2 M4</b> <b>32.95 dBV/m</b>	<b>Grid 3 M4</b> <b>32.44 dBV/m</b>
<b>Grid 4 M4</b> <b>34.12 dBV/m</b>	<b>Grid 5 M4</b> <b>34.29 dBV/m</b>	<b>Grid 6 M4</b> <b>33.36 dBV/m</b>
<b>Grid 7 M4</b> <b>35.5 dBV/m</b>	<b>Grid 8 M4</b> <b>35.51 dBV/m</b>	<b>Grid 9 M4</b> <b>34.04 dBV/m</b>

**Cursor:**

Total = 28.90 dBV/m

E Category: M4

Location: 25, -25, 9.7 mm

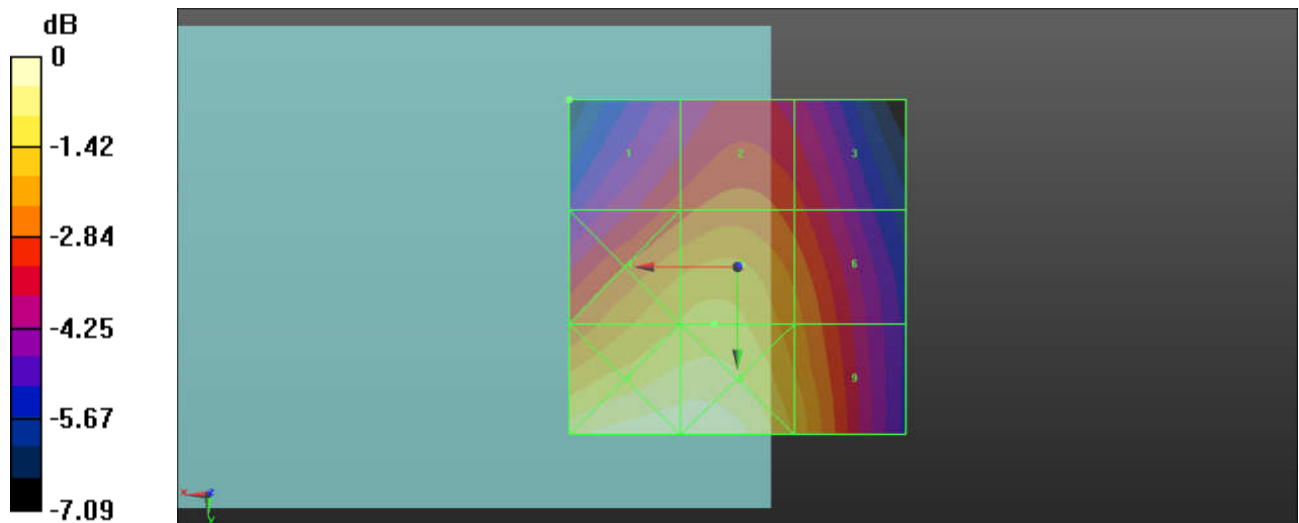

0 dB = 59.65 V/m = 35.51 dBV/m



**2 HAC RF GSM850\_Voice\_Ch128\_E\_Battery2**

Communication System: UID 10021 - DAB, GSM-FDD (TDMA, GMSK); Frequency: 824.2 MHz; Duty Cycle: 1:8.3

Medium: Air Medium parameters used:  $\sigma = 0 \text{ S/m}$ ,  $\epsilon_r = 1$ ;  $\rho = 0 \text{ kg/m}^3$

Ambient Temperature : 23.2 °C

DASY5 Configuration:

- Probe: ER3DV6 - SN2476; ConvF(1, 1, 1); Calibrated: 2015.11.25;
- Sensor-Surface: (Fix Surface)
- Electronics: DAE4 Sn1210; Calibrated: 2016.5.18
- Phantom: HAC Test Arch with AMCC; Type: SD HAC P01 BA;
- Measurement SW: DASY52, Version 52.8 (8); SEMCAD X Version 14.6.10 (7331)

**Ch128/Hearing Aid Compatibility Test (101x101x1):** Interpolated grid: dx=0.5000 mm, dy=0.5000 mm

Device Reference Point: 0, 0, -6.3 mm

Reference Value = 28.67 V/m; Power Drift = -0.10 dB

Applied MIF = 3.53 dB

RF audio interference level = 30.15 dBV/m

**Emission category: M4**

MIF scaled E-field

<b>Grid 1 M4</b> <b>28.39 dBV/m</b>	<b>Grid 2 M4</b> <b>28.84 dBV/m</b>	<b>Grid 3 M4</b> <b>28.25 dBV/m</b>
<b>Grid 4 M4</b> <b>29.98 dBV/m</b>	<b>Grid 5 M4</b> <b>30.15 dBV/m</b>	<b>Grid 6 M4</b> <b>29.19 dBV/m</b>
<b>Grid 7 M4</b> <b>31.32 dBV/m</b>	<b>Grid 8 M4</b> <b>31.34 dBV/m</b>	<b>Grid 9 M4</b> <b>29.91 dBV/m</b>

**Cursor:**

Total = 31.34 dBV/m

E Category: M4

Location: 6.5, 25, 9.7 mm

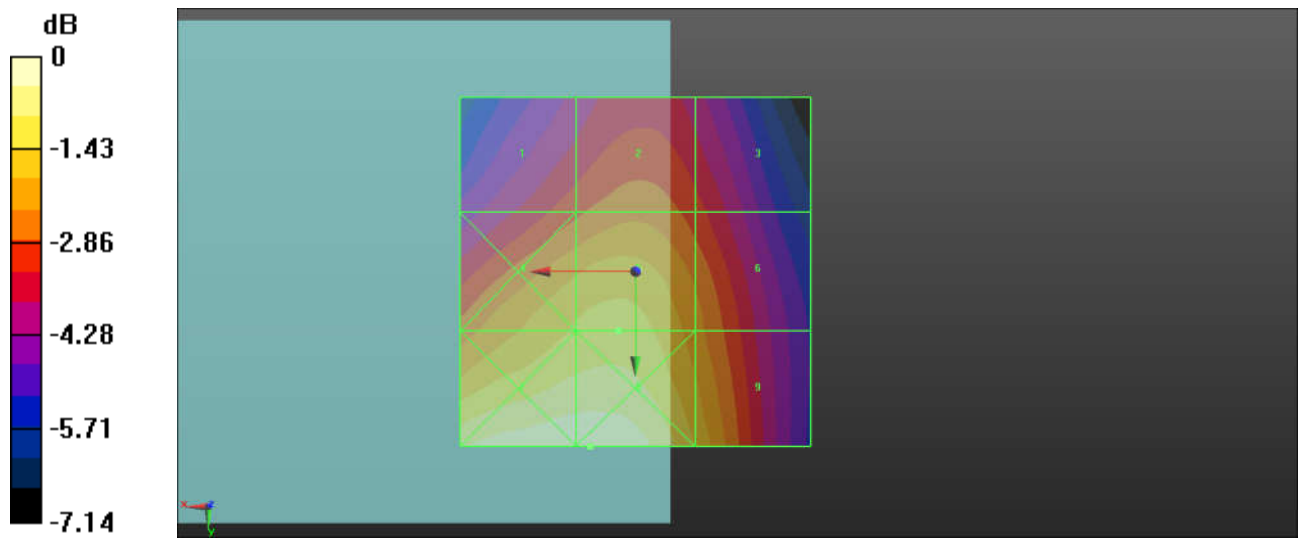

0 dB = 36.88 V/m = 31.34 dBV/m

**3 HAC RF GSM850\_Voice\_Ch189\_E**

Communication System: UID 10021 - DAB, GSM-FDD (TDMA, GMSK); Frequency: 836.4 MHz; Duty Cycle: 1:8.3

Medium: Air Medium parameters used:  $\sigma = 0$  S/m,  $\epsilon_r = 1$ ;  $\rho = 0$  kg/m<sup>3</sup>

Ambient Temperature : 23.2 °C

DASY5 Configuration:

- Probe: ER3DV6 - SN2476; ConvF(1, 1, 1); Calibrated: 2015.11.25;
- Sensor-Surface: (Fix Surface)
- Electronics: DAE4 Sn1210; Calibrated: 2016.5.18
- Phantom: HAC Test Arch with AMCC; Type: SD HAC P01 BA;
- Measurement SW: DASY52, Version 52.8 (8); SEMCAD X Version 14.6.10 (7331)

**Ch189/Hearing Aid Compatibility Test (101x101x1):** Interpolated grid: dx=0.5000 mm, dy=0.5000 mm

Device Reference Point: 0, 0, -6.3 mm

Reference Value = 42.13 V/m; Power Drift = -0.06 dB

Applied MIF = 3.53 dB

RF audio interference level = 34.00 dBV/m

**Emission category: M4**

MIF scaled E-field

Grid 1 <b>M4</b> <b>31.64 dBV/m</b>	Grid 2 <b>M4</b> <b>32.12 dBV/m</b>	Grid 3 <b>M4</b> <b>31.58 dBV/m</b>
Grid 4 <b>M4</b> <b>33.88 dBV/m</b>	Grid 5 <b>M4</b> <b>34 dBV/m</b>	Grid 6 <b>M4</b> <b>32.75 dBV/m</b>
Grid 7 <b>M4</b> <b>35.52 dBV/m</b>	Grid 8 <b>M4</b> <b>35.52 dBV/m</b>	Grid 9 <b>M4</b> <b>33.77 dBV/m</b>

**Cursor:**

Total = 27.08 dBV/m

E Category: M4

Location: 25, -25, 9.7 mm

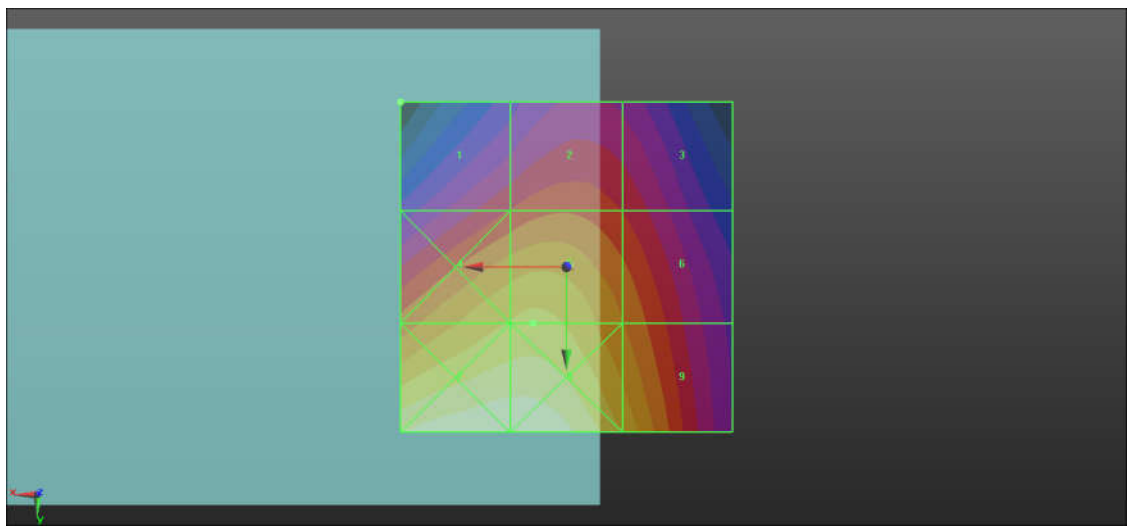
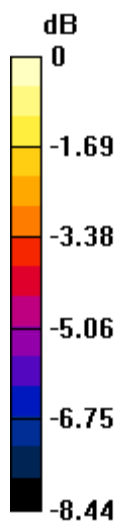

0 dB = 59.73 V/m = 35.52 dBV/m

**4 HAC RF GSM850\_Voice\_Ch251\_E**

Communication System: UID 10021 - DAB, GSM-FDD (TDMA, GMSK); Frequency: 848.8 MHz; Duty Cycle: 1:8.3

Medium: Air Medium parameters used:  $\sigma = 0$  S/m,  $\epsilon_r = 1$ ;  $\rho = 0$  kg/m<sup>3</sup>

Ambient Temperature : 23.2 °C

DASY5 Configuration:

- Probe: ER3DV6 - SN2476; ConvF(1, 1, 1); Calibrated: 2015.11.25;
- Sensor-Surface: (Fix Surface)
- Electronics: DAE4 Sn1210; Calibrated: 2016.5.18
- Phantom: HAC Test Arch with AMCC; Type: SD HAC P01 BA;
- Measurement SW: DASY52, Version 52.8 (8); SEMCAD X Version 14.6.10 (7331)

**Ch251/Hearing Aid Compatibility Test (101x101x1):** Interpolated grid: dx=0.5000 mm, dy=0.5000 mm

Device Reference Point: 0, 0, -6.3 mm

Reference Value = 39.02 V/m; Power Drift = 0.04 dB

Applied MIF = 3.50 dB

RF audio interference level = 33.80 dBV/m

**Emission category: M4**

MIF scaled E-field

Grid 1 <b>M4</b> <b>30.78 dBV/m</b>	Grid 2 <b>M4</b> <b>31.09 dBV/m</b>	Grid 3 <b>M4</b> <b>30.11 dBV/m</b>
Grid 4 <b>M4</b> <b>33.74 dBV/m</b>	Grid 5 <b>M4</b> <b>33.8 dBV/m</b>	Grid 6 <b>M4</b> <b>31.67 dBV/m</b>
Grid 7 <b>M4</b> <b>35.63 dBV/m</b>	Grid 8 <b>M4</b> <b>35.61 dBV/m</b>	Grid 9 <b>M4</b> <b>33.28 dBV/m</b>

**Cursor:**

Total = 24.91 dBV/m

E Category: M4

Location: 25, -25, 9.7 mm

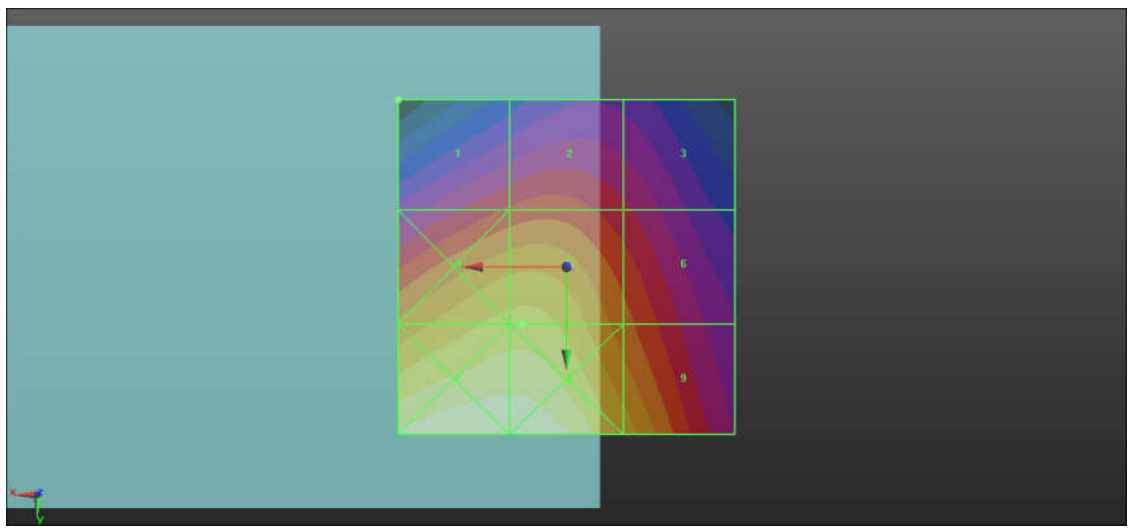
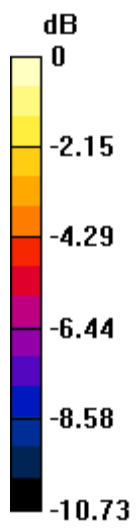

0 dB = 60.50 V/m = 35.64 dBV/m

**5 HAC RF GSM1900\_Voice\_Ch512\_E**

Communication System: UID 10021 - DAB, GSM-FDD (TDMA, GMSK); Frequency: 1850.2 MHz; Duty Cycle: 1:8.3

Medium: Air Medium parameters used:  $\sigma = 0$  S/m,  $\epsilon_r = 1$ ;  $\rho = 0$  kg/m<sup>3</sup>

Ambient Temperature : 23.2 °C

DASY5 Configuration:

- Probe: ER3DV6 - SN2476; ConvF(1, 1, 1); Calibrated: 2015.11.25;
- Sensor-Surface: (Fix Surface)
- Electronics: DAE4 Sn1210; Calibrated: 2016.5.18
- Phantom: HAC Test Arch with AMCC; Type: SD HAC P01 BA;
- Measurement SW: DASY52, Version 52.8 (8); SEMCAD X Version 14.6.10 (7331)

**Ch512/Hearing Aid Compatibility Test (101x101x1):** Interpolated grid: dx=0.5000 mm, dy=0.5000 mm

Device Reference Point: 0, 0, -6.3 mm

Reference Value = 7.906 V/m; Power Drift = -0.02 dB

Applied MIF = 3.50 dB

RF audio interference level = 23.44 dBV/m

**Emission category: M4**

MIF scaled E-field

<b>Grid 1 M4</b> <b>26.69 dBV/m</b>	<b>Grid 2 M4</b> <b>27.99 dBV/m</b>	<b>Grid 3 M4</b> <b>27.56 dBV/m</b>
<b>Grid 4 M4</b> <b>21.74 dBV/m</b>	<b>Grid 5 M4</b> <b>23.44 dBV/m</b>	<b>Grid 6 M4</b> <b>23.42 dBV/m</b>
<b>Grid 7 M4</b> <b>21.5 dBV/m</b>	<b>Grid 8 M4</b> <b>21.45 dBV/m</b>	<b>Grid 9 M4</b> <b>20.68 dBV/m</b>

**Cursor:**

Total = 22.55 dBV/m

E Category: M4

Location: 25, -25, 9.7 mm

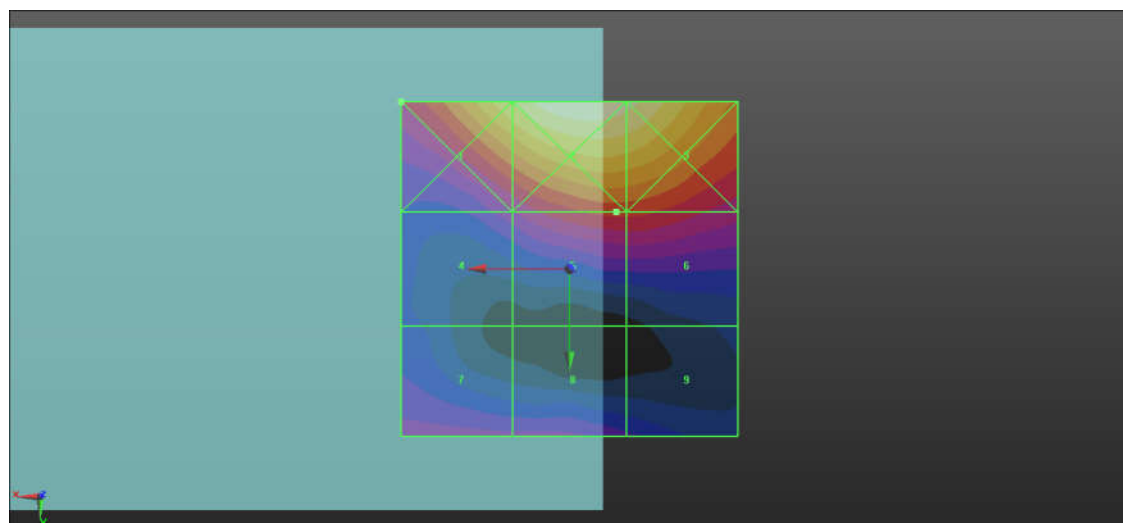
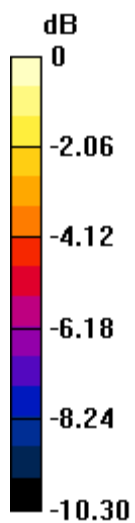

0 dB = 25.08 V/m = 27.99 dBV/m



**6 HAC RF GSM1900\_Voice\_Ch661\_E**

Communication System: UID 10021 - DAB, GSM-FDD (TDMA, GMSK); Frequency: 1880 MHz; Duty Cycle: 1:8.3

Medium: Air Medium parameters used:  $\sigma = 0$  S/m,  $\epsilon_r = 1$ ;  $\rho = 0$  kg/m<sup>3</sup>

Ambient Temperature : 23.2 °C

DASY5 Configuration:

- Probe: ER3DV6 - SN2476; ConvF(1, 1, 1); Calibrated: 2015.11.25;
- Sensor-Surface: (Fix Surface)
- Electronics: DAE4 Sn1210; Calibrated: 2016.5.18
- Phantom: HAC Test Arch with AMCC; Type: SD HAC P01 BA;
- Measurement SW: DASY52, Version 52.8 (8); SEMCAD X Version 14.6.10 (7331)

**Ch661/Hearing Aid Compatibility Test (101x101x1):** Interpolated grid: dx=0.5000 mm, dy=0.5000 mm

Device Reference Point: 0, 0, -6.3 mm

Reference Value = 8.687 V/m; Power Drift = -0.01 dB

Applied MIF = 3.50 dB

RF audio interference level = 23.71 dBV/m

**Emission category: M4**

MIF scaled E-field

Grid 1 <b>M4</b> <b>26.61 dBV/m</b>	Grid 2 <b>M4</b> <b>28.24 dBV/m</b>	Grid 3 <b>M4</b> <b>27.93 dBV/m</b>
Grid 4 <b>M4</b> <b>21.81 dBV/m</b>	Grid 5 <b>M4</b> <b>23.71 dBV/m</b>	Grid 6 <b>M4</b> <b>23.71 dBV/m</b>
Grid 7 <b>M4</b> <b>21.86 dBV/m</b>	Grid 8 <b>M4</b> <b>22.11 dBV/m</b>	Grid 9 <b>M4</b> <b>21.56 dBV/m</b>

**Cursor:**

Total = 22.03 dBV/m

E Category: M4

Location: 25, -25, 9.7 mm

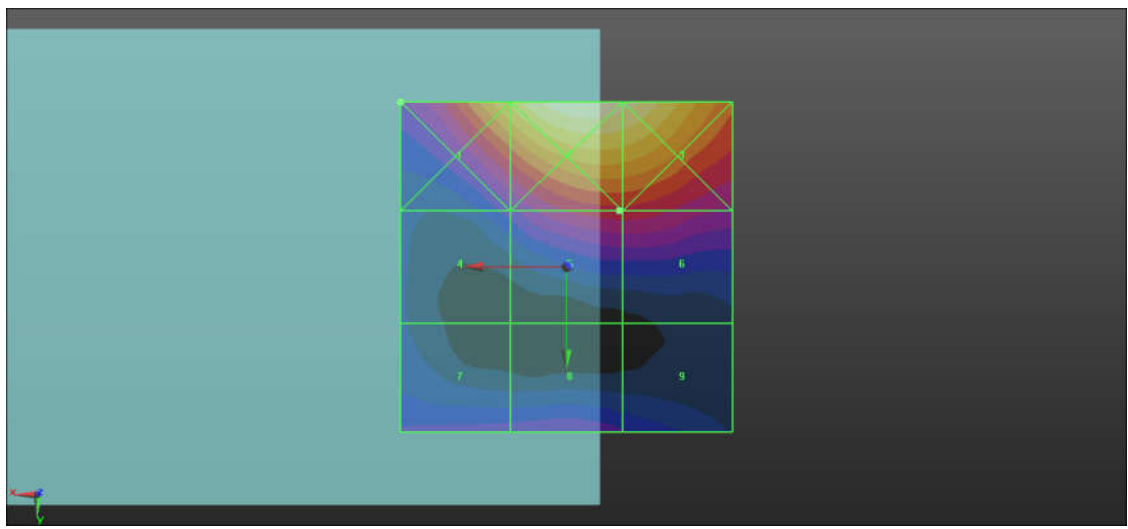
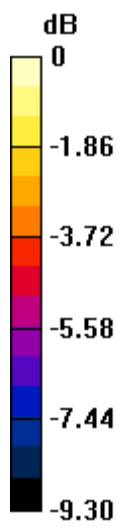

0 dB = 25.83 V/m = 28.24 dBV/m

**7 HAC RF GSM1900\_Voice\_Ch810\_E**

Communication System: UID 10021 - DAB, GSM-FDD (TDMA, GMSK); Frequency: 1909.8 MHz; Duty Cycle: 1:8.3

Medium: Air Medium parameters used:  $\sigma = 0$  S/m,  $\epsilon_r = 1$ ;  $\rho = 0$  kg/m<sup>3</sup>

Ambient Temperature : 23.2 °C

DASY5 Configuration:

- Probe: ER3DV6 - SN2476; ConvF(1, 1, 1); Calibrated: 2015.11.25;
- Sensor-Surface: (Fix Surface)
- Electronics: DAE4 Sn1210; Calibrated: 2016.5.18
- Phantom: HAC Test Arch with AMCC; Type: SD HAC P01 BA;
- Measurement SW: DASY52, Version 52.8 (8); SEMCAD X Version 14.6.10 (7331)

**Ch810/Hearing Aid Compatibility Test (101x101x1):** Interpolated grid: dx=0.5000 mm, dy=0.5000 mm

Device Reference Point: 0, 0, -6.3 mm

Reference Value = 11.08 V/m; Power Drift = -0.15 dB

Applied MIF = 3.51 dB

RF audio interference level = 24.28 dBV/m

**Emission category: M4**

MIF scaled E-field

<b>Grid 1 M4</b> <b>26.39 dBV/m</b>	<b>Grid 2 M4</b> <b>28.27 dBV/m</b>	<b>Grid 3 M4</b> <b>27.95 dBV/m</b>
<b>Grid 4 M4</b> <b>22.86 dBV/m</b>	<b>Grid 5 M4</b> <b>24.28 dBV/m</b>	<b>Grid 6 M4</b> <b>24.21 dBV/m</b>
<b>Grid 7 M4</b> <b>21.39 dBV/m</b>	<b>Grid 8 M4</b> <b>21.73 dBV/m</b>	<b>Grid 9 M4</b> <b>21.33 dBV/m</b>

**Cursor:**

Total = 22.50 dBV/m

E Category: M4

Location: 25, -25, 9.7 mm

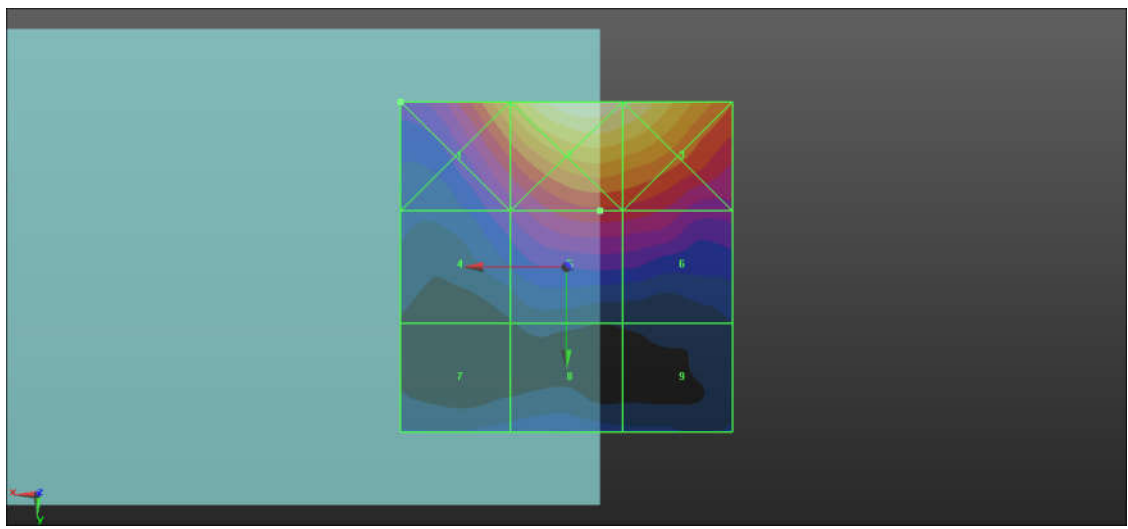
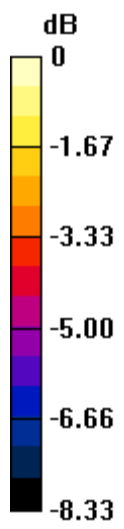

0 dB = 25.92 V/m = 28.27 dBV/m

**8 HAC RF GSM850\_Voice\_Ch189\_E\_Battery2**

Communication System: UID 10021 - DAB, GSM-FDD (TDMA, GMSK); Frequency: 1909.8 MHz; Duty Cycle: 1:8.3

Medium: Air Medium parameters used:  $\sigma = 0$  S/m,  $\epsilon_r = 1$ ;  $\rho = 0$  kg/m<sup>3</sup>

Ambient Temperature : 23.2 °C

DASY5 Configuration:

- Probe: ER3DV6 - SN2476; ConvF(1, 1, 1); Calibrated: 2015.11.25;
- Sensor-Surface: (Fix Surface)
- Electronics: DAE4 Sn1210; Calibrated: 2016.5.18
- Phantom: HAC Test Arch with AMCC; Type: SD HAC P01 BA;
- Measurement SW: DASY52, Version 52.8 (8); SEMCAD X Version 14.6.10 (7331)

**Ch810/Hearing Aid Compatibility Test (101x101x1):** Interpolated grid: dx=0.5000 mm, dy=0.5000 mm

Device Reference Point: 0, 0, -6.3 mm

Reference Value = 5.465 V/m; Power Drift = -0.02 dB

Applied MIF = 3.51 dB

RF audio interference level = 19.87 dBV/m

**Emission category: M4**

MIF scaled E-field

<b>Grid 1 M4</b> <b>23.57 dBV/m</b>	<b>Grid 2 M4</b> <b>24.94 dBV/m</b>	<b>Grid 3 M4</b> <b>24.51 dBV/m</b>
<b>Grid 4 M4</b> <b>18.98 dBV/m</b>	<b>Grid 5 M4</b> <b>19.69 dBV/m</b>	<b>Grid 6 M4</b> <b>19.72 dBV/m</b>
<b>Grid 7 M4</b> <b>19.05 dBV/m</b>	<b>Grid 8 M4</b> <b>19.87 dBV/m</b>	<b>Grid 9 M4</b> <b>19.62 dBV/m</b>

**Cursor:**

Total = 24.94 dBV/m

E Category: M4

Location: -1.5, -25, 9.7 mm

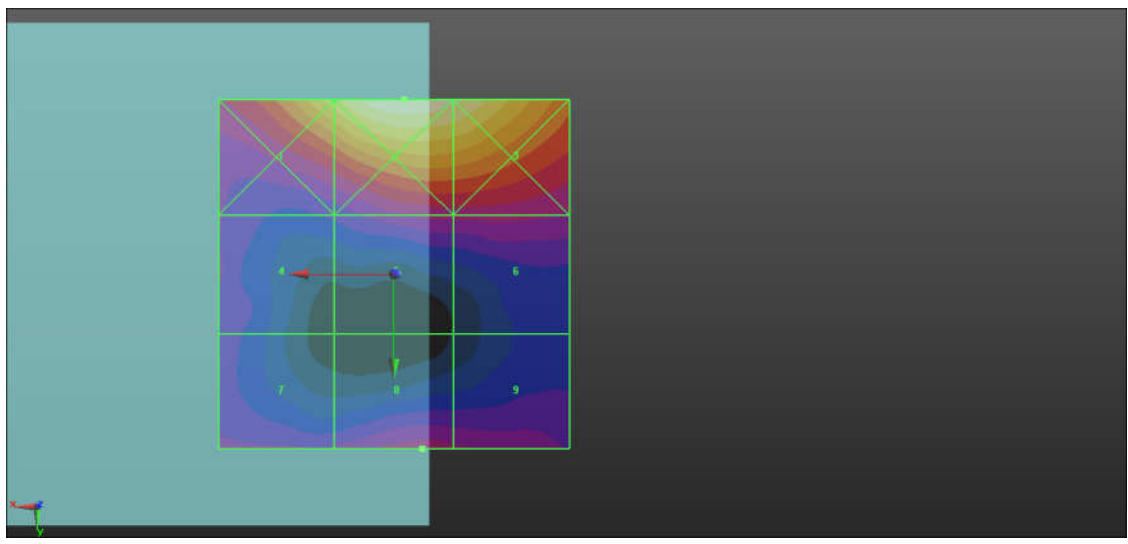
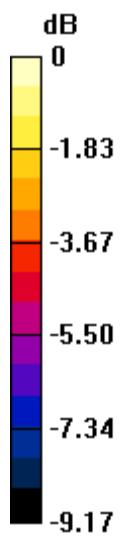

0 dB = 17.66 V/m = 24.94 dBV/m



## ***Appendix C. DASY Calibration Certificate***

The DASY calibration certificates are shown as follows.



Accredited by the Swiss Accreditation Service (SAS)  
The Swiss Accreditation Service is one of the signatories to the EA  
Multilateral Agreement for the recognition of calibration certificates

Accreditation No.: **SCS 0108**

Client **Sporton-KS (Auden)**

Certificate No: **CD835V3-1171\_Jan16**

## CALIBRATION CERTIFICATE

Object **CD835V3 - SN: 1171**

Calibration procedure(s) **QA CAL-20.v6  
Calibration procedure for dipoles in air**

Calibration date: **January 27, 2016**

This calibration certificate documents the traceability to national standards, which realize the physical units of measurements (SI).  
The measurements and the uncertainties with confidence probability are given on the following pages and are part of the certificate.

All calibrations have been conducted in the closed laboratory facility: environment temperature ( $22 \pm 3$ )°C and humidity < 70%.

Calibration Equipment used (M&TE critical for calibration)

Primary Standards	ID #	Cal Date (Certificate No.)	Scheduled Calibration
Power meter EPM-442A	GB37480704	07-Oct-15 (No. 217-02222)	Oct-16
Power sensor HP 8481A	US37292783	07-Oct-15 (No. 217-02222)	Oct-16
Power sensor HP 8481A	MY41092317	07-Oct-15 (No. 217-02223)	Oct-16
Reference 10 dB Attenuator	SN: 5047.2 / 06327	01-Apr-15 (No. 217-02130)	Mar-16
Probe ER3DV6	SN: 2336	31-Dec-15 (No. ER3-2336_Dec15)	Dec-16
Probe H3DV6	SN: 6065	31-Dec-15 (No. H3-6065_Dec15)	Dec-16
DAE4	SN: 781	04-Sep-15 (No. DAE4-781_Sep15)	Sep-16
Secondary Standards	ID #	Check Date (in house)	Scheduled Check
Power meter Agilent 4419B	SN: GB42420191	09-Oct-09 (in house check Sep-14)	In house check: Sep-16
Power sensor HP E4412A	SN: US38485102	05-Jan-10 (in house check Sep-14)	In house check: Sep-16
Power sensor HP 8482A	SN: US37295597	09-Oct-09 (in house check Sep-14)	In house check: Sep-16
Network Analyzer HP 8753E	US37390585	18-Oct-01 (in house check Oct-15)	In house check: Oct-16
RF generator R&S SMT-06	SN: 832283/011	27-Aug-12 (in house check Oct-15)	In house check: Oct-18

Calibrated by: **Leif Klysnér** Laboratory Technician

Approved by: **Fin Bornholt** Deputy Technical Manager

Signature  
*Leif Klysnér*  
*F. Bornholt*

Issued: January 28, 2016

This calibration certificate shall not be reproduced except in full without written approval of the laboratory.





Accredited by the Swiss Accreditation Service (SAS)

The Swiss Accreditation Service is one of the signatories to the EA  
Multilateral Agreement for the recognition of calibration certificates

Accreditation No.: **SCS 0108**

## References

- [1] ANSI-C63.19-2011  
American National Standard, Methods of Measurement of Compatibility between Wireless Communications  
Devices and Hearing Aids.

## Methods Applied and Interpretation of Parameters:

- **Coordinate System:** y-axis is in the direction of the dipole arms. z-axis is from the basis of the antenna (mounted on the table) towards its feed point between the two dipole arms. x-axis is normal to the other axes. In coincidence with the standards [1], the measurement planes (probe sensor center) are selected to be at a distance of 15 mm above the top metal edge of the dipole arms.
- **Measurement Conditions:** Further details are available from the hardcopies at the end of the certificate. All figures stated in the certificate are valid at the frequency indicated. The forward power to the dipole connector is set with a calibrated power meter connected and monitored with an auxiliary power meter connected to a directional coupler. While the dipole under test is connected, the forward power is adjusted to the same level.
- **Antenna Positioning:** The dipole is mounted on a HAC Test Arch phantom using the matching dipole positioner with the arms horizontal and the feeding cable coming from the floor. The measurements are performed in a shielded room with absorbers around the setup to reduce the reflections. It is verified before the mounting of the dipole under the Test Arch phantom, that its arms are perfectly in a line. It is installed on the HAC dipole positioner with its arms parallel below the dielectric reference wire and able to move elastically in vertical direction without changing its relative position to the top center of the Test Arch phantom. The vertical distance to the probe is adjusted after dipole mounting with a DASYS Surface Check job. Before the measurement, the distance between phantom surface and probe tip is verified. The proper measurement distance is selected by choosing the matching section of the HAC Test Arch phantom with the proper device reference point (upper surface of the dipole) and the matching grid reference point (tip of the probe) considering the probe sensor offset. The vertical distance to the probe is essential for the accuracy.
- **Feed Point Impedance and Return Loss:** These parameters are measured using a HP 8753E Vector Network Analyzer. The impedance is specified at the SMA connector of the dipole. The influence of reflections was eliminated by applying the averaging function while moving the dipole in the air, at least 70cm away from any obstacles.
- **E-field distribution:** E field is measured in the x-y-plane with an isotropic ER3D-field probe with 100 mW forward power to the antenna feed point. In accordance with [1], the scan area is 20mm wide, its length exceeds the dipole arm length (180 or 90mm). The sensor center is 15 mm (in z) above the metal top of the dipole arms. Two 3D maxima are available near the end of the dipole arms. Assuming the dipole arms are perfectly in one line, the average of these two maxima (in subgrid 2 and subgrid 8) is determined to compensate for any non-parallelity to the measurement plane as well as the sensor displacement. The E-field value stated as calibration value represents the maximum of the interpolated 3D-E-field, in the plane above the dipole surface.

The reported uncertainty of measurement is stated as the standard uncertainty of measurement multiplied by the coverage factor  $k=2$ , which for a normal distribution corresponds to a coverage probability of approximately 95%.

## Measurement Conditions

DASY system configuration, as far as not given on page 1.

DASY Version	DASY5	V52.8.8
Phantom	HAC Test Arch	
Distance Dipole Top - Probe Center	15 mm	
Scan resolution	dx, dy = 5 mm	
Frequency	835 MHz $\pm$ 1 MHz	
Input power drift	< 0.05 dB	

## Maximum Field values at 835 MHz

E-field 15 mm above dipole surface	condition	Interpolated maximum
Maximum measured above high end	100 mW input power	107.4 V/m = 40.62 dBV/m
Maximum measured above low end	100 mW input power	104.7 V/m = 40.40 dBV/m
Averaged maximum above arm	100 mW input power	<b>106.0 V/m <math>\pm</math> 12.8 % (k=2)</b>

## Appendix (Additional assessments outside the scope of SCS 0108)

### Antenna Parameters

Frequency	Return Loss	Impedance
800 MHz	16.1 dB	42.8 $\Omega$ - 12.9 j $\Omega$
835 MHz	27.3 dB	51.5 $\Omega$ + 4.1 j $\Omega$
900 MHz	16.2 dB	57.9 $\Omega$ - 15.0 j $\Omega$
950 MHz	21.7 dB	46.4 $\Omega$ + 7.1 j $\Omega$
960 MHz	16.9 dB	53.0 $\Omega$ + 14.5 j $\Omega$

### 3.2 Antenna Design and Handling

The calibration dipole has a symmetric geometry with a built-in two stub matching network, which leads to the enhanced bandwidth.

The dipole is built of standard semirigid coaxial cable. The internal matching line is open ended. The antenna is therefore open for DC signals.

Do not apply force to dipole arms, as they are liable to bend. The soldered connections near the feedpoint may be damaged. After excessive mechanical stress or overheating, check the impedance characteristics to ensure that the internal matching network is not affected.

After long term use with 40W radiated power, only a slight warming of the dipole near the feedpoint can be measured.



# Impedance Measurement Plot

27 Jan 2016 14:47:38



CH2 S11 1 U FS 2: 51.490  $\Omega$  4.1328  $\Omega$  787.73 pH 835.000 000 MHz

De1  
Cor  
Avg 16  
H1d

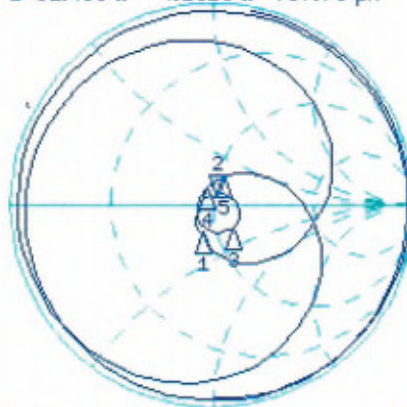

START 335.000 000 MHz

STOP 1 335.000 000 MHz

## DASY5 E-field Result

Date: 27.01.2016

Test Laboratory: SPEAG Lab2

**DUT: HAC-Dipole 835 MHz; Type: CD835V3; Serial: CD835V3 - SN: 1171**

Communication System: UID 0 - CW ; Frequency: 835 MHz  
Medium parameters used:  $\sigma = 0$  S/m,  $\epsilon_r = 1$ ;  $\rho = 1000$  kg/m<sup>3</sup>  
Phantom section: RF Section  
Measurement Standard: DASY5 (IEEE/IEC/ANSI C63.19-2011)

DASY52 Configuration:

- Probe: ER3DV6 - SN2336; ConvF(1, 1, 1); Calibrated: 31.12.2015;
- Sensor-Surface: (Fix Surface)
- Electronics: DAE4 Sn781; Calibrated: 04.09.2015
- Phantom: HAC Test Arch with AMCC; Type: SD HAC P01 BA; Serial: 1070
- DASY52 52.8.8(1258); SEMCAD X 14.6.10(7372)

**Dipole E-Field measurement @ 835MHz/E-Scan - 835MHz d=15mm/Hearing Aid Compatibility Test (41x361x1):**

Interpolated grid: dx=0.5000 mm, dy=0.5000 mm

Device Reference Point: 0, 0, -6.3 mm

Reference Value = 111.1 V/m; Power Drift = -0.02 dB

Applied MIF = 0.00 dB

RF audio interference level = 40.62 dBV/m

**Emission category: M3**

MIF scaled E-field

Grid 1 M3 40.36 dBV/m	Grid 2 M3 40.4 dBV/m	Grid 3 M3 40.14 dBV/m
Grid 4 M4 35.79 dBV/m	Grid 5 M4 35.83 dBV/m	Grid 6 M4 35.6 dBV/m
Grid 7 M3 40.45 dBV/m	Grid 8 M3 40.62 dBV/m	Grid 9 M3 40.51 dBV/m

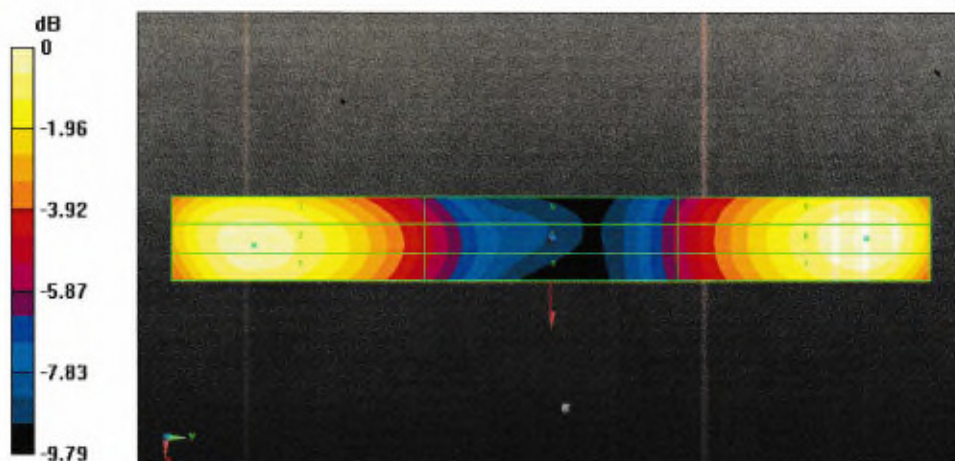

0 dB = 107.4 V/m = 40.62 dBV/m



Accredited by the Swiss Accreditation Service (SAS)  
The Swiss Accreditation Service is one of the signatories to the EA  
Multilateral Agreement for the recognition of calibration certificates

Accreditation No.: **SCS 0108**

Client **Sporton-KS (Auden)**

Certificate No: **CD1880V3-1155\_Jan16**

## CALIBRATION CERTIFICATE

Object **CD1880V3 - SN: 1155**

Calibration procedure(s) **QA CAL-20.v6  
Calibration procedure for dipoles in air**

Calibration date: **January 27, 2016**

This calibration certificate documents the traceability to national standards, which realize the physical units of measurements (SI).  
The measurements and the uncertainties with confidence probability are given on the following pages and are part of the certificate.

All calibrations have been conducted in the closed laboratory facility: environment temperature ( $22 \pm 3$ )°C and humidity < 70%.

Calibration Equipment used (M&TE critical for calibration)

Primary Standards	ID #	Cal Date (Certificate No.)	Scheduled Calibration
Power meter EPM-442A	GB37480704	07-Oct-15 (No. 217-02222)	Oct-16
Power sensor HP 8481A	US37292783	07-Oct-15 (No. 217-02222)	Oct-16
Power sensor HP 8481A	MY41092317	07-Oct-15 (No. 217-02223)	Oct-16
Reference 10 dB Attenuator	SN: 5047.2 / 06327	01-Apr-15 (No. 217-02130)	Mar-16
Probe ER3DV6	SN: 2336	31-Dec-15 (No. ER3-2336_Dec15)	Dec-16
Probe H3DV6	SN: 6065	31-Dec-15 (No. H3-6065_Dec15)	Dec-16
DAE4	SN: 781	04-Sep-15 (No. DAE4-781_Sep15)	Sep-16
Secondary Standards	ID #	Check Date (in house)	Scheduled Check
Power meter Agilent 4419B	SN: GB42420191	09-Oct-09 (in house check Sep-14)	In house check: Sep-16
Power sensor HP E4412A	SN: US38485102	05-Jan-10 (in house check Sep-14)	In house check: Sep-16
Power sensor HP 8482A	SN: US37295597	09-Oct-09 (in house check Sep-14)	In house check: Sep-16
Network Analyzer HP 8753E	US37390585	18-Oct-01 (in house check Oct-15)	In house check: Oct-16
RF generator R&S SMT-06	SN: 832283/011	27-Aug-12 (in house check Oct-15)	In house check: Oct-18

Calibrated by: **Leif Klysner** Laboratory Technician

Approved by: **Fin Bomholt** Deputy Technical Manager

Signature

Issued: January 28, 2016

This calibration certificate shall not be reproduced except in full without written approval of the laboratory.





Accredited by the Swiss Accreditation Service (SAS)

The Swiss Accreditation Service is one of the signatories to the EA  
Multilateral Agreement for the recognition of calibration certificates

Accreditation No.: **SCS 0108**

## References

- [1] ANSI-C63.19-2011  
American National Standard, Methods of Measurement of Compatibility between Wireless Communications  
Devices and Hearing Aids.

## Methods Applied and Interpretation of Parameters:

- **Coordinate System:** y-axis is in the direction of the dipole arms. z-axis is from the basis of the antenna (mounted on the table) towards its feed point between the two dipole arms. x-axis is normal to the other axes. In coincidence with the standards [1], the measurement planes (probe sensor center) are selected to be at a distance of 15 mm above the top metal edge of the dipole arms.
- **Measurement Conditions:** Further details are available from the hardcopies at the end of the certificate. All figures stated in the certificate are valid at the frequency indicated. The forward power to the dipole connector is set with a calibrated power meter connected and monitored with an auxiliary power meter connected to a directional coupler. While the dipole under test is connected, the forward power is adjusted to the same level.
- **Antenna Positioning:** The dipole is mounted on a HAC Test Arch phantom using the matching dipole positioner with the arms horizontal and the feeding cable coming from the floor. The measurements are performed in a shielded room with absorbers around the setup to reduce the reflections. It is verified before the mounting of the dipole under the Test Arch phantom, that its arms are perfectly in a line. It is installed on the HAC dipole positioner with its arms parallel below the dielectric reference wire and able to move elastically in vertical direction without changing its relative position to the top center of the Test Arch phantom. The vertical distance to the probe is adjusted after dipole mounting with a DASY5 Surface Check job. Before the measurement, the distance between phantom surface and probe tip is verified. The proper measurement distance is selected by choosing the matching section of the HAC Test Arch phantom with the proper device reference point (upper surface of the dipole) and the matching grid reference point (tip of the probe) considering the probe sensor offset. The vertical distance to the probe is essential for the accuracy.
- **Feed Point Impedance and Return Loss:** These parameters are measured using a HP 8753E Vector Network Analyzer. The impedance is specified at the SMA connector of the dipole. The influence of reflections was eliminated by applying the averaging function while moving the dipole in the air, at least 70cm away from any obstacles.
- **E-field distribution:** E field is measured in the x-y-plane with an isotropic ER3D-field probe with 100 mW forward power to the antenna feed point. In accordance with [1], the scan area is 20mm wide, its length exceeds the dipole arm length (180 or 90mm). The sensor center is 15 mm (in z) above the metal top of the dipole arms. Two 3D maxima are available near the end of the dipole arms. Assuming the dipole arms are perfectly in one line, the average of these two maxima (in subgrid 2 and subgrid 8) is determined to compensate for any non-parallelity to the measurement plane as well as the sensor displacement. The E-field value stated as calibration value represents the maximum of the interpolated 3D-E-field, in the plane above the dipole surface.

The reported uncertainty of measurement is stated as the standard uncertainty of measurement multiplied by the coverage factor  $k=2$ , which for a normal distribution corresponds to a coverage probability of approximately 95%.

## Measurement Conditions

DASY system configuration, as far as not given on page 1.

<b>DASY Version</b>	DASY5	V52.8.8
<b>Phantom</b>	HAC Test Arch	
<b>Distance Dipole Top - Probe Center</b>	15 mm	
<b>Scan resolution</b>	dx, dy = 5 mm	
<b>Frequency</b>	1880 MHz $\pm$ 1 MHz	
<b>Input power drift</b>	< 0.05 dB	

## Maximum Field values at 1880 MHz

<b>E-field 15 mm above dipole surface</b>	<b>condition</b>	<b>Interpolated maximum</b>
Maximum measured above high end	100 mW input power	90.4 V/m = 39.13 dBV/m
Maximum measured above low end	100 mW input power	87.8 V/m = 38.87 dBV/m
Averaged maximum above arm	100 mW input power	<b>89.1 V/m <math>\pm</math> 12.8 % (k=2)</b>

## Appendix (Additional assessments outside the scope of SCS 0108)

### Antenna Parameters

<b>Frequency</b>	<b>Return Loss</b>	<b>Impedance</b>
1730 MHz	33.1 dB	52.0 $\Omega$ - 1.1 j $\Omega$
1880 MHz	17.9 dB	42.7 $\Omega$ + 9.4 j $\Omega$
1900 MHz	18.4 dB	45.6 $\Omega$ + 10.7 j $\Omega$
1950 MHz	23.2 dB	50.8 $\Omega$ + 6.9 j $\Omega$
2000 MHz	19.7 dB	43.0 $\Omega$ + 6.7 j $\Omega$

### 3.2 Antenna Design and Handling

The calibration dipole has a symmetric geometry with a built-in two stub matching network, which leads to the enhanced bandwidth.

The dipole is built of standard semirigid coaxial cable. The internal matching line is open ended. The antenna is therefore open for DC signals.

Do not apply force to dipole arms, as they are liable to bend. The soldered connections near the feedpoint may be damaged. After excessive mechanical stress or overheating, check the impedance characteristics to ensure that the internal matching network is not affected.

After long term use with 40W radiated power, only a slight warming of the dipole near the feedpoint can be measured.



# Impedance Measurement Plot

27 Jan 2016 14:52:26

CH1 S11 LOG 5 dB/REF -18 dB 2f-17.856 dB 1 880.000 000 MHz



CH2 S11 1 U FS 2: 42.658  $\Omega$  9.3867  $\Omega$  794.65 pF 1 880.000 000 MHz

Del  
Cor  
Avg 16  
H1d

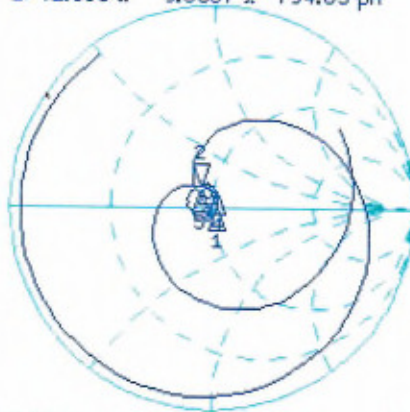

CENTER 1 880.000 000 MHz

SPAN 1 880.000 000 MHz



## DASY5 E-field Result

Date: 27.01.2016

Test Laboratory: SPEAG Lab2

**DUT: HAC Dipole 1880 MHz; Type: CD1880V3; Serial: CD1880V3 - SN: 1155**

Communication System: UID 0 - CW ; Frequency: 1880 MHz

Medium parameters used:  $\sigma = 0$  S/m,  $\epsilon_r = 1$ ;  $\rho = 1000$  kg/m<sup>3</sup>

Phantom section: RF Section

Measurement Standard: DASY5 (IEEE/IEC/ANSI C63.19-2011)

DASY52 Configuration:

- Probe: ER3DV6 - SN2336; ConvF(1, 1, 1); Calibrated: 31.12.2015;
- Sensor-Surface: (Fix Surface)
- Electronics: DAE4 Sn781; Calibrated: 04.09.2015
- Phantom: HAC Test Arch with AMCC; Type: SD HAC P01 BA; Serial: 1070
- DASY52 52.8.8(1258); SEMCAD X 14.6.10(7372)

**Dipole E-Field measurement @ 1880MHz/E-Scan - 1880MHz d=15mm/Hearing Aid Compatibility Test (41x181x1):**

Interpolated grid: dx=0.5000 mm, dy=0.5000 mm

Device Reference Point: 0, 0, -6.3 mm

Reference Value = 154.9 V/m; Power Drift = 0.02 dB

Applied MIF = 0.00 dB

RF audio interference level = 39.13 dBV/m

**Emission category: M2**

MIF scaled E-field

Grid 1 M2 38.98 dBV/m	Grid 2 M2 39.13 dBV/m	Grid 3 M2 38.99 dBV/m
Grid 4 M2 36.69 dBV/m	Grid 5 M2 36.77 dBV/m	Grid 6 M2 36.59 dBV/m
Grid 7 M2 38.71 dBV/m	Grid 8 M2 38.87 dBV/m	Grid 9 M2 38.76 dBV/m

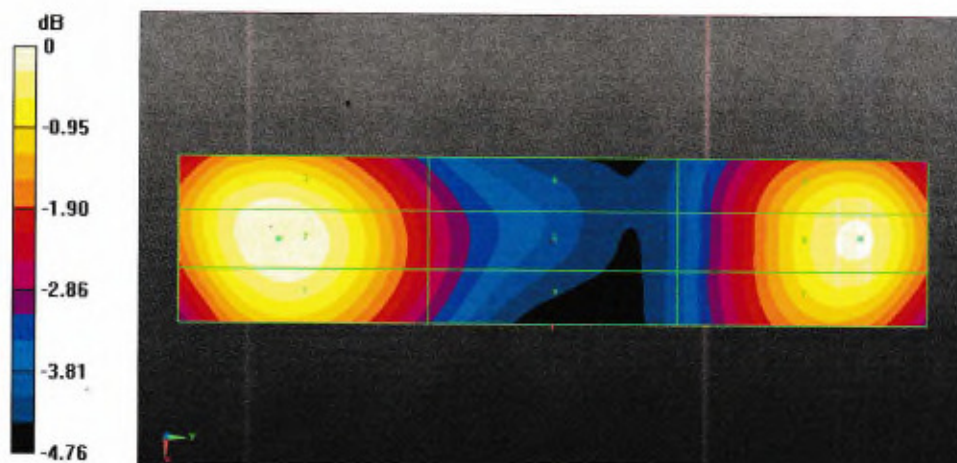



In Collaboration with  
**s p e a g**  
CALIBRATION LABORATORY



中国认可  
国际互认  
校准  
CALIBRATION  
CNAS L0570

Add: No.51 Xueyuan Road, Haidian District, Beijing, 100191, China  
Tel: +86-10-62304633-2218 Fax: +86-10-62304633-2209  
E-mail: cttl@chinattl.com [Http://www.chinattl.cn](http://www.chinattl.cn)

Client : **Sporton\_CN**

Certificate No: **Z16-97071**

## CALIBRATION CERTIFICATE

Object **DAE4 - SN: 1210**

Calibration Procedure(s) **FD-Z11-2-002-01**  
Calibration Procedure for the Data Acquisition Electronics (DAEx)

Calibration date: **May 18, 2016**

This calibration Certificate documents the traceability to national standards, which realize the physical units of measurements(SI). The measurements and the uncertainties with confidence probability are given on the following pages and are part of the certificate.

All calibrations have been conducted in the closed laboratory facility: environment temperature(22±3)°C and humidity<70%.

Calibration Equipment used (M&TE critical for calibration)

Primary Standards	ID #	Cal Date(Calibrated by, Certificate No.)	Scheduled Calibration
-------------------	------	--	-----------------------

Process Calibrator 753	1971018	06-July-15 (CTTL, No:J15X04257)	July-16
------------------------	---------	---------------------------------	---------

	Name	Function	Signature
Calibrated by:	Yu Zongying	SAR Test Engineer	
Reviewed by:	Qi Dianyuan	SAR Project Leader	
Approved by:	Lu Bingsong	Deputy Director of the laboratory	

Issued: May 19, 2016

This calibration certificate shall not be reproduced except in full without written approval of the laboratory.



In Collaboration with

**s p e a g**

**CALIBRATION LABORATORY**

Add: No.51 Xueyuan Road, Haidian District, Beijing, 100191, China

Tel: +86-10-62304633-2218

Fax: +86-10-62304633-2209

E-mail: [ettl@chinattl.com](mailto:ettl@chinattl.com)

[Http://www.chinattl.cn](http://www.chinattl.cn)

### **Glossary:**

DAE data acquisition electronics  
Connector angle information used in DASY system to align probe sensor X to the robot coordinate system.

### **Methods Applied and Interpretation of Parameters:**

- *DC Voltage Measurement:* Calibration Factor assessed for use in DASY system by comparison with a calibrated instrument traceable to national standards. The figure given corresponds to the full scale range of the voltmeter in the respective range.
- *Connector angle:* The angle of the connector is assessed measuring the angle mechanically by a tool inserted. Uncertainty is not required.
- The report provide only calibration results for DAE, it does not contain other performance test results.





In Collaboration with

**s p e a g**  
**CALIBRATION LABORATORY**

Add: No.51 Xueyuan Road, Haidian District, Beijing, 100191, China  
Tel: +86-10-62304633-2218 Fax: +86-10-62304633-2209  
E-mail: cttl@chinattl.com Http://www.chinattl.cn

### DC Voltage Measurement

A/D - Converter Resolution nominal

High Range: 1LSB =  $6.1\mu\text{V}$ , full range =  $-100\dots+300\text{ mV}$

Low Range: 1LSB =  $61\text{nV}$ , full range =  $-1\dots+3\text{mV}$

DASY measurement parameters: Auto Zero Time: 3 sec; Measuring time: 3 sec

Calibration Factors	X	Y	Z
High Range	$404.076 \pm 0.15\% (k=2)$	$404.897 \pm 0.15\% (k=2)$	$405.013 \pm 0.15\% (k=2)$
Low Range	$3.99810 \pm 0.7\% (k=2)$	$3.98220 \pm 0.7\% (k=2)$	$3.99829 \pm 0.7\% (k=2)$

### Connector Angle

Connector Angle to be used in DASY system	$58^\circ \pm 1^\circ$
---	------------------------



Accredited by the Swiss Accreditation Service (SAS)  
The Swiss Accreditation Service is one of the signatories to the EA  
Multilateral Agreement for the recognition of calibration certificates

Accreditation No.: **SCS 0108**

Client **Sporton-KS (Auden)**

Certificate No: **ER3-2476\_Nov15**

**CALIBRATION CERTIFICATE**

Object **ER3DV6 - SN:2476**

Calibration procedure(s) **QA CAL-02.v8, QA CAL-25.v6  
Calibration procedure for E-field probes optimized for close near field  
evaluations in air**

Calibration date: **November 25, 2015**

This calibration certificate documents the traceability to national standards, which realize the physical units of measurements (SI).  
The measurements and the uncertainties with confidence probability are given on the following pages and are part of the certificate.

All calibrations have been conducted in the closed laboratory facility: environment temperature (22 ± 3)°C and humidity < 70%.

Calibration Equipment used (M&TE critical for calibration)

Primary Standards	ID	Cal Date (Certificate No.)	Scheduled Calibration
Power meter E4419B	GB41293874	01-Apr-15 (No. 217-02128)	Mar-16
Power sensor E4412A	MY41498087	01-Apr-15 (No. 217-02128)	Mar-16
Reference 3 dB Attenuator	SN: S5054 (3c)	01-Apr-15 (No. 217-02129)	Mar-16
Reference 20 dB Attenuator	SN: S5277 (20x)	01-Apr-15 (No. 217-02132)	Mar-16
Reference 30 dB Attenuator	SN: S5129 (30b)	01-Apr-15 (No. 217-02133)	Mar-16
Reference Probe ER3DV6	SN: 2328	12-Oct-15 (No. ER3-2328_Oct15)	Oct-16
DAE4	SN: 789	16-Mar-15 (No. DAE4-789_Mar15)	Mar-16
Secondary Standards	ID	Check Date (in house)	Scheduled Check
RF generator HP 8648C	US3642U01700	4-Aug-99 (in house check Apr-13)	In house check: Apr-16
Network Analyzer HP 8753E	US37390585	18-Oct-01 (in house check Oct-15)	In house check: Oct-16

Calibrated by:	Name <b>Israe Elnaouq</b>	Function <b>Laboratory Technician</b>	Signature 
Approved by:	Name <b>Katja Pokovic</b>	Function <b>Technical Manager</b>	Signature 

Issued: November 26, 2015

This calibration certificate shall not be reproduced except in full without written approval of the laboratory.



Accredited by the Swiss Accreditation Service (SAS)

Accreditation No.: **SCS 0108**

The Swiss Accreditation Service is one of the signatories to the EA  
Multilateral Agreement for the recognition of calibration certificates

**Glossary:**

NORM <sub>x,y,z</sub>	sensitivity in free space
DCP	diode compression point
CF	crest factor (1/duty_cycle) of the RF signal
A, B, C, D	modulation dependent linearization parameters
Polarization $\varphi$	$\varphi$ rotation around probe axis
Polarization $\vartheta$	$\vartheta$ rotation around an axis that is in the plane normal to probe axis (at measurement center), i.e., $\vartheta = 0$ is normal to probe axis
Connector Angle	information used in DASY system to align probe sensor X to the robot coordinate system

**Calibration is Performed According to the Following Standards:**

- a) IEEE Std 1309-2005, "IEEE Standard for calibration of electromagnetic field sensors and probes, excluding antennas, from 9 kHz to 40 GHz", December 2005
- b) CTIA Test Plan for Hearing Aid Compatibility, Rev 3.0, November 2013

**Methods Applied and Interpretation of Parameters:**

- *NORM<sub>x,y,z</sub>*: Assessed for E-field polarization  $\vartheta = 0$  for XY sensors and  $\vartheta = 90$  for Z sensor ( $f \leq 900$  MHz in TEM-cell;  $f > 1800$  MHz: R22 waveguide).
- *NORM(f)<sub>x,y,z</sub>* = *NORM<sub>x,y,z</sub>* \* *frequency\_response* (see Frequency Response Chart).
- *DCP<sub>x,y,z</sub>*: DCP are numerical linearization parameters assessed based on the data of power sweep with CW signal (no uncertainty required). DCP does not depend on frequency nor media.
- *PAR*: PAR is the Peak to Average Ratio that is not calibrated but determined based on the signal characteristics
- *A<sub>x,y,z</sub>*; *B<sub>x,y,z</sub>*; *C<sub>x,y,z</sub>*; *D<sub>x,y,z</sub>*; *VR<sub>x,y,z</sub>*: *A, B, C, D* are numerical linearization parameters assessed based on the data of power sweep for specific modulation signal. The parameters do not depend on frequency nor media. *VR* is the maximum calibration range expressed in RMS voltage across the diode.
- *Spherical isotropy (3D deviation from isotropy)*: in a locally homogeneous field realized using an open waveguide setup.
- *Sensor Offset*: The sensor offset corresponds to the offset of virtual measurement center from the probe tip (on probe axis). No tolerance required.
- *Connector Angle*: The angle is assessed using the information gained by determining the *NORM<sub>x</sub>* (no uncertainty required).



# Probe ER3DV6

## SN:2476

Manufactured: March 31, 2009  
Calibrated: November 25, 2015

**Calibrated for DASY/EASY Systems**  
(Note: non-compatible with DASY2 system!)

## DASY/EASY - Parameters of Probe: ER3DV6 - SN:2476

### Basic Calibration Parameters

	Sensor X	Sensor Y	Sensor Z	Unc (k=2)
Norm ( $\mu\text{V}/(\text{V}/\text{m})^2$ )	1.92	1.70	2.21	$\pm 10.1 \%$
DCP (mV) <sup>B</sup>	100.8	100.7	101.6	

### Modulation Calibration Parameters

UID	Communication System Name		A dB	B dB $\sqrt{\mu\text{V}}$	C	D dB	VR mV	Unc <sup>E</sup> (k=2)
0	CW	X	0.0	0.0	1.0	0.00	183.5	$\pm 3.0 \%$
		Y	0.0	0.0	1.0		215.7	
		Z	0.0	0.0	1.0		167.5	
10011- CAB	UMTS-FDD (WCDMA)	X	3.36	67.8	19.3	2.91	148.5	$\pm 0.9 \%$
		Y	3.25	67.0	18.9		129.5	
		Z	3.30	67.5	19.1		135.5	
10021- DAB	GSM-FDD (TDMA, GMSK)	X	15.67	99.5	28.6	9.39	134.6	$\pm 1.2 \%$
		Y	16.21	99.9	28.8		116.7	
		Z	21.64	99.5	28.8		108.1	
10039- CAB	CDMA2000 (1xRTT, RC1)	X	4.98	68.3	20.3	4.57	147.9	$\pm 1.4 \%$
		Y	4.78	67.1	19.5		124.6	
		Z	4.71	67.0	19.4		134.7	
10081- CAB	CDMA2000 (1xRTT, RC3)	X	3.98	66.8	19.2	3.97	143.5	$\pm 0.7 \%$
		Y	3.86	65.9	18.7		120.9	
		Z	3.85	66.0	18.7		130.6	
10295- AAB	CDMA2000, RC1, SO3, 1/8th Rate 25 fr.	X	13.31	98.6	41.9	12.49	83.0	$\pm 2.7 \%$
		Y	14.28	99.8	42.0		98.4	
		Z	17.01	99.3	39.7		86.2	

The reported uncertainty of measurement is stated as the standard uncertainty of measurement multiplied by the coverage factor  $k=2$ , which for a normal distribution corresponds to a coverage probability of approximately 95%.

<sup>B</sup> Numerical linearization parameter: uncertainty not required.

<sup>E</sup> Uncertainty is determined using the max. deviation from linear response applying rectangular distribution and is expressed for the square of the field value.



## Frequency Response of E-Field (TEM-Cell:ifi110 EXX, Waveguide: R22)

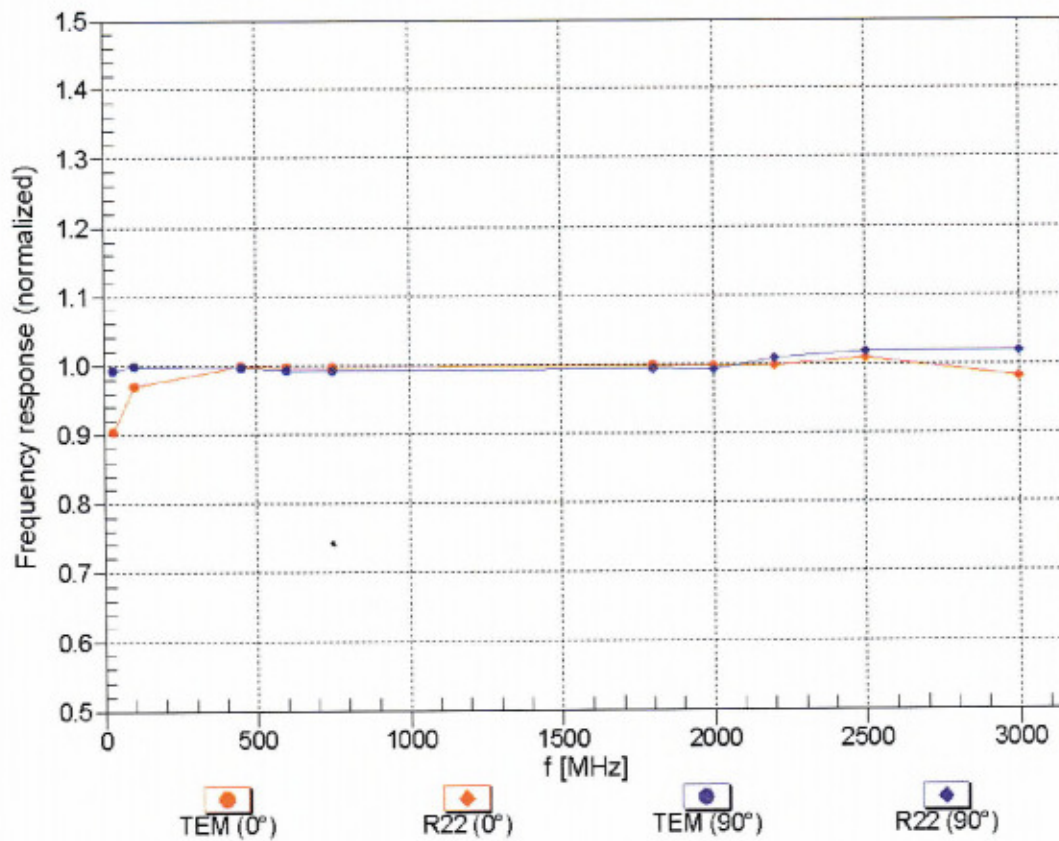

Uncertainty of Frequency Response of E-field:  $\pm 6.3\%$  (k=2)

### Receiving Pattern ( $\phi$ ), $\vartheta = 0^\circ$

f=450 MHz, TEM,  $0^\circ$

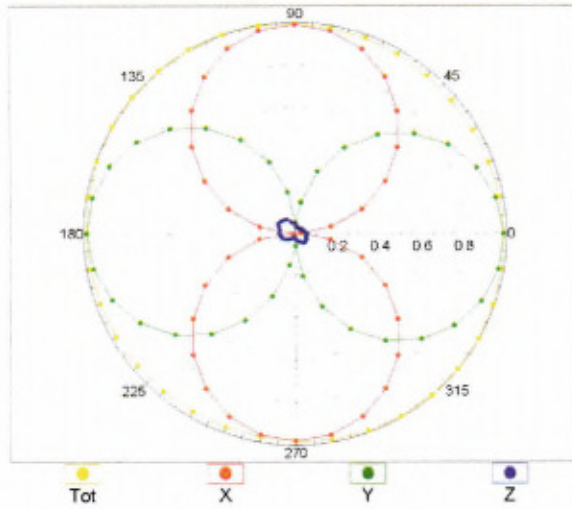

f=2500 MHz, R22,  $0^\circ$

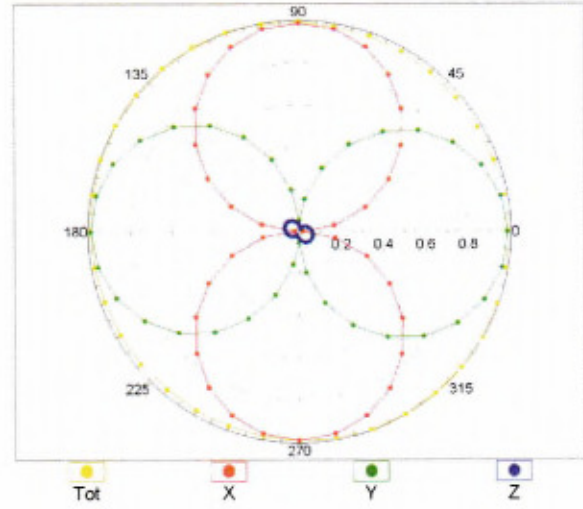

### Receiving Pattern ( $\phi$ ), $\vartheta = 90^\circ$

f=450 MHz, TEM,  $90^\circ$

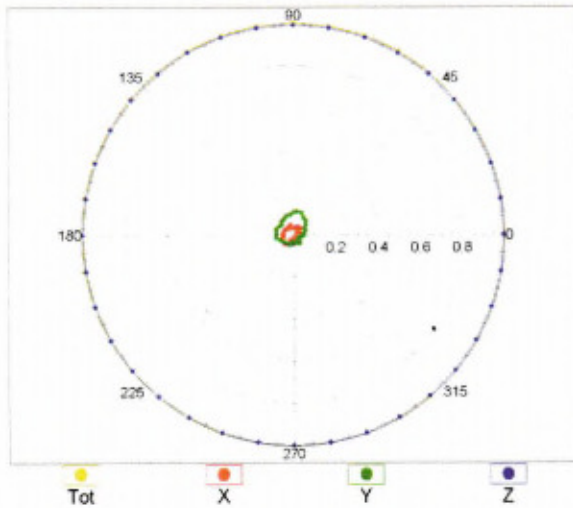

f=2500 MHz, R22,  $90^\circ$

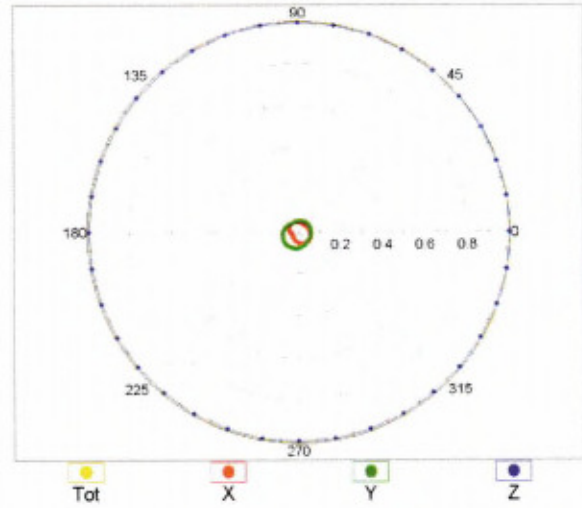

### Receiving Pattern ( $\phi$ ), $\vartheta = 0^\circ$

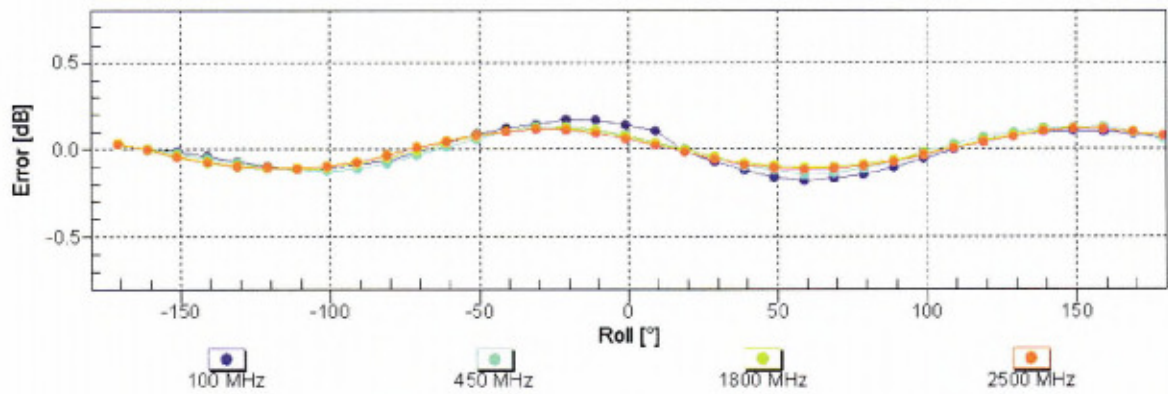

Uncertainty of Axial Isotropy Assessment:  $\pm 0.5\%$  ( $k=2$ )

### Receiving Pattern ( $\phi$ ), $\vartheta = 90^\circ$

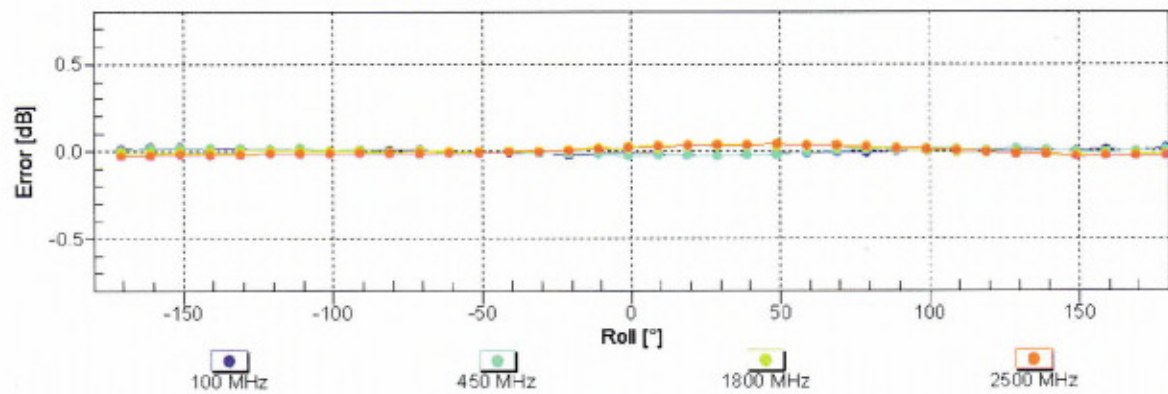

Uncertainty of Axial Isotropy Assessment:  $\pm 0.5\%$  ( $k=2$ )

### Dynamic Range f(E-field) (TEM cell , f = 900 MHz)

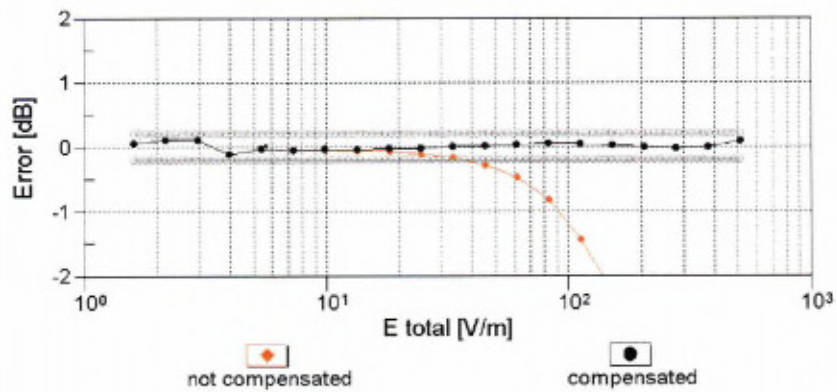
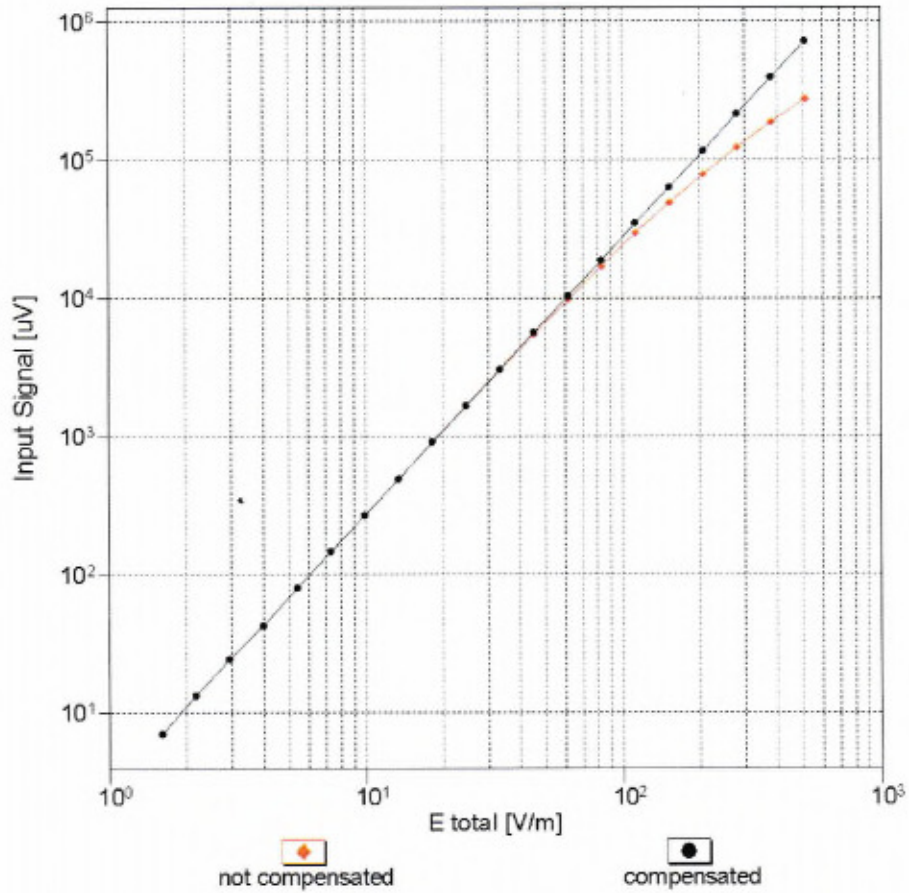

Uncertainty of Linearity Assessment: ± 0.6% (k=2)



# Deviation from Isotropy in Air

Error ( $\phi, \vartheta$ ),  $f = 900$  MHz

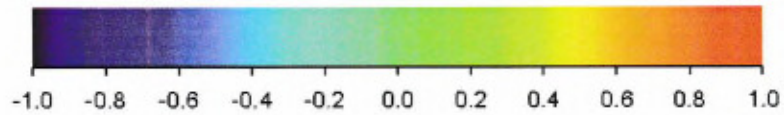
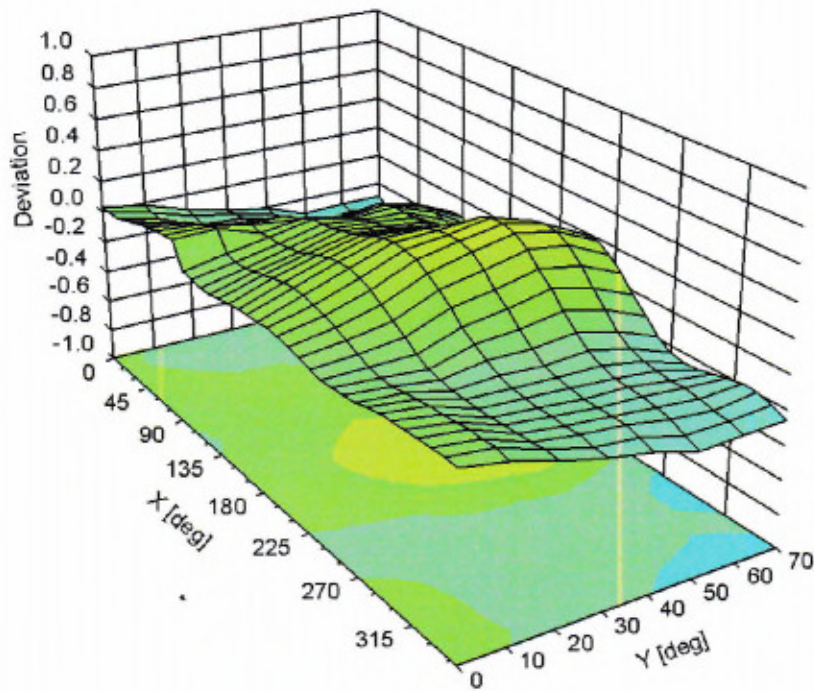

Uncertainty of Spherical Isotropy Assessment:  $\pm 2.6\%$  ( $k=2$ )

## DASY/EASY - Parameters of Probe: ER3DV6 - SN:2476

### Other Probe Parameters

Sensor Arrangement	Rectangular
Connector Angle (°)	19
Mechanical Surface Detection Mode	enabled
Optical Surface Detection Mode	disabled
Probe Overall Length	337 mm
Probe Body Diameter	10 mm
Tip Length	10 mm
Tip Diameter	8 mm
Probe Tip to Sensor X Calibration Point	2.5 mm
Probe Tip to Sensor Y Calibration Point	2.5 mm
Probe Tip to Sensor Z Calibration Point	2.5 mm