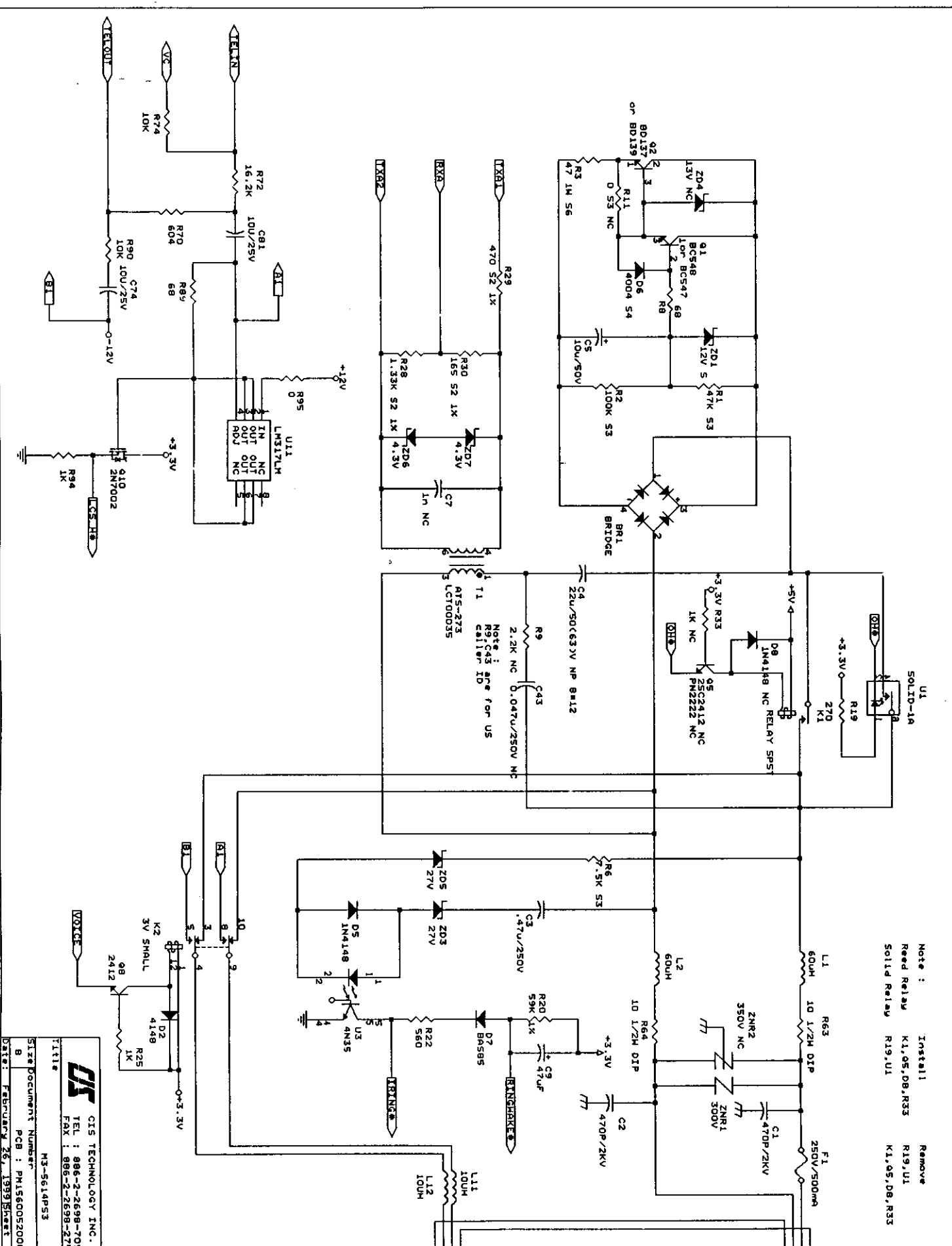

***EXHIBIT D***  
***Circuit Diagram***



Note : Install  
 Reed Relay K1.05.D8.R33 R19.U1  
 Solid Relay R19.U1 K1.05.D8.R33

**CTS**  
 CIS TECHNOLOGY INC.  
 TEL : 886-2-2698-7099  
 FAX : 886-2-2698-2753

Size Document Number: M3-5614P53  
 PCB : PH1560052000  
 Date : FEBRUARY 26, 1999 Sheet 1 of 1

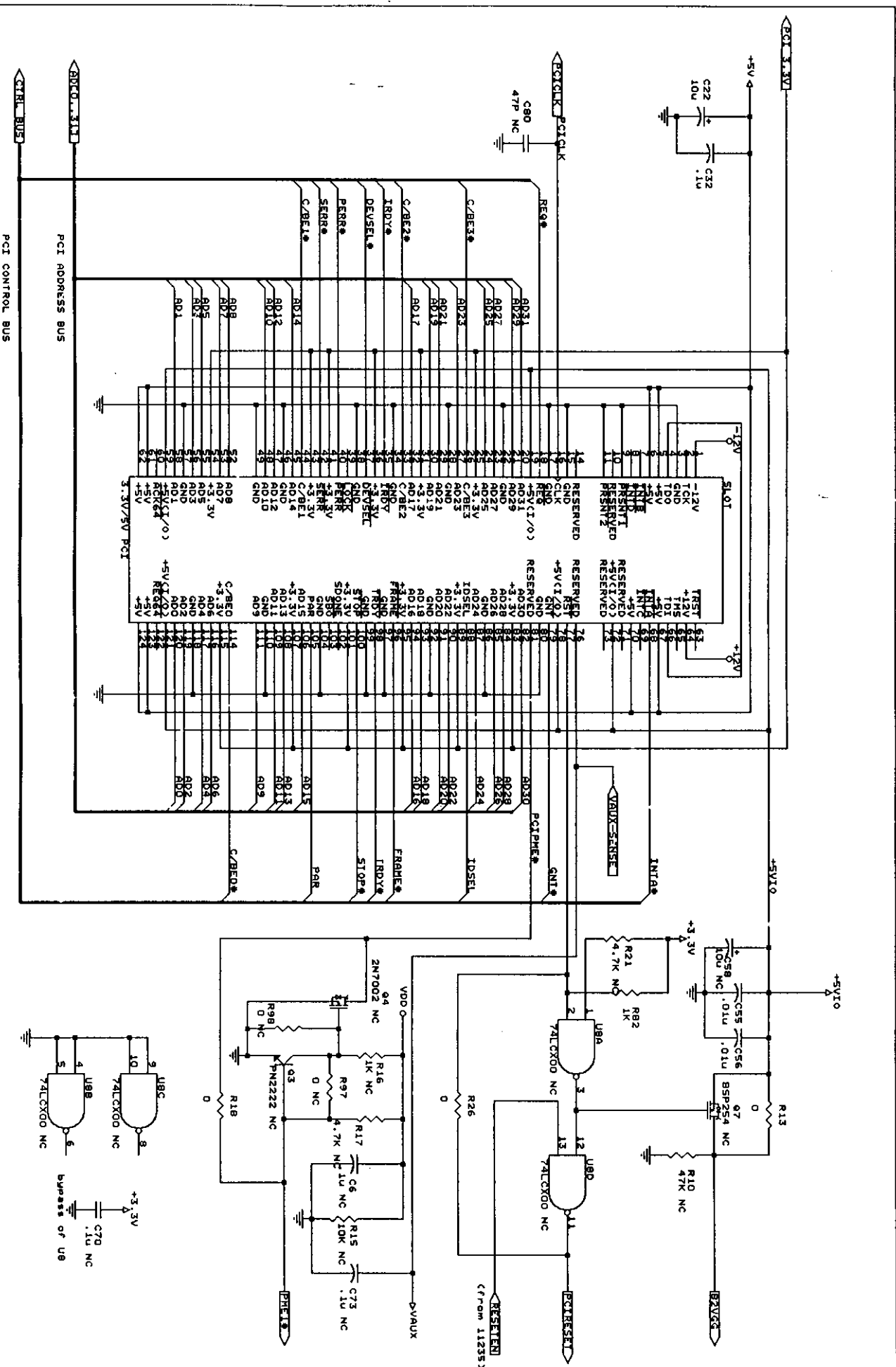

**CIS** CIS TECHNOLOGY INC.  
 TEL : 886-2-2698-7099  
 FAX : 886-2-2698-2753  
 M3-5614P53

Size Document Number: 8  
 PCB : PH1560DS2000  
 Date: March 1, 1999 Sheet 2 of 2



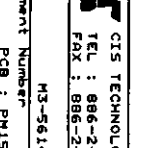
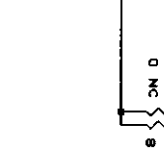
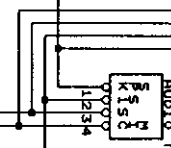
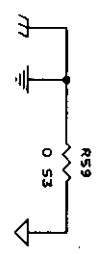
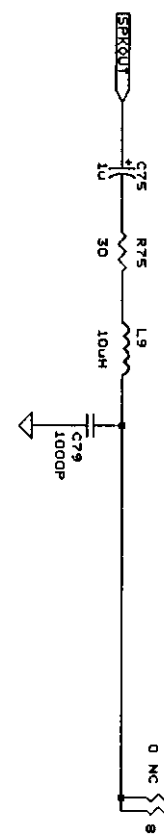
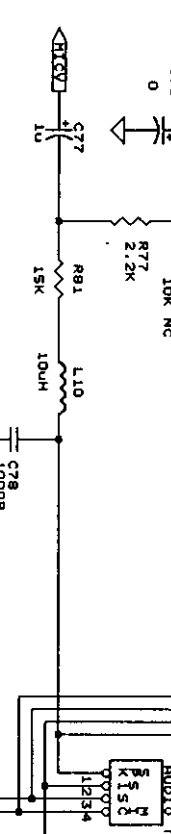
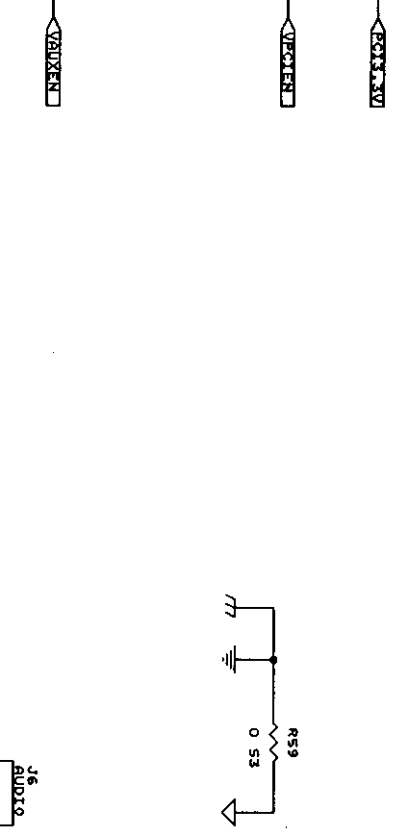
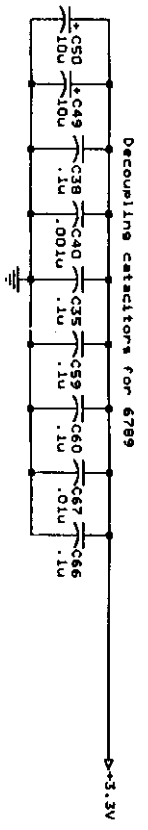
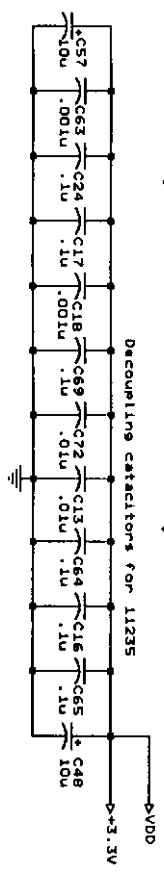
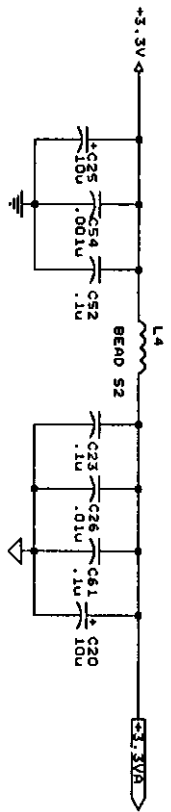
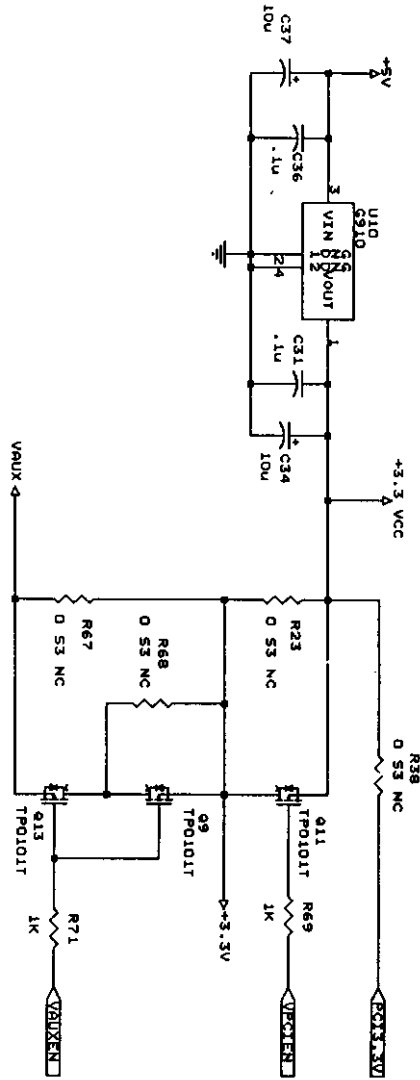

**CIS TECHNOLOGY INC.**  
 TEL : 886-2-698-7099  
 FAX : 886-2-698-2753  
 H3-5614P53  
 Size Document Number : PN1560052000  
 B PCB : March 1, 1998 Sheet 4 of 4