



H.B. Compliance Solutions

Intentional Radiator Test Report

For the

Globalstar, Inc.

SmartOneC

Tested under

The FCC Rules contained in Title 47 of the CFR, Part 25 for

Satellite Communications

November 12, 2021

Prepared for:

Globalstar, Inc.

1351 Holiday Square Blvd.

Covington, LA 70433

Prepared By:

H.B. Compliance Solutions

5005 S. Ash Avenue, Suite # A-10

Tempe, Arizona 85282

Reviewed By:

A handwritten signature in black ink, appearing to read 'Hoosamuddin Bandukwala', written over a light gray grid background.

Hoosamuddin Bandukwala



Cert # ATL-0062-E

Engineering Statement: The measurements shown in this report were made in accordance with the procedure indicated, and the emissions from this equipment were found to be within the limits applicable. I assume full responsibility for the accuracy and completeness of these measurements, and for the qualifications of all persons taking them. It is further stated that upon the basis of the measurement made, the equipment tested is capable of operation in accordance with the requirements of Part 25 of the FCC Rules under normal use and maintenance. All results contained herein relate only to the sample tested.



Report Status Sheet

Revision #	Report Date	Reason for Revision
∅	November 12, 2021	Initial Issue
1	November 30, 2021	TCB Comments

Table of Contents

EXECUTIVE SUMMARY	4
1. Testing Summary.....	4
EQUIPMENT CONFIGURATION.....	5
1. Overview	5
2. Test Facility.....	6
3. Description of Test Sample	7
4. Equipment Configuration	7
5. Support Equipment	7
6. Ports and Cabling Information.....	8
7. Method of Monitoring EUT Operation.....	8
8. Mode of Operation.....	8
9. Modifications	8
10. Disposition of EUT	8
Criteria for Intentional Radiators	9
1. RF Power Output	9
2. Occupied Bandwidth	11
3. Unwanted Emissions at Antenna Terminals.....	13
4. Radiated Spurious Emissions	20
5. Protection of Aeronautical Radio Navigation Satellite Service	23
6. Frequency Stability vs Temperature	29
7. Frequency Stability vs Voltage.....	31
Test Equipment.....	33
8. Measurement Uncertainty	34

EXECUTIVE SUMMARY

1. Testing Summary

These tests were conducted on a sample of the equipment for the purpose of demonstrating compliance with Part 25. All tests were conducted using measurement procedure from ANSI C63.26-2015 as appropriate.

Test Name	Test Method / FCC Standard	Result	Comments
RF Output Power	§2.1046; §25.204	Pass	
Occupied Bandwidth	§2.1049	Pass	
Unwanted Emissions at Antenna Terminals	§2.1051; §25.202(f)	Pass	
Radiated Spurious Emissions	§2.1053; §25.202(f)	Pass	
Protection of Aeronautical Radio Navigation Satellite Service	§25.216(c)(f)(g)(i)(j)	Pass	
Frequency Stability over Temperature Variations	§2.1055(a)(1); §25.202(d)	Pass	
Frequency Stability over Voltage Variations	§2.1055(d); §25.202(d)	Pass	

EQUIPMENT CONFIGURATION

1. Overview

H.B Compliance Solutions was contracted by Globalstar to perform testing on the SmartOneC under the purchase number 17587.

This document describes the test setups, test methods, required test equipment, and the test limit criteria used to perform compliance testing of the Globalstar, SmartOneC.

The tests were based on FCC Part 25 Rules. The tests described in this document were formal tests as described with the objective of the testing was to evaluate compliance of the Equipment Under Test (EUT) to the requirements of the aforementioned specifications. Globalstar should retain a copy of this document and it should be kept on file for at least five years after the manufacturing of the EUT has been permanently discontinued. The results obtained relate only to the item(s) tested.

Product Name:	SmartOneC
Model(s) Tested:	SmartOneC
FCC ID:	L2V-S1C
Supply Voltage Input:	Primary Power: 6 VDC
Frequency Range:	1611.25MHz to 1618.75MHz
No. of Channels:	4 Channels
Necessary Bandwidth	N/A
Type(s) of Modulation:	BPSK
Range of Operation Power:	0.19W
Voltage into final Transistor	3.3V
Current into final Transistor	475mA
Emission Designator:	1M99G1D
Channel Spacing(s)	2.5MHz
Test Item:	Pre-Production
Type of Equipment:	Mobile
Antenna:	Integrated Patch Antenna (1.0dBi Gain)
Environmental Test Conditions:	Temperature: 15-35°C Humidity: 30-60% Barometric Pressure: 860-1060 mbar
Modification to the EUT:	None
Evaluated By:	Staff at H.B. Compliance Solutions
Test Date(s):	07/23/2021 till 11/30/2021

2. Test Facility

All testing was performed at H.B. Compliance Solutions. This facility is located at 5005 S. Ash Avenue, Suite # A-10, Tempe AZ-85282. All equipment used in making physical determination is accurate and bears recent traceability to the National Institute of Standards and Technology.

Radiated Emissions measurements from 30MHz to 1GHz were performed in a GTEM chamber (equivalent to an Open Area Test Site). Radiated Emissions Above 1GHz were performed on an Open Area Test Site (OATS). In accordance with §2.948(a)(3), a complete site description is contained at H.B. Compliance Solutions.

Test facility H.B. Compliance Solutions is an ANAB accredited test site. The ANAB certificate number is L2458. The scope of accreditation can be found on ANAB website www.anab.org



3. Description of Test Sample

The Globalstar SmartOne C is designed to track the positions of trailers, cargo containers, heavy construction equipment, generators, boats/barges and any other mobile assets. The SmartOne also has 2 dry contact inputs, to manage run time of engines and/or other alarm inputs, and one serial port for passive and smart sensors. The SmartOne processes GPS satellite signals to obtain its position in terms of longitude and latitude and transmits this information over Globalstar’s Satellite Network. In addition to position information, the SmartOne transmits other message types that include battery status, input alarm status and diagnostic information. The SmartOne is configured using a computer and USB configuration cable to communicate these messages at certain times and/or under certain conditions.

4. Equipment Configuration

Ref. ID	Name / Description	Model Number	Serial Number
# 1	Globalstar (Sample # 1 with temporary SMA connector) – For Conducted test only	SmartOneC	0-4315262
# 2	Globalstar (Sample # 2) – For Radiated test only	SmartOneC	0-4315943

Table 1. Equipment Configuration

5. Support Equipment

All support equipment supplied is listed in the following Support Equipment List.

Ref ID	Name / Description	Manufacturer	Model #	Serial #
#2	DC Power Supply	Lambda	LA-200	LA2-AA20-143 3535
#3	Laptop Computer	Acer	Aspire One	LUSAL0B137011532631601

Table 2. Support Equipment

6. Ports and Cabling Information

Ref ID	Port name on the EUT	Cable Description	Qty.	Length (m)	Shielded? (Y/N)	Termination Box ID & Port ID
#4	Power	2 wire	1	2	N	DC Power Supply
#5	USB	USB Cable	1	0.5	N	#3

Table 3. Ports and Cabling Information

7. Method of Monitoring EUT Operation

A test receiver will be used to monitor the data transmission from the EUT.

8. Mode of Operation

The EUT will be configured to transmit at maximum power level. Test mode was provided using a Hex Dumper application on the laptop to set the frequency, power level and change the device from CW to Modulation mode. These settings were created for testing purpose only.

9. Modifications

9.1 Modifications to EUT

No modifications were made to the EUT

9.2 Modifications to Test Standard

No Modifications were made to the test standard.

10. Disposition of EUT

The test sample including all support equipment submitted to H.B Compliance Solutions for testing will be returned to Globalstar upon completion of testing & certification

Criteria for Intentional Radiators

1. RF Power Output

Test Requirement(s):	§2.1046, §25.204	Test Engineer(s):	Sean E.
Test Results:	Pass	Test Date(s):	11/30/2021

Test Procedures: As required by 47 CFR §2.1046, RF Power output measurements were made at the RF output terminals of the EUT.

Customer provided a test mode internal to the EUT to control the RF modulation, and frequency channel. The EUT was connected through an attenuator to a Spectrum Analyzer capable of making power measurements. Measurements were made at the low and high channels of the entire frequency band.

Test Setup:

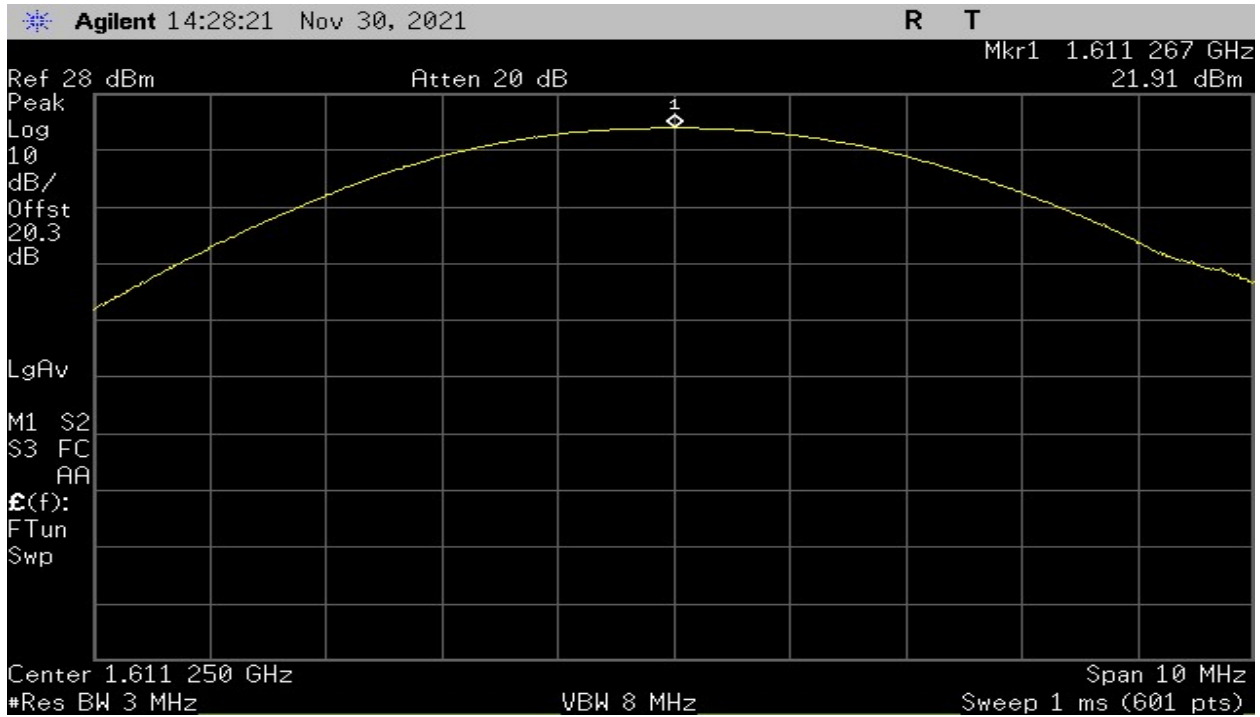

Figure 1 Output RF power Test Setup

Test Results:

Frequency (MHz)	Channel	Conducted Power (dBm)	Transmit Antenna Gain (dBi)	Carrier Power Peak EIRP (dBm)	Specification Limit (dBW)
1611.25	Lowest	21.91	1.0	22.91	40
1618.75	Highest	21.89	1.0	22.89	40

Table 4. RF Power Output, Test Results



Plot 1 – Output Power – Low

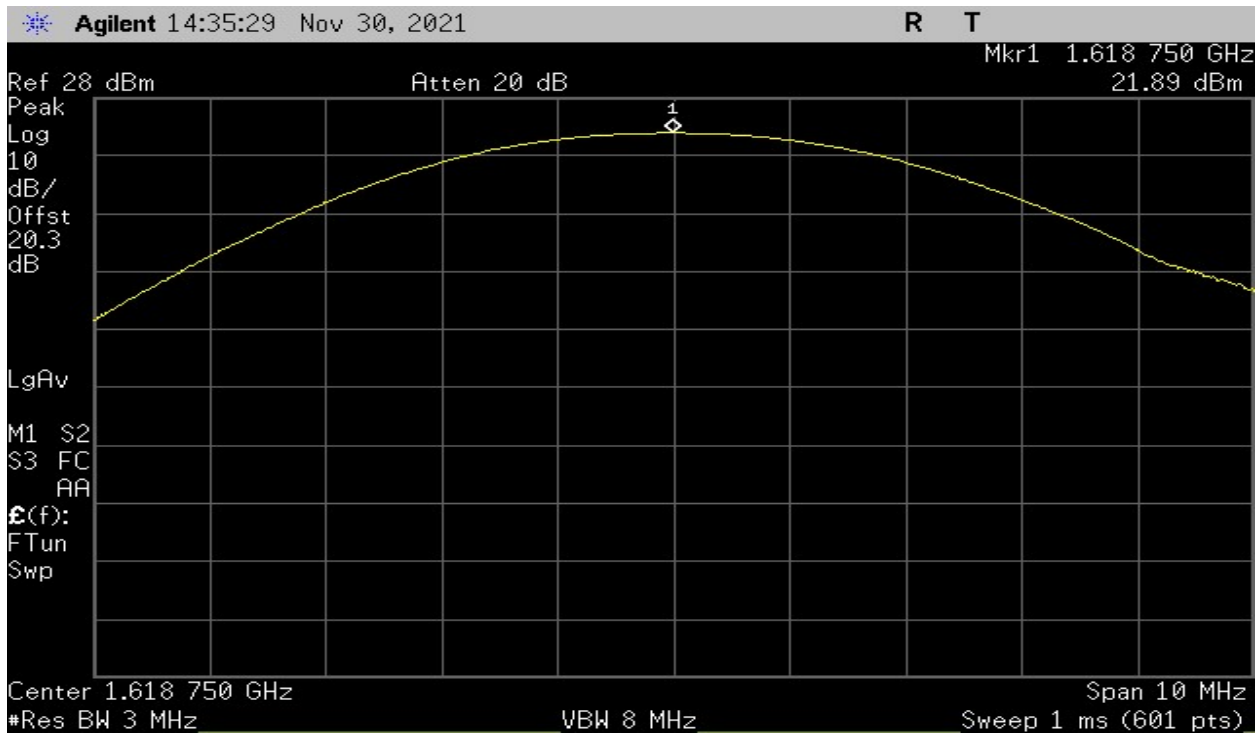

Plot 2 – Output Power – High

2. Occupied Bandwidth

Test Requirement(s):	§2.1049	Test Engineer(s):	Sean E.
Test Results:	Pass	Test Date(s):	07/28/2021

Test Procedure: As required by 47 CFR §2.1049, occupied bandwidth measurements were made at the output terminals of the EUT.

Customer provided a test mode internal to the EUT to control the RF modulation, and frequency channel. The EUT was connected through an attenuator to a Spectrum Analyzer. The measured highest peak power was set relative to zero dB reference. The RBW of the Spectrum Analyzer was set to at least 1% of the channel bandwidth and video bandwidth was set to 3 times the resolution bandwidth. Measurements were carried out at the low and high channels of the TX band.

The following pages show measurements of Occupied Bandwidth plots:

Test Setup:



Figure 2: Occupied Bandwidth Test Setup

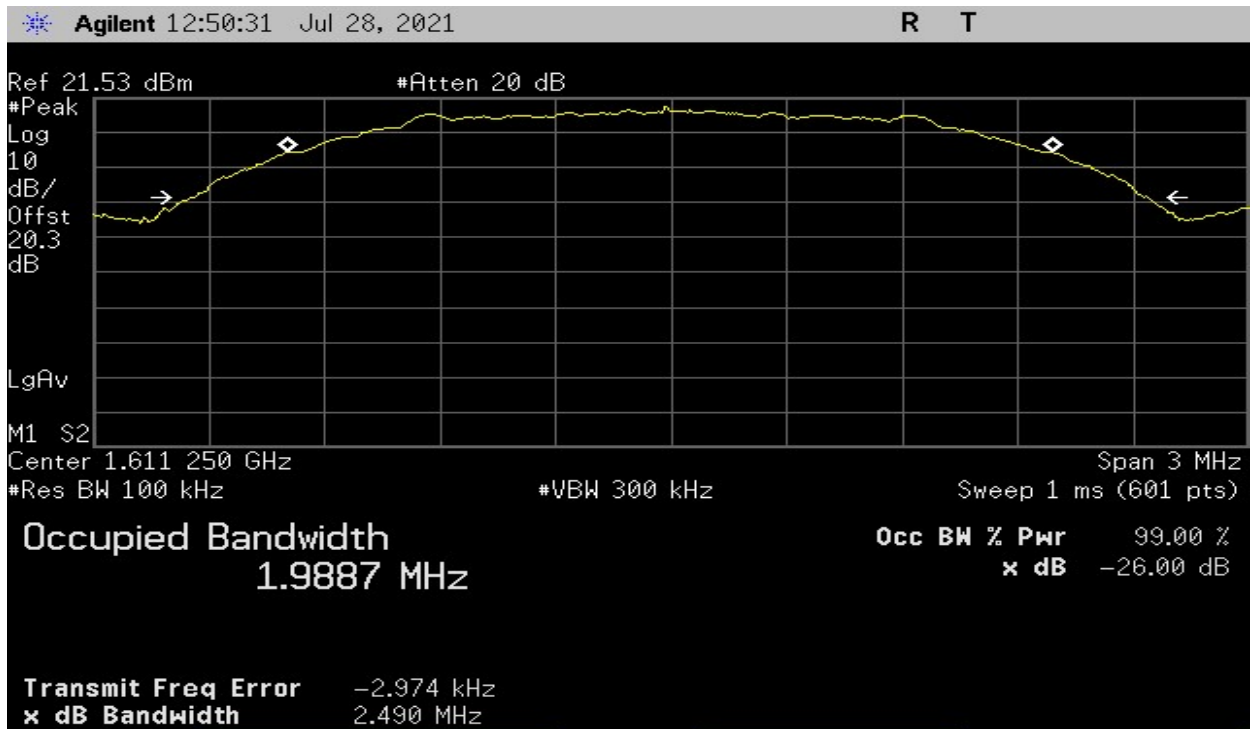

Plot 3 – Low Channel – 26dB Bandwidth

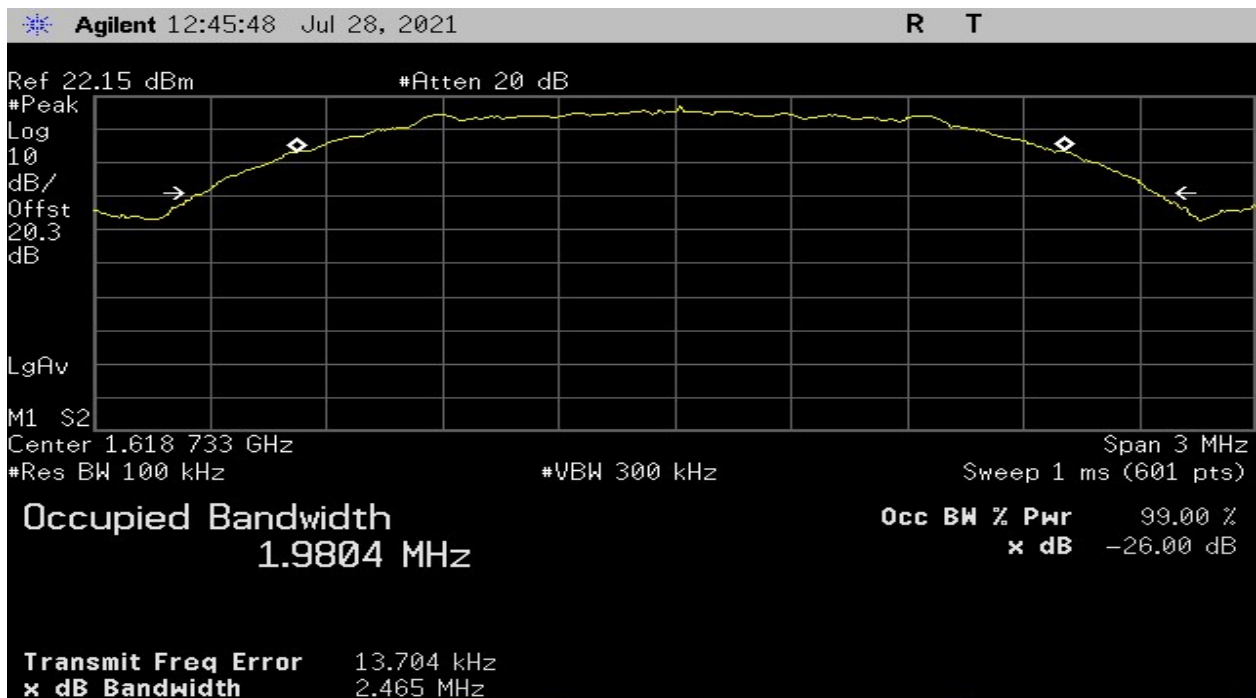

Plot 4 – High Channel – 26dB Bandwidth

3. Unwanted Emissions at Antenna Terminals

Test Requirement(s):	§2.1051, §25.202(f)	Test Engineer(s):	Sean E.
Test Results:	Pass	Test Date(s):	08/02/2021

Test Procedures: As required by 47 CFR §25.202(f), unwanted emissions at antenna terminal measurements were made at the RF output antenna terminal of the EUT.

Customer provided a test mode internal to the EUT to control the RF modulation, and frequency channel. The EUT was connected through an attenuator to a Spectrum Analyzer to verify the DUT met the requirements as specified in §25.202(f). Measurements were made at the lowest and highest frequency of the transmit band.

Frequency removed from channel center by	Minimum signal reduction
0 to 50%	In Channel
50 to 100%	-25dBc
100 to 250%	-35dBc
More than 250%	-13dBm

Table 5 – Test Limit per section 25.202(f)

Test Setup:



Figure 3: Spurious Emission at Antenna Terminal Test setup

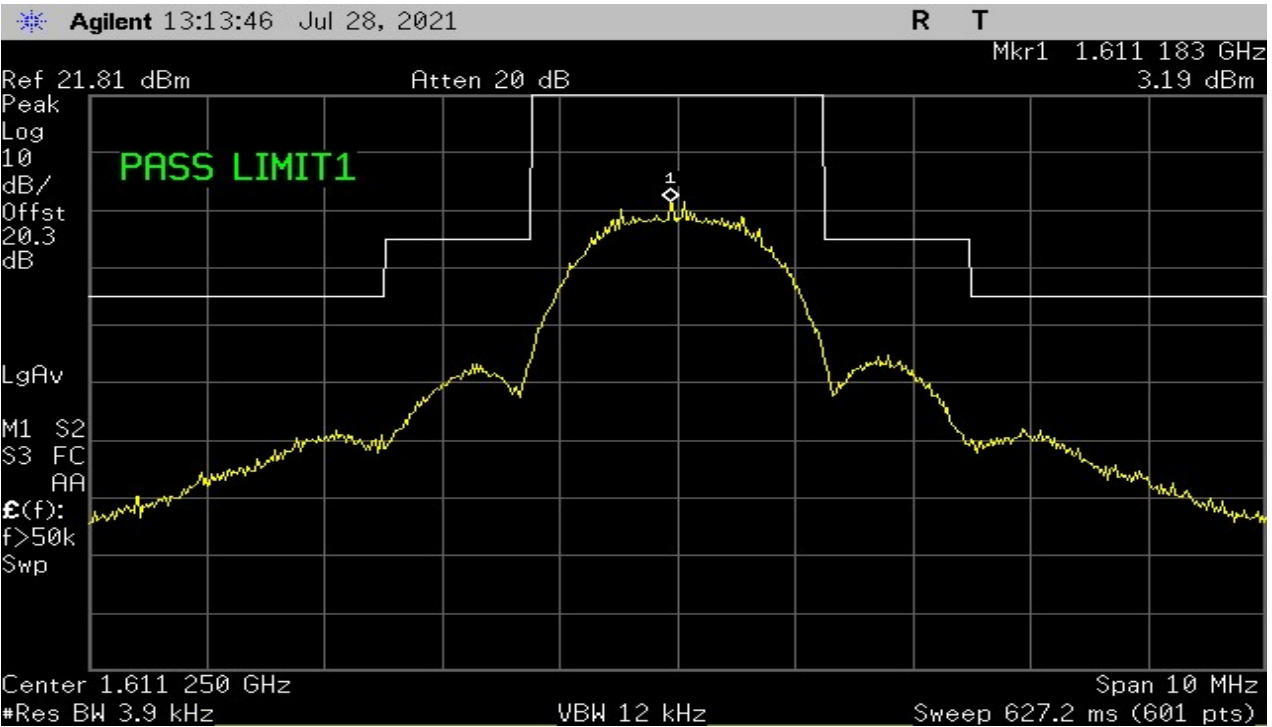

Plot 5 – Emission Mask – Low Channel

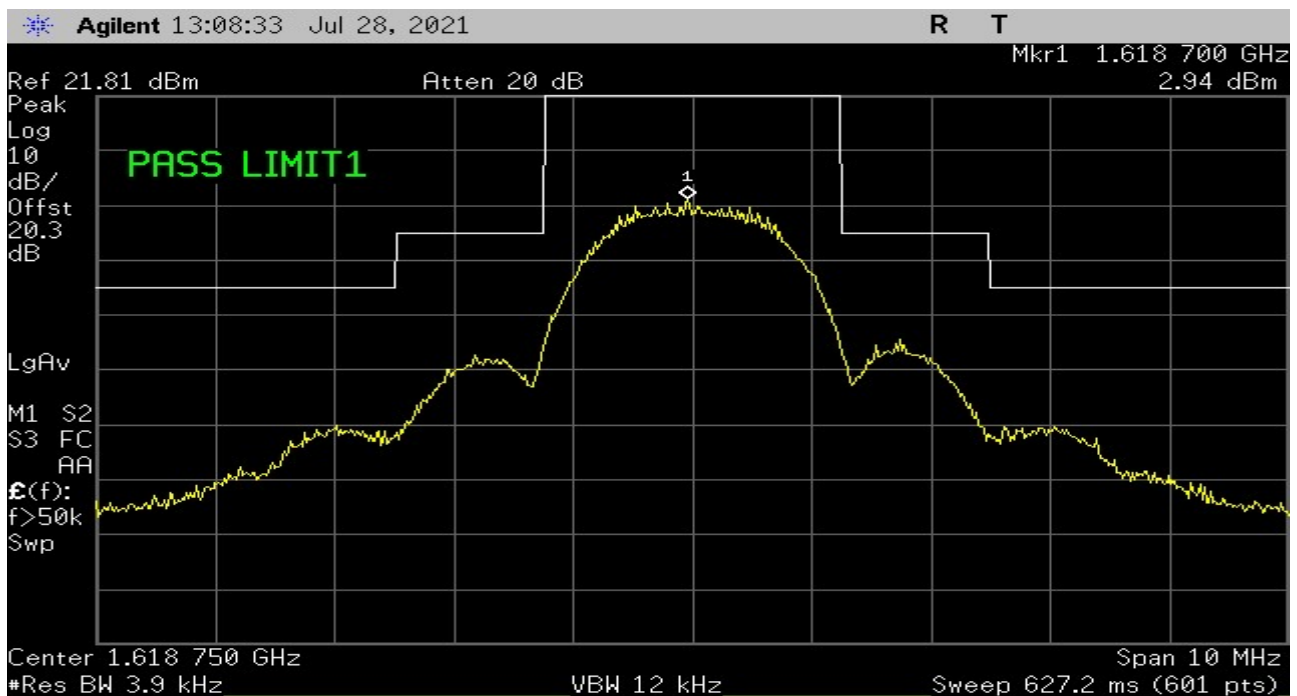

Plot 6 – Emission Mask - High Channel

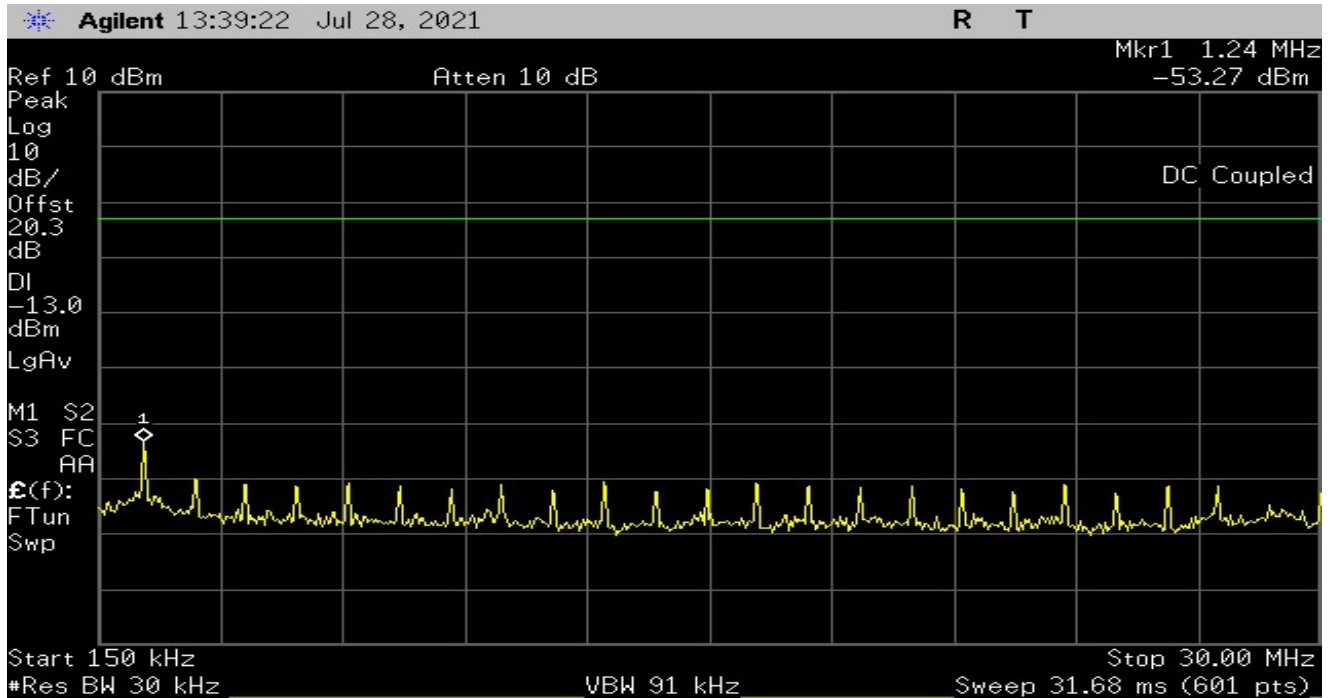

Plot 7 – Lowest Channel - 150kHz to 30MHz

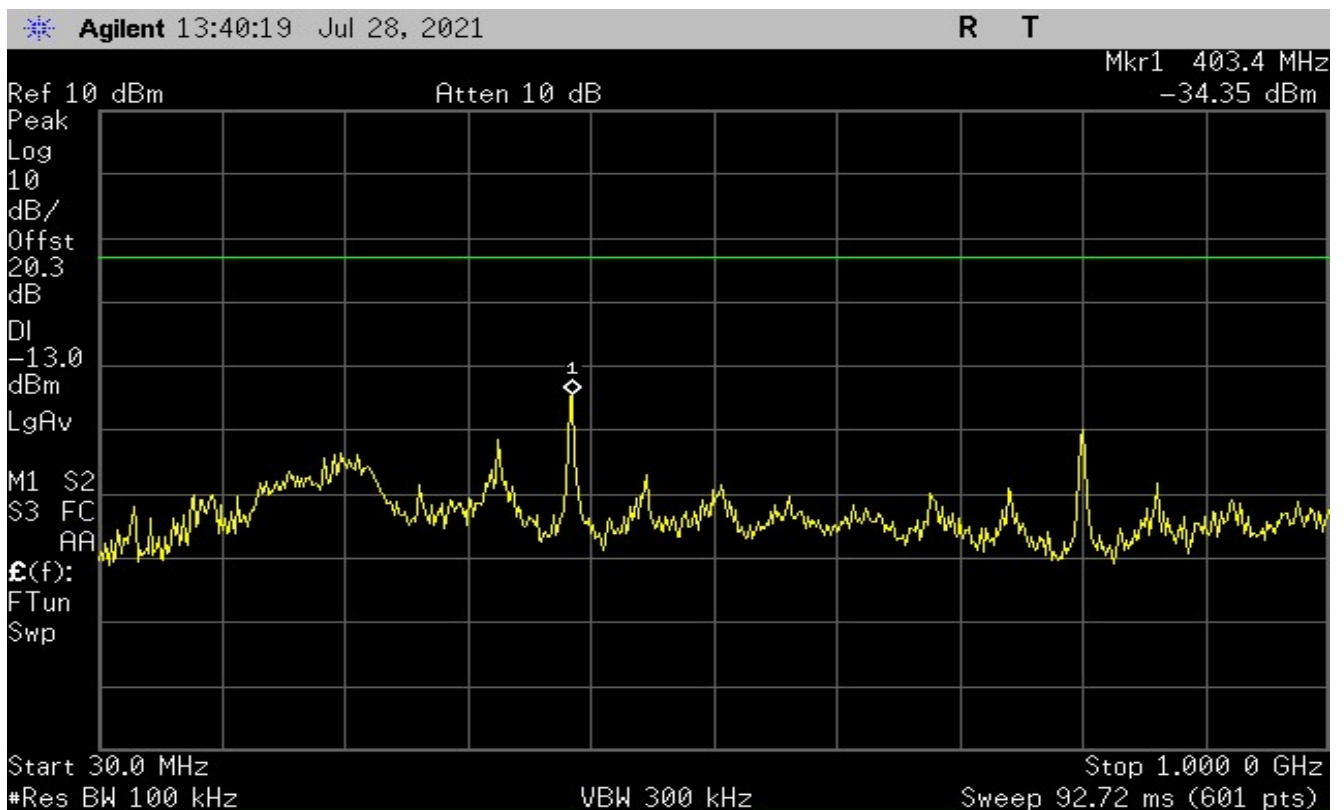

Plot 8 – Lowest Channel - 30MHz to 1GHz

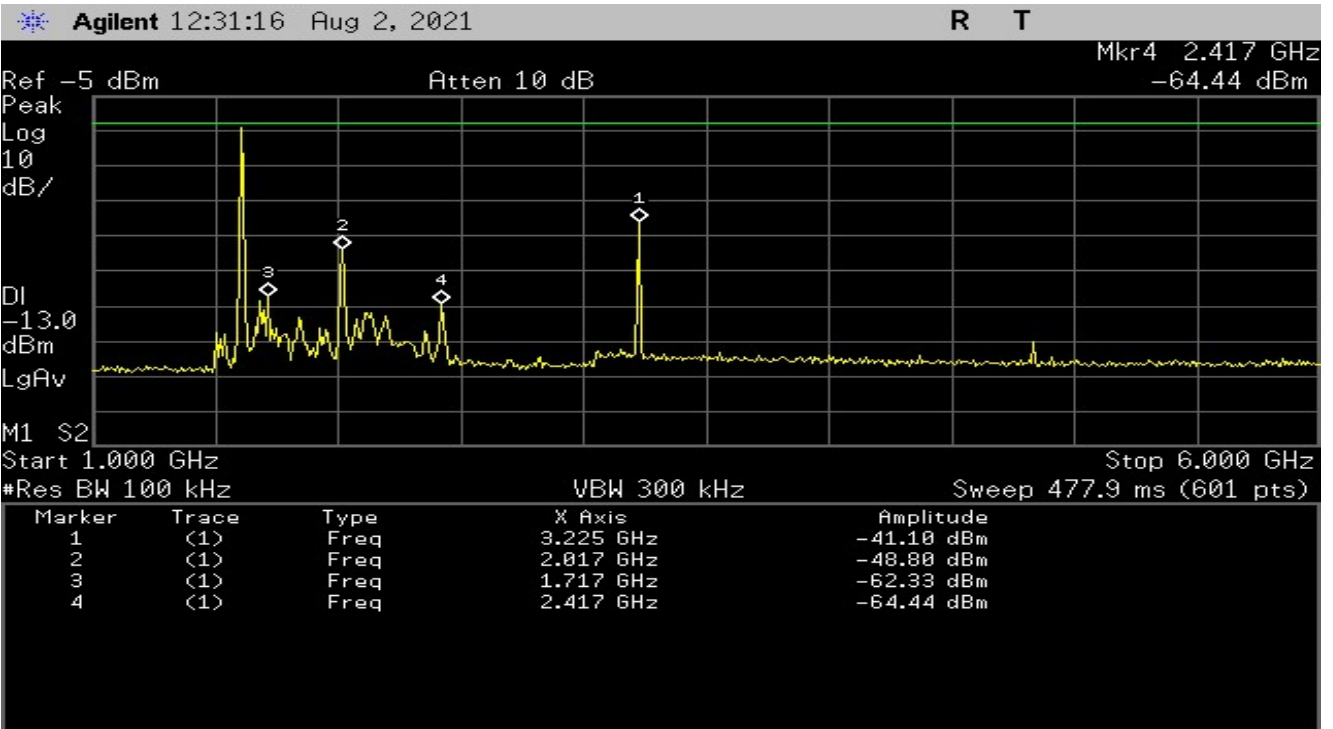

Plot 9 – Lowest Channel - 1GHz to 6GHz

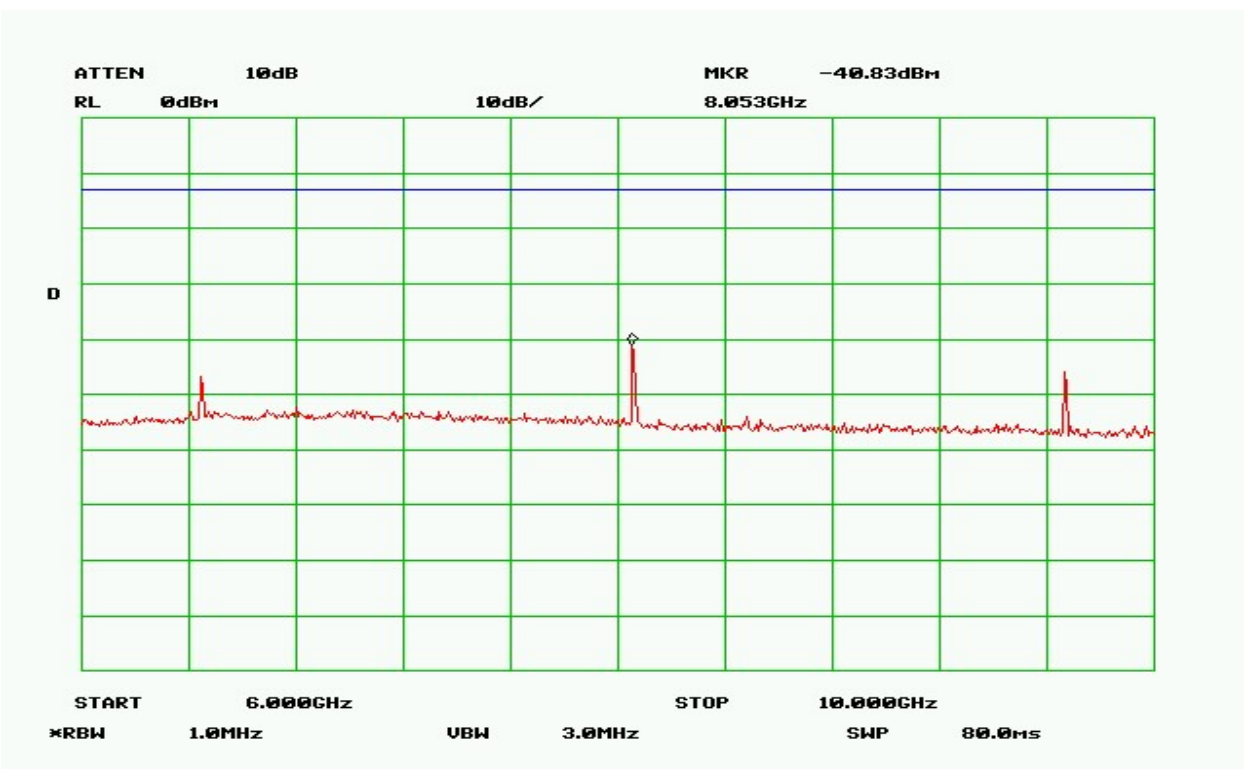

Plot 10 – Lowest Channel - 6GHz to 10 GHz

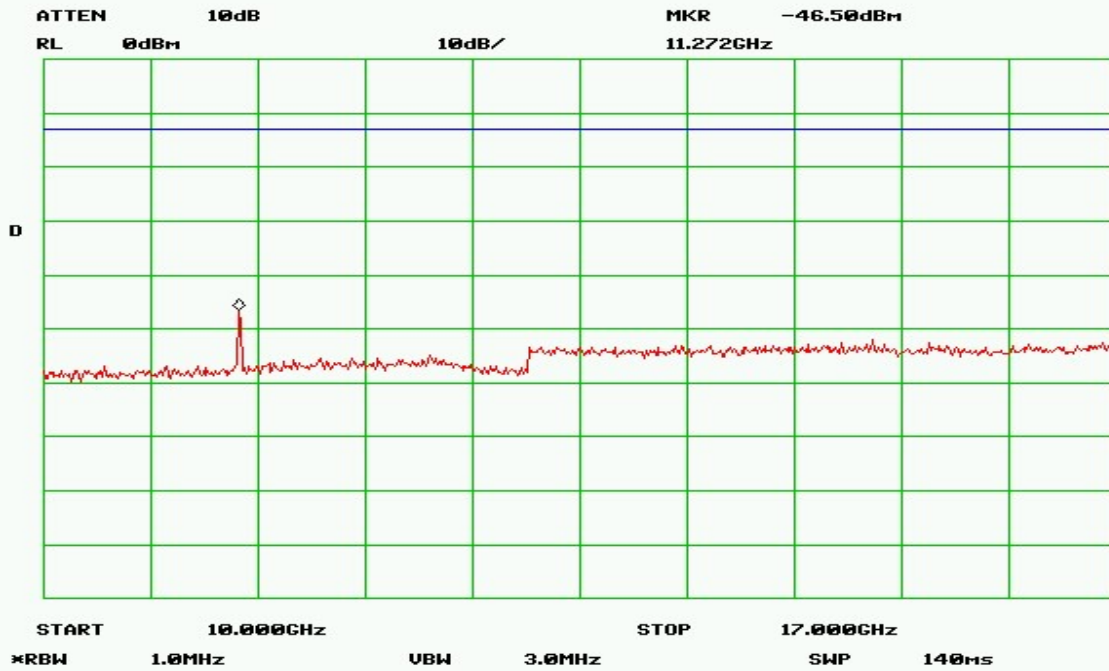

Plot 11 – Lowest Channel - 10GHz to 17GHz

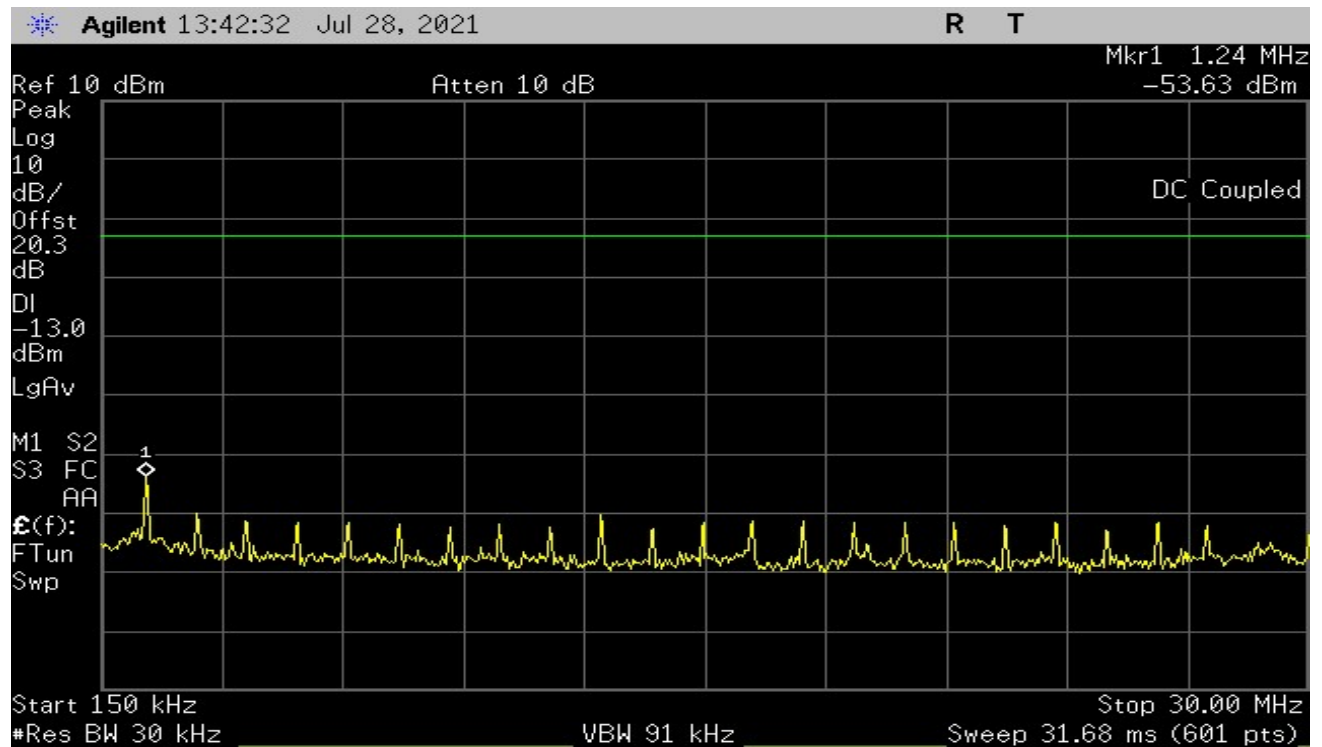

Plot 12 – Highest Channel – 150kHz to 30MHz

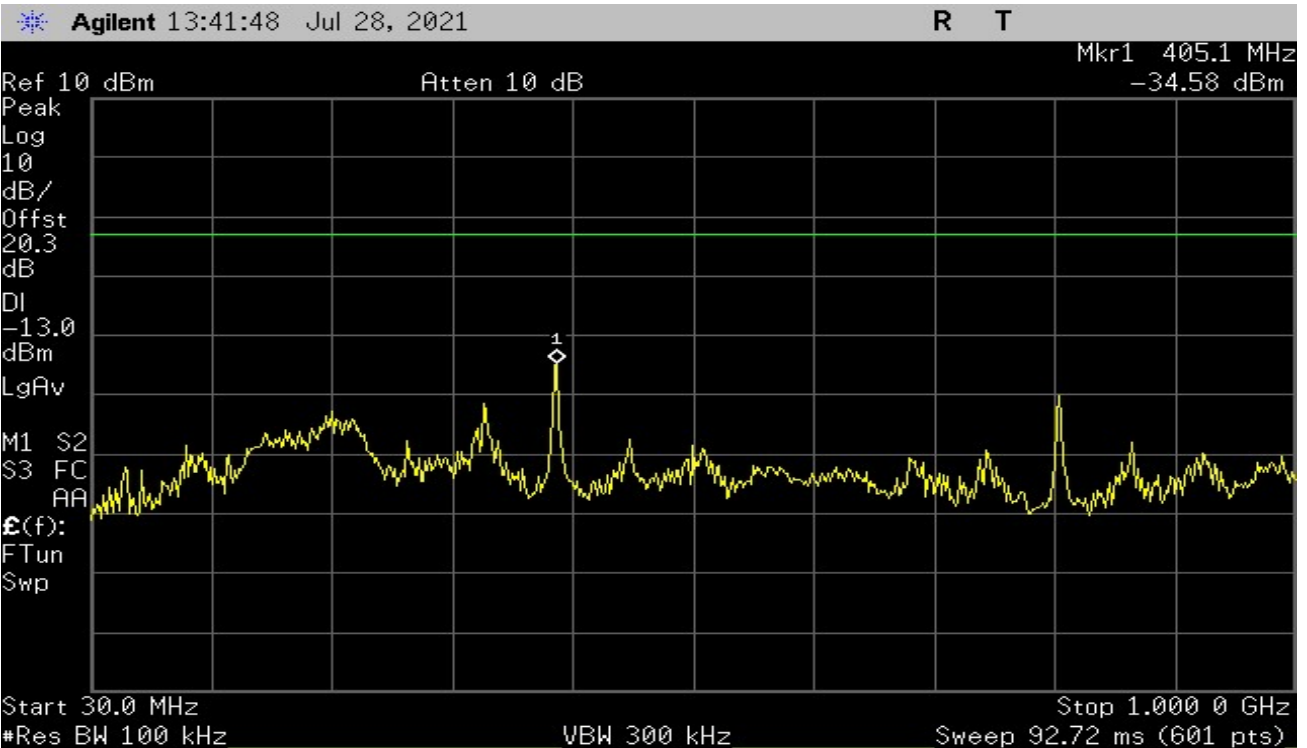

Plot 13 Highest Channel – 30MHz to 1GHz

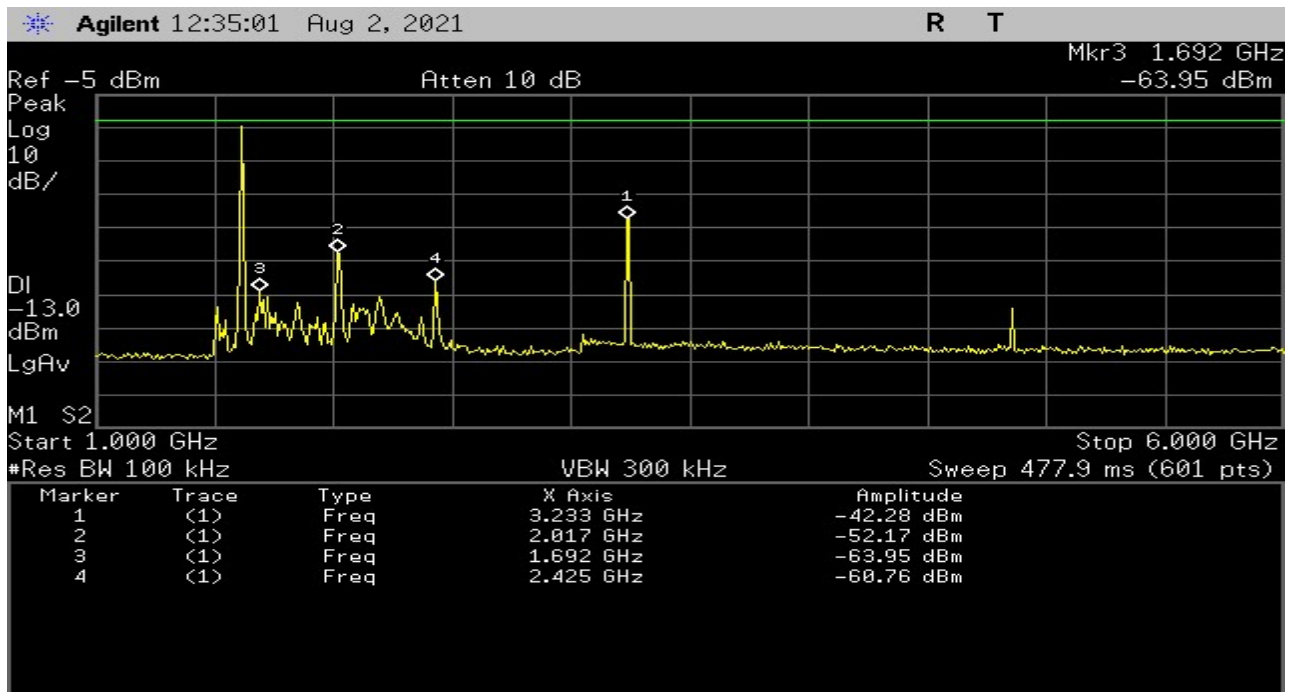

Plot 14 Highest Channel - 1GHz to 6GHz

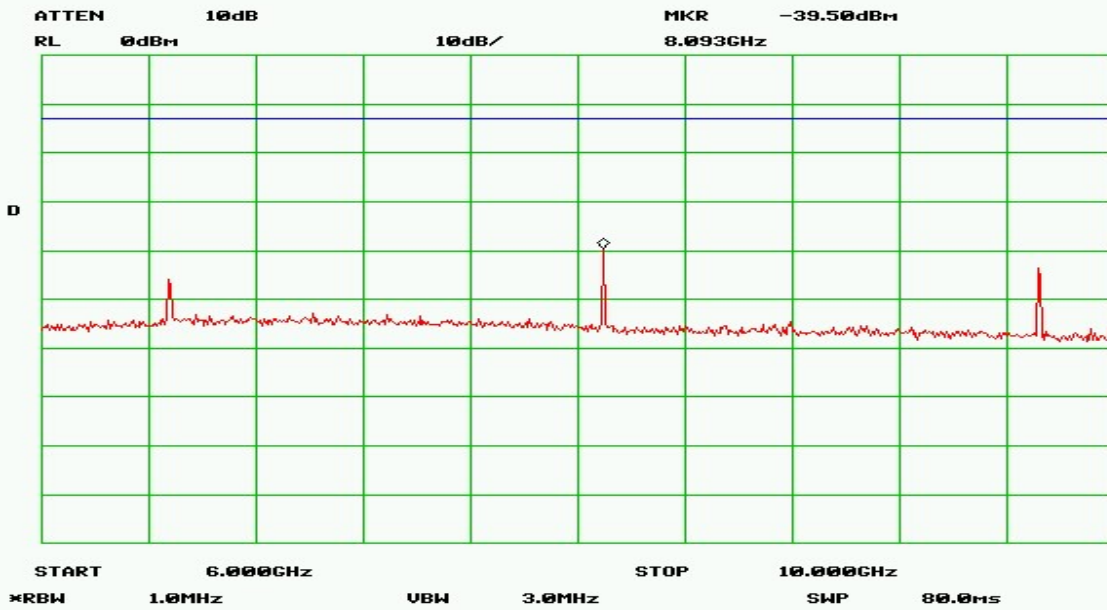

Plot 15 Highest Channel - 6GHz to 10GHz

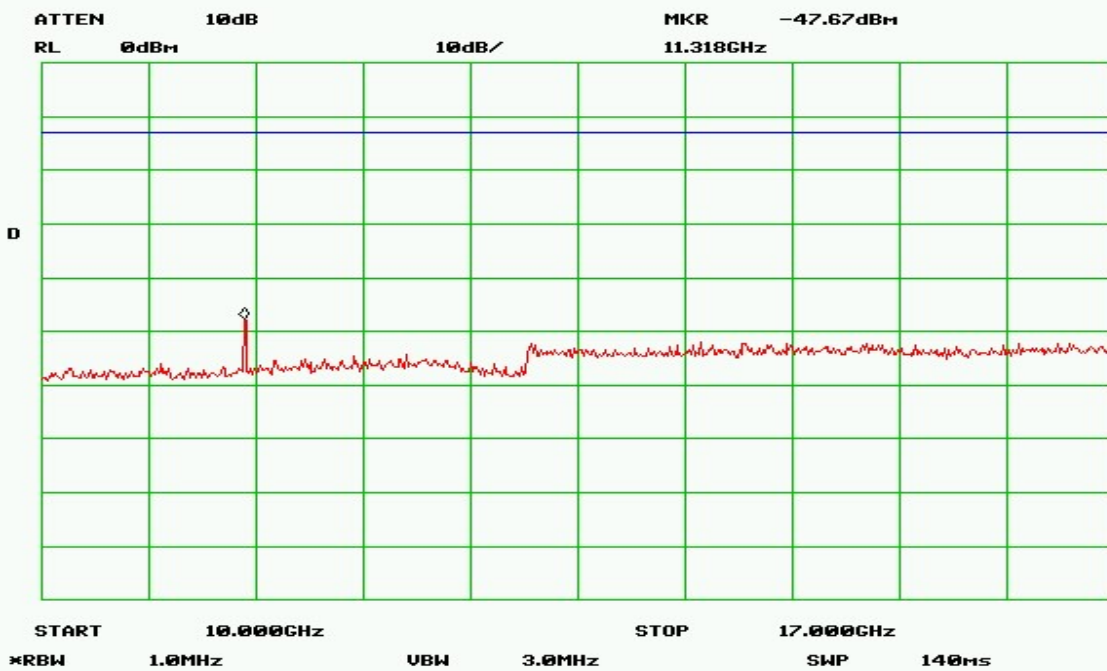

Plot 16 Highest Channel - 10GHz to 17GHz

4. Radiated Spurious Emissions

Test Requirement(s):	§2.1053, §25.202(f)	Test Engineer(s):	Sean E.
Test Results:	Pass	Test Date(s):	07/28/2020

Test Procedures: As required by 47 CFR 2.1053, field strength of radiated spurious measurements were made in accordance with the procedures of the ANSI C63.26-2015.

The EUT was placed on a non-reflective table inside a 3-meter open area test site. The EUT was set on continuous transmit.

The measurement antenna was placed at a distance of 3 meters from the EUT. During the tests, the antenna height and polarization as well as EUT azimuth were varied in order to identify the maximum level of emissions from the EUT. The test was performed by placing the EUT on 3 orthogonal axes. The frequency range up to the 10th harmonic was investigated.

To get a maximum emission level from the EUT, the EUT was rotated throughout the X-axis, Y-axis and Z-axis. Worst case is X-axis

Test Setup:

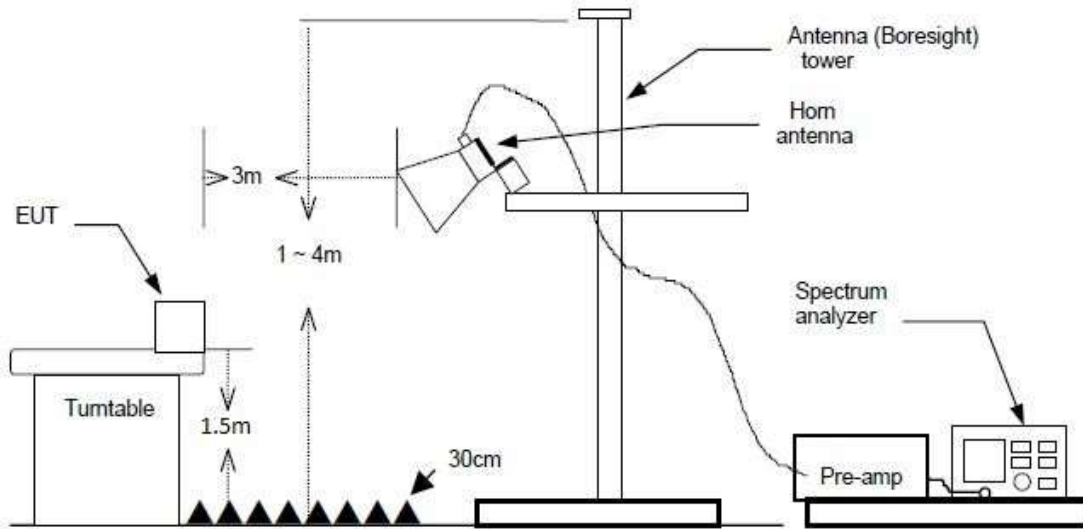

Figure 4 – Radiated Spurious Emissions

Test Results:

Frequency (MHz)	Measured Amplitude (dBuV/m)	Equivalent Radiated Power (dBm)	Antenna Polarity (V/H)	Spurious Limit (dBm)	Margin	Comment
1611.25	118.9	21.52	Horizontal	-	-	Fundamental
3222.5	42.26	-55.12	Horizontal	-13	-42.1	
4833.75	36.13	-61.25	Horizontal	-13	-48.3	
6445.0	26.26	-71.12	Horizontal	-13	-58.1	

Table 6 - Spurious Radiated Emission Data – Low Band

Frequency (MHz)	Measured Amplitude (dBuV/m)	Equivalent Radiated Power (dBm)	Antenna Polarity (V/H)	Spurious Limit (dBm)	Margin (dB)	Comment
1618.75	119.2	21.82	Horizontal	-	-	Fundamental
3237.5	43.09	-54.29	Horizontal	-13	-41.3	
4856.25	37.26	-60.12	Horizontal	-13	-47.1	
6475.0	34.26	-63.12	Horizontal	-13	-50.1	

Table 7– Spurious Radiated Emission Data – High Band

NOTE: There were no detectable emissions above the 4th harmonic. Measurement was made at the 10th harmonic.

5. Protection of Aeronautical Radio Navigation Satellite Service

Test Requirement(s):	§25.216	Test Engineer(s):	Sean E.
Test Results:	Pass	Test Date(s):	07/27/2021

Test Procedures: As required by 47 CFR §25.216(h), measurement were made at the RF output antenna terminal of the EUT.

Customer provided a test mode internal to the EUT to control the RF modulation, and frequency channel. The EUT was connected through an attenuator to a Spectrum analyzer to verify the EUT met the requirements as specified in in §25.202(f). Measurements were made at the lowest and highest frequency of the transmit band

§25.216 Section	Description	Result	Comments
§25.216 (c)	Limits for MES Protect Radionavigation-Satellite Service	Pass	See Plot # 17 -20
§25.216 (f) (g)	Limits for MES Protect Radionavigation-Satellite Service	Pass	See Plots 21 - 24
§25.216 (i)	Limits for MES e.i.r.p density of carrier-off	Pass	See Plots 25 & 26

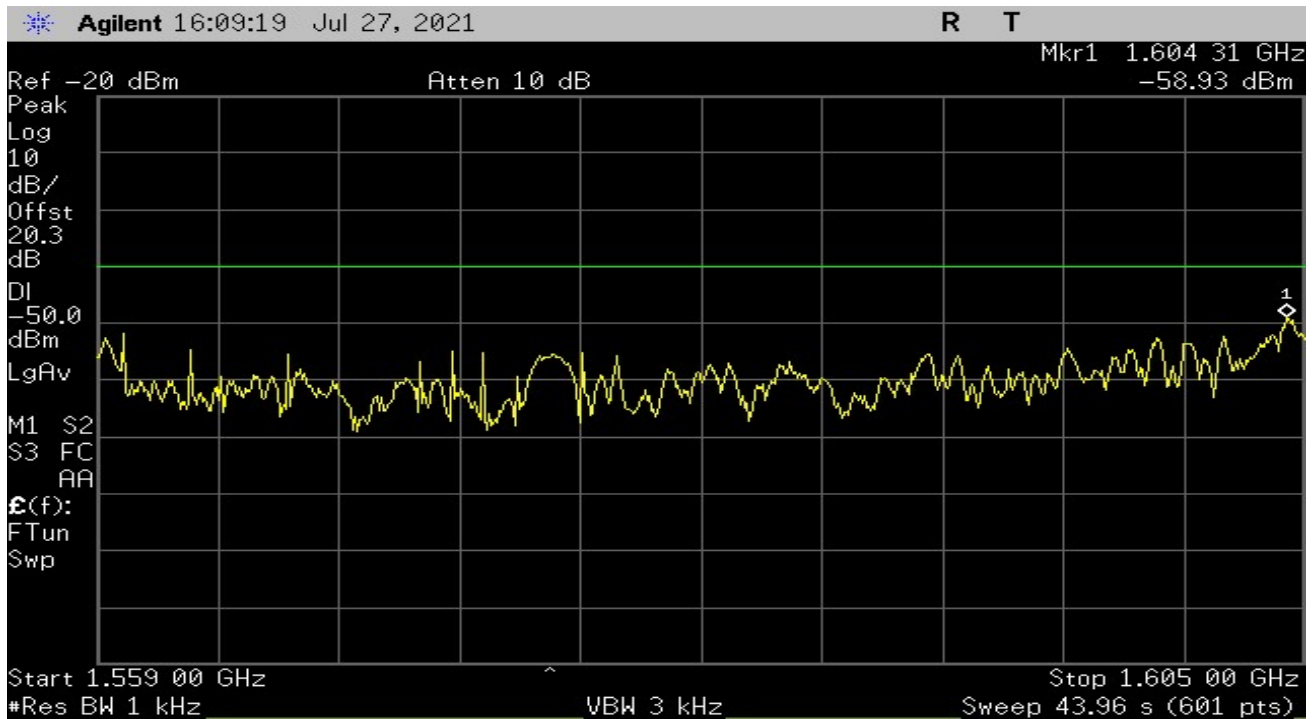

Plot 17 – Low Channel – Test Limit 25.216 (c) – Discrete Emissions

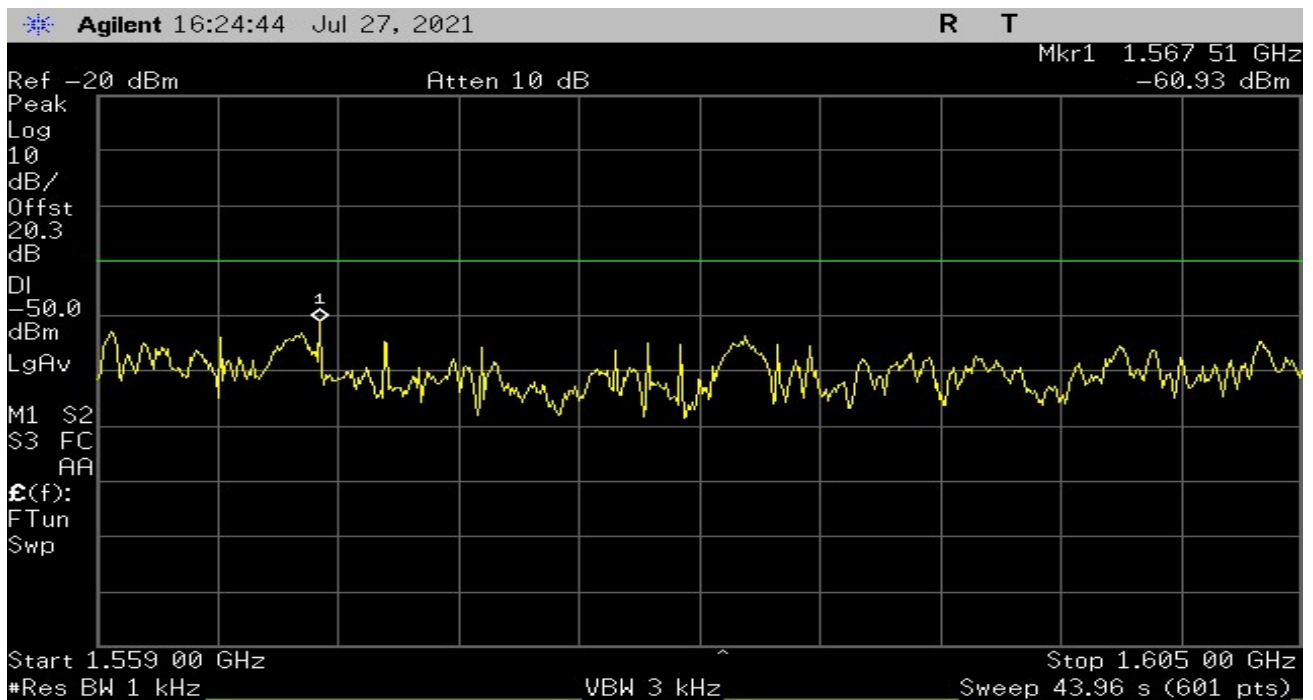

Plot 18 – High Channel – Test Limit 25.216 (c) – Discrete Emissions

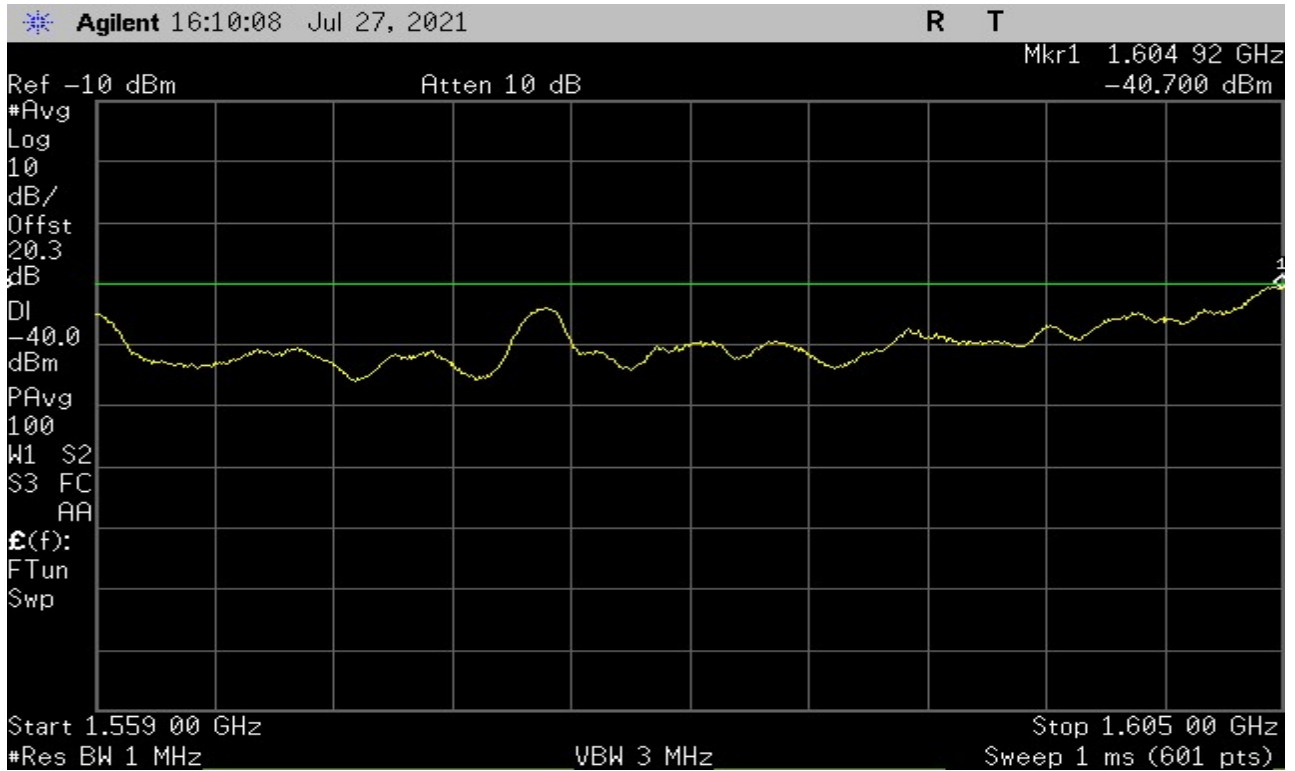

Plot 19 – Low Channel – Test Limit 25.216 (c)

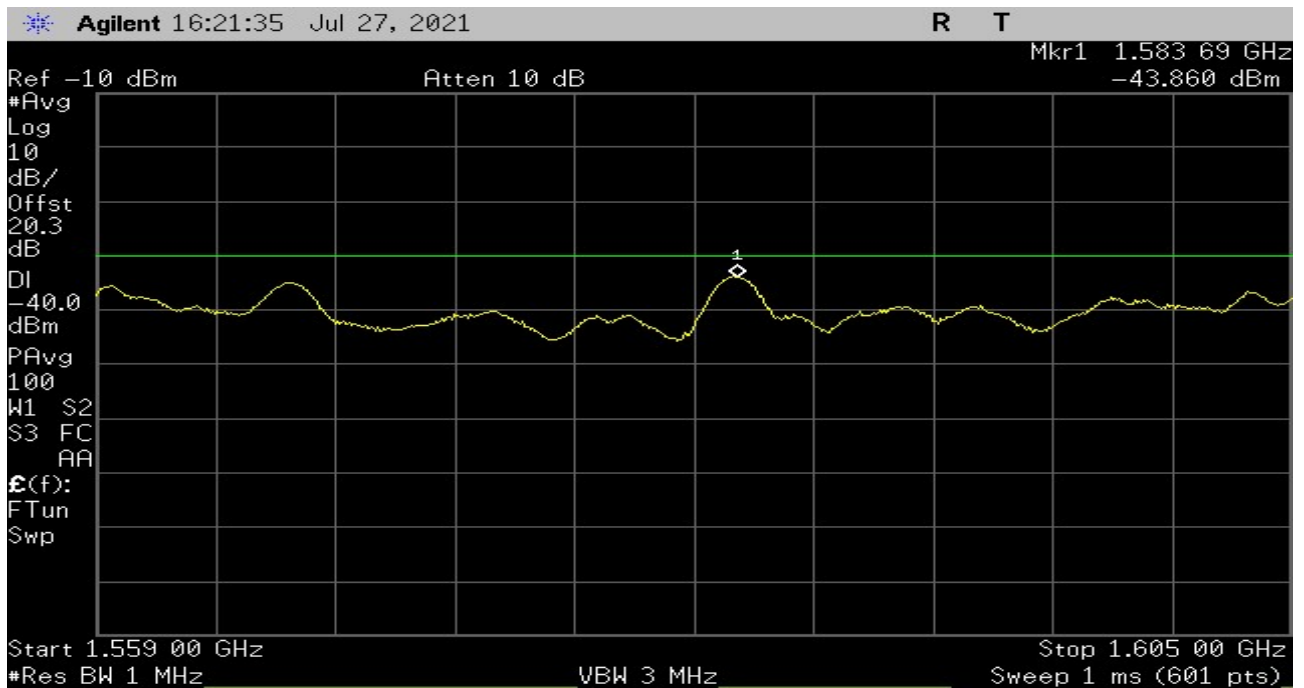

Plot 20 – High Channel – Test Limit 25.216 (c)



Plot 21- Low Channel – Test Limit 25.216 (f)(g) – Discrete Emissions



Plot 22-High Channel – Test Limit 25.216 (f)(g) – Discrete Emissions



Plot 23- Low Channel – Test Limit 25.216 (f)(g)

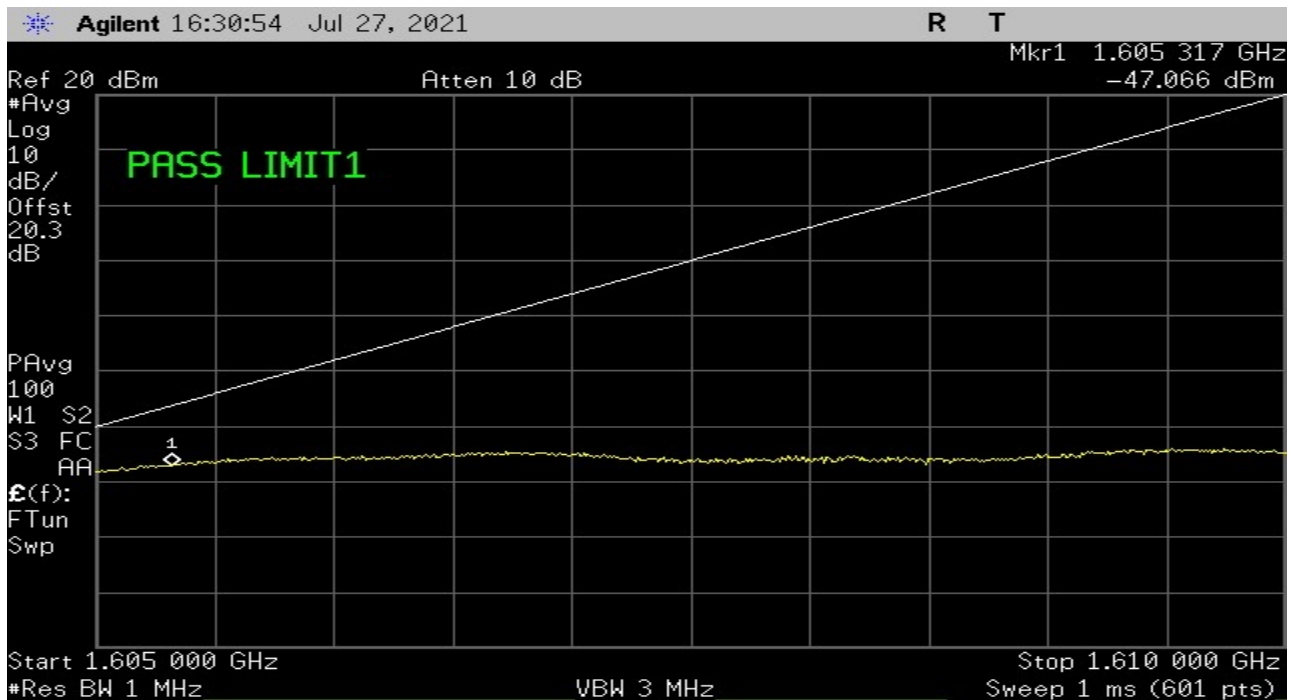

Plot 24-High Channel – Test Limit 25.216 (f)(g)

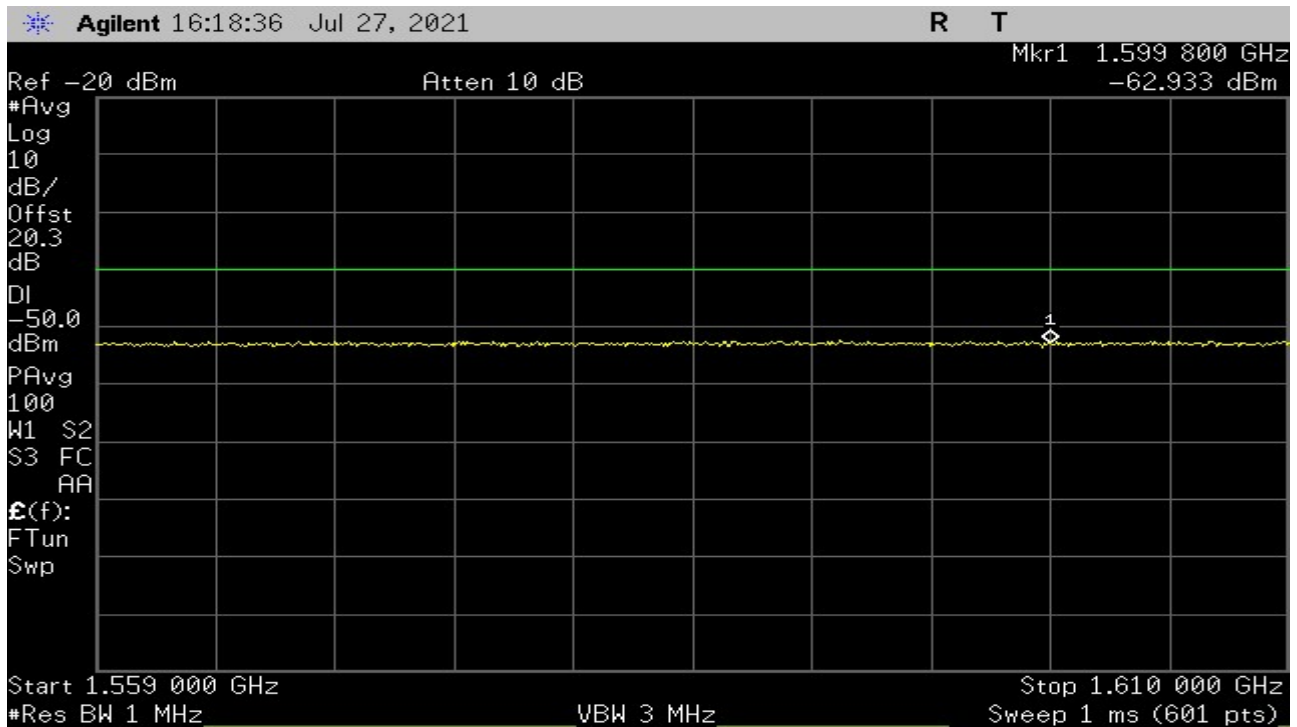

Plot 25- Low Channel - Carrier Off

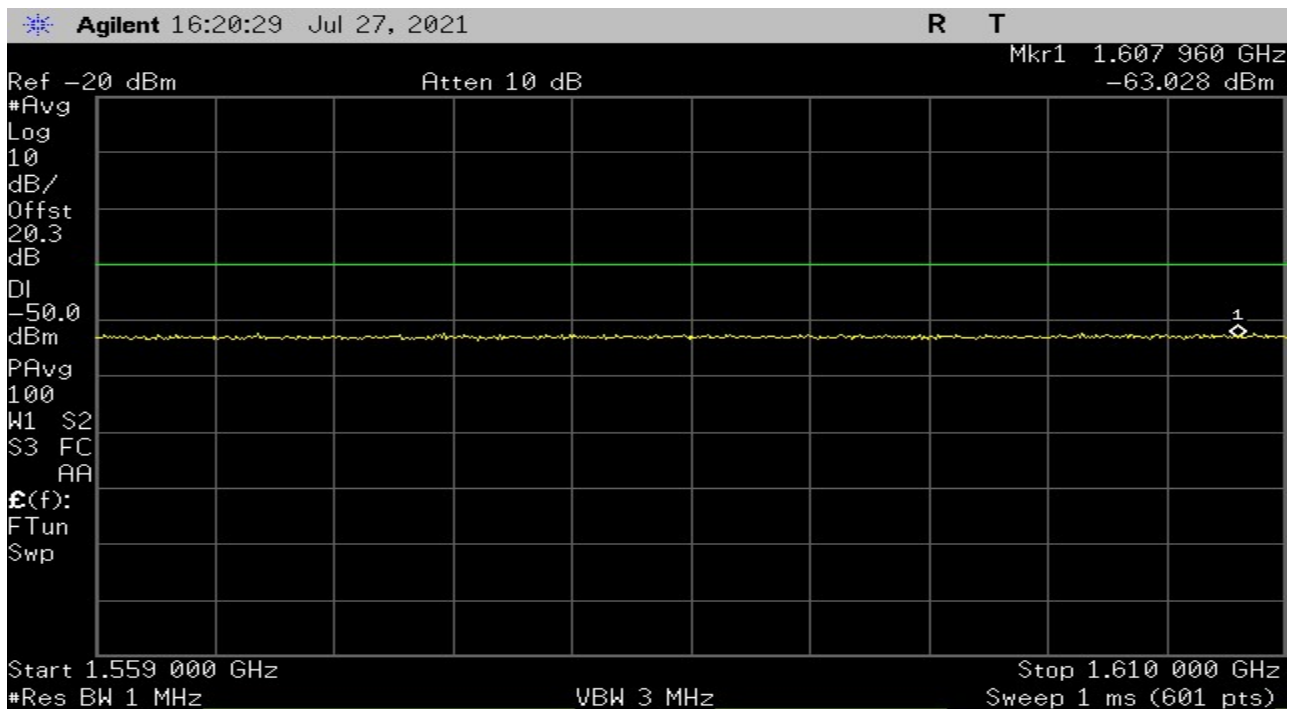

Plot 26 – High Channel – Carrier Off

6. Frequency Stability vs Temperature

Test Requirement(s):	§2.1055	Test Engineer(s):	Sean E.
Test Results:	Pass	Test Date(s):	07/29/2021

Test Procedures: As required by 47 CFR §2.0155, Frequency Stability measurements were made at the RF antenna output terminals of the EUT.

The EUT was placed in an Environmental Chamber with all the support equipment outside the chamber. The EUT was set to transmit a modulated carrier. The reference frequency at 20°C was observed and noted down. The frequency drift was investigated for every 10°C increment until the unit was stabilized then recorded the reading in tabular format with the temperature range of -30°C to 50°C.

Test Setup:

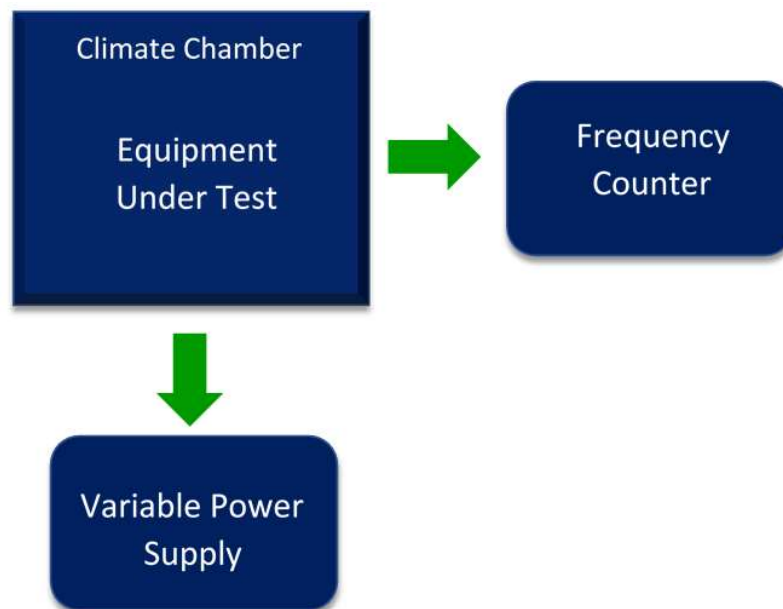
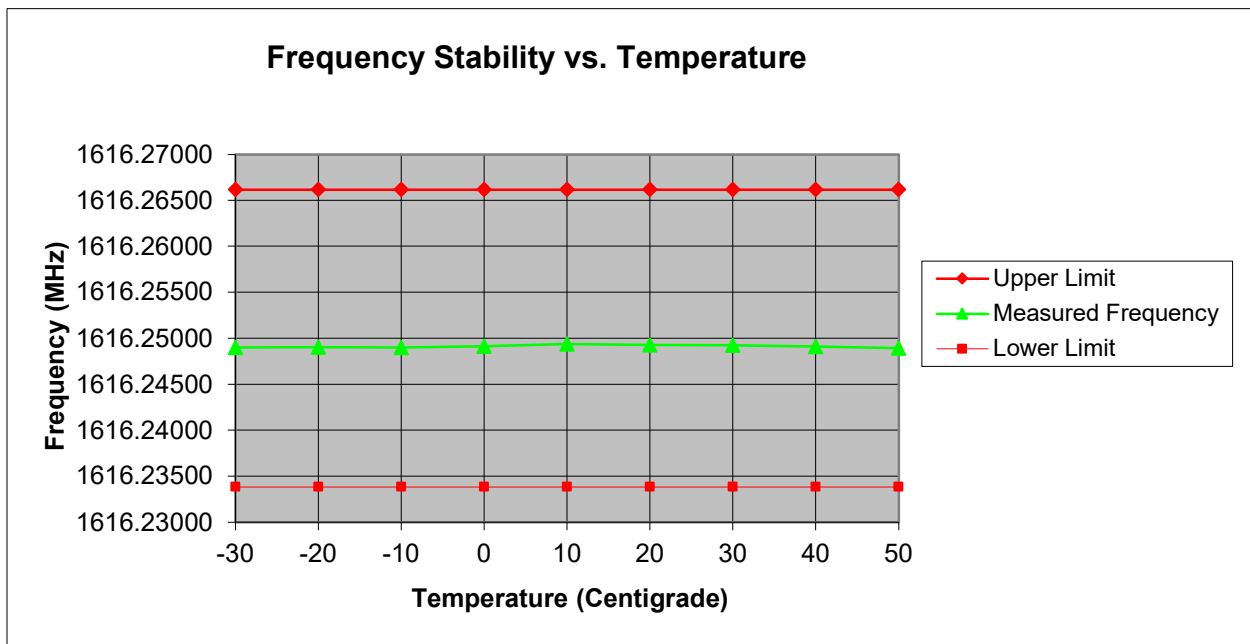

Figure 5 – Frequency Stability Test Setup

Test Results:

Temperature centigrade	Measured Frequency (MHz)	Upper Margin (MHz)	Lower Margin (MHz)
-30	1616.24900	-0.01717	0.01516
-20	1616.24901	-0.01716	0.01517
-10	1616.24898	-0.01719	0.01514
0	1616.24911	-0.01705	0.01527
10	1616.24938	-0.01678	0.01555
20	1616.24926	-0.01690	0.01542
30	1616.24922	-0.01694	0.01538
40	1616.24908	-0.01709	0.01524
50	1616.24893	-0.01723	0.01509

Table 8 – Temperature vs Frequency Test Result



Plot 27 – Temperature vs Frequency

7. Frequency Stability vs Voltage

Test Requirement(s):	§2.1055	Test Engineer(s):	Sean E.
Test Results:	Pass	Test Date(s):	07/29/2021

Test Procedures: As required by 47 CFR §2.0155, Frequency Stability measurements were made at the RF antenna output terminals of the EUT.

The EUT was connected to a variable DC source. The frequency was measured at both the nominal 6 Vdc of the EUT and at the extreme $\pm 15\%$ of nominal which is 85% level or 5.1Vdc and at the 115% level or 6.9Vdc

With the voltage set to a measurement point, the transmitted signal was captured by the spectrum analyzer and the frequency value determined. The frequencies are compared to the tuned frequency. All data for these measurements are found in the table 6.

Reference Frequency: 1616.25 at 6 VDC at 20°C

Test Setup:

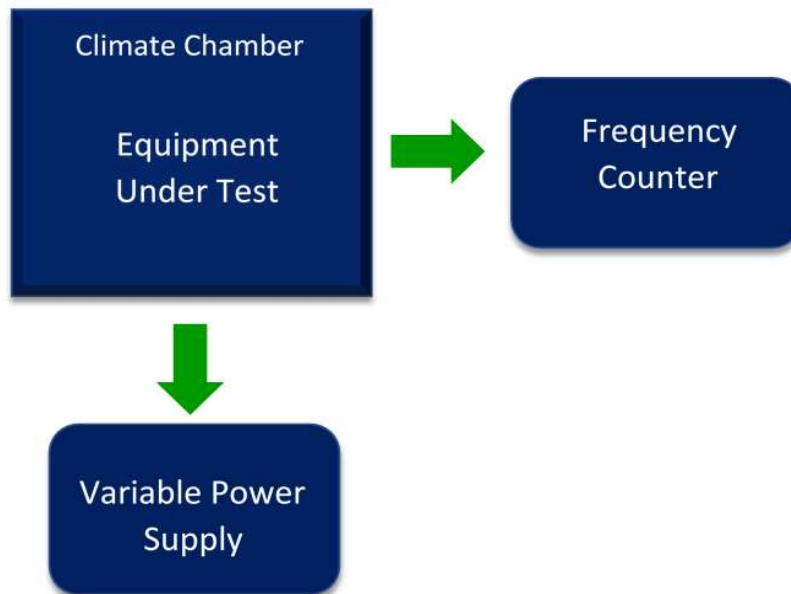
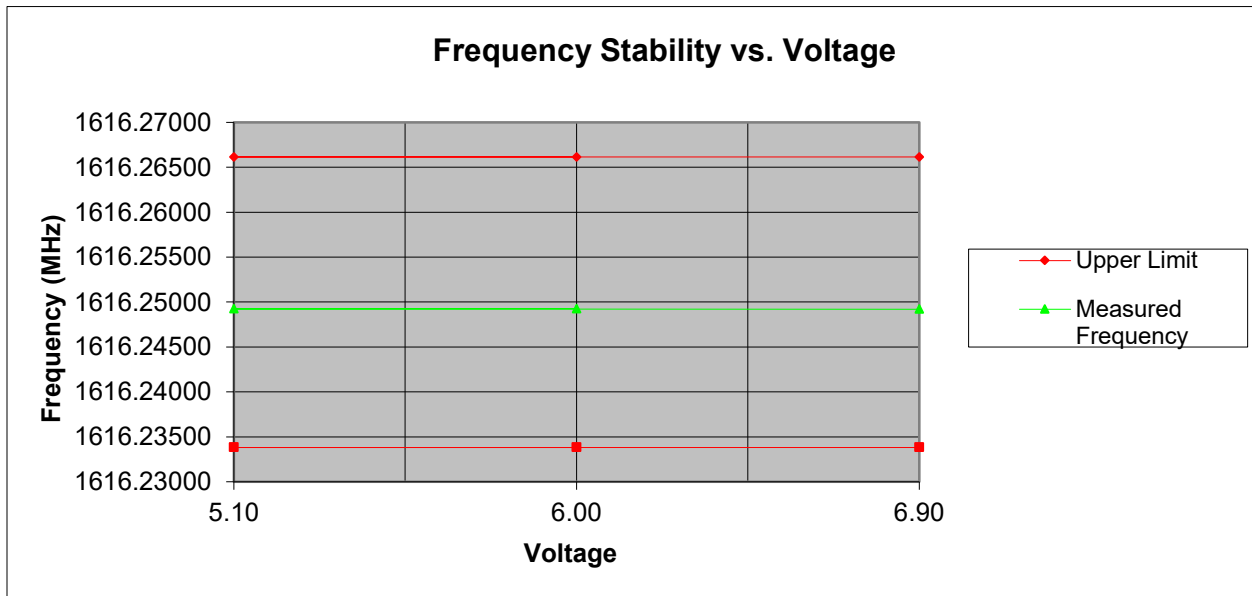

Figure 6 – Frequency Stability Test Setup

Test Results:

Input Voltage (Vdc)	Measured Frequency (MHz)	Upper Margin (MHz)	Lower Margin (MHz)
5.10	1616.24927	-0.01690	0.01543
6.00	1616.24926	-0.01690	0.01542
6.90	1616.24922	-0.01694	0.01539

Table 9. Temperature vs. Voltage Test Result



Plot 28 – Temperature vs Voltage

Test Equipment

Equipment	Manufacturer	Model	Serial #	Last Cal Date	Cal Due Date
Spectrum Analyzer	Agilent	E4443A	US41420164	Jan-28-21	Jan-28-22
Spectrum Analyzer	Hewlett Packard	8563E	3821A09316	Apr-28-21	Apr-28-22
Attenuator 20dB	Weinschel	41-20-12	86332	Apr-27-21	Apr-27-23
Horn Antenna	Com-Power	AHA-118	071150	Dec-17-20	Dec-17-22
Attenuator 10dB	Huber+Suhner	6810.17.A	747300	Apr-27-21	Apr-27-23
Digital Multimeter	Fluke	77 III	72550270	Apr-26-21	Apr-26-22
Power Supply	Hewlett Packard	Lambda	LA2-AA20-143 3535	NCR	None
Temperature Chamber	TestEquity	1027C	17953	Aug-26-21	Feb-26-22
Frequency Counter	Agilent	53181A	MY40004981	Apr-21-21	Apr-26-22

Table 10 – Test Equipment List

***Statement of Traceability:** Test equipment is maintained and calibrated on a regular basis. All calibrations have been performed by a 17025 accredited test facility, traceable to National Institute of Standards and Technology (NIST)

8. Measurement Uncertainty

ISO/IEC 17025 requires that an estimate of the measurement uncertainties associated with the emissions test results be included in the report. These measurements figures are calculated in accordance with ETSI TR 100 028 Parts 1 and 2. Instrumentation measurement uncertainty has **not** been taken into account to determine compliance.

The following measurement uncertainty values have been calculated as show in the table below:

Measured Parameter	Measurement Unit	Frequency Range	Expanded Uncertainty
Conducted Emissions (AC Power)	dBuV or dBuA	150kHz – 30MHz	± 4.3dB
Radiated Emissions below 1GHz	dBuV/m	30 – 1000MHz	± 5.6dB
Radiated Emissions above 1GHz	dBuV/m	1 – 26.5GHz	± 4.1dB

The reported expanded uncertainty has been estimated at a 95% confidence level (k=2)

END OF TEST REPORT