

**Amber Helm Development L.C.**

92723 Michigan Hwy-152

Sister Lakes, Michigan 49047 USA

Tel: 888-847-8027

# EMC Test Report

**F5TR-WR1919TX**

Issued: November 5, 2019

regarding

USA: CFR Title 47, Part 95 Subpart M (Emissions)  
Canada: ISED RSS-251 version 2 (Emissions)

for



## F5TR

Category: FMCW Radar

Judgments:

**FCC Part 95M and ISED RSS-251v2 Compliant**

Testing Completed: November 3, 2019



Prepared for:

### Aptiv Services US, LLC

One Corporate Center, Kokomo Indiana 46904-9005 USA

Phone: 765 451 5770, Fax: 765-451-0900

Contact: Brian Johnson, brian.w.johnson@delphi.com

Data Recorded by: Joseph Brunett  
Dr. Joseph Brunett, EMC-002790-NE

Reviewed by: Gordon L. Helm  
Gordon Helm, EMC-002401-NE

Prepared by: Joseph Brunett  
Dr. Joseph Brunett, EMC-002790-NE

Date of Issue: November 5, 2019

## Revision History

Rev. No.	Date	Details	Revised By
r0	November 5, 2019	Initial Release.	J. Brunett
r1	November 19, 2019	Remove duty cycle, minor typo corrections.	J. Brunett
r2	November 22, 2019	Include higher resolutions plots.	J. Brunett

## Contents

<b>Revision History</b>	<b>2</b>
<b>Table of Contents</b>	<b>2</b>
<b>1 Test Report Scope and Limitations</b>	<b>4</b>
1.1 Laboratory Authorization . . . . .	4
1.2 Report Retention . . . . .	4
1.3 Subcontracted Testing . . . . .	4
1.4 Test Data . . . . .	4
1.5 Limitation of Results . . . . .	4
1.6 Copyright . . . . .	4
1.7 Endorsements . . . . .	4
1.8 Test Location . . . . .	5
1.9 Traceability and Equipment Used . . . . .	5
<b>2 Test Specifications and Procedures</b>	<b>6</b>
2.1 Test Specification and General Procedures . . . . .	6
<b>3 Configuration and Identification of the Equipment Under Test</b>	<b>7</b>
3.1 Description and Declarations . . . . .	7
3.1.1 EUT Configuration . . . . .	8
3.1.2 Modes of Operation . . . . .	8
3.1.3 Variants . . . . .	8
3.1.4 Test Samples . . . . .	8
3.1.5 Functional Exerciser . . . . .	8
3.1.6 Modifications Made . . . . .	8
3.1.7 Production Intent . . . . .	8
3.1.8 Declared Exemptions and Additional Product Notes . . . . .	8
<b>4 Emissions</b>	<b>9</b>
4.1 General Test Procedures . . . . .	9
4.1.1 Radiated Test Setup and Procedures . . . . .	9
4.1.2 Conducted Emissions Test Setup and Procedures . . . . .	11
4.1.3 Power Supply Variation . . . . .	11
4.2 Intentional Emissions . . . . .	12
4.2.1 Fundamental Emission Pulsed Operation . . . . .	12
4.2.2 Fundamental Emission Bandwidth . . . . .	17
4.2.3 Fundamental Emission . . . . .	21
4.3 Unintentional Emissions . . . . .	22
4.3.1 Transmit Chain Spurious Emissions . . . . .	22
<b>5 Measurement Uncertainty and Accreditation Documents</b>	<b>24</b>

## List of Tables

1	Test Site List. . . . .	5
2	Equipment List. . . . .	5
3	EUT Declarations. . . . .	7
4	Pulsed Emission Characteristics (Duty Cycle). . . . .	12
5	Intentional Emission Bandwidth. . . . .	17
6	Fundamental Radiated Emissions. . . . .	21
7	Transmit Chain Spurious Emissions. . . . .	22
7	Transmit Chain Spurious Emissions. . . . .	23
7	Transmit Chain Spurious Emissions. . . . .	23
8	Measurement Uncertainty. . . . .	24

## List of Figures

1	Photos of EUT. . . . .	7
2	EUT Test Configuration Diagram. . . . .	8
3	Radiated Emissions Diagram of the EUT. . . . .	9
4	Radiated Emissions Test Setup Photograph(s). . . . .	10
5	Pulsed Emission Characteristics (Duty Cycle). . . . .	13
5	Pulsed Emission Characteristics (Duty Cycle). . . . .	14
5	Pulsed Emission Characteristics (Duty Cycle). . . . .	15
5	Pulsed Emission Characteristics (Duty Cycle). . . . .	16
6	Intentional Emission Bandwidth. . . . .	18
6	Intentional Emission Bandwidth. . . . .	19
6	Intentional Emission Bandwidth. . . . .	20
7	Accreditation Documents . . . . .	24

## **1 Test Report Scope and Limitations**

### **1.1 Laboratory Authorization**

Test Facility description and attenuation characteristics are on file with the FCC Laboratory, Columbia, Maryland (FCC Reg. No: US5348 and US5356) and with ISED Canada, Ottawa, ON (File Ref. No: 3161A and 24249). Amber Helm Development L.C. holds accreditation under NVLAP Lab Code 200129-0.

### **1.2 Report Retention**

For equipment verified to comply with the regulations herein, the manufacturer is obliged to retain this report with the product records for the life of the product, and no less than ten years. A copy of this Report will remain on file with this laboratory until December 2029.

### **1.3 Subcontracted Testing**

This report does not contain data produced under subcontract.

### **1.4 Test Data**

This test report contains data included within the laboratories scope of accreditation.

### **1.5 Limitation of Results**

The test results contained in this report relate only to the item(s) tested. Any electrical or mechanical modification made to the test item subsequent to the test date shall invalidate the data presented in this report. Any electrical or mechanical modification made to the test item subsequent to this test date shall require reevaluation.

### **1.6 Copyright**

This report shall not be reproduced, except in full, without the written approval of Amber Helm Development L.C.

### **1.7 Endorsements**

This report shall not be used to claim product endorsement by any accrediting, regulatory, or governmental agency.

## 1.8 Test Location

The EUT was fully tested by **Amber Helm Development L.C.**, headquartered at 92723 Michigan Hwy-152, Sister Lakes, Michigan 49047 USA. Table 1 lists all sites employed herein. Specific test sites utilized are also listed in the test results sections of this report where needed.

Table 1: Test Site List.

Description	Location	Quality Num.
OATS (3 meter)	3615 E Grand River Rd., Williamston, Michigan 48895	OATSC

## 1.9 Traceability and Equipment Used

Pertinent test equipment used for measurements at this facility is listed in Table 2. The quality system employed at Amber Helm Development L.C. has been established to ensure all equipment has a clearly identifiable classification, calibration expiry date, and that all calibrations are traceable to the SI through NIST, other recognized national laboratories, accepted fundamental or natural physical constants, ratio type of calibration, or by comparison to consensus standards.

Table 2: Equipment List.

Description	Manufacturer/Model	SN	Quality Num.	Cal/Ver By / Date Due
Spectrum Analyzer	R & S / FSV30	101660	RSFSV30001	RS / Apr-2021
Harmonic Mixer	Hewlett Packard / 11970U	2332A01153	MIX40TO7001	Keysight / Mar-2022
Harmonic Mixer	VDI / SAX 108	A30316	MIX60TO9001	Keysight / On-Use
Harmonic Mixer	Hewlett Packard / 11970W	2521A00179	MIX70TO11001	Keysight / Mar-2022
Harmonic Mixer	Pacific mmWave / GMA	26	MIX110TO23001	PMP / On-Use
Biconical	EMCO / 93110B	9802-3039	BICEMCO01	Keysight / Aug-2020
Log Periodic Antenna	EMCO / 3146	9305-3614	LOGEMCO01	Keysight / Aug-2020
Quad Ridge Horn	Singer / A6100	C35200	HQR1TO18S01	Keysight / Aug-2020
K-Band Horn	JEF / NRL Std.	001	HRNK01	AHD / Jul-2020
Ka-Band Horn	JEF / NRL Std.	001	HRNKA001	AHD / Jul-2020
U-Band Horn	Cust. Micro. / HO19R	-	HRNU01	Cust.M. / On-Use
E-Band Horn	Flann M. / 26240-25-1030B	250901	HRNE01	Flann / On-Use
W-Band Horn	Cust. Micro. / HO10R	-	HRNW01	Cust.M. / On-Use
D/G-Band Horn	Cust. Micro. / HO5R	-	HRNG01	Cust.M. / On-Use

## 2 Test Specifications and Procedures

### 2.1 Test Specification and General Procedures

The goal of Aptiv Services US, LLC is to demonstrate that the Equipment Under Test (EUT) complies with the Rules and/or Directives below. Detailed in this report are the results of testing the Aptiv Services US, LLC F5TR for compliance to:

Country/Region	Rules or Directive	Referenced Section(s)
United States	Code of Federal Regulations	CFR Title 47, Part 95 Subpart M
Canada	ISED Canada	ISED RSS-251 version 2

It has been determined that the equipment under test is subject to the rules and directives above at the date of this testing. In conjunction with these rules and directives, the following specifications and procedures are followed herein to demonstrate compliance (in whole or in part) with these regulations.

ANSI C63.4:2014	"Methods of Measurement of Radio-Noise Emissions from Low-Voltage Electrical and Electronic Equipment in the Range of 9 kHz to 40 GHz"
ANSI C63.10:2013	"American National Standard of Procedures for Compliance Testing of Unlicensed Wireless Devices"
ANSI C63.26:2015	"American National Standard for Compliance Testing of Transmitters Used in Licensed Radio Services"
KDB 653005 D01 v01r01	"Equipment Authorization Guidance for 76-81 GHz Radar Devices "
TP0102RA	"AHD Internal Document TP0102 - Radiated Emissions Test Procedure"
TP0106RC	"AHD Internal Document TP0106 - Emissions Measurement Procedures (above 40 GHz)"
ISED Canada	"The Measurement of Occupied Bandwidth"

### 3 Configuration and Identification of the Equipment Under Test

#### 3.1 Description and Declarations

The EUT is an automotive radar. The EUT is approximately 6.5 x 6.5 x 1 cm in dimension, and is depicted in Figure 1. It is powered by 12.0 VDC vehicle power system. In use, this device is permanently affixed in a motor vehicle. Table 3 outlines provider declared EUT specifications.



Figure 1: Photos of EUT.

Table 3: EUT Declarations.

General Declarations	
<b>Equipment Type:</b>	FMCW Radar
<b>Country of Origin:</b>	Not Declared
<b>Nominal Supply:</b>	12.0 VDC
<b>Oper. Temp Range:</b>	-40°C to +85°C
<b>Frequency Range:</b>	76.042 to 76.980 GHz
<b>Antenna Dimension:</b>	6cm
<b>Antenna Type:</b>	integral patch arrays
<b>Antenna Gain:</b>	17 dBi (max)
<b>Number of Channels:</b>	3
<b>Channel Spacing:</b>	Not Declared
<b>Alignment Range:</b>	Not Declared
<b>Type of Modulation:</b>	FMCW
United States	
<b>FCC ID Number:</b>	L2CF5TR
<b>Classification:</b>	VRD
Canada	
<b>IC Number:</b>	3432A-F5TR
<b>Classification:</b>	Radar, Vehicular Device

### 3.1.1 EUT Configuration

The EUT is configured for testing as depicted in Figure 2.

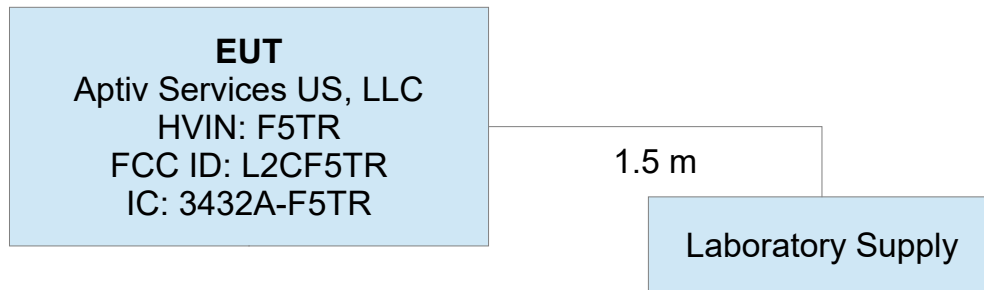

Figure 2: EUT Test Configuration Diagram.

### 3.1.2 Modes of Operation

The manufacturer considers the modes of operation of this product to be of a proprietary nature. Please reference confidential Modes of Operation exhibit for complete details.

### 3.1.3 Variants

There is only a single variant of the EUT, as tested.

### 3.1.4 Test Samples

Three samples were provided, each capable of continuous normal mode transmissions and CW modes at low, middle, and high operating channels.

### 3.1.5 Functional Exerciser

Normal operating EUT functionality was verified prior to testing by observation of the emissions spectrum.

### 3.1.6 Modifications Made

There were no modifications made to the EUT by this laboratory.

### 3.1.7 Production Intent

The EUT appears to be a production ready sample.

### 3.1.8 Declared Exemptions and Additional Product Notes

The EUT is permanently installed in a transportation vehicle. As such, digital emissions are exempt from US and Canadian digital emissions regulations (per FCC 15.103(a) and IC correspondence on ICES-003). In the mm-wave band, narrow pulses arise as the FMCW signal chirps past the receiver tuned frequency. To avoid amplitude measurement error due to Pulse Desensitization, we measure peak emissions only when the radar is either placed into CW mode or when the signal Dwells at a single frequency for an extended period of time. In computation of duty cycle for the FMCW chirp modulation, pulse desensitization can cause the measurement receiver with a narrow IFBW to report wider than actual pulse widths, and thus greater on-time and lower duty cycle based on the calculation method. Duty cycle in the FMCW mode is a worst-case computation, applied to a properly measured peak emission.



## 4 Emissions

### 4.1 General Test Procedures

#### 4.1.1 Radiated Test Setup and Procedures

Radiated electromagnetic emissions from the EUT are first pre-scanned in our screen room. Spectrum and modulation characteristics of all emissions are recorded. Instrumentation, including spectrum analyzers and other test equipment as detailed in Section 1.8 are employed. After pre-scan, emission measurements are made on the test site of record. If the EUT connects to auxiliary equipment and is table or floor standing, the configurations prescribed in relevant test standards are followed. Alternatively, a layout closest to normal use (as declared by the provider) is employed if the resulting emissions appear to be worst-case in such a configuration. See Figure 3. All intentionally radiating elements that are not fixed-mounted in use are placed on the test table lying flat, on their side, and on their end (3-axes) and the resulting worst case emissions are recorded. If the EUT is fixed-mounted in use, measurements are made with the device oriented in the manner consistent with installation and then emissions are recorded. If the EUT exhibits spurious emissions due to internal receiver circuitry, such emissions are measured with an appropriate carrier signal applied.

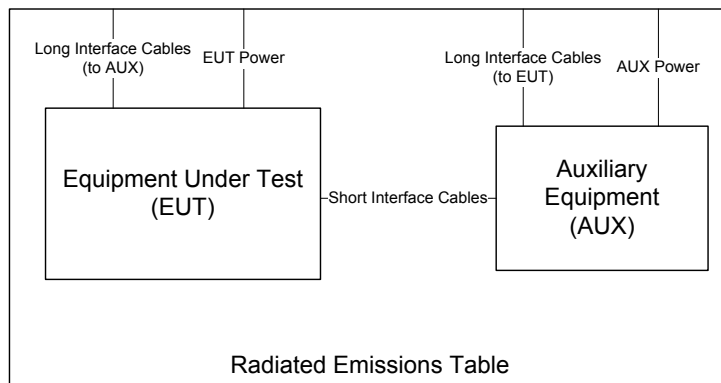

Figure 3: Radiated Emissions Diagram of the EUT.

For devices with intentional emissions below 30 MHz, a shielded loop antenna and/or E-field and H-Field broadband probes are used depending on the regulations. Shielded loops are placed at a 1 meter receive height at the desired measurement distance. For exposure in this band, the broadband probes employed are 10cm diameter single-axis shielded transducers and measurements are repeated and summed over three axes.

Emissions between 30 MHz and 1 GHz are measured using calibrated broadband antennas. For both horizontal and vertical polarizations, the test antenna is raised and lowered from 1 to 4 m in height until a maximum emission level is detected. The EUT is then rotated through  $360^\circ$  in azimuth until the highest emission is detected. The test antenna is then raised and lowered one last time from 1 to 4 m and the worst case value is recorded. Emissions above 1 GHz are characterized using standard gain or broadband ridge-horn antennas on our OATS with a  $4 \times 5$  m rectangle of ECCOSORB absorber covering the OATS ground screen and a 1.5m table height. Care is taken to ensure that test receiver resolution and video bandwidths meet the regulatory requirements, and that the emission bandwidth of the EUT is not reduced. Photographs of the test setup employed are depicted in Figure 4.

Where regulations allow for direct measurement of field strength, power values (dBm) measured on the test receiver / analyzer are converted to  $\text{dB}\mu\text{V}/\text{m}$  at the regulatory distance, using

$$E_{dist} = 107 + P_R + K_A - K_G + K_E - C_F$$

where  $P_R$  is the power recorded on spectrum analyzer, in dBm,  $K_A$  is the test antenna factor in dB/m,  $K_G$  is the combined pre-amplifier gain and cable loss in dB,  $K_E$  is duty correction factor (when applicable) in dB, and  $C_F$  is a distance conversion (employed only if limits are specified at alternate distance) in dB. This field strength value is then compared with the regulatory limit. If effective isotropic radiated power (EIRP) is computed, it is computed as

$$EIRP(\text{dBm}) = E_{3m}(\text{dB}\mu\text{V}/\text{m}) - 95.2.$$

When presenting data at each frequency, the highest measured emission under all possible EUT orientations (3-axes) is reported.

Where regulations call for substitution method measurements, the EUT is replaced by a substitution antenna if field strength measurements indicate the emission is close to the regulatory limit. This antenna is co-polarized with the test antenna and tuned (when necessary) to the emission frequency, after which the test antenna height is again optimized. The substitution antenna's signal level is adjusted such that its emission is equal to the level measured from the EUT. The signal level applied to the substitution antenna is then recorded. Effective isotropic radiated power (EIRP) and effective radiated power (ERP) in dBm are formulated from

$$EIRP = P_T - G_A = ERP + 2.16, \quad (1)$$

where  $P_T$  is the power applied to substitution antenna in dBm, including correction for cable loss, and  $G_A$  is the substitution antenna gain, in dBi.

When microwave measurements are made at a range different than the regulatory distance or made at close-range to improve receiver sensitivity, the reading is corrected back to the regulatory distance. This is done using a 20 dB/decade field behavior as dictated by the test procedures. When measurements are made in the near-field, the near-field/far-field boundary (N/F) is reported. It is computed as

$$N/F = 2D^2/\lambda$$

where  $D$  is the maximum dimension of the transmitter or receive antenna, and  $\lambda$  is the wavelength at the measurement frequency. Typically for high frequency measurements the receive antenna is connected to test receiver / analyzer through an external mixer. In this case, cable loss, IF amplifier gain, and mixer conversion losses are corrected for in the data table, or directly in the analyzer.



Figure 4: Radiated Emissions Test Setup Photograph(s).

#### **4.1.2 Conducted Emissions Test Setup and Procedures**

#### **4.1.3 Power Supply Variation**

Tests at extreme supply voltages are made if required by the procedures specified in the test standard, and results of this testing are detailed in this report.

## 4.2 Intentional Emissions

### 4.2.1 Fundamental Emission Pulsed Operation

The details and results of testing the EUT for pulsed operation are summarized in Table 4. Plots showing the measurements made to obtain these values are provided in Figure 5.

Table 4: Pulsed Emission Characteristics (Duty Cycle).

<b>Det</b> Pk	<b>IF Bandwidth</b> 28 MHz	<b>Video Bandwidth</b> 28 MHz	<b>Test Date:</b> 1-Nov-19
			<b>Test Engineer:</b> Joseph Brunett
			<b>EUT</b> Aptiv F5TR
			<b>Meas. Distance:</b> 1 m

Pulsed Operation / Duty Cycle											
Transmit Mode	Voltage (V)	Test Frequency <sup>(1)</sup> (GHz)	Total Cycle Time (ms)	FMCW On-Time (ms)	BPSK Ant Duty <sup>(2)</sup> (dB)	Exposure Duty Factor <sup>(3)</sup> (dB)	FMCW Period (ms)	CHIRP BW (MHz)	Dwell/MHz/Chirp <sup>(4)</sup> (ms)	Chirps / On-Time <sup>(5)</sup> (#)	Max On-Time/Cycle <sup>(6)</sup> (ms)
LR (FMCW)	12.0	76.500	50.2	14.40	-2.0	-7.4	0.028	175.0	0.00016	514	0.082
MR (FMCW)	12.0	76.500	50.2	14.30	-2.0	-7.5	0.028	425.0	0.00007	511	0.034
SR (FMCW)	12.0	76.500	50.1	14.30	-2.0	-7.4	0.033	600.0	0.00006	433	0.024

(1) Worst-case frequency selected at center of operating band.

(2) 2 x Tx arrays are BPSK driven, resulting in a 50% A1 Gain, 50% A2 Gain:  $10 \cdot \text{LOG}_{10}(0.5 \cdot 10^{(0/10)} + 0.5 \cdot 10^{(-6/10)}) = -2.0$ , see Modes Exhibit for Details.

(3) Exposure Duty Correction =  $10 \cdot \text{Log}(\text{Total On-Time} / \text{Total Cycle-Time}) + \text{BPSK Antenna Duty}$

(4) Dwell / MHz / Chirp is the CW time spent in any given 1MHz window within the channel during a single chirp = FMCW Period / CHIRP BW, CHIRP BW is taken as the smaller of declared and measured.

(5) Chirps / On-Time = FMCW On-Time / FMCW Period

(6) Max On-Time / Cycle = Chirps / On-Time x Dwell / MHz / Chirp

Equipment Used: RSFSV30001, MIX70TO10001, HRNW01

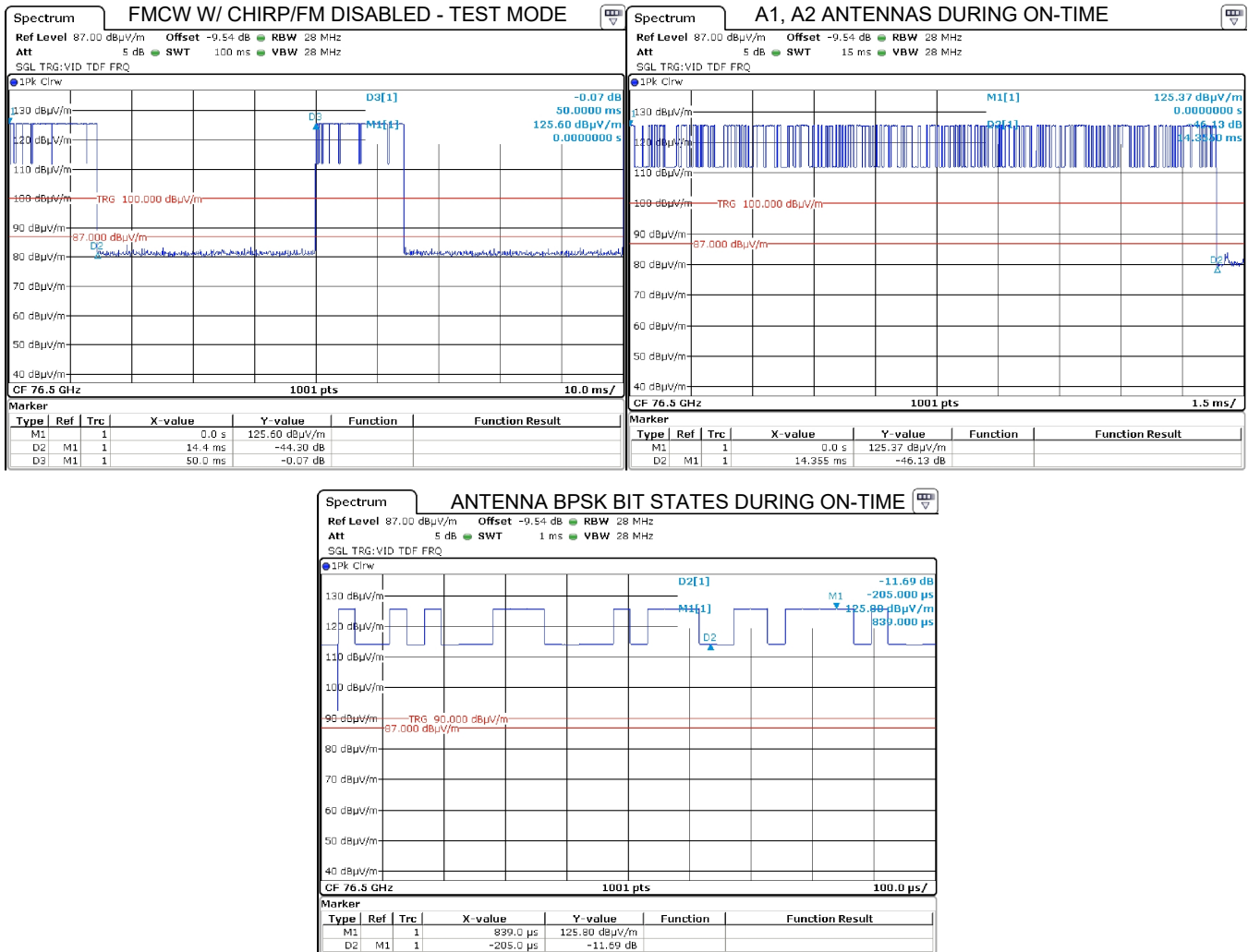

Figure 5(a): Pulsed Emission Characteristics (Duty Cycle).

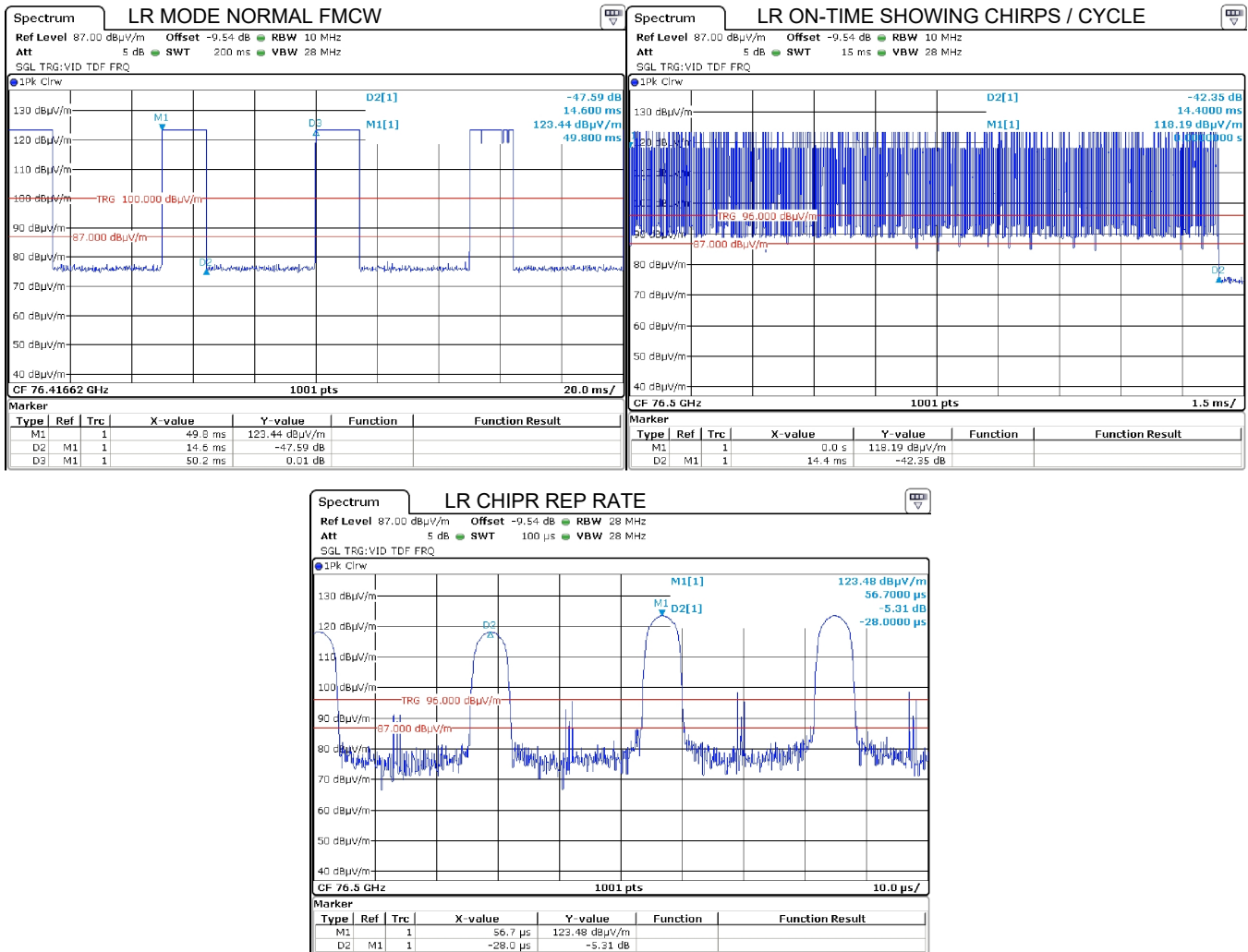

Figure 5(b): Pulsed Emission Characteristics (Duty Cycle).

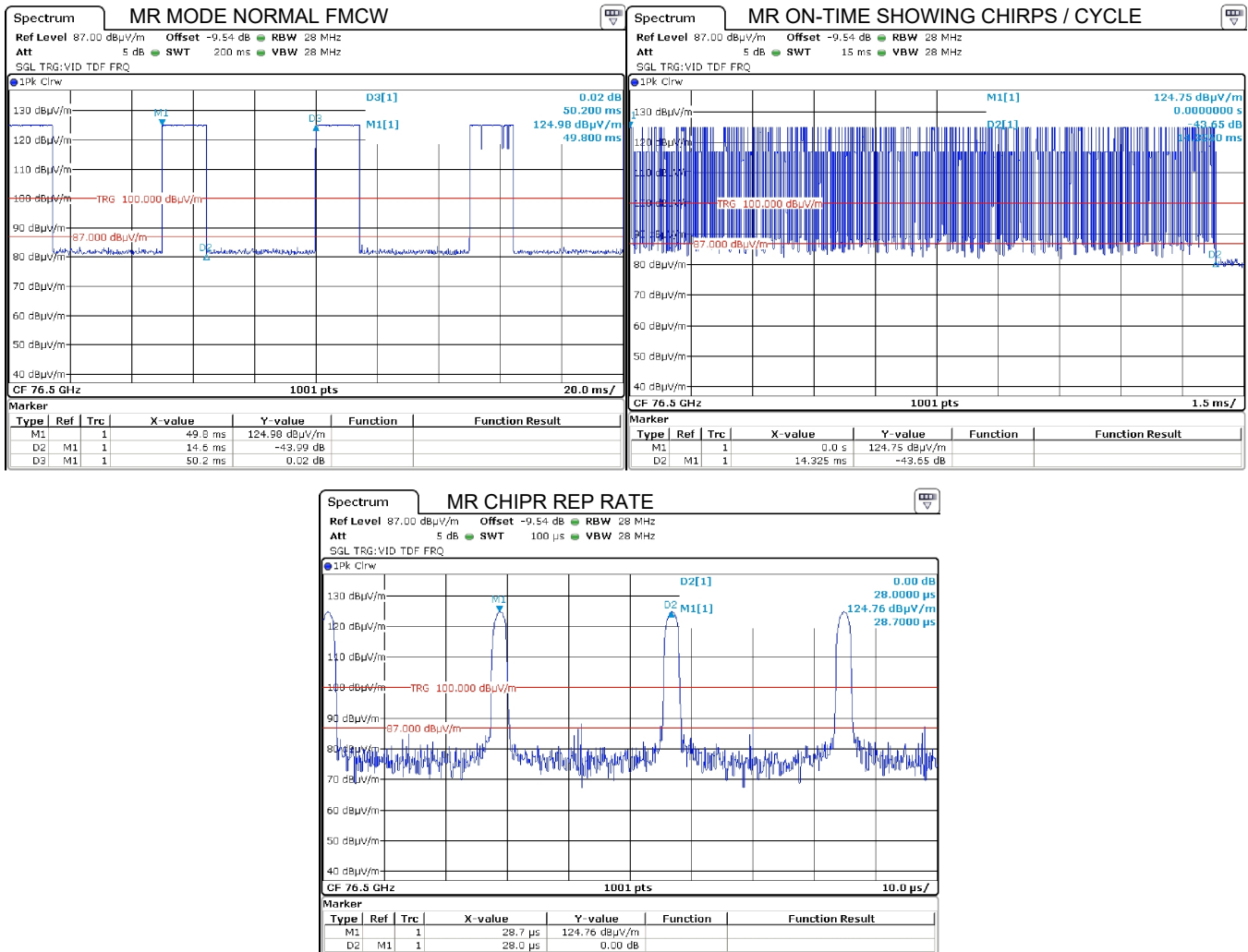

Figure 5(c): Pulsed Emission Characteristics (Duty Cycle).

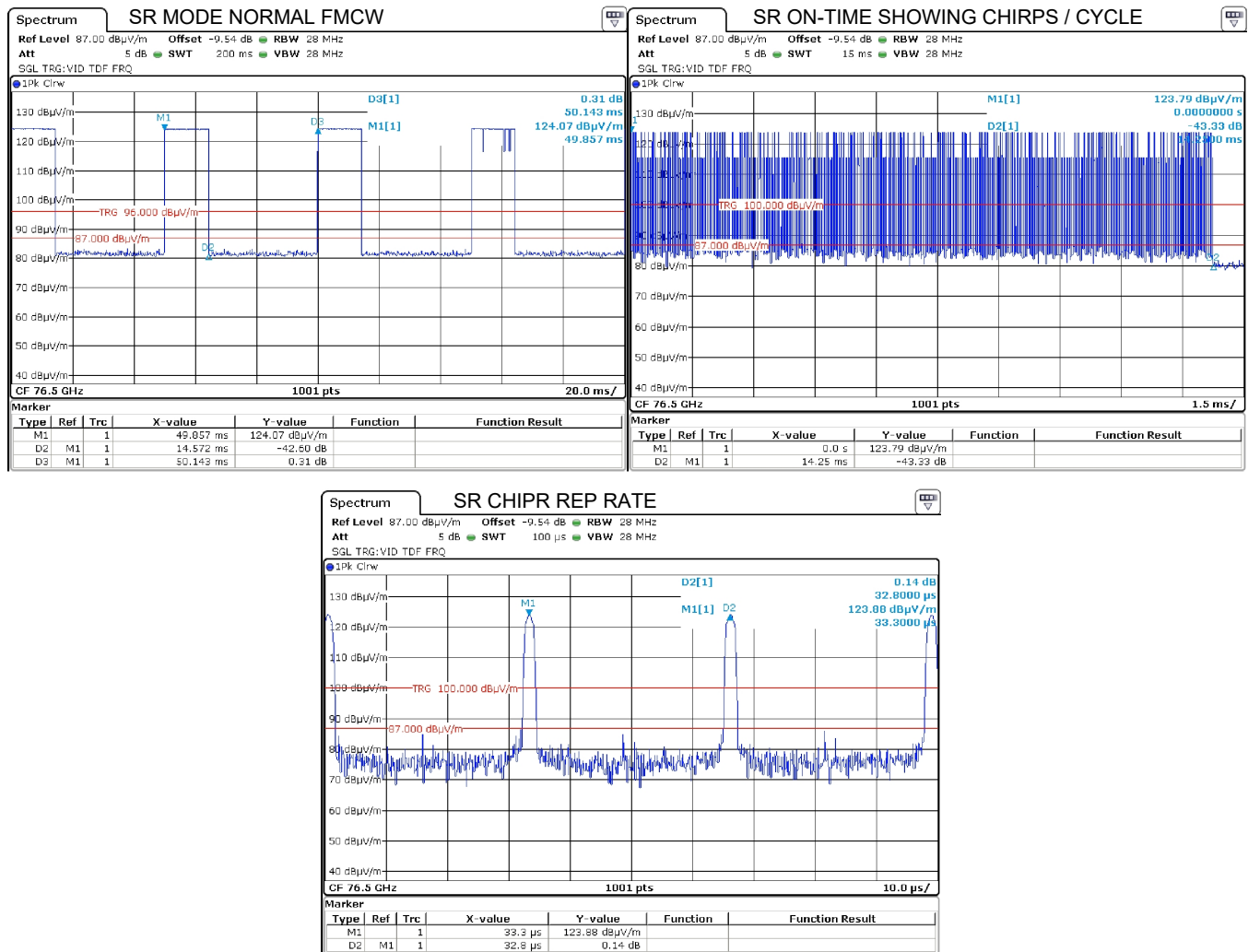

Figure 5(d): Pulsed Emission Characteristics (Duty Cycle).



#### 4.2.2 Fundamental Emission Bandwidth

Emission bandwidth (EBW) of the EUT is measured with the device placed in the worst case test mode. Radiated emissions are recorded following the test procedures listed in Section 2.1. The 99% EBW is measured as the max-held peak-detected signal when the IF bandwidth is greater than or equal to 1% of the receiver span. The results of EBW testing are summarized in Table 5. Plots showing measurements employed to obtain the emission bandwidth reported are provided in Figure 6.

Table 5: Intentional Emission Bandwidth.

<b>Det</b>	<b>IF Bandwidth</b>	<b>Video Bandwidth</b>	<b>Test Date:</b>	1-Nov-19
Pk	10 MHz	28 MHz	<b>Test Engineer:</b>	Joseph Brunett
			<b>EUT:</b>	Aptiv F5TR
			<b>Meas. Distance:</b>	20 cm

Occupied Bandwidth										
Transmit Mode	Channel	Temperature (C)	Voltage (V)	fL* (MHz)	fL Limit (MHz)	fH* (MHz)	fH Limit (MHz)	99% OBW (MHz)	Notes/Pass/Fail	
LR (FMCW)	Low	85.0	18.0	76033.5	76000.0	76277.9	77000.0	244.4		
	Low	85.0	9.0	76033.5	76000.0	76277.9	77000.0	244.4		
	Low	-40.0	18.0	76034.8	76000.0	76279.2	77000.0	244.4		
	Low	-40.0	9.0	76034.8	76000.0	76279.2	77000.0	244.4		
	Mid	20.0	12.0	76409.3	76000.0	76654.0	77000.0	244.7		
	High	85.0	18.0	76708.1	76000.0	76953.3	77000.0	245.2		
	High	85.0	9.0	76708.1	76000.0	76953.3	77000.0	245.2		
	High	-40.0	18.0	76709.4	76000.0	76954.6	77000.0	245.2		
MR (FMCW)	Low	85.0	18.0	76055.8	76000.0	76642.3	77000.0	586.5		
	Low	85.0	9.0	76055.8	76000.0	76642.2	77000.0	586.5		
	Low	-40.0	18.0	76057.0	76000.0	76643.5	77000.0	586.5		
	Low	-40.0	9.0	76057.0	76000.0	76643.5	77000.0	586.5		
	Mid	20.0	12.0	76280.9	76000.0	76866.7	77000.0	585.9		
	High	85.0	18.0	76380.6	76000.0	76967.7	77000.0	587.1		
	High	85.0	9.0	76380.6	76000.0	76967.6	77000.0	587.1		
	High	-40.0	18.0	76381.9	76000.0	76968.9	77000.0	587.1		
SR (FMCW)	Low	85.0	18.0	76042.4	76000.0	76851.0	77000.0	808.6		
	Low	85.0	9.0	76042.3	76000.0	76851.0	77000.0	808.6		
	Low	-40.0	18.0	76043.6	76000.0	76852.3	77000.0	808.6		
	Low	-40.0	9.0	76043.6	76000.0	76852.3	77000.0	808.6		
	High	20.0	12.0	76173.3	76000.0	76979.1	77000.0	805.8		
	High	85.0	18.0	76172.4	76000.0	76978.2	77000.0	805.8		
	High	85.0	9.0	76172.4	76000.0	76978.2	77000.0	805.8		
	High	-40.0	18.0	76173.6	76000.0	76979.5	77000.0	805.8		
				9.0	76173.6	76000.0	76979.5	77000.0	805.8	
				<b>fL<sub>MIN</sub></b>	<b>76042.3</b>	<b>fH<sub>MAX</sub></b>	<b>76979.5</b>	<b>OBW<sub>MAX</sub></b>	<b>808.6</b>	Pass

\* Computed via CW mode frequency shift and nominal OBW measurements.

Equipment Used: RSFSV30001, MIX70TO10001, HRNW01

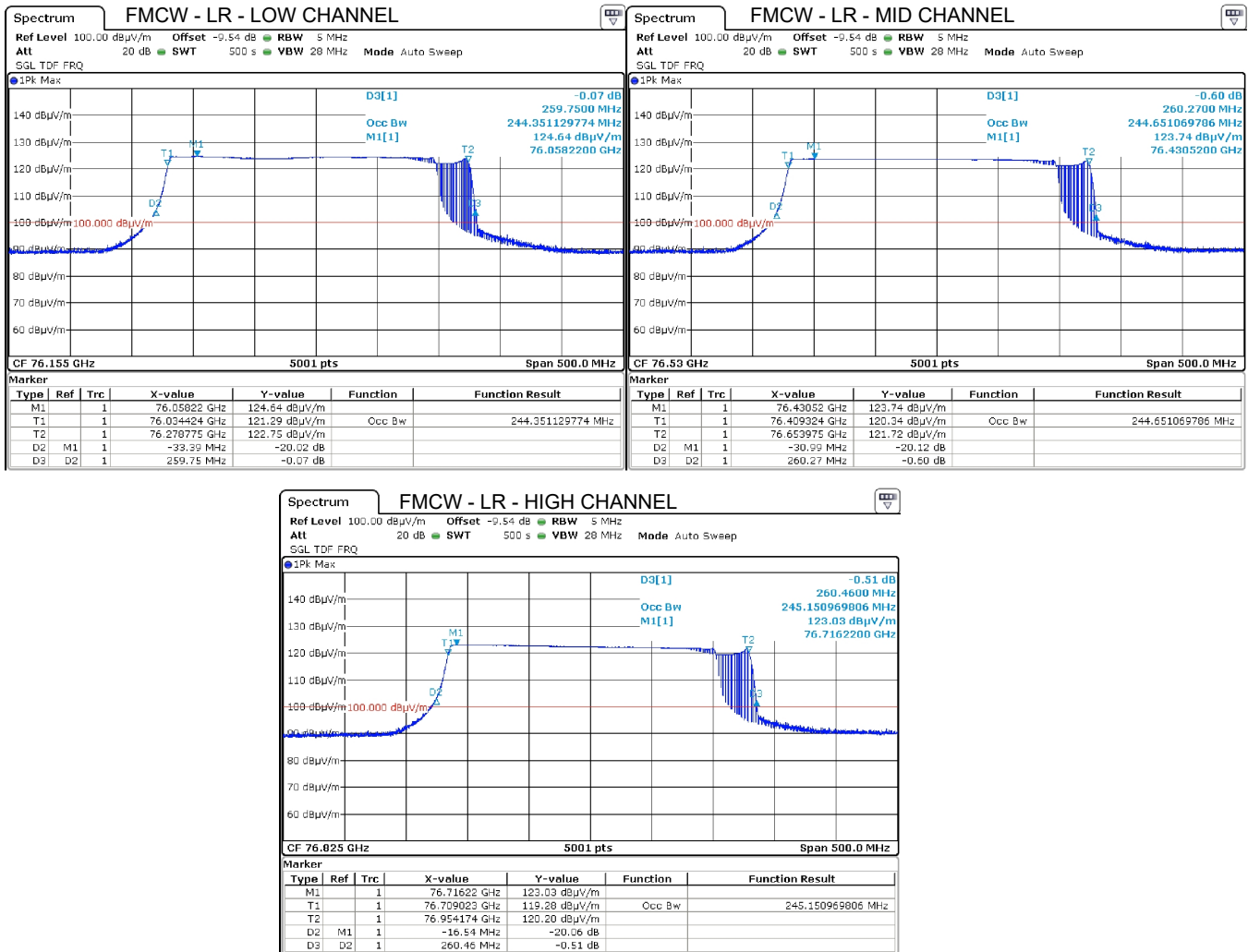

Figure 6(a): Intentional Emission Bandwidth.

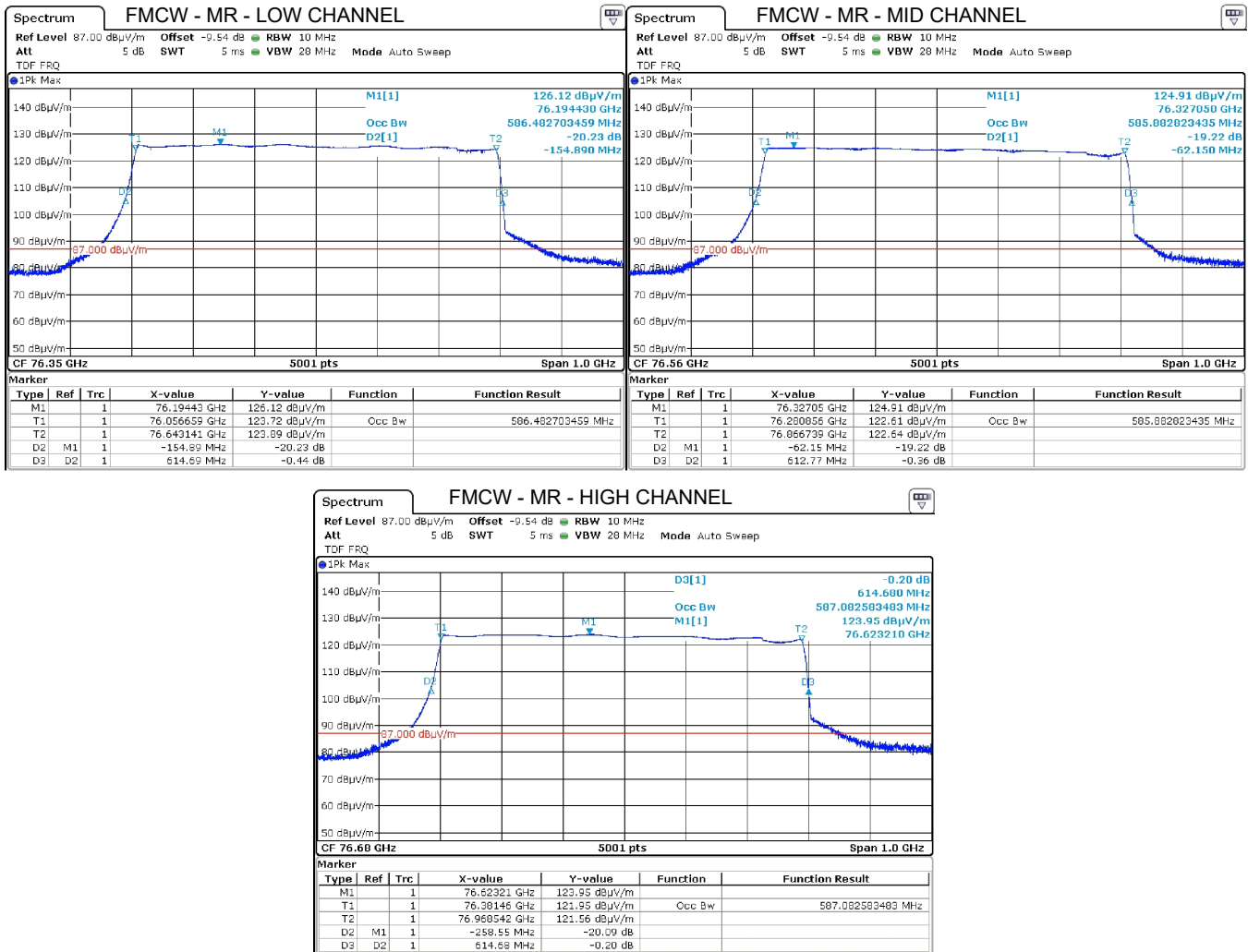

Figure 6(b): Intentional Emission Bandwidth.

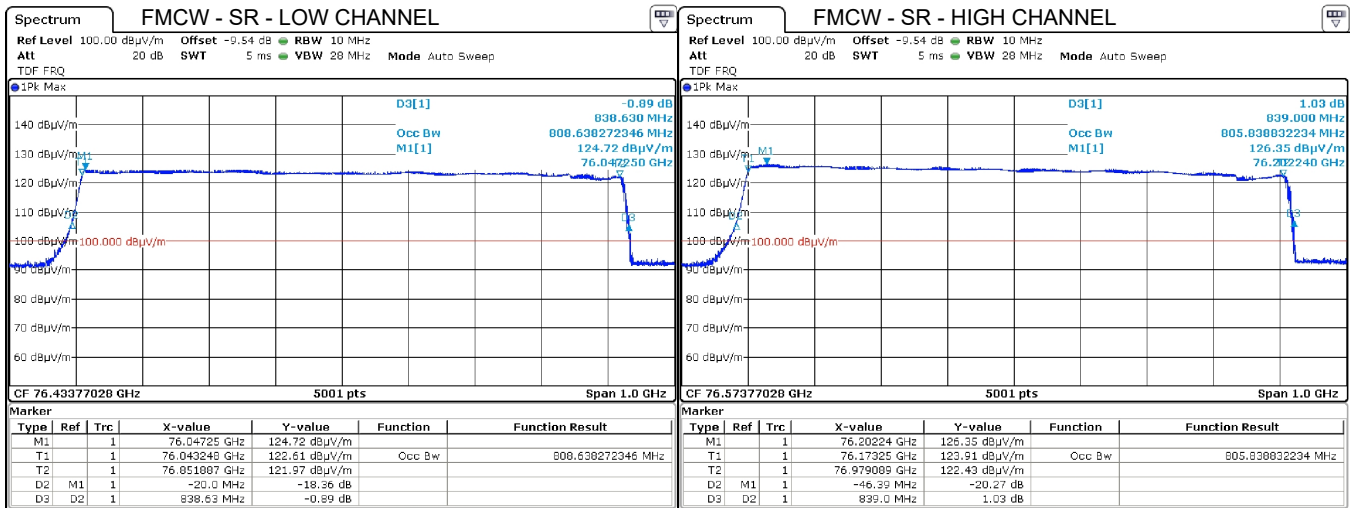

Figure 6(c): Intentional Emission Bandwidth.

### 4.2.3 Fundamental Emission

Following the test procedures listed in Section 2.1, radiated emissions measurements are made on the EUT for both Horizontal and Vertical polarized fields. Table 6 details the results of these measurements.

Table 6: Fundamental Radiated Emissions.

<b>Frequency Range</b>	<b>Det</b>	<b>IF Bandwidth</b>	<b>Video Bandwidth</b>	<b>Test Date:</b>	1-Nov-19
25 MHz f 1 000 MHz	Pk/QPk	120 kHz	300 kHz	<b>Test Engineer:</b>	Joseph Brunett
f > 1 000 MHz	Pk	1 MHz	3 MHz	<b>EUT:</b>	Aptiv F5TR
f > 1 000 MHz	Avg (RMS)	1 MHz	3 MHz	<b>Mode:</b>	CW, MAX ANT GAIN (A1)
				<b>Meas. Distance:</b>	See Table.

#	Env.		Frequency Band		Antenna / Cable					Range Correction <sup>(1)</sup>				E3-Field		EIRP/MHz <sup>(3)</sup>		EIRP/MHz Limit		Pass By	Comments
	Temp. (C)	Volt. (V)	Start MHz	Stop MHz	Ant QN	Pol. H/V	Dim. <sup>(4)</sup> cm	Ka dB/m	Kg dB	MR m	DR m	N/F m	CF dB	Pk dBuV/m	Avg dBuV/m	Pk dBm / MHz	Avg dBm / MHz	Pk dBm/MHz	Avg dBm/MHz		
1	20	12.0	76005.0	76005.0	HRNW01	H/V	5.0	45.3	41.7	3.0	3.0	1.3	0.0	123.2		28.0		55.0	50.0	22.0	max all orientations, CW mode
2	20	12.0	76500.0	76500.0	HRNW01	H/V	5.0	45.3	41.7	3.0	3.0	1.3	0.0	122.8		27.6		55.0	50.0	22.4	max all orientations, CW mode
3	20	12.0	76970.0	76970.0	HRNW01	H/V	5.0	45.3	41.5	3.0	3.0	1.3	0.0	121.7		26.5		55.0	50.0	23.5	max all orientations, CW mode
4																					

#	Mode	Decl. Freq (MHz)	Temp. (C)	E3-Field dBuV/m	Freq. Meas. (MHz)	Freq Error ppm	Volt. (V)	E3-Field dBuV/m	Freq. Meas. (MHz)	Freq Error ppm
5	CW	76.50000	85	122.8	76.50080	-10.5	18.0	122.8	76.50166	-21.7
6			80	122.7	76.50091	-11.9	12.0	122.8	76.50168	-22.0
7			70	122.8	76.50099	-12.9	9.0	122.8	76.50168	-22.0
8			60	122.8	76.50112	-14.6				
9			50	122.7	76.50145	-19.0				
10			40	122.8	76.50153	-20.0				
11			30	122.8	76.50168	-22.0				
12			20	122.8	76.50168	-22.0				
13			10	122.7	76.50171	-22.4				
14			.0	122.6	76.50177	-23.1				
15			-10	122.5	76.50180	-23.5				
16			-20	122.4	76.50189	-24.7				
17			-30	122.3	76.50199	-26.0				
18			-40	122.2	76.50207	-27.1				

- (1) Avg. is computed from the highest measured Peak via the worst-case Spread Duty Cycle detailed in the Duty Cycle section of this test report.
- (2) CF is computed assuming a 20 dB/decade Field Decay Rate. DR is Regulatory Range Distance. MR is Measurement Distance. N/F is near-far boundary.
- (3) EIRP is computed from field strength at 3 meter distance.
- (4) Dimension of antenna is taken to be the larger of the test antenna and the EUT antenna; EUT antenna is 6cm in dimension.

Equipment Used: RSFSV30001, MIX70TO10001, HRNW01

### 4.3 Unintentional Emissions

#### 4.3.1 Transmit Chain Spurious Emissions

The results for the measurement of transmit chain spurious emissions at the nominal voltage and temperature are provided in Table 7.

Table 7(a): Transmit Chain Spurious Emissions.

**Frequency Range**  
 25 MHz f 1 000 MHz  
 f > 1 000 MHz  
 f > 1 000 MHz

**Det**  
 Pk/QPk  
 Pk  
 Avg (RMS)

**IF Bandwidth**  
 120 kHz  
 1 MHz  
 1 MHz

**Video Bandwidth**  
 300 kHz  
 3 MHz  
 3 MHz

**Test Date:** 11/03/19  
**Test Engineer:** Joseph Brunett  
**EUT:** Aptiv F5TR  
**Mode:** LR (FMCW) + CW  
**Meas. Distance:** See Table.

FREQ < 40 GHZ																									
#	Env. Temp. (C)	Volt. (V)	Frequency Band		Antenna + Cable***					Range Correction**				E-Field @ DR		Pass By	Comments								
			Start MHz	Stop MHz	Quality Number	Pol. H/V	Dim. cm	Ka dB/m	Kg dB	MR m	DR m	N/F m	CF dB	Pk dBuV/m	Qpk dBuV/m			Pk dBuV/m	Qpk dBuV/m						
1	16	13.4	30.0	88.0	BICEMCO01	H/V	22.0	16.9	0.0	3.0	3.0	0.0	0.0	36.8	27.4		40.0	12.6	LMH Channels (max all), background						
2	16	13.4	88.0	216.0	BICEMCO01	H/V	22.0	16.9	0.0	3.0	3.0	0.1	0.0	32.9	32.1		43.5	11.4	LMH Channels (max all), background						
3	16	13.4	216.0	1000.0	LOGEMCO01	H/V	22.0	20.1	0.0	3.0	3.0	0.3	0.0	37.3	33.6		46.0	12.4	LMH Channels (max all), background						
#	Env. Temp. (C)	Volt. (V)	Frequency Band		Antenna + Cable***					Range Correction**				E-Field @ DR		Pass By	Comments								
			Start MHz	Stop MHz	Quality Number	Pol. H/V	Dim. cm	Ka dB/m	Kg dB	MR m	DR m	N/F m	CF dB	Pk dBuV/m	Avg dBuV/m			Pk dBuV/m	Avg dBuV/m						
4	16	13.4	1000.0	6000.0	HQR1TO18S01	H/V	22.0	24.1	-1.3	3.0	3.0	1.9	0.0	48.7	41.1		74.0	54.0	LMH Channels (max all), background						
5	16	13.4	6000.0	18000.0	HQR1TO18S01	H/V	15.0	35.0	-2.5	3.0	3.0	2.7	0.0	55.1	43.3		74.0	54.0	LMH Channels (max all), background						
6	16	13.4	18000.0	26500.0	HRNK001	H/V	10.2	33.7	0.0	3.0	3.0	1.8	0.0	51.9	41.0		74.0	54.0	LMH Channels (max all), noise						
7	16	13.4	26500.0	40000.0	HRNKA01	H/V	9.2	37.2	36.0	0.6	3.0	2.3	-14.0	63.2	46.2		74.0	54.0	LMH Channels (max all), noise						
FREQ >> 40 GHZ																									
#	Env. Temp. (C)	Volt. (V)	Frequency Band		Antenna + Cable***					Range Correction**				E-Field @ DR		EIRP**		EIRP ISED Limit****		S @ DR****		S FCC Limit @ DR****		Pass By	Comments
			Start GHz	Stop GHz	Quality Number	Pol. H/V	Dim. cm	Ka dB/m	Kg dB	MR m	DR m	N/F m	CF dB	Pk dBuV/m	Avg/RMS dBuV/m	Pk dBm	RMS dBm	Pk dBm/MHz	RMS dBm/MHz	Pk dBm/cm2	Avg dBm/cm2	Pk dBm/cm2	Avg dBm/cm2		
8	16	13.4	40.0	70.0	HRNU001	H/V	6.3	39.1	0.0	0.30	3.0	1.9	-20.0	59.8	48.7	-35.4	-46.5		-30.0	-95.9	-107.0		-62.2	16.5	LMH Channels (max all)
9	20	13.4	70.0	73.5	HRNW001	H/V	6.0	40.1	0.0	0.30	3.0	1.8	-20.0	63.2	53.0	-32.0	-42.2		-30.0	-92.5	-102.7		-62.2	12.2	LMH Channels (max all)
10	20	13.4	73.5	76.0	HRNW001	H/V	6.0	45.3	0.0	0.30	3.0	1.8	-20.0	76.3	59.1	-18.9	-36.1		0.0	-79.4	-96.7		-62.2	34.5	LowCH (low band edge)
11	20	13.4	73.5	76.0	HRNW001	H/V	6.0	45.3	0.0	0.30	3.0	1.8	-20.0	66.7	51.2	-28.5	-44.0		0.0	-89.0	-104.5		-62.2	42.3	MidCH (low band edge)
12	20	13.4	73.5	76.0	HRNW001	H/V	6.0	45.3	0.0	0.30	3.0	1.8	-20.0	64.4	50.5	-30.8	-44.7		0.0	-91.3	-105.2		-62.2	43.0	HighCH (low band edge)
13	20	13.4	81.0	110.0	HRNW001	H/V	6.0	46.4	0.0	0.30	3.0	2.6	-20.0	65.6	51.4	-29.6	-43.8		-30.0	-90.1	-104.3		-62.2	13.8	LowCH (high band edge)
14	20	13.4	81.0	110.0	HRNW001	H/V	6.0	46.4	0.0	0.30	3.0	2.6	-20.0	65.0	51.1	-30.2	-44.1		-30.0	-90.7	-104.6		-62.2	14.1	MidCH (high band edge)
15	20	13.4	81.0	110.0	HRNW001	H/V	6.0	46.4	0.0	0.30	3.0	2.6	-20.0	75.3	51.7	-19.9	-43.5		-30.0	-80.4	-104.1		-62.2	13.5	HighCH (high band edge)
16	20	13.4	110.0	140.0	HRNG001	H/V	6.0	54.0	0.0	0.15	3.0	3.4	-26.0	72.0	59.8	-23.2	-35.4		-30.0	-83.7	-95.9		-62.2	5.4	LMH Channels (max all)
17	20	13.4	140.0	200.0	HRNG001	H/V	6.0	54.0	0.0	0.15	3.0	4.8	-26.0	72.6	60.9	-22.6	-34.3		-30.0	-83.1	-94.8		-62.2	4.3	LMH Channels (max all)
18	20	13.4	200.0	231.0	HRNG001	H/V	6.0	54.0	0.0	0.15	3.0	5.5	-26.0	90.0	77.9	-5.2	-17.3			-65.7	-77.8		-60.0	17.3	LMH Channels (max all)
19																									

\* CF is computed assuming a 20 dB/decade Decay Rate. DR is Regulatory Range Distance. MR is Measurement Distance, reduced as necessary to achieve Rx. sensitivity.

\*\* EIRP is computed from field strength at 3 meter distance in a 1 MHz RBW / 3 MHz VBW.

\*\*\* Dimension of antenna is taken to be larger of the test antenna and the DUT antenna; DUT antenna is 6cm in dimension.

\*\*\*\* S @ DR: 600 pW/cm2 = -62.2 dBm/cm2, 1000 pW/cm2 = -60 dBm/cm2, FCC Regulatory Limit; ISED Regulatory Limit EIRP / MHz

Spacial Power Density S @ 3m (dBm/cm2) = EIRP (dBm) - 10\*log10(4\*pi\*(300cm)^2) = EIRP (dBm) - 60.5 dB

Equipment Used: RFSFSV30001

Table 7(b): Transmit Chain Spurious Emissions.

<b>Frequency Range</b> 25 MHz f 1 000 MHz f > 1 000 MHz f > 1 000 MHz	<b>Det</b> Pk/QPk Pk Avg (RMS)	<b>IF Bandwidth</b> 120 kHz 1 MHz 1 MHz	<b>Video Bandwidth</b> 300 kHz 3 MHz 3 MHz	<b>Test Date:</b> 11/03/19
				<b>Test Engineer:</b> Joseph Brunett
				<b>EUT:</b> Aptiv F5TR
				<b>Mode:</b> MR (FCW) + CW
				<b>Meas. Distance:</b> See Table.

FREQ < 40 GHZ																			
#	Env. Temp. (C)	Volt. (V)	Frequency Band		Antenna + Cable***				Range Correction*				E-Field @ DR		E-Field Limit		Pass By	Comments	
			Start MHz	Stop MHz	Quality Number	Pol. H/V	Dim. cm	Ka dB/m	Kg dB	MR m	DR m	N/F m	CF dB	Pk dBuV/m	Qpk dBuV/m	Pk dBuV/m			Qpk dBuV/m
1	16	13.4	30.0	88.0	BICEMCO01	H/V	22.0	16.9	0.0	3.0	3.0	0.0	0.0	36.8	27.4	40.0	12.6	LMH Channels (max all), background	
2	16	13.4	88.0	216.0	BICEMCO01	H/V	22.0	16.9	0.0	3.0	3.0	0.1	0.0	32.9	32.1	43.5	11.4	LMH Channels (max all), background	
3	16	13.4	216.0	1000.0	LOGEMCO01	H/V	22.0	20.1	0.0	3.0	3.0	0.3	0.0	37.3	33.6	46.0	12.4	LMH Channels (max all), background	
#	Env. Temp. (C)	Volt. (V)	Frequency Band		Antenna + Cable***				Range Correction*				E-Field @ DR		E-Field Limit		Pass By	Comments	
			Start MHz	Stop MHz	Quality Number	Pol. H/V	Dim. cm	Ka dB/m	Kg dB	MR m	DR m	N/F m	CF dB	Pk dBuV/m	Avg dBuV/m	Pk dBuV/m			Avg dBuV/m
4	16	13.4	1000.0	6000.0	HQRITO18S01	H/V	22.0	24.1	-1.3	3.0	3.0	1.9	0.0	48.7	41.1	74.0	54.0	12.9	LMH Channels (max all)
5	16	13.4	6000.0	18000.0	HQRITO18S01	H/V	15.0	35.0	-2.5	3.0	3.0	2.7	0.0	55.1	43.3	74.0	54.0	10.7	LMH Channels (max all), background
6	16	13.4	18000.0	26500.0	HRNK001	H/V	10.2	33.7	0.0	3.0	3.0	1.8	0.0	51.9	41.0	74.0	54.0	13.0	LMH Channels (max all), noise
7	16	13.4	26500.0	40000.0	HRNKA01	H/V	9.2	37.2	36.0	0.6	3.0	2.3	-14.0	63.2	46.2	74.0	54.0	7.8	LMH Channels (max all), noise

\* CF is computed assuming a 20 dB/decade Decay Rate. DR is Regulatory Range Distance. MR is Measurement Distance, reduced as necessary to achieve Rx. sensitivity.  
 \*\* EIRP is computed from field strength at 3 meter distance in a 1 MHz RBW / 3 MHz VBW.  
 \*\*\* Dimension of antenna is taken to be larger of the test antenna and the DUT antenna; DUT antenna is 6cm in dimension.  
 \*\*\*\* S @ DR: 600 pW/cm2 = -62.2 dBm/cm2, 1000 pW/cm2 = -60 dBm/cm2, FCC Regulatory Limit; ISED Regulatory Limit EIRP / MHz  
 Spatial Power Density S @ 3m (dBm/cm2) = EIRP (dBm) - 10\*log10(4\*pi\*(300cm)^2) = EIRP (dBm) - 60.5 dB  
 Equipment Used: RSFSV30001

Table 7(c): Transmit Chain Spurious Emissions.

<b>Frequency Range</b> 25 MHz f 1 000 MHz f > 1 000 MHz f > 1 000 MHz	<b>Det</b> Pk/QPk Pk Avg (RMS)	<b>IF Bandwidth</b> 120 kHz 1 MHz 1 MHz	<b>Video Bandwidth</b> 300 kHz 3 MHz 3 MHz	<b>Test Date:</b> 11/03/19
				<b>Test Engineer:</b> Joseph Brunett
				<b>EUT:</b> Aptiv F5TR
				<b>Mode:</b> SR (FCW) + CW
				<b>Meas. Distance:</b> See Table.

FREQ < 40 GHZ																			
#	Env. Temp. (C)	Volt. (V)	Frequency Band		Antenna + Cable***				Range Correction*				E-Field @ DR		E-Field Limit		Pass By	Comments	
			Start MHz	Stop MHz	Quality Number	Pol. H/V	Dim. cm	Ka dB/m	Kg dB	MR m	DR m	N/F m	CF dB	Pk dBuV/m	Qpk dBuV/m	Pk dBuV/m			Qpk dBuV/m
1	16	13.4	30.0	88.0	BICEMCO01	H/V	22.0	16.9	0.0	3.0	3.0	0.0	0.0	36.8	27.4	40.0	12.6	LH Channels (max all), background	
2	16	13.4	88.0	216.0	BICEMCO01	H/V	22.0	16.9	0.0	3.0	3.0	0.1	0.0	32.9	32.1	43.5	11.4	LH Channels (max all), background	
3	16	13.4	216.0	1000.0	LOGEMCO01	H/V	22.0	20.1	0.0	3.0	3.0	0.3	0.0	37.3	33.6	46.0	12.4	LH Channels (max all), background	
#	Env. Temp. (C)	Volt. (V)	Frequency Band		Antenna + Cable***				Range Correction*				E-Field @ DR		E-Field Limit		Pass By	Comments	
			Start MHz	Stop MHz	Quality Number	Pol. H/V	Dim. cm	Ka dB/m	Kg dB	MR m	DR m	N/F m	CF dB	Pk dBuV/m	Avg dBuV/m	Pk dBuV/m			Avg dBuV/m
4	16	13.4	1000.0	6000.0	HQRITO18S01	H/V	22.0	24.1	-1.3	3.0	3.0	1.9	0.0	48.7	41.1	74.0	54.0	12.9	LH Channels (max all)
5	16	13.4	6000.0	18000.0	HQRITO18S01	H/V	15.0	35.0	-2.5	3.0	3.0	2.7	0.0	55.1	43.3	74.0	54.0	10.7	LH Channels (max all), background
6	16	13.4	18000.0	26500.0	HRNK001	H/V	10.2	33.7	0.0	3.0	3.0	1.8	0.0	51.9	41.0	74.0	54.0	13.0	LH Channels (max all), noise
7	16	13.4	26500.0	40000.0	HRNKA01	H/V	9.2	37.2	36.0	0.6	3.0	2.3	-14.0	63.2	46.2	74.0	54.0	7.8	LH Channels (max all), noise

\* CF is computed assuming a 20 dB/decade Decay Rate. DR is Regulatory Range Distance. MR is Measurement Distance, reduced as necessary to achieve Rx. sensitivity.  
 \*\* EIRP is computed from field strength at 3 meter distance in a 1 MHz RBW / 3 MHz VBW.  
 \*\*\* Dimension of antenna is taken to be larger of the test antenna and the DUT antenna; DUT antenna is 6cm in dimension.  
 \*\*\*\* S @ DR: 600 pW/cm2 = -62.2 dBm/cm2, 1000 pW/cm2 = -60 dBm/cm2, FCC Regulatory Limit; ISED Regulatory Limit EIRP / MHz  
 Spatial Power Density S @ 3m (dBm/cm2) = EIRP (dBm) - 10\*log10(4\*pi\*(300cm)^2) = EIRP (dBm) - 60.5 dB  
 Equipment Used: RSFSV30001

## 5 Measurement Uncertainty and Accreditation Documents

The maximum values of measurement uncertainty for the laboratory test equipment and facilities associated with each test are given in the table below. This uncertainty is computed for a 95.45% confidence level based on a coverage factor of  $k = 2$ .

Table 8: Measurement Uncertainty.

Measured Parameter	Measurement Uncertainty <sup>†</sup>
Radio Frequency	$\pm(f_{Mkr}/10^7 + RBW/10 + (SPN/(PTS - 1))/2 + 1 \text{ Hz})$
Conducted Emm. Amplitude	$\pm 1.9 \text{ dB}$
Radiated Emm. Amplitude (30 – 200 MHz)	$\pm 4.0 \text{ dB}$
Radiated Emm. Amplitude (200 – 1000 MHz)	$\pm 5.2 \text{ dB}$
Radiated Emm. Amplitude ( $f > 1000 \text{ MHz}$ )	$\pm 3.7 \text{ dB}$

<sup>†</sup>Ref: CISPR 16-4-2:2011+A1:2014



Figure 7: Accreditation Documents