

# GNSS+LTE MIMO+WIFI Combination Antenna Q-(JCA236+JCG316LMW)-1

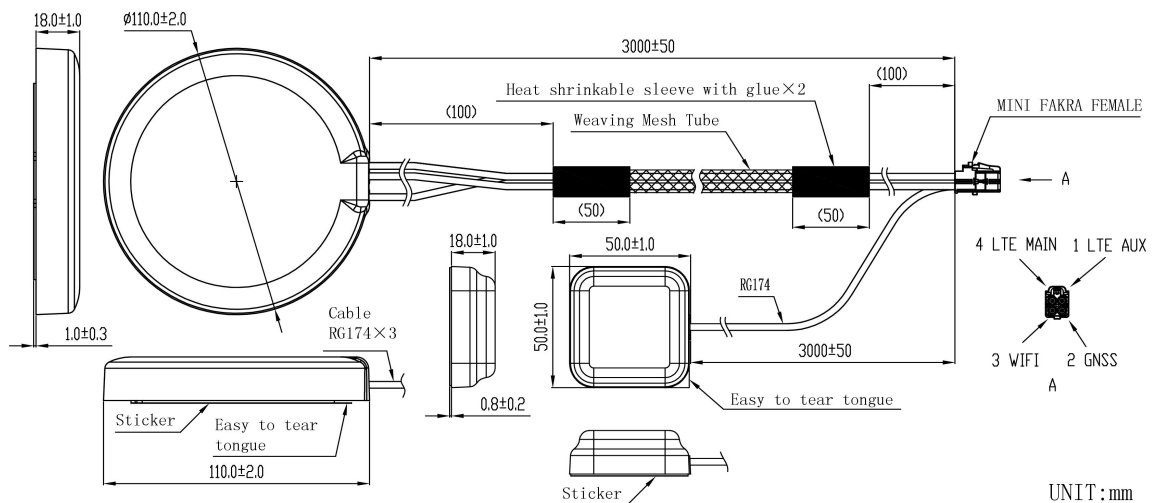

## DIMENSIONS



JIAXING JINCHANG ELECTRONIC TECHNOLOGY CO.,LTD

Add: 398#, Zhenye Road, South Street, Jiaxing, Zhejiang, China

Http:// www.jinchanggps.com

E-mail: jcgps@vip.163.com

Tel: 86-0573-83692157/83692605/83958637 Fax: 86-0573-83958635

**SPECIFICATIONS**

Item		Specifications	
GNSS Antenna	Dielectric Antenna (2 Pins)	Frequency Range	1561.098~1602MHz
		Polarization	RHCP
		Gain	5dBic (Zenith)
		V.S.W.R	<1.5
		Axial Ratio	3dB
	LNA	Gain	28±2dB
		Noise Figure	≤2.0dB
		V.S.W.R	<2.0
		Supply Voltage	3~5V DC
		Current Consumption	<20mA
LTE MIMO&WIFI Antenna	LTE MIMO	Frequency Range	698~960MHz/1710~2690MHz
		V.S.W.R	≤3.0
		Polarization	Linear
		Gain	2.0dBi
		Impedance	50Ω
	WIFI	Frequency Range	2400~2483.5MHz/4900~5825MHz
		Polarization	Linear
		Gain	3dBi
		V.S.W.R	≤2.0
		Impedance	50Ω
Mechanical	Cable	RG174 or others	
	Connector	FAKRA or others	
	Material	ABS	
	Mounting Method	Adhesive/Magnet	
Environmental	Operating Temperature	-40℃~+85℃	
	Relative Humidity	Up to 95%	
	Ingress Protection	IP66	
	Vibration	10 to 55Hz with 1.5mm amplitude 2hours	
	Environmentally Friendly	ROHS Compliant	

**Radiation Pattern**

GNSS Antenna

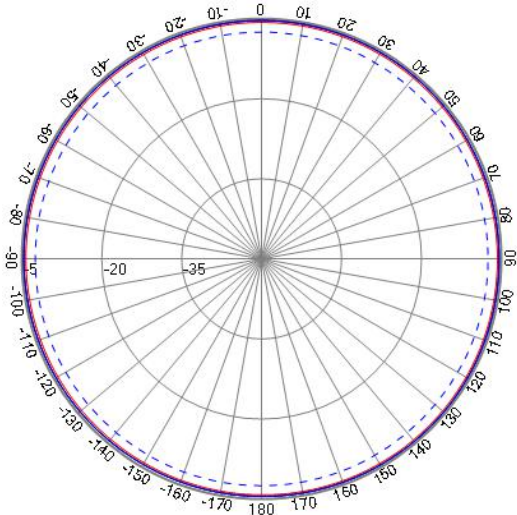

XY-PLANE

- Freq: 1602
- Freq: 1561
- Freq: 1575

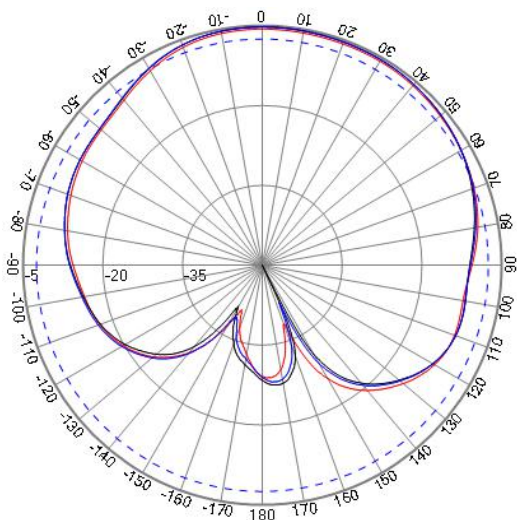

XZ-PLANE

- Freq: 1602
- Freq: 1561
- Freq: 1575

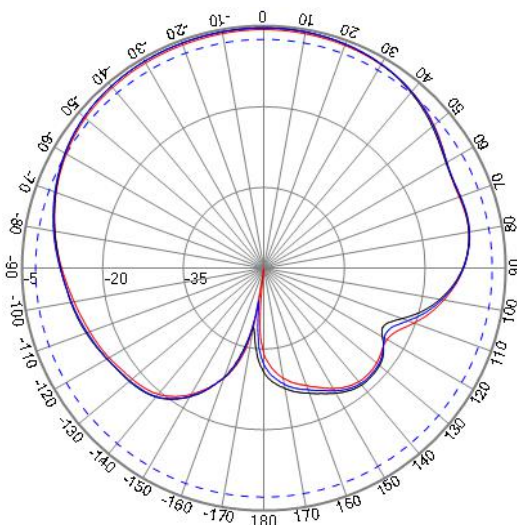

YZ-PLANE

- Freq: 1602
- Freq: 1561
- Freq: 1575

JIAXING JINCHANG ELECTRONIC TECHNOLOGY CO.,LTD

Add: 398#, Zhenye Road, South Street, Jiaxing, Zhejiang, China

Http:// www.jinchanggps.com

E-mail: jcgps@vip.163.com

Tel: 86-0573-83692157/83692605/83958637 Fax: 86-0573-83958635

LTE Antenna

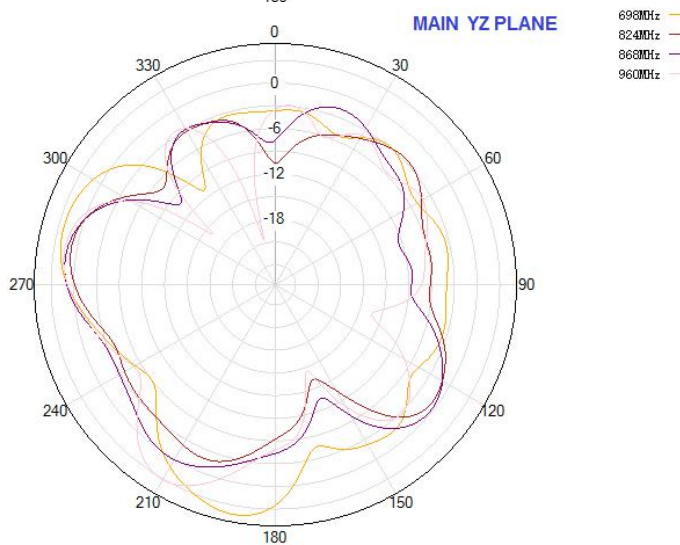
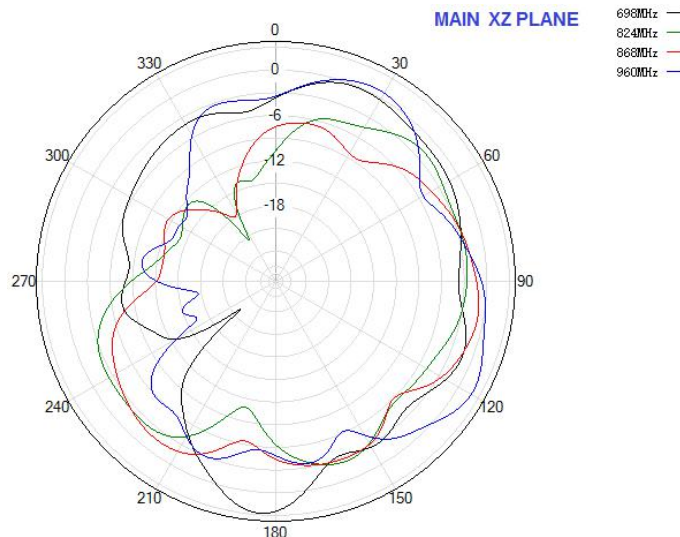
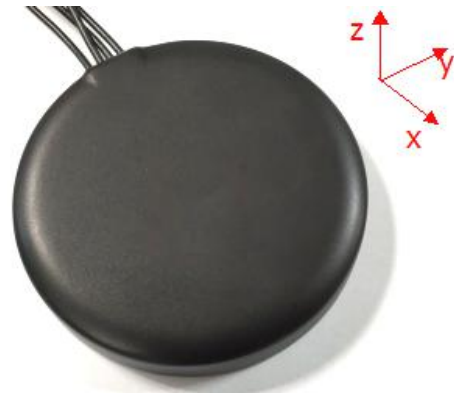
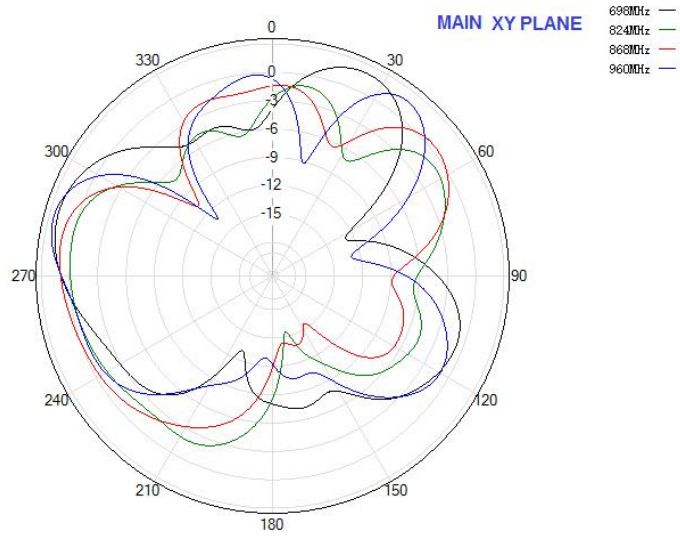



Jinchang Electron Global Service

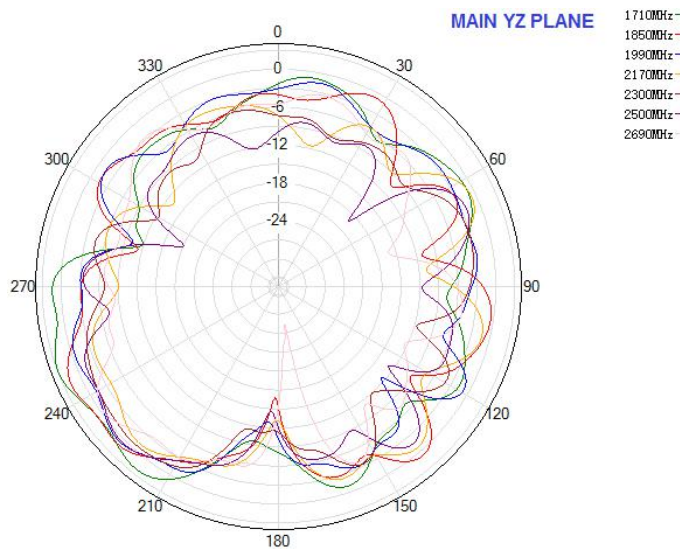
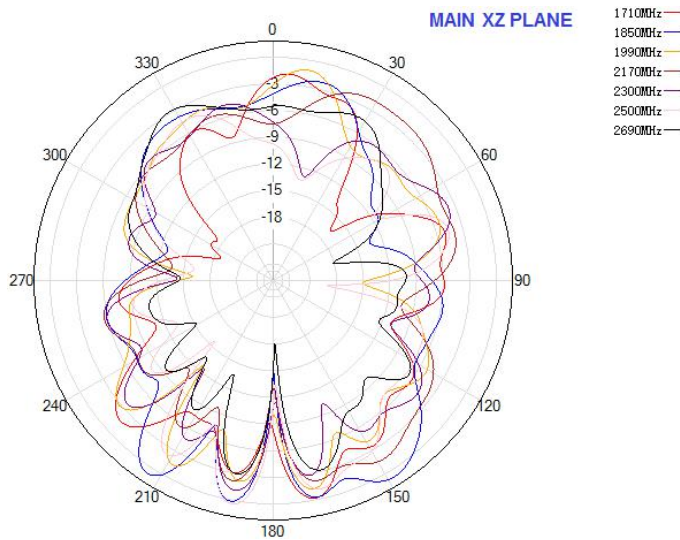
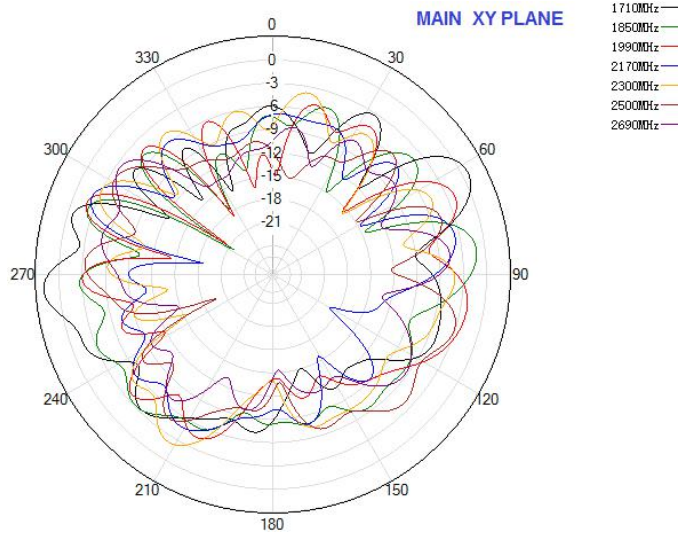



Jinchang Electron Global Service

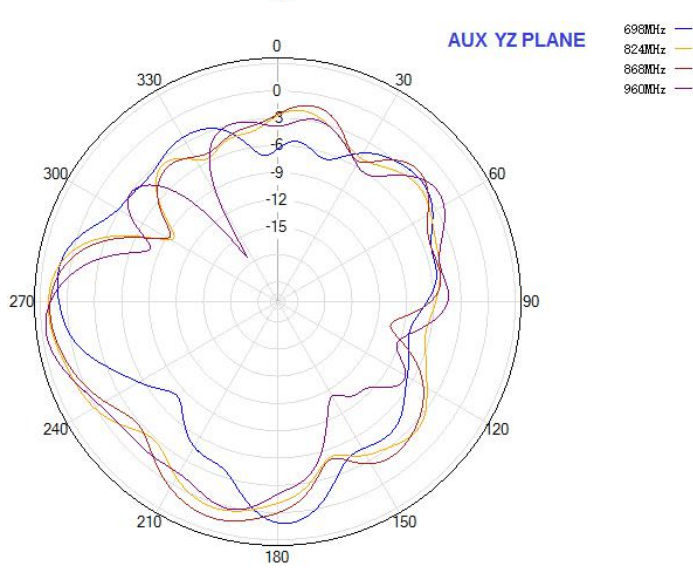
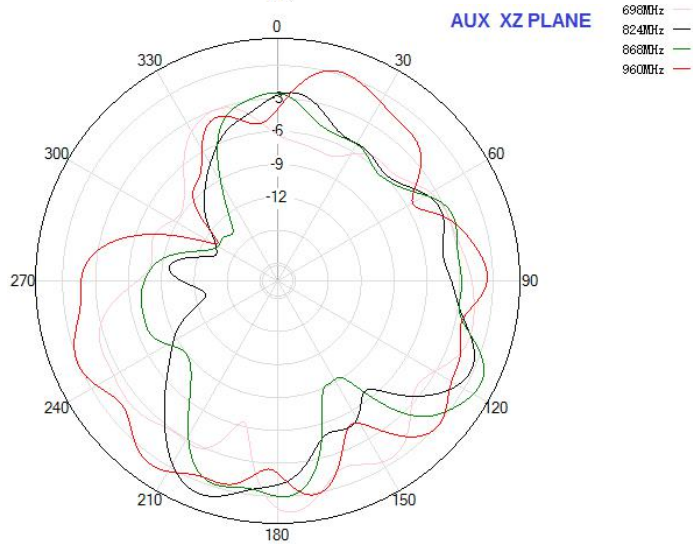
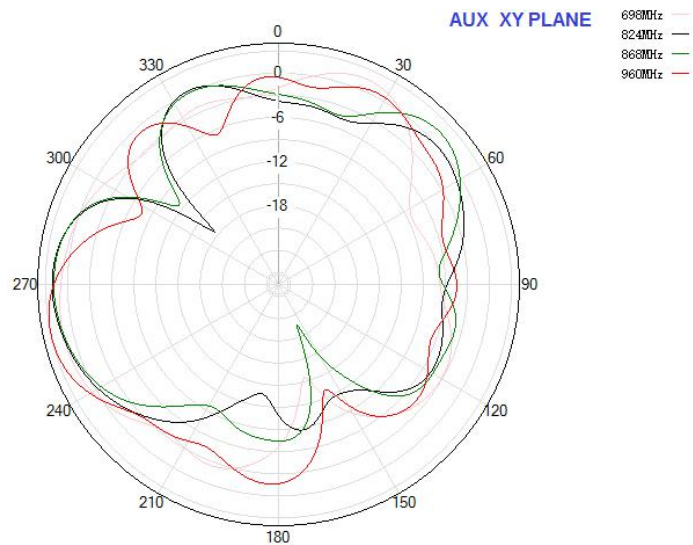



Jinchang Electron Global Service

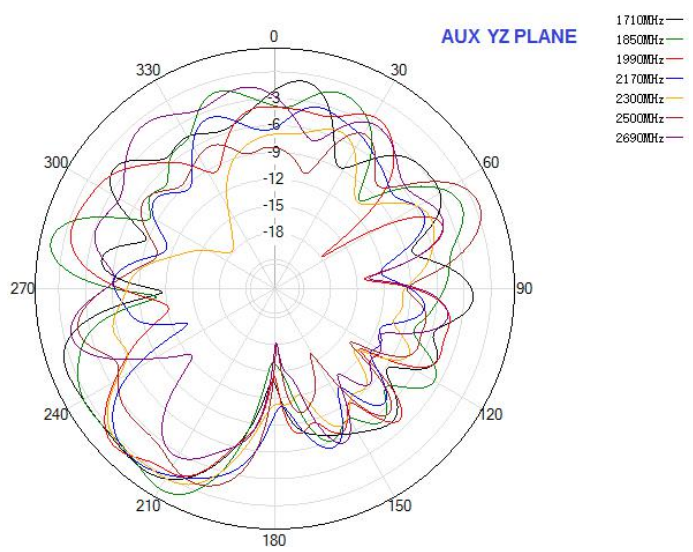
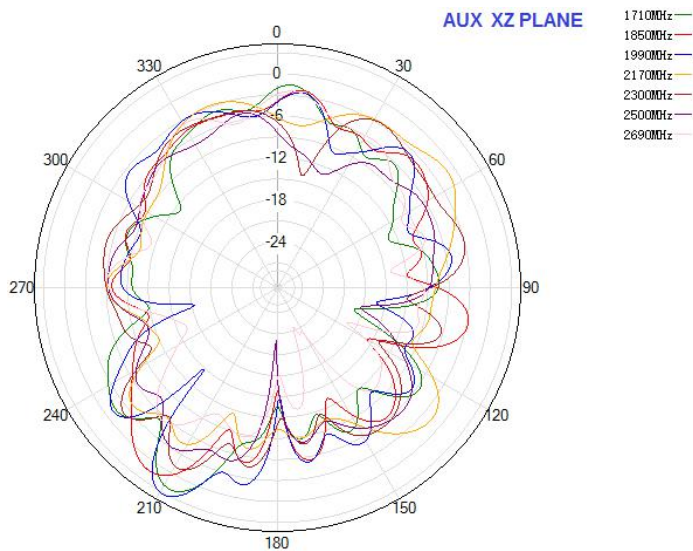
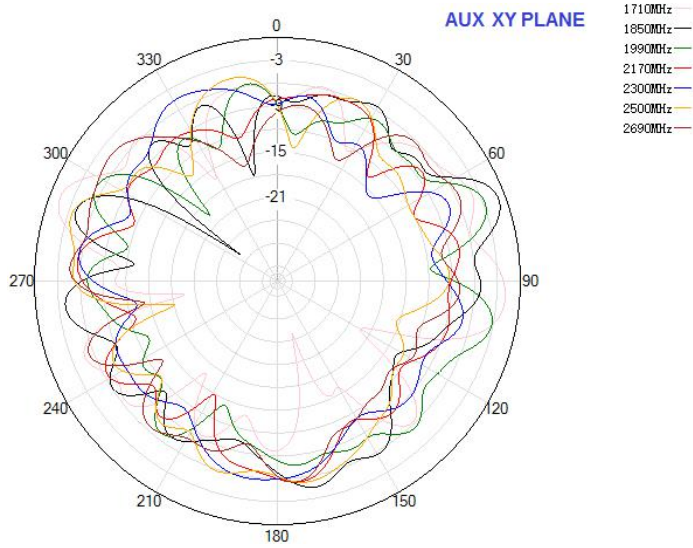

WIFI Antenna

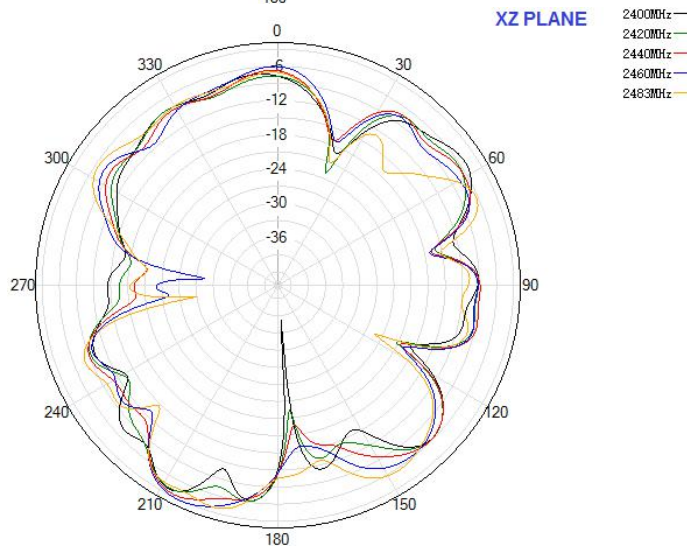
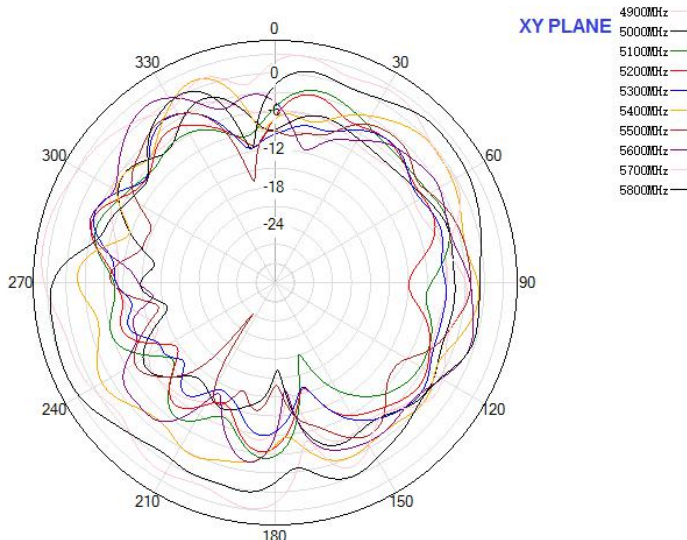
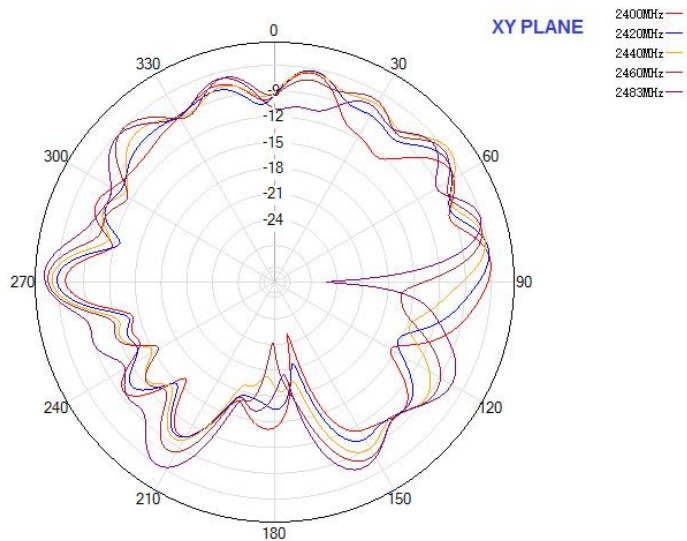





Jinchang Electron Global Service

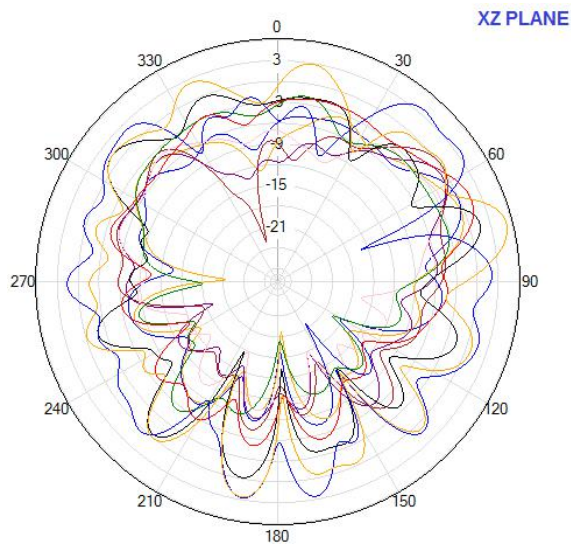

- 4900MHz
- 5000MHz
- 5100MHz
- 5200MHz
- 5300MHz
- 5400MHz
- 5500MHz
- 5600MHz
- 5700MHz
- 5800MHz

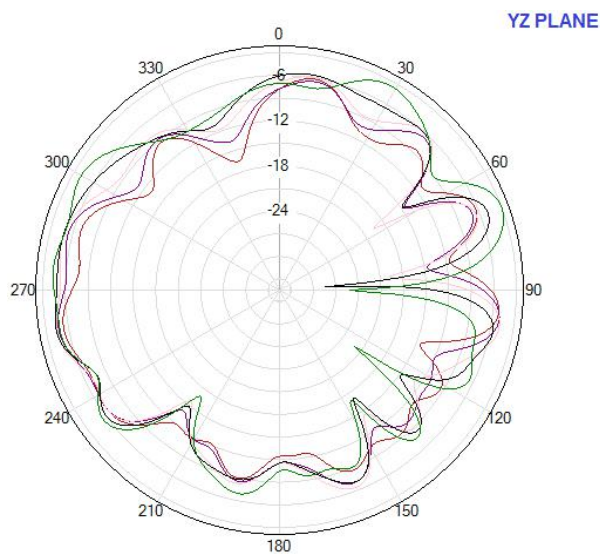

- 2400MHz
- 2420MHz
- 2440MHz
- 2463MHz

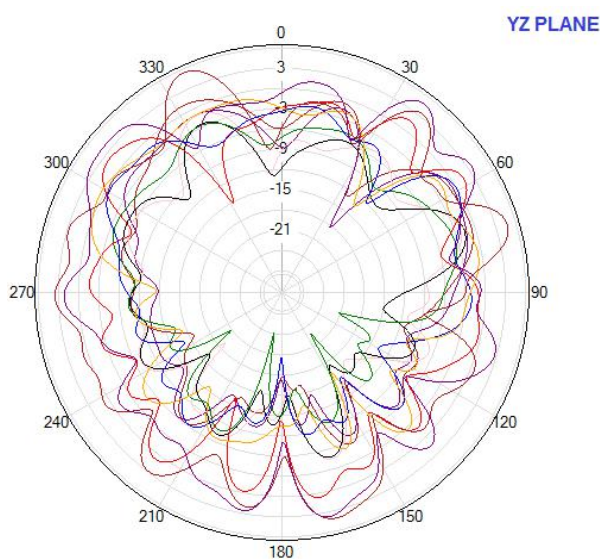

- 4900MHz
- 5000MHz
- 5100MHz
- 5200MHz
- 5300MHz
- 5400MHz
- 5500MHz
- 5600MHz
- 5700MHz
- 5800MHz