

SEL	V_SW_INT	RGB_YBPR_SEL
YPbPb	0	0
VGA	0	1
2PYpPb	1	1
EXT_YRpb	1	0

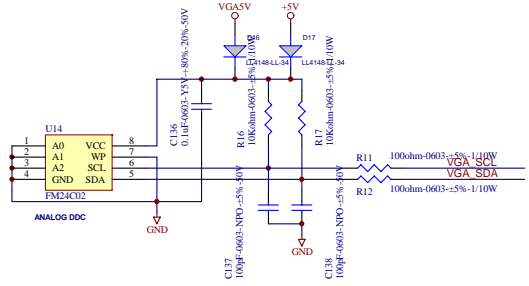

D11 BAV99LT(A7)-SOT-23  
C25 0.1uF-0603-Y5V-80%-20%-50V

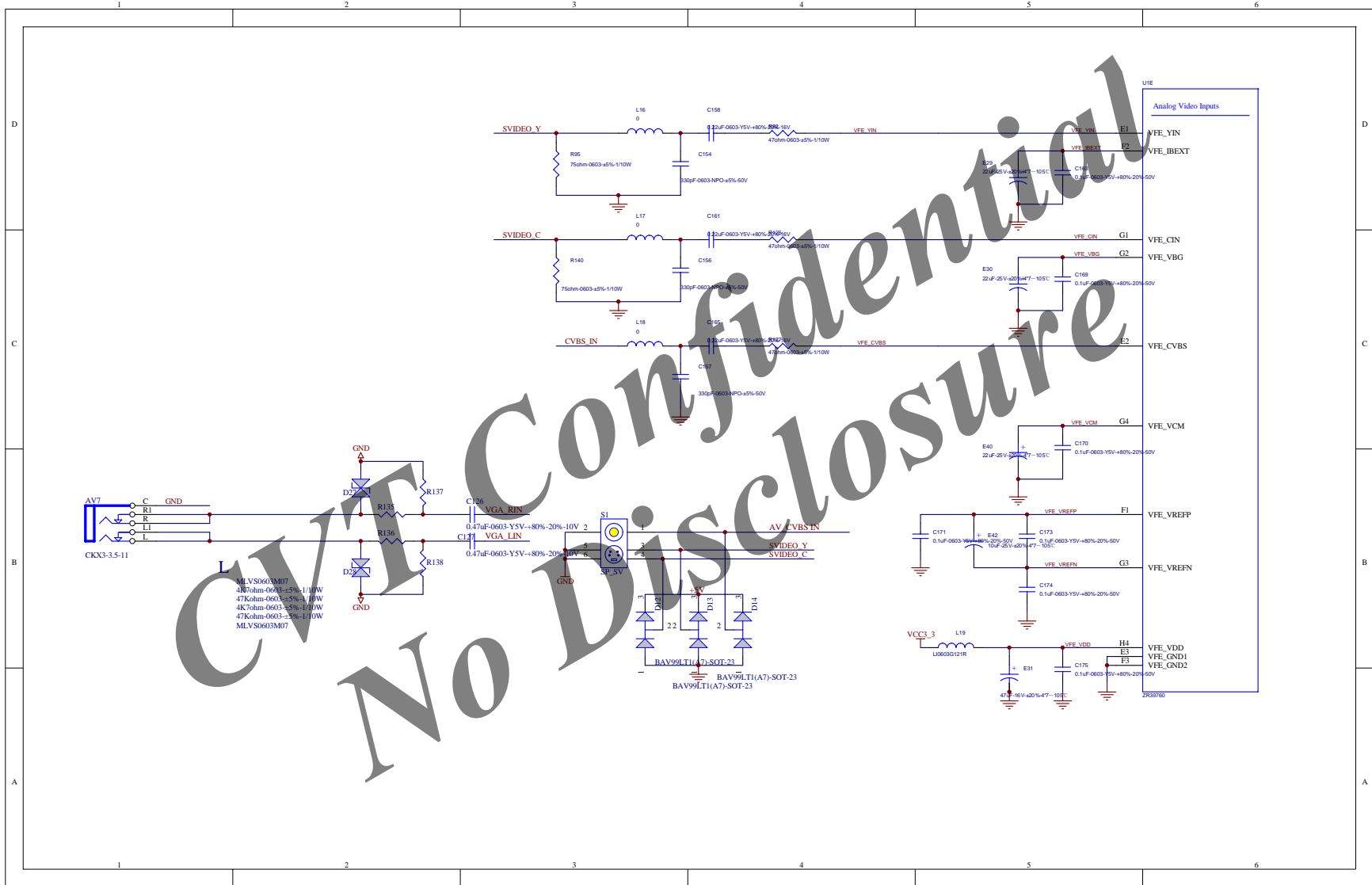





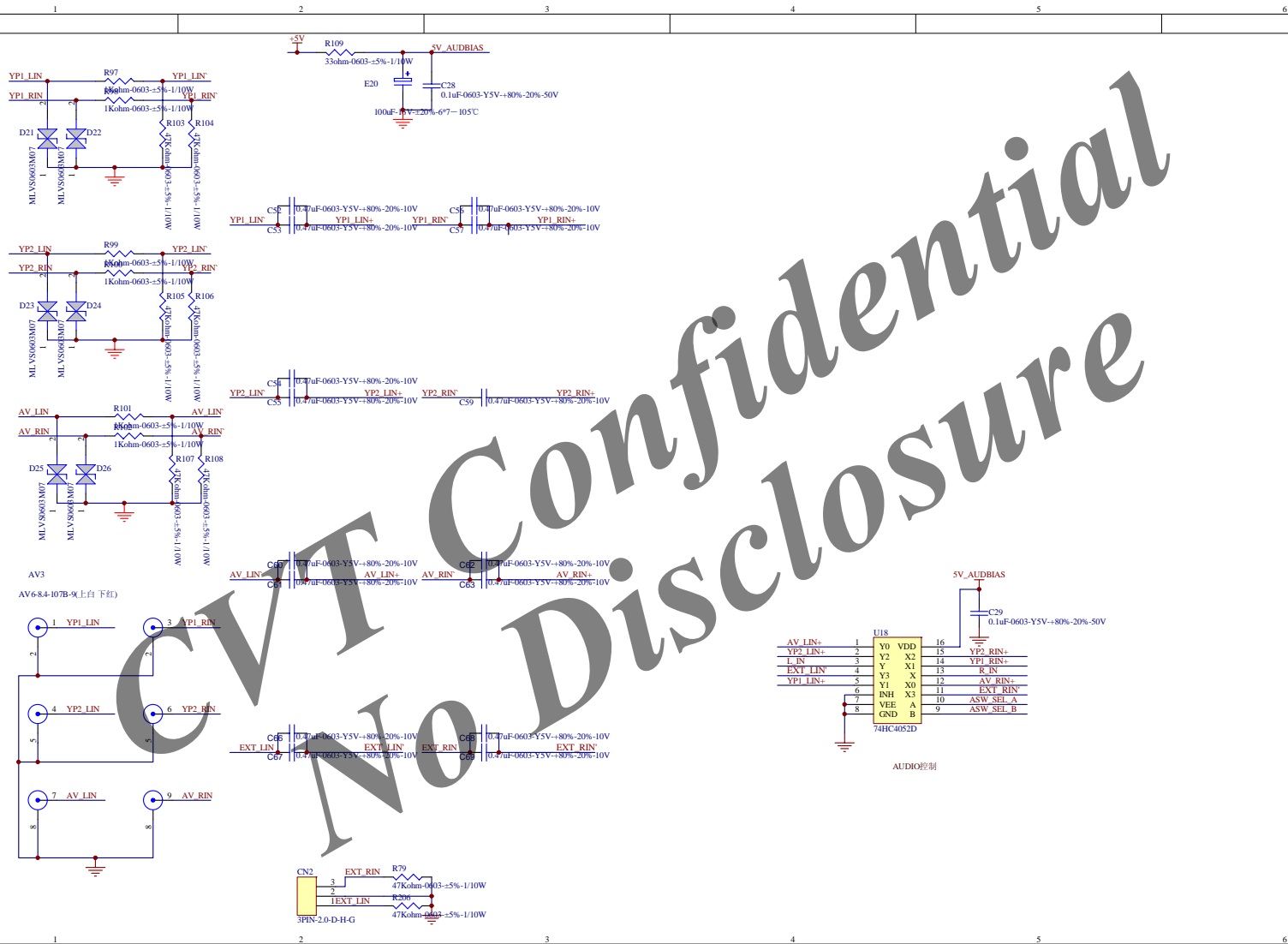

CONFIDENTIAL  
NO Disclosure

AV_LIN+	1	Y0	VDD	16	YP2_RIN+
YP2_LIN+	2	Y2	X2	15	YP2_RIN+
L_IN	3	Y2	X2	14	YP1_RIN+
EXT_LIN	4	Y3	X1	13	R_IN
YP1_LIN+	5	Y3	X0	12	AV_RIN+
	6	INH	X3	11	EXT_RIN
	7	VEE	A	10	ASW_SEL_A
	8	GND	B	9	ASW_SEL_B

74HC4052D

AUDIO控制





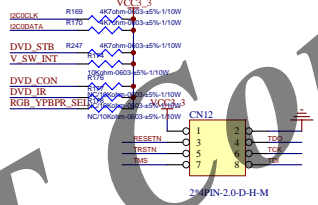
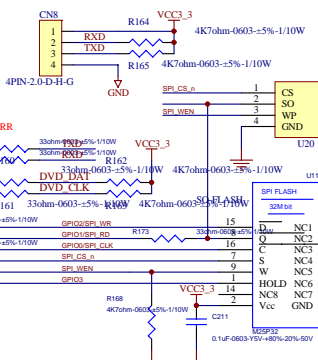
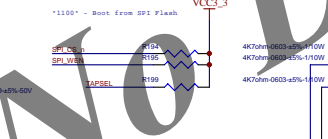
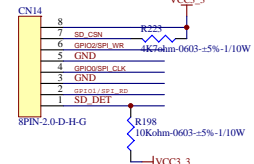
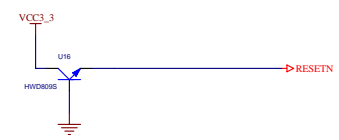
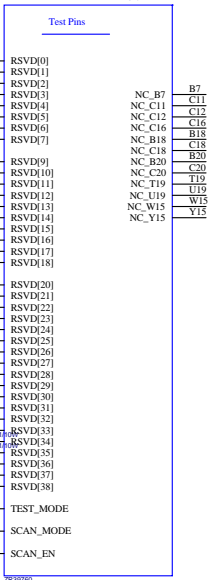
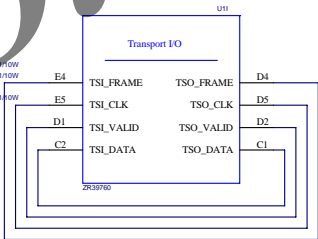
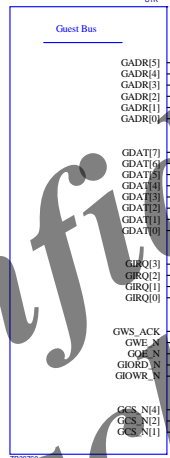
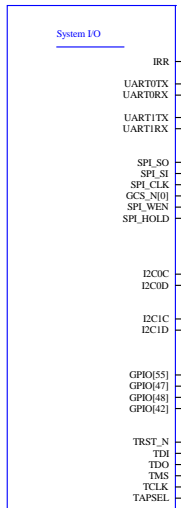
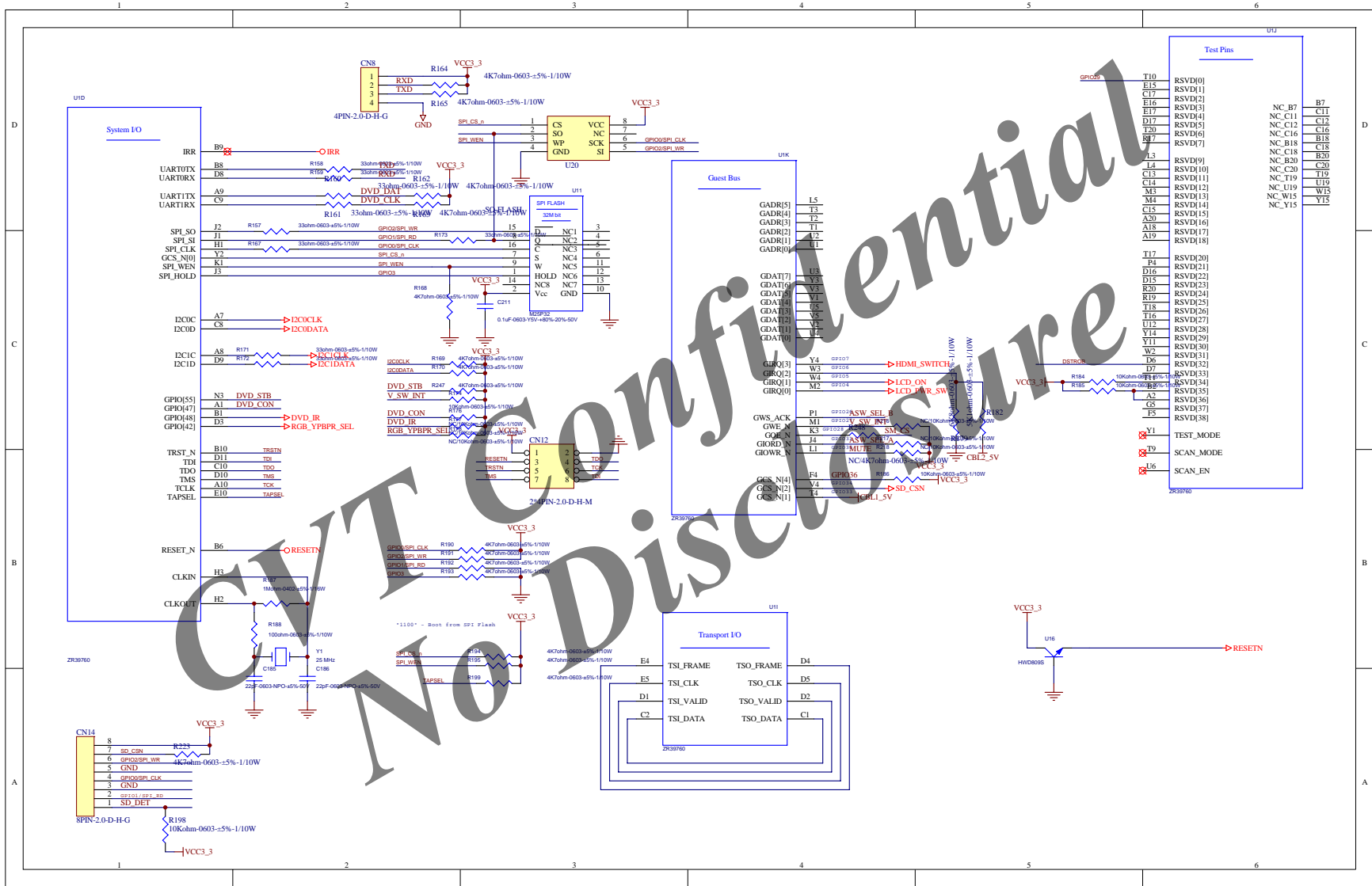

Confidential  
No Disclosure

