

KTL Test Report: 9L0022RUS

Applicant: Andrew Corporation
2601 Telecom Parkway
Richardson, Tx.

Equipment Under Test: 2400 Mobile Data Radio and 385700-4000-001 4 Port
Line Amplifier.

FCC ID: KUWMDL2400MDR

In Accordance With: **FCC Part 15, Subpart C**
Direct Sequence Transmitters 2.4 – 2.4835 GHz

Tested By: KTL Dallas Inc.
802 N Kealy
Lewisville, Tx 75057-3136

Authorized By: 
Tom Tidwell, RF Group Manager

Date: January 4, 2000

Total Number of Pages: 51

Table Of Contents

Section 1. Summary of Test Results

General.....4
Summary of Test Data5

Section 2. General Equipment Specification

Specifications - Transmitter6
Specifications - Receiver7
Modifications8
Family List Rational8
Theory of Operation 9
System Diagram9-10

Section 3. Powerline Conducted Emissions

Test Results11-13
Potographs14

Section 4. Occupied Bandwidth

Test Results15
Graphs16

Section 5. Peak Power Output

Test Results17
Peak Power Output Table18-19

Section 6. Spurious Emissions (Antenna Conducted)

Test Results20
Graphs21-25

Section 7. Spurious Emissions (Radiated)

Test Results26
Test Data - Radiated Emissions (PEAK)27-28
Test Data - Radiated Emissions (AVERAGE)27-28
Radiated Photographs29
Test Data - Microwave Radiated Emissions30
Microwave Photographs.....31
Test Data - Microwave Radiated Emissions32
Microwave Photographs.....33

EQUIPMENT: 2400 Mobile Data Radio and 385700-4000-001 4 Port Line Amplifier
FCC ID:

Table Of Contents (Continued)

Section 8. Transmitter Power Density

Test Results34
Graphs35-36

Section 9. Processing Gain

Test Results37
Processing Gain Data38
Additional Data39

Section 10. Test Equipment List

Equipment List40

Annex A. Test Methodologies

Powerline Conducted EmissionsA2
Occupied BandwidthA3
Peak Power OutputA4
Spurious Emissions at Antenna Terminal.....A5
Radiated Spurious EmissionsA6
Transmitter Power DensityA7
Processing Gain.....A8

Annex B. Block Diagrams

Test Site for Radiated EmissionsB2
Conducted EmissionsB2
Transmitter Power Density & Peak Power at Antenna TerminalsB3
Processing Gain.....B3

EQUIPMENT: 2400 Mobile Data Radio and 385700-4000-001 4 Port Line Amplifier
FCC ID:

Section 1. Summary Of Test Results

Manufacturer: Andrew Corporation
Model No.: 2400 Mobile Data Radio and 385700-4000-001 4 Port Line Amplifier
Serial No.: DL
General: **All measurements are traceable to national standards.**

These tests were conducted on a sample of the equipment for the purpose of demonstrating compliance with FCC Part 15, Subpart C, Paragraph 15.247 for Direct Sequence Spread Spectrum devices.

- | | | | |
|-------------------------------------|----------------------------|-------------------------------------|---------------------|
| <input checked="" type="checkbox"/> | New Submission | <input checked="" type="checkbox"/> | Production Unit |
| <input type="checkbox"/> | Class II Permissive Change | <input type="checkbox"/> | Pre-Production Unit |

THIS TEST REPORT RELATES ONLY TO THE ITEM(S) TESTED.

THE FOLLOWING DEVIATIONS FROM, ADDITIONS TO, OR EXCLUSIONS FROM THE TEST SPECIFICATIONS HAVE BEEN MADE.
See " Summary of Test Data".



NVLAP LAB CODE: 100351-0

TESTED BY: Ron Gaytan DATE: 8/10/99-10/27/99

KTL Dallas, Inc. authorizes the above named company to reproduce this report provided it is reproduced in its entirety and for use by the company's employees only.

Any use which a third party makes of this report, or any reliance on or decisions to be made based on it, are the responsibility of such third parties. KTL Dallas, Inc. accepts no responsibility for damages, if any, suffered by any third party as a result of decisions made or actions based on this report. This report applies only to the items tested.

*EQUIPMENT: 2400 Mobile Data Radio and 385700-4000-001 4 Port Line Amplifier**FCC ID:*

Summary Of Test Data:

NAME OF TEST	PARA. NO.	SPEC.	MEAS.	RESULT
Powerline Conducted Emissions	15.207 (a)	48 dB μ V	42 dB μ V	Complies
Occupied Bandwidth	15.247 (a)(2)	\geq 500 kHz	12.3246 MHz	Complies
Peak Power Output	15.247 (b)	1 Watt	1Watt	Complies
Spurious Emissions (Antenna Conducted)	15.247 (c)	-20 dBc	-20.88 dBm	Complies
Spurious Emissions (Radiated)	15.247 (c)	Table 15.209 (a)	61.8 dBuV/m	Complies
Transmitter Power Density	15.247 (d)	\leq +8 dBm	1.33 dBm	Complies
Processing Gain	15.247 (e)	\geq 10 dB	15.9 dB	Complies

Footnotes:**Test Conditions:**

Indoor Temperature: 22°C
 Humidity: 36%

Outdoor Temperature: 28°C
 Humidity: 48%

EQUIPMENT: 2400 Mobile Data Radio and 385700-4000-001 4 Port Line Amplifier
FCC ID:

Section 2. General Equipment Specification

Transmitter:

Power Input:	18-56 VDC	
Frequency Range:	2400-2483.5 GHz	
Tunable Bands:	Not Applicable	
6 dB Bandwidth:	13.6347 MHz	
Type of Modulation	GPSK	
Data Rate:	128 Kbps	Radio to radio
	64 Kbps	User equipment to radio
Internal / External Data Source:	External	
Emissions Designator:	13M6F9W	
Output Impedance:	50 ohms	
RF Power Output (Rated):	1 Watt	
Duty Cycle:	Up to 100%	
Channel Spacing:	Not Applicable	
Operator Selection of Operating Frequency:	Not Applicable	
Power Output Adjustment Capability:	Computer controlled <32 dBm	

EQUIPMENT: 2400 Mobile Data Radio and 385700-4000-001 4 Port Line Amplifier

FCC ID:

Receiver:

Frequency Range: 2400-2483.5 GHz

Tunable Bands: Not Applicable

1st IF: 2276.352 MHz

2nd IF: 129.6 MHz

Bandwidth: 12.3246 MHz

Type of Modulation: GFSK

Operator Selection of Operating Frequency Not Applicable

NOTE: other oscillators in receiver section are
42.752 MHz
16.896 MHz

KTL Dallas, Inc.

FCC PART 15, SUBPART C
DIRECT SEQUENCE TRANSMITTERS
PROJECT NO.: 9L0022RUS

EQUIPMENT: 2400 Mobile Data Radio and 385700-4000-001 4 Port Line Amplifier
FCC ID:

Description of Modification for Modification Filing:

1.) Properly shielded Data 1 And Data 2 ports at both ends of the cables on 3-2400 base station.

Family List Rational:

Not Applicable

EQUIPMENT: 2400 Mobile Data Radio and 385700-4000-001 4 Port Line Amplifier

FCC ID:

Theory of Operation:

The Mobile Data Radio is a full duplex transceiver. The unit received and transmits data to customer provided equipment through a synchronous interface EIA-530 interface. The radio is used in a subway train system.

System Diagram: Base Station Setup

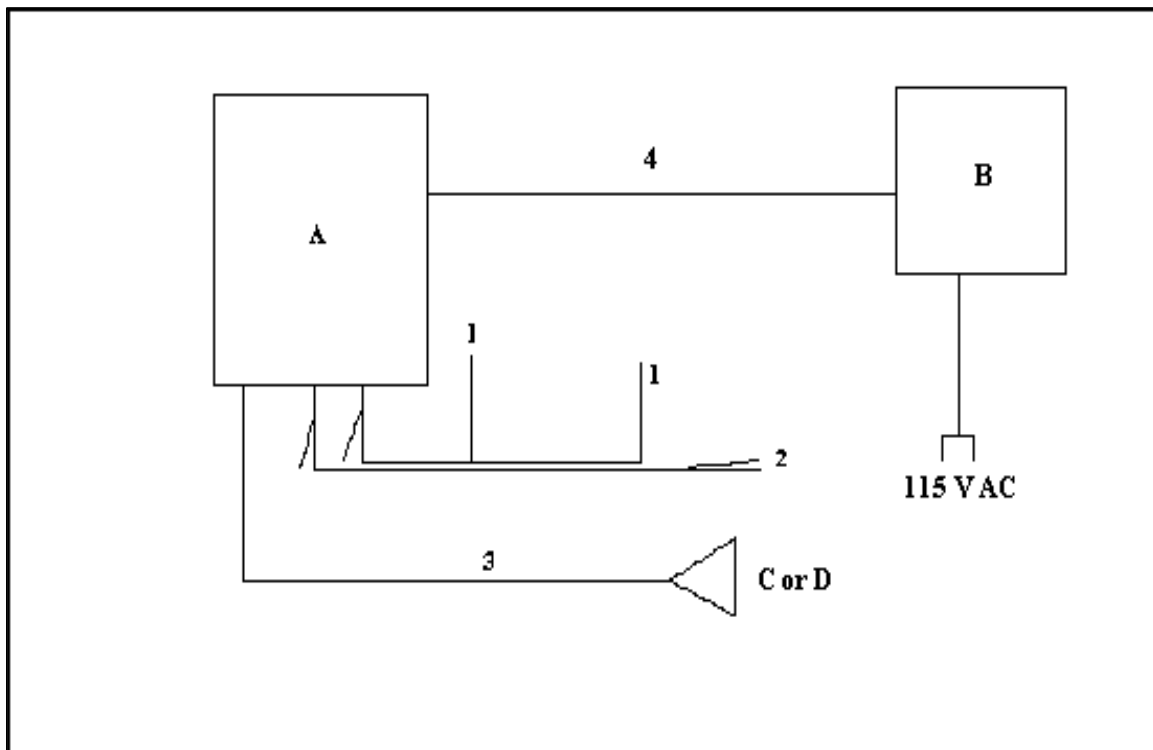

EQUIPMENT: 2400 Mobile Data Radio and 385700-4000-001 4 Port Line Amplifier

FCC ID:

System Diagram: Line Amplifier Setup

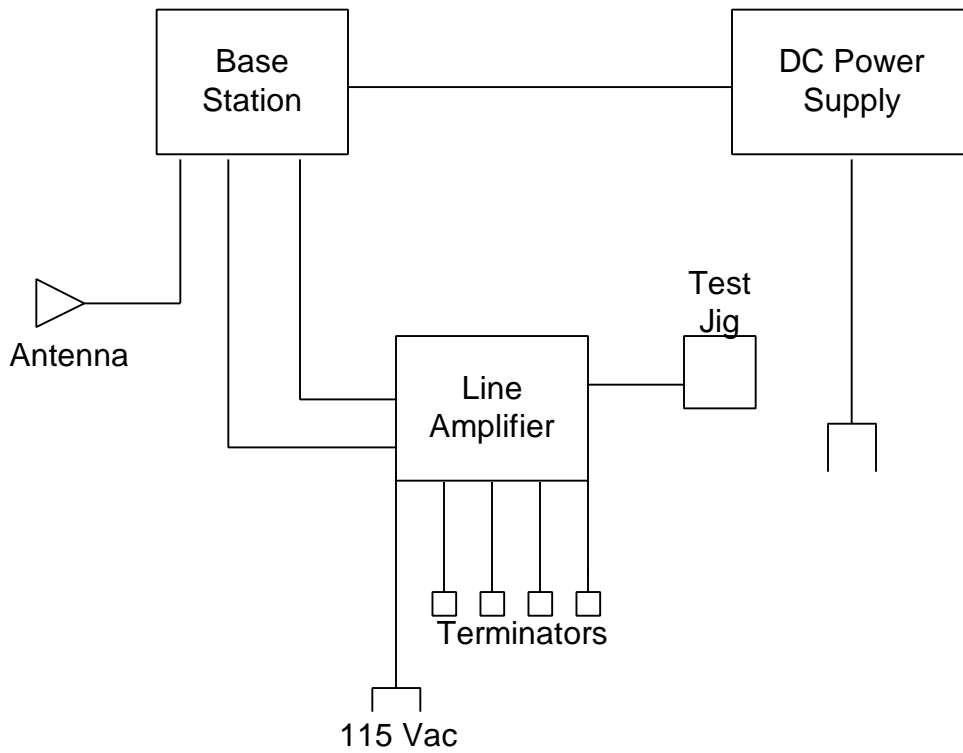

KTL Dallas, Inc.

FCC PART 15, SUBPART C
DIRECT SEQUENCE TRANSMITTERS
PROJECT NO.: 9L0022RUS

EQUIPMENT: 2400 Mobile Data Radio and 385700-4000-001 4 Port Line Amplifier

FCC ID:

Section 3. Powerline Conducted Emissions

NAME OF TEST: Powerline Conducted Emissions	PARA. NO.: 15.207(a)
TESTED BY: Ron GaytanTom Tidwell / Debbie Jensen	DATE: 12/20/99

Test Results: Complies. See attached data.

Measurement Data: See attached data. Next page.

EQUIPMENT: 2400 Mobile Data Radio and 385700-4000-001 4 Port Line Amplifier

FCC ID: _____

Powerline Conducted Emissions Test # CE-2:

Conducted Emissions Data (CISPR Quasi-Peak Detector) FCC (CFR 47)									
Complete	<u> X </u>								
Preliminary	<u> </u>		Page <u> 1 </u> of <u> 2 </u>						
Client:	<u> Andrew Coporation </u>			W.O.#:	<u> 9L0025R </u>		Date:	<u> 12/20/99 </u>	
EUT:	<u> 385700-4000-001 </u>			S/N:	<u> None </u>		Specification:	<u> CFR47 part 15.207 </u>	
Tech:	<u> Ron Gaytan </u>			Test #:	<u> CE-2 </u>		Lab:	<u> 3 </u> Photo ID: <u> 9L0025 CE-2 </u>	
Equipment Used:	<u> G2634-G2408-C21-G1605-G1705 </u>								
Configuration:	<u> Tx into 50 ohms </u>								
IF Bandwidth:	<u> 10 kHz </u>		Video Bandwidth:	<u> 10 kHz </u>		Detector:	<u> </u> Peak <u> X </u> CISPR		
Ambient Temperature:	<u> 23 </u> C		EUT Power:	<u> X </u> 115 V.A.C.		<u> X </u> 60 Hz	<u> X </u> 1 Phase		
Relative Humidity:	<u> 40 </u> %		<u> </u> 230 V.A.C.		<u> </u> 50 Hz	<u> </u> 3 Phase			
Atmospheric Pressure:	<u> 999 </u> mbar		<u> </u> Other <u> </u>						
Freq. (MHz)	Meter Reading (dBuV)	Attn. (dB)	Cable Loss (dB)	Probe Factor (dB)	Corrected Reading (dBuV)	Spec. limit (dBuV)	Pol.	Comments:	
0.507	40.5	0	0	0	40.5	48	H	(H= Hot Side of Line)	
0.608	42	0	0	0	42	48	H		
0.71	39.4	0	0	0	39.4	48	H		
1.014	43.7	0	0	0	43.7	48	H		
1.521	46	0	0	0	46	48	H		
2.737	43.3	0	0	0	43.3	48	H		
11.161	31.6	0	0	0	31.6	48	H		
18.368	26	0	0	0	26	48	H		
29.924	32.2	0	0	0	32.2	48	H		
0.507	52.6	0	0	0	52.6	48	N		
0.507	42	0	0	0	42	48	N	Average detector qualifies for	
507	39.6	0	0	0	39.6	48	N	13 dB relaxation	
0.608	51.1	0	0	0	51.1	48	N	Average detector qualifies for	
0.608	41.8	0	0	0	41.8	48	N	13 dB relaxation	
0.608	38.1	0	0	0	38.1	48	N		
0.709	44.6	0	0	0	44.6	48	N		
1.014	41.8	0	0	0	41.8	48	N		
1.519	43	0	0	0	43	48	N		
2.737	37.7	0	0	0	37.7	48	N		
11.156	31.6	0	0	0	31.6	48	N		
Note: Verify that the IF Bandwidth is in the proper setting.									

EQUIPMENT: 2400 Mobile Data Radio and 385700-4000-001 4 Port Line Amplifier
 FCC ID: _____

Powerline Conducted Emissions Test # CE-2 (Continued):

Complete <u> X </u>			Conducted Emissions Data		Page <u> 2 </u> of <u> 2 </u>	
Preliminary _____			(CISPR Quasi-Peak Detector)			
			FCC (CFR 47)			
Client: <u>Andrew Coporation</u>			W.O.#: <u>9L0025R</u>		Date: <u>12/20/99</u>	
EUT: <u>385700-4000-001</u>			S/N: <u>None</u>		Specification: <u>CFR47 part 15.207</u>	
Tech: <u>Ron Gaytan</u>			Test #: <u>CE-2</u>		Lab: <u>3</u> Photo ID: <u>9L0025 CE-2</u>	

Freq. (MHz)	Meter Reading (dBuV)	Attn. (dB)	Cable Loss (dB)	Probe Factor (dB)	Corrected Reading (dBuV)	CISPR Spec.limit (dBuV)	Pol.	Comments:
18.368	25.2	0	0	0	25.2	48	N	
29.924	31.6	0	0	0	31.6	48	N	
Scanned from 450 kHz to 30 MHz.								

Note: Verify that the IF Bandwidth is in the proper setting.

EQUIPMENT: 2400 Mobile Data Radio and 385700-4000-001 4 Port Line Amplifier

FCC ID:

Powerline Conducted Emissions Photographs

SIDE VIEW:



SIDE VIEW:

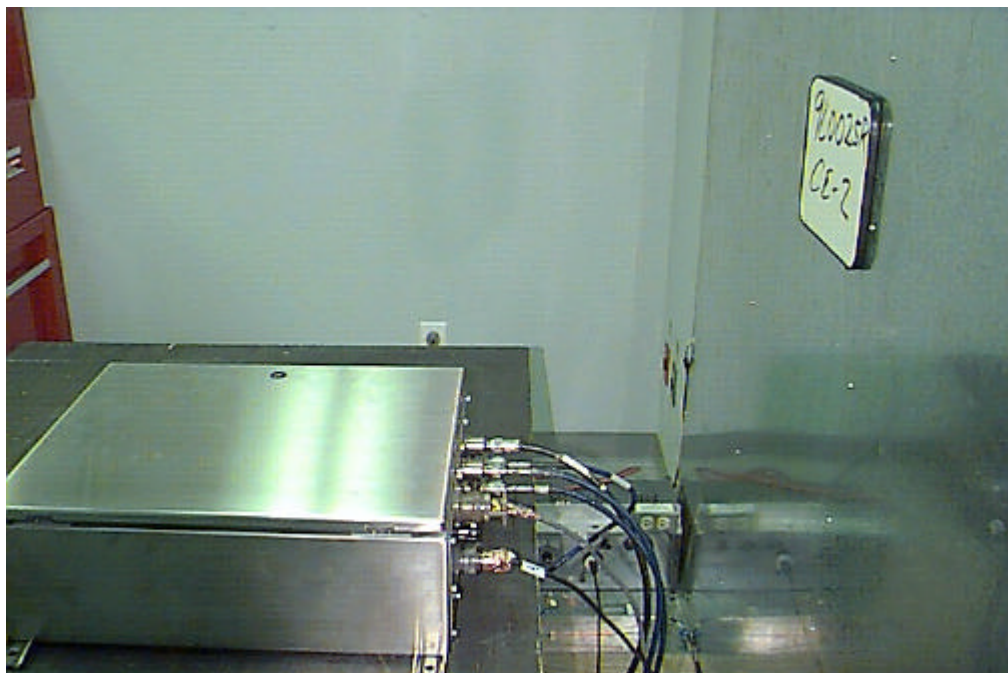

KTL Dallas, Inc.

FCC PART 15, SUBPART C
DIRECT SEQUENCE TRANSMITTERS
PROJECT NO.: 9L0022RUS

EQUIPMENT: 2400 Mobile Data Radio and 385700-4000-001 4 Port Line Amplifier

FCC ID:

Section 4. Occupied Bandwidth

NAME OF TEST: Occupied Bandwidth	PARA. NO.: 15.247(a)(2)
TESTED BY: Ron Gaytan Tom Tidwell / Debbie Jensen	DATE: 8/12/99

Test Results: Complies. The 6 dB bandwidth is 12.3246 MHz.

Measurement Data: See attached graph.

EQUIPMENT: 2400 Mobile Data Radio and 385700-4000-001 4 Port Line Amplifier

FCC ID:

Occupied Bandwidth:

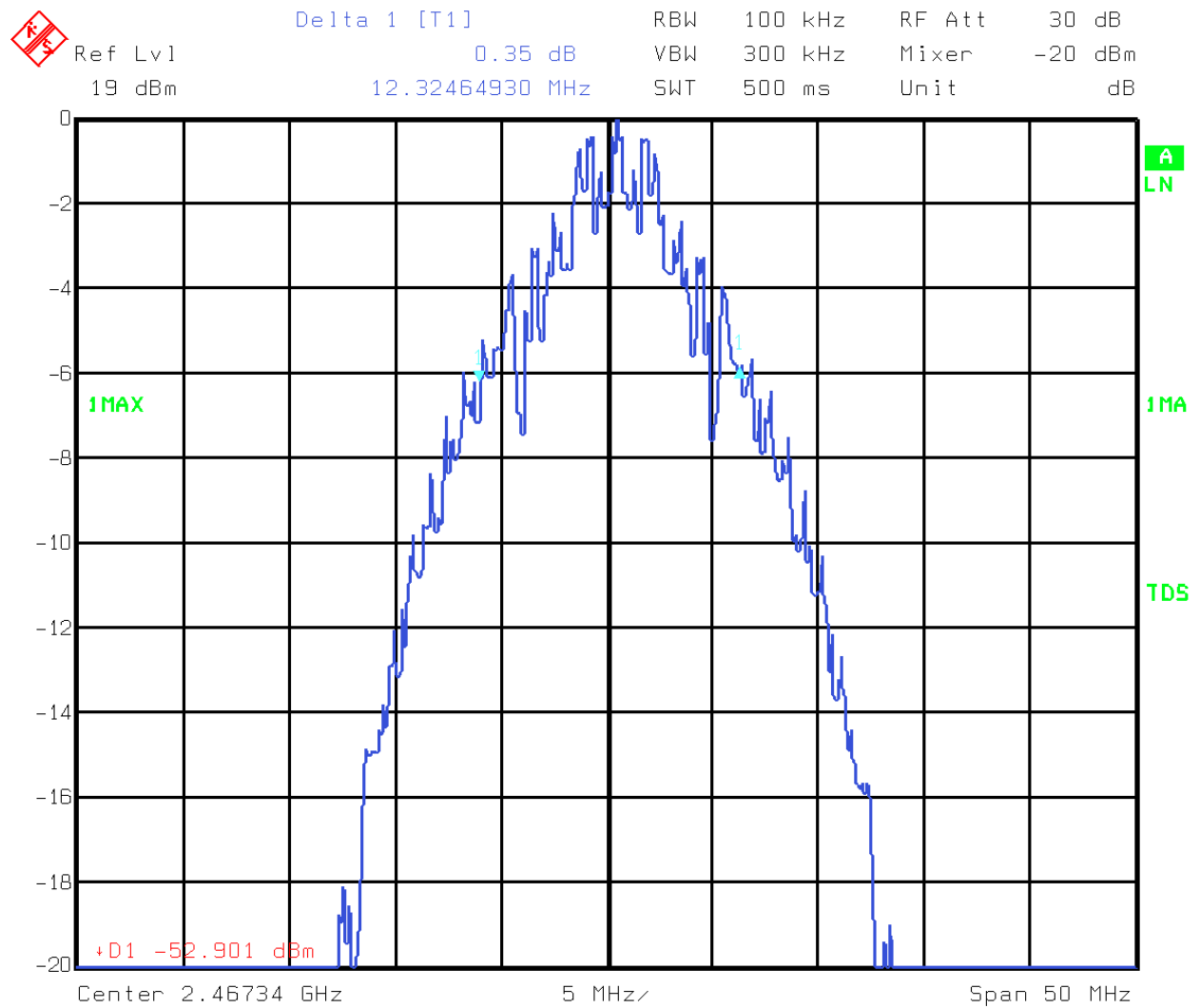

Title: Occupied Bandwidth
Date: 12.AUG.1999 14:02:22

EQUIPMENT: 2400 Mobile Data Radio and 385700-4000-001 4 Port Line Amplifier
FCC ID:

Section 5. Peak Power Output

NAME OF TEST: Peak Power Output	PARA. NO.: 15.247 (b)
TESTED BY: Ron Gaytan Tom Tidwell / Debbie Jensen	DATE: 8/10/99

Test Results:

Complies. The maximum peak power output of the transmitter is 1.00 watts The system is professionally installed and the installer is instructed to reduce the power output at the antenna port to +24 dBm when using the 12 dBi gain antenna.

Measurement Data:

Detachable antenna? Yes No

If yes, state the type of non-standard connector used at the antenna port: Type N female connector. The equipment is professionally installed in a specific application. The equipment is marketed to select users only.

Directional Gain of Antenna: 12 dBi or 15.8 Numeric.

Peak Power Output: 0.251watts.

Field Strength: 129.0 dB μ V/m @ 3m or 2.8 V/m @ 3m.

EQUIPMENT: 2400 Mobile Data Radio and 385700-4000-001 4 Port Line Amplifier
FCC ID: _____

Peak Power Output (Field Strength):

Microwave Radiated Emissions Data										
Complete <input checked="" type="checkbox"/>		Preliminary <input type="checkbox"/>				Page <u>1</u> of <u>1</u>				
Client: <u>Andrew Corporation</u>			Test #: <u>ERP-1</u>			W.O.#: <u>9L0022R</u>				
EUT: <u>2400 Mobile Transceiver</u>				S/N: <u>None</u>		Photo ID: <u>9L0022R</u>				
Technician: <u>Ron Gaytan</u>		Specification: <u>CFR 47 Part 15.247</u>			Lab: <u>ANC1</u>		Date: <u>8/13/99</u>			
Equipment Used: <u>G2626-G2200-CF31-G2034</u>										
Configuration: <u>Tx @ 24 dBm with 12 dBi ISM Panel Antenna</u>										
Bandwidth: <u>1 MHz</u>		Video Bandwidth: <u>1 MHz</u>		Antenna Distance: <u>3</u> m		Detector:				
Climatic Conditions:			EUT Power: <input checked="" type="checkbox"/> 115 V.A.C.			<input checked="" type="checkbox"/> 60 Hz		<input checked="" type="checkbox"/> Peak		
Temperature: <u>23</u> C					208 V.A.C.		<input type="checkbox"/> 50 Hz		<input type="checkbox"/> Average	
Relative Humidity: <u>38</u> %					230 V.A.C.					
Atmospheric Pressure: <u>998</u> mbar			<input type="checkbox"/> Other _____		<input type="checkbox"/> 1 Phase		<input type="checkbox"/> 3 Phase			
Freq. (MHz)	Meter Reading (dBm)	Antenna Factor (dB)	Cable Loss (dB)	RF Gain (dB)	Conver. Factor	Corrected Reading (dBuV/m)	ERP (mW)	ERP (dBm)	Pol.	Comments:
2.467	-28.2	28.4	3.1	0	107	110.3	32.15	15.07	H	
2.467	-9.5	28.4	3.1	0	107	129	2383	33.77	V	

EQUIPMENT: 2400 Mobile Data Radio and 385700-4000-001 4 Port Line Amplifier
FCC ID:

Section 6. Spurious Emissions (Antenna Conducted)

NAME OF TEST: Spurious Emissions (Antenna Conducted)	PARA. NO.: 15.247(c)
TESTED BY: Ron Gaytan Tom Tidwell / Debbie Jensen	DATE: 8/12/99, 10/26/99

Test Results: Complies. The worst-case emission level is -20.88 dBm at 6.8822 GHz. This is 7.88 dB below the specification limit.

Measurement Data: See attached graphs.

EQUIPMENT: 2400 Mobile Data Radio and 385700-4000-001 4 Port Line Amplifier
FCC ID:

Antenna Port Spurious Emissions:

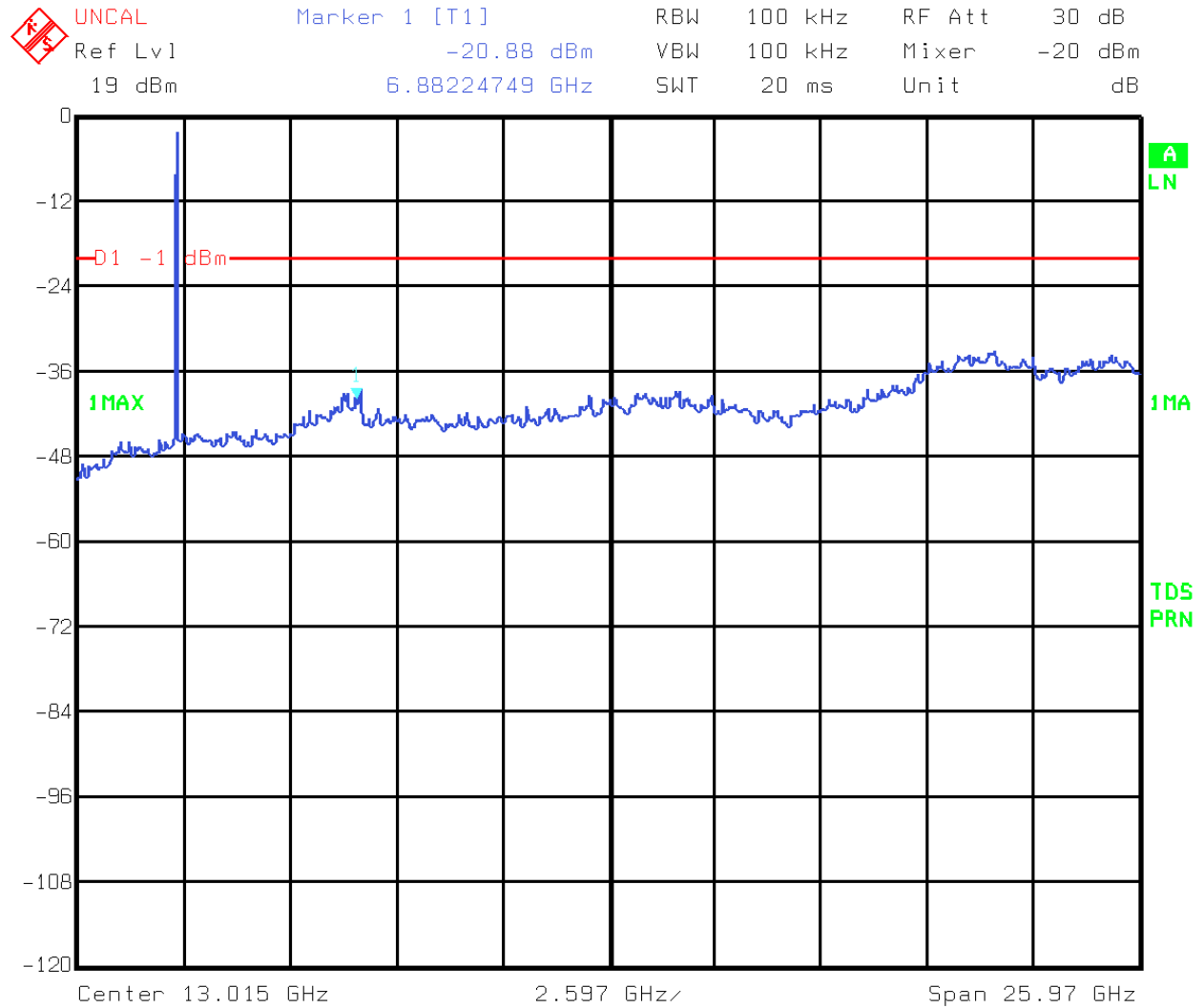

Title: Lower Band Edge
Date: 12.AUG.1999 14:43:02

EQUIPMENT: 2400 Mobile Data Radio and 385700-4000-001 4 Port Line Amplifier

FCC ID:

Lower Band Edge:

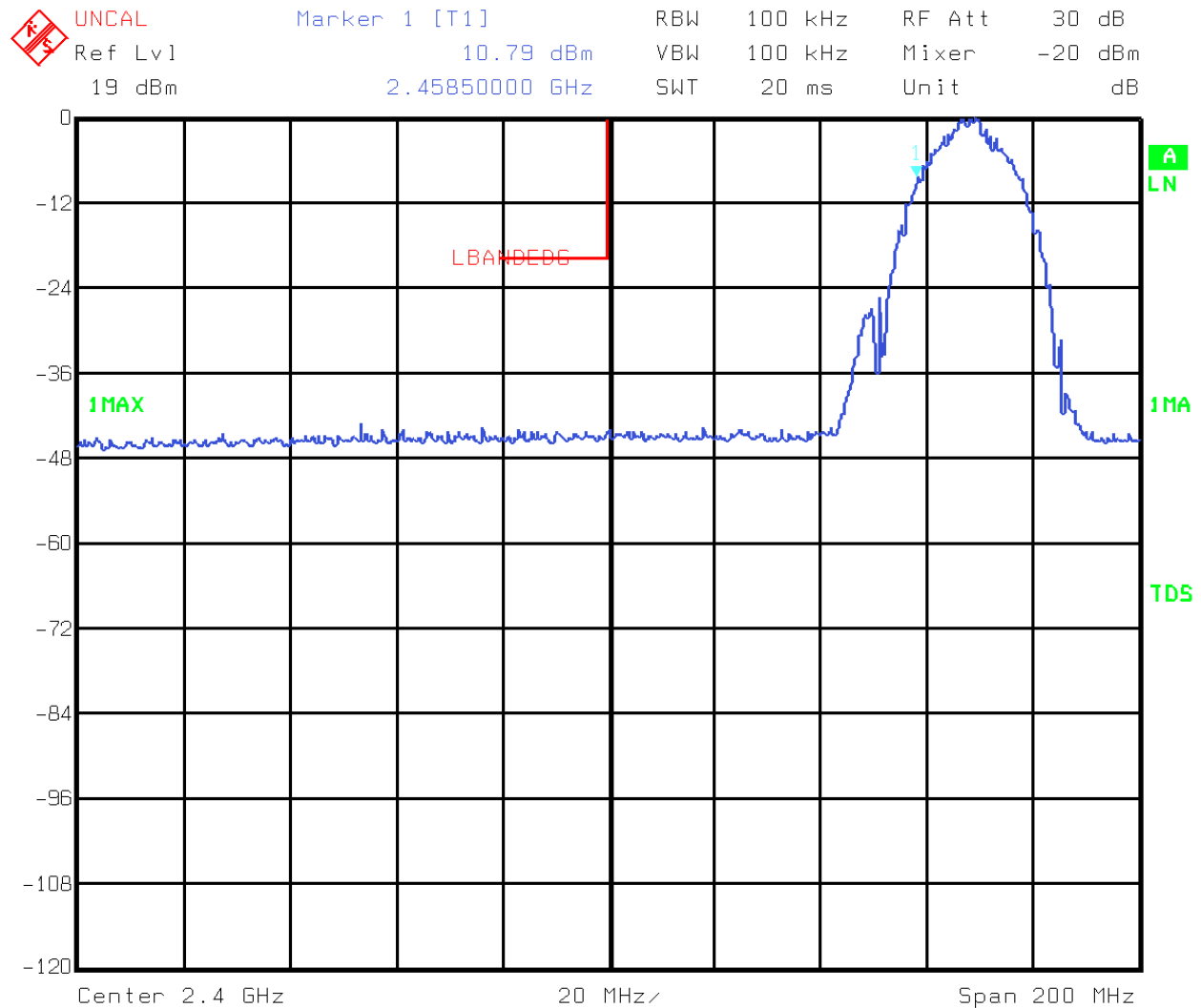

Title: Lower Band Edge
Date: 12.AUG.1999 14:39:53

EQUIPMENT: 2400 Mobile Data Radio and 385700-4000-001 4 Port Line Amplifier

FCC ID:

Upper Band Edge:

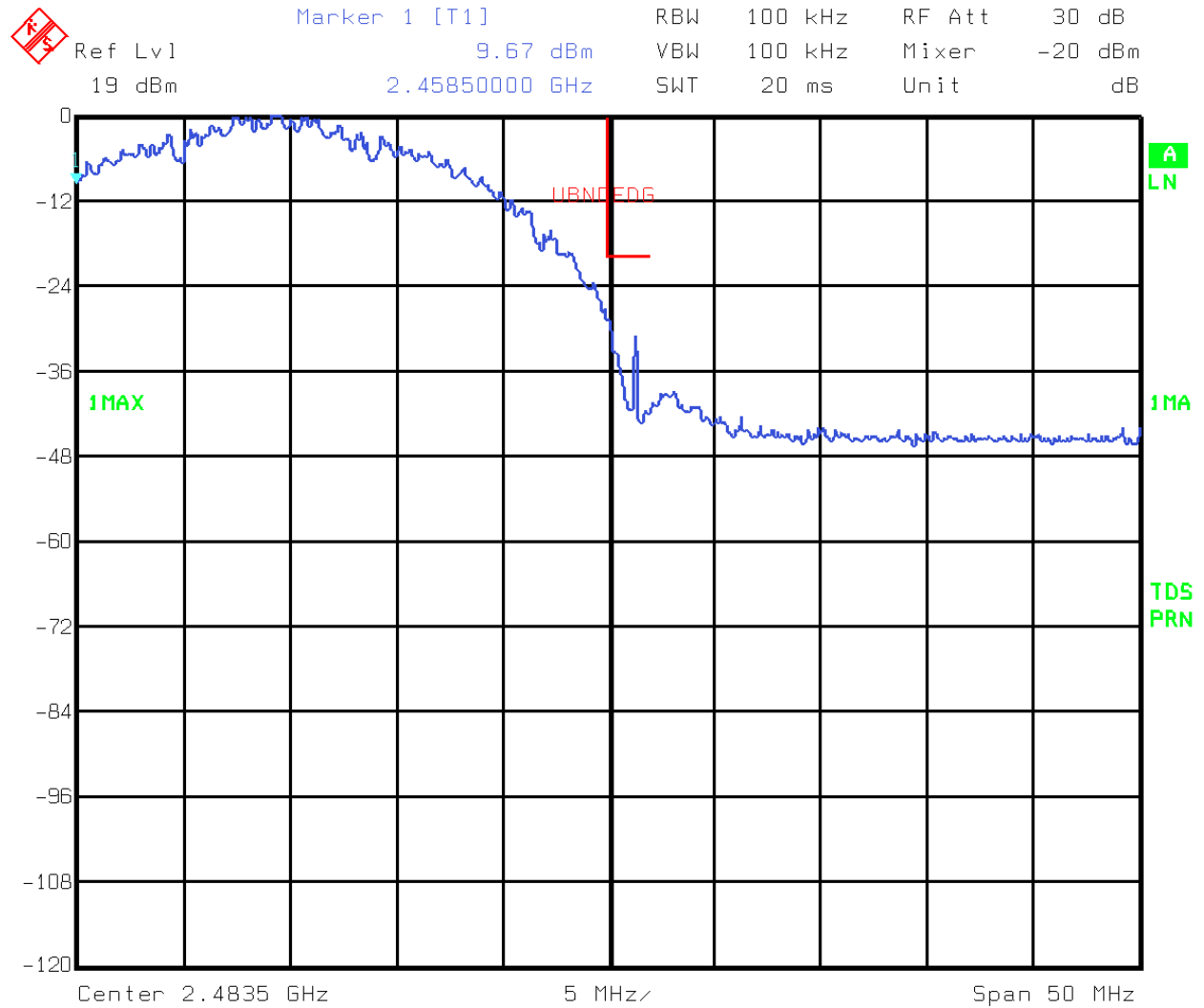

Title: Upper Band Edge
Date: 12.AUG.1999 14:35:25

EQUIPMENT: 2400 Mobile Data Radio and 385700-4000-001 4 Port Line Amplifier
FCC ID:

Base Station:

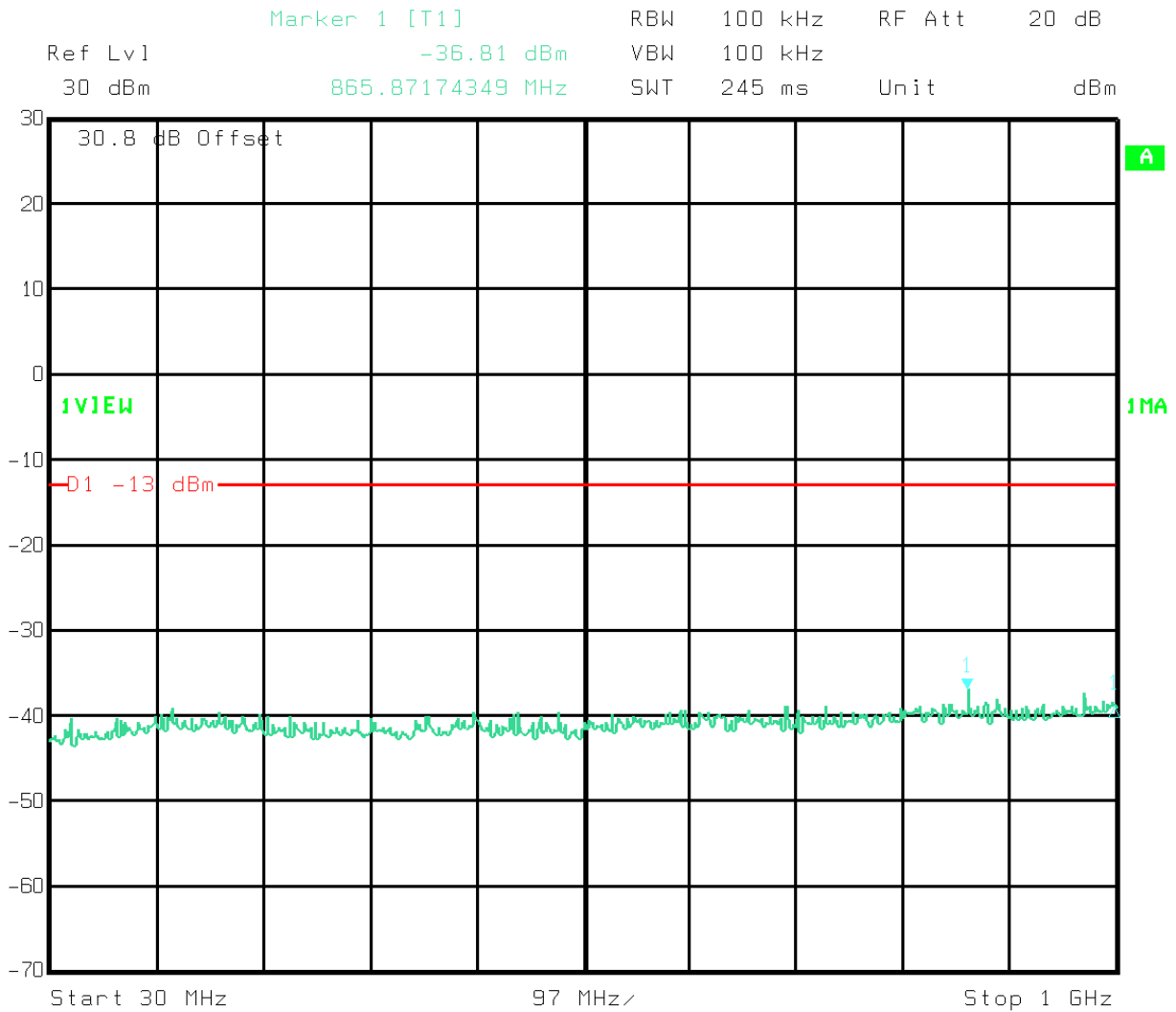

Title: Antenna Port Conducted (385700-4000-001)
Comment A: APSE1
Date: 26.OCT.1999 8:40:09

EQUIPMENT: 2400 Mobile Data Radio and 385700-4000-001 4 Port Line Amplifier

FCC ID:

Base Station:

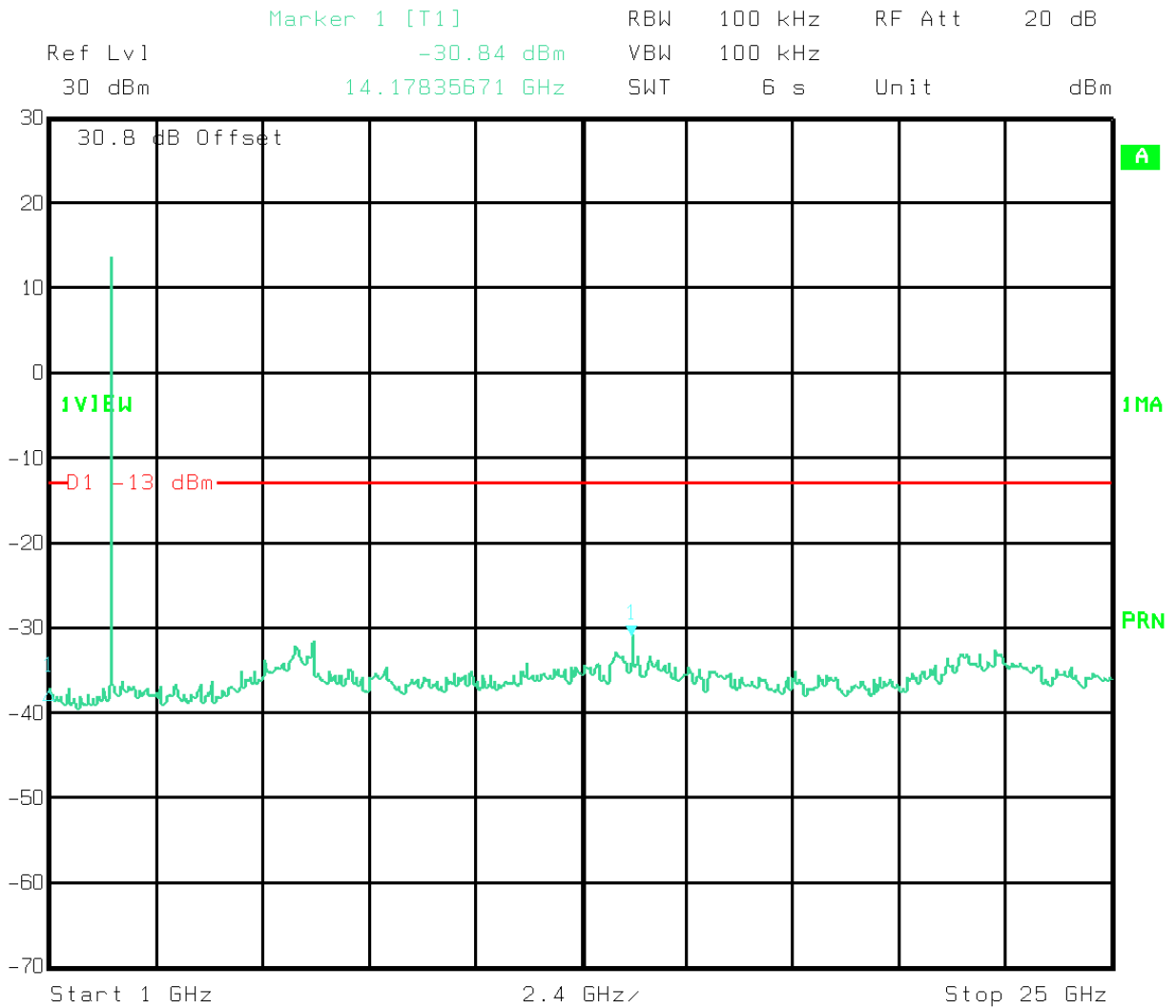

Title: Antenna Port Conducted (385700-4000-001)
Comment A: APSE2
Date: 26.OCT.1999 8:44:13

EQUIPMENT: 2400 Mobile Data Radio and 385700-4000-001 4 Port Line Amplifier
FCC ID:

Section 7. Spurious Emissions (Radiated)

NAME OF TEST: Spurious Emissions (Radiated)	PARA. NO.: 15.247(c)
TESTED BY: Ron Gaytan Tom Tidwell / Debbie Jensen	DATE: 8/17/99, 10/26-27/99

Test Results: Complies. The worst-case noise floor emission level is 61.3 dB μ V/m @ 3m at 4.935 GHz. This is 4.2 dB Below the specification limit.

Measurement Data: See attached graphs.

EQUIPMENT: 2400 Mobile Data Radio and 385700-4000-001 4 Port Line Amplifier
 FCC ID:

Test Data - Radiated Emissions (PEAK/AVERAGE):

Microwave Radiated Emissions Data								
Complete <input type="checkbox"/>		Preliminary <input checked="" type="checkbox"/>		Page <u>1</u> of <u>2</u>				
Client: <u>Andrew Corporation</u>			Test #: <u>MW-2</u>		W.O.#: <u>9L0022R</u>			
EUT: <u>2400 Mobile Transceiver</u>			S/N: <u>None</u>		Photo ID: <u>9L0022R MW-2</u>			
Technician: <u>Ron Gaytan</u>		Specification: <u>CFR 47 Part 15.247</u>			Lab: <u>ANC1</u>		Date: <u>8/12/99</u>	
Equipment Used: <u>G2626-CF31-G2200-G2034-934-677-G2235</u>								
Configuration: <u>Tx Mode</u>								
Bandwidth: <u>1 MHz</u>		Video Bandwidth: <u>1 MHz</u>		Antenna Distance <u>3</u> m		Detector:		
Climatic Conditions:			EUT Power: <input checked="" type="checkbox"/> 115 V.A.C.		<input checked="" type="checkbox"/> 60 Hz		<input checked="" type="checkbox"/> Peak	
Temperature: <u>23</u> C			<input type="checkbox"/> 208 V.A.C.		<input type="checkbox"/> 50 Hz		<input type="checkbox"/> Average	
Relative Humidity: <u>42</u> %			<input type="checkbox"/> 230 V.A.C.		<input type="checkbox"/>		<input type="checkbox"/>	
Atmospheric Pressure: <u>998</u> mbar			<input type="checkbox"/> Other		<input checked="" type="checkbox"/> 1 Phase		<input type="checkbox"/> 3 Phase	
Freq. (GHz)	Meter Reading (dBuV)	Antenna Factor (dB)	Cable Loss (dB)	RF Gain (dB)	Corrected Reading (dBuV/m)	Spec. Limit (dBuV/m)	Pol.	Comments:
2.468	63.3	28.4	3.1	31.8	63	N/A	V	Fundamental Freq.
2.276	54.1	28.2	3.0	31.9	53.4	54	V	Refer to Average Det.
2.276	52.1	28.2	3.0	31.9	51.4	54	V	Average Detector
4.935	47.2	33.2	4.6	29.5	55.5	54	V	Refer to Average Det.
4.935	41.5	33.2	4.6	29.5	49.8	54	V	Average Detector
7.401	37.6	36.1	5.8	34.2	45.3	109	V	Avg. Det. Noise Floor
9.869	38.1	37.6	6.9	33.3	49.3	109	V	Avg. Det. Noise Floor
12.336	37.3	39	8.0	32.8	51.5	54	V	Avg. Det. Noise Floor
								KTL # 677
12.336	5	39	8.0	32.8	19.2	54	V	Avg. Det. Noise Floor
14.803	39.3	42.0	8.7	30.7	59.3	109	V	Avg. Det. Noise Floor
17.27	39.3	44.2	9.6	31.3	61.8	109	V	Avg. Det. Noise Floor
2.468	54.5	28.4	3.1	31.8	54.2	N/A	H	Fundamental Freq.
2.276	51.9	28.2	3.0	31.9	51.2	54	H	Refer to Average Det.
2.276	49.5	28.2	3.0	31.9	48.8	54	H	Average Detector
4.935	44.3	33.2	4.6	29.5	52.6	54	H	Refer to Average Det.
4.935	37.4	33.2	4.6	29.5	45.7	54	H	Average Detector
7.401	37.6	36.1	5.8	34.2	45.3	109	H	Avg. Det. Noise Floor
9.869	38.1	37.6	6.9	33.3	49.3	109	H	Avg. Det. Noise Floor
DATACOMMON\FORMS\TESTDATASHEETS\MICRORE REV 030597								

EQUIPMENT: 2400 Mobile Data Radio and 385700-4000-001 4 Port Line Amplifier
 FCC ID: _____

Test Data - Radiated Emissions (PEAK/AVERAGE) (Continued):

Microwave Radiated Emissions Data								
Continuation Page								
Complete <input checked="" type="checkbox"/>		Preliminary <input type="checkbox"/>		Page <u>2</u> of <u>2</u>				
Client: <u>Andrew Corporation</u>				Test #: <u>MW-2</u>		W.O.#: <u>9L0022R</u>		
EUT: <u>2400 Mobile Transceiver</u>				S/N: <u>None</u>		Photo ID: <u>9L0022R MW-2</u>		
Technician: <u>Ron Gaytan</u>			Specification: <u>CFR 47 Part 15.247</u>		Lab: <u>ANC1</u>	Date: <u>8/13/99</u>		
Freq. (GHz)	Meter Reading (dBm)	Antenna Factor (dB)	Cable Loss (dB)	RF Gain (dB)	Corrected Reading (dBuV/m)	Spec. Limit (dBuV/m)	Pol.	Comments:
12.336	37.3	39	8.0	32.8	51.5	54	H	Avg. Det. Noise Floor
								KTL # 677
12.336	5	39	8.0	32.8	19.2	54	H	Avg. Det. Noise Floor
14.803	39.3	42.0	8.7	30.7	59.3	109	H	Avg. Det. Noise Floor
17.27	39.3	44.2	9.6	31.3	61.8	109	H	Avg. Det. Noise Floor
								Scanned 1 GHz to 25 GHz

EQUIPMENT: 2400 Mobile Data Radio and 385700-4000-001 4 Port Line Amplifier

FCC ID:

Radiated Photographs (Worst Case Configuration):

FRONT VIEW:

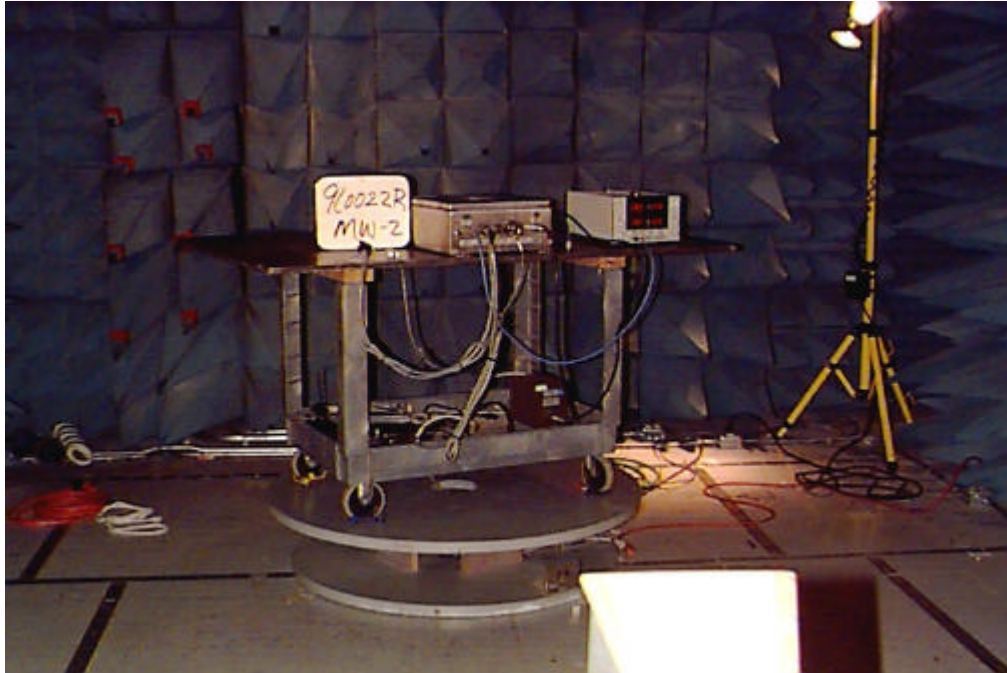

FRONT VIEW:



EQUIPMENT: 2400 Mobile Data Radio and 385700-4000-001 4 Port Line Amplifier

FCC ID:

Test Data - Microwave Radiated Emissions (MW-2):

Microwave Radiated Emissions Data									
Complete <input type="checkbox"/>		Preliminary <input checked="" type="checkbox"/>				Page <u>1</u> of <u>1</u>			
Client: <u>Andrew Corporation</u>				Test #: <u>MW-2</u>		W.O.#: <u>9L0025R</u>			
EUT: <u>385700-4000-001</u>				S/N: <u>None</u>		Photo ID: <u>9L0025R</u>			
Technician: <u>Ron Gaytan</u>		Specification: <u>CFR 47 Part 15.247</u>			Lab: <u>D OATS</u>		Date: <u>10/26/99</u>		
Equipment Used: <u>677-G2016-CF31-EM2200</u>									
Configuration: <u>TX MAX POWER</u>									
Bandwidth: <u>1 MHz</u>		Video Bandwidth: <u>1 MHz</u>		Antenna Distance <u>3</u> m		Detector:			
Climatic Conditions:		EUT Power: <input checked="" type="checkbox"/> 115 V.A.C.		<input checked="" type="checkbox"/> 60 Hz		<input checked="" type="checkbox"/> Peak			
Temperature: <u>19</u> C		<input type="checkbox"/> 208 V.A.C.		<input type="checkbox"/> 50 Hz		<input type="checkbox"/> Average			
Relative Humidity: <u>42</u> %		<input type="checkbox"/> 230 V.A.C.		<input type="checkbox"/>		<input type="checkbox"/>			
Atmospheric Pressure: <u>998</u> mbar		<input type="checkbox"/> Other <input type="checkbox"/>		<input type="checkbox"/> 1 Phase		<input type="checkbox"/> 3 Phase			
Freq. (MHz)	Meter Reading (dBuV)	Antenna Factor (dB)	Cable Loss (dB)	RF Gain (dB)	Conver. Factor	Corrected Reading (dBuV/m)	Spec. limit (dBuV/m)	Pol.	Comments:
2.421	51	27.6	3.1	0	0	81.7	N/A	V	
4.805	11.4	34	4.6	0	0	50	54	V	
4.835	19	34	4.6	0	0	57.6	54	V	
4.835	8	34	4.6	0	0	46.6	54	V	Average Det.
7.248	7	37.2	5.7	0	0	49.9	67.7	V	Avg Det. N.F
12.08	4	39.6	8.0	33.5	0	18.1	54	V	Avg Det. N.F
2.421	62	27.6	3.1	0	0	92.7	N/A	H	
4.805	11.4	34	4.6	0	0	50	54	H	
4.835	13	34	4.6	0	0	51.6	54	H	
4.835	2	34	4.6	0	0	40.6	54	H	Average Det.
7.248	7	37.2	5.7	0	0	49.9	67.7	H	Avg Det. N.F
12.08	4	39.6	8.0	33.5	0	18.1	54	H	Avg Det. N.F
									Scanned 1-18 GHz
DATACOMMONFORMSITESTDATASHEETSIMICRORE REV 030597									

EQUIPMENT: 2400 Mobile Data Radio and 385700-4000-001 4 Port Line Amplifier

FCC ID:

Microwave Radiated Emissions Photographs:

SIDE VIEW:



SIDE VIEW:



EQUIPMENT: 2400 Mobile Data Radio and 385700-4000-001 4 Port Line Amplifier
 FCC ID: _____

Test Data - Microwave Radiated Emissions (MW-3):

Microwave Radiated Emissions Data									
Complete <input checked="" type="checkbox"/>		Preliminary <input type="checkbox"/>			Page <u>1</u> of <u>1</u>				
Client: <u>Andrew Corporation</u>				Test #: <u>MW-3</u>		W.O.#: <u>9L0024R</u>			
EUT: <u>385700-4000-001</u>				S/N: <u>None</u>		Photo ID: <u>9L0024R MW-3</u>			
Technician: <u>Ron Gaytan</u>			Specification: <u>CFR 47 Part 15.247</u>		Lab: <u>A OATS</u>		Date: <u>10/27/99</u>		
Equipment Used: <u>677-2023-CF31</u>									
Configuration: <u>Tx Max Power (Low Channel)</u>									
Bandwidth: <u>1 MHz</u>		Video Bandwidth: <u>1 MHz</u>		Antenna Distance <u>3</u> m		Detector:			
Climatic Conditions:		EUT Power: <input checked="" type="checkbox"/> 115 V.A.C.		<input checked="" type="checkbox"/> 60 Hz		<input checked="" type="checkbox"/> Peak			
Temperature: <u>22</u> C		<input type="checkbox"/> 208 V.A.C.		<input type="checkbox"/> 50 Hz		<input type="checkbox"/> Average			
Relative Humidity: <u>42</u> %		<input type="checkbox"/> 230 V.A.C.		<input type="checkbox"/> Other _____		<input type="checkbox"/> 1 Phase		<input type="checkbox"/> 3 Phase	
Atmospheric Pressure: <u>998</u> mbar									
Freq. (GHz)	Meter Reading (dBuV)	Antenna Factor (dB)	Cable Loss (dB)	RF Gain (dB)	Conver. Factor	Corrected Reading (dBuV/m)	Spec. Limit (dBuV/m)	Pol.	Comments:
2.421	84	27.6	3.1	0	0	115	N/A	V	Fundamental
4.835	16	34	4.6	0	0	54.6	54	V	
4.835	4	34	4.6	0	0	42.6	54	V	Average Det.
7.248	7	37.2	5.7	0	0	49.9	67.7	V	Avg Det. N.F
12.08	4	39.6	8.0	0	0	51.6	54.0	V	Avg Det. N.F
2.421	104	27.6	3.1	0	0	135	N/A	H	Fundamental
4.835	16	34	4.6	0	0	54.6	54	H	
4.835	2	34	4.6	0	0	40.6	54	H	Average Det.
7.248	7	37.2	5.7	0	0	49.9	67.7	H	Avg Det. N.F
12.08	4	39.6	8.0	0	0	51.6	54.0	H	Avg Det. N.F
									Scanned 1-18 GHz

EQUIPMENT: 2400 Mobile Data Radio and 385700-4000-001 4 Port Line Amplifier

FCC ID:

Microwave Radiated Emissions Photographs:

FRONT VIEW:



SIDE VIEW:

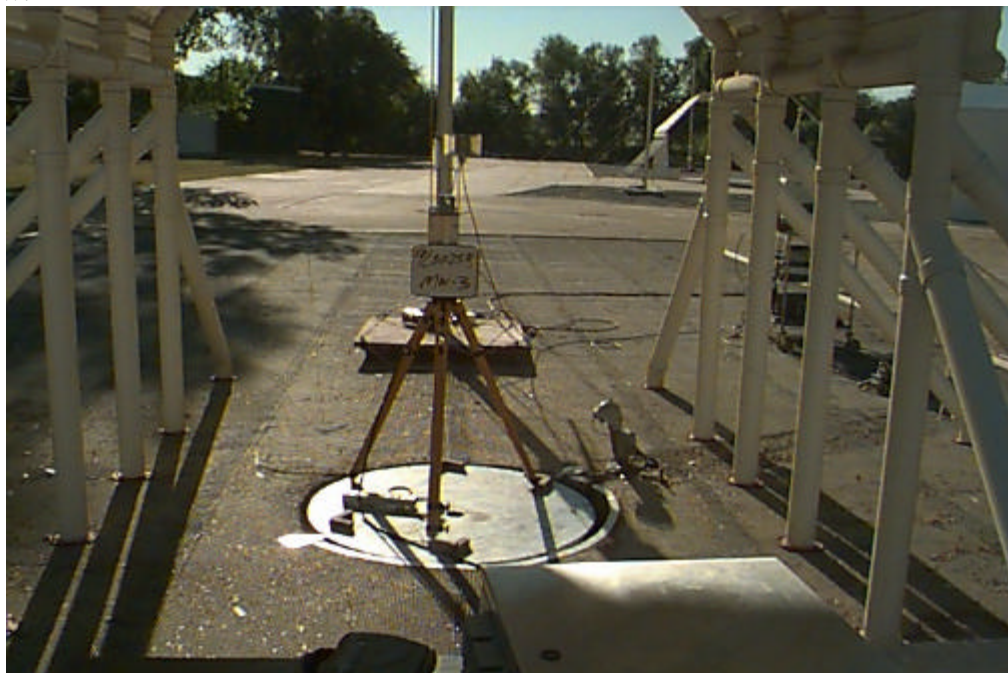

KTL Dallas, Inc.

FCC PART 15, SUBPART C
DIRECT SEQUENCE TRANSMITTERS
PROJECT NO.: 9L0022RUS

EQUIPMENT: 2400 Mobile Data Radio and 385700-4000-001 4 Port Line Amplifier

FCC ID:

Section 8. Transmitter Power Density

NAME OF TEST: Transmitter Power Density	PARA. NO.: 15.247(d)
TESTED BY: Ron Gaytan Tom Tidwell / Debbie Jensen	DATE: 8/13/99, 10/26/99

Test Results: Complies.

Measurement Data: See attached graphs.

EQUIPMENT: 2400 Mobile Data Radio and 385700-4000-001 4 Port Line Amplifier
FCC ID:

Power Spectral Density Data:

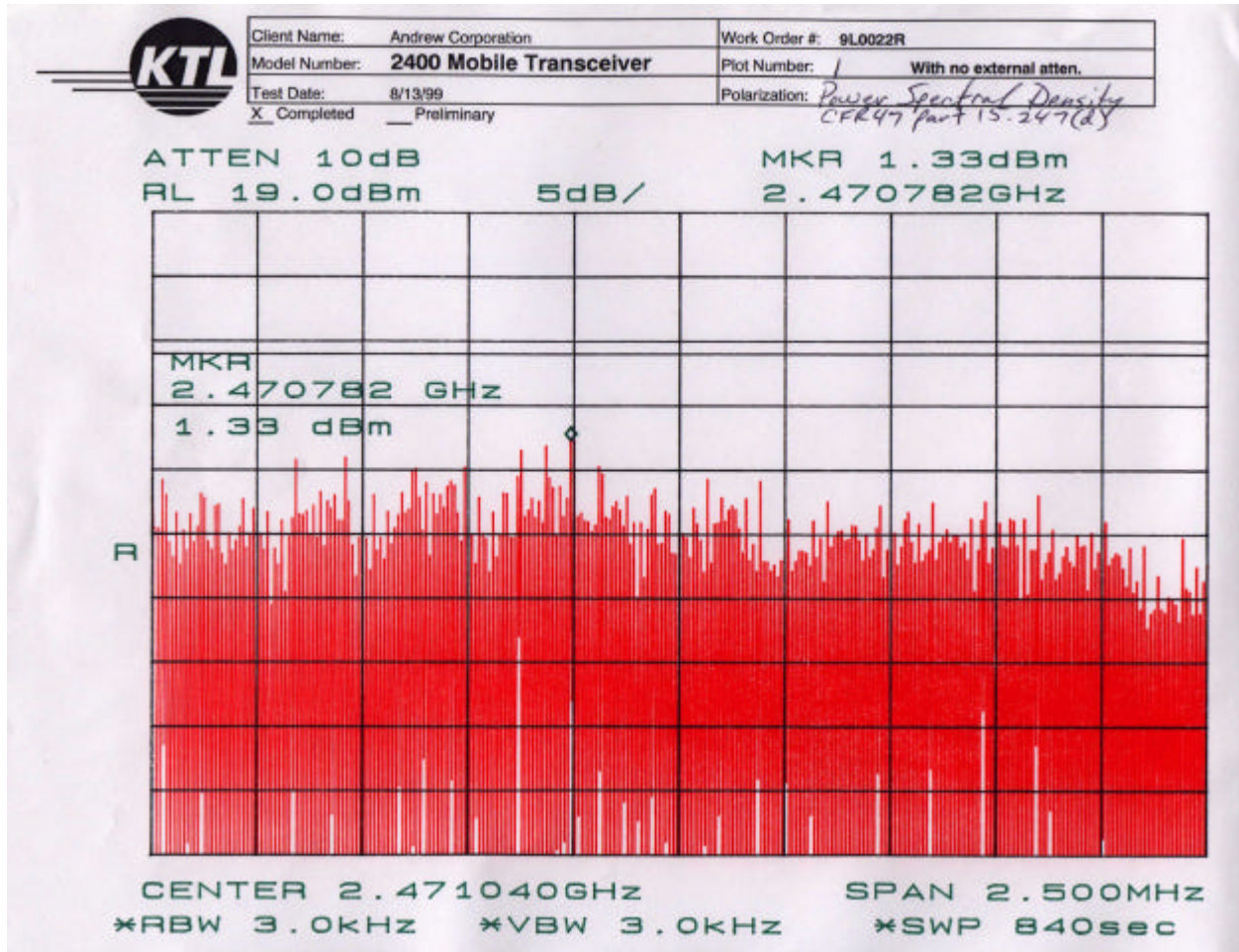

EQUIPMENT: 2400 Mobile Data Radio and 385700-4000-001 4 Port Line Amplifier
FCC ID:

Base Station:

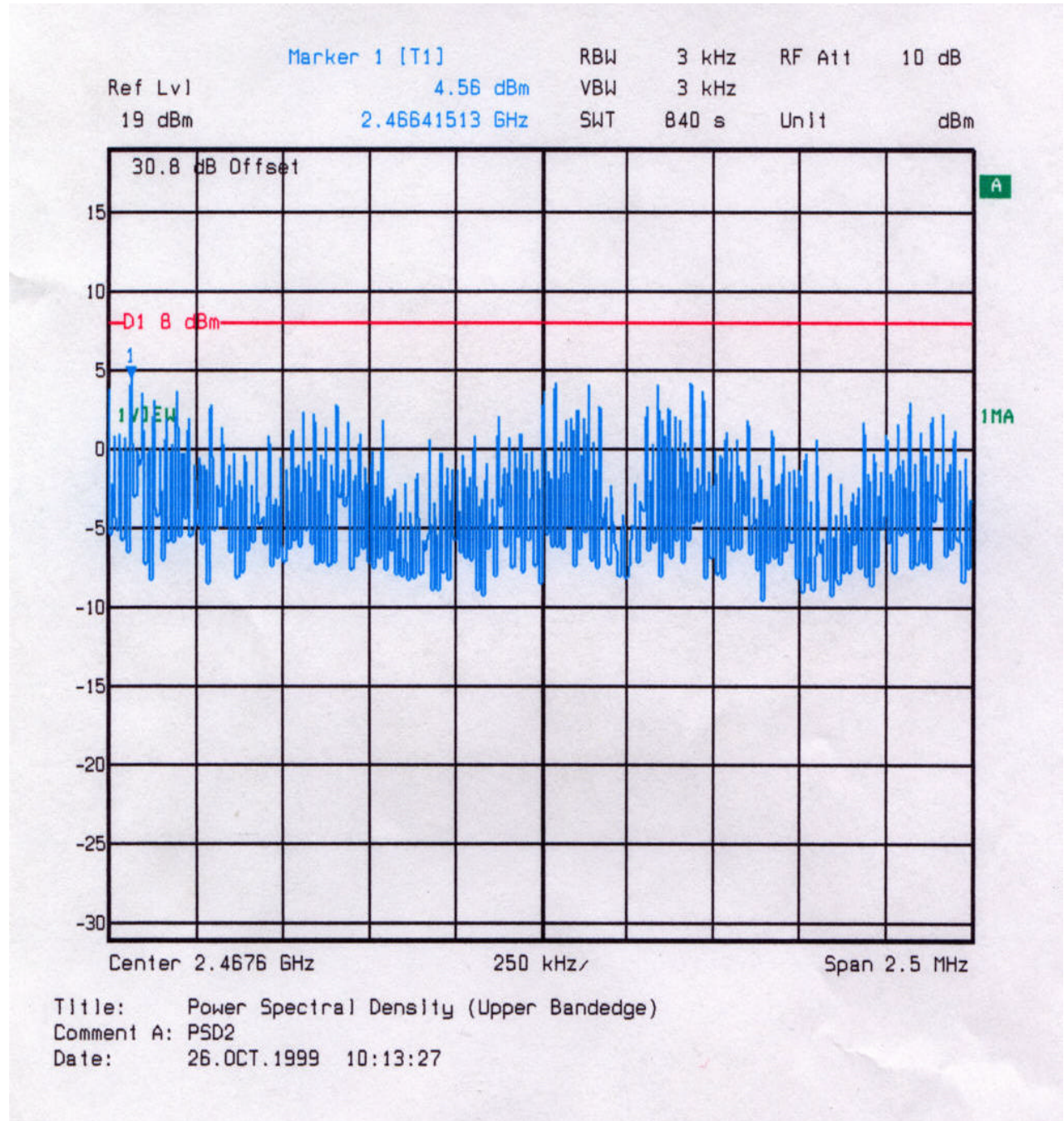

EQUIPMENT: 2400 Mobile Data Radio and 385700-4000-001 4 Port Line Amplifier
FCC ID:

Section 9. Processing Gain

NAME OF TEST: Processing Gain	PARA. NO.: 15.247(e)
TESTED BY: Ron Gaytan Tom Tidwell / Debbie Jensen	DATE: 8/13/99

Test Results: Complies. The processing gain of the system is 15.9 dB.

Measurement Data: See attached data.

1st graph is the RF output from the base transmitter

2nd graph is plot of the IF spectrum measured at the output of the correlator.

$G_p = 10 \text{ Log}(\text{RF bandwidth}/\text{De-correlated BW})$

$G_p = 10 \text{ Log}(14.36/.373)$

$G_p = 15.85 \text{ dB}$

EQUIPMENT: 2400 Mobile Data Radio and 385700-4000-001 4 Port Line Amplifier

FCC ID:

Processing Gain Data (Base RF Out):

	Delta 1 [T1]	RBW	100 kHz	RF Att	10 dB	
	Ref Lvl	0.33 dB	VBW	10 kHz	Mixer	-20 dBm
	-9.5 dBm	-14.36472946 MHz	SWT	160 ms	Unit	dB

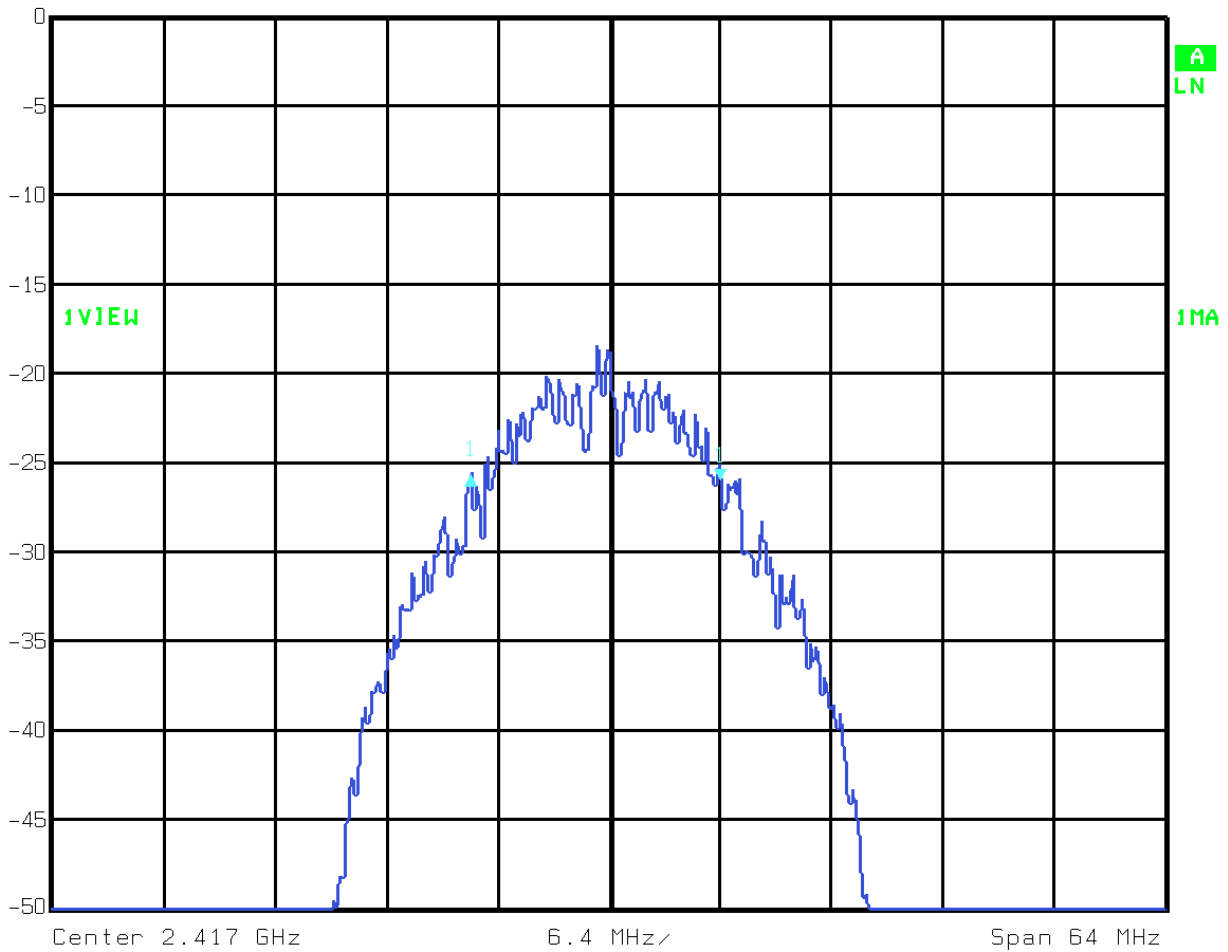

Title: 6 dB BW of Transmitted Signal (Base RF Out)
Date: 13.AUG.1999 11:13:30

EQUIPMENT: 2400 Mobile Data Radio and 385700-4000-001 4 Port Line Amplifier

FCC ID:

Processing Gain Data (Mobile IF):

	Delta 1 [T3]	RBW	100 kHz	RF Att	10 dB	
	Ref Lvl	0.29 dB	VBW	10 kHz	Mixer	-20 dBm
	-4.5 dBm	372.74549098 kHz	SWT	5 ms	Unit	dB

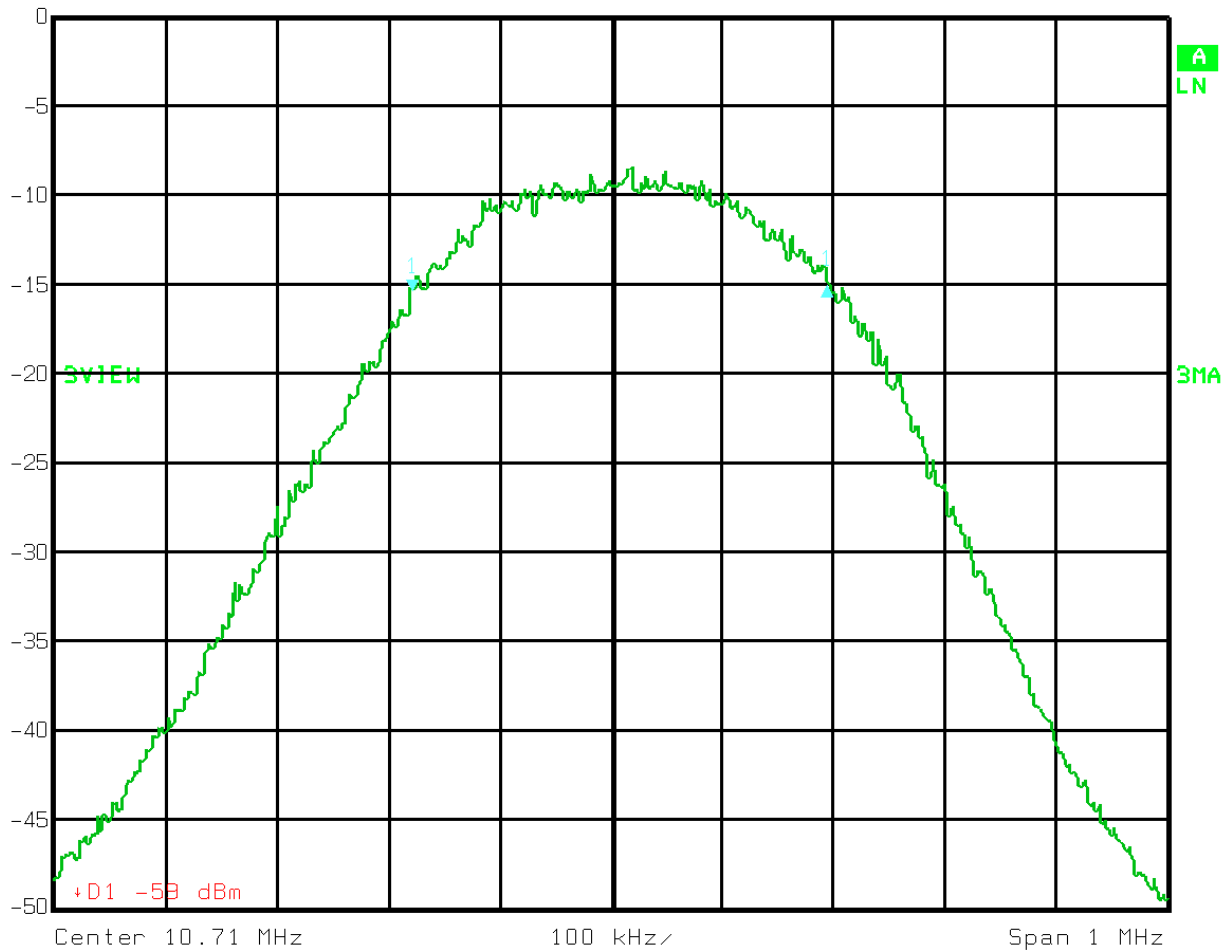

Title: 6 dB BW of De-Correlated Signal (Mobile IF)
Date: 13.AUG.1999 10:59:59

EQUIPMENT: 2400 Mobile Data Radio and 385700-4000-001 4 Port Line Amplifier

FCC ID:

Section 10. Test Equipment List

<u>KTL ID</u>	<u>Description</u>	<u>Manufacturer Model Number</u>	<u>Serial Number</u>	<u>Calibration Date</u>
CF31	Cable, 7.6m	KTL Semi-Flex, Storm	N/A	01/29/99
677	RECEIVER, 1-18 GHz	ELECTRO METRICS EMC 50	185	08/26/98
934	HORN ANTENNA (18-26.5GHZ)	EMCO 3160-09	9705-1079	08/13/97
G2034	ANTENNA-HORN	ELECTRO METRICS RGA-60	6174	06/28/99
G2200	AMPLIFIER	HEWLETT PACKARD 8449A	2749A00159	06/11/99
G2626	SPECTRUM ANALYZER	HEWLETT PACKARD 8566B	2618A02843	04/21/99
	Anchoic Chamber #1			

Calibration interval on all items is typically 12 months from the calibration date shown. Where relevant, measuring equipment is subjected to in-service checks between testing. Should any measurement equipment be utilized beyond its scheduled calibration date, the measurement equipment is subjected to in-service checks prior to use. TKL shall notify clients promptly, in writing, of identification of defective measuring equipment that casts doubt on the validity of results in this report.

LEGEND:

- CNR CALIBRATION NOT REQUIRED
- N/A NOT APPLICABLE
- CBU CALIBRATED BEFORE USE

KTL Dallas, Inc.

FCC PART 15, SUBPART C
DIRECT SEQUENCE TRANSMITTERS
PROJECT NO.: 9L0022RUS
ANNEX A

EQUIPMENT: Mobile Data Radio and 385700-4000-001 4 Port Line Amplifier
FCC ID:

ANNEX A
TEST METHODOLOGIES

KTL Dallas, Inc.

FCC PART 15, SUBPART C
DIRECT SEQUENCE TRANSMITTERS
PROJECT NO.: 9L0022RUS
ANNEX A

EQUIPMENT: Mobile Data Radio and 385700-4000-001 4 Port Line Amplifier
FCC ID:

NAME OF TEST: Powerline Conducted Emissions

PARA. NO.: 15.207(a)

Minimum Standard:

The R.F. that is conducted back onto the AC power line on any frequency within the band 0.45 to 30 MHz shall not exceed 250 μ V (48 dB μ V) across 50 ohms.

EQUIPMENT: Mobile Data Radio and 385700-4000-001 4 Port Line Amplifier
FCC ID:

NAME OF TEST: Occupied Bandwidth	PARA. NO.: 15.247(a)(2)
----------------------------------	-------------------------

Minimum Standard: The minimum bandwidth shall be at least 500 kHz.

Method Of Measurement:

The spectrum analyzer is set as follows:

- RBW: 100 kHz
- VBW: 100 kHz
- Span: >RBW
- LOG dB/div.: 2 dB
- Sweep: Auto

Number of channels tested:

Tuning Range	Number Of Channels Tested	Channel Location In Band
1 MHz or Less	1	Middle
1 to 10 MHz	2	Top And Bottom
More Than 10 MHz	3	Top, Middle, Bottom

EQUIPMENT: Mobile Data Radio and 385700-4000-001 4 Port Line Amplifier
 FCC ID: _____

NAME OF TEST: Peak Power Output	PARA. NO.: 15.247(b)
---------------------------------	----------------------

Minimum Standard: The maximum peak power output shall not exceed 1 watt.
 If transmitting antennas of directional gain greater than 6 dBi are used, the power shall be reduced by the amount in dB that the directional gain of the antenna exceeds 6 dBi.

Systems operating in the 2400-2483.5 Mhz band that are used exclusively for fixed, point-to-point operations may employ transmitting antennas with directional gain greater than 6 dBi provided the maximum peak output of the intentional radiator is reduced by 1 dB for every 3 dB that the directional gain of the antenna exceeds 6 dBi.

Direct Measurement Method For Detachable Antennas:

If the antenna is detachable, a peak power meter is used to measure the power output with the transmitter operating into a 50 ohm load.

Calculation Of EIRP For Integral Antenna:

If the antenna is not detachable from the circuit then the Peak Power Output is derived from the peak radiated field strength of the fundamental emission by using the plane wave relation $GP/4\pi R^2 = E^2/120\pi$ and proceeding as follows:

$$P = \frac{E^2 R^2}{30G} = \frac{E^2 3^2}{30G}$$

where,

P = the equivalent isotropic radiated power in watts

E = the maximum measured field strength in V/m

R = the measurement range (3 meters)

G = the numeric gain of the transmit antenna in relation to an isotropic radiator

The RBW of the spectrum analyzer shall be set to a value greater than the measured 6 dB occupied bandwidth of the E.U.T.

Number of channels tested:

Tuning Range	Number Of Channels Tested	Channel Location In Band
1 MHz or Less	1	Middle
1 to 10 MHz	2	Top And Bottom
More Than 10 MHz	3	Top, Middle, Bottom

EQUIPMENT: Mobile Data Radio and 385700-4000-001 4 Port Line Amplifier
 FCC ID: _____

NAME OF TEST: Spurious Emissions at Antenna Terminal	PARA. NO.: 15.247(c)
--	----------------------

Minimum Standard: In any 100kHz bandwidth outside the 2400-2483.5 MHz bands emissions shall be at least 20 dB below the fundamental emission or shall not exceed the following field strength limits. Emissions falling in the restricted bands of 15.205 shall not exceed the following field strength limits:

Frequency (MHz)	Field Strength (mV/m @ 3m)	Field Strength (dB @ 3m)
30 - 88	100	40.0
88 - 216	150	43.5
216 - 960	200	46.0
Above 960	500	54.0

The spectrum was searched to the 10th harmonic.

Method Of Measurement:

Upper Band Edge

RBW: At least 1% of span/div.
 VBW: >RBW
 Span: As necessary to display any spurious at band edge.
 Sweep: Auto
 Center Frequency: 2483.5 MHz
 Marker: Peak of fundamental emission
 Marker Δ: Peak of highest spurious level above 928 MHz

Lower Band Edge

RBW: At least 1% of span/div.
 VBW: >RBW
 Span: As necessary to display any spurious at band edge.
 Sweep: Auto
 Center Frequency: 2400 MHz
 Marker: Peak of fundamental emission
 Marker Δ: Peak of highest spurious level below 902 MHz

30 MHz - 10th Harmonic Plot

RBW: 100 kHz
 VBW: 300 kHz
 Sweep: Auto
 Display line: -20 dBc

Number of channels tested:

Tuning Range	Number Of Channels Tested	Channel Location In Band
1 MHz or Less	1	Middle
1 to 10 MHz	2	Top And Bottom
More Than 10 MHz	3	Top, Middle, Bottom

EQUIPMENT: Mobile Data Radio and 385700-4000-001 4 Port Line Amplifier
 FCC ID:

NAME OF TEST: Radiated Spurious Emissions	PARA. NO.: 15.247(c)
---	----------------------

Minimum Standard: In any 100kHz bandwidth outside the 2400-2483.5 MHz bands emissions shall be at least 20 dB below the fundamental emission or shall not exceed the following field strength limits. *Emissions falling in the restricted bands of 15.205 shall not exceed the following field strength limits:*

Frequency (MHz)	Field Strength (mV/m @ 3m)	Field Strength (dB @ 3m)
30 - 88	100	40.0
88 - 216	150	43.5
216 - 960	200	46.0
Above 960	500	54.0

The spectrum was searched to the 10th harmonic.

15.205 Restricted Bands

MHz	MHz	MHz	GHz
0.09-0.11	16.42-16.423	399.9-410	4.5-5.25
0.495-0.505	16.69475-16.69525	608-614	5.35-5.46
2.1735-2.1905	16.80425-16.80475	960-1240	7.25-7.75
4.125-4.128	25.5-25.67	1300-1427	8.025-8.5
4.17725-4.17775	37.5-38.25	1435-1626.5	9.0-9.2
4.20725-4.20775	73-74.6	1645.5-1646.5	9.3-9.5
6.125-6.218	74.8-75.2	1660-1710	10.6-12.7
6.26775-6.26825	108-121.94	1718.8-1722.2	13.25-13.4
6.31175-6.31225	123-138	2200-2300	14.47-14.5
8.291-8.294	149.9-150.05	2310-2390	15.35-16.2
8.362-8.366	156.52475-156.52525	2483.5-2500	17.7-21.4
8.37625-8.38675	156.7-156.9	2655-2900	22.01-23.12
8.41425-8.41475	162.0125-167.17	3260-3267	23.6-24.0
12.29-12.293	167.72-173.2	3332-3339	31.2-31.8
12.51975-12.52025	240-285	3345.8-3358	36.43-36.5
12.57675-12.57725	322-335.4	3600-4400	Above 38.6
13.36-13.41	1718		

Number of channels tested:

Tuning Range	Number Of Channels Tested	Channel Location In Band
1 MHz or Less	1	Middle
1 to 10 MHz	2	Top And Bottom
More Than 10 MHz	3	Top, Middle, Bottom

EQUIPMENT: Mobile Data Radio and 385700-4000-001 4 Port Line Amplifier
FCC ID:

NAME OF TEST: Transmitter Power Density	PARA. NO.: 15.247(d)
---	----------------------

Minimum Standard: The transmitted power density averaged over any 1 second interval shall not be greater than +8 dBm in any 3 kHz bandwidth.

Method Of Measurement: The spectrum analyzer is set as follows:

- RBW: 3 kHz
- VBW: >3 kHz
- Span: => measured 6 dB bandwidth
- Sweep: Span(kHz)/3 (i.e. for a span of 1.5 MHz the sweep rate is 1500/3 = 500 sec.
- LOG dB/div.: 2 dB

Note: For devices with spectrum line spacing =< 3 kHz, the RBW of the analyzer is reduced until the spectral lines are resolved. The measurement data is normalized to 3 kHz by summing the power of all the individual spectral lines within a 3 kHz band in linear power units.

For Devices With Integral Antenna:

For devices with non-detachable antennas, the received field strength is peaked and the spectrum analyzer is set as above. The peak emission level is then measured and converted to a field strength by adding the appropriate antenna factor and cable loss. This field strength is then converted to an equivalent isotropic radiated power using the same method as described for Peak Power output.

Number of channels tested:

Tuning Range	Number Of Channels Tested	Channel Location In Band
1 MHz or Less	1	Middle
1 to 10 MHz	2	Top And Bottom
More Than 10 MHz	3	Top, Middle, Bottom

EQUIPMENT: Mobile Data Radio and 385700-4000-001 4 Port Line Amplifier
FCC ID:

NAME OF TEST: Processing Gain

PARA. NO.: 15.247(e)

Minimum Standard: The processing gain shall be at least 10 dB.

Method Of Measurement: The plot was taken of the spectrum of the RF transmitter and compared to a plot of the IF spectrum measured at the output of the correlator.

Calculation Of Processing Gain:

The processing gain was determined by measuring the jamming margin of the E.U.T. and using the following formula:

$$\text{Jamming Margin} = G_p - (S/N)_{\text{out}} - L_{\text{sys}}$$

For a receiver using non-coherent detection the value $(S/N)_{\text{out}}$ is calculated using the formula:

$P_e = (1/2)\text{EXP}\{-E/2N_o\}$ where P_e is the probability of error (minimum Bit Error Rate required for proper operation).

E/N_o is $(S/N)_{\text{out}}$

for example, for a bit error rate of 10^{-4} a S/N ratio of 12.3 dB is required.

L_{sys} (system losses) is assumed to be 2 dB.

Therefore $G_p = M_j + (S/N)_{\text{out}} + L_{\text{sys}}$

Measurement performed at 915 MHz.

KTL Dallas, Inc.

FCC PART 15, SUBPART C
DIRECT SEQUENCE TRANSMITTERS
PROJECT NO.9L022RUS:
ANNEX B

EQUIPMENT: 2400 Mobile Data Radio and 385700-4000-001 4 Port Line Amplifier
FCC ID:

ANNEX B
BLOCK DIAGRAMS

EQUIPMENT: 2400 Mobile Data Radio and 385700-4000-001 4 Port Line Amplifier
FCC ID:

Test Site For Radiated Emissions

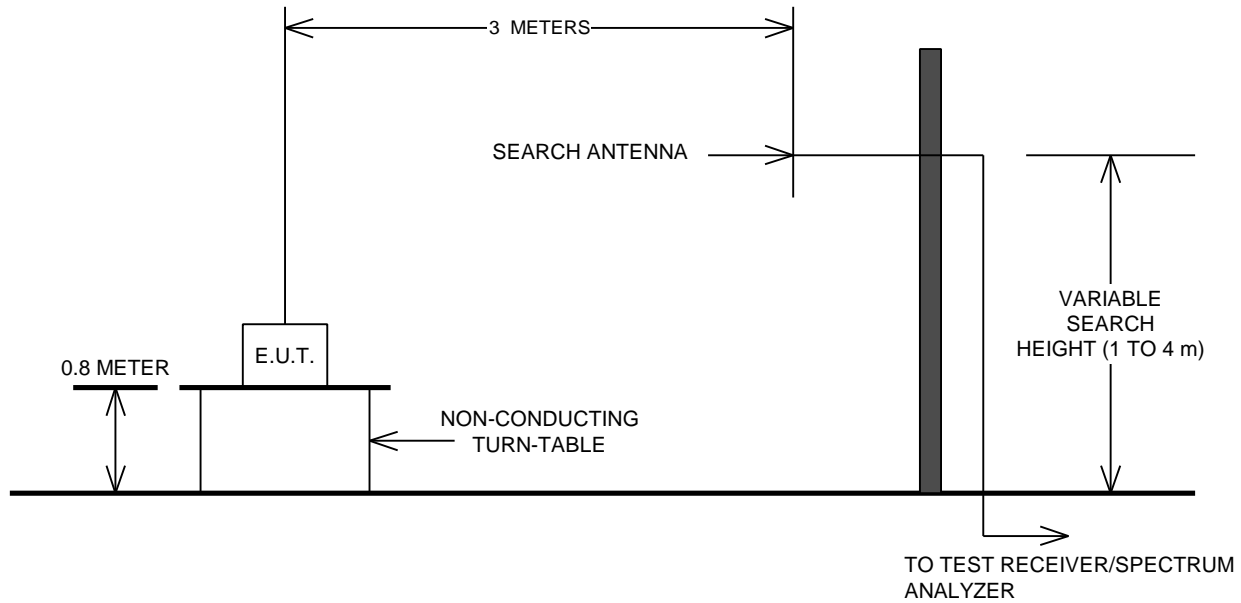

Below 1 GHz

Peak detector.
RBW = 100 kHz

Above 1 GHz For Peak Emission Levels

Peak detector
RBW = 1 MHz
VBW = >RBW

Above 1 GHz For Average Emission Levels

Peak detector
RBW = 1 MHz
VBW = 10 Hz

Conducted Emissions

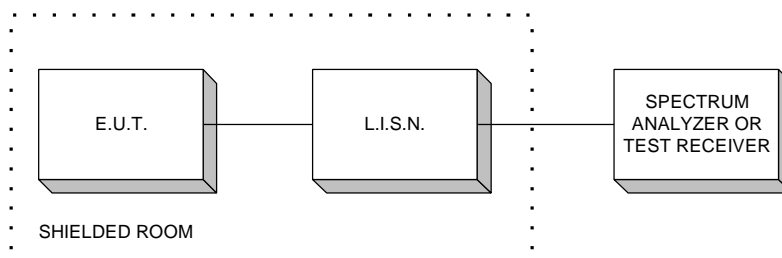

EQUIPMENT: 2400 Mobile Data Radio and 385700-4000-001 4 Port Line Amplifier
FCC ID:

Transmitter Power Density & Peak Power At Antenna Terminals

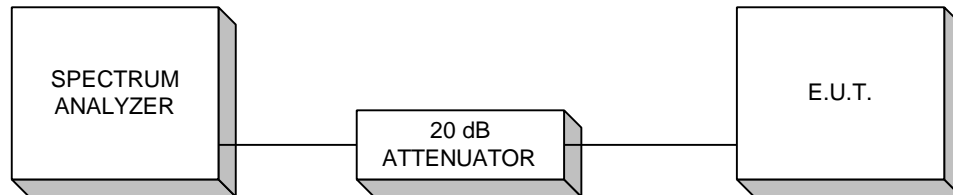

If the E.U.T. has an integral (non-detachable) antenna, the above test is performed as a radiated measurement and the result is reported as EIRP.

Processing Gain

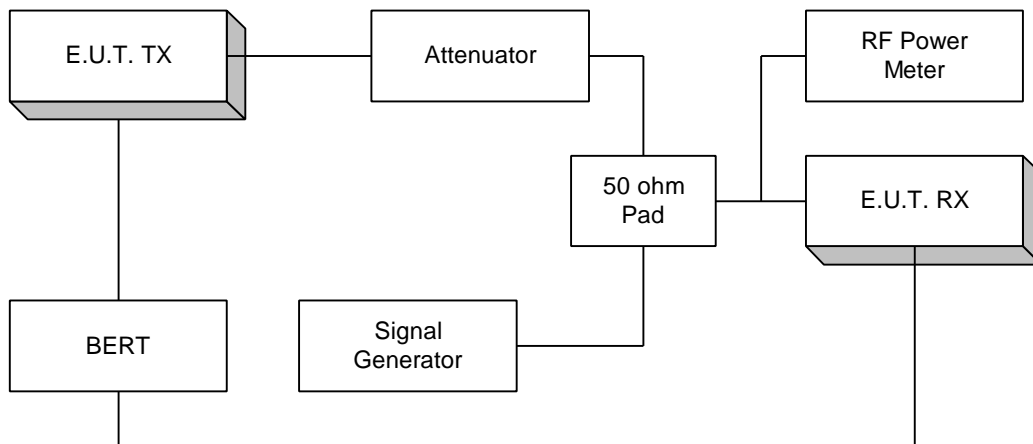

NOTE: This is a typical setup. The setup may vary slightly since many devices have BER test functions built into the device.