

Project No: TM-2309000126P
Report No.: TMWK2309003227KR

FCC ID: KR5TIS-16

Page 1 / 32
Rev. 00

RADIO TEST REPORT

FCC 47 CFR PART 15 SUBPART C

Test Standard	FCC Part 15.231
Product name	Tire Pressure Monitoring System
Model No.	TIS-16
Trade name	Continental
Operation Freq.	TX: 315MHz
Test Result	Pass
Statements of Conformity	Determination of compliance is based on the results of the compliance measurement, not taking into account measurement instrumentation uncertainty.

The test Result was tested by Compliance Certification Services Inc. The test data, data evaluation, test procedures, and equipment configurations shown in this report were given in ANSI C63.10: 2013 and compliance standards.

The test results of this report relate only to the tested sample (EUT) identified in this report.

The test Report of full or partial shall not copy. Without written approval of SGS Compliance Certification Services Inc. (Wugu Laboratory)

Approved by:



Shawn Wu
Supervisor

Unless otherwise stated the results shown in this test report refer only to the sample(s) tested and such sample(s) are retained for 90 days only.
除非另有說明，此報告結果僅對測試之樣品負責，同時此樣品僅保留90天。本報告未經本公司書面許可，不可部份複製。

This document is issued by the Company subject to its General Conditions of Service printed overleaf, available on request or accessible at <http://www.sgs.com.tw/Terms-and-Conditions> and, for electronic format documents, subject to Terms and Conditions for Electronic Documents at <http://www.sgs.com.tw/Terms-and-Conditions>. Attention is drawn to the limitation of liability, indemnification and jurisdiction issues defined therein. Any holder of this document is advised that information contained hereon reflects the Company's findings at the time of its intervention only and within the limits of client's instruction, if any. The Company's sole responsibility is to its Client and this document does not exonerate parties to a transaction from exercising all their rights and obligations under the transaction documents. This document cannot be reproduced, except in full, without prior written approval of the Company. Any unauthorized alteration, forgery or falsification of the content or appearance of this document is unlawful and offenders may be prosecuted to the fullest extent of the law.

Revision History

Rev.	Issue Date	Revisions	Effect Page	Revised By
00	October 3, 2023	Initial Issue	ALL	Peggy Tsai

Table of contents

1. GENERAL INFORMATION	4
1.1 EUT INFORMATION	4
1.2 EUT CHANNEL INFORMATION	5
1.3 ANTENNA INFORMATION	5
1.4 MEASUREMENT UNCERTAINTY	6
1.5 FACILITIES AND TEST LOCATION	7
1.6 INSTRUMENT CALIBRATION	7
1.7 SUPPORT AND EUT ACCESSORIES EQUIPMENT	8
1.8 TEST METHODOLOGY AND APPLIED STANDARDS	8
2. TEST SUMMARY	9
3. DESCRIPTION OF TEST MODES	10
3.1 THE WORST MODE OF OPERATING CONDITION	10
3.2 THE WORST MODE OF MEASUREMENT	10
3.3 FCC PART 15.205 RESTRICTED BANDS OF OPERATIONS	11
3.4 EUT DUTY CYCLE	13
4. TEST RESULT	14
4.1 AC POWER LINE CONDUCTED EMISSION	14
4.2 EMISSION BANDWIDTH	15
4.3 FIELD STRENGTH OF FUNDAMENTAL	17
4.4 RADIATION UNWANTED EMISSION	22
4.5 OPERATION RESTRICTION	30
4.6 ANTENNA REQUIREMENT	32
APPENDIX 1 – PHOTOGRAPHS OF EUT	

Report No.: TMWK2309003227KR

1. GENERAL INFORMATION

1.1 EUT INFORMATION

Applicant	Continental Automotive Technologies GmbH Siemensstrasse 12 Regensburg 93055 Germany
Manufacturer	Continental Automotive Technologies GmbH Siemensstrasse 12 Regensburg 93055 Germany
Factory	Continental Automotive Changchun Co., Ltd Jingyue Branch 5800, Shengtai Street Changchun, 130000 Jilin Province P.R. CHINA
Equipment	Tire Pressure Monitoring System
Model Name	TIS-16
Model Discrepancy	N/A
Received Date	September 12, 2023
Date of Test	September 15 ~ 20, 2023
Periodic operation	<input checked="" type="checkbox"/> (1) A manually operated transmitter shall employ a switch that will automatically deactivate the transmitter within not more than 5 seconds of being released. <input type="checkbox"/> (2) A transmitter activated automatically shall cease transmission within 5 seconds after activation <input type="checkbox"/> (3) Periodic transmissions at regular predetermined intervals are not permitted. <input type="checkbox"/> (4) Periodic transmissions (lower field strength): each transmission is not greater than 1 sec and the silent period between transmissions is at least 30 times the duration of the transmission but in no case less than 10 sec.
Power Operation	Power from Battery: DC 3V
Operation Frequency	TX: 315MHz
H/W Version	01
S/W Version	145

Remark:

1. For more details, please refer to the User's manual of the EUT.

Report No.: TMWK2309003227KR

1.2 EUT CHANNEL INFORMATION

Frequency Range	TX: 315MHz
Modulation Type	ASK / FSK

Remark:

Refer as ANSI 63.10:2013 clause 5.6.1 Table 4 for test channels

Number of frequencies to be tested		
Frequency range in which device operates	Number of frequencies	Location in frequency range of operation
<input checked="" type="checkbox"/> 1 MHz or less	1	Middle
<input type="checkbox"/> 1 MHz to 10 MHz	2	1 near top and 1 near bottom
<input type="checkbox"/> More than 10 MHz	3	1 near top, 1 near middle, and 1 near bottom

1.3 ANTENNA INFORMATION

Antenna Type	TX: Internal Antenna
Antenna Gain	TX: -28 dBi
Antenna Connector	N/A

Remark:

1. Disclaimer: Antenna information is provided by the applicant, test results of this report are applicable to the sample EUT received.

1.4 MEASUREMENT UNCERTAINTY

PARAMETER	UNCERTAINTY
AC Powerline Conducted Emission	+/- 2.213 dB
Channel Bandwidth	+/- 2.7 %
Radiated Emission_9kHz-30MHz	+/- 3.761 dB
Radiated Emission_30MHz-200MHz	+/- 3.473 dB
Radiated Emission_200MHz-1GHz	+/- 3.946 dB
Radiated Emission_1GHz-6GHz	+/- 4.797 dB

Remark:

- 1.This uncertainty represents an expanded uncertainty expressed at approximately the 95% confidence level using a coverage factor of k=2
2. ISO/IEC 17025 requires that an estimate of the measurement uncertainties associated with the emissions test results be included in the report.

1.5 FACILITIES AND TEST LOCATION

All measurement facilities used to collect the measurement data are located at

No.11, Wugong 6th Rd., Wugu Dist., New Taipei City, Taiwan.

CABID: TW1309

Test site	Test Engineer	Remark
AC Conduction Room	-	Not applicable, because EUT doesn't connect to AC Main Source direct.
Radiation	Ray Li	-
Conducted	David Li	-

Remark: The sites are constructed in conformance with the requirements of ANSI C63.7, ANSI C63.4 and CISPR Publication 22.

1.6 INSTRUMENT CALIBRATION

3M 966 Chamber Test Site					
Equipment	Manufacturer	Model	S/N	Cal Date	Cal Due
PXA Signal Analyzer	Keysight Technologies	N9030B	MY62291089	2022-10-14	2023-10-13
Loop Antenna	COM-POWER	AL-130	121051	2023-05-23	2024-05-22
Preamplifier	EMEC	EM330	060609	2023-02-22	2024-02-21
Thermo-Hygro Meter	WISEWIND	1206	D07	2022-12-19	2023-12-18
Bi-Log Antenna	Sunol Sciences	JB3	A030105	2023-08-08	2024-08-07
Cable	Huber+Suhner	104PEA	20995+21000+182330	2023-02-22	2024-02-21
Turn Table	CCS	CC-T-1F	N/A	N.C.R	N.C.R
Controller	CCS	CC-C-1F	N/A	N.C.R	N.C.R
Antenna Tower	CCS	CC-A-1F	N/A	N.C.R	N.C.R
Software	e3 V9-210616c				

RF Conducted Test Site					
Name of Equipment	Manufacturer	Model	Serial Number	Calibration Date	Calibration Due
Loop Probe	LANGER EMV-TECHNIK	RF-R 50-1	02-2644	2023-01-13	2024-01-12
EXA Signal Analyzer	Keysight	N9010B	MY60242460	2023-02-02	2024-02-01
Software	N/A				

Remark:

- Each piece of equipment is scheduled for calibration once a year.
- N.C.R. = No Calibration Required.

1.7 SUPPORT AND EUT ACCESSORIES EQUIPMENT

There are no accessories and support equipment be used during the test.

EUT Accessories Equipment					
No.	Equipment	Brand	Model	Series No.	FCC ID
	N/A				

Support Equipment					
No.	Equipment	Brand	Model	Series No.	FCC ID
1.	Power Supply	ABM	9603D-D011314		

1.8 TEST METHODOLOGY AND APPLIED STANDARDS

The test methodology, setups and results comply with all requirements in accordance with ANSI C63.10:2013, FCC 15.231.

2. TEST SUMMARY

FCC Standard Sec.	Chapter	Test Item	Result
15.207	4.1	AC Power-line Conducted Emission	Not applicable
15.231(c)	4.2	Emission Bandwidth	Pass
15.231(b)	4.3	Fundamental Emission	Pass
15.209(b)	4.4	Transmitter Radiated Emission	Pass
15.231(a)(1)	4.5	Operation Restriction	Pass
15.203	4.6	Antenna Requirement	Pass

Report No.: TMWK2309003227KR

3. DESCRIPTION OF TEST MODES

3.1 THE WORST MODE OF OPERATING CONDITION

Operation mode	TX: 315MHz
RF Field strength	TX 315MHz <u>Peak: 74.14 dBuv/m</u> <u>Average : 60.42 dBuv/m</u>

Remark: Field strength performed Average level at 3m.

3.2 THE WORST MODE OF MEASUREMENT

Radiated Emission Measurement Above 1G	
Test Condition	Radiated Emission Above 1G
Power supply Mode	Mode 1: EUT power by Battery
Worst Mode	<input checked="" type="checkbox"/> Mode 1 <input type="checkbox"/> Mode 2 <input type="checkbox"/> Mode 3 <input type="checkbox"/> Mode 4
Worst Position	<input type="checkbox"/> Placed in fixed position. <input type="checkbox"/> Placed in fixed position at X-Plane (E2-Plane) <input checked="" type="checkbox"/> Placed in fixed position at Y-Plane (E1-Plane) <input type="checkbox"/> Placed in fixed position at Z-Plane (H-Plane)

Radiated Emission Measurement Below 1G	
Test Condition	Radiated Emission Below 1G
Power supply Mode	Mode 1: EUT power by Battery
Worst Mode	<input checked="" type="checkbox"/> Mode 1 <input type="checkbox"/> Mode 2 <input type="checkbox"/> Mode 3 <input type="checkbox"/> Mode 4

Remark:

1. The worst mode was record in this test report.
2. EUT pre-scanned in three axis ,X,Y, Z and two polarity, for radiated measurement. The worst case(Y-Plane) were recorded in this report.

3.3 FCC PART 15.205 RESTRICTED BANDS OF OPERATIONS

According to FCC 15.231(b), 15.231(e),

(b) In addition to the provisions of §15.205, the field strength of emissions from intentional radiators operated under this section shall not exceed the following:

Fundamental frequency (MHz)	Field strength of fundamental (microvolts/meter)	Field strength of spurious emissions (microvolts/meter)
40.66-40.70	2,250	225
70-130	1,250	125
130-174	¹ 1,250 to 3,750	¹ 125 to 375
174-260	3,750	375
260-470	¹ 3,750 to 12,500	¹ 375 to 1,250
Above 470	12,500	1,250

¹Linear interpolations.

(1) The above field strength limits are specified at a distance of 3 meters. The tighter limits apply at the band edges.

(2) Intentional radiators operating under the provisions of this section shall demonstrate compliance with the limits on the field strength of emissions, as shown in the above table, based on the average value of the measured emissions. As an alternative, compliance with the limits in the above table may be based on the use of measurement instrumentation with a CISPR quasi-peak detector. The specific method of measurement employed shall be specified in the application for equipment authorization. If average emission measurements are employed, the provisions in §15.35 for averaging pulsed emissions and for limiting peak emissions apply. Further, compliance with the provisions of §15.205 shall be demonstrated using the measurement instrumentation specified in that section.

(3) The limits on the field strength of the spurious emissions in the above table are based on the fundamental frequency of the intentional radiator. Spurious emissions shall be attenuated to the average (or, alternatively, CISPR quasi-peak) limits shown in this table or to the general limits shown in §15.209, whichever limit permits a higher field strength.

Report No.: TMWK2309003227KR

(e) Intentional radiators may operate at a periodic rate exceeding that specified in paragraph (a) of this section and may be employed for any type of operation, including operation prohibited in paragraph (a) of this section, provided the intentional radiator complies with the provisions of paragraphs (b) through (d) of this section, except the field strength table in paragraph (b) of this section is replaced by the following:

Fundamental frequency (MHz)	Field strength of fundamental (microvolts/meter)	Field strength of spurious emissions (microvolts/meter)
40.66-40.70	1,000	100
70-130	500	50
130-174	500 to 1,500 ¹	50 to 150 ¹
174-260	1,500	150
260-470	1,500 to 5,000 ¹	150 to 500 ¹
Above 470	5,000	500

¹Linear interpolations.

In addition, devices operated under the provisions of this paragraph shall be provided with a means for automatically limiting operation so that the duration of each transmission shall not be greater than one second and the silent period between transmissions shall be at least 30 times the duration of the transmission but in no case less than 10 seconds.

Report No.: TMWK2309003227KR

3.4 EUT DUTY CYCLE

Temperature: 24 ~ 25.3°C **Test Date:** September 15 ~ 20, 2023
Humidity: 53 ~ 54% RH **Tested by:** David Li

Duty Cycle			
TX ON (ms)	TX All(ms)	Duty Cycle (%)	Duty Factor(dB)
20.600	100.000	20.60%	-13.72

DUTY CYCLE

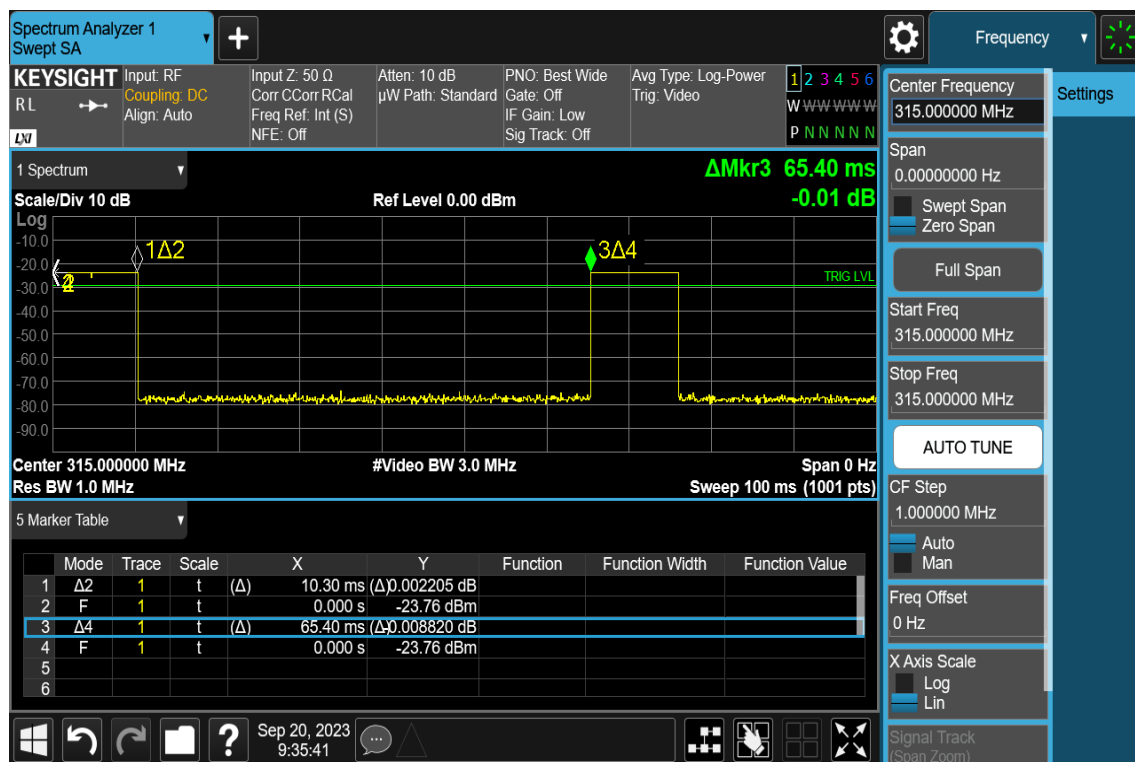

Notes:

1. The transmitter duty cycle was measured using a spectrum analyser in the time domain and calculated by $20 \log(\text{Time(on)} / \text{Time(all)})$
2. The EUT transmits for a Time(on) of 100 milliseconds.

$$20 \log(\text{Time(on)} / \text{Time(all)})$$

$$20 \log(20.6 / 100) = -13.72 \text{ dB}$$

4. TEST RESULT

4.1 AC POWER LINE CONDUCTED EMISSION

4.1.1 Test Limit

According to §15.207(a),

Frequency Range (MHz)	Limits(dBµV)	
	Quasi-peak	Average
0.15 to 0.50	66 to 56*	56 to 46*
0.50 to 5	56	46
5 to 30	60	50

* Decreases with the logarithm of the frequency.

4.1.2 Test Procedure

Test method Refer as ANSI 63.10:2013 clause 6.2,

1. The EUT was placed on a table, which is 0.8m above ground plane.
2. Maximum procedure was performed on the six highest emissions to ensure EUT compliance.
3. Repeat above procedures until all frequency measured were complete

4.1.3 Test Setup

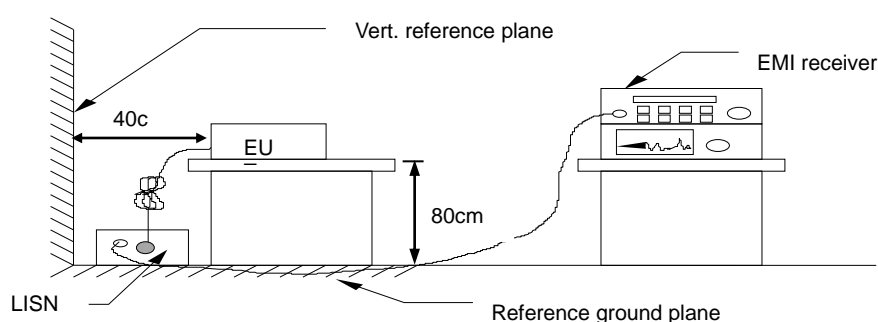

4.1.4 Test Result

Not applicable, because EUT doesn't connect to AC Main Source direct.

4.2 EMISSION BANDWIDTH

4.2.1 Test Limit

According to §15.231(c),

Limit	<input checked="" type="checkbox"/> 70 MHz – 900 MHz : $F_c * 0.25 \%$ <input type="checkbox"/> Above 900 MHz : $F_c * 0.5 \%$
-------	---

4.2.2 Test Procedure

Test method Refer as ANSI 63.10:2013 clause 6.9.2,

SA set RBW = 1% ~ 5% OBW, VBW = three times the RBW and Detector = Peak, Trace mode = Max hold, Sweep = Auto. Measure the maximum width of the emission that is constrained by the frequencies associated with the Occupied Bandwidth (99%) and 20dB Bandwidth.

4.2.3 Test Setup

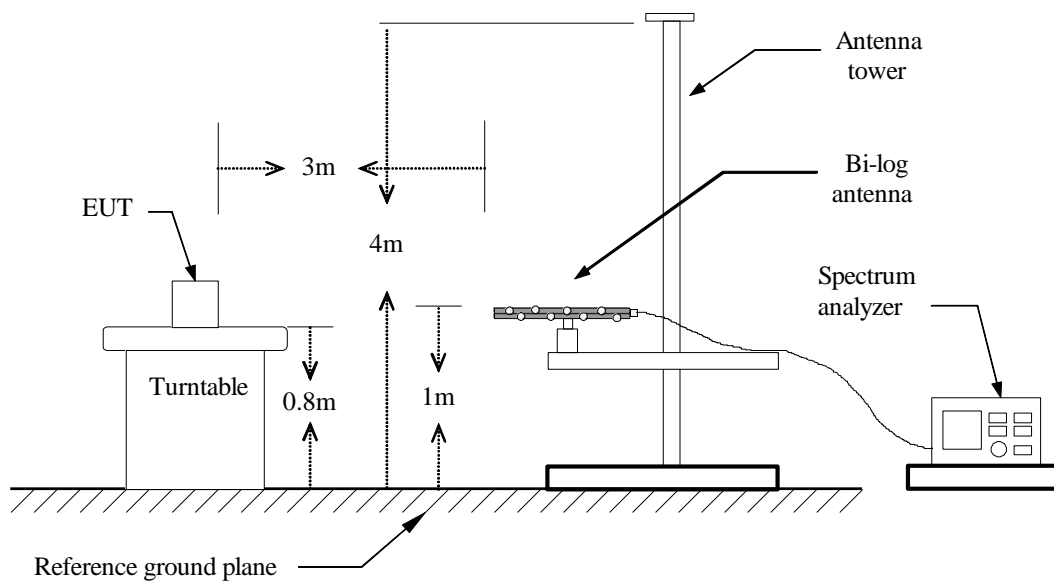

Report No.: TMWK2309003227KR

4.2.4 Test Result

Temperature: 24 ~ 25.3°C Test Date: September 15 ~ 20, 2023
Humidity: 53 ~ 54% RH Tested by: David Li

Spectrum Bandwidth				
Frequency (MHz)	20dB Bandwidth (KHz)	20dB Bandwidth Limits (MHz)	99% Occupied BW (KHz)	99% Bandwidth Limits (MHz)
315	173.6	0.7875	207.21	0.7875

Test Data

20dB Bandwidth and 99% Occupied BW

315MHz

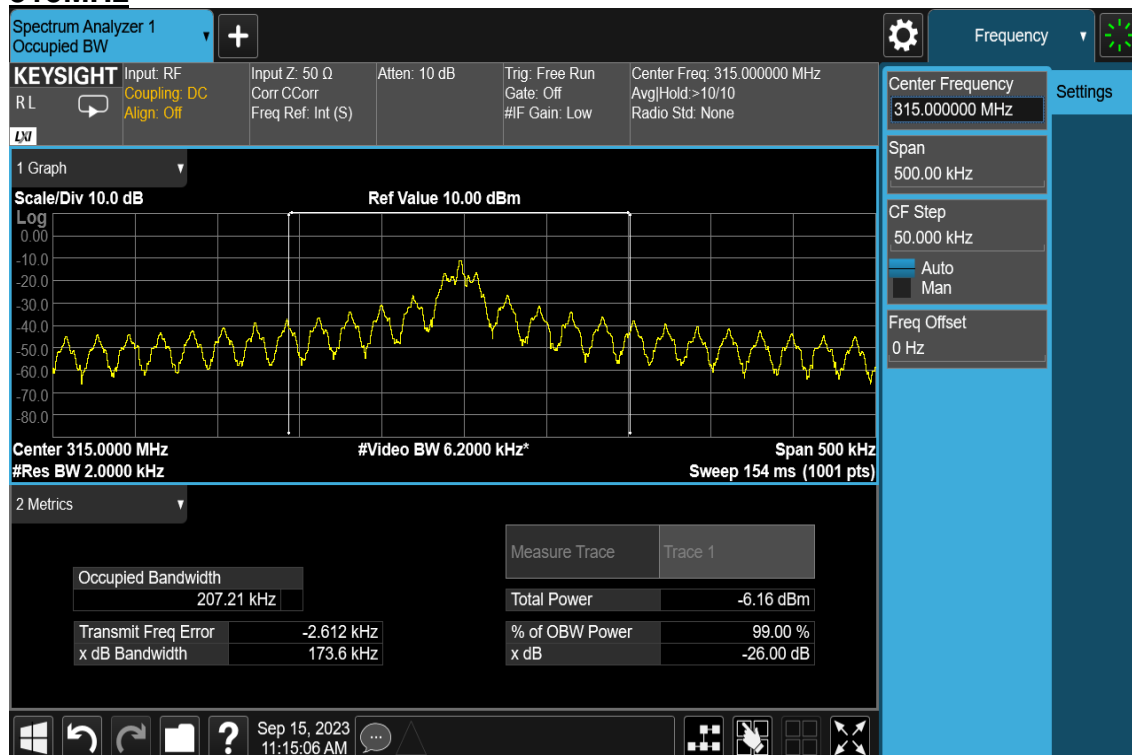

Report No.: TMWK2309003227KR

4.3 FIELD STRENGTH OF FUNDAMENTAL

4.3.1 Test Limit

According to §15.231(b)

Fundamental frequency (MHz)	Field strength of fundamental (microvolts/meter)	Field strength of fundamental (microvolts/meter)
40.66-40.70	2,250	225
70-130	1,250	125
130-174	11,250 to 3,750	1125 to 375
174-260	3,750	375
260-470	13,750 to 12,500	1375 to 1,250
Above 470	12,500	1,250

* Linear interpolation with frequency, f, in MHz:

For 130-174 MHz: Field Strength ($\mu\text{V}/\text{m}$) = $(56.82 \times f) - 6136$

For 260-470 MHz: Field Strength ($\mu\text{V}/\text{m}$) = $(41.67 \times f) - 7083$

Note 1: Frequency bands 225-328.6 MHz and 335.4-399.9 MHz are designated for the exclusive use of the Government of Canada. Manufacturers should be aware of possible harmful interference and degradation of their licence-exempt radio equipment in these frequency bands.

4.3.2 Test Procedure

Test method Refer as ANSI 63.10:2013 clause 4.1.4 and clause 6.5

clause 4.1.4	<input checked="" type="checkbox"/> 4.1.4.2.2: Measurement Peak value. <input type="checkbox"/> 4.1.4.2.3: Duty cycle \geq 100%. <input checked="" type="checkbox"/> 4.1.4.2.4: Measurement Average value.
--------------	--

4.3.3 Test Setup

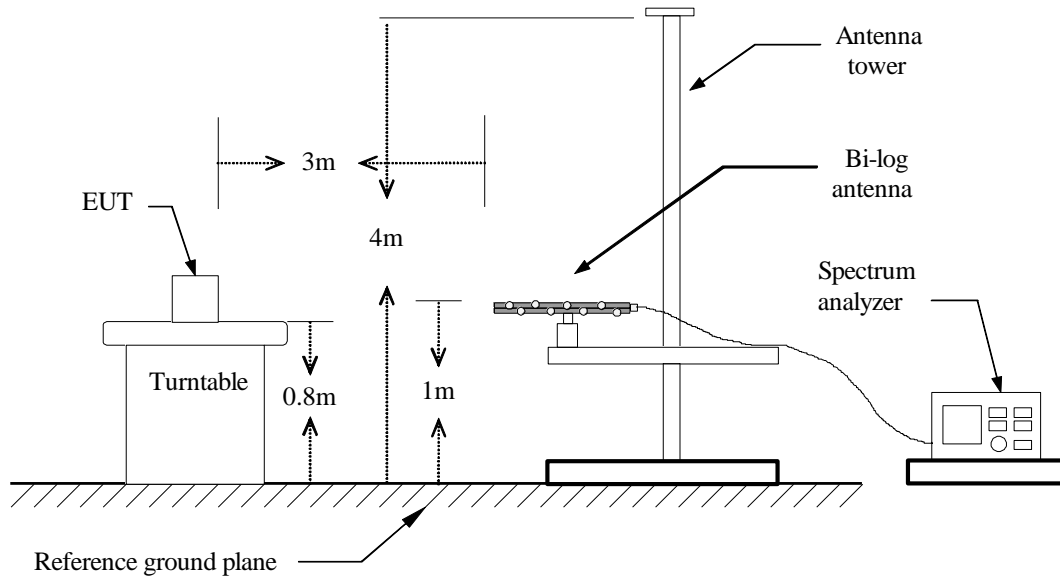

Report No.: TMWK2309003227KR

4.3.4 Test Result

Field Strength					
Frequency (MHz)	Fundamental (dBuV/m) at 3m	Limit (dBuV/m) at 3m	Margin (dB)	Axis/Pol.	Remark
315	60.42	75.63	-15.21	Z/V	AVG

Remark:

1. Fundamental measured method setting on spectrum, RBW=100 kHz, VBW=100kHz and Detector=Peak.
2. Average result = Peak result + Duty factor = 74.14 dBuV/m – 13.72 = 60.42 dBuV/m
3. 260MHz ~ 470MHz limit is $41.67 * (\text{Frequency, MHz}) - 7083$
 Limit = $41.67 * (315 \text{ MHz}) - 7083$
 = 6043.05 (uV/m)
 dBuV/m = $20 \text{ Log (uV/m) } = 20 \text{ Log (6043.05 uV/m)} = 75.63 \text{ dBuV/m}$

Report No.: TMWK2309003227KR

Test Data

Test Mode:	TX-315MHz	Temp/Hum	24.5(°C)/ 57%RH
Test Item	Fundamental	Test Date	September 15, 2023
Axis/Polarize	Z-Plane / Ver.	Test Engineer	Ray Li
Detector	Peak & Average		

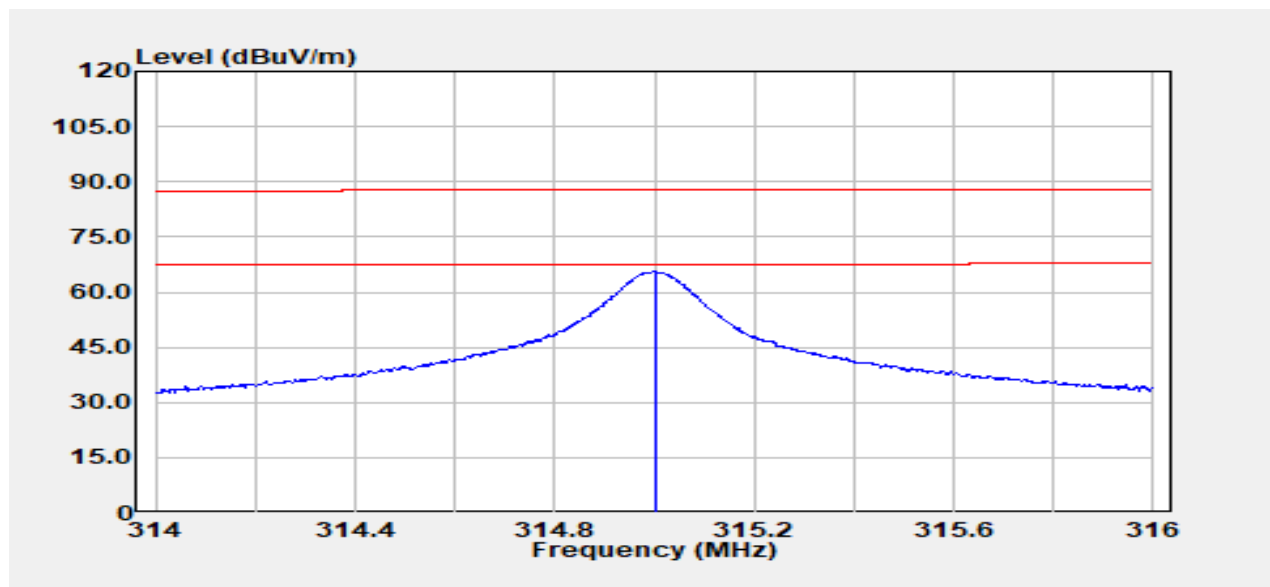

No	Frequency (MHz)	Detector Mode (PK/QP/AV)	Spectrum Reading Level (dBuV)	Factor (dB)	Actual FS (dBuV/m)	Limit @3m (dBuV/m)	Margin (dB)
1	315.00	Peak	73.58	-8.12	65.46	87.66	-22.20
2	315.00	Average	--	-13.72	51.74	67.66	-10.70

Note:

Average result = Peak result + Duty factor = 65.46dBuV/m -13.72= 51.74 dBuV/m

Report No.: TMWK2309003227KR

Test Mode:	TX-315MHz	Temp/Hum	24.5(°C)/ 57%RH
Test Item	Fundamental	Test Date	September 15, 2023
Axis/Polarize	Z-Plane / Hor.	Test Engineer	Ray Li
Detector	Peak & Average		

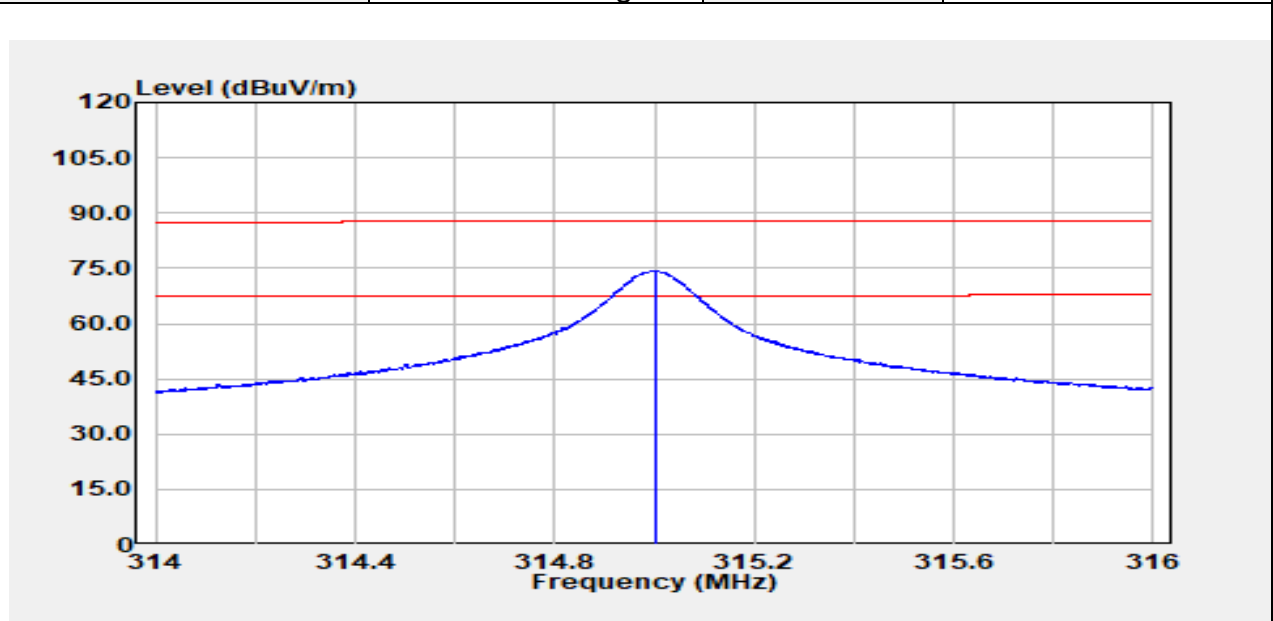

No	Frequency (MHz)	Detector Mode (PK/QP/AV)	Spectrum Reading Level (dBuV)	Factor (dB)	Actual FS (dBuV/m)	Limit @3m (dBuV/m)	Margin (dB)
1	315.00	Peak	82.26	-8.12	74.14	87.66	-13.52
2	315.00	Average	--	-13.72	60.42	67.66	-2.02

Note:

Average result = Peak result + Duty factor = 74.14 dBuV/m -13.72= 60.42 dBuV/m

Report No.: TMWK2309003227KR

4.4 RADIATION UNWANTED EMISSION

4.4.1 Test Limit

According to §15.231(b) and §15.209, §15.205

Unwanted emissions limit follow the table or the FCC Part 15.209, whichever limit permits higher field strength.

According to §15.231(b)

Fundamental frequency (MHz)	Field strength of fundamental (microvolts/meter)	Field strength of fundamental (microvolts/meter)
40.66-40.70	2,250	225
70-130	1,250	125
130-174	¹ 1,250 to 3,750	¹ 125 to 375
174-260	3,750	375
260-470	¹ 3,750 to 12,500	¹ 375 to 1,250
Above 470	12,500	1,250

¹Linear interpolations.

Below 30MHz

Frequency (MHz)	Field Strength				
	(μ V/m)	(dB μ V/m)	Measurement Distance (meter)	(dB μ V/m)	Measurement Distance (meter)
0.009 - 0.490	2400/F(kHz)	48.52 – 13.80	300	128.52–104.84	3
0.490 - 1.705	24000/F(kHz)	33.80 – 22.97	30	73.80– 62.97	3
1.705 – 30.0	30	29.54	30	69.54	3

Above 30MHz

Frequency (MHz)	Field Strength		Measurement Distance (meter)
	(μ V/m)	(dB μ V/m)	
30-88	100	40.0	3
88-216	150	43.5	3
216-960	200	46.0	3
Above 960	500	54.0	3

Report No.: TMWK2309003227KR

4.4.2 Test Procedure

Test method Refer as ANSI 63.10:2013

<input checked="" type="checkbox"/> Unwanted Emission	<input checked="" type="checkbox"/> clause 4.1.4.2.2: Measurement Peak value. <input type="checkbox"/> clause 4.1.4.2.3: Duty cycle \geq 100%. <input checked="" type="checkbox"/> clause 4.1.4.2.4: Measurement Average value.
---	---

<input checked="" type="checkbox"/> Radiated Emission	<input checked="" type="checkbox"/> clause 6.4: below 30 MHz and test distance is 3m. <input checked="" type="checkbox"/> clause 6.5: below 30 MHz -1 GHz and test distance is 3m. <input checked="" type="checkbox"/> clause 6.6: Above 30 MHz and test distance is 3m.
---	--

1. The EUT is placed on a turntable, which is 0.8m for test below 1GHz and 1.5m for test above 1GHz, above ground plane.
2. The turntable shall be rotated for 360 degrees to determine the position of maximum emission level.
3. EUT is set 3m away from the receiving antenna, which is varied from 1m to 4m to find out the highest emissions.
4. Maximum procedure was performed on the six highest emissions to ensure EUT compliance.
5. And also, each emission was to be maximized by changing the polarization of receiving antenna both horizontal and vertical.
6. Set the spectrum analyzer in the following setting as:
 Below 1GHz:
 RBW=100kHz / VBW=300kHz / Sweep=AUTO
 Above 1GHz:
 (a)PEAK: RBW=1MHz / VBW=3MHz / Sweep=AUTO
 (b)AVERAGE: RBW=1MHz,
7. Repeat above procedures until the measurements for all frequencies are complete.

Remark.

1. Although these tests were performed other than open area test site, adequate comparison measurements were confirmed against 30 m open area test site. Therefore sufficient tests were made to demonstrate that the alternative site produces results that correlate with the ones of tests made in an open field based on KDB 414788.
2. No emission found between lowest internal used/generated frequency to 30MHz (9kHz~30MHz).

4.4.3 Test Setup

9kHz ~ 30MHz

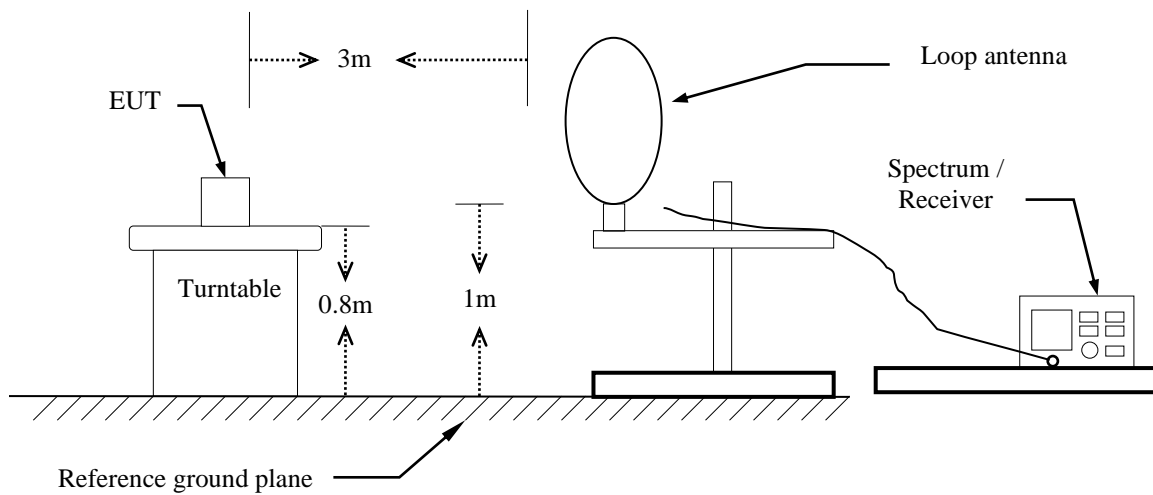

30MHz ~ 1 GHz

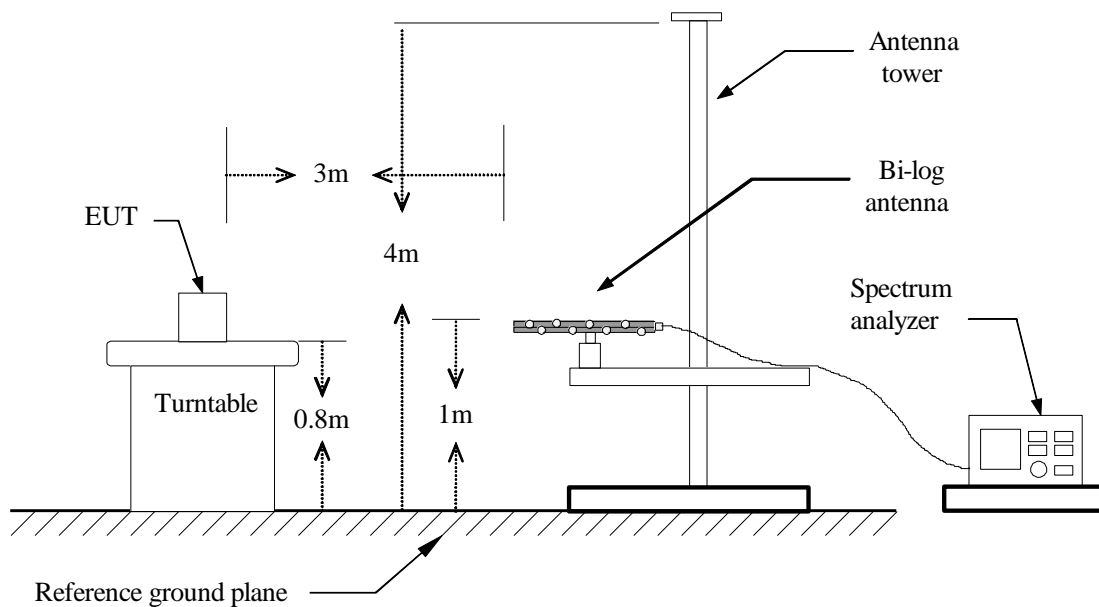

Above 1 GHz

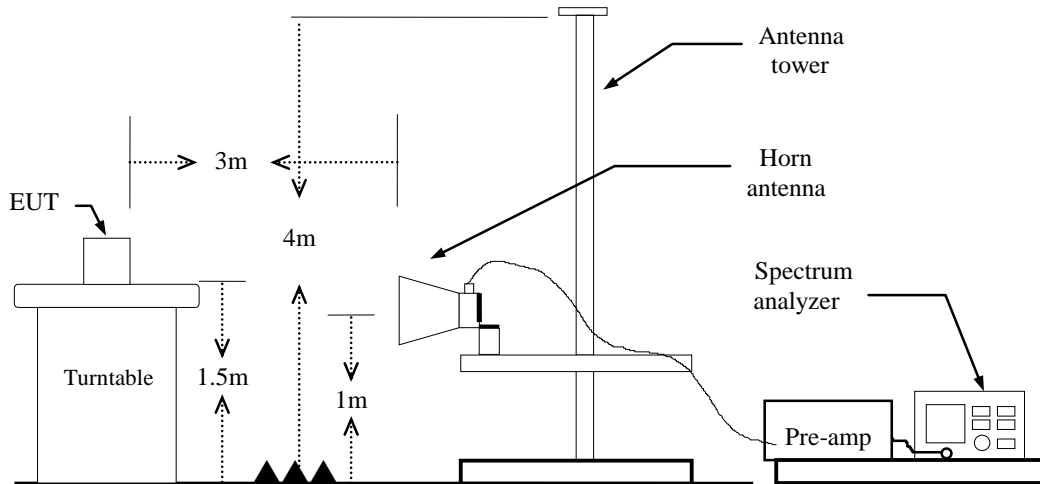

4.4.4 Test Result

Pass.

Report No.: TMWK2309003227KR

Below 1GHz

Test Mode:	TX-315MHz	Temp/Hum	24.5(°C)/ 57%RH
Test Item	Below 1GHz	Test Date	September 15, 2023
Polarize	Vertical	Test Engineer	Ray Li
Detector	Peak		

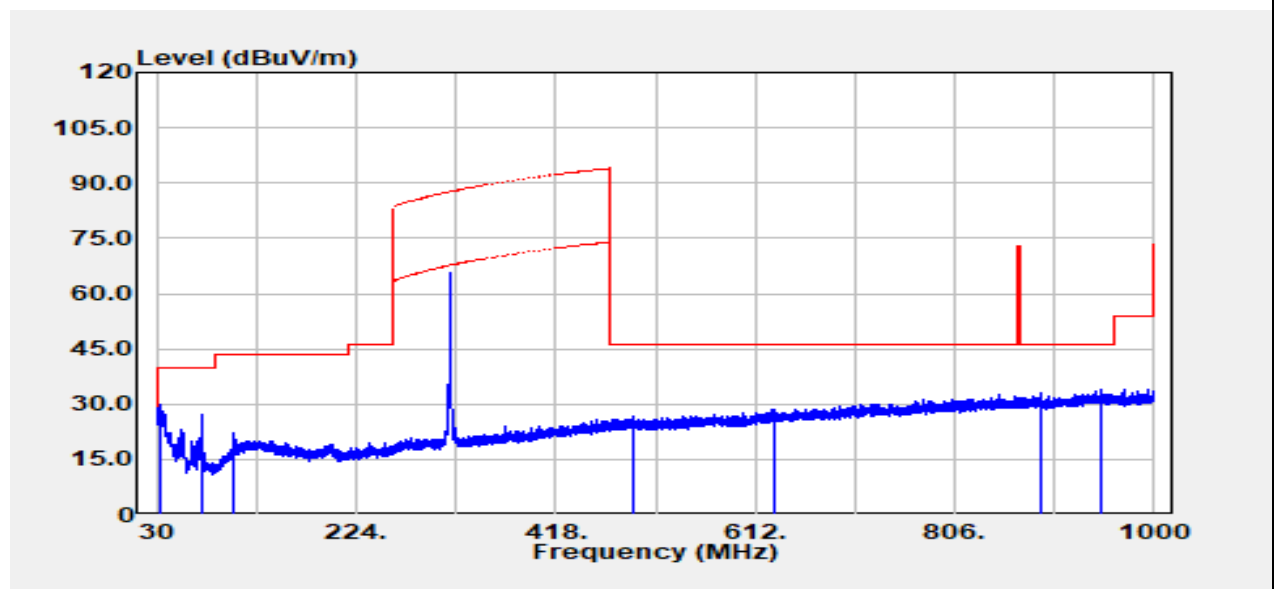

Frequency (MHz)	Detector Mode (PK/QP/AV)	Spectrum Reading Level (dBuV)	Factor (dB)	Actual FS (dBuV/m)	Limit @3m (dBuV/m)	Margin (dB)
33.20	Peak	35.05	-5.06	29.98	40.00	-10.02
74.00	Peak	42.68	-15.41	27.27	40.00	-12.73
104.90	Peak	33.32	-11.32	22.00	43.50	-21.50
494.40	Peak	30.34	-3.63	26.72	46.00	-19.28
630.00	Peak	29.71	-1.16	28.55	46.00	-17.45
890.20	Peak	30.75	2.44	33.19	46.00	-12.81
949.00	Peak	30.27	3.66	33.92	46.00	-12.08

Test Mode:	TX-315MHz	Temp/Hum	24.5(°C)/ 57%RH
Test Item	Below 1GHz	Test Date	September 15, 2023
Polarize	Horizontal	Test Engineer	Ray Li
Detector	Peak		

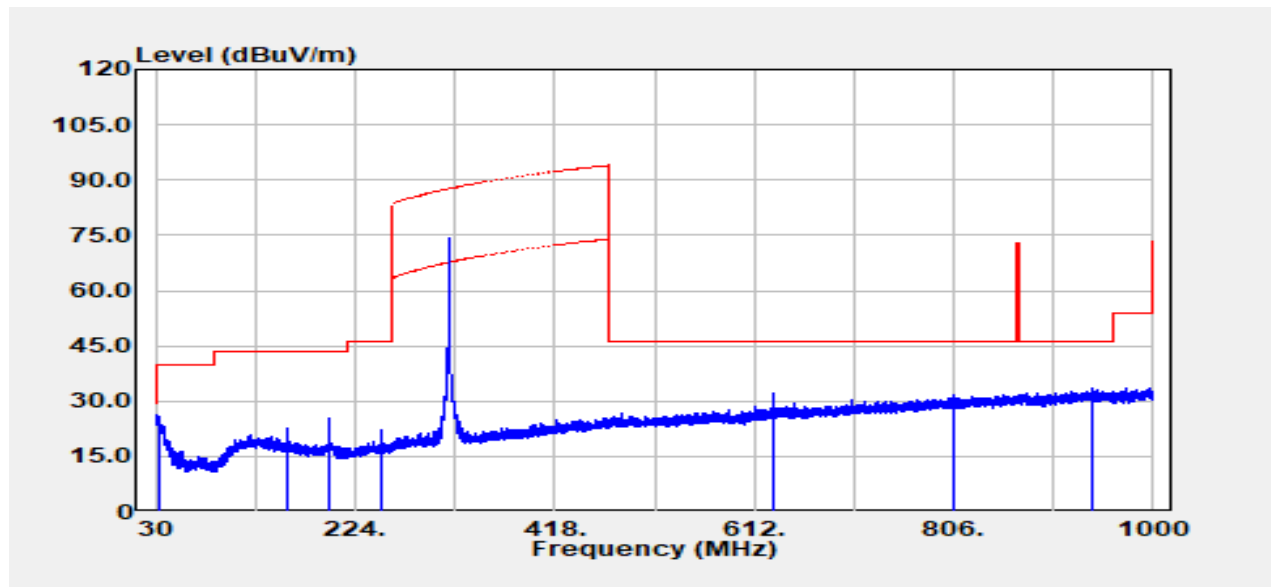

Frequency (MHz)	Detector Mode (PK/QP/AV)	Spectrum Reading Level (dBuV)	Factor (dB)	Actual FS (dBuV/m)	Limit @3m (dBuV/m)	Margin (dB)
32.20	Peak	29.50	-3.79	25.71	40.00	-14.29
158.10	Peak	33.13	-10.57	22.57	43.50	-20.93
198.80	Peak	35.36	-9.99	25.36	43.50	-18.14
249.60	Peak	32.89	-10.88	22.01	46.00	-23.99
630.00	Peak	33.44	-1.16	32.28	46.00	-13.72
807.10	Peak	30.26	1.38	31.64	46.00	-14.36
939.90	Peak	29.72	3.66	33.37	46.00	-12.63

Report No.: TMWK2309003227KR

Above 1GHz

Test Mode:	TX-315MHz	Temp/Hum	24.5(°C)/ 57%RH
Test Item	Above 1GHz	Test Date	September 15, 2023
Polarize	Vertical	Test Engineer	Ray Li
Detector	Peak & Average		

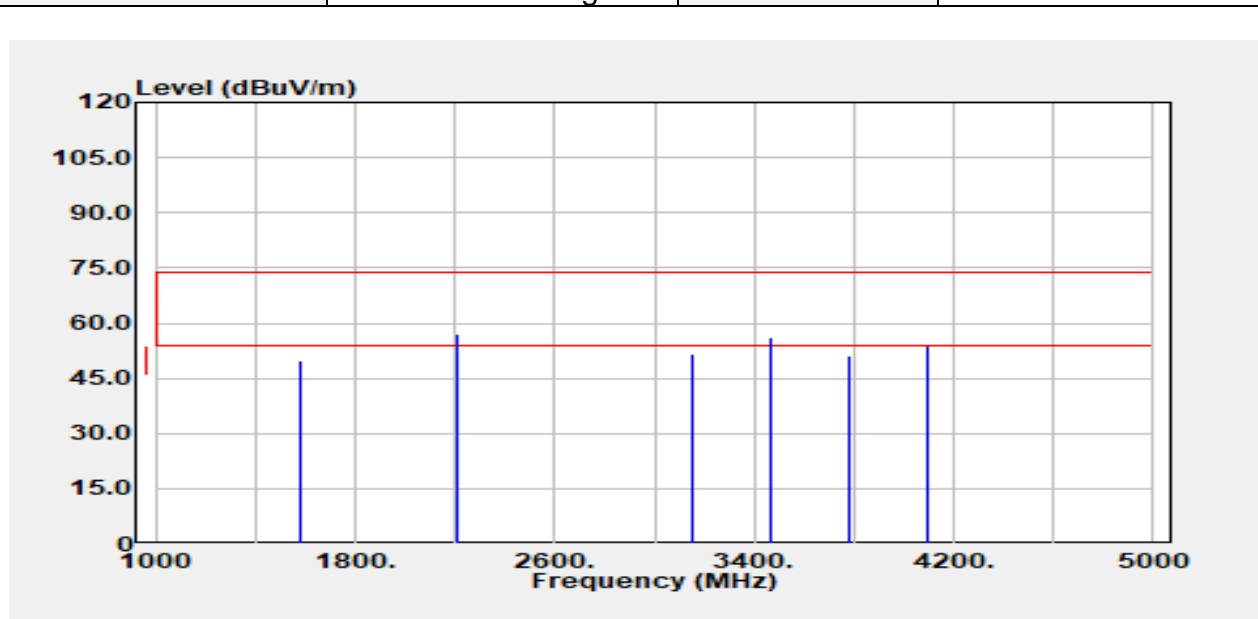

Frequency (MHz)	Detector Mode (PK/QP/AV)	Spectrum Reading Level (dBUV)	Factor (dB)	Actual FS (dBUV/m)	Limit @3m (dBUV/m)	Margin (dB)
1575.00	Peak	57.26	-7.50	49.77	74.00	-24.23
1575.00	Average	--	-13.72	36.05	54.00	-12.73
2205.00	Peak	60.57	-3.66	56.92	74.00	-17.08
2205.00	Average	--	-13.72	43.20	54.00	-5.58
3150.00	Peak	54.16	-2.43	51.73	74.00	-22.27
3150.00	Average	--	-13.72	38.01	54.00	-10.77
3464.80	Peak	57.89	-1.52	56.37	74.00	-17.63
3464.80	Average	--	-13.72	42.65	54.00	-6.13
3780.00	Peak	51.75	-0.42	51.33	74.00	-22.67
3780.00	Average	--	-13.72	37.61	54.00	-11.17
4095.20	Peak	54.05	0.06	54.11	74.00	-19.89
4095.20	Average	--	-13.72	40.39	54.00	-8.39

Remark:

1. Measuring frequencies from 1 GHz to the 10th harmonic of highest fundamental frequency.
2. For above 1GHz, the EUT peak value was under average limit, therefore the Average value compliance with the average limit.

Report No.: TMWK2309003227KR

Test Mode:	TX-315MHz	Temp/Hum	24.5(°C)/ 57%RH
Test Item	Above 1GHz	Test Date	September 15, 2023
Polarize	Horizontal	Test Engineer	Ray Li
Detector	Peak & Average		

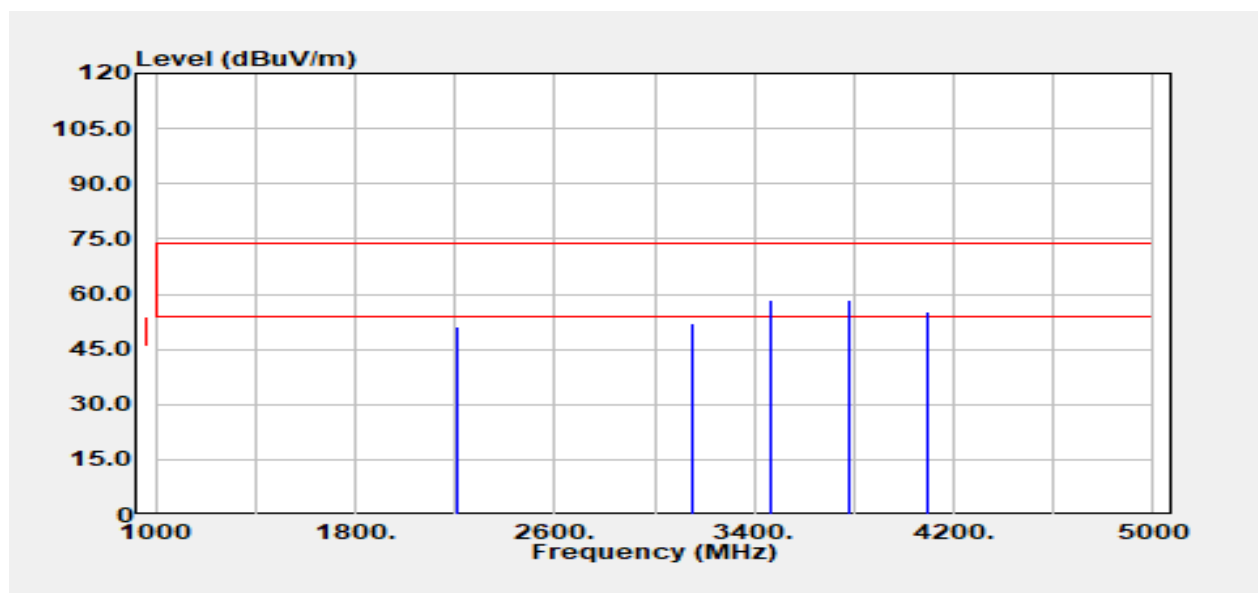

Frequency (MHz)	Detector Mode (PK/QP/AV)	Spectrum Reading Level (dBUV)	Factor (dB)	Actual FS (dBUV/m)	Limit @3m (dBUV/m)	Margin (dB)
2205.00	Peak	54.97	-3.66	51.31	74.00	-22.69
2205.00	Average	--	-13.72	37.59	54.00	-11.19
3150.00	Peak	54.58	-2.43	52.15	74.00	-21.85
3150.00	Average	--	-13.72	38.43	54.00	-10.35
3464.80	Peak	60.09	-1.52	58.57	74.00	-15.43
3464.80	Average	--	-13.72	44.85	54.00	-3.93
3780.00	Peak	58.62	-0.42	58.21	74.00	-15.79
3780.00	Average	--	-13.72	44.49	54.00	-4.29
4095.20	Peak	55.06	0.06	55.12	74.00	-18.88
4095.20	Average	--	-13.72	41.40	54.00	-7.38
2205.00	Peak	54.97	-3.66	51.31	74.00	-22.69
2205.00	Average	--	-13.72	37.59	54.00	-11.19

Remark:

1. Measuring frequencies from 1 GHz to the 10th harmonic of highest fundamental frequency.
2. For above 1GHz, the EUT peak value was under average limit, therefore the Average value compliance with the average limit.

4.5 OPERATION RESTRICTION

4.5.1 Test Limit

15.231(a)(1),

A manually operated transmitter shall employ a switch that will automatically deactivate the transmitter within not more than 5 seconds of being released.

4.5.2 Test Procedure

Test method Refer as ANSI 63.10:2013 clause 7.4

Set the RBW=1MHz, VBW=1MHz, Detector = Peak, Trace mode = Max hold, Sweep = 1s. Measure

4.5.3 Test Setup

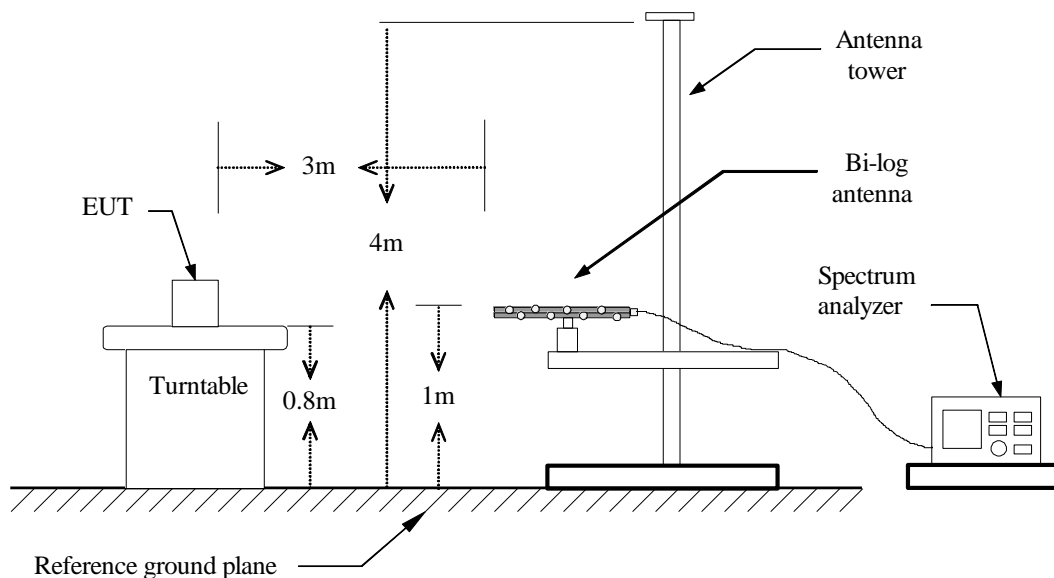

Report No.: TMWK2309003227KR

4.5.4 Test Result

Temperature: 24 ~ 25.3°C Test Date: September 15 ~ 20, 2023
Humidity: 53 ~ 54% RH Tested by: David Li

Dwell Time			
Operation condition (manually operated)	Pulse On Time (ms)	Limits	Result
315 MHz	364	5 sec	PASS

Test Data

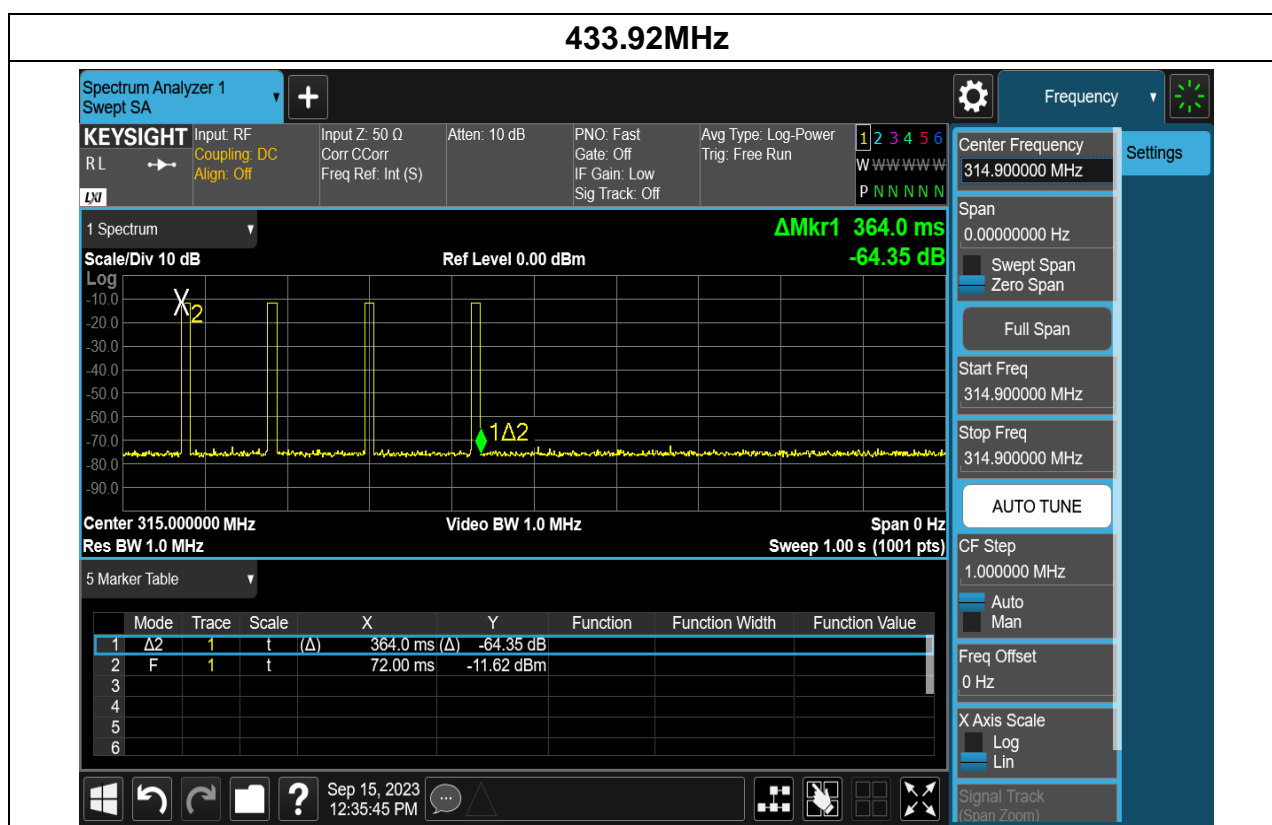

Report No.: TMWK2309003227KR

4.6 ANTENNA REQUIREMENT

§ 15.203 Antenna requirement.

An intentional radiator shall be designed to ensure that no antenna other than that furnished by the responsible party shall be used with the device. The use of a permanently attached antenna or of an antenna that uses a unique coupling to the intentional radiator shall be considered sufficient to comply with the provisions of this section. The manufacturer may design the unit so that a broken antenna can be replaced by the user, but the use of a standard antenna jack or electrical connector is prohibited. This requirement does not apply to carrier current devices or to devices operated under the provisions of §15.211, §15.213, §15.217, §15.219, or §15.221. Further, this requirement does not apply to intentional radiators that must be professionally installed, such as perimeter protection systems and some field disturbance sensors, or to other intentional radiators which, in accordance with §15.31(d), must be measured at the installation site. However, the installer shall be responsible for ensuring that the proper antenna is employed so that the limits in this part are not exceeded.

Antenna Type	<input checked="" type="checkbox"/> Internal Antenna <input type="checkbox"/> FPC <input type="checkbox"/> Dipole <input type="checkbox"/> Coils
Antenna Gain	Gain: -28 dBi

Remark:

1.The antenna(s) of the EUT are permanently attached and there are no provisions for connection to an external antenna. So the EUT complies with the requirements of §15.203.

- End of Test Report -