

Project No.: TM-2209000550P
 Report No.: TMWK2209003994KR

Page 1 / 30
 Rev. 01

FCC RADIO TEST REPORT

FCC 47 CFR PART 15 SUBPART C

Test Standard	FCC Part 15.209+ IC RSS-210 Issue 10
FCC ID	KR5HFM201
IC	7812D-HFM201
Product name	Hand Free Module
Model No.	HFM201
Trade name	Continental
Operation Freq.	TX: 125 KHz, RX: 433.92MHz
Test Result	Pass
Statements of Conformity	Determination of compliance is based on the results of the compliance measurement, not taking into account measurement instrumentation uncertainty.

The test Result was tested by Compliance Certification Services Inc. The test data, data evaluation, test procedures, and equipment configurations shown in this report were given in ANSI C63.10: 2013 and compliance standards.

The test results of this report relate only to the tested sample (EUT) identified in this report.

The test Report of full or partial shall not copy. Without written approval of SGS Compliance Certification Services Inc. (Wugu Laboratory)

Approved by:



Shawn Wu
 Supervisor

Unless otherwise stated the results shown in this test report refer only to the sample(s) tested and such sample(s) are retained for 90 days only.
 除非另有說明，此報告結果僅對測試之樣品負責，同時此樣品僅保留90天。本報告未經本公司書面許可，不可部份複製。

This document is issued by the Company subject to its General Conditions of Service printed overleaf, available on request or accessible at <http://www.sgs.com.tw/Terms-and-Conditions> and, for electronic format documents, subject to Terms and Conditions for Electronic Documents at <http://www.sgs.com.tw/Terms-and-Conditions>. Attention is drawn to the limitation of liability, indemnification and jurisdiction issues defined therein. Any holder of this document is advised that information contained hereon reflects the Company's findings at the time of its intervention only and within the limits of client's instruction, if any. The Company's sole responsibility is to its Client and this document does not exonerate parties to a transaction from exercising all their rights and obligations under the transaction documents. This document cannot be reproduced, except in full, without prior written approval of the Company. Any unauthorized alteration, forgery or falsification of the content or appearance of this document is unlawful and offenders may be prosecuted to the fullest extent of the law.

Revision History

Rev.	Issue Date	Revisions	Effect Page	Revised By
00	November 3, 2022	Initial Issue	ALL	Allison Chen
01	November 22, 2022	See the following Note Rev.(01)	P.10-11, 15, 17-18, 21-26	Allison Chen

Note:

Rev.(01)

1. Modify test summary in section 2.
2. Modify RF field strength description in section 3.1.
3. Modify standard description in section 4.1 and 4.2.

Table of contents

1.	GENERAL INFORMATION	4
1.1	EUT INFORMATION	4
1.2	EUT CHANNEL INFORMATION	5
1.3	ANTENNA INFORMATION	5
1.4	MEASUREMENT UNCERTAINTY.....	6
1.5	FACILITIES AND TEST LOCATION	7
1.6	INSTRUMENT CALIBRATION.....	8
1.7	SUPPORT AND EUT ACCESSORIES EQUIPMENT	9
1.8	TEST METHODOLOGY AND APPLIED STANDARDS	9
2.	TEST SUMMARY	10
3.	DESCRIPTION OF TEST MODES	11
3.1	THE WORST MODE OF OPERATING CONDITION	11
3.2	THE WORST MODE OF MEASUREMENT	11
3.3	FCC PART 15.205 & RSS GEN SECTION 8.10 RESTRICTED BANDS OF OPERATIONS	12
4.	TEST RESULT	15
4.1	20DB BANDWIDTH & 99%OBW	15
4.2	TRANSMITTER RADIATED EMISSION.....	17
4.3	AC POWER LINE CONDUCTED EMISSION	29
4.4	ANTENNA REQUIREMENT	30

APPENDIX 1 – PHOTOGRAPHS OF EUT

Report No.: TMWK2209003994KR

1. GENERAL INFORMATION

1.1 EUT INFORMATION

Applicant	Continental Automotive Technologies GmbH Siemensstrasse 12 93055 Regensburg Germany
Manufacturer	Continental Automotive Technologies GmbH Siemensstrasse 12 93055 Regensburg Germany
Factory	(1) Continental Automotive Changchun Co., Ltd. Jingyue Branch 5800 Shengtai Street Changchun, 130000 Jilin P.R. China (2) CONTINENTAL AUTOMOTIVE GUADALAJARA MEXICO S DE RL DE CV Camino a la Tijera No. 3 K.m. 3.5 Carretera Guadalajara Morelia. Colonia la Tijera 45640 Tlajomulco de Zúñiga Jalisco, MEXICO
Equipment	Hand Free Module
Model Name	HFM201
Model Discrepancy	N/A
Received Date	October 3, 2022
Date of Test	October 7~12, 2022
Power Operation	Power from power supply. (DC 12V)
Operation Frequency	TX: 125 KHz, RX: 433.92MHz
H/W Version	HFM201
S/W Version	SW0A00
EUT Serial #	20744925062038

Remark:

1. For more details, please refer to the User's manual of the EUT.
2. Disclaimer: Antenna information is provided by the applicant, test results of this report are applicable to the sample EUT received.

Report No.: TMWK2209003994KR

1.2 EUT CHANNEL INFORMATION

Frequency Range	TX: 125 KHz, RX: 433.92MHz
Modulation Type	ASK

Remark:

Refer as ANSI 63.10:2013 clause 5.6.1 Table 4 for test channels

Number of frequencies to be tested		
Frequency range in which device operates	Number of frequencies	Location in frequency range of operation
<input checked="" type="checkbox"/> 1 MHz or less	1	Middle
<input type="checkbox"/> 1 MHz to 10 MHz	2	1 near top and 1 near bottom
<input type="checkbox"/> More than 10 MHz	3	1 near top, 1 near middle, and 1 near bottom

1.3 ANTENNA INFORMATION

Antenna Type	Winded wire coil
Antenna Gain	Door antennas, Gain: 0 dBi Interior antennas, Gain: 0 dBi Kazashi, Gain: 0 dBi
Brand / Model	Door antennas: Continental / A2C 98 300 400 Interior antennas: Continental / A2C 53 119 236 Kazashi: Kazashi / 251 50 5RA0A

Remark:

1. Disclaimer: Antenna information is provided by the applicant, test results of this report are applicable to the sample EUT received.

1.4 MEASUREMENT UNCERTAINTY

PARAMETER	UNCERTAINTY
AC Powerline Conducted Emission	± 2.1183
Channel Bandwidth	± 2.1863
Radiated Emission_9kHz-30MHz	± 3.814
Radiated Emission_30MHz-200MHz	± 4.272
Radiated Emission_200MHz-1GHz	± 4.619

Remark:

- 1.This uncertainty represents an expanded uncertainty expressed at approximately the 95% confidence level using a coverage factor of $k=2$
2. ISO/IEC 17025 requires that an estimate of the measurement uncertainties associated with the emissions test results be included in the report.

Report No.: TMWK2209003994KR

1.5 FACILITIES AND TEST LOCATION

All measurement facilities used to collect the measurement data are located at

No.11, Wugong 6th Rd., Wugu Dist., New Taipei City, Taiwan.

No. 12, Ln. 116, Wugong 3rd Rd., Wugu Dist., New Taipei City, Taiwan.

CAB identifier: TW1309

Test site	Test Engineer	Remark
AC Conduction Room	-	Not applicable, because EUT doesn't connect to AC Main Source direct.
Radiation	Ray Li	-
Conducted	Jack Chen	-

Remark: The sites are constructed in conformance with the requirements of ANSI C63.7, ANSI C63.4 and CISPR Publication 22.

Report No.: TMWK2209003994KR

1.6 INSTRUMENT CALIBRATION

3M 966A Chamber Test Site					
Equipment	Manufacturer	Model	S/N	Cal Date	Cal Due
Bi-Log Antenna	Sunol Sciences	JB3	A030105	2022-08-03	2023-08-02
Spectrum Analyzer	Agilent	E4446A	MY46180323	2021-12-06	2022-12-05
Thermo-Hygro Meter	WISEWIND	1206	D07	2021-12-28	2022-12-27
Loop Antenna	COM-POWER	AL-130	121051	2022-04-13	2023-04-12
Preamplifier	EMEC	EM330	060609	2022-02-23	2023-02-22
Preamplifier	HP	8449B	3008A00965	2021-12-24	2022-12-23
Cable	Huber+Suhner	104PEA	20995+11112+182 330	2022-02-23	2023-02-22
Coaxial Cable	EMCI	EMC105	190914+33953	2022-06-15	2023-06-14
Horn Antenna	ETC	MCTD 1209	DRH13M02003	2022-01-25	2023-01-24
Turn Table	CCS	CC-T-1F	N/A	N.C.R	N.C.R
Controller	CCS	CC-C-1F	N/A	N.C.R	N.C.R
Antenna Tower	CCS	CC-A-1F	N/A	N.C.R	N.C.R
Software	e3 6.11-20180419c				

Conducted					
Equipment	Manufacturer	Model	S/N	Cal Date	Cal Due
EXA Signal Analyzer	Keysight	N9010B	MY60242460	2022-01-30	2023-01-29
Loop Probe	LANGER EMV-TECHNIK	RF-R 50-1	02-2644	2022-01-24	2023-01-23
Software	N/A				

Remark:

1. Each piece of equipment is scheduled for calibration once a year.
2. N.C.R. = No Calibration Required.

1.7 SUPPORT AND EUT ACCESSORIES EQUIPMENT

There are no accessories and support equipment be used during the test.

EUT Accessories Equipment					
No.	Equipment	Brand	Model	Series No.	FCC ID
	N/A				

Support Equipment					
No.	Equipment	Brand	Model	Series No.	FCC ID
1	DC power Source	TECH	PROGRAMMABLE	N/A	N/A

1.8 TEST METHODOLOGY AND APPLIED STANDARDS

The test methodology, setups and results comply with all requirements in accordance with ANSI C63.10:2013, FCC 15.209, IC RSS-210, IC RSS-Gen Rules.

2. TEST SUMMARY

FCC Standard Sec.	IC Standard Sec.	Chapter	Test Item	Result
15.215	RSS-GEN Sec. 6.7	4.1	20dB Bandwidth & 99% OBW	Pass
15.209	RSS-GEN Sec. 8.9	4.2	Transmitter Radiated Emission	Pass
15.207	RSS-GEN Sec. 8.8	4.3	AC Power-line Conducted Emission	Not applicable
15.203	RSS-GEN Sec. 6.8	4.4	Antenna Requirement	Pass

Report No.: TMWK2209003994KR

3. DESCRIPTION OF TEST MODES

3.1 THE WORST MODE OF OPERATING CONDITION

Operation mode	TX: 125KHz, RX: 433.92MHz
RF Field strength	<u>22.05 dBuV/m (-29.45 dBuA/m) @300m</u>

3.2 THE WORST MODE OF MEASUREMENT

Radiated Emission Measurement Above 1G	
Test Condition	Radiated Emission Above 1G
Power supply Mode	Mode 1: EUT power by Power supply
Worst Mode	<input checked="" type="checkbox"/> Mode 1 <input type="checkbox"/> Mode 2 <input type="checkbox"/> Mode 3 <input type="checkbox"/> Mode 4
Worst Position	<input type="checkbox"/> Placed in fixed position. <input checked="" type="checkbox"/> Placed in fixed position at X-Plane (E2-Plane) <input type="checkbox"/> Placed in fixed position at Y-Plane (E1-Plane) <input type="checkbox"/> Placed in fixed position at Z-Plane (H-Plane)

Radiated Emission Measurement Below 1G	
Test Condition	Radiated Emission Below 1G
Power supply Mode	Mode 1: EUT power by Power supply
Worst Mode	<input checked="" type="checkbox"/> Mode 1 <input type="checkbox"/> Mode 2 <input type="checkbox"/> Mode 3 <input type="checkbox"/> Mode 4

Remark:

1. The worst mode was record in this test report.
2. EUT pre-scanned in three axis ,X,Y, Z and two polarity, for radiated measurement. The worst case(X-Plane) were recorded in this report

Report No.: TMWK2209003994KR

3.3 FCC PART 15.205 & RSS GEN SECTION 8.10 RESTRICTED BANDS OF OPERATIONS

According to FCC 15.205,

- (a) Except as shown in other rules, only spurious emissions are permitted in any of the frequency bands listed below:

MHz	MHz	MHz	GHz
0.090 - 0.110	16.42 - 16.423	399.9 - 410	4.5 - 5.15
¹ 0.495 - 0.505	16.69475 - 16.69525	608 - 614	5.35 - 5.46
2.1735 - 2.1905	16.80425 - 16.80475	960 - 1240	7.25 - 7.75
4.125 - 4.128	25.5 - 25.67	1300 - 1427	8.025 - 8.5
4.17725 - 4.17775	37.5 - 38.25	1435 - 1626.5	9.0 - 9.2
4.20725 - 4.20775	73 - 74.6	1645.5 - 1646.5	9.3 - 9.5
6.215 - 6.218	74.8 - 75.2	1660 - 1710	10.6 - 12.7
6.26775 - 6.26825	108 - 121.94	1718.8 - 1722.2	13.25 - 13.4
6.31175 - 6.31225	123 - 138	2200 - 2300	14.47 - 14.5
8.291 - 8.294	149.9 - 150.05	2310 - 2390	15.35 - 16.2
8.362 - 8.366	156.52475 -	2483.5 - 2500	17.7 - 21.4
8.37625 - 8.38675	156.52525	2655 - 2900	22.01 - 23.12
8.41425 - 8.41475	156.7 - 156.9	3260 - 3267	23.6 - 24.0
12.29 - 12.293	162.0125 - 167.17	3332 - 3339	31.2 - 31.8
12.51975 - 12.52025	167.72 - 173.2	3345.8 - 3358	36.43 - 36.5
12.57675 - 12.57725	240 - 285	3600 - 4400	(²)
13.36 - 13.41	322 - 335.4		

¹ Until February 1, 1999, this restricted band shall be 0.490-0.510 MHz.

² Above 38.6

- (b) Except as provided by other rules, the field strength of emissions appearing within these frequency bands shall not exceed the limits shown in Section 15.209. At frequencies equal to or less than 1000 MHz, compliance with the limits in Section 15.209 shall be demonstrated using measurement instrumentation employing a CISPR quasi-peak detector. Above 1000 MHz, compliance with the emission limits in Section 15.209 shall be demonstrated based on the average value of the measured emissions. The provisions in Section 15.35 apply to these measurements.

According to RSS-GEN section 8.10 Restricted bands of operation,

Restricted frequency bands, identified in table 7, are designated primarily for safety-of-life services (distress calling and certain aeronautical activities), certain satellite downlinks, radio astronomy and some government uses. Except where otherwise indicated, the following conditions related to the restricted frequency bands apply:

- (a) The transmit frequency, including fundamental components of modulation, of licence-exempt radio apparatus shall not fall within the restricted frequency bands listed in table 7 except for apparatus compliant with RSS-287, Emergency Position Indicating Radio Beacons (EPIRB), Emergency Locator Transmitters (ELT), Personal Locator Beacons (PLB), and Maritime Survivor Locator Devices (MSLD).
- (b) Unwanted emissions that fall into restricted frequency bands listed in table 7 shall comply with the limits specified in table 5 and table 6.
- (c) Unwanted emissions that do not fall within the restricted frequency bands listed in table 7 shall comply either with the limits specified in the applicable RSS or with those specified in table 5 and table 6.

Table 7 – Restricted frequency bands ^{Note 1}		
MHz	MHz	GHz
0.090 - 0.110	149.9 - 150.05	9.0 - 9.2
0.495 - 0.505	156.52475 - 156.52525	9.3 - 9.5
2.1735 - 2.1905	156.7 - 156.9	10.6 - 12.7
3.020 - 3.026	162.0125 - 167.17	13.25 - 13.4
4.125 - 4.128	167.72 - 173.2	14.47 - 14.5
4.17725 - 4.17775	240 – 285	15.35 - 16.2
4.20725 - 4.20775	322 - 335.4	17.7 - 21.4
5.677 - 5.683	399.9 - 410	22.01 - 23.12
6.215 - 6.218	608 - 614	23.6 - 24.0
6.26775 - 6.26825	960 - 1427	31.2 - 31.8
6.31175 - 6.31225	1435 - 1626.5	36.43 - 36.5
8.291 - 8.294	1645.5 - 1646.5	Above 38.6
8.362 - 8.366	1660 - 1710	
8.37625 - 8.38675	1718.8 - 1722.2	
8.41425 - 8.41475	2200 - 2300	
12.29 - 12.293	2310 - 2390	
12.51975 - 12.52025	2483.5 - 2500	
12.57675 - 12.57725	2655 - 2900	
13.36 - 13.41	3260 – 3267	
16.42 - 16.423	3332 - 3339	
16.69475 - 16.69525	3345.8 - 3358	
16.80425 - 16.80475	3500 - 4400	
25.5 - 25.67	4500 - 5150	
37.5 - 38.25	5350 - 5460	
73 - 74.6	7250 - 7750	
74.8 - 75.2	8025 – 8500	
108 – 138		

Note 1: Certain frequency bands listed in table 7 and in bands above 38.6 GHz are designated for licence-exempt applications. These frequency bands and the requirements that apply to related devices are set out in the 200 and 300 series of RSSs.

Report No.: TMWK2209003994KR

4. TEST RESULT

4.1 20DB BANDWIDTH & 99%OBW

DEFINITION

According to FCC Part 15.215 (c) ,Intentional radiators operating under the alternative provisions to the general emission limits, as contained in §§15.217 through 15.257 and in subpart E of this part, must be designed to ensure that the 20 dB bandwidth of the emission, or whatever bandwidth may otherwise be specified in the specific rule section under which the equipment operates, is contained within the frequency band designated in the rule section under which the equipment is operated.

For ISED, RSS-GEN, 6.7 Occupied bandwidth (or 99% emission bandwidth) and x dB bandwidth

The occupied bandwidth or the “99% emission bandwidth” is defined as the frequency range between two points, one above and the other below the carrier frequency, within which 99% of the total transmitted power of the fundamental transmitted emission is contained. The occupied bandwidth shall be reported for all equipment in addition to the specified bandwidth required in the applicable RSSs.

In some cases, the “x dB bandwidth” is required, which is defined as the frequency range between two points, one at the lowest frequency below and one at the highest frequency above the carrier frequency, at which the maximum power level of the transmitted emission is attenuated x dB below the maximum in-band power level of the modulated signal, where the two points are on the outskirts of the in-band emission.

TEST CONFIGURATION

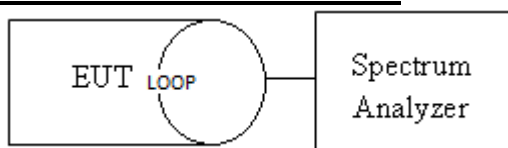

TEST PROCEDURE

The Loop antenna connected to the spectrum analyzer, was touching to the transmitter antenna. Set the RBW=1KHz, VBW ≥ 3 x RBW, Detector = Peak, Trace mode = Max hold, Sweep = 500ms. Measure the maximum width of the emission that is constrained by the frequencies associated with the Occupied Bandwidth.

TEST RESULTS

Compliance

Report No.: TMWK2209003994KR

Test Data

Temperature: 25.5°C Test Date: October 7, 2022
Humidity: 53% RH Tested By: Jack Chen

20 dB Bandwidth (kHz)			99% Bandwidth (kHz)
FL	FH	Bandwidth	
119.538	130.629	11.091	23.818

Test Plots

20dB & 99%OBW

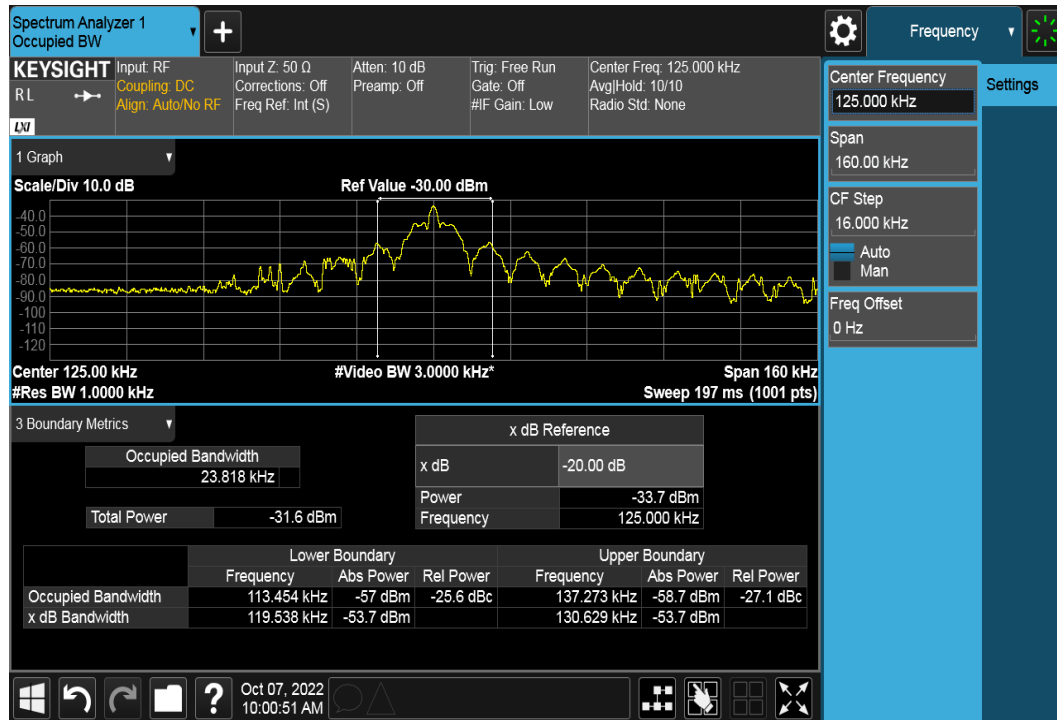

4.2 TRANSMITTER RADIATED EMISSION

LIMIT

1. According to FCC PART 15.209(a), except as provided elsewhere in this Subpart, the emissions from an intentional radiator shall not exceed the field strength levels specified in the following table:

Frequency (MHz)	Field Strength ($\mu\text{V/m}$)	Measurement Distance (m)
0.009 - 0.490	2400/F(kHz)	300
0.490 - 1.705	24000/F(kHz)	30
1.705 – 30.0	30	30
30-88	100	3
88-216	150	3
216-960	200	3
Above 960	500	3

Remark: Except as provided in other rules, fundamental emissions from intentional radiators operating under this Section shall not be located in the frequency bands 54-72 MHz, 76-88 MHz, 174-216 MHz or 470-806 MHz. However, operation within these frequency bands is permitted under other sections of this Part, e.g., Sections 15.231 and 15.241.

2. In the above emission table, the tighter limit applies at the band edges.

Above 30MHz

Frequency (MHz)	Field Strength		Measurement Distance (meter)
	($\mu\text{V/m}$)	(dB $\mu\text{V/m}$)	
30-88	100	40.0	3
88-216	150	43.5	3
216-960	200	46.0	3
Above 960	500	54.0	3

Report No.: TMWK2209003994KR

According to RSS-210, Section 7.3 and RSS-GEN Sec. 8.9 Transmitters whose wanted and unwanted emissions fall within the general field strength limits specified in RSS-Gen may operate licence-exempt in any of the frequency bands, other than the restricted frequency bands listed in RSS-Gen and the TV bands 54-72 MHz, 76-88 MHz, 174-216 MHz and 470-602 MHz, and shall be certified under RSS-210. Under no circumstances shall the level of any unwanted emissions exceed the level of the fundamental emissions.

Below 30MHz

Table 6 – General field strength limits at frequencies below 30 MHz		
Frequency	Magnetic field strength (H-Field) (µA/m)	Measurement distance (m)
9 - 490 kHz ^{Note 1}	6.37/F (F in kHz)	300
490 - 1705 kHz	63.7/F (F in kHz)	30
1.705 - 30 MHz	0.08	30

Note 1: The emission limits for the ranges 9-90 kHz and 110-490 kHz are based on measurements employing a linear average detector.

Above 30MHz

Table 5 – General field strength limits at frequencies above 30 MHz	
Frequency	Field strength (µV/m at 3 m)
30 – 88	100
88 – 216	150
216 – 960	200
Above 960	500

Test Configuration

9kHz ~ 30MHz

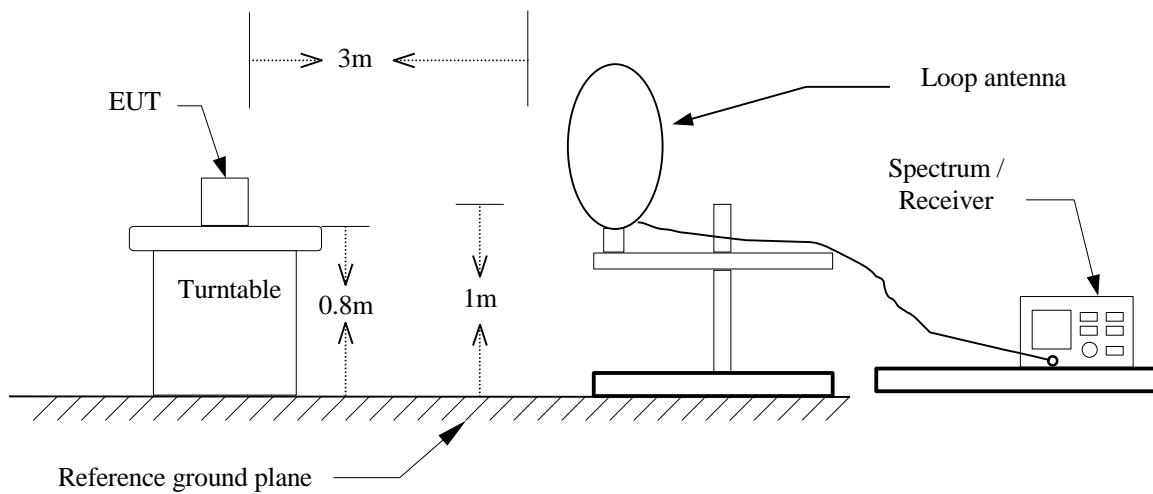

30MHz ~ 1GHz

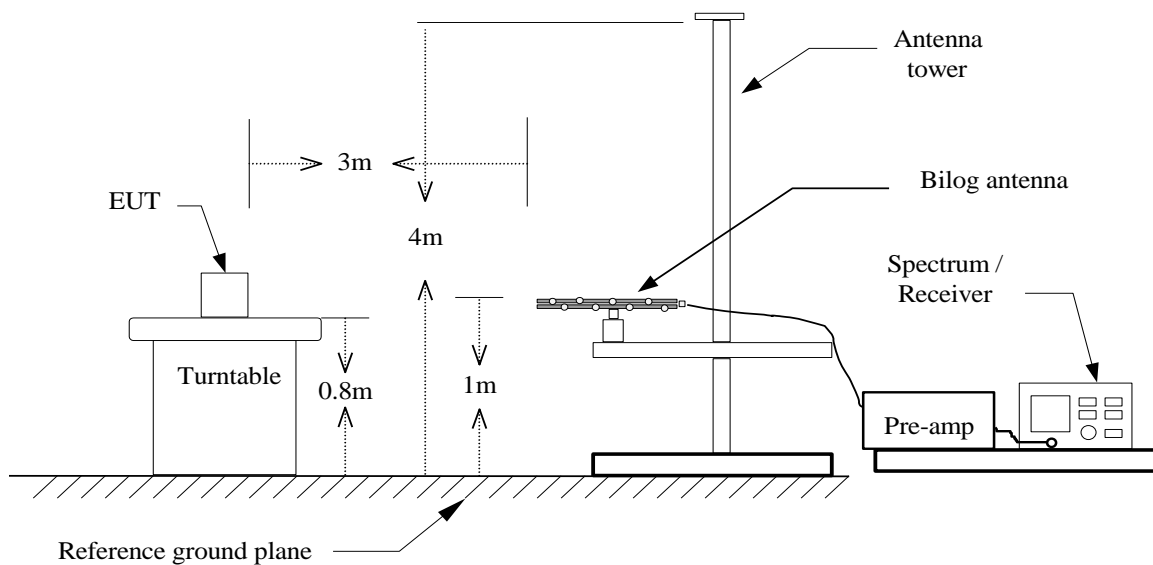

TEST PROCEDURE

For 9KHz ~ 30MHz

1. The EUT is placed on a turntable, which is 0.8m above ground plane.
2. The turntable shall be rotated for 360 degrees to determine the position of maximum emission level.
3. EUT is set 3m away from the receiving antenna, which is varied from 1m to find out the highest emissions.
4. Maximum procedure was performed on the six highest emissions to ensure EUT compliance.
5. And also, each emission was to be maximized by changing the polarization of receiving antenna both horizontal and vertical.
6. Set the spectrum analyzer in the following setting as:
Below 1GHz:
RBW=200kHz / VBW=600kHz / Sweep=AUTO
7. Repeat above procedures until the measurements for all frequencies are complete.
8. Test distance for frequencies at below 30 MHz, measurements may be performed at a distance closer than the EUT limit distance; however, an attempt should be made to avoid making measurements in the near field. When performing measurements below 30 MHz at a closer distance than the limit distance, the results shall be extrapolated to the specified distance by either making measurements at a minimum of two or more distances on at least one radial to determine the proper extrapolation factor or by using the square of an inverse linear distance extrapolation factor (40 dB/decade). The test report shall specify the extrapolation method used to determine compliance of the EUT.

For 30MHz ~ 1GHz

1. The EUT is placed on a turntable, which is 0.8m above ground plane.
2. The turntable shall be rotated for 360 degrees to determine the position of maximum emission level.
3. EUT is set 3m away from the receiving antenna, which is varied from 1m to 4m to find out the highest emissions.
4. Maximum procedure was performed on the six highest emissions to ensure EUT compliance.
5. And also, each emission was to be maximized by changing the polarization of receiving antenna both horizontal and vertical.
6. Set the spectrum analyzer in the following setting as:
RBW=100kHz / VBW=300kHz / Sweep=AUTO
7. Repeat above procedures until the measurements for all frequencies are complete.

Report No.: TMWK2209003994KR

Fundamental Strength

Operation Mode: Main

Temperature: 23.1°C

Test Date: October 12, 2022

Humidity: 62% RH

Tested by: Tony Chao

Standard: FCC

Freq. (MHz)	Detector Mode (PK/QP/AV)	Spectrum Reading Level (dBμV)	Factor (dB)	Actual FS (dBμV/m)	Limit (dBμV/m)	Margin (dB)	Antenna Pol.
0.125	Peak	78.12	-66.94	11.17	25.66	-14.49	V
0.125	Peak	88.99	-66.94	22.05	25.67	-3.63	H
0.125	Peak	73.46	-66.94	6.52	25.66	-19.15	G

Antenna Pol.: Vertical

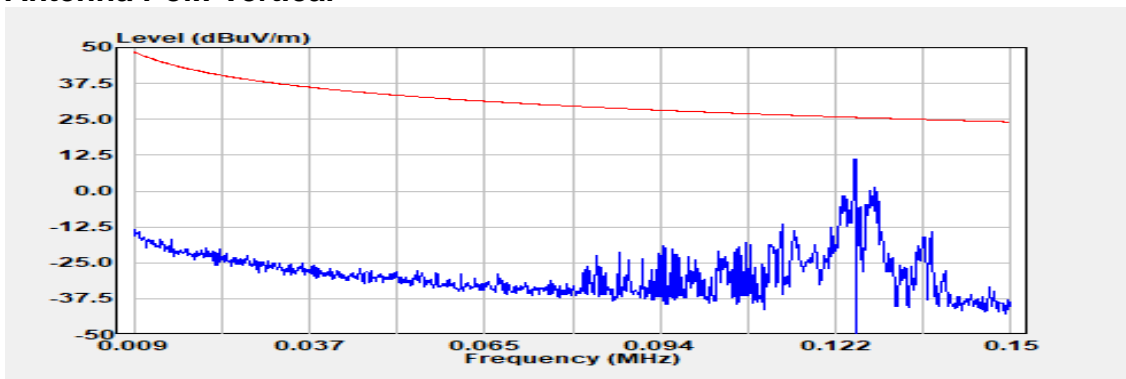

Antenna Pol.: Horizontal

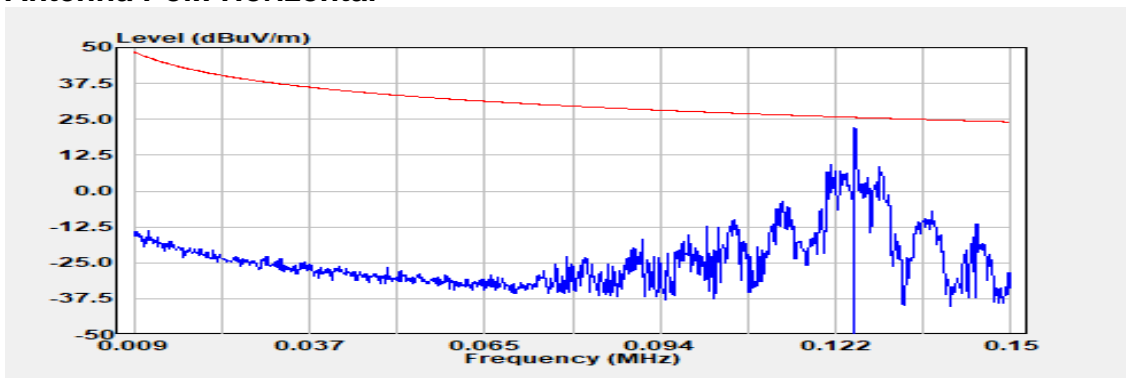

Antenna Pol.: Ground

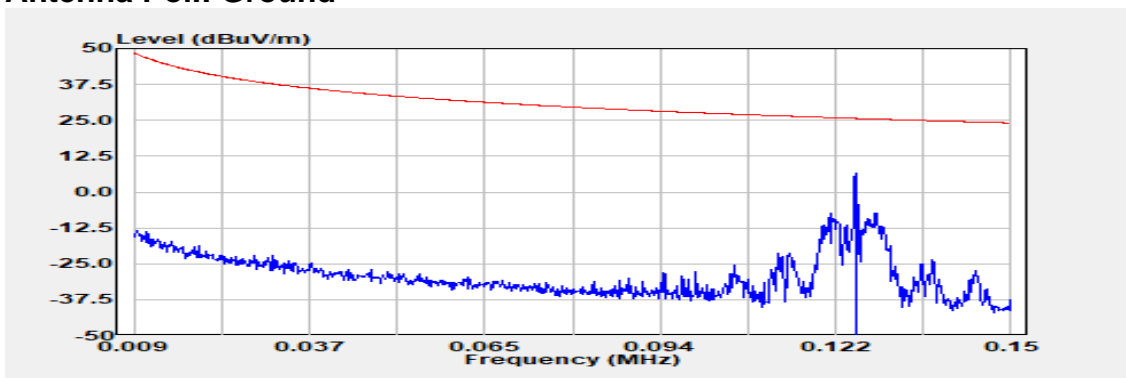

Report No.: TMWK2209003994KR

Operation Mode: Main

Temperature: 23.1°C

Test Date: October 12, 2022

Humidity: 62% RH

Tested by: Tony Chao

Standard: IC

Freq (MHz)	Detector Mode (PK/QP/AV)	Spectrum Read Level (dBμV)	Factor (dB)	Actual FS (dBμV/m)	Limit @3m (dBμV/m)	Actual FS (dBμA/m)	Limit (dBμA/m)	Margin (dB)	Antenna Pol. (V/H/G)
0.125	Peak	78.12	-66.94	11.17	25.66	-40.33	-25.84	-14.49	V
0.125	Peak	88.99	-66.94	22.05	25.67	-29.45	-25.83	-3.63	H
0.125	Peak	73.46	-66.94	6.52	25.66	-44.98	-25.84	-19.15	G

Remark: dBμA/m=dBμV/m-51.5

Antenna Pol.: Vertical

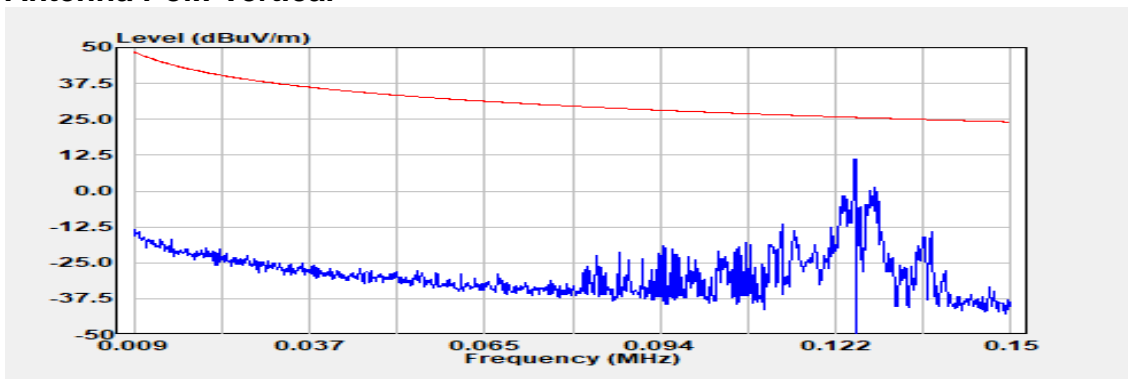

Antenna Pol.: Horizontal

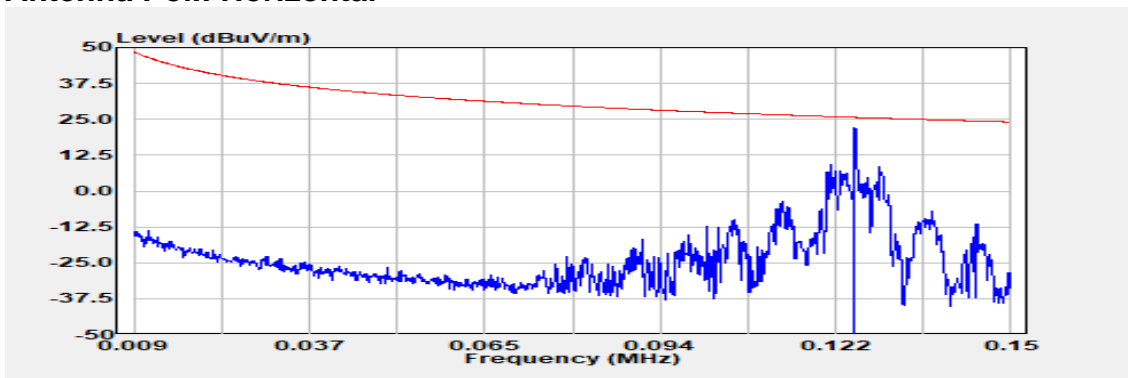

Antenna Pol.: Ground

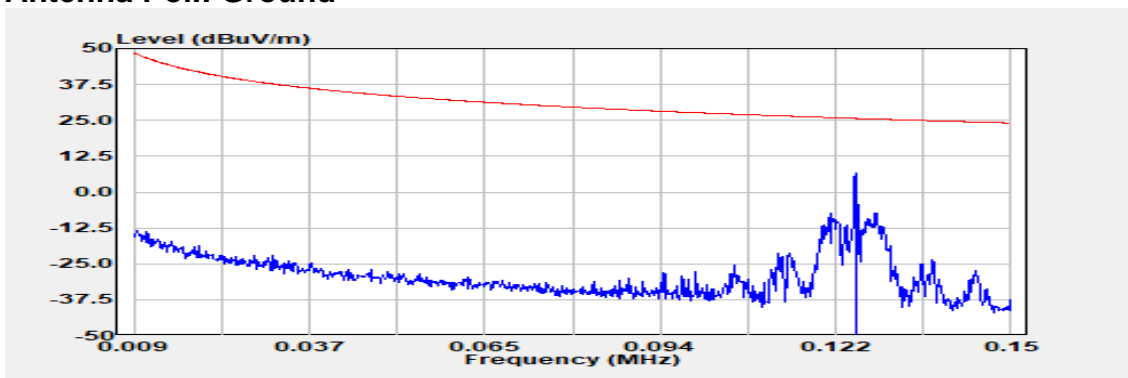

Report No.: TMWK2209003994KR

9 kHz – 30MHz

Operation Mode: TX 125KHz

Antenna Pol.: Horizontal

Temperature: 23.1°C

Test Date: October 12, 2022

Humidity: 62% RH

Tested by: Tony Chao

Standard: FCC

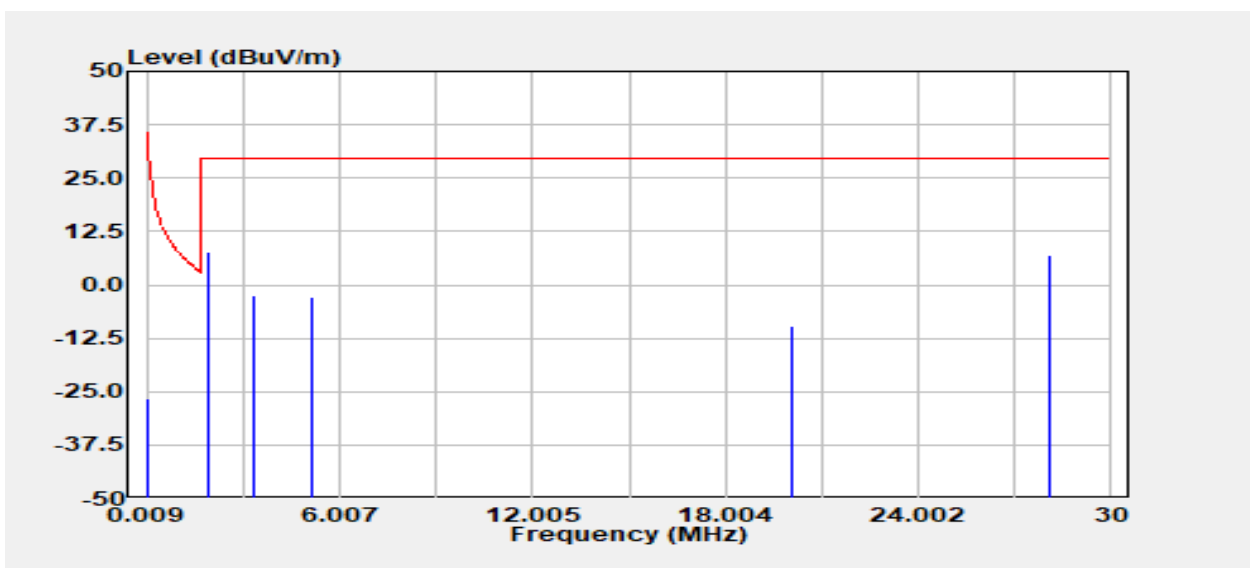

Freq. (MHz)	Detector Mode (PK/QP/AV)	Spectrum Reading Level (dB μ V)	Factor (dB)	Actual FS (dB μ V/m)	Limit (dB μ V/m)	Margin (dB)
0.05	Peak	39.64	-66.40	-26.76	33.69	-60.46
1.96	Peak	33.97	-26.28	7.69	29.54	-21.85
3.35	Peak	23.56	-26.10	-2.54	29.54	-32.08
5.17	Peak	22.81	-25.81	-2.99	29.54	-32.53
20.04	Peak	14.99	-24.71	-9.72	29.54	-39.26
28.08	Peak	33.22	-26.14	7.08	29.54	-22.46

Remark:

1. the frequency bands 9-90 kHz, 110-490 kHz measurements employing an average detector and other below 1GHz measurements employing a CISPR quasi-peak detector.

Report No.: TMWK2209003994KR

9 kHz – 30MHz

Operation Mode: TX 125KHz

Antenna Pol.: Horizontal

Temperature: 23.1°C

Test Date: October 12, 2022

Humidity: 62% RH

Tested by: Tony Chao

Standard: IC

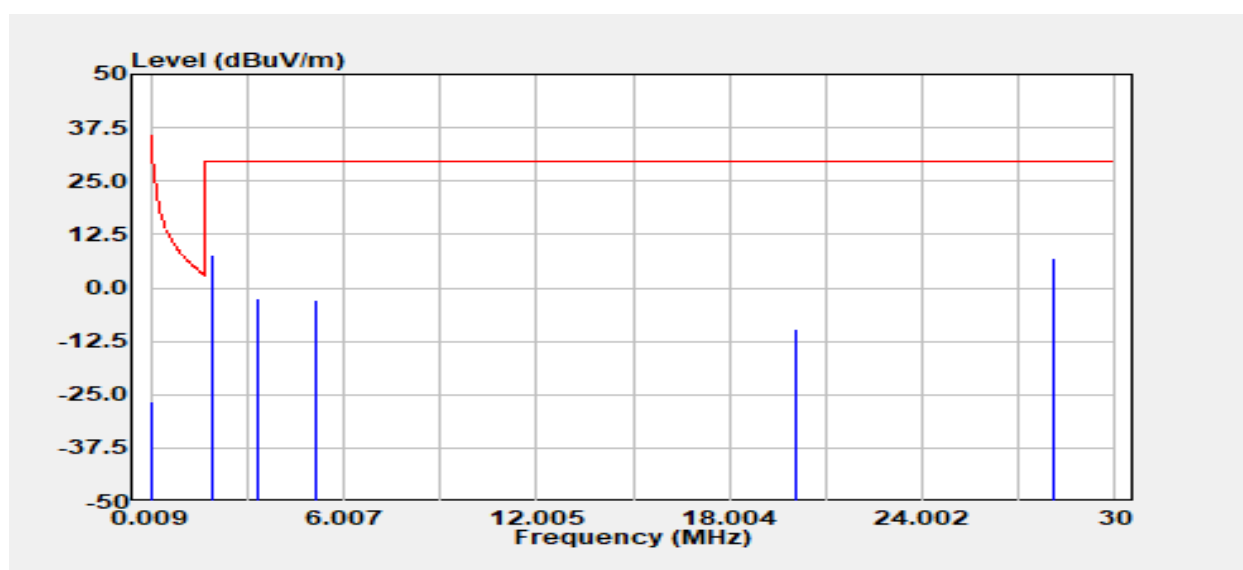

Freq (MHz)	Detector Mode (PK/QP/AV)	Spectrum Read Level (dB μ V)	Factor (dB)	Actual FS (dB μ V/m)	Limit @3m (dB μ V/m)	Actual FS (dB μ A/m)	Limit (dB μ A/m)	Margin (dB)
0.05	Peak	39.64	-66.40	-26.76	33.69	-78.26	-17.81	-60.46
1.96	Peak	33.97	-26.28	7.69	29.54	-43.81	-21.96	-21.85
3.35	Peak	23.56	-26.10	-2.54	29.54	-54.04	-21.96	-32.08
5.17	Peak	22.81	-25.81	-2.99	29.54	-54.49	-21.96	-32.53
20.04	Peak	14.99	-24.71	-9.72	29.54	-61.22	-21.96	-39.26
28.08	Peak	33.22	-26.14	7.08	29.54	-44.42	-21.96	-22.46

Remark:

1. the frequency bands 9-90 kHz, 110-490 kHz measurements employing an average detector and other below 1GHz measurements employing a CISPR quasi-peak detector.

Report No.: TMWK2209003994KR

Below 1 GHz

Operation Mode: TX 125KHz

Antenna Pol.: Vertical

Temperature: 23.1°C

Test Date: October 12, 2022

Humidity: 62% RH

Tested by: Tony Chao

Standard: FCC & IC

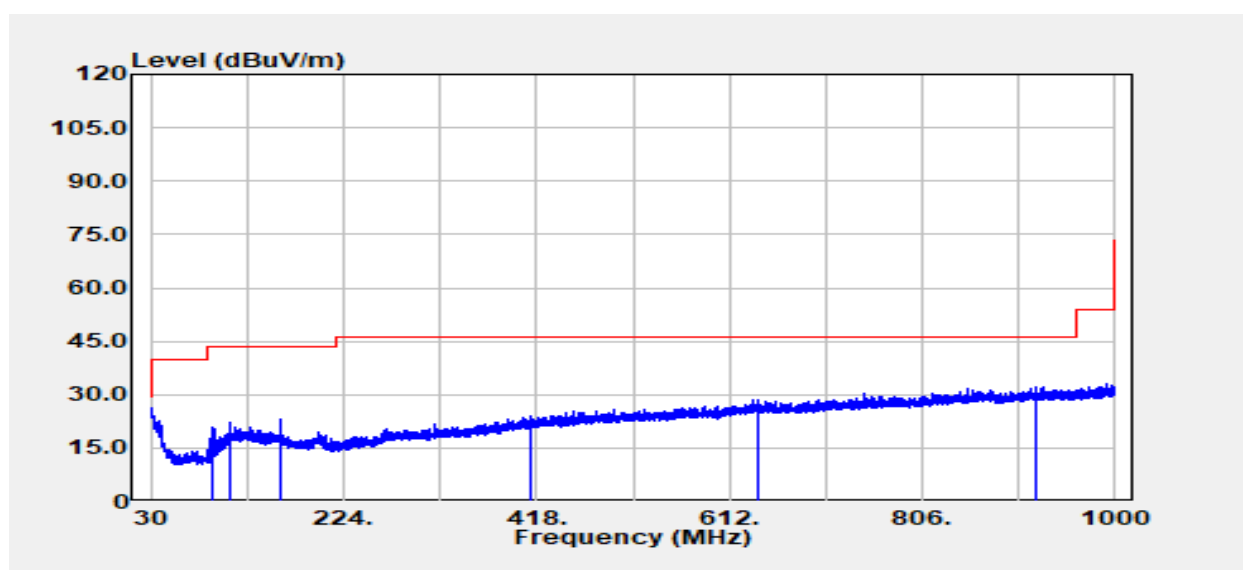

Freq. (MHz)	Detector Mode (PK/QP/AV)	Spectrum Reading Level (dBμV)	Factor (dB)	Actual FS (dBμV/m)	Limit @3m (dBμV/m)	Margin (dB)
92.57	Peak	35.78	-15.13	20.66	43.50	-22.84
109.42	Peak	32.80	-10.61	22.18	43.50	-21.32
160.10	Peak	34.05	-10.83	23.22	43.50	-20.28
412.54	Peak	29.80	-5.59	24.21	46.00	-21.79
639.89	Peak	29.50	-0.99	28.51	46.00	-17.49
921.31	Peak	29.38	2.94	32.32	46.00	-13.68

Report No.: TMWK2209003994KR

Operation Mode: TX 125KHz

Antenna Pol.: Horizontal

Temperature: 23.1°C

Test Date: October 12, 2022

Humidity: 62% RH

Tested by: Tony Chao

Standard: FCC & IC

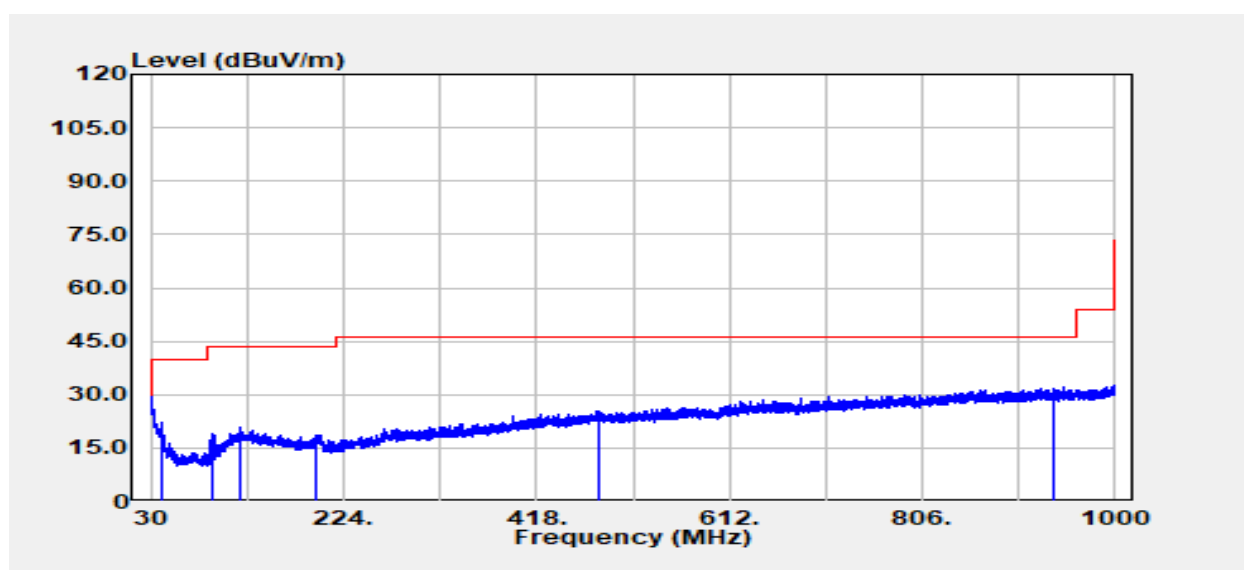

Freq. (MHz)	Detector Mode (PK/QP/AV)	Spectrum Reading Level (dBμV)	Factor (dB)	Actual FS (dBμV/m)	Limit @3m (dBμV/m)	Margin (dB)
40.06	Peak	32.05	-9.77	22.28	40.00	-17.72
93.17	Peak	34.12	-14.88	19.24	43.50	-24.26
119.97	Peak	30.12	-9.33	20.79	43.50	-22.71
195.99	Peak	29.11	-10.35	18.76	43.50	-24.74
481.29	Peak	29.37	-3.82	25.55	46.00	-20.45
939.25	Peak	28.77	3.13	31.90	46.00	-14.10

4.3 AC POWER LINE CONDUCTED EMISSION

4.3.1 Test Limit

According to §15.207(a), RSS-Gen Sec.8.8,

Frequency Range (MHz)	Limits(dB μ V)	
	Quasi-peak	Average
0.15 to 0.50	66 to 56*	56 to 46*
0.50 to 5	56	46
5 to 30	60	50

* Decreases with the logarithm of the frequency.

4.3.2 Test Procedure

Test method Refer as ANSI 63.10:2013 clause 6.2,

1. The EUT was placed on a table, which is 0.8m above ground plane.
2. Maximum procedure was performed on the six highest emissions to ensure EUT compliance.
3. Repeat above procedures until all frequency measured were complete

4.3.3 Test Setup

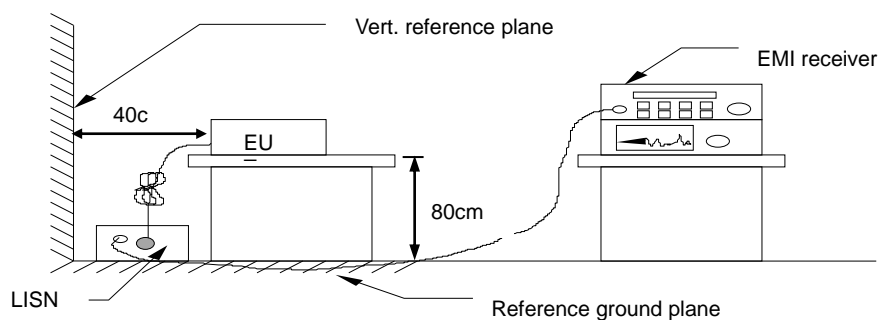

4.3.4 Test Result

Not applicable, because EUT doesn't connect to AC Main Source direct.

4.4 ANTENNA REQUIREMENT

§ 15.203 Antenna requirement and RSS-Gen 6.8.

An intentional radiator shall be designed to ensure that no antenna other than that furnished by the responsible party shall be used with the device. The use of a permanently attached antenna or of an antenna that uses a unique coupling to the intentional radiator shall be considered sufficient to comply with the provisions of this section. The manufacturer may design the unit so that a broken antenna can be replaced by the user, but the use of a standard antenna jack or electrical connector is prohibited. This requirement does not apply to carrier current devices or to devices operated under the provisions of §15.211, §15.213, §15.217, §15.219, or §15.221. Further, this requirement does not apply to intentional radiators that must be professionally installed, such as perimeter protection systems and some field disturbance sensors, or to other intentional radiators which, in accordance with §15.31(d), must be measured at the installation site. However, the installer shall be responsible for ensuring that the proper antenna is employed so that the limits in this part are not exceeded.

Antenna Type	Winded wire coil
Antenna Gain	Door antennas: 0 dBi Interior antennas: 0 dBi Kazashi: 0 dBi
Brand / Model	Door antennas: Continental / A2C 98 300 400 Interior antennas: Continental / A2C 53 119 236 Kazashi: Kazashi / 251 50 5RA0A

Remark:

1.The antenna(s) of the EUT are permanently attached and there are no provisions for connection to an external antenna. So the EUT complies with the requirements of §15.203 and RSS-Gen 6.8.

- End of Test Report -